



奇妙积木

KEEP PLEY

大国重器
The Pillars of a Great Power

中国航母
FLEET 18

福建舰
CNS Fujian

Length: 320 meters

2024年9月1日8时许,我国第三艘航空母舰福建舰从上海江南造船厂码头解缆启航,赴相关海域开展首次航行试验。

Full load displacement: over 80000 tons

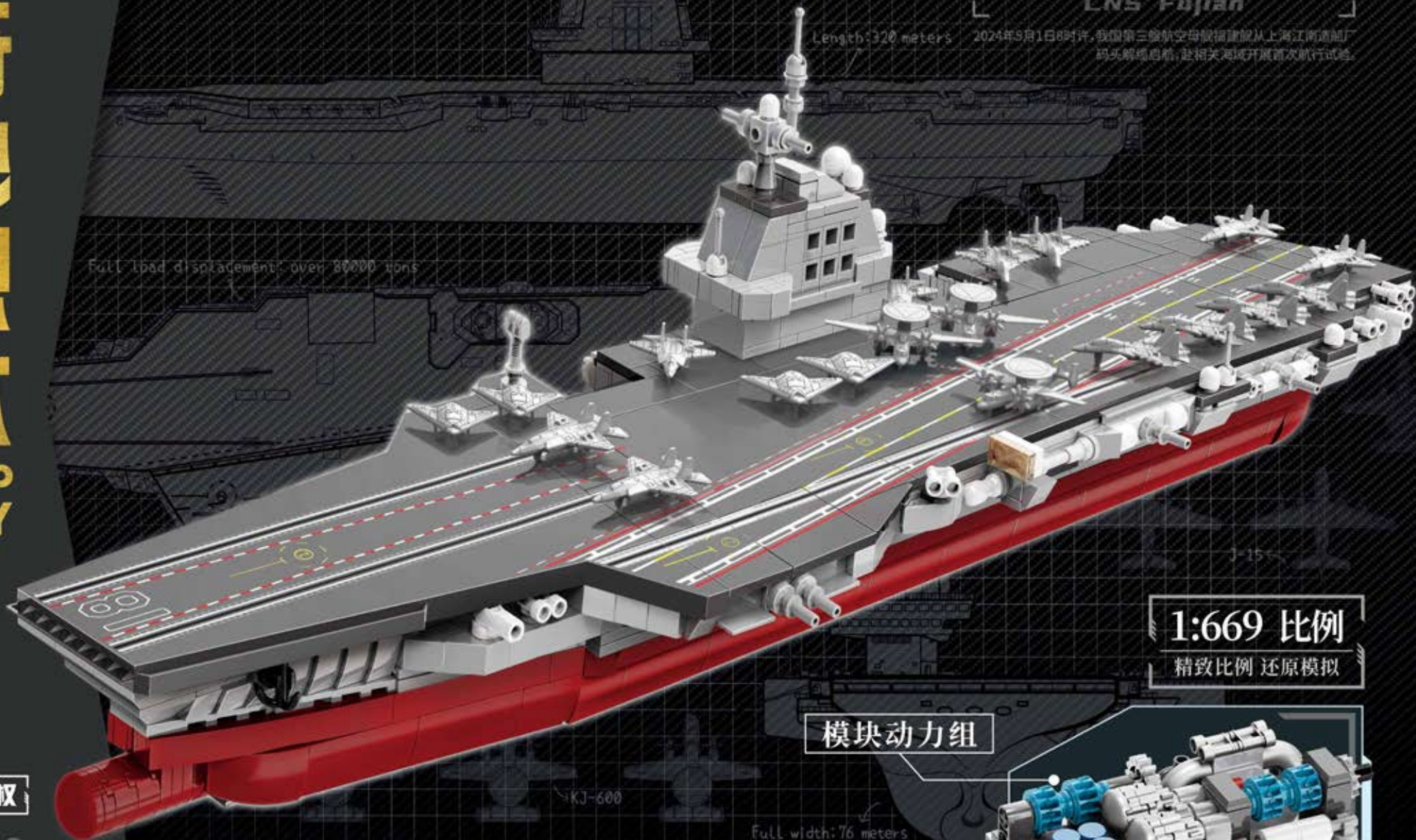

1:669 比例

精致比例 还原模拟

模块动力组

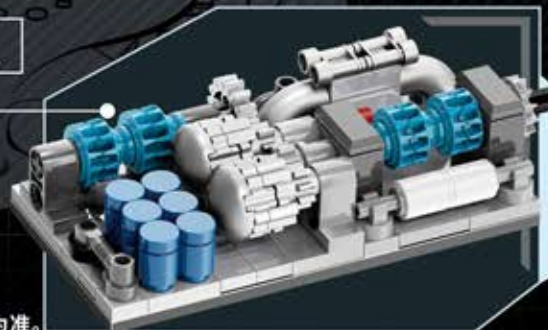

正版授权

23028
福建舰

Full width: 76 meters

图片仅供参考,请以实物为准。

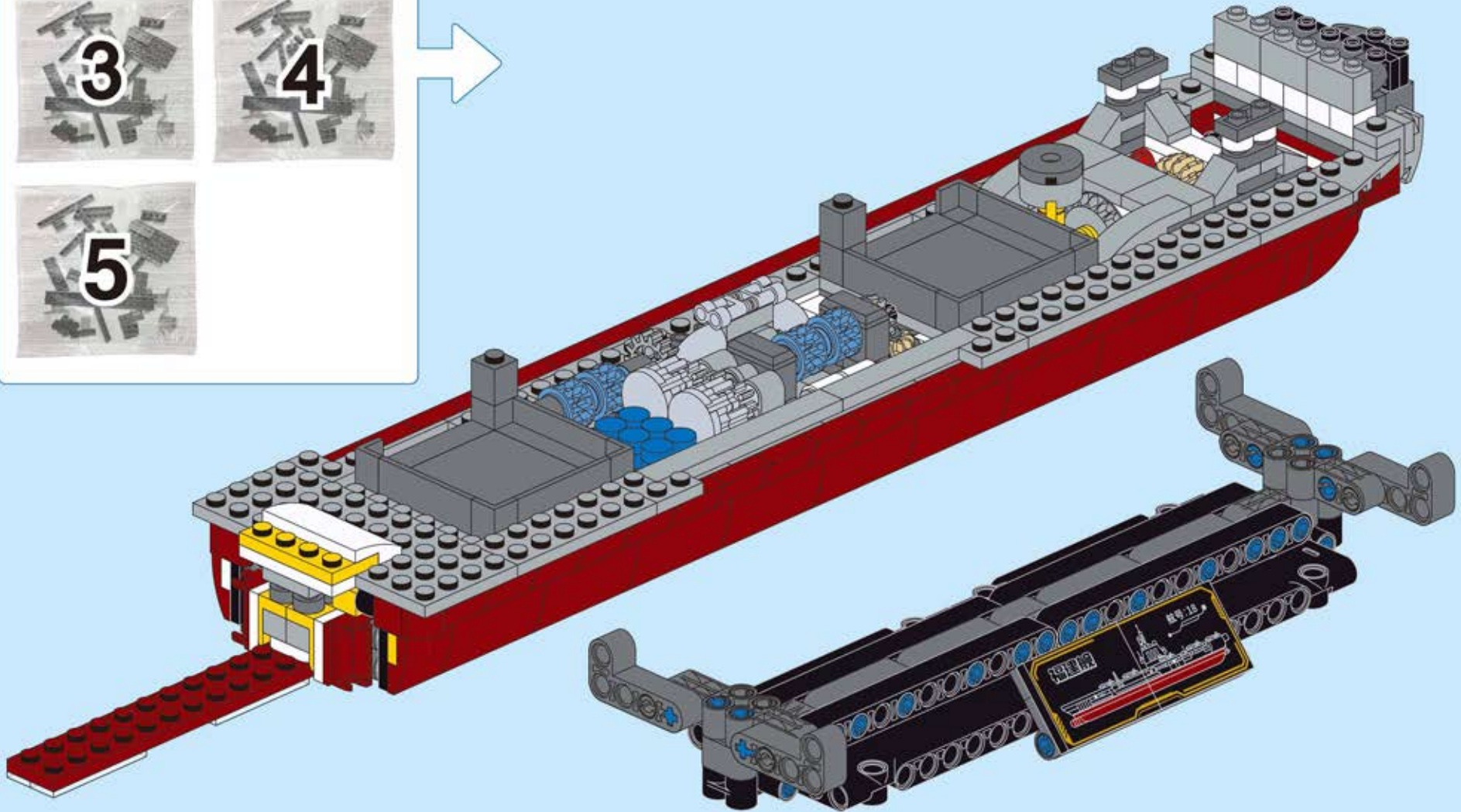
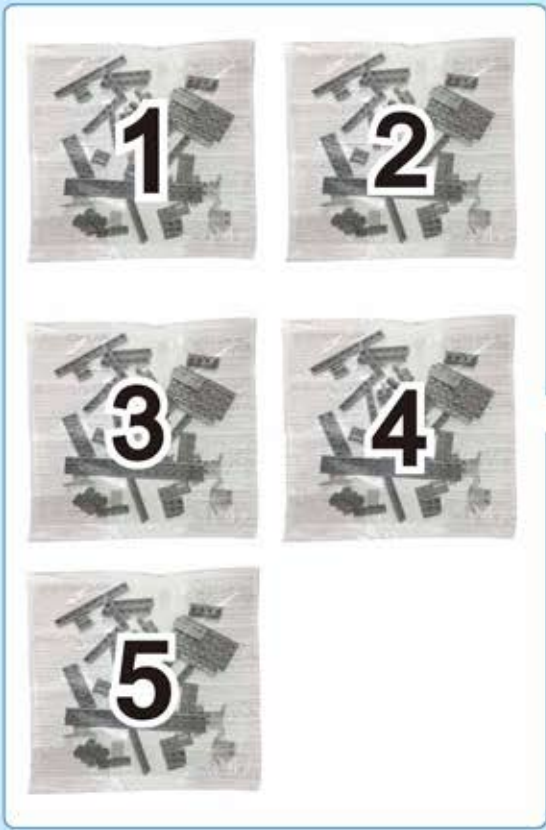

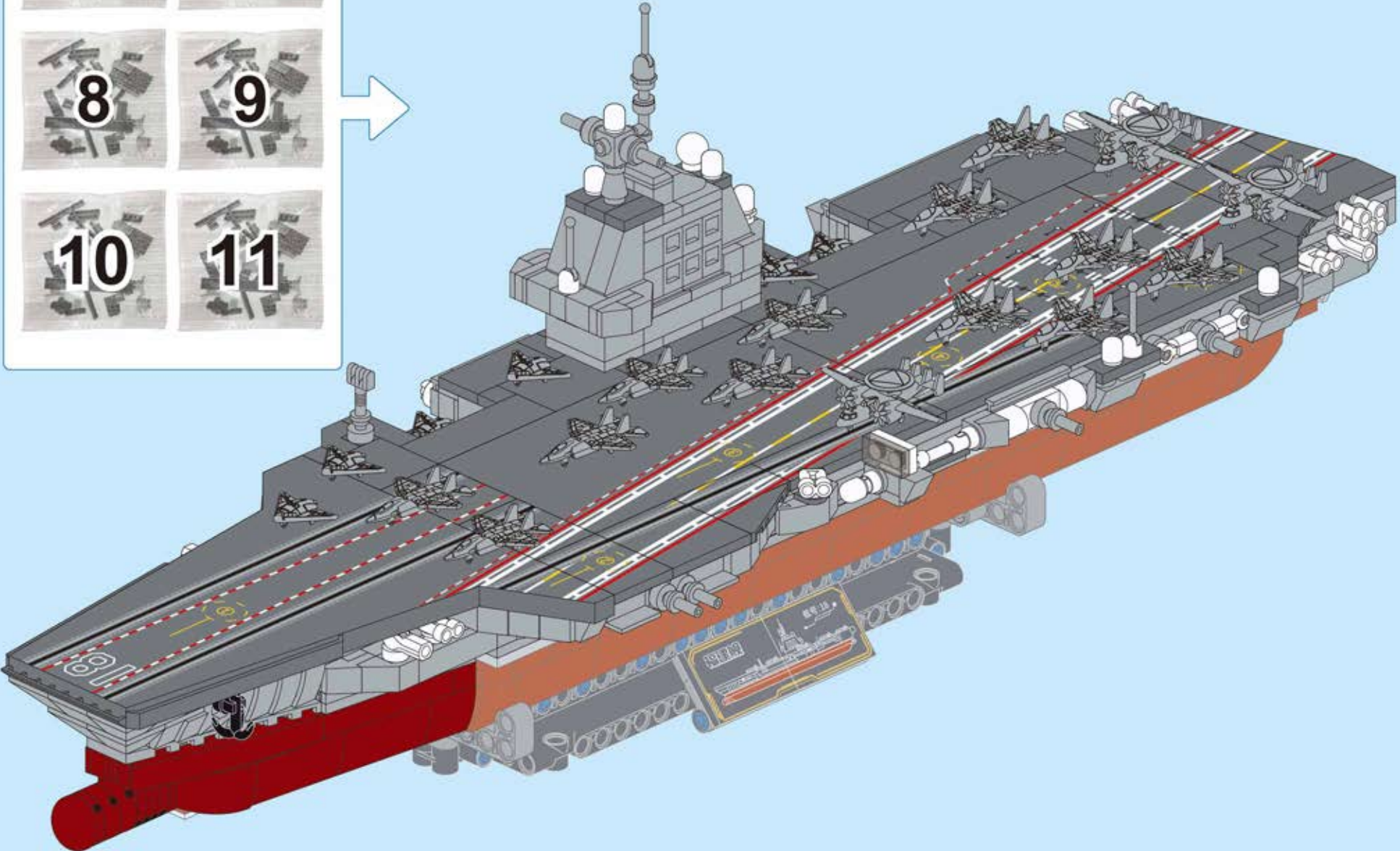

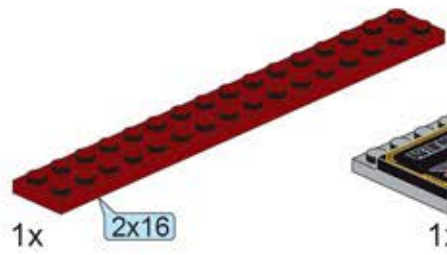

+

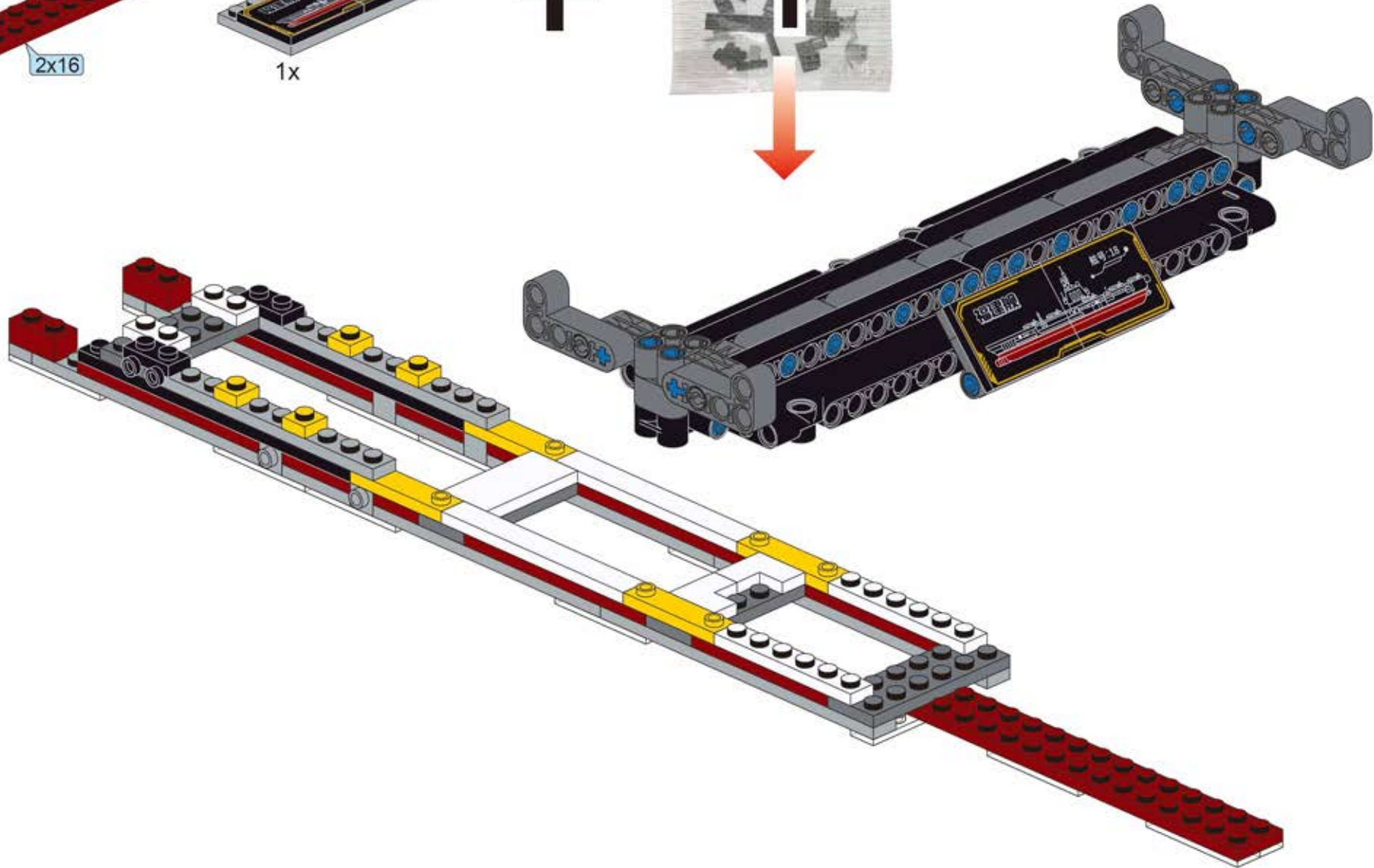

拆件器使用方法，仅为示例

Usage of Brick Separator, Just for the sample

1



3



2



4



A1

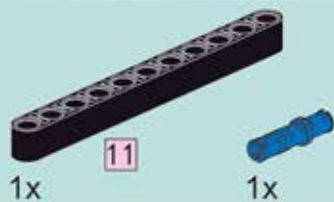

A2

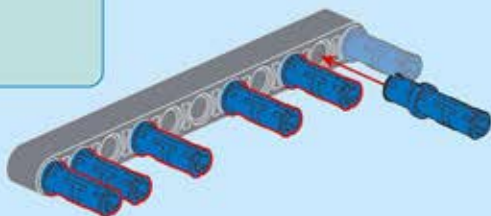

11 1:1

A3

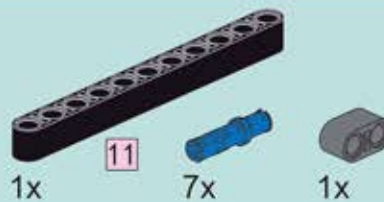

1



2

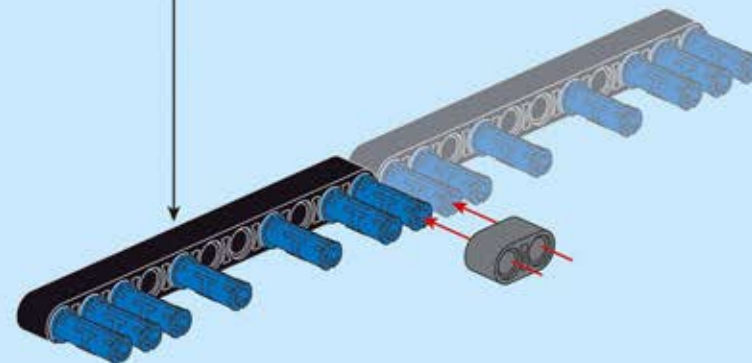
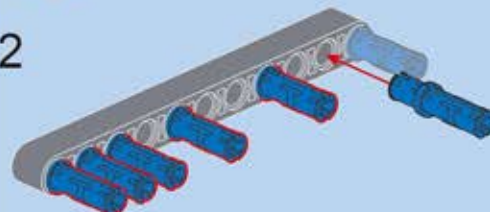



A4

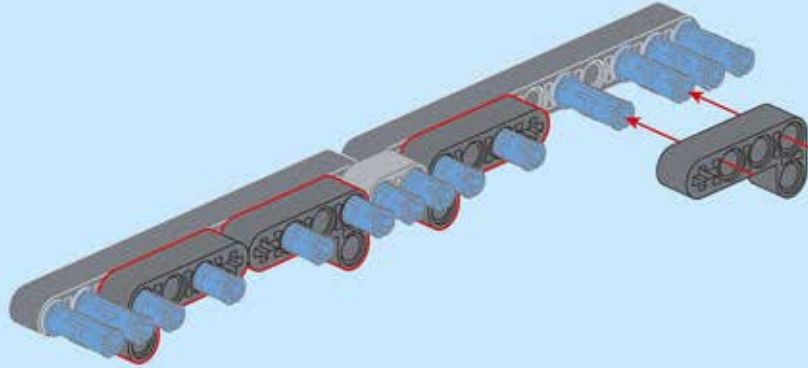
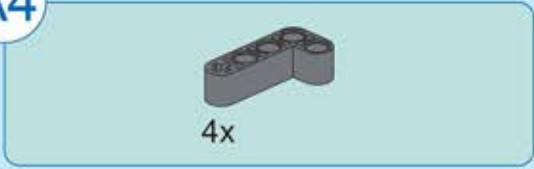

A5

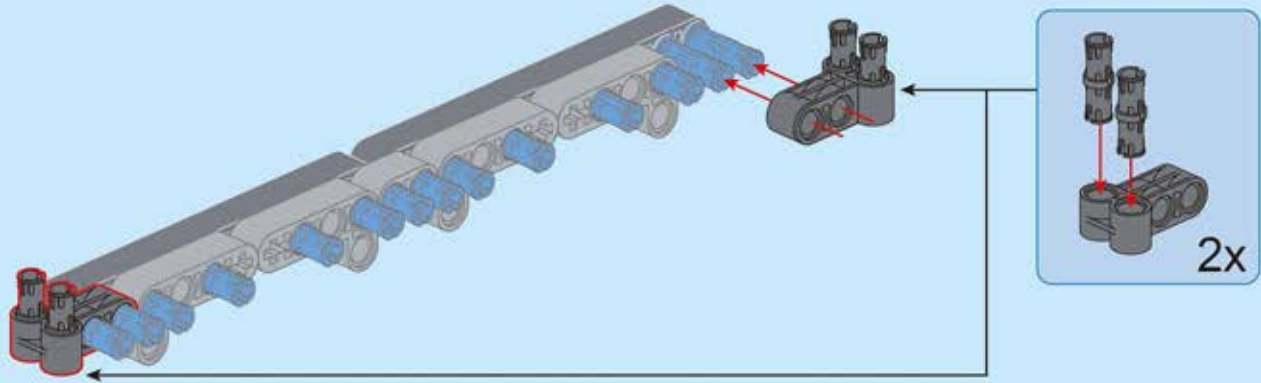
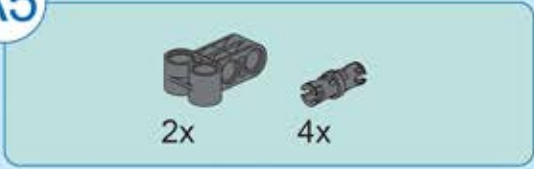

A6

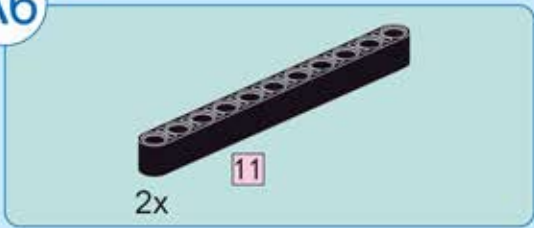

A7

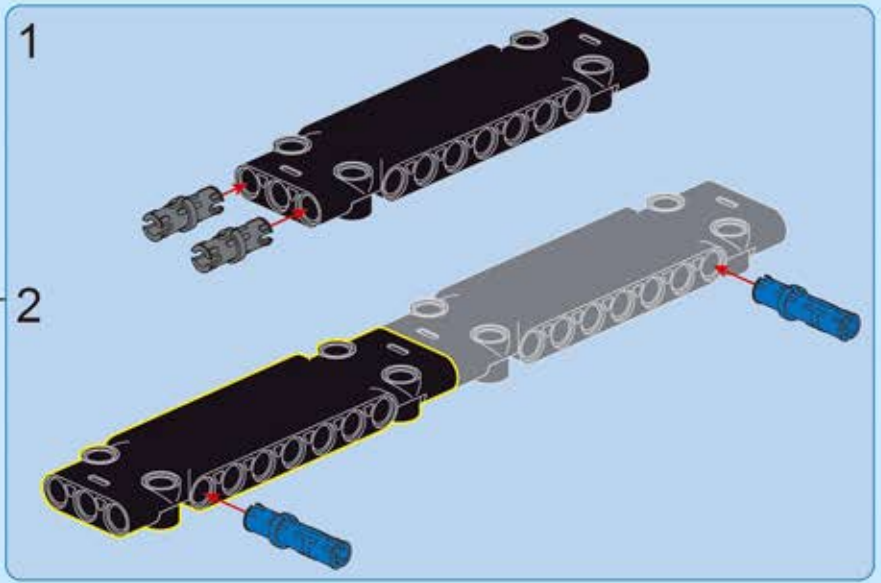
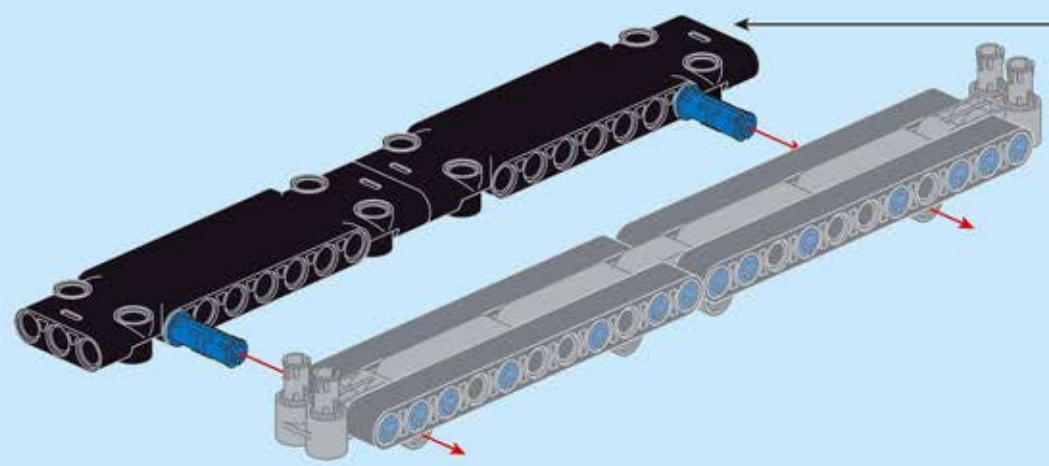
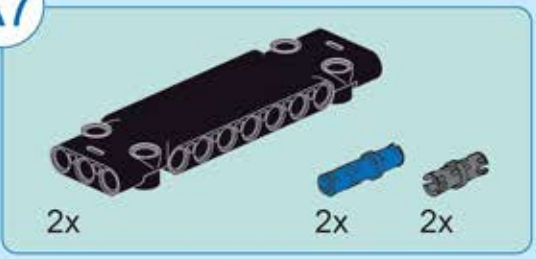

A8

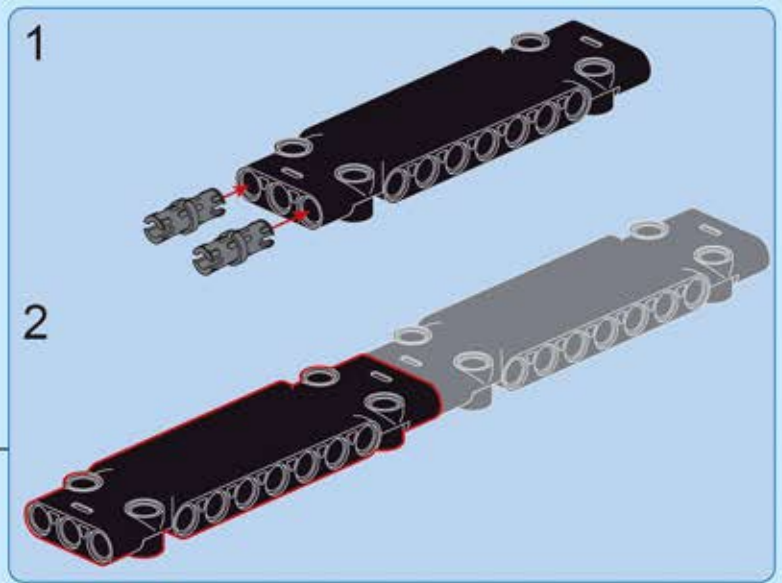
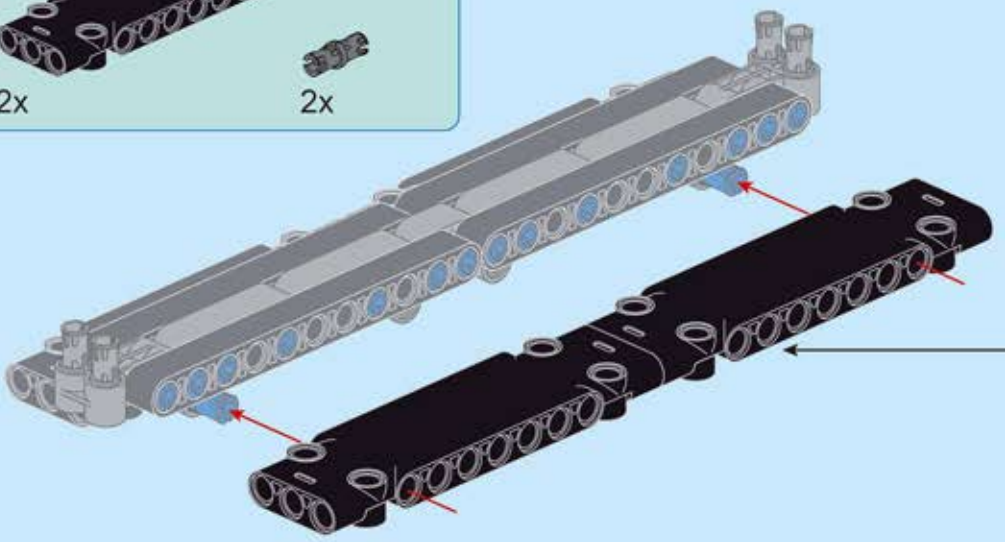
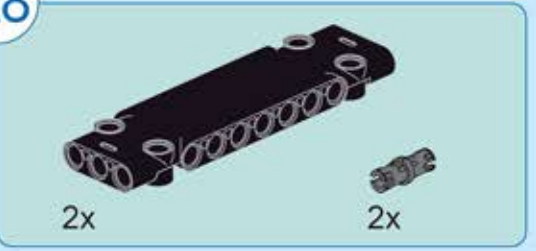

A9



2x



4x



2x



6x

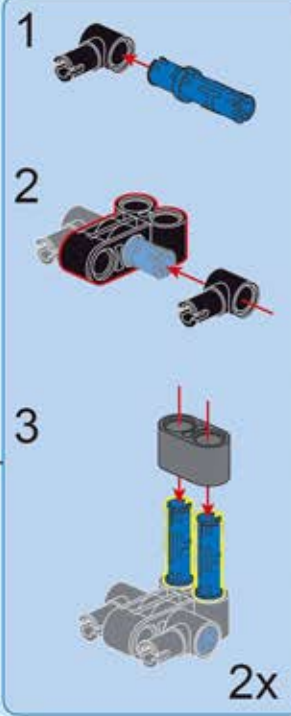
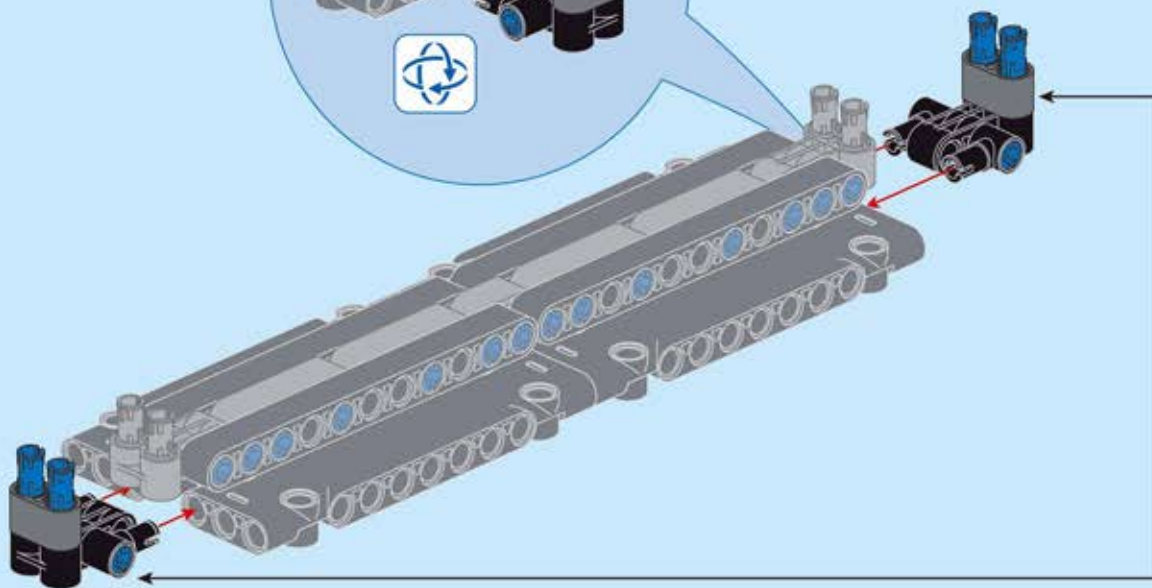
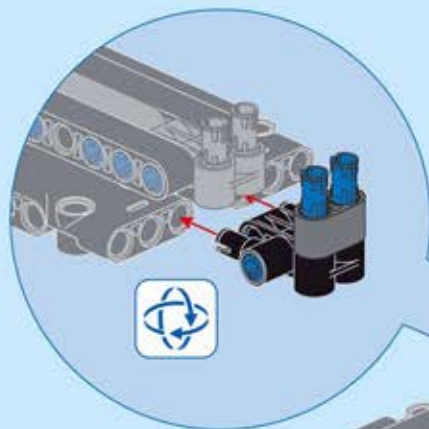

A10



4x



4x



4x



4x

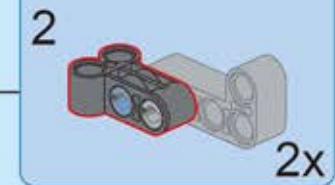
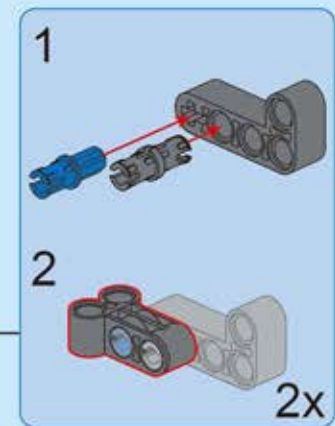
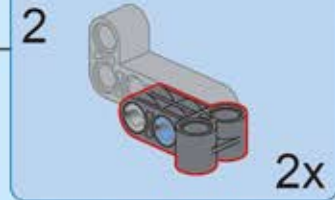
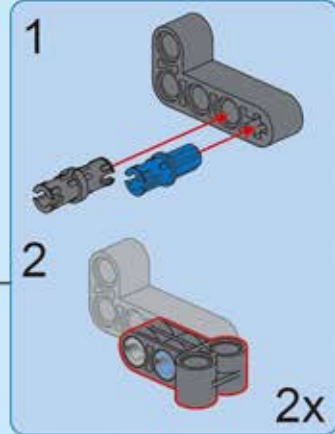
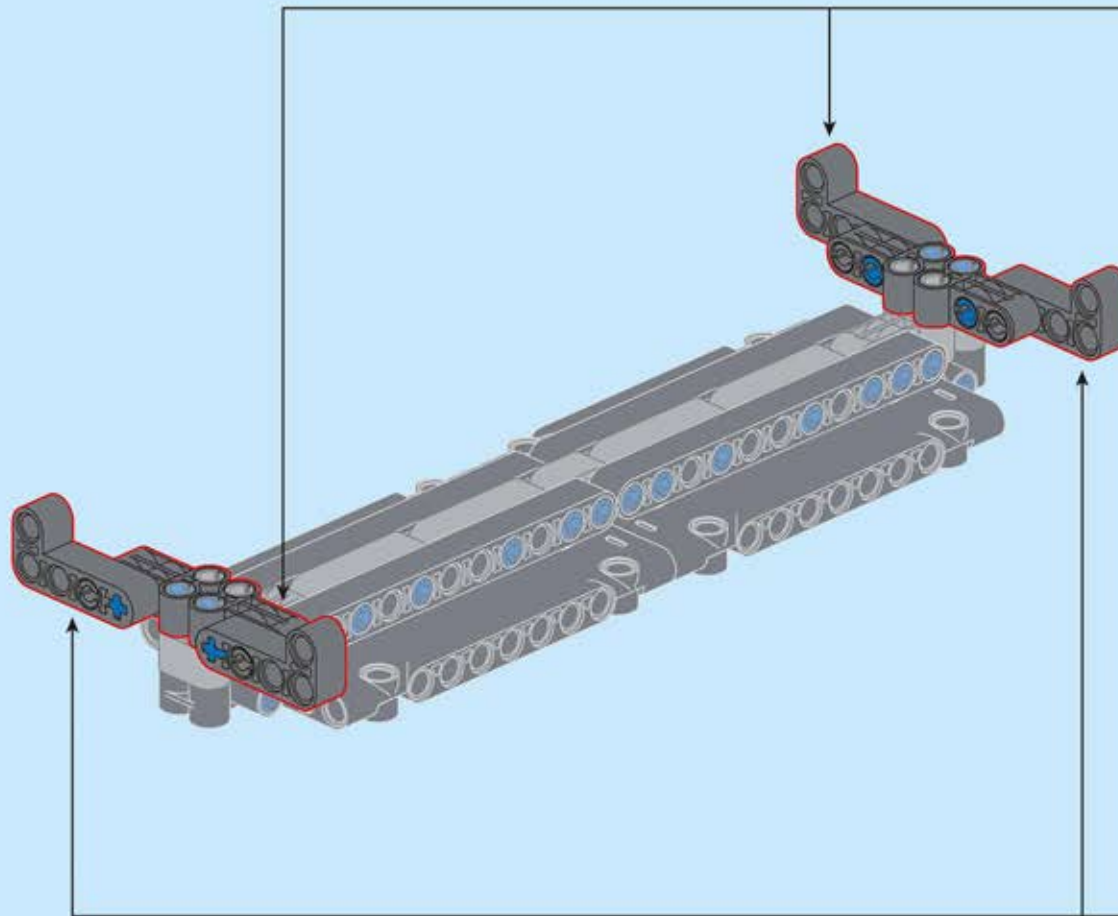

注意：需将此组件拆开，然后在相对应的序号步骤处拼装。
Caution: This set piece needs to be separated, and assembled at respective sequence number.

该积木用于第5分包
This brick is for pack 5

1x B130 4x8
1x A11 3x4
1x A11 3x4

A11

1x 3x4 1x 3x4 2x 1x
1x 1x8 4x 2x 2x 2x

1

2

3

1 2

2x

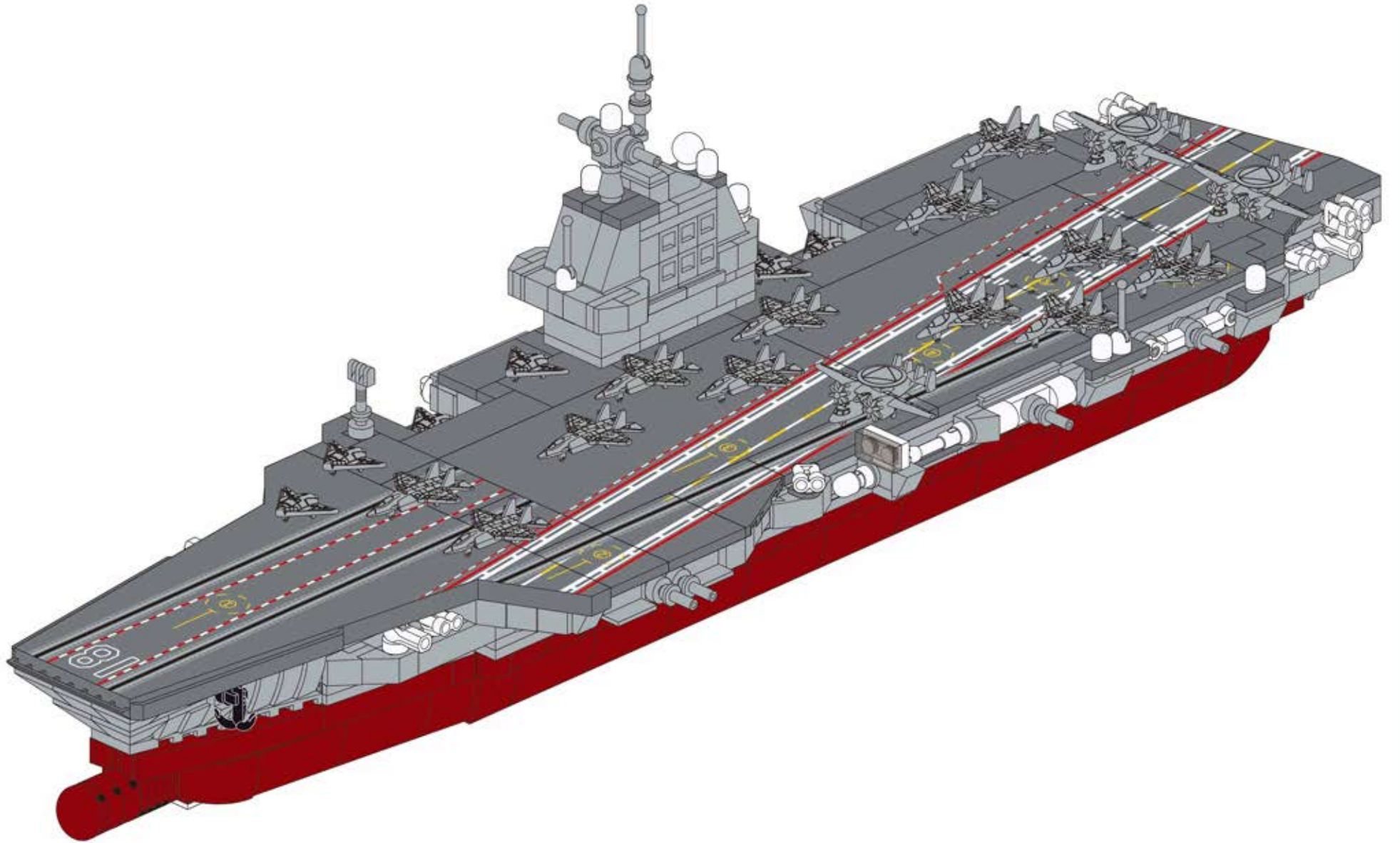

B1

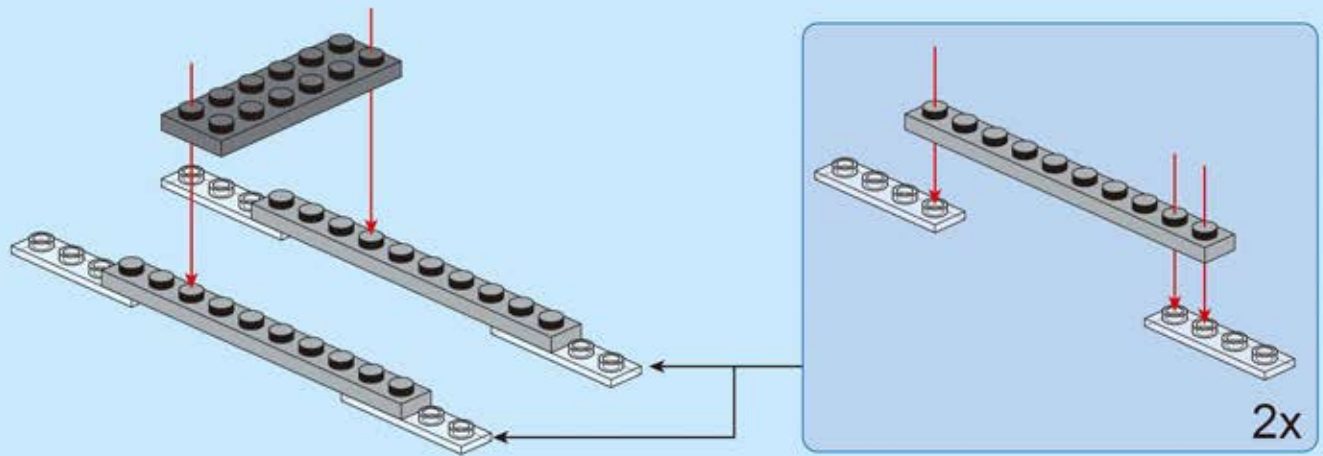
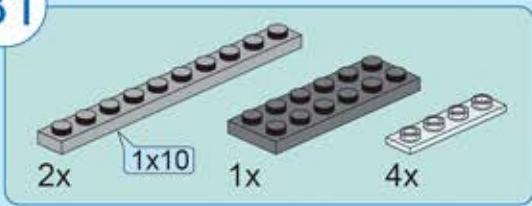

B2

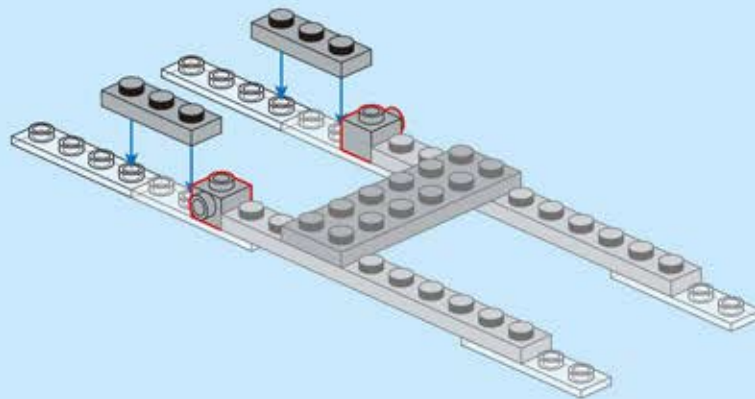
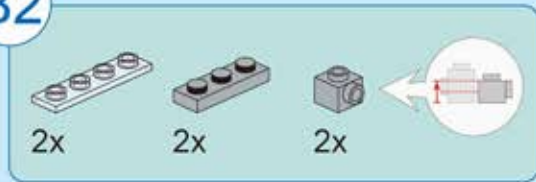

B3

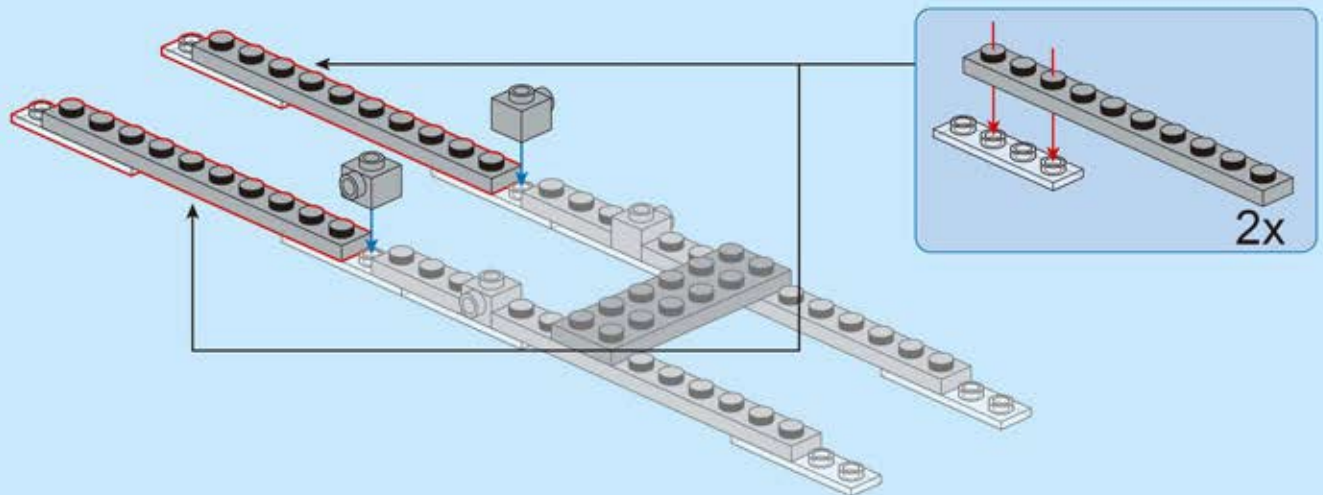
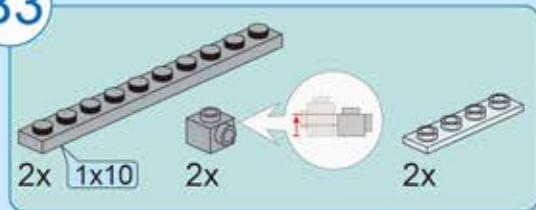

B4

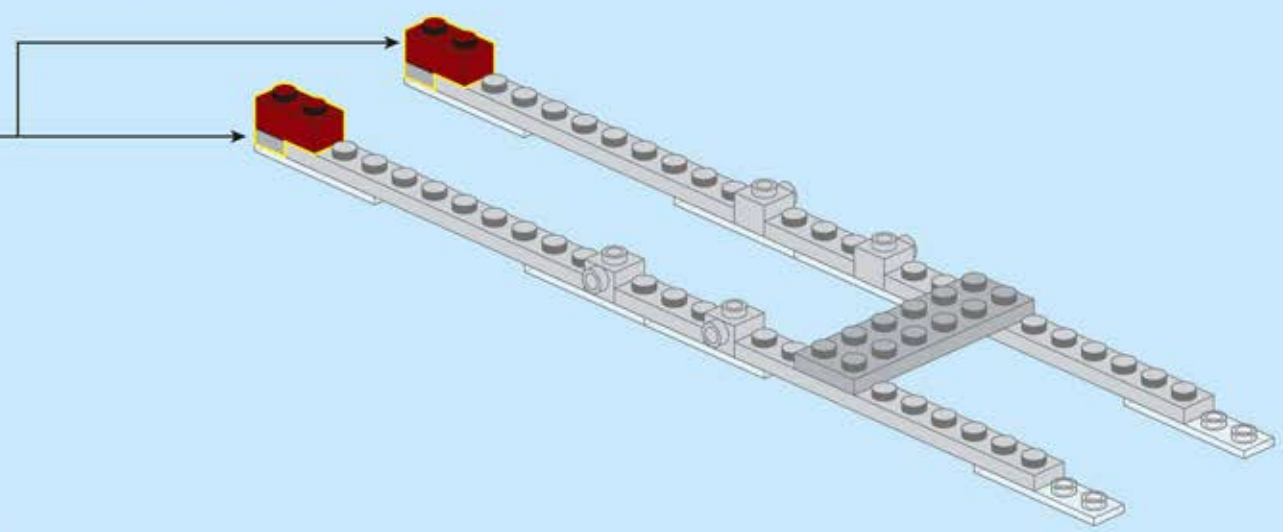
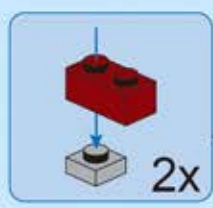
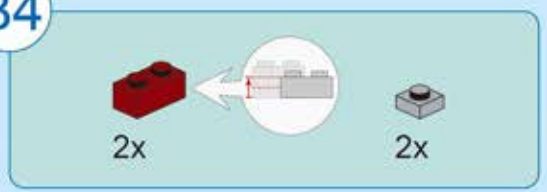

B5

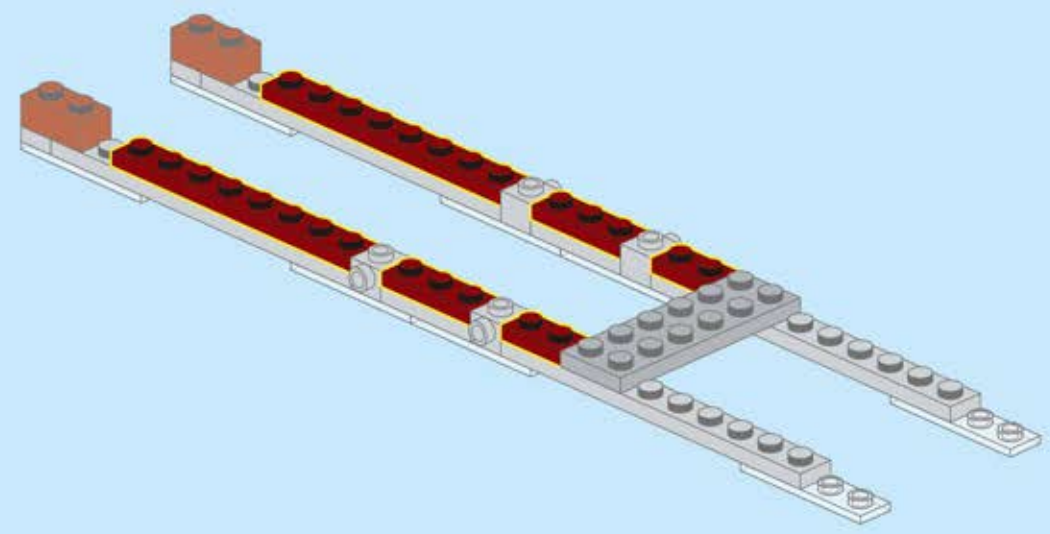
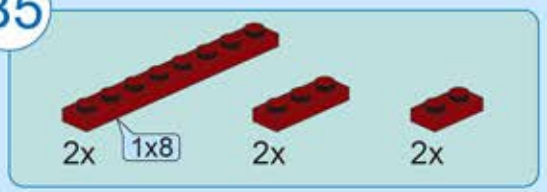

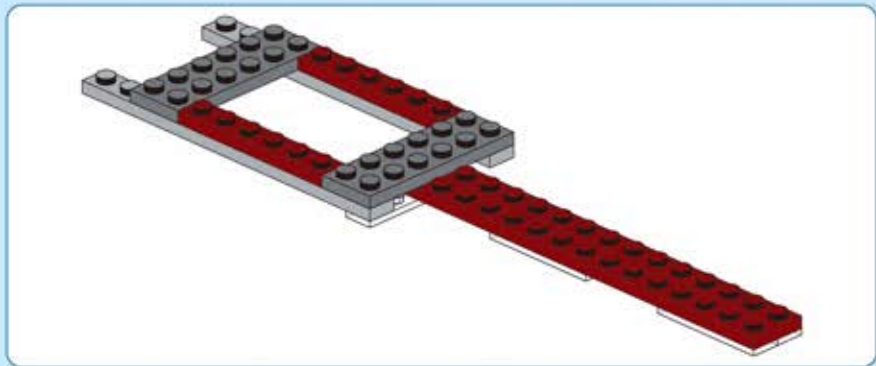

B6

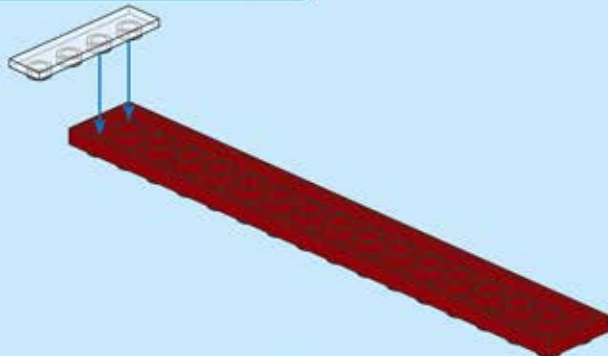
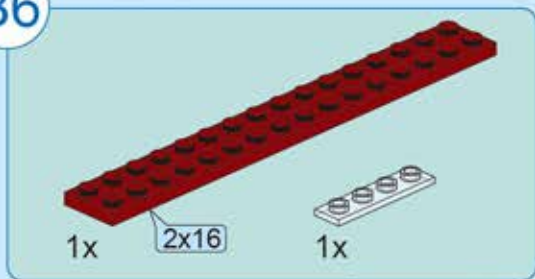

B7

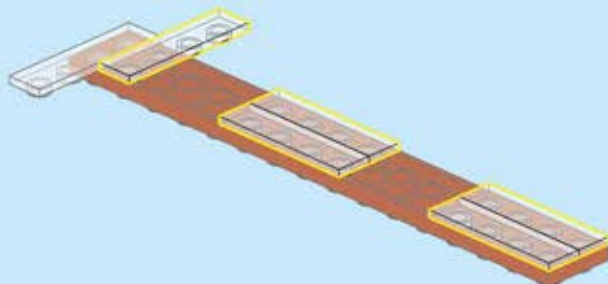
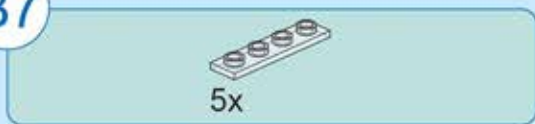

B8

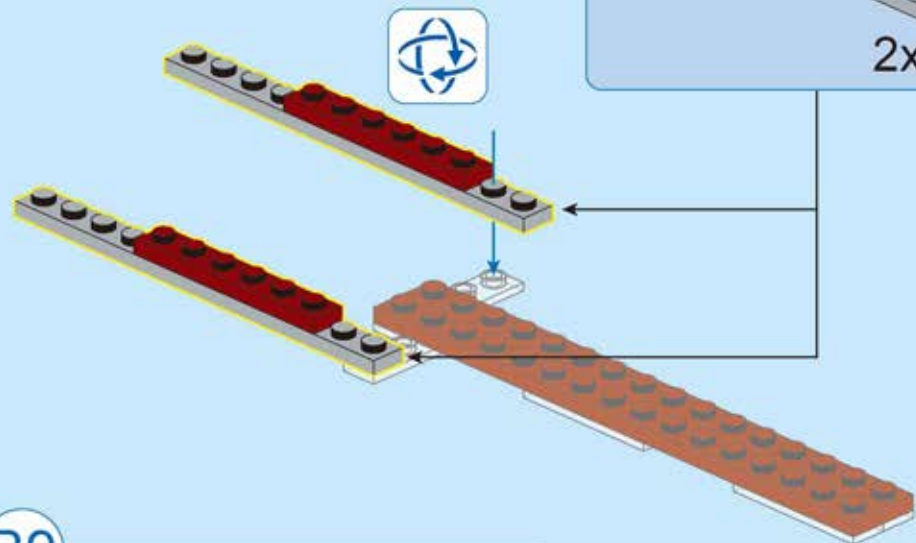
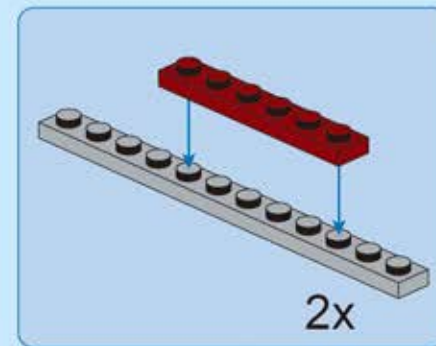
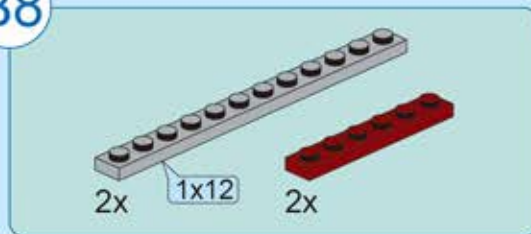

B9

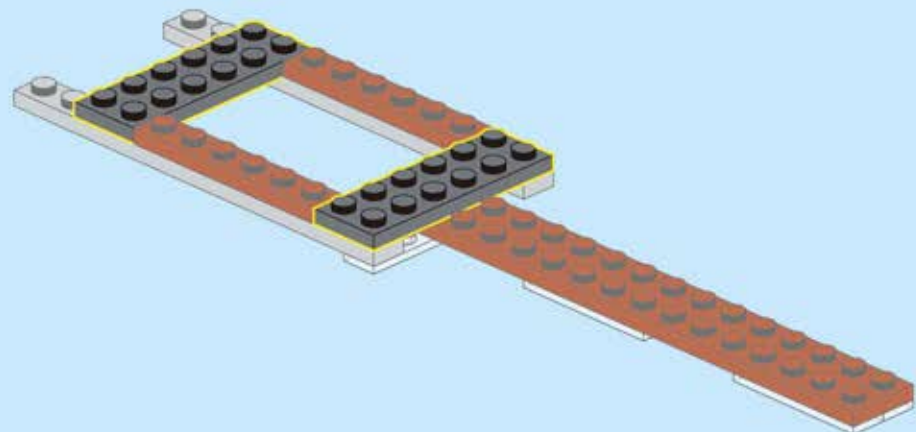
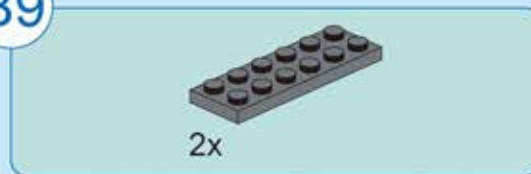

B10

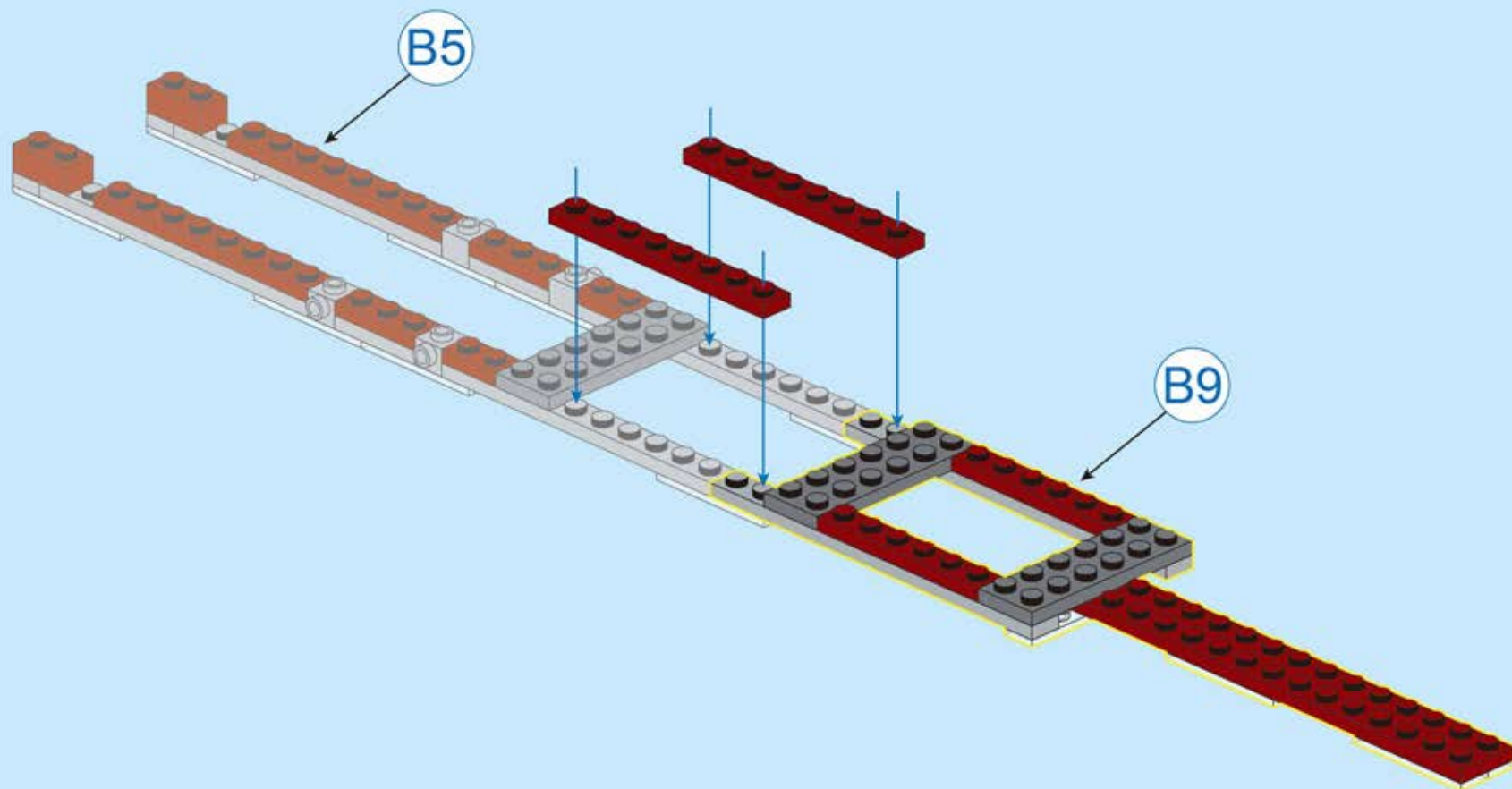
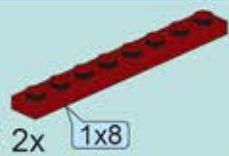

B11

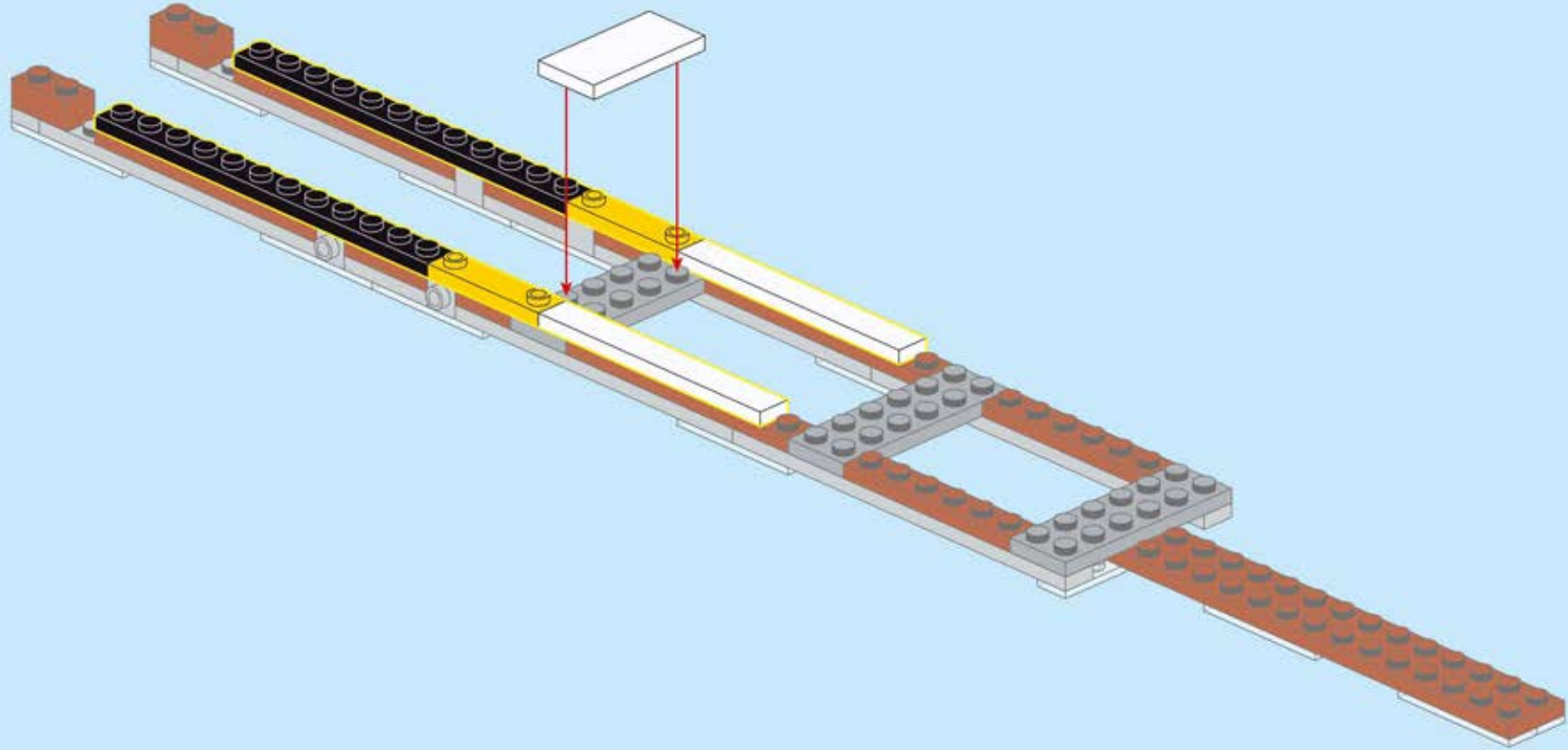
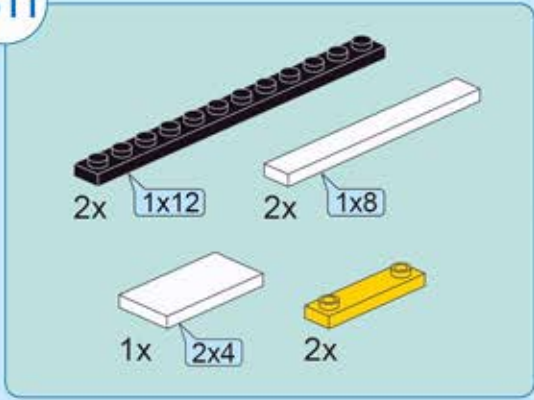

B12



2x



2x



2x

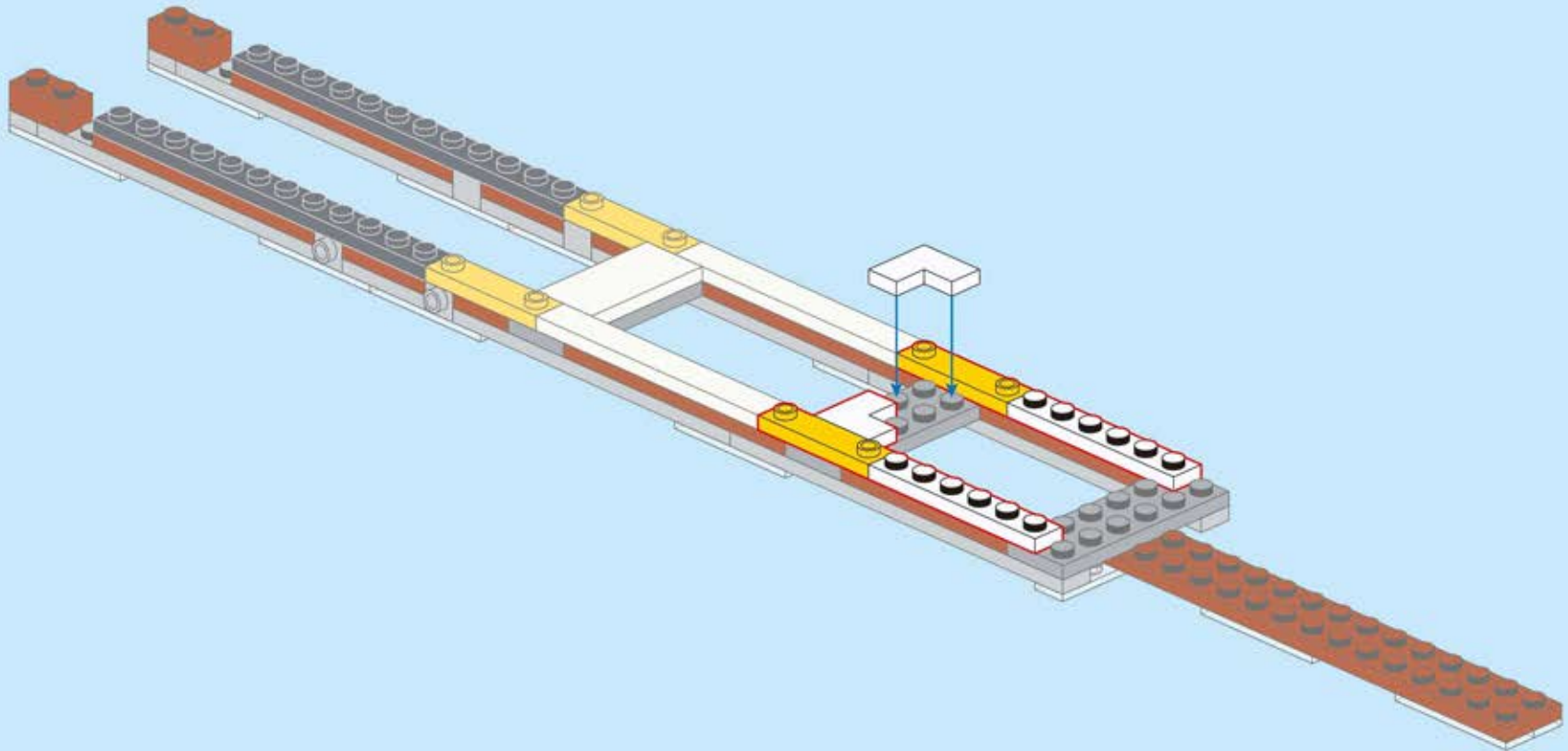

B13

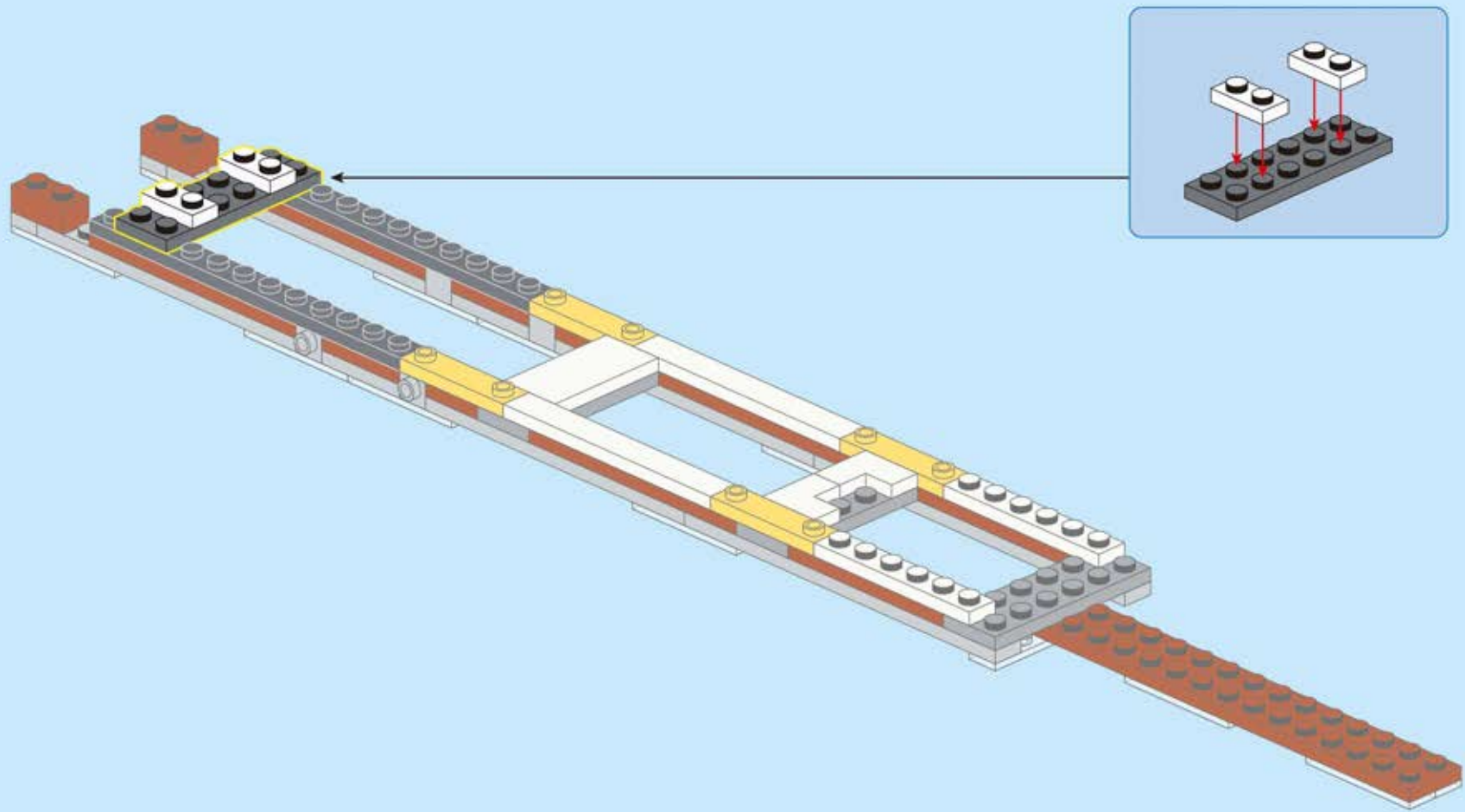
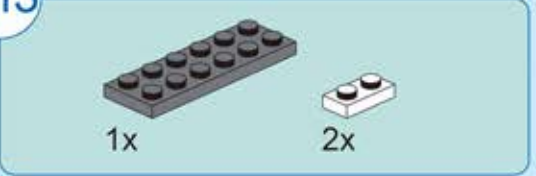

B14

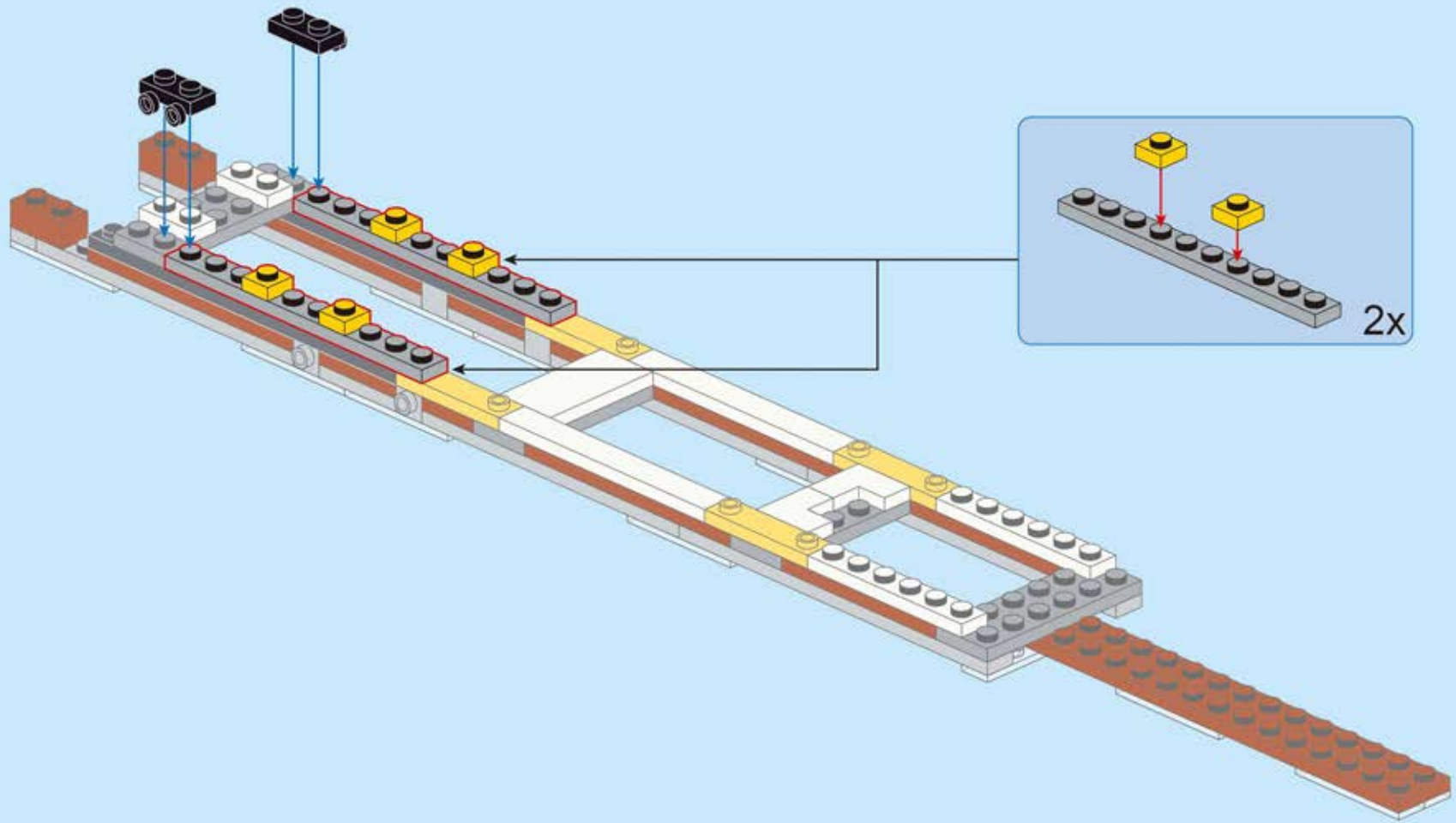
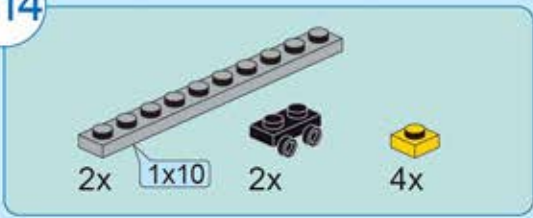

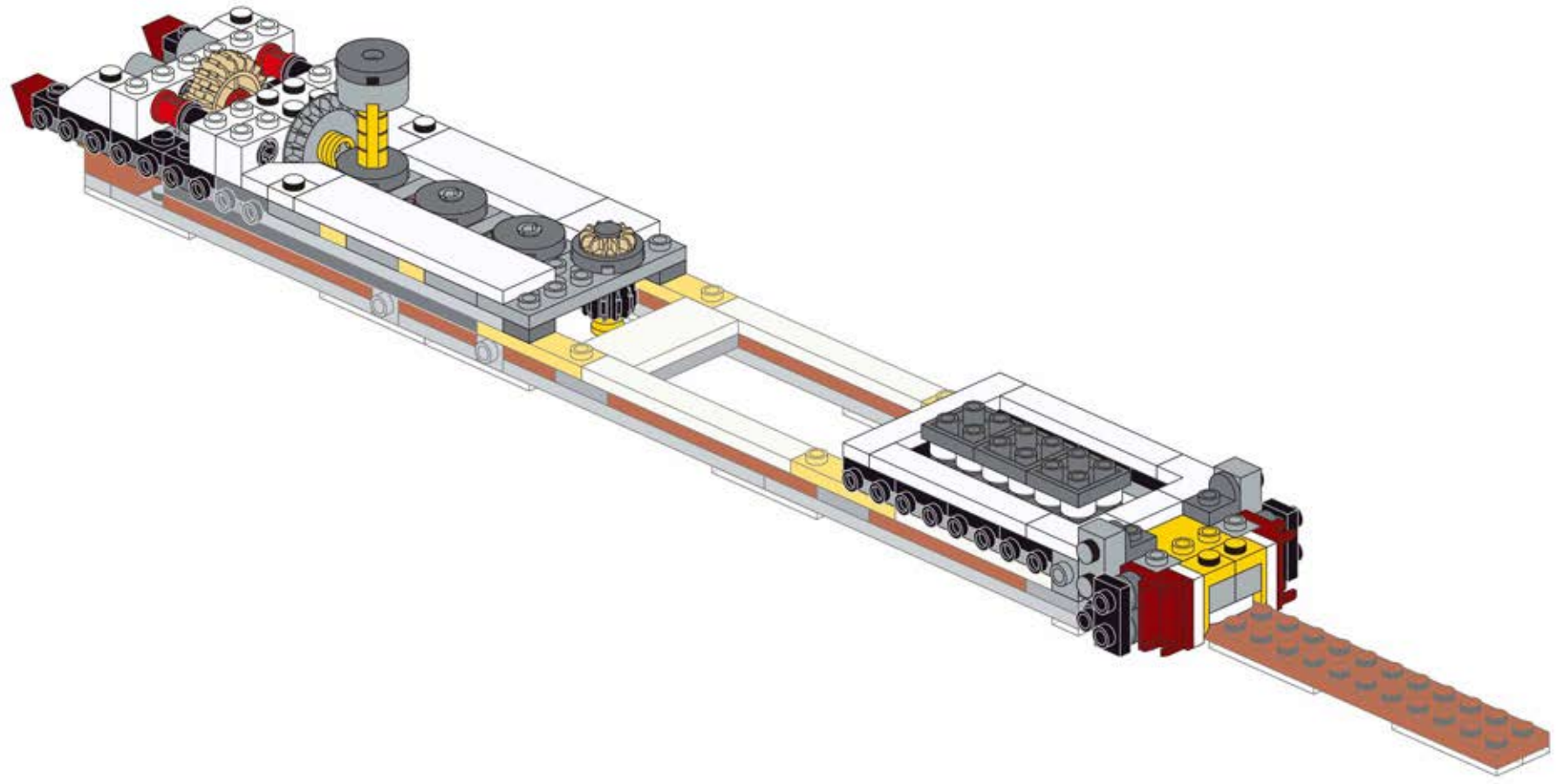

B15

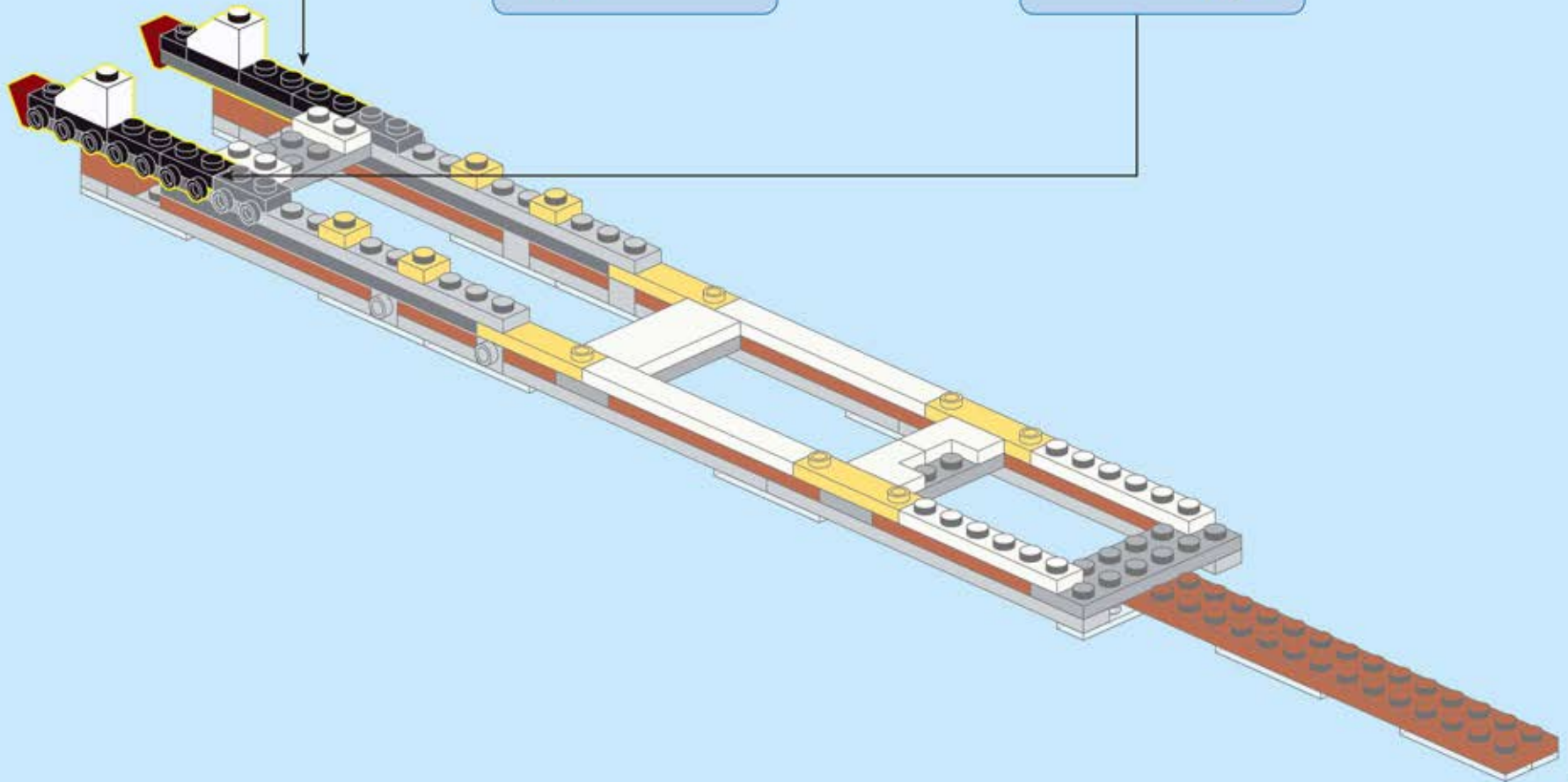
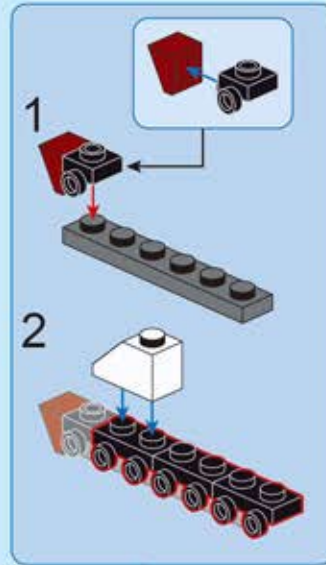
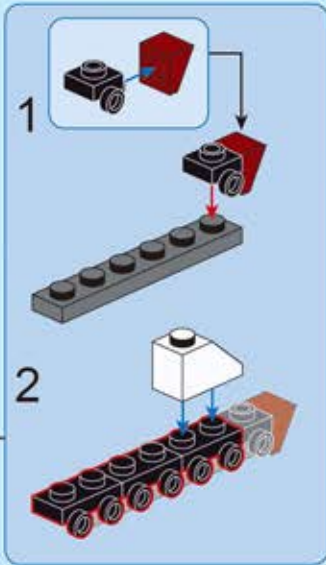
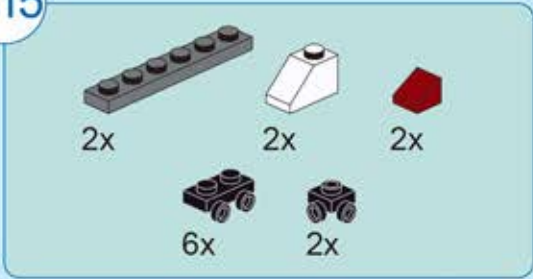

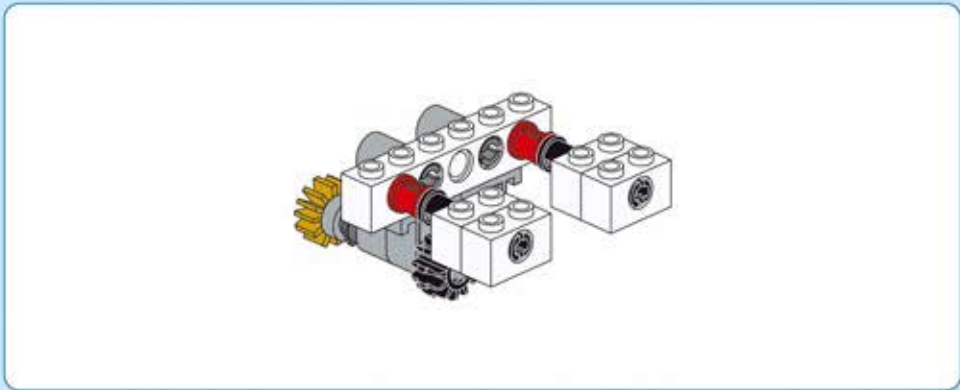

B16

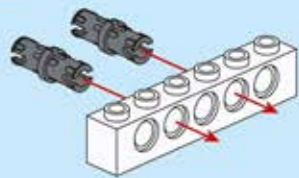
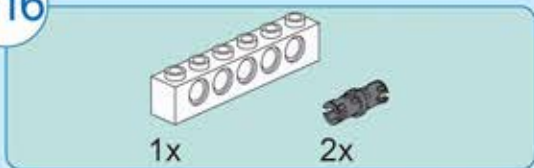

B17

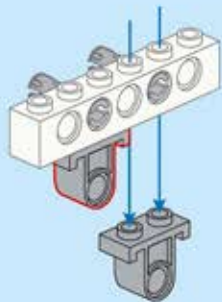

B18

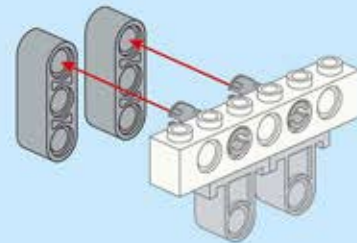
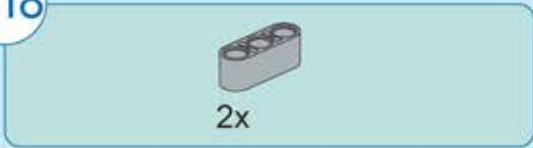

B19

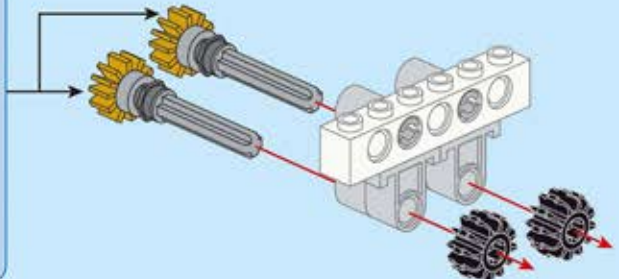
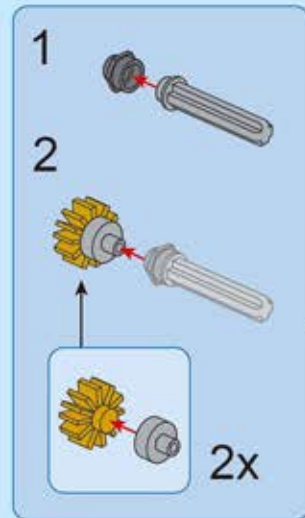

B20

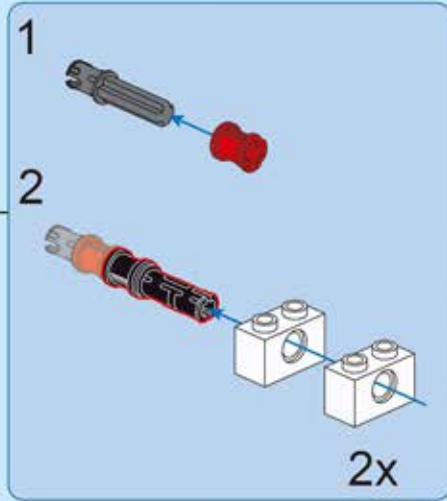
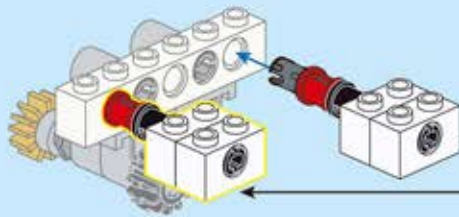

B21

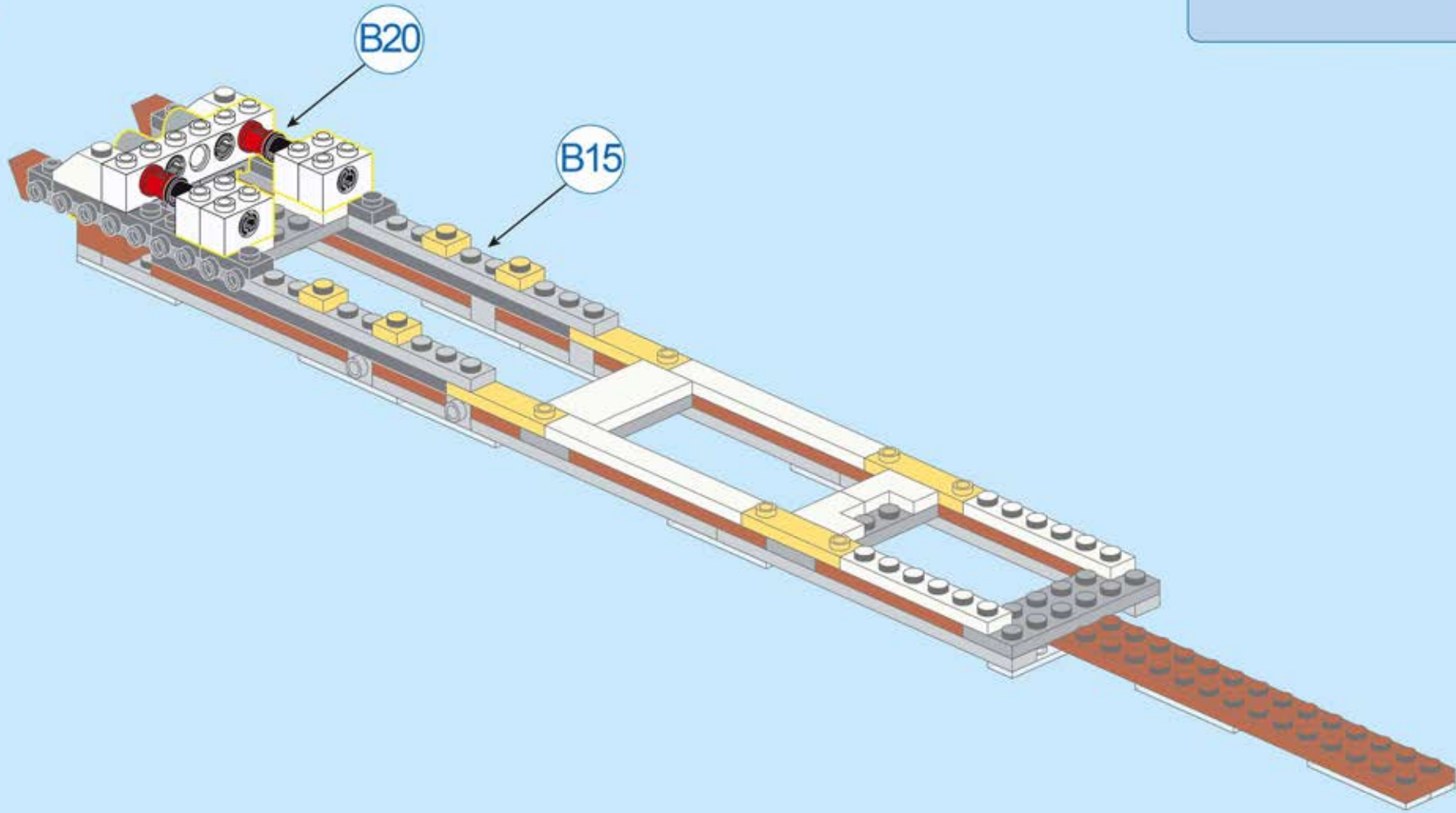

B22

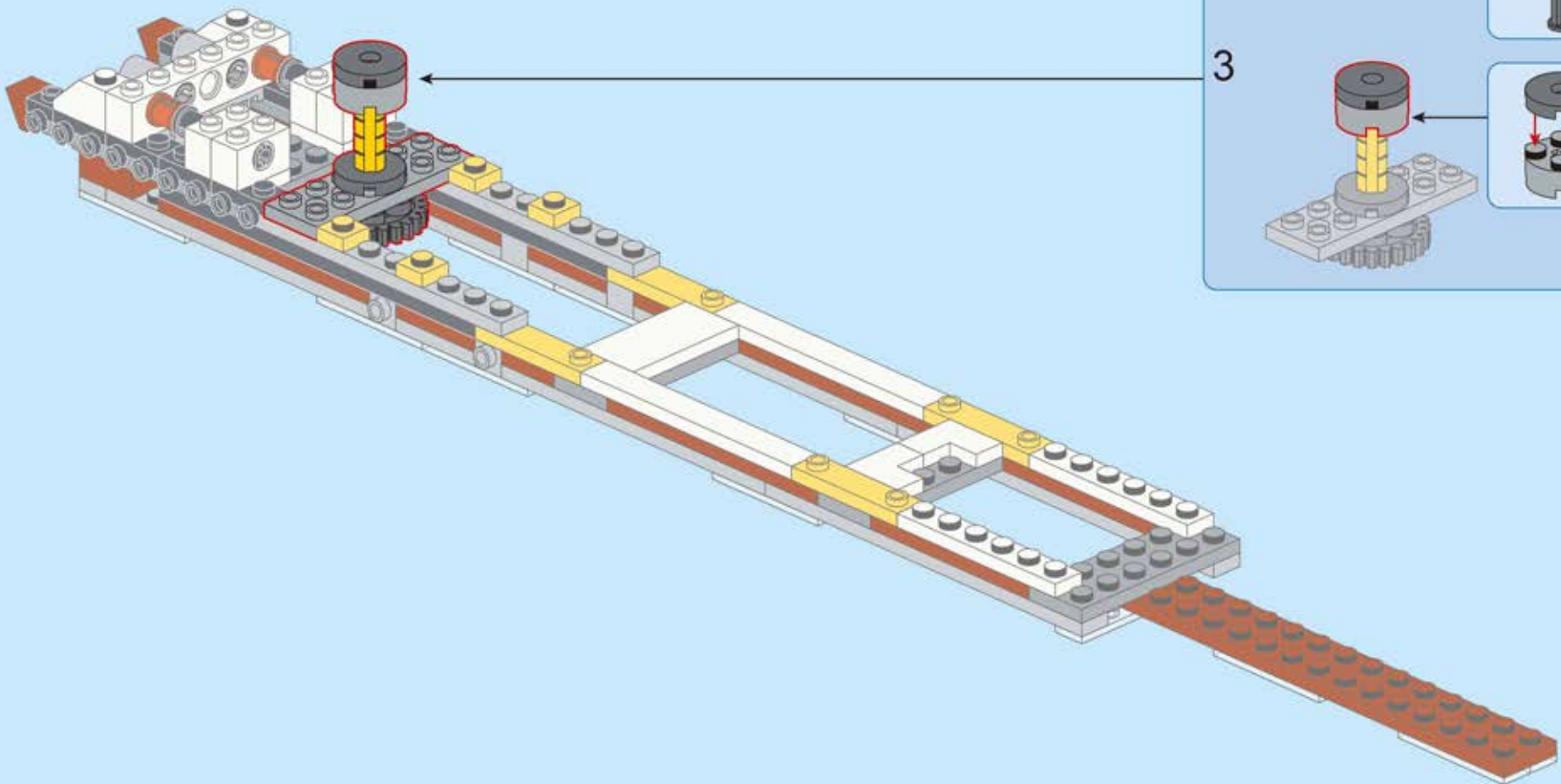
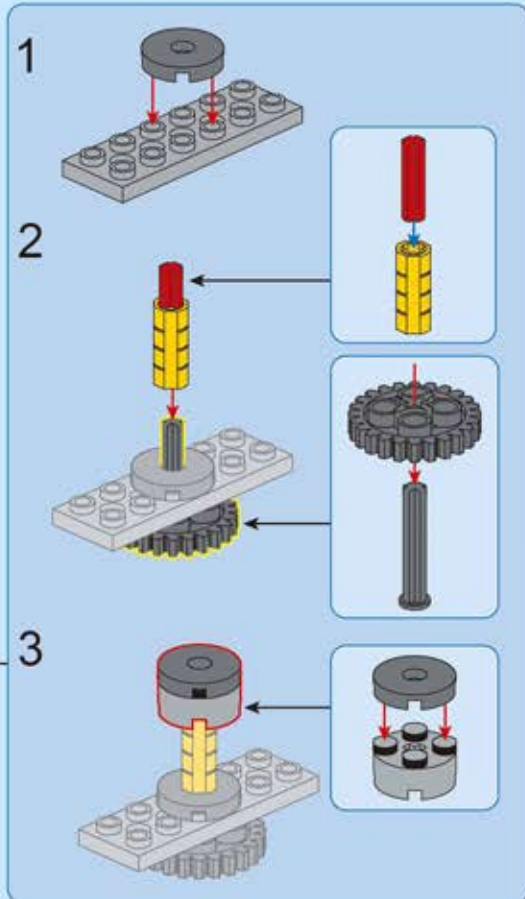
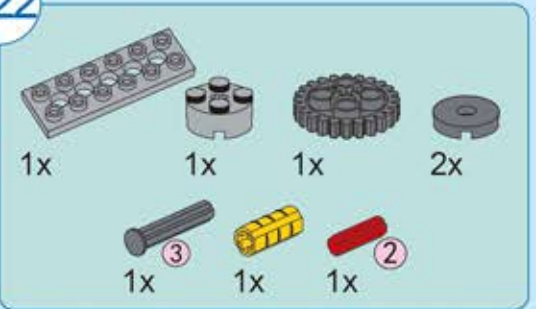

B23

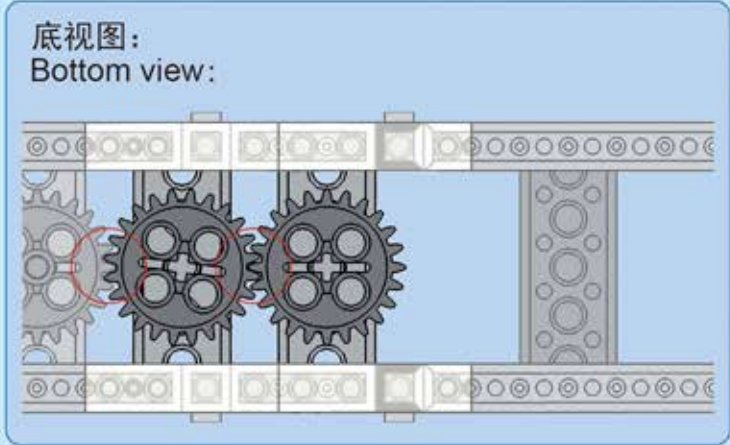
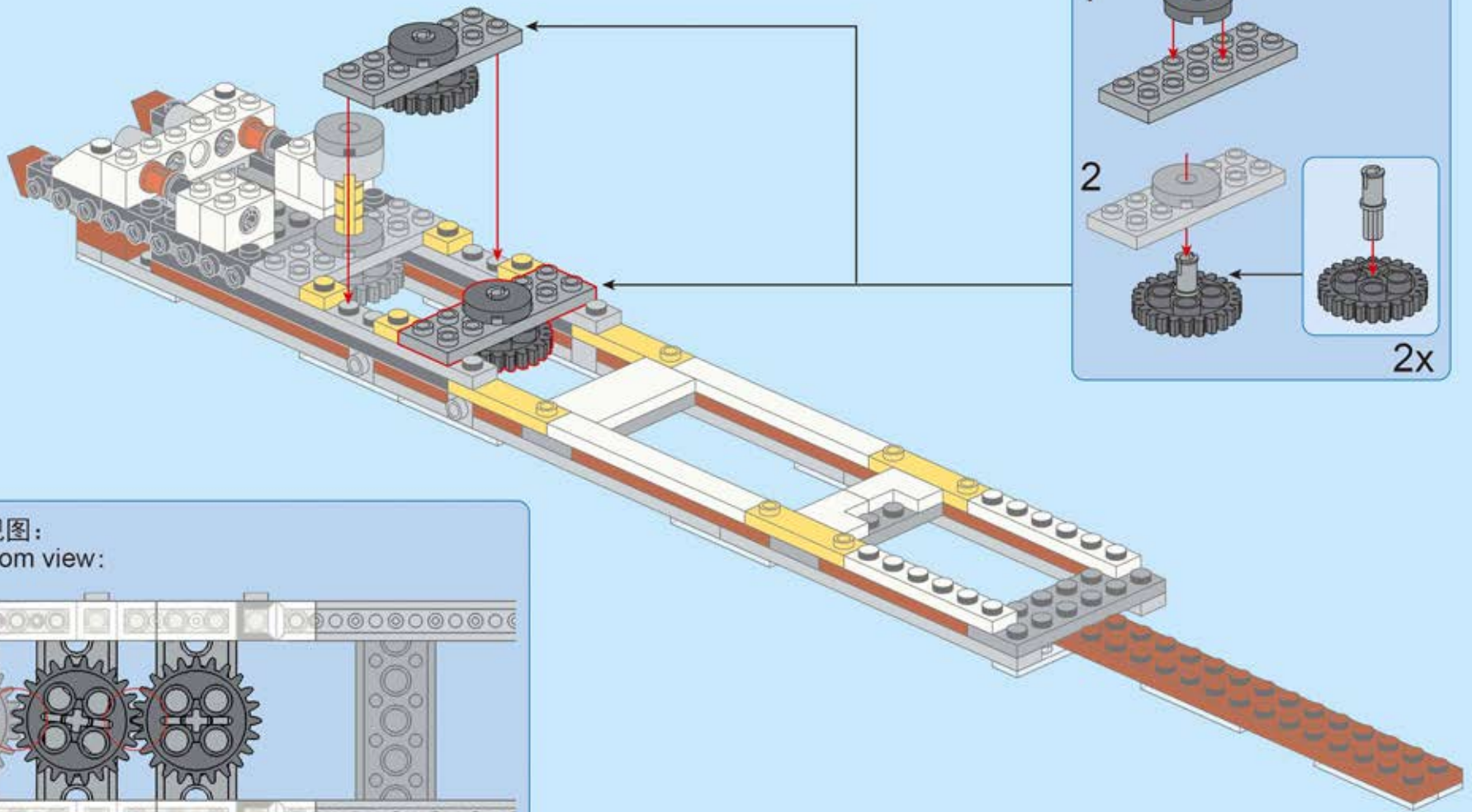

B24

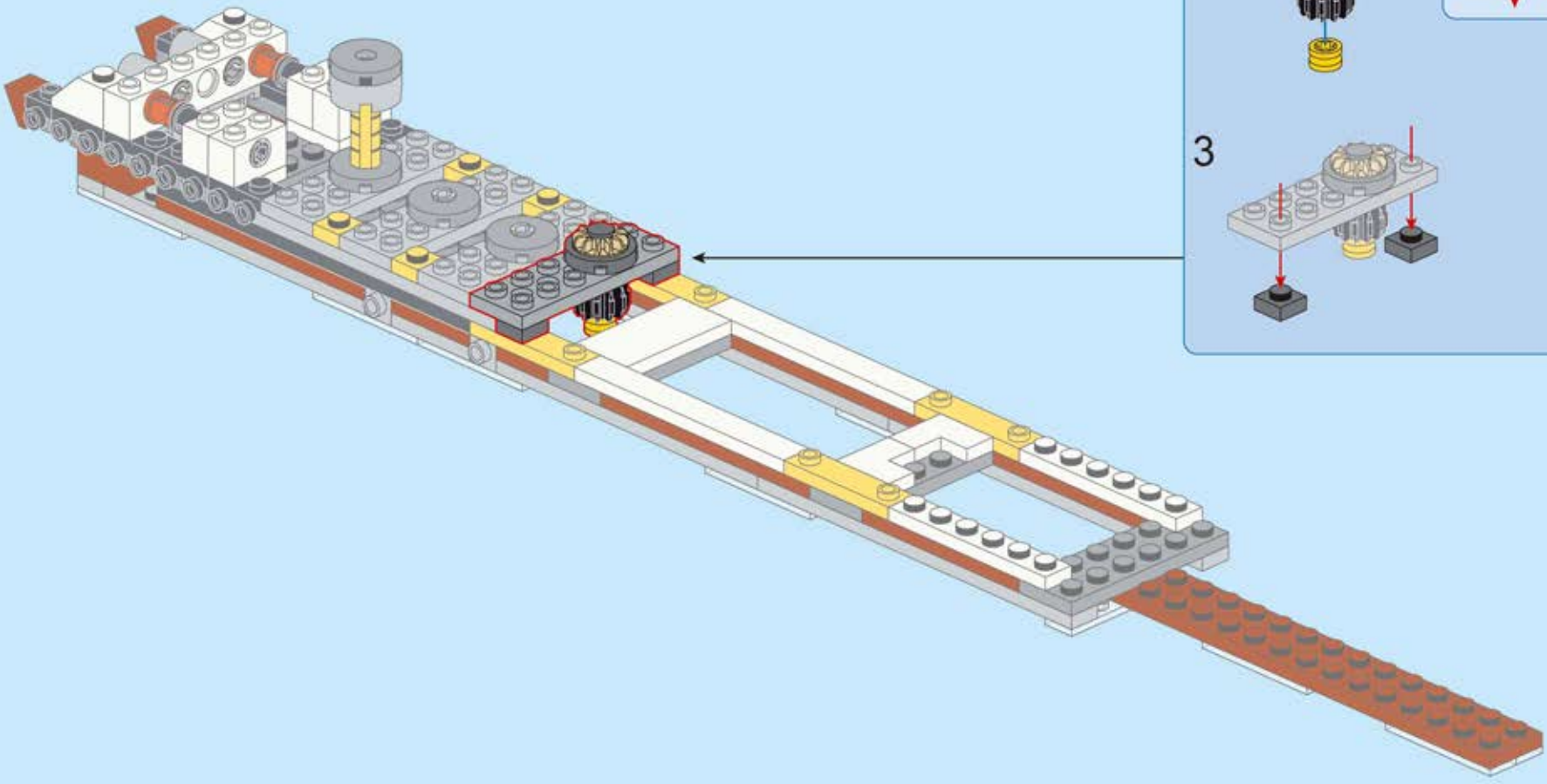
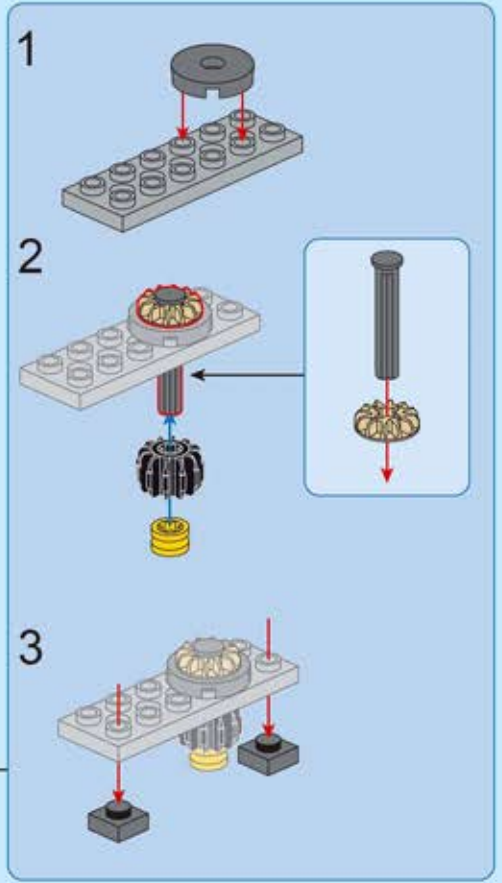
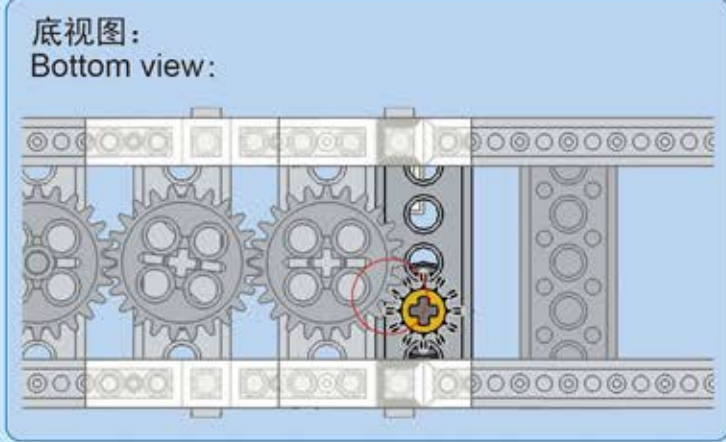

B25

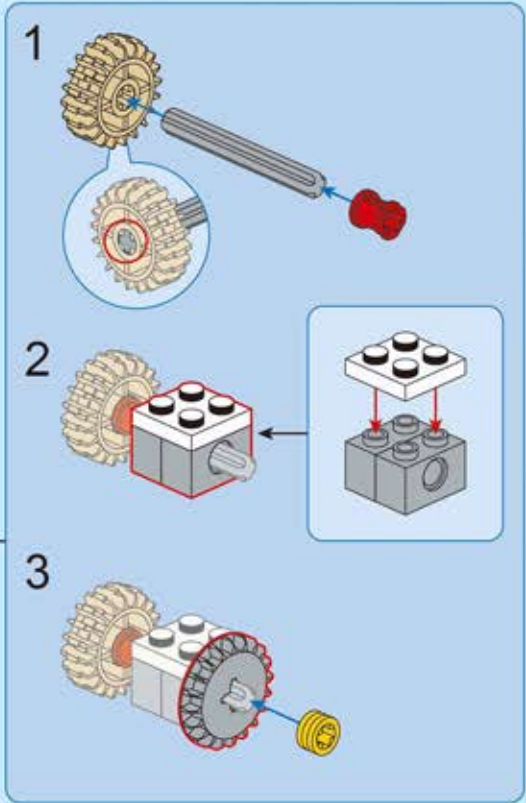
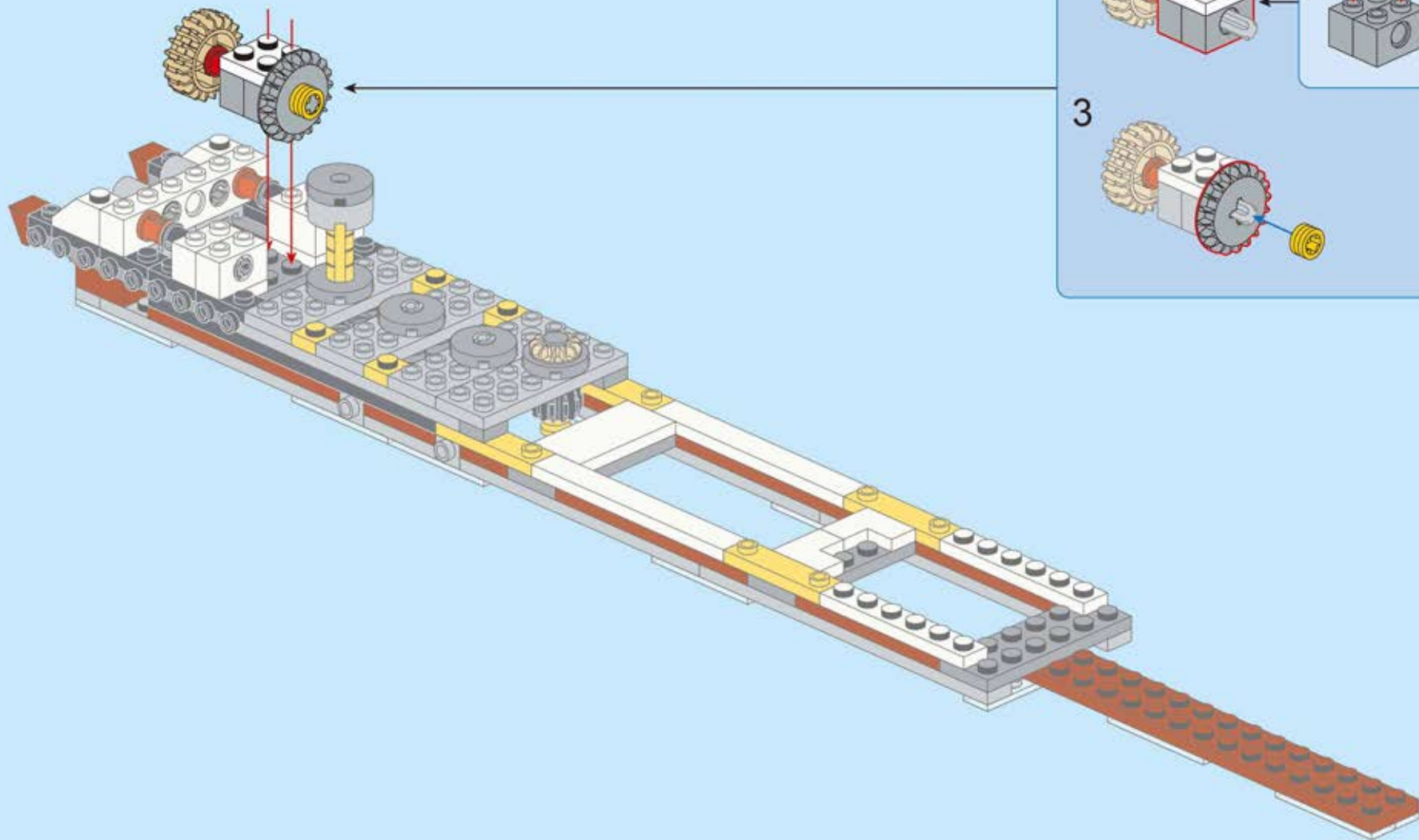
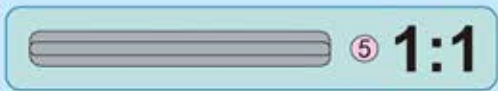
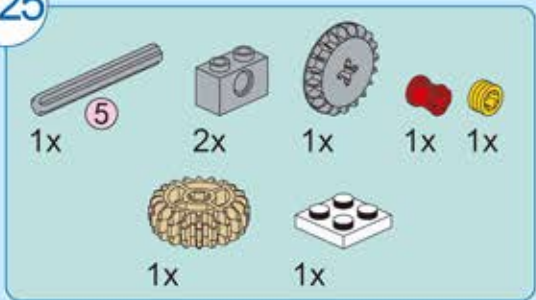

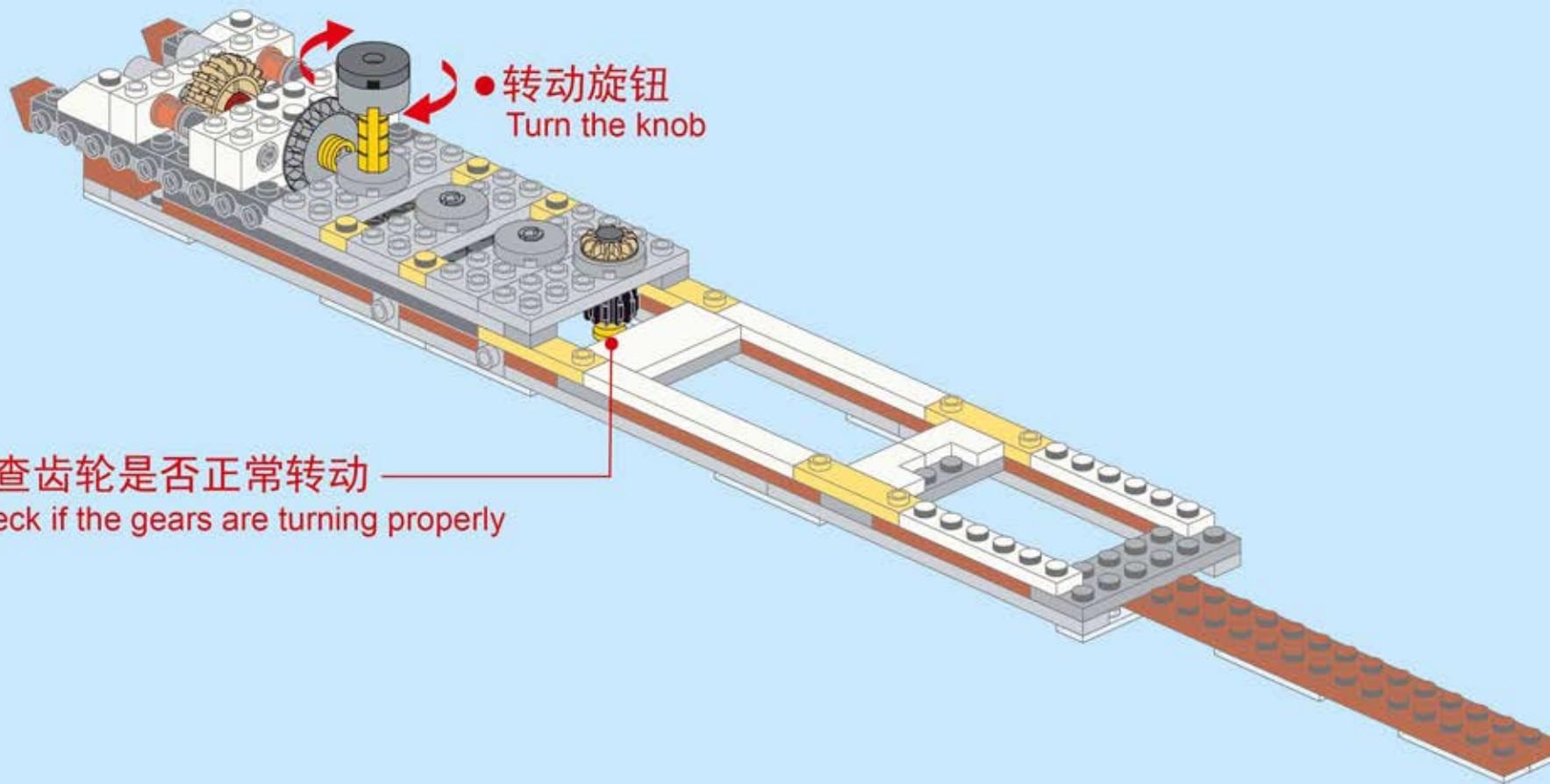

• 转动旋钮
Turn the knob

检查齿轮是否正常转动
Check if the gears are turning properly

B27

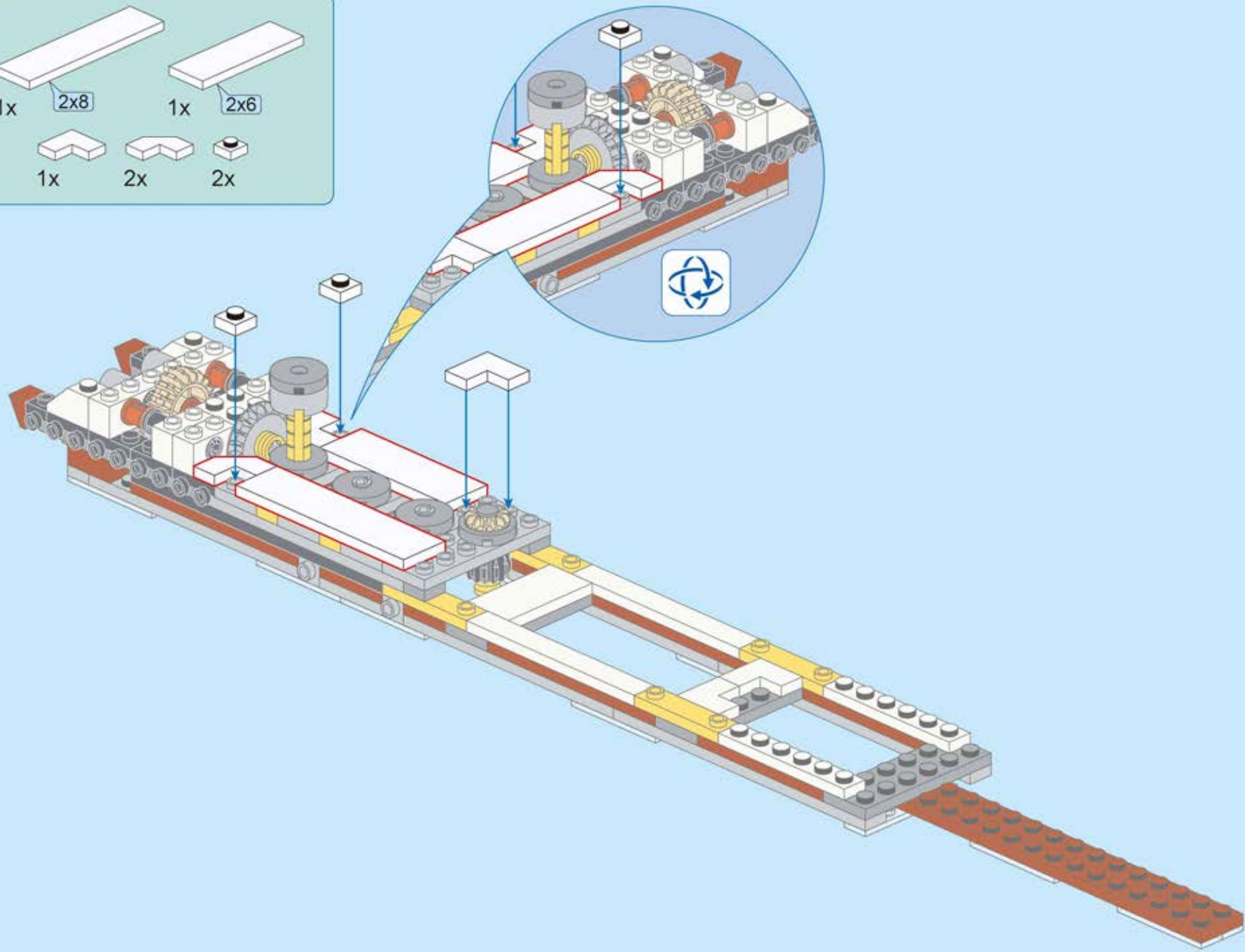
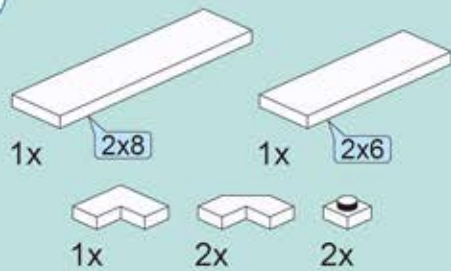

B28

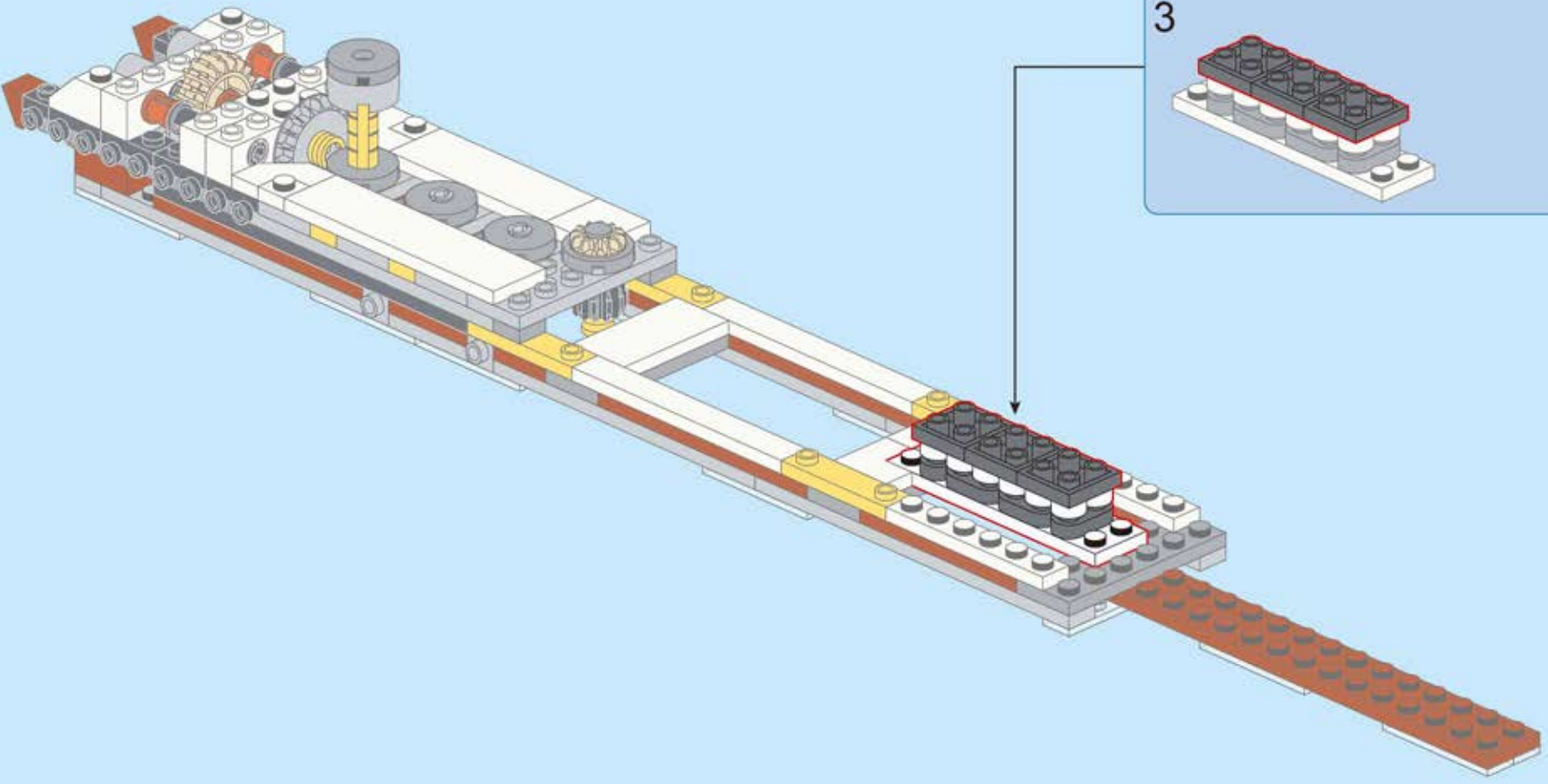
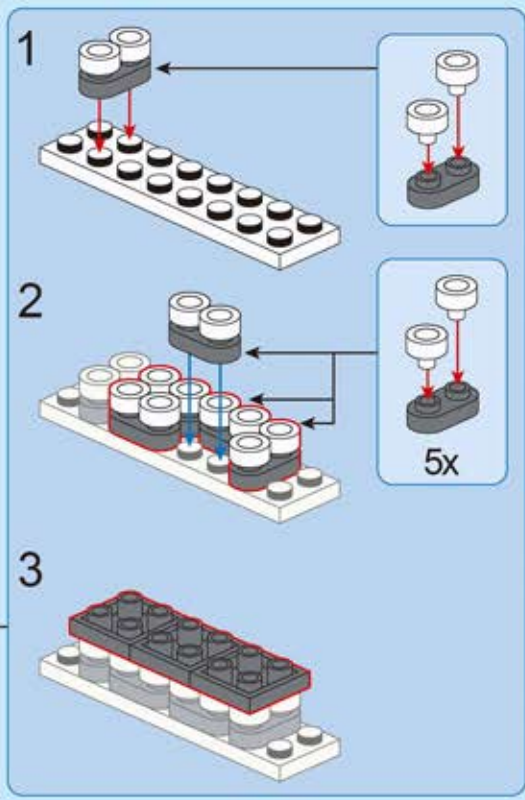
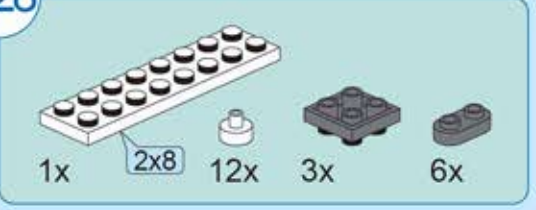

B29

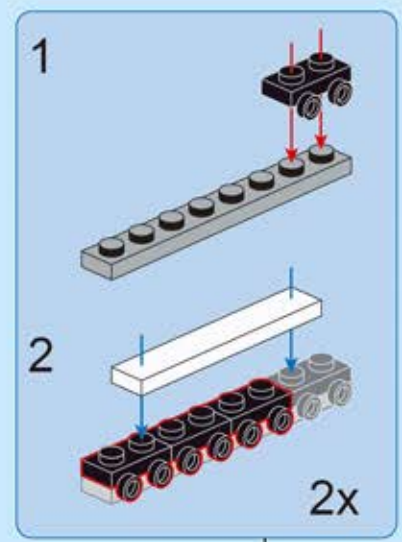
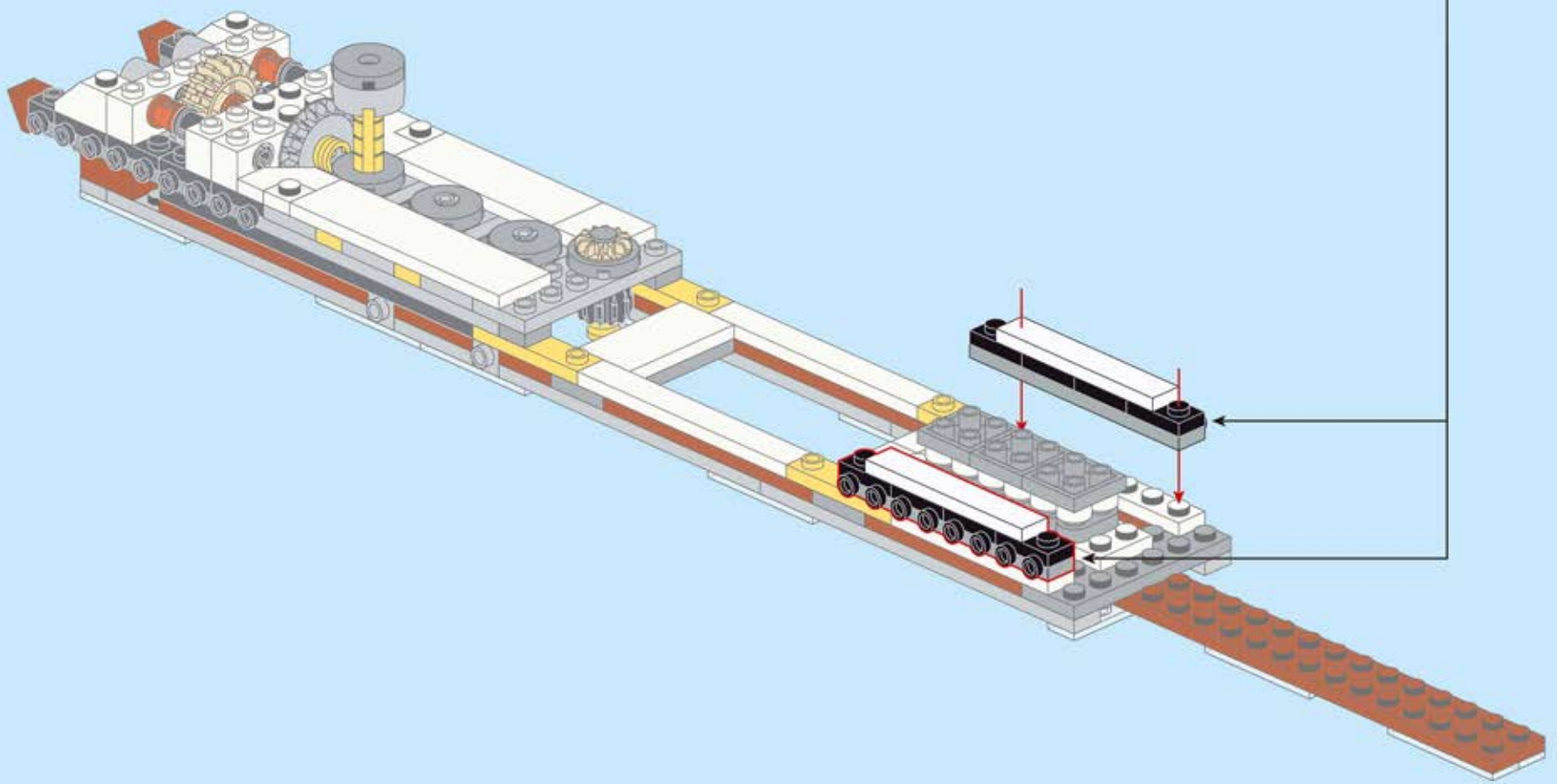
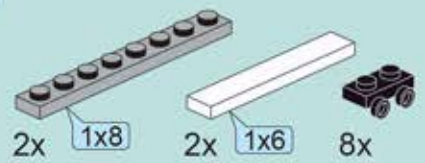

B30

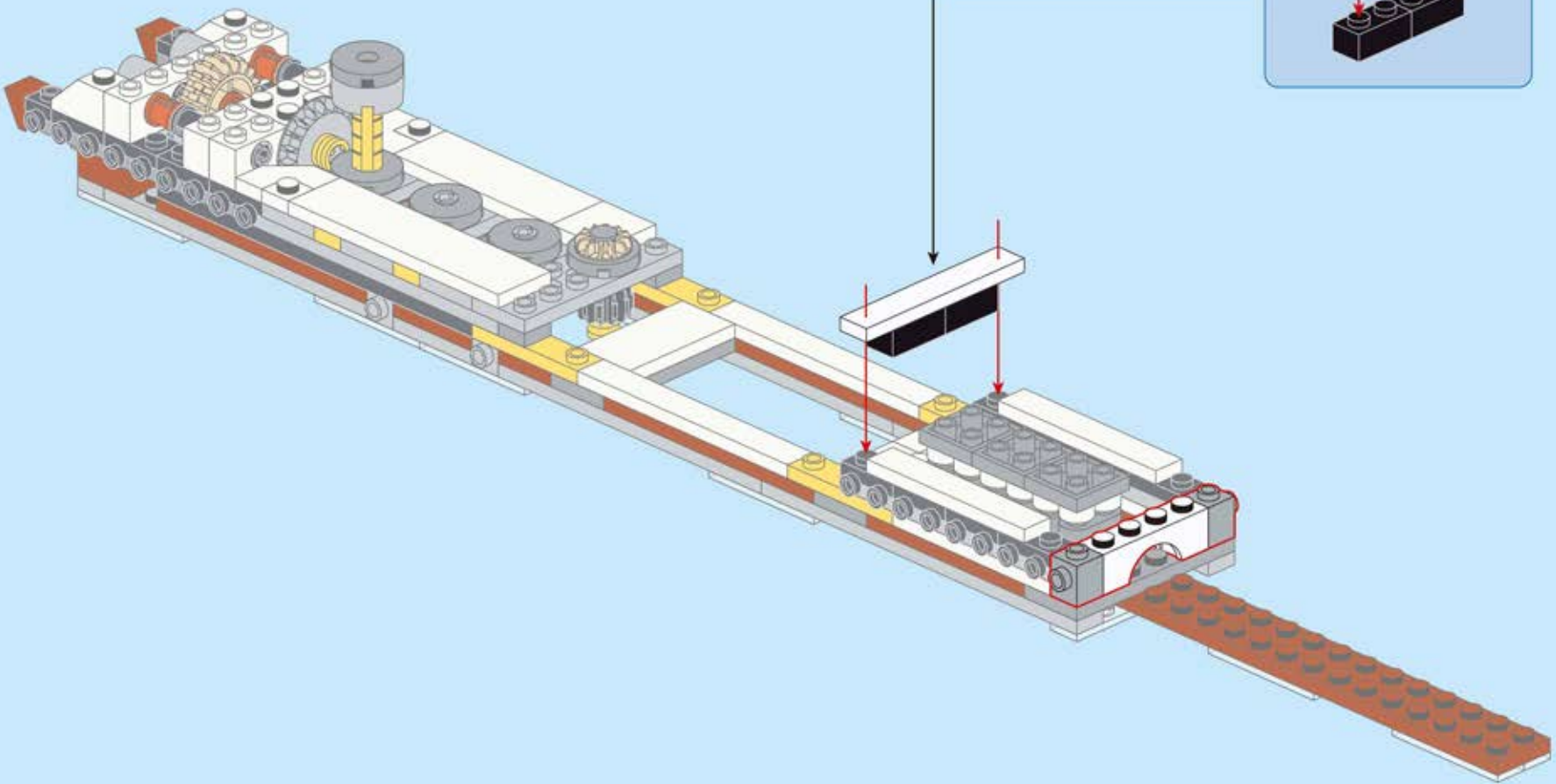
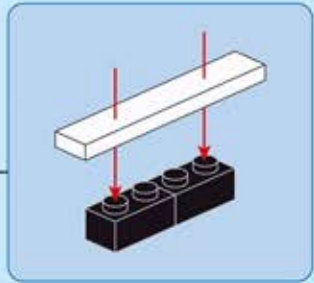
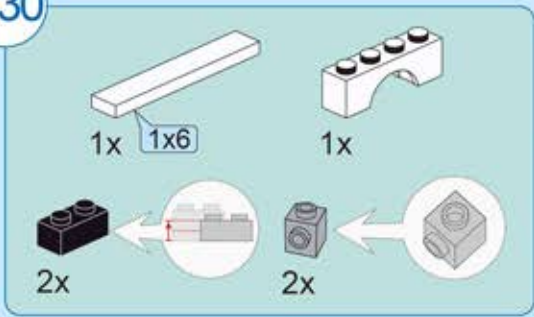

B31



2x



1x

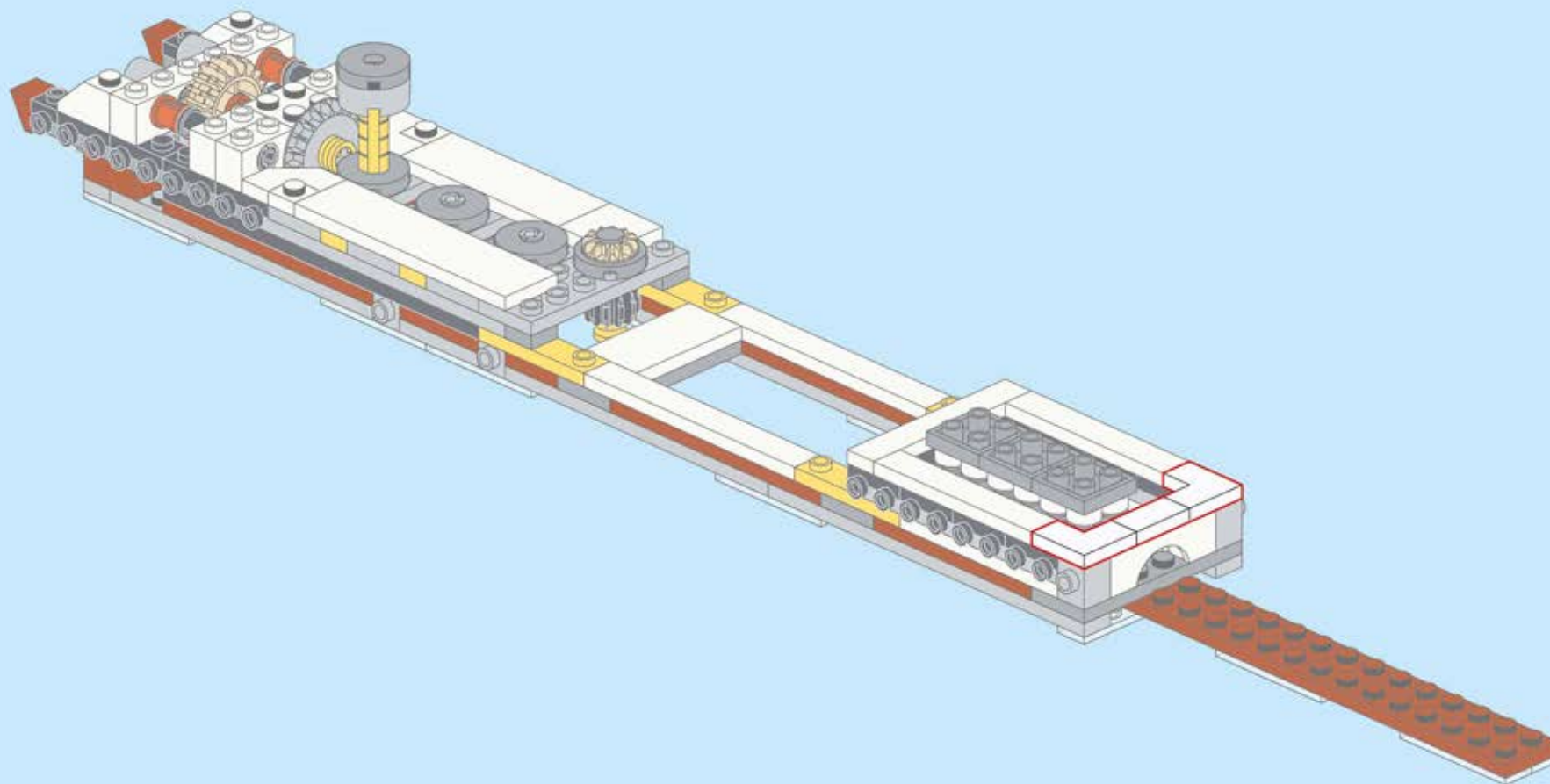



B32

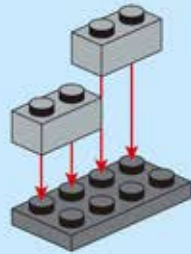
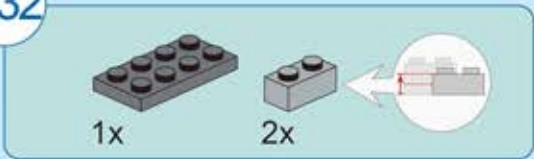

B33

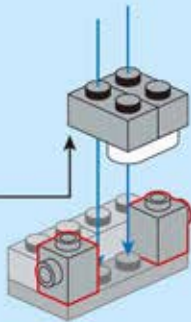
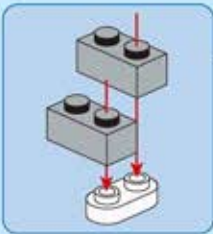
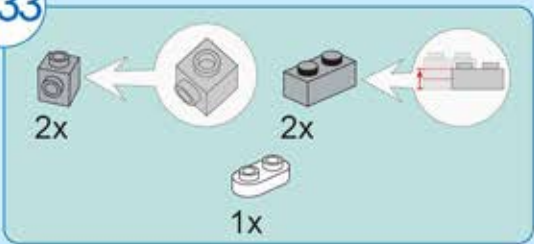

B34

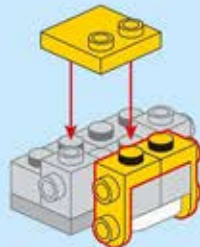
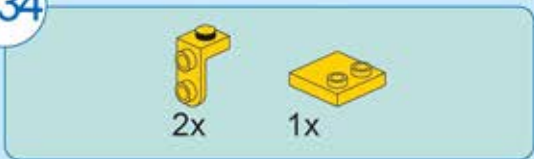

B35

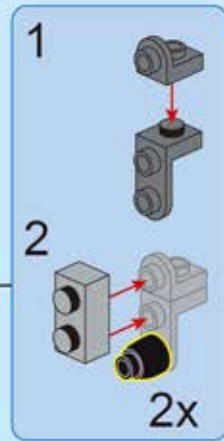
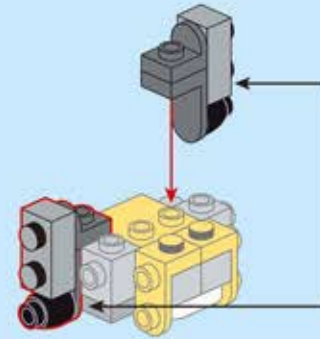

B36

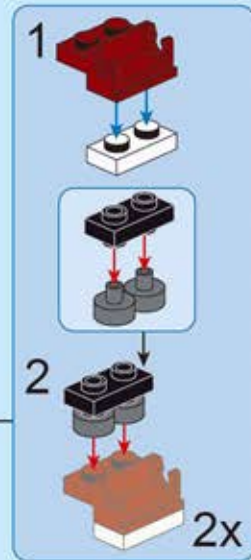
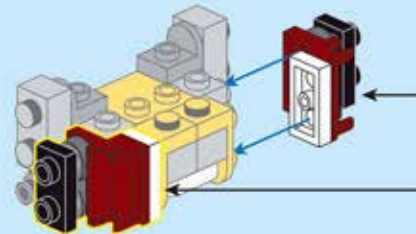

B37

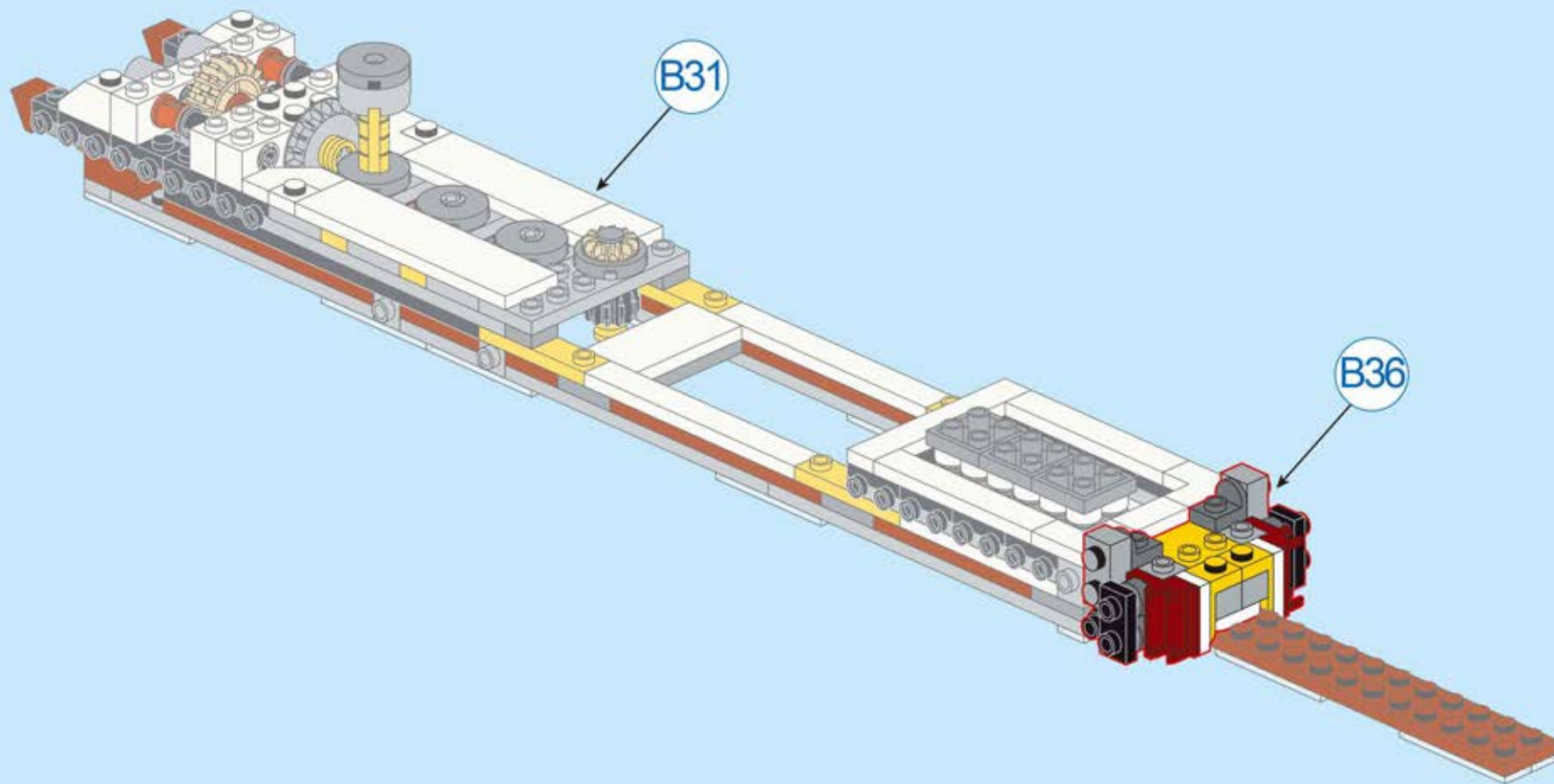

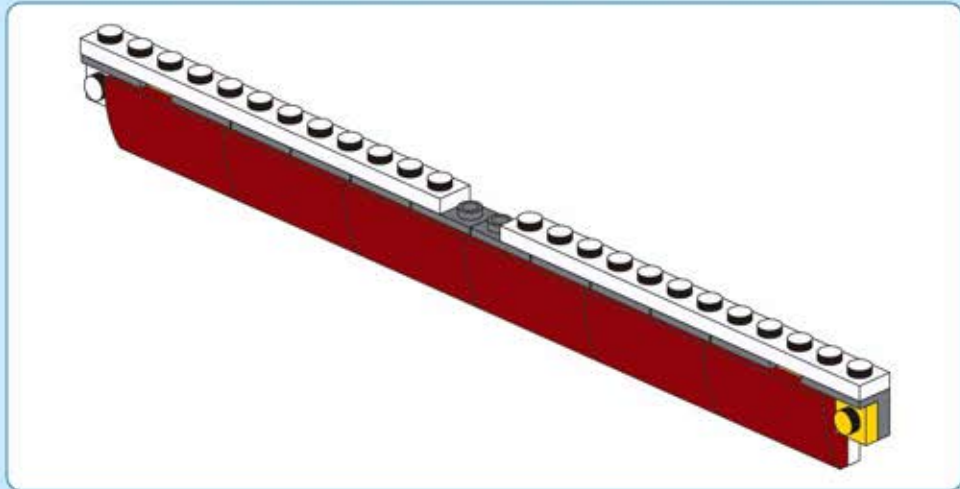
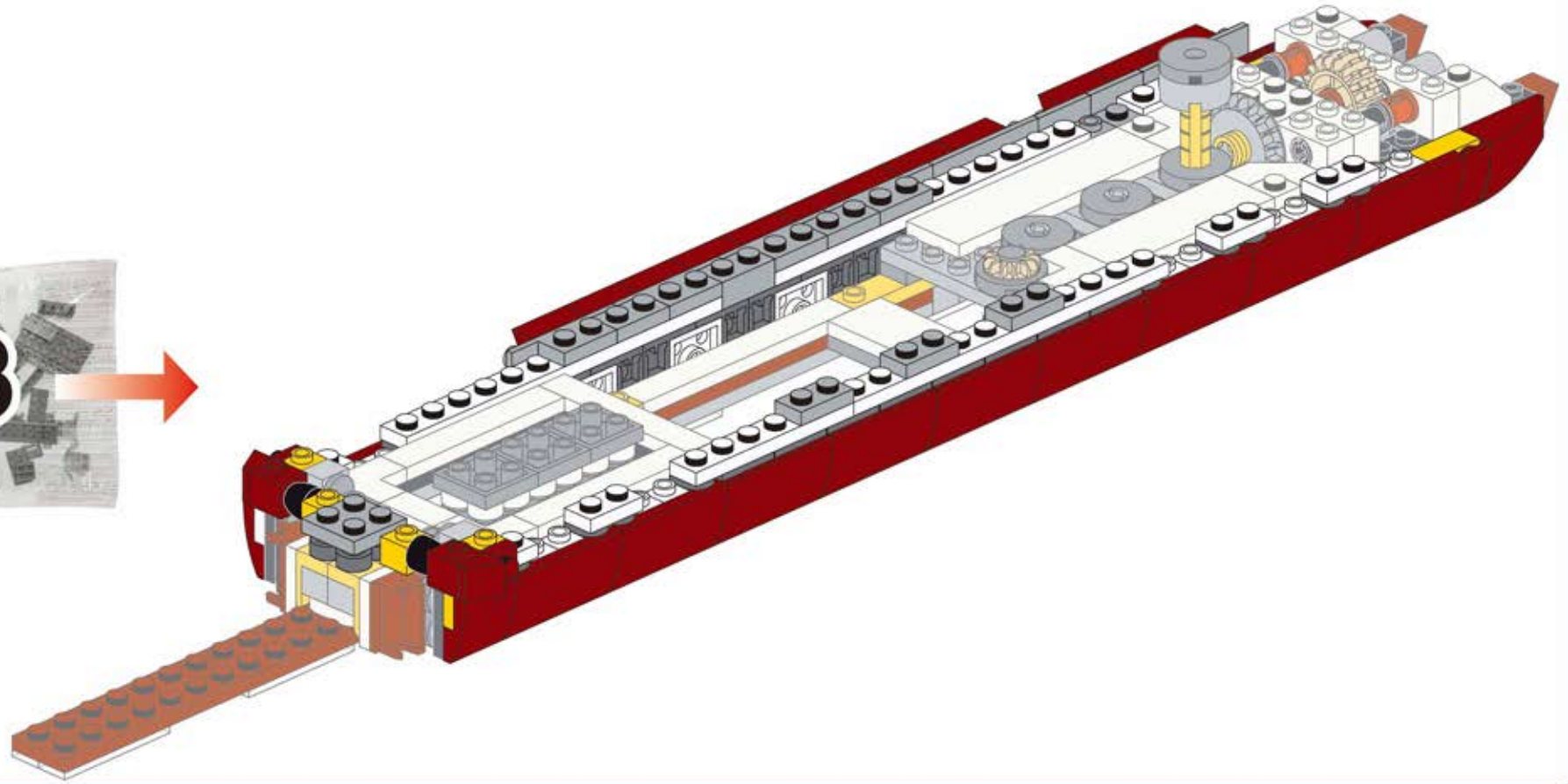

B38

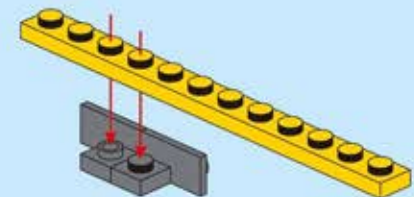
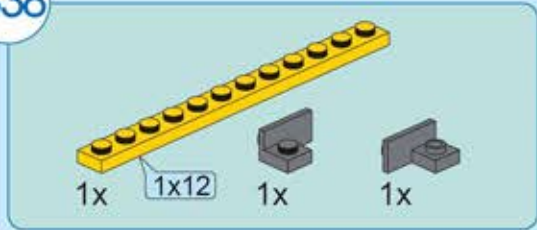

B39

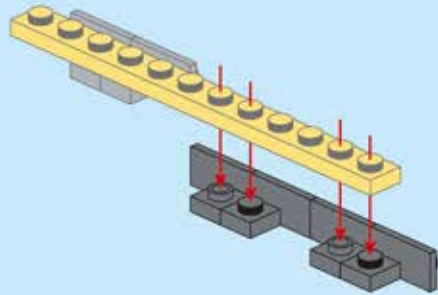
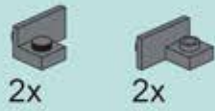

B40

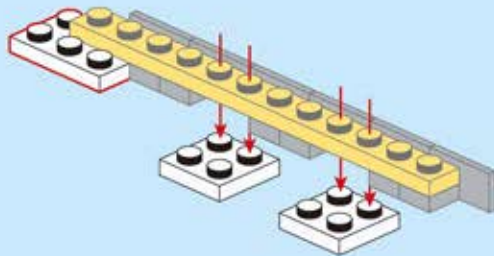

B41

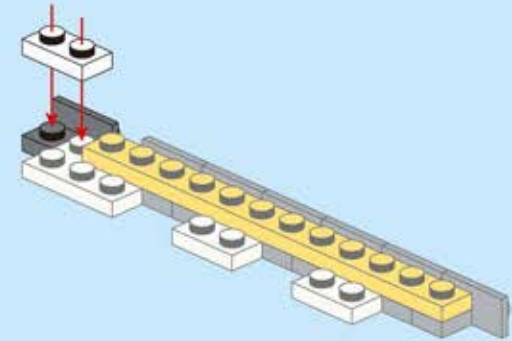

B42

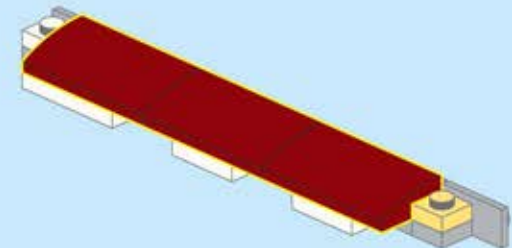
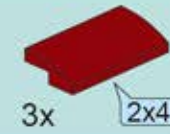

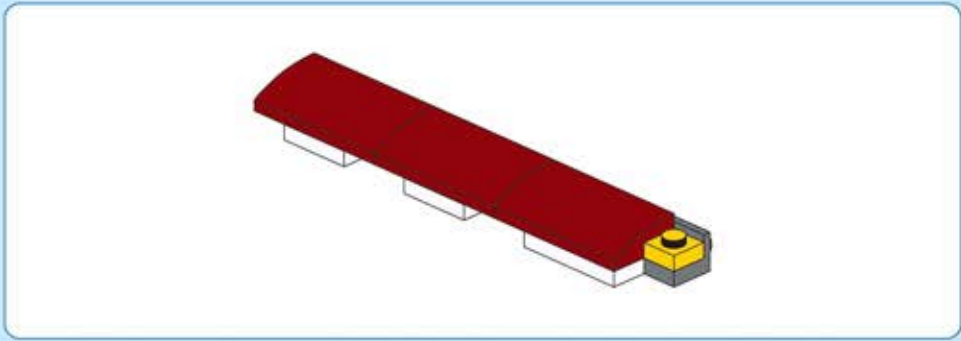

B43

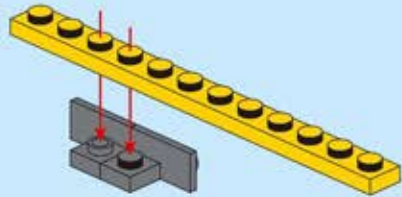
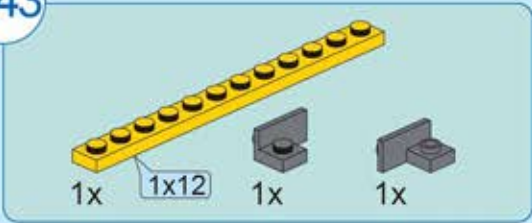

B44

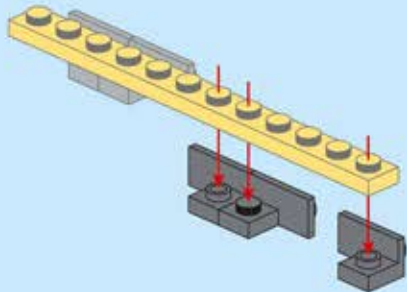
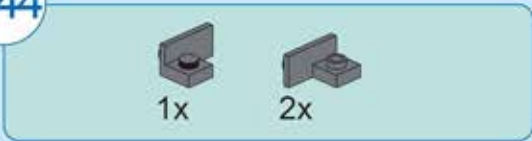

B45

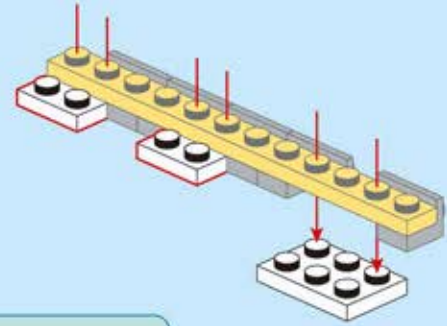

B46

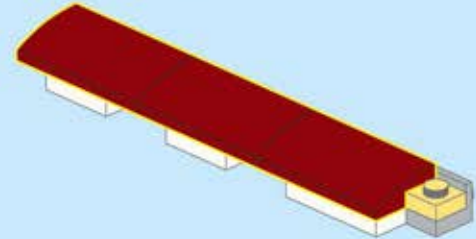
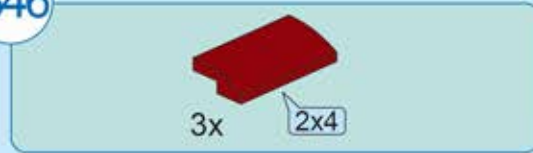

B47

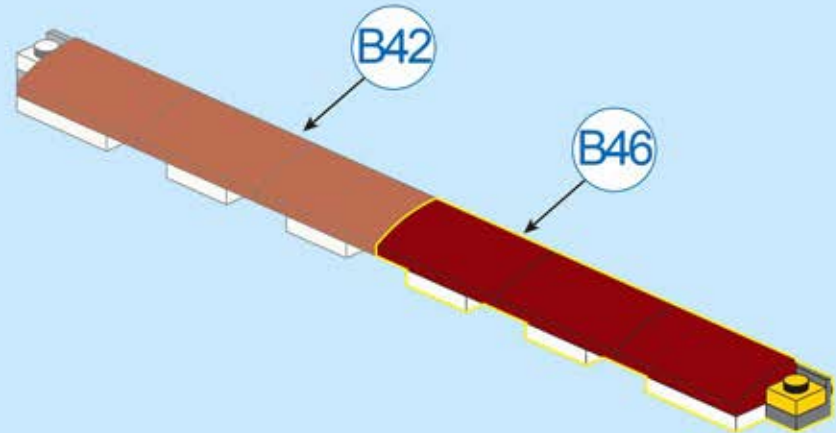

B48

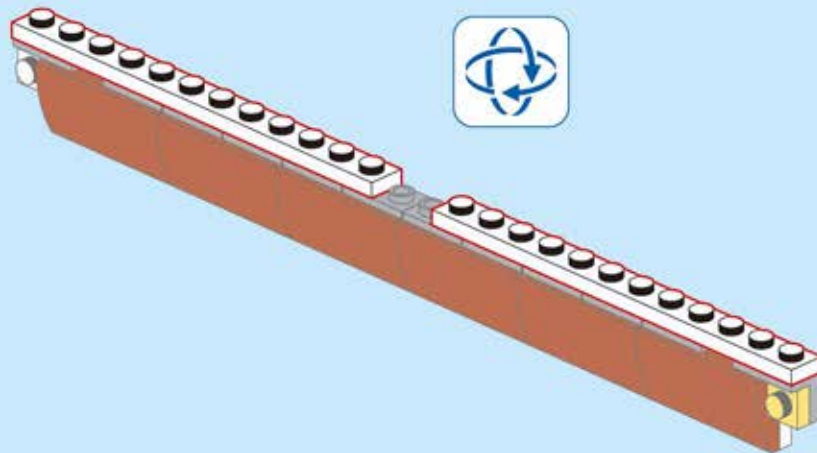
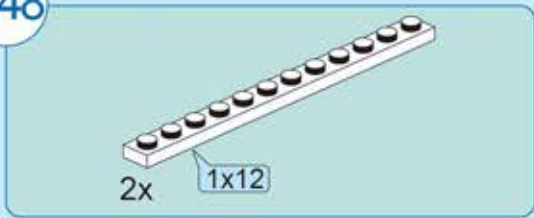

B49

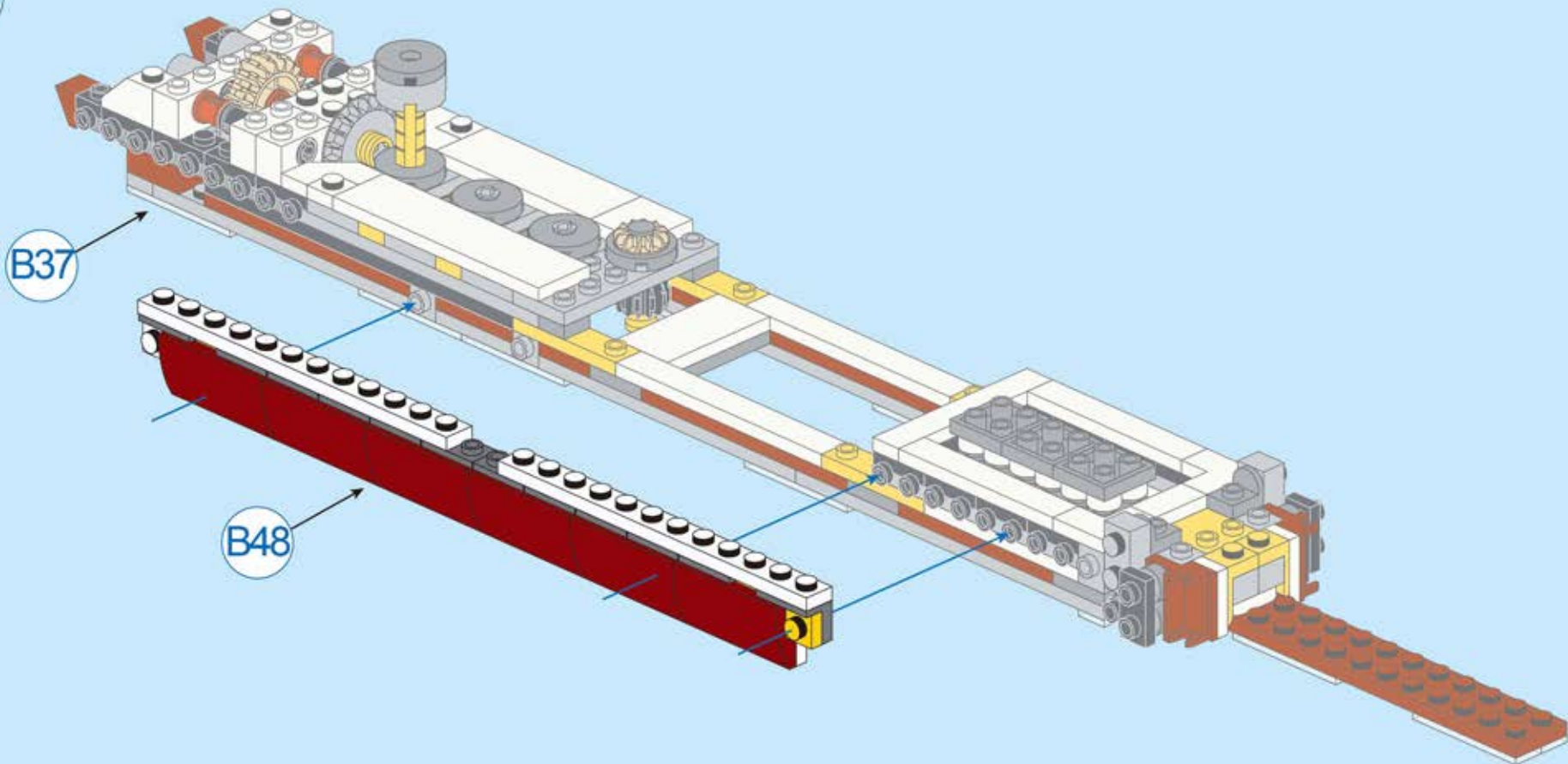

B50

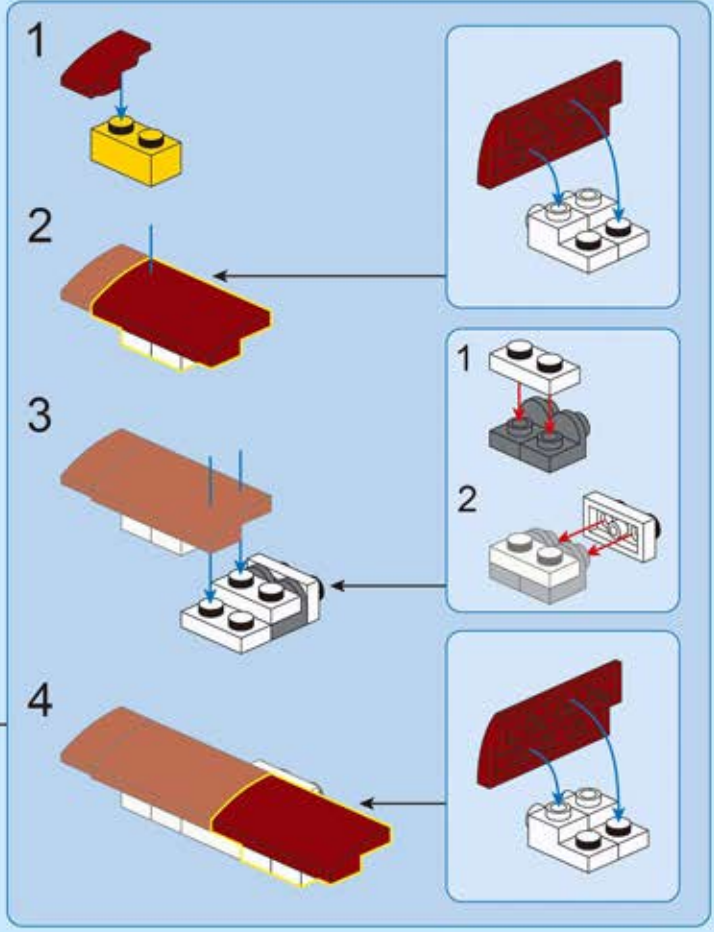
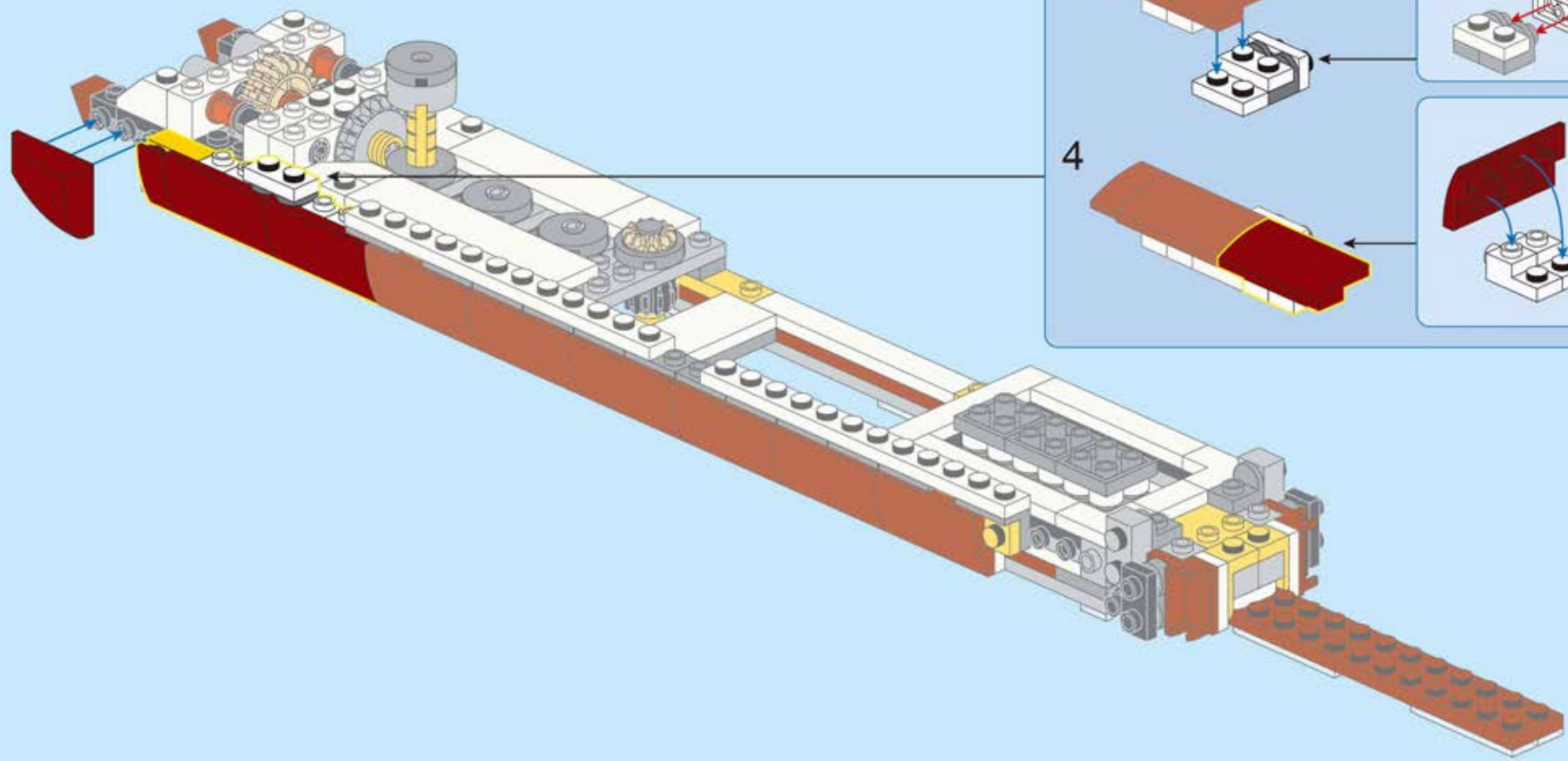
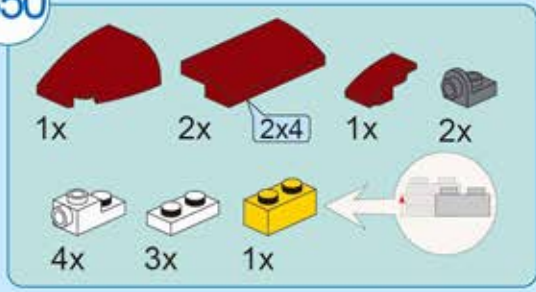

B51

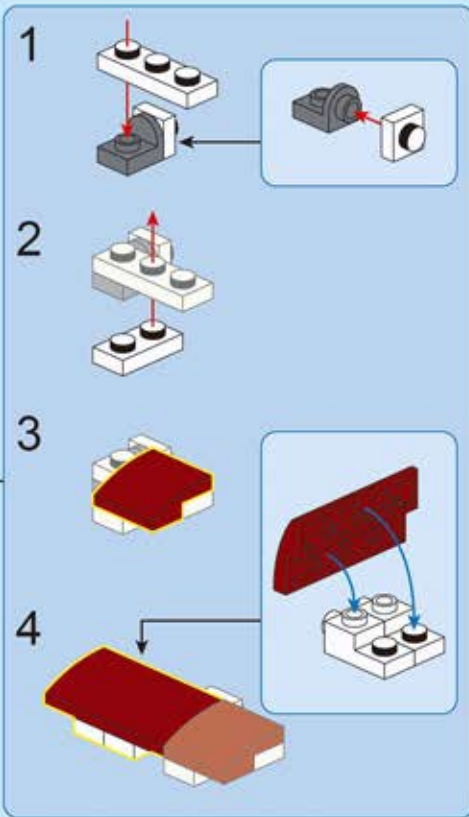
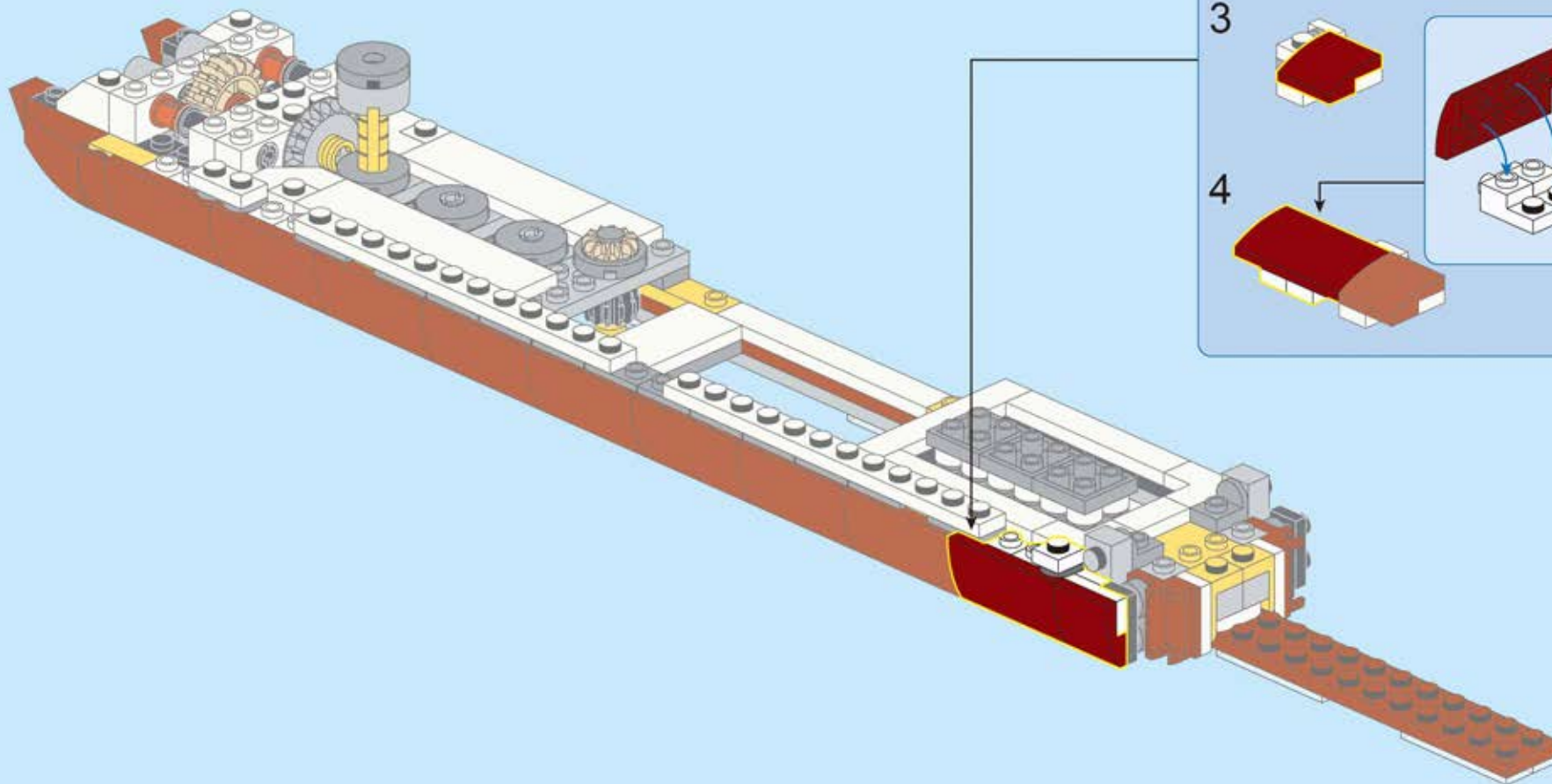
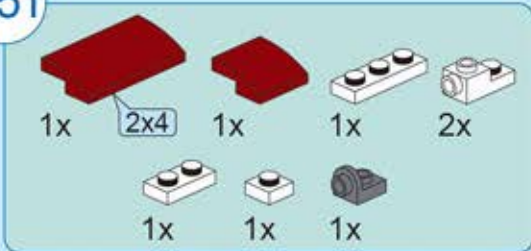

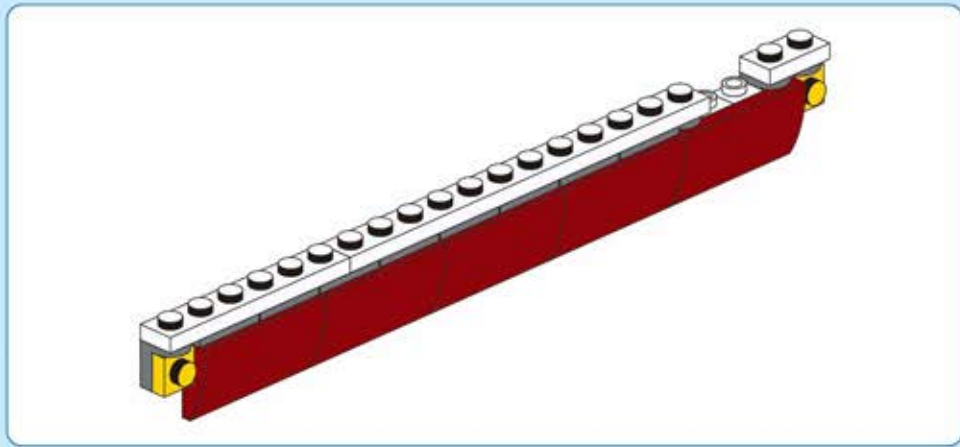

B52

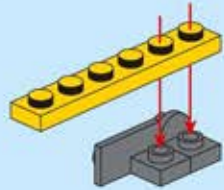
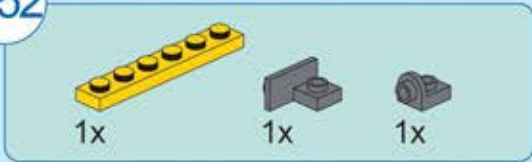

B53

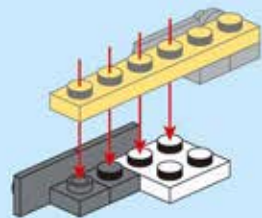

B54

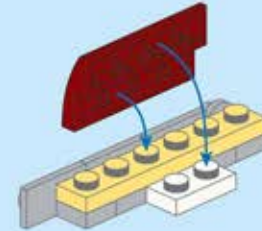
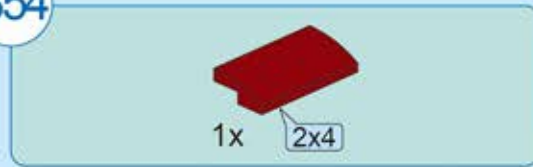

B55

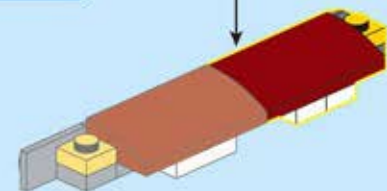
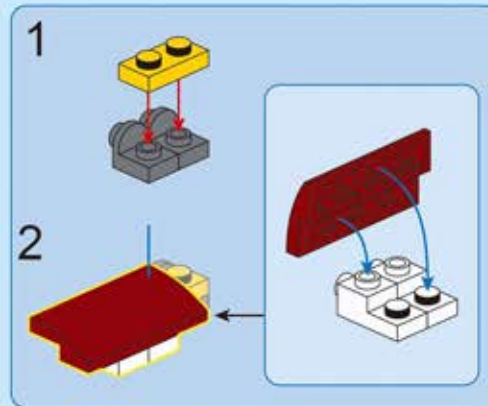

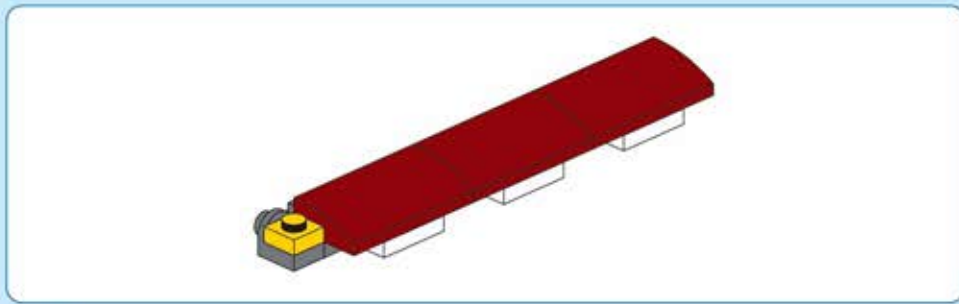

B56

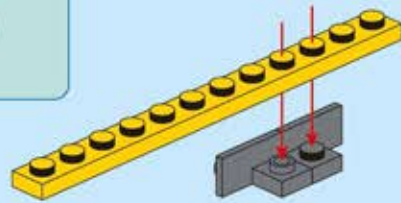
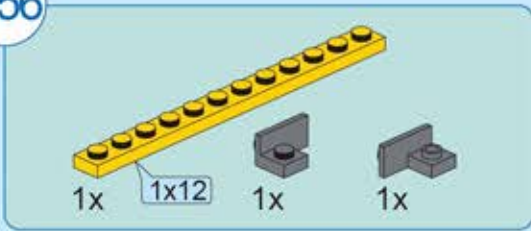

B57

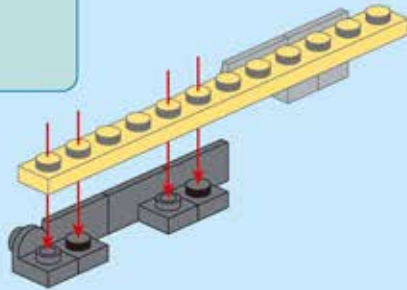
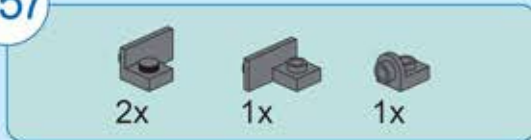

B58

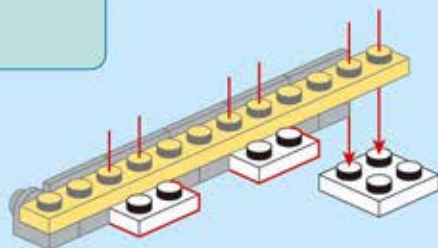

B59

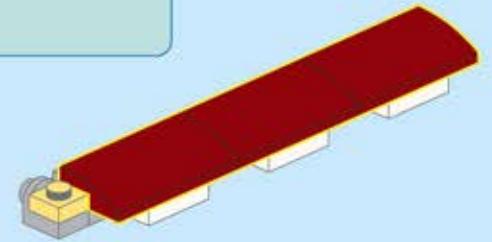
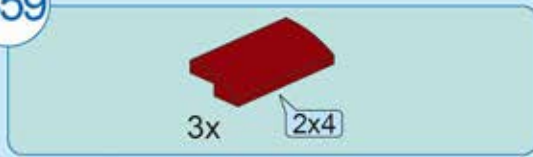

B60

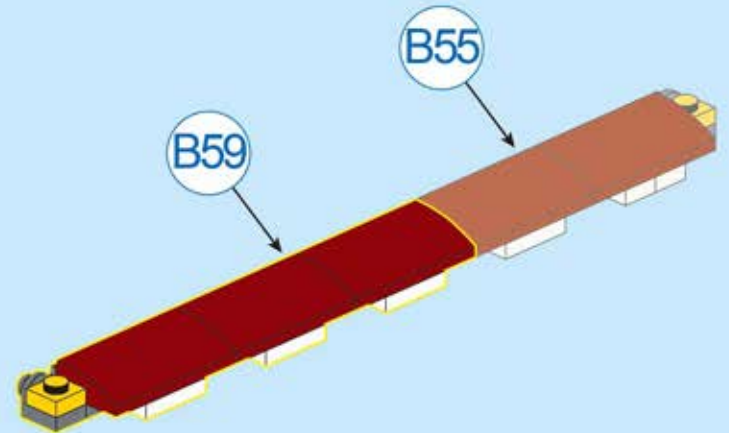

B61

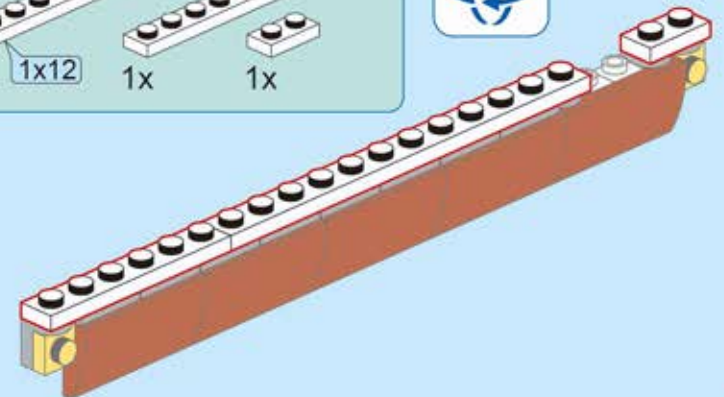
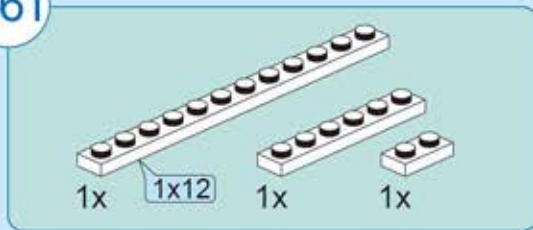

B62

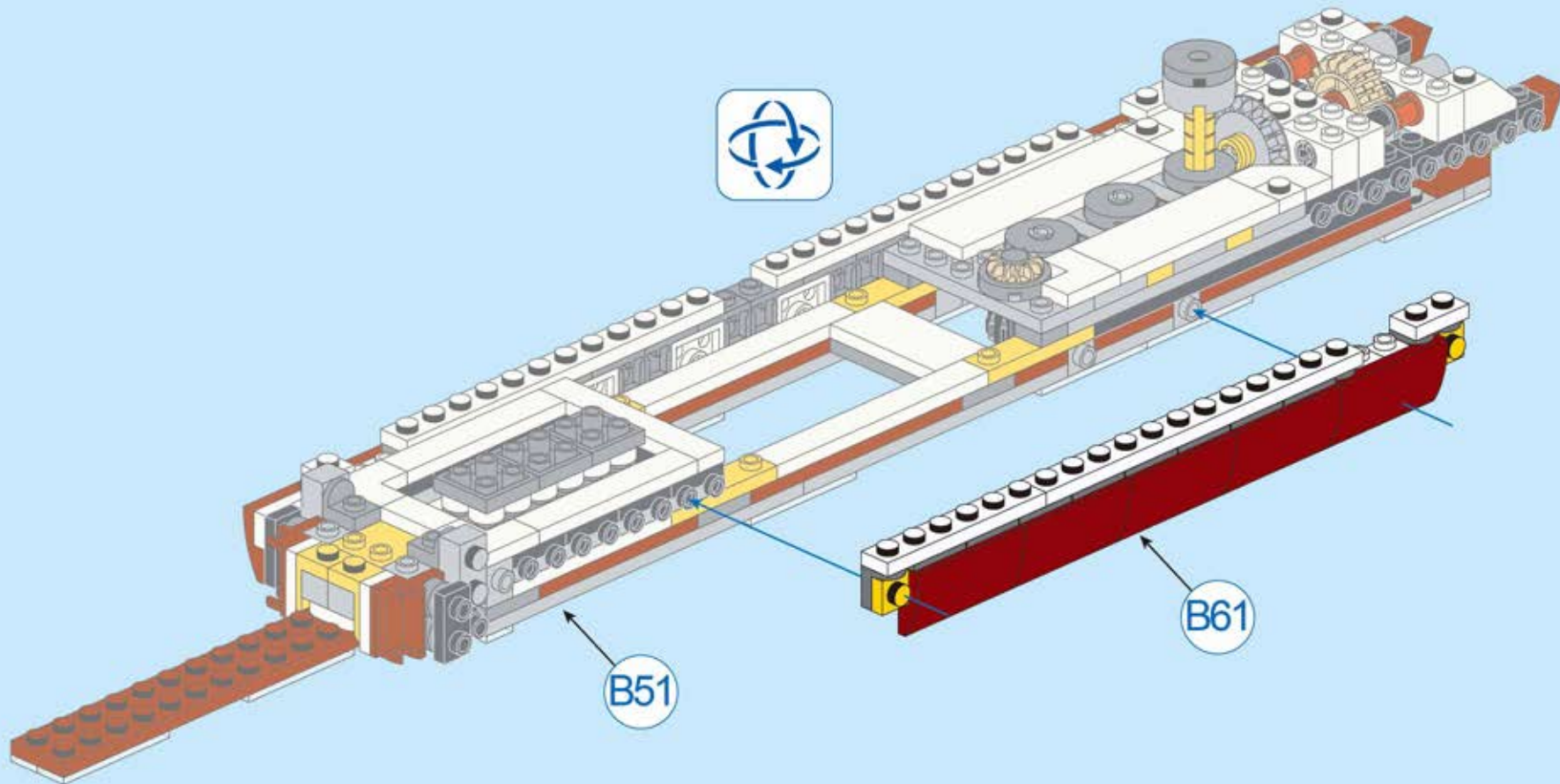

B63

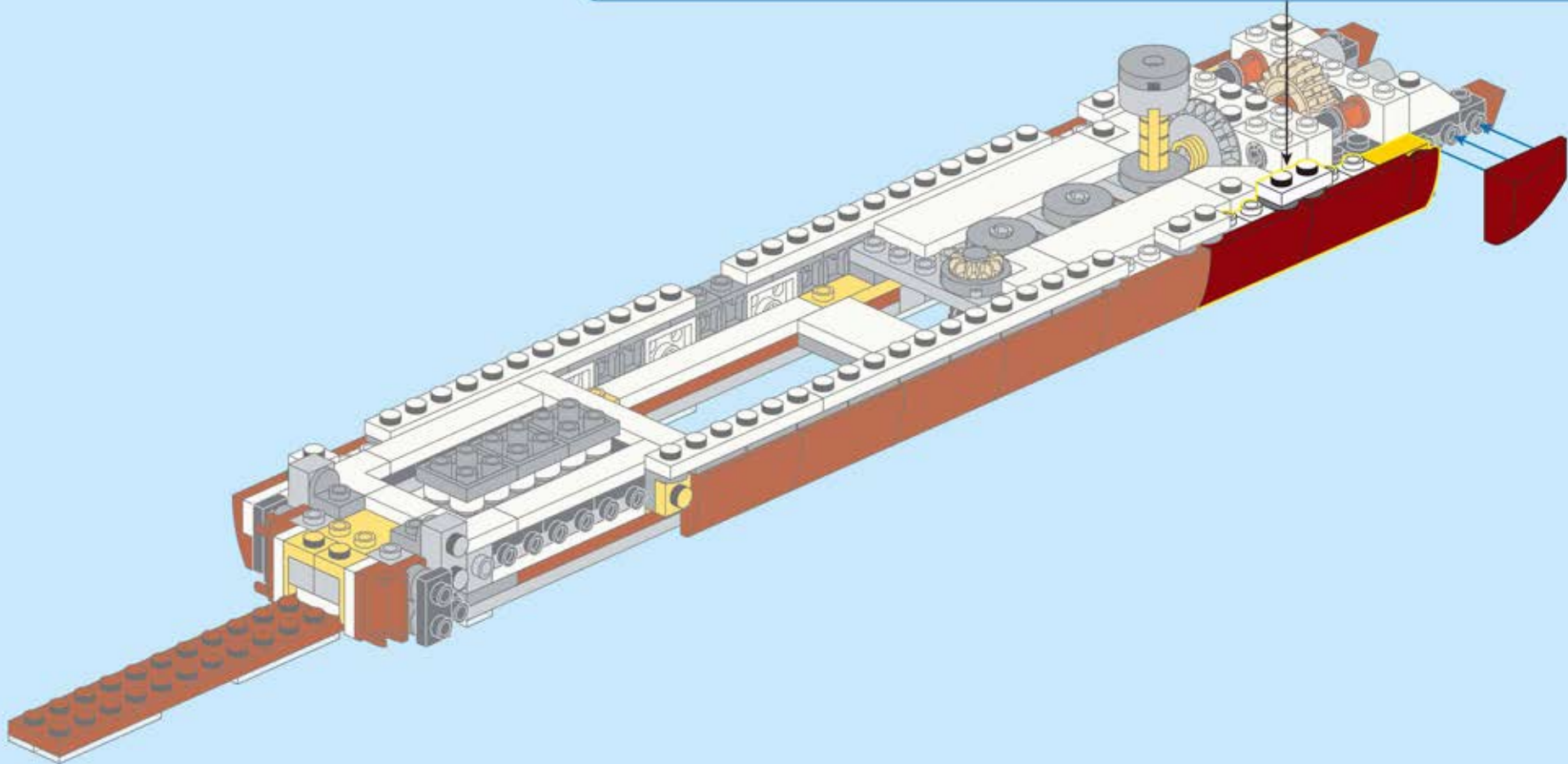
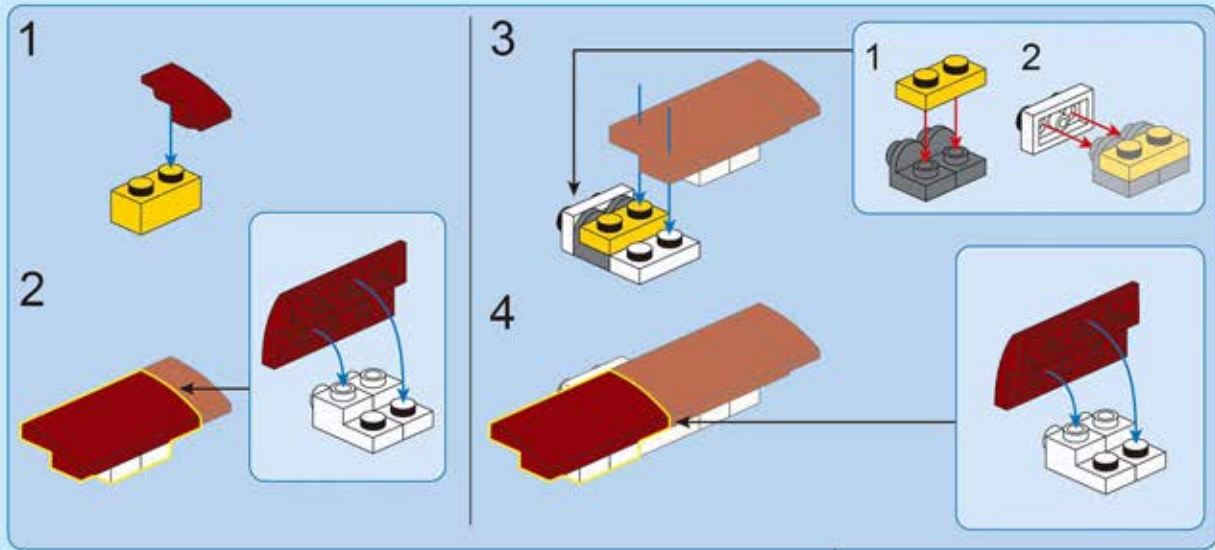
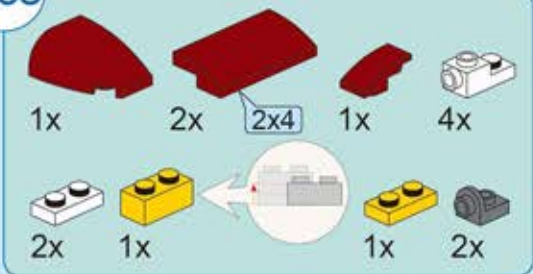

B64

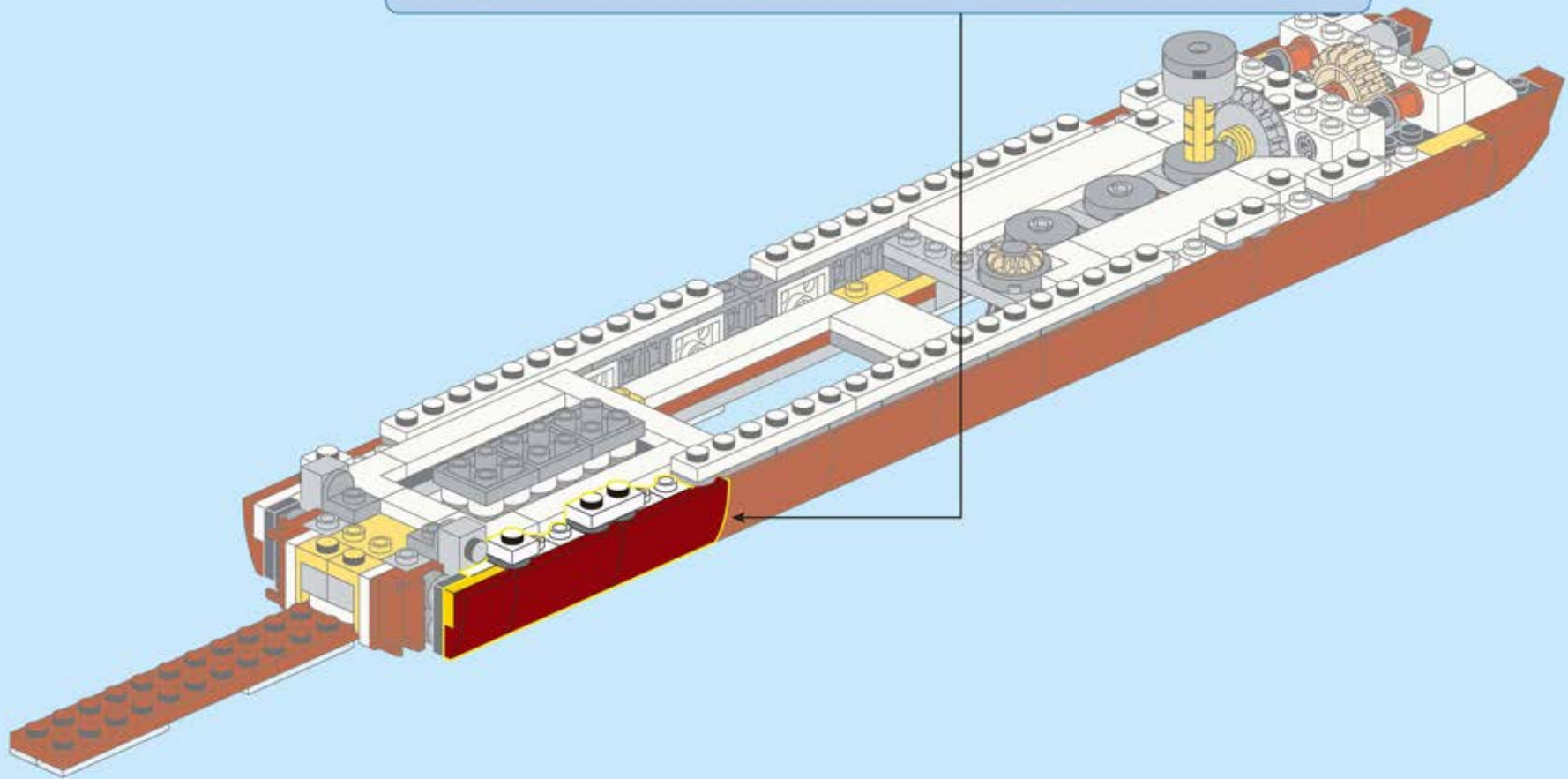
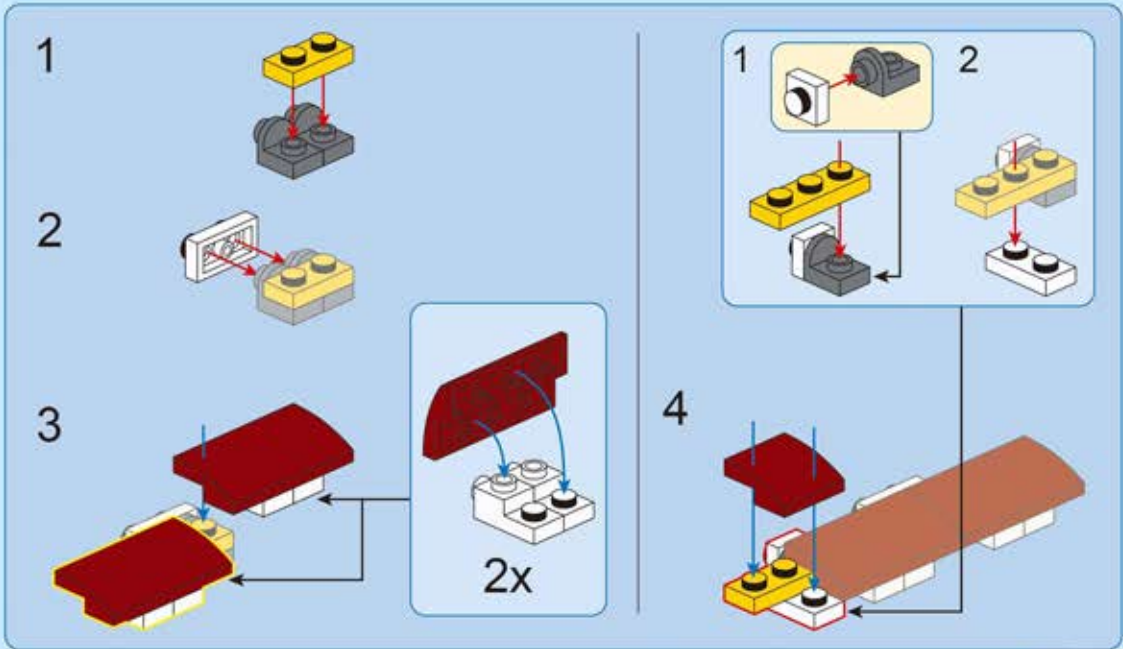
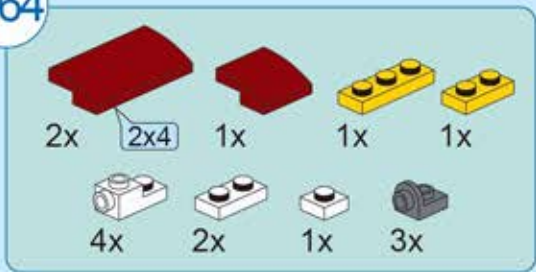

B65

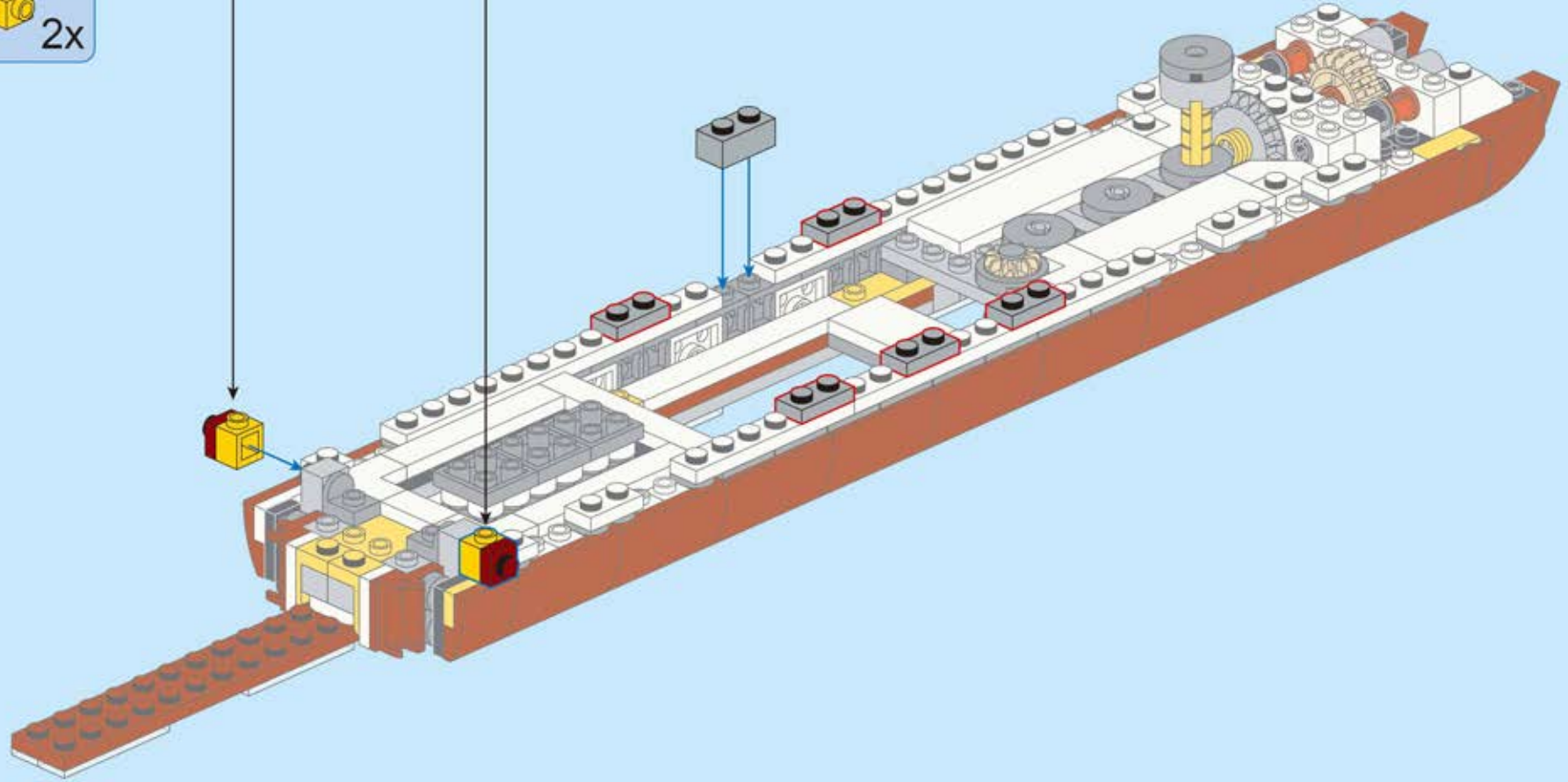
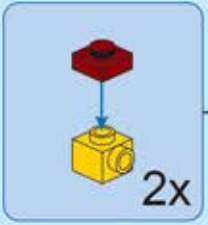
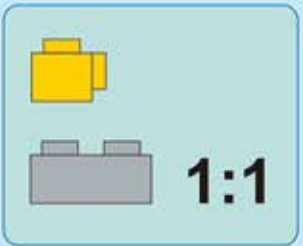
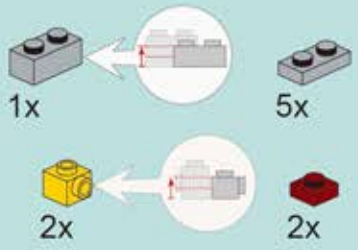

B66

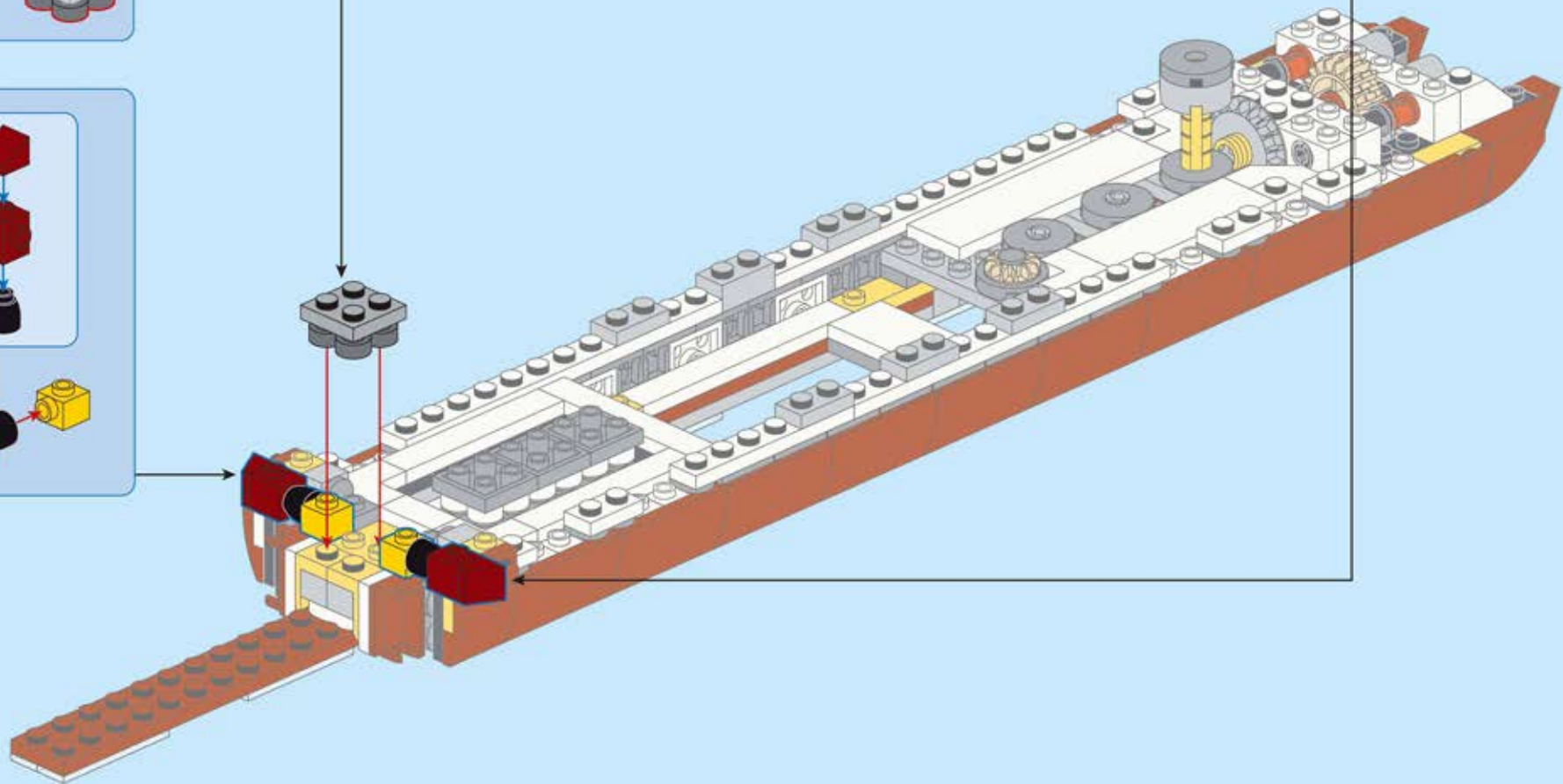
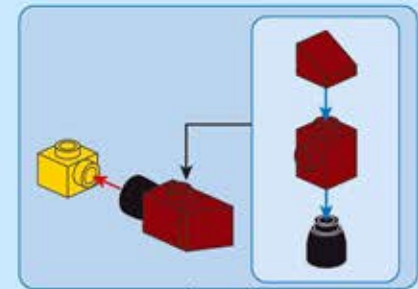
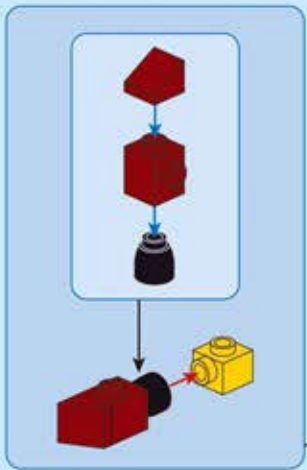
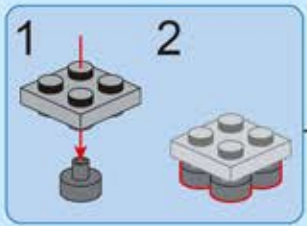
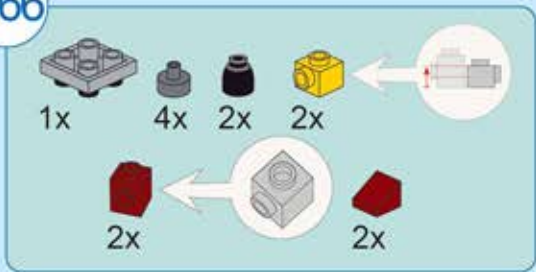

B67



2x



2x



3x

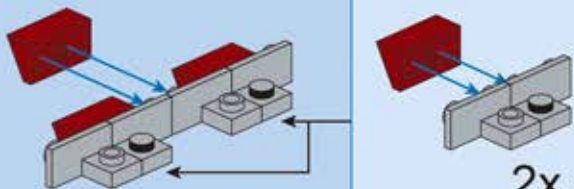

2x



B68



4x



1x



9x

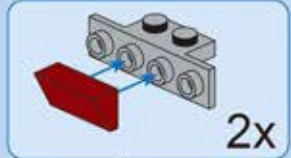
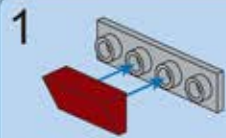

2x

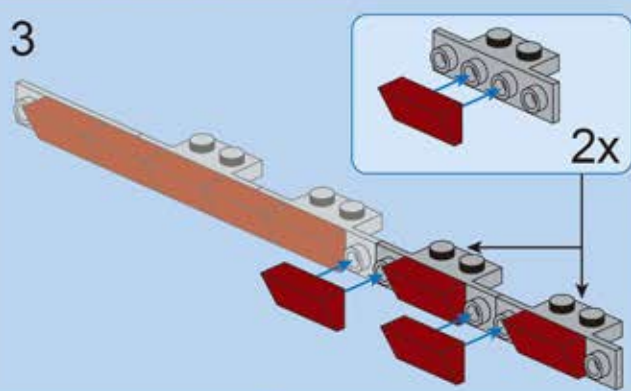
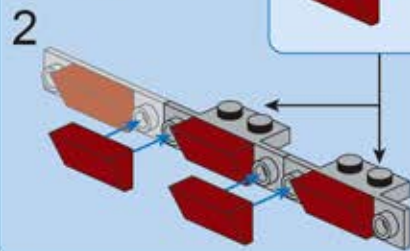

2x

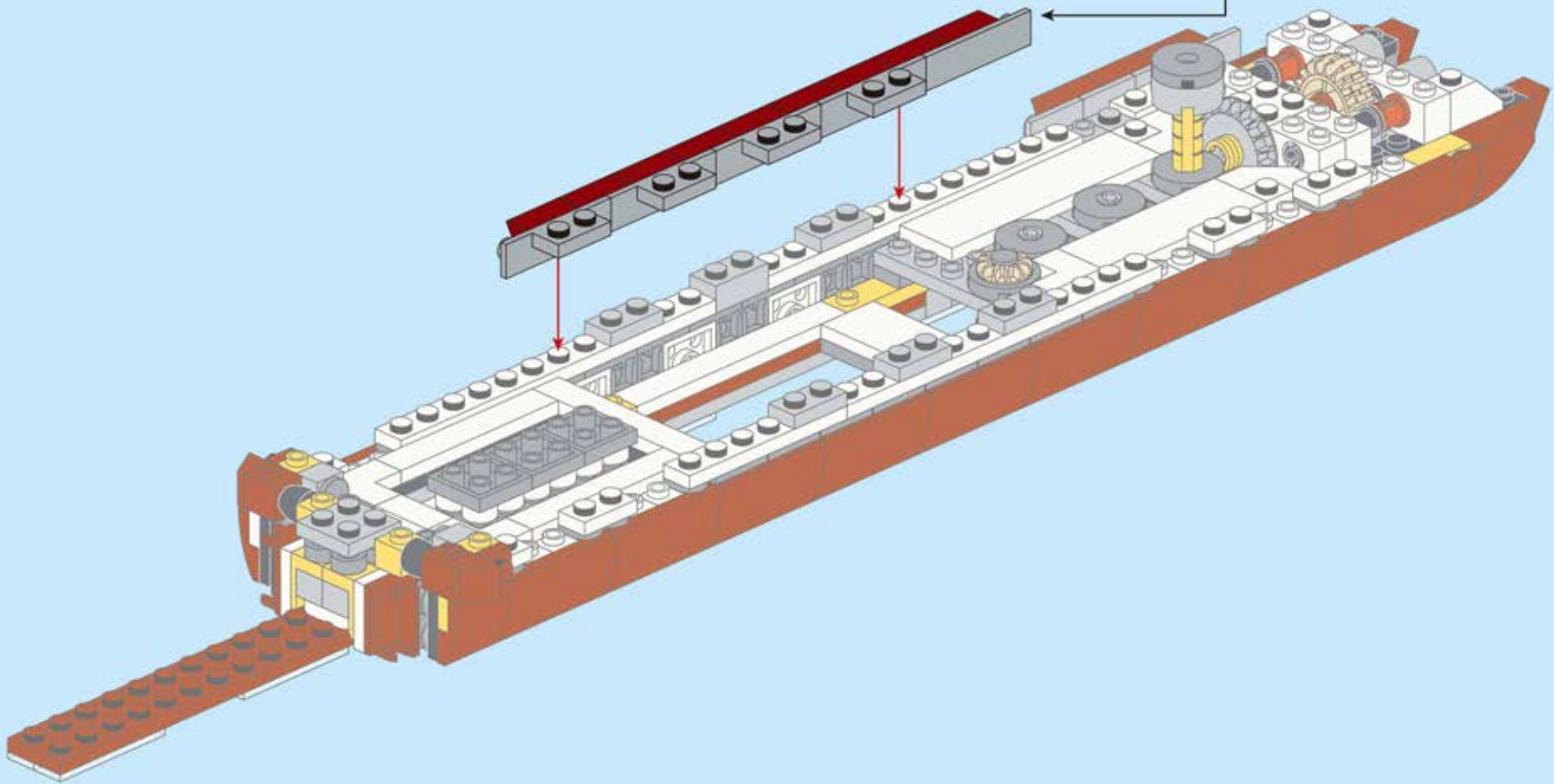

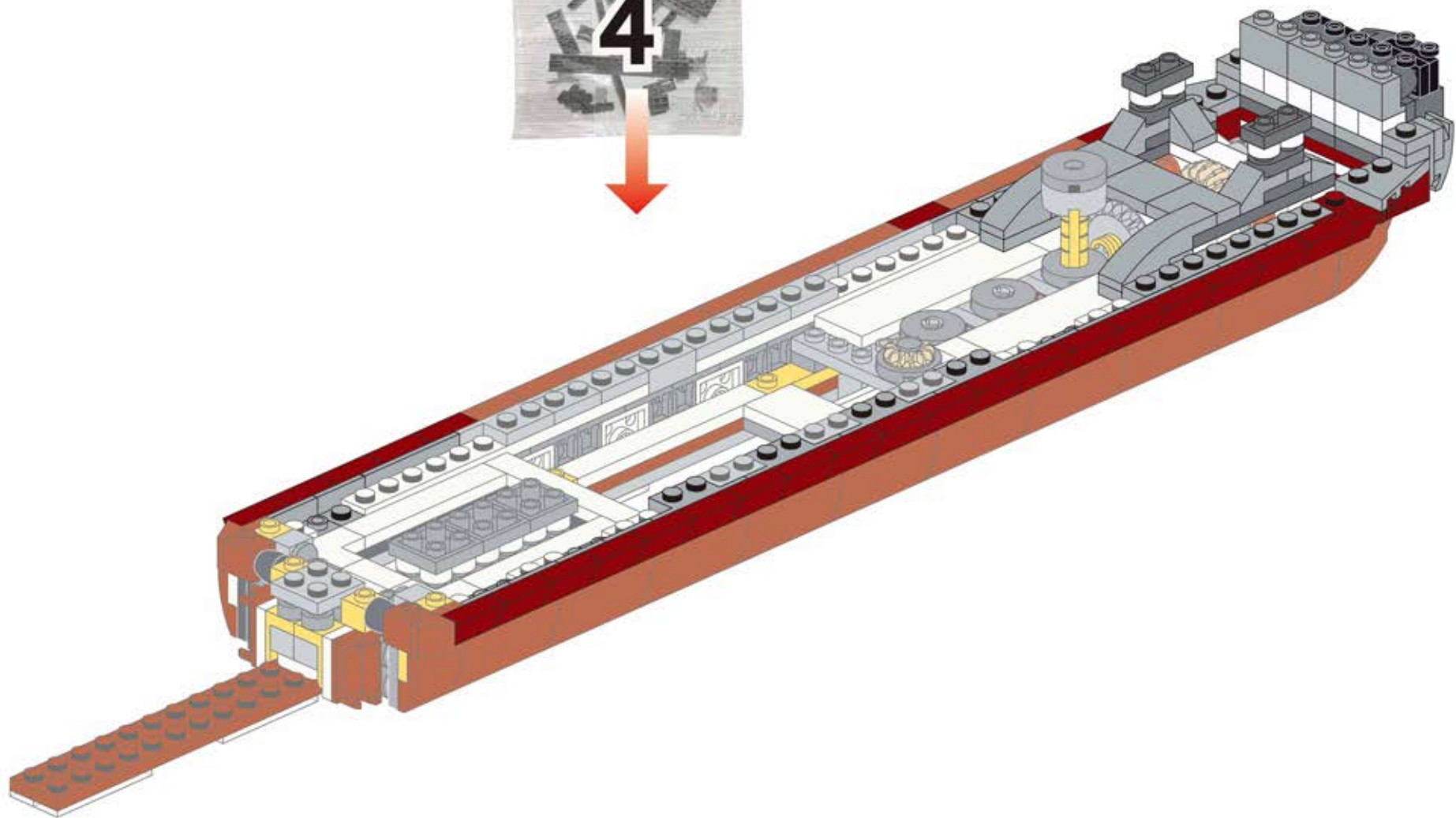

B69



1x



1x



1x



3x

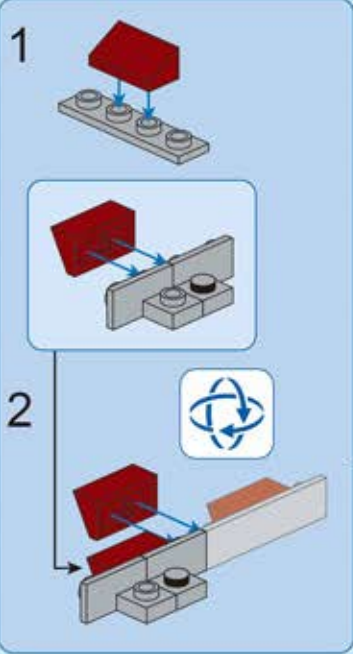

B70



3x



3x



5x

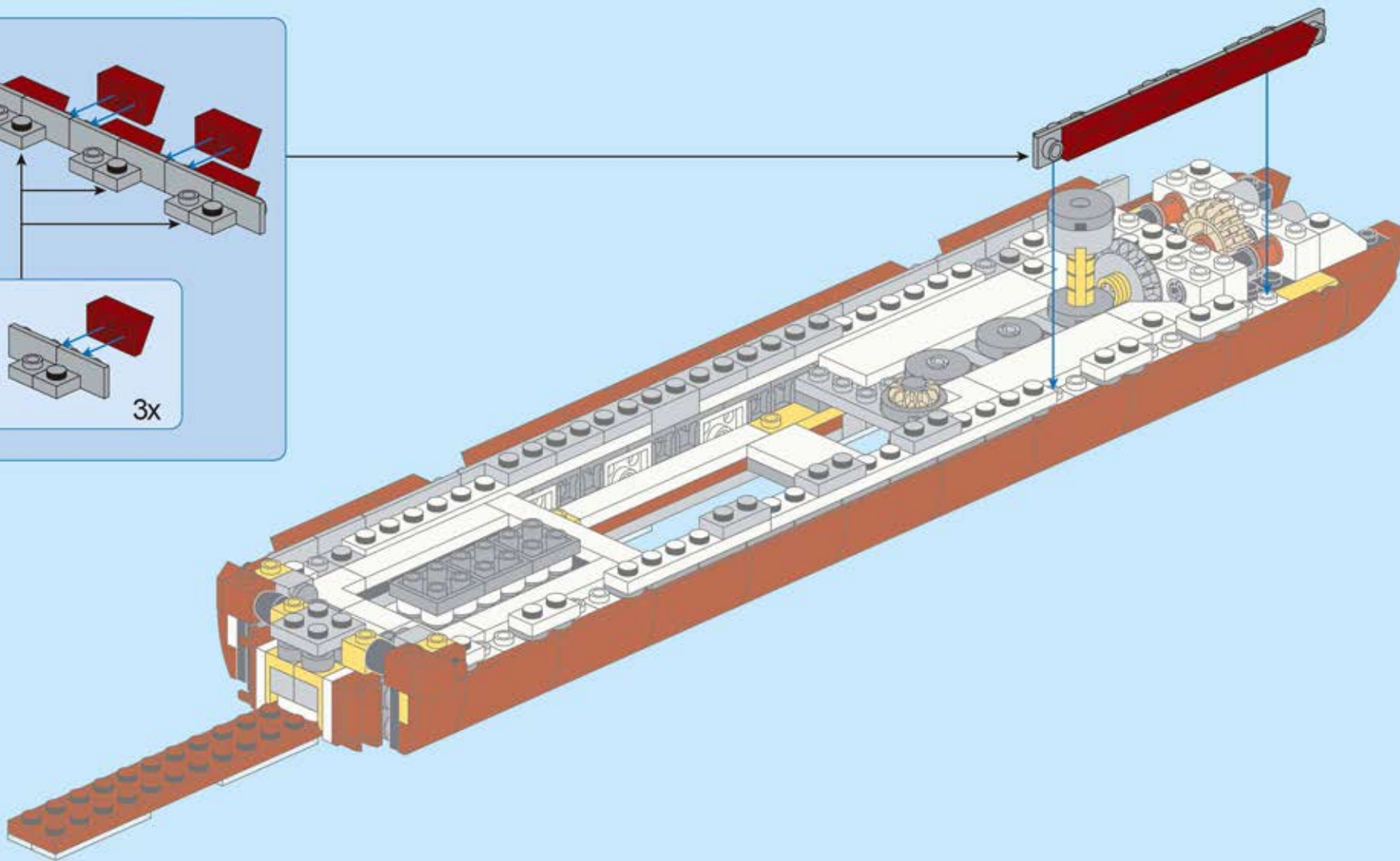
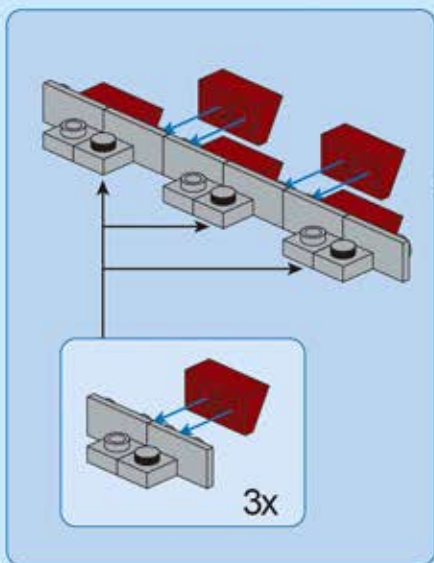

B71

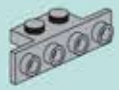

4x



7x

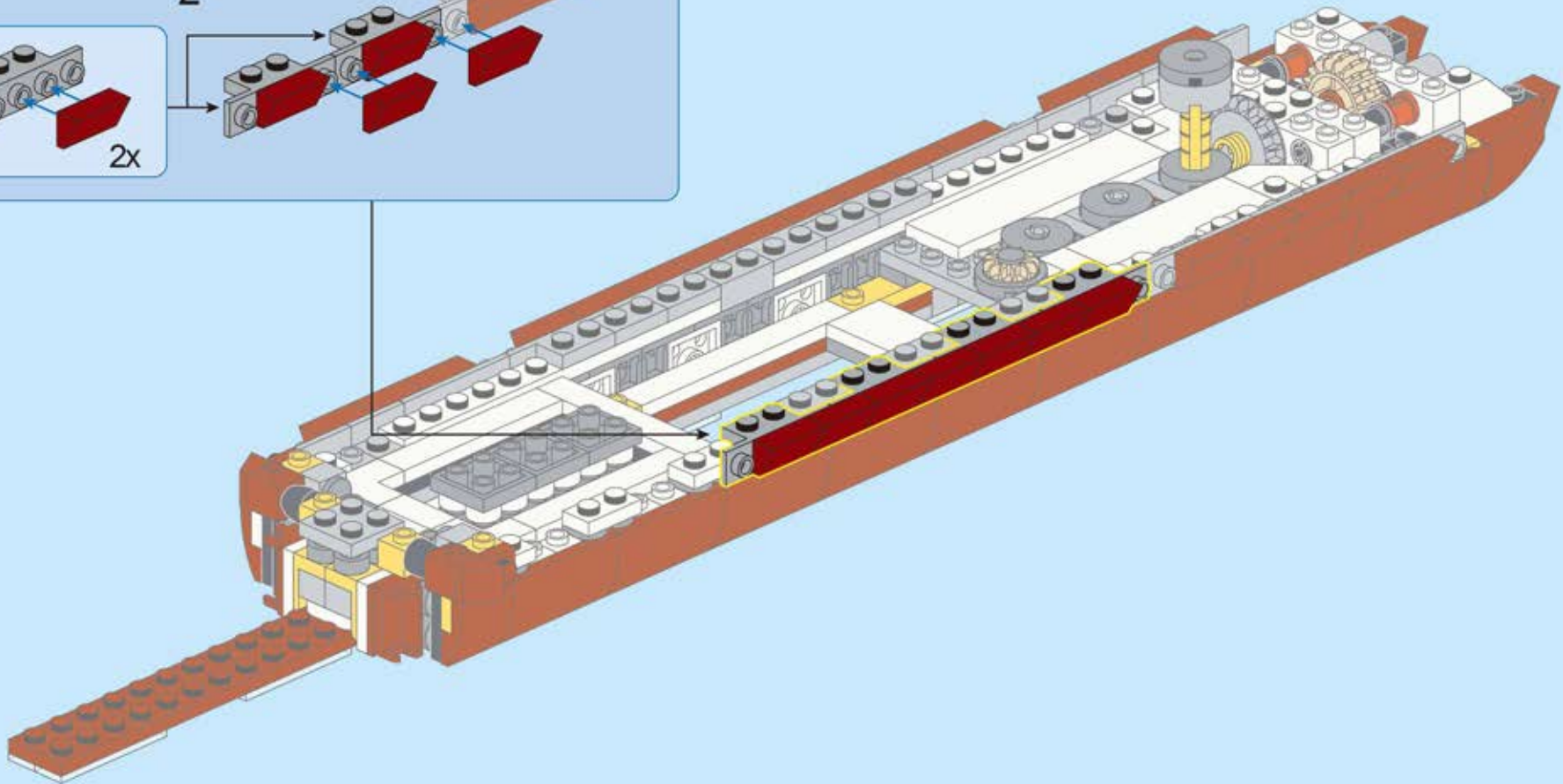
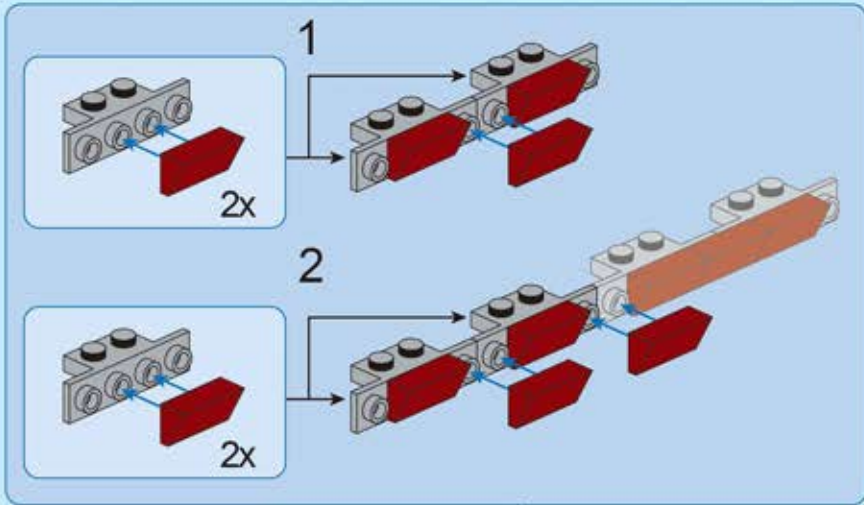

B72

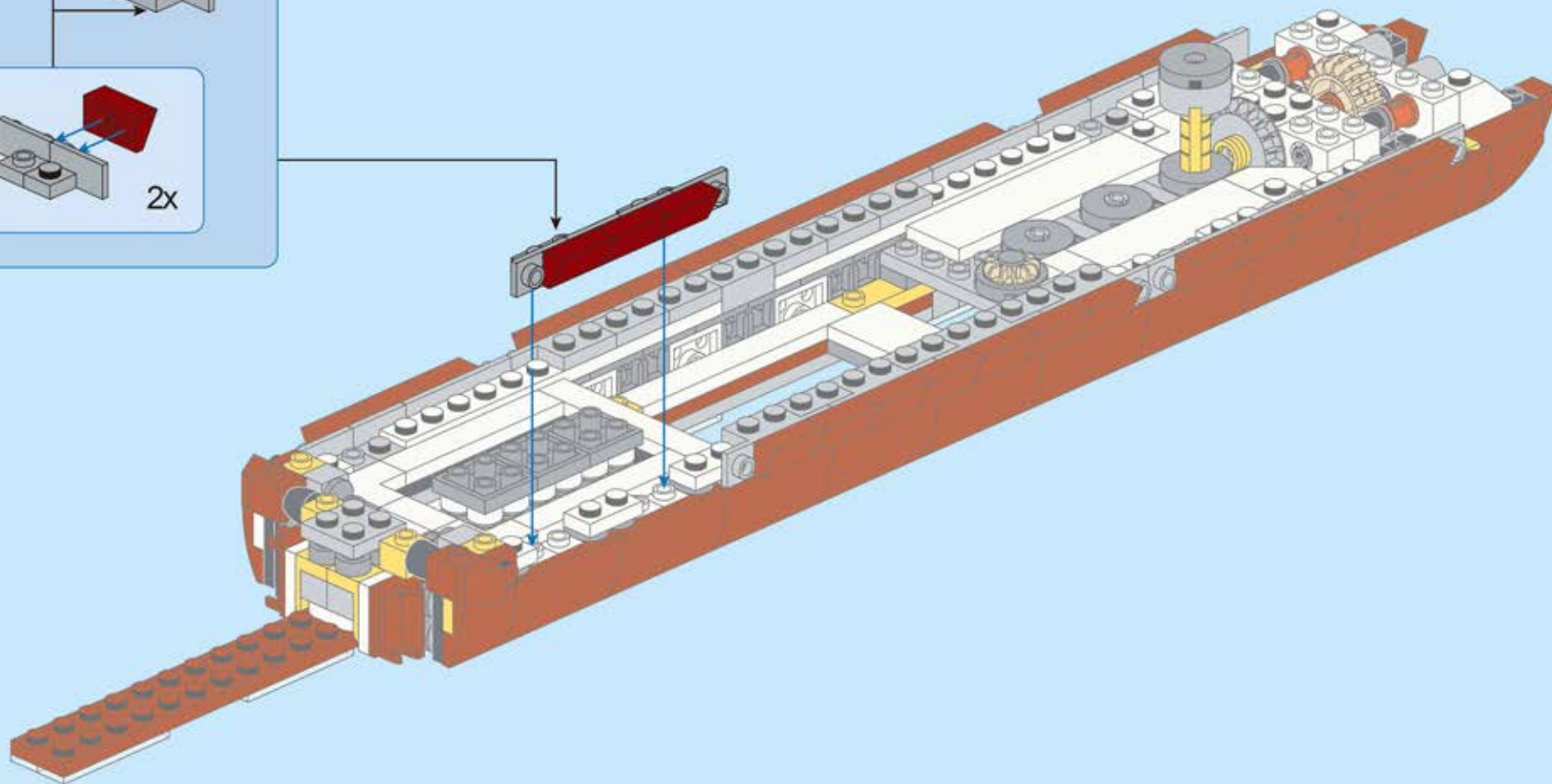
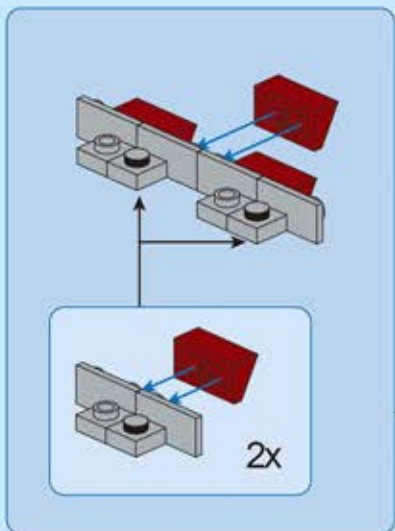

B73



6x

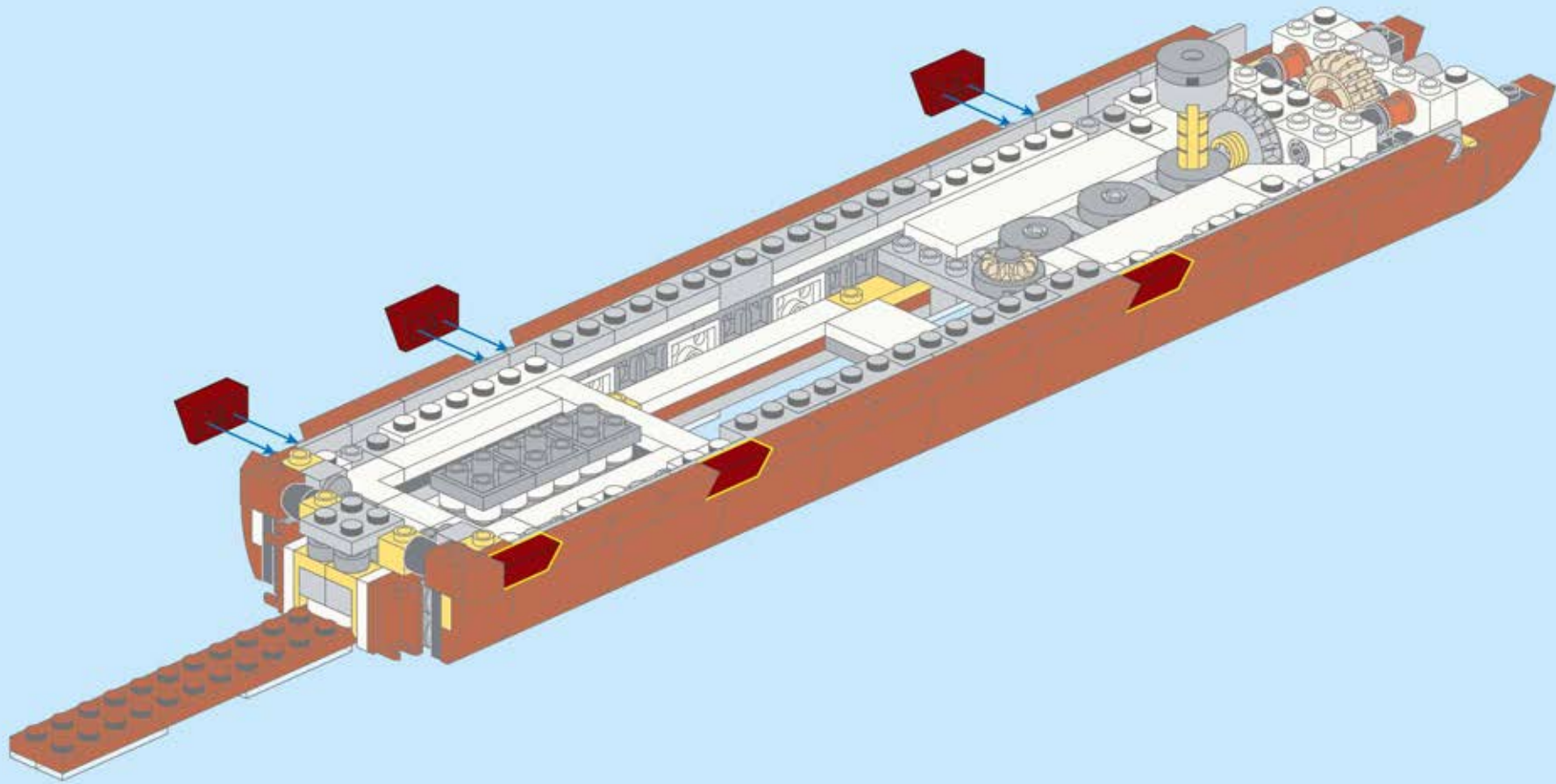

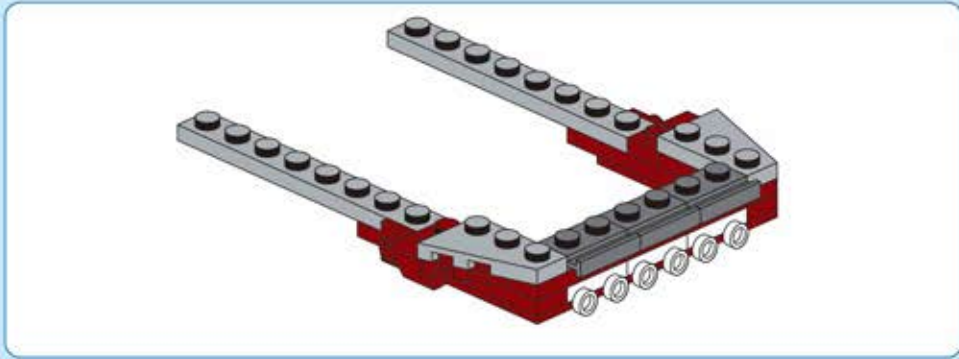

B74

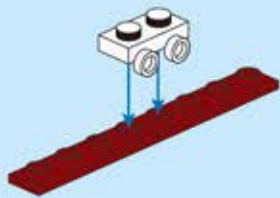
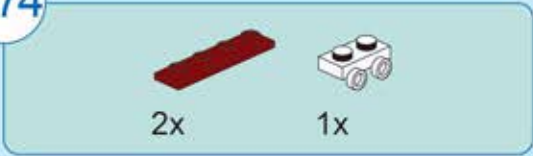

B75

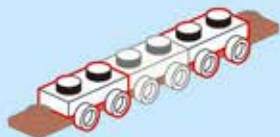

B76

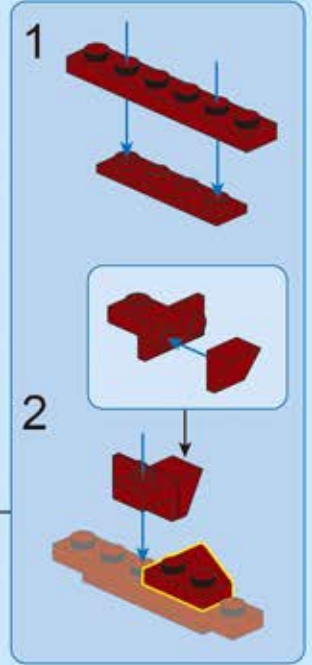
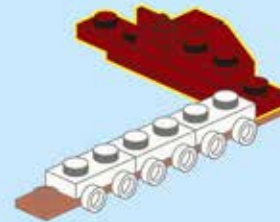
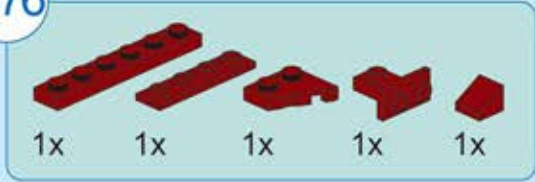

B77

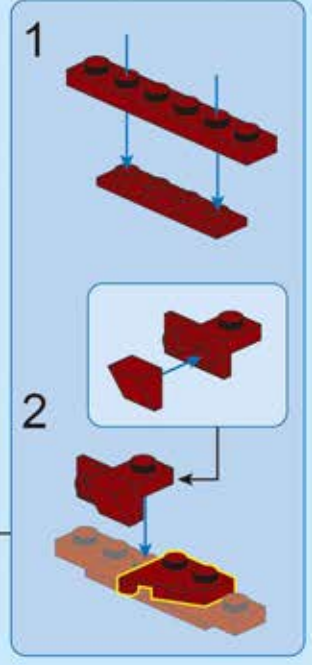
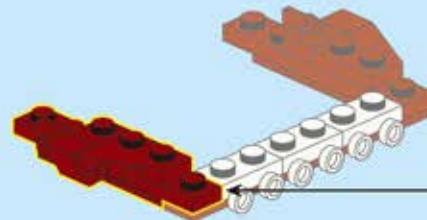

B78

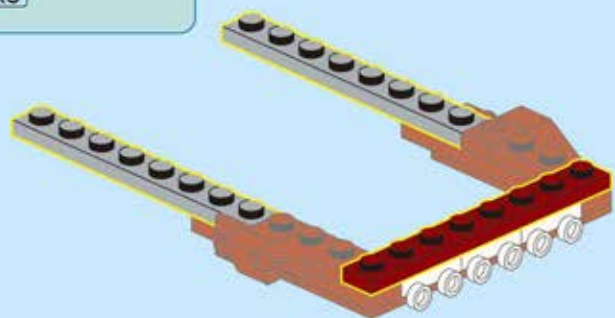
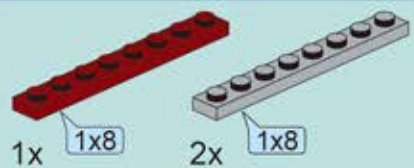

B79

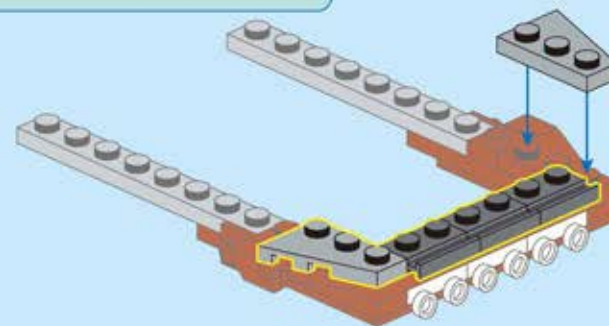
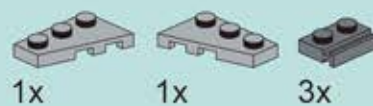

B80

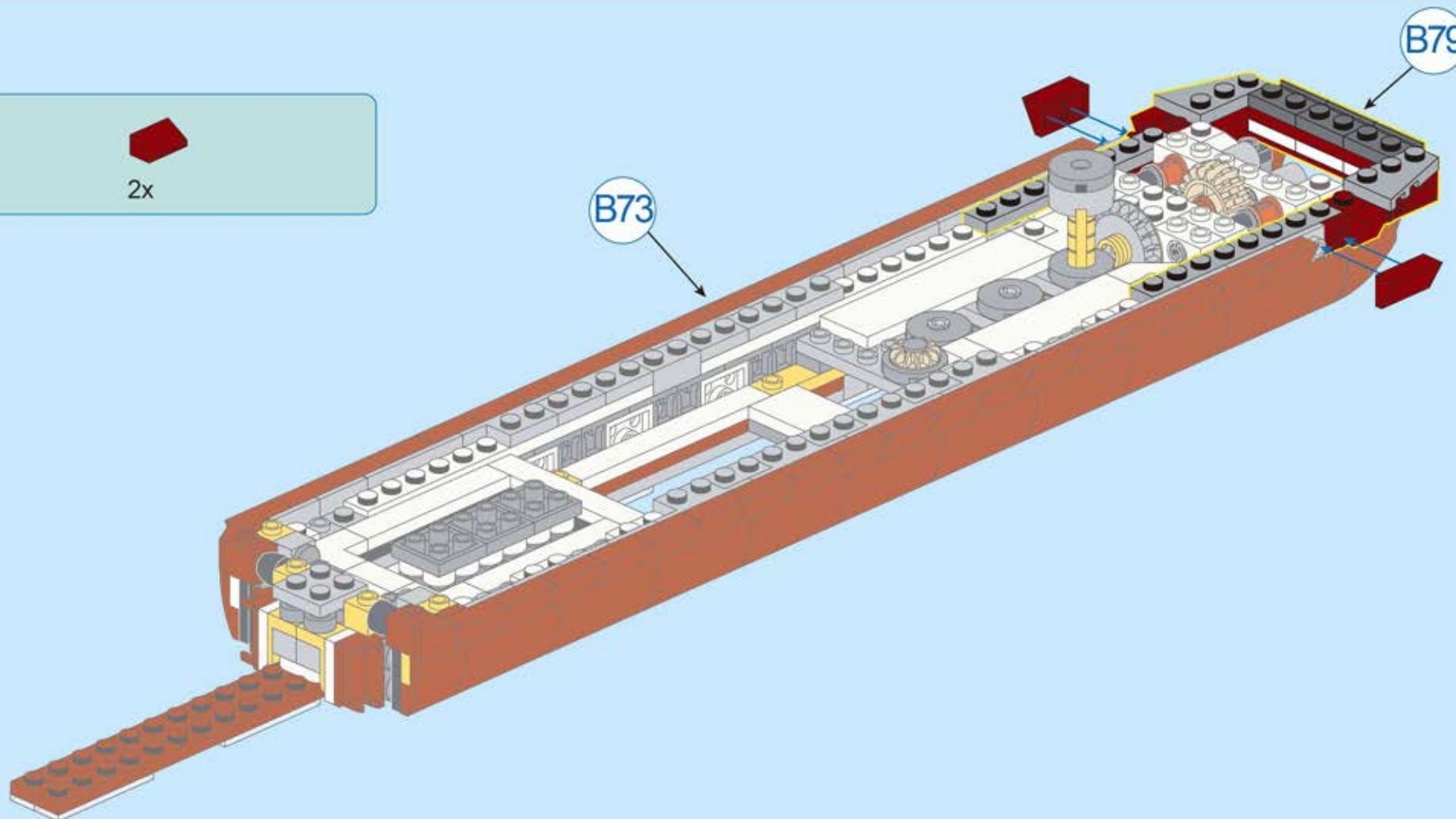

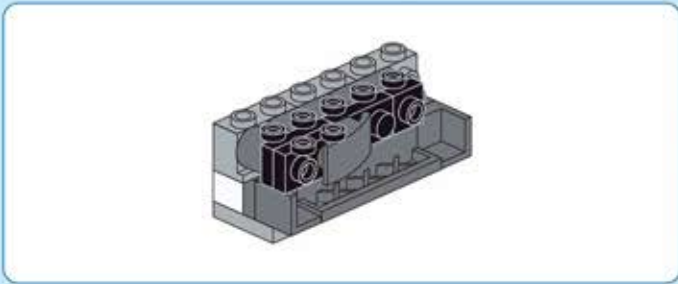

B81

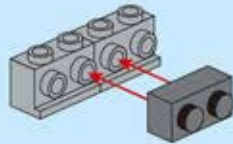
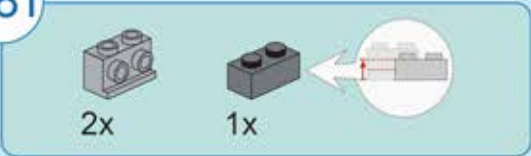

B82

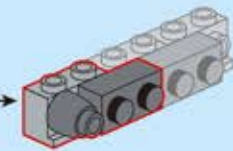
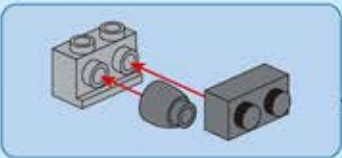
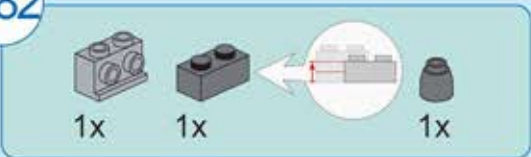

B83

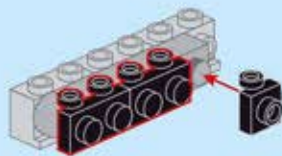

B84

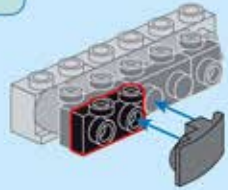

B85

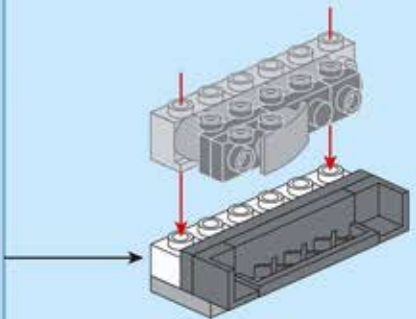
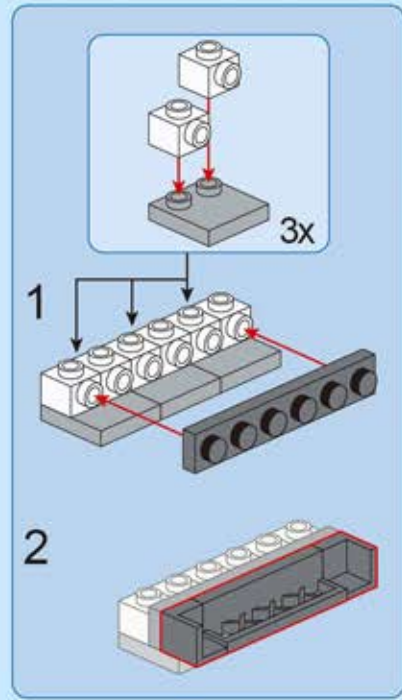
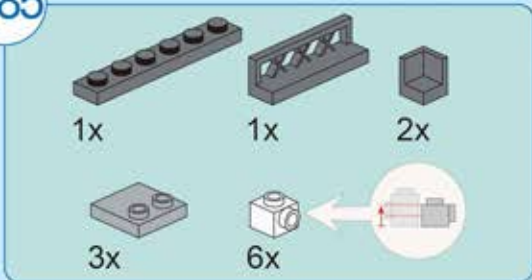

B86

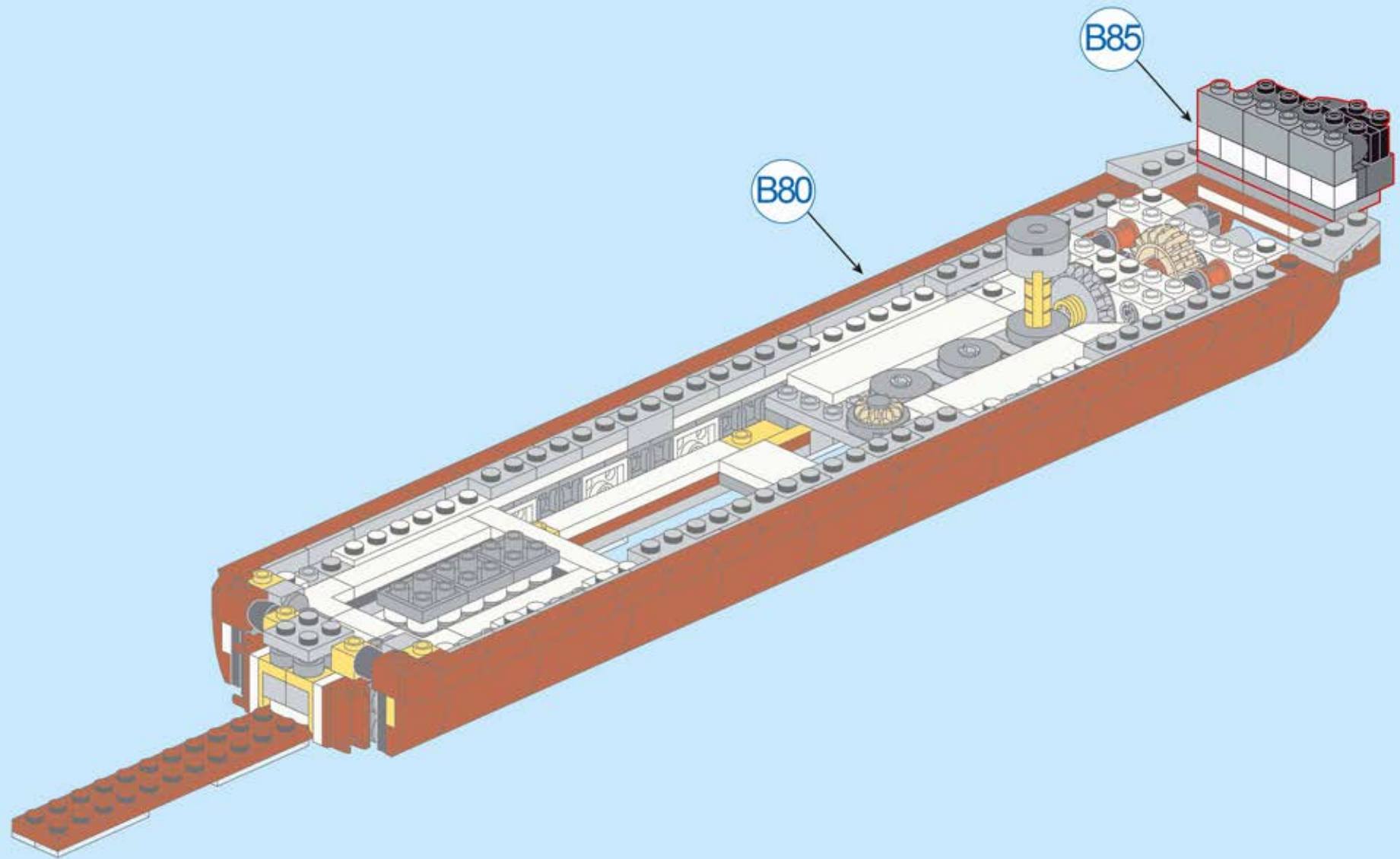

B87



2x



2x



4x

1

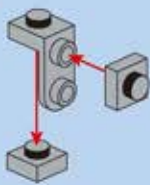

2

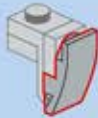

2x

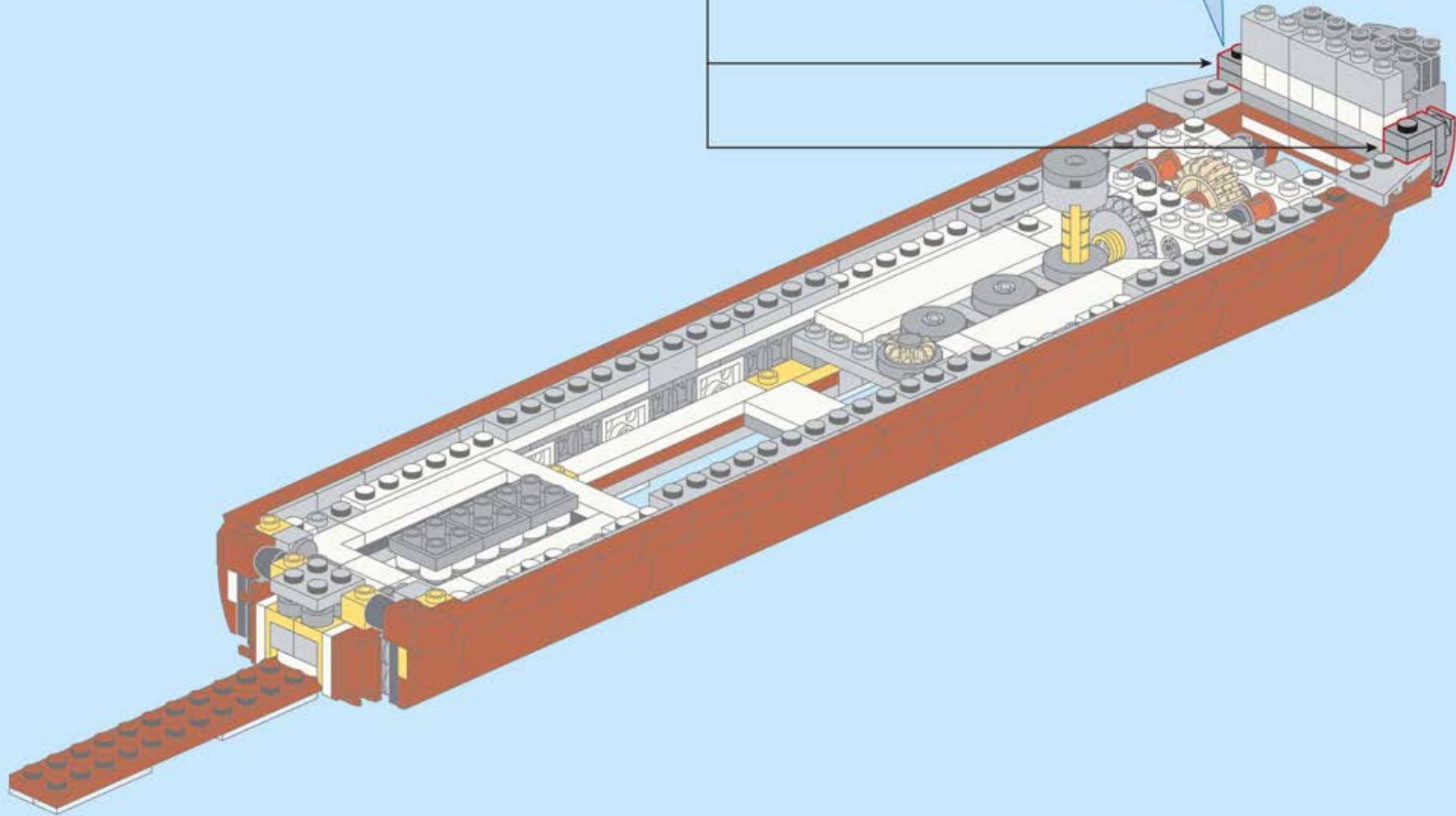
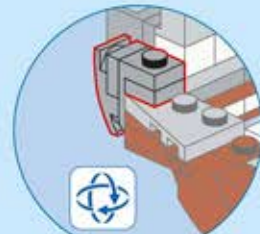

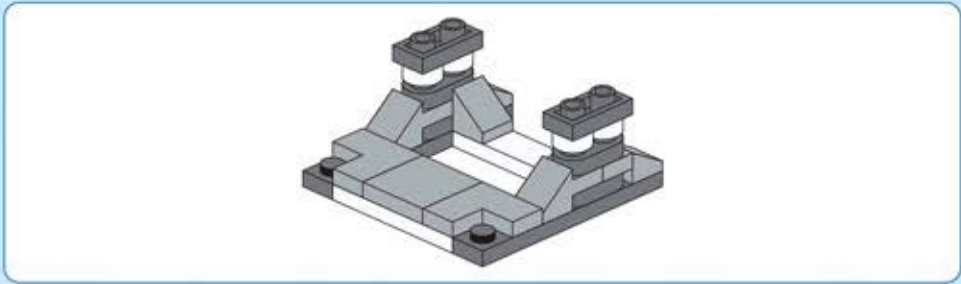

B88

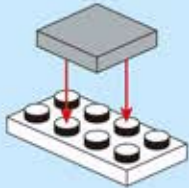
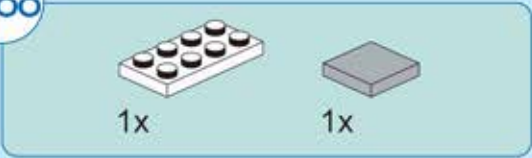

B89

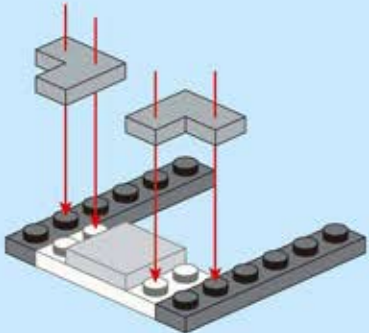
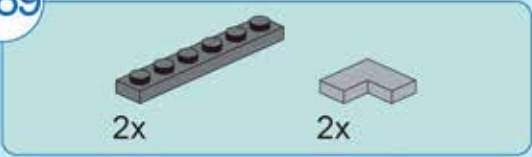

B90

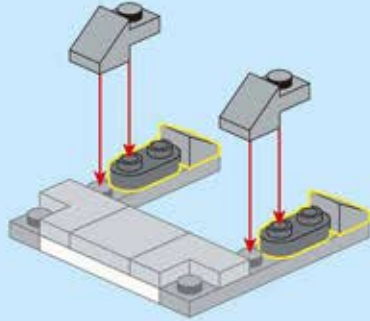
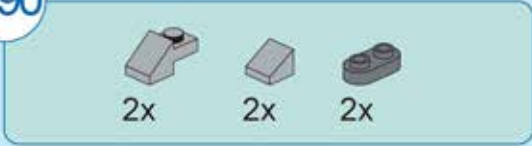

B91

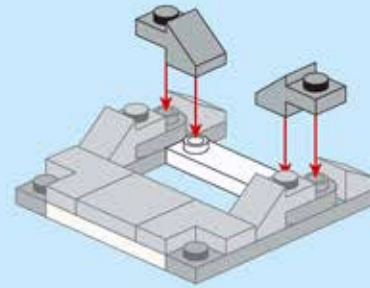
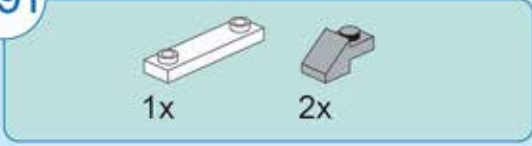

B92

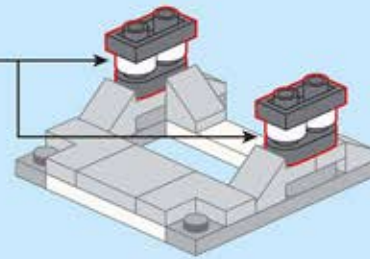
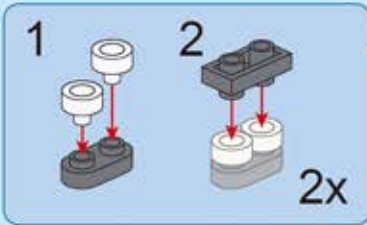

B93

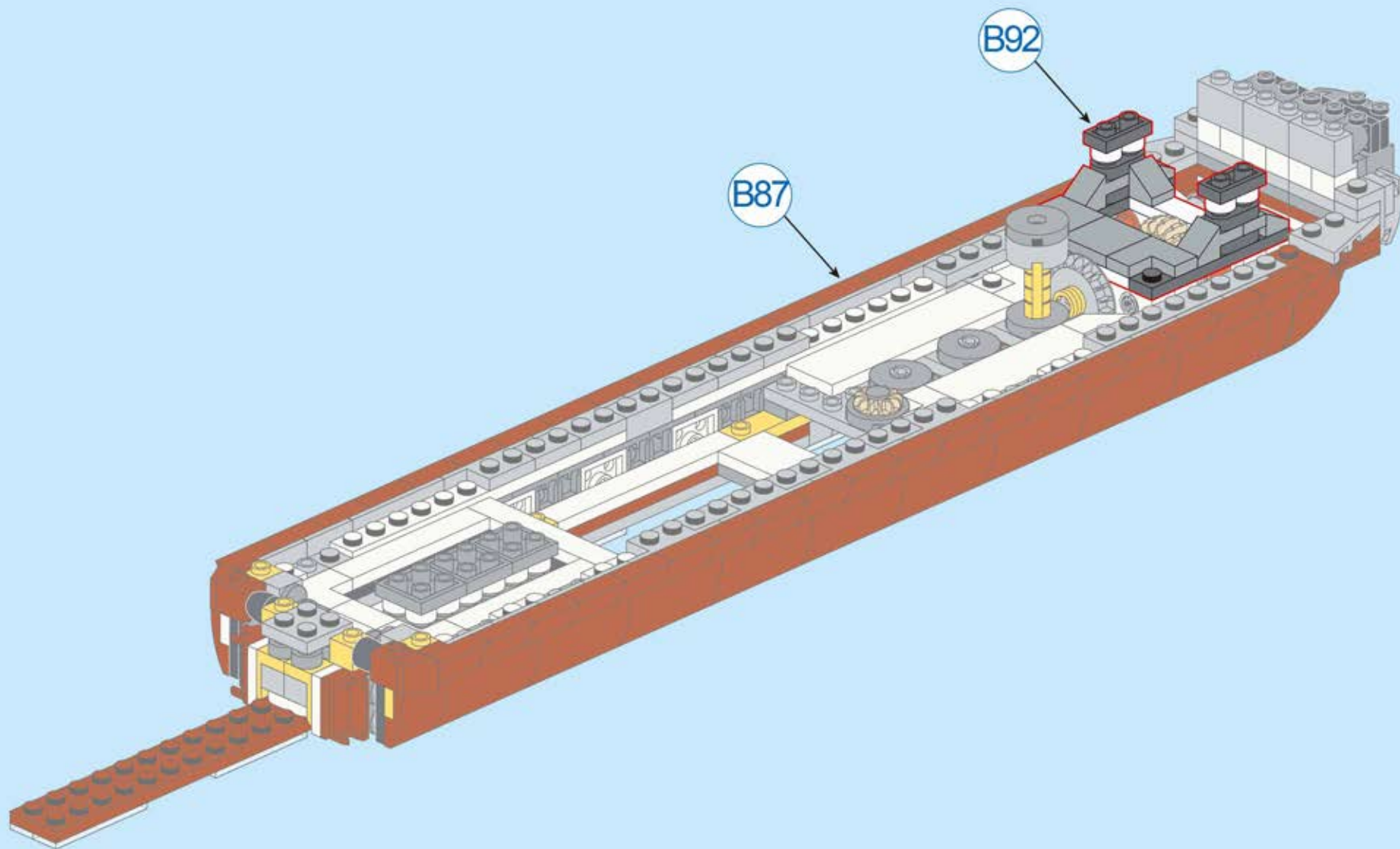

B94

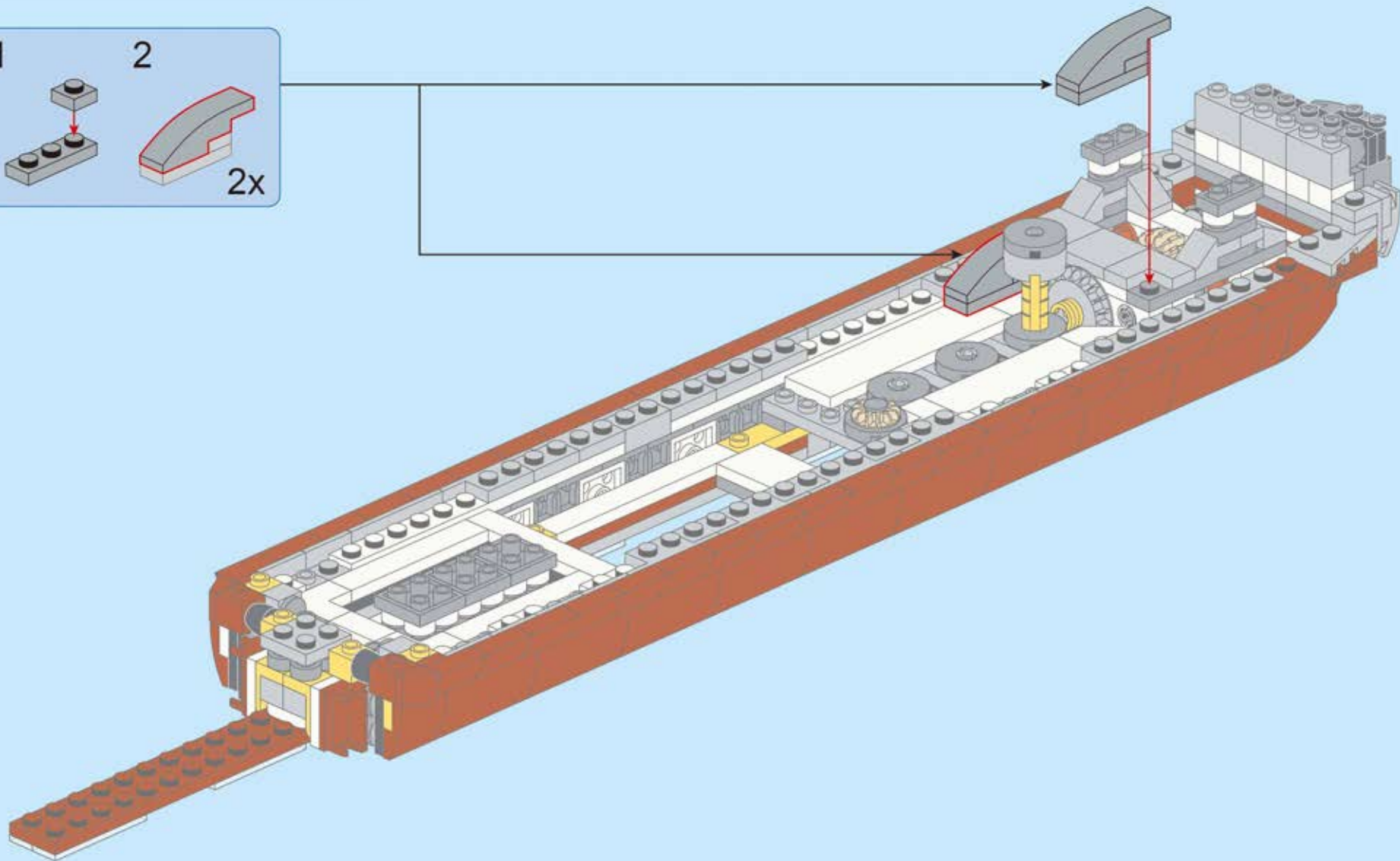
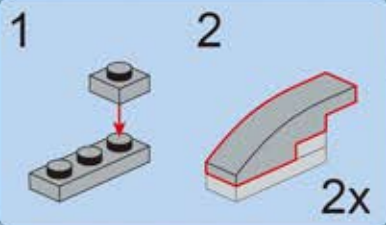
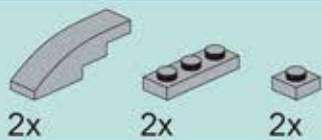

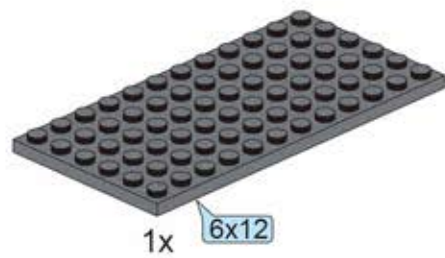

+

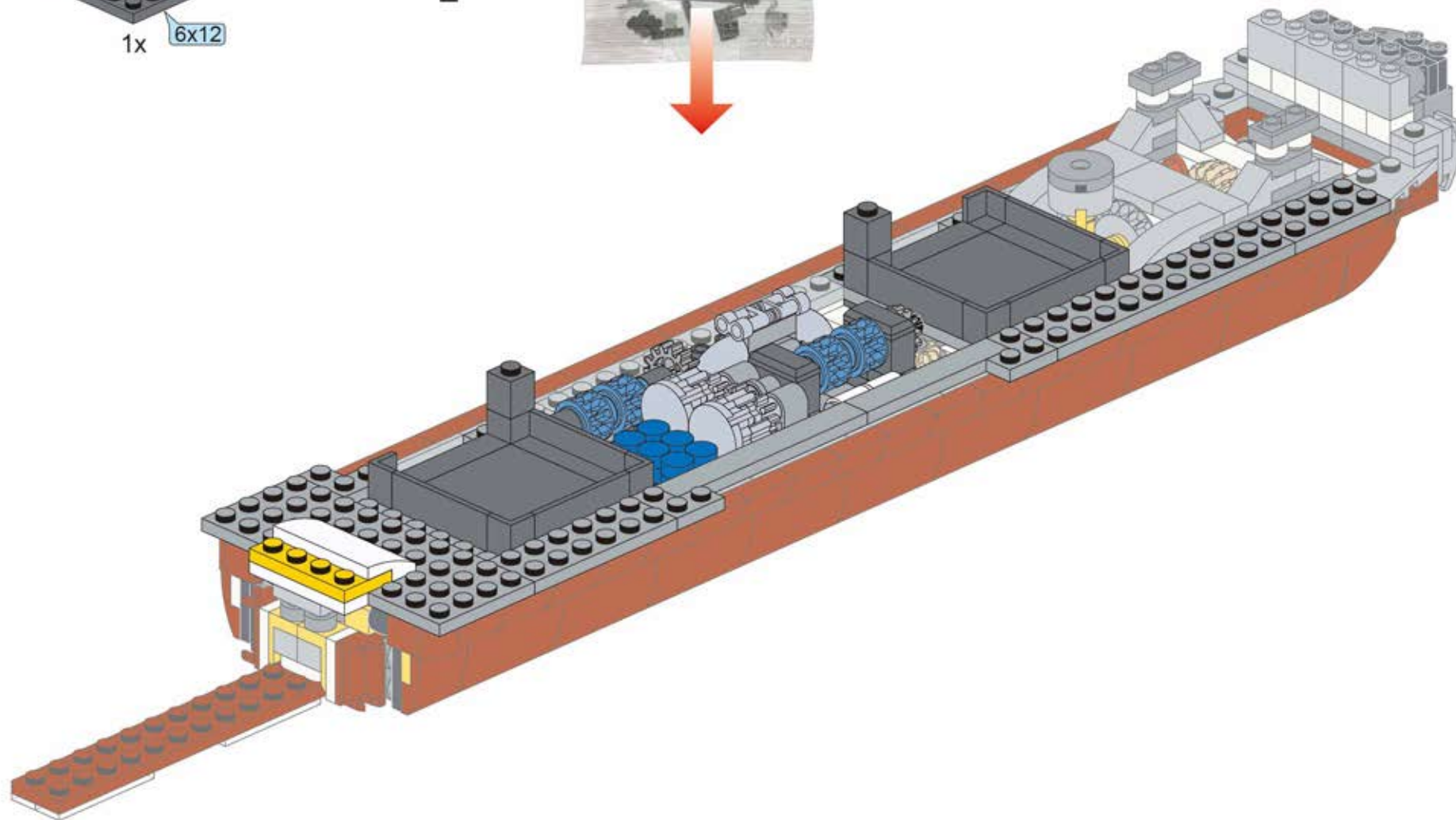

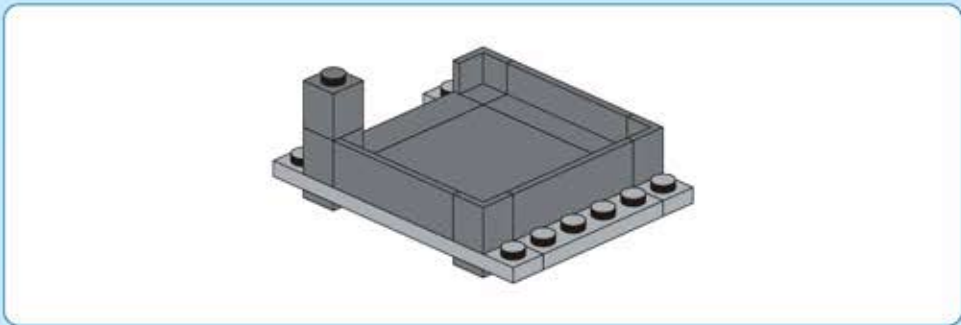

B95

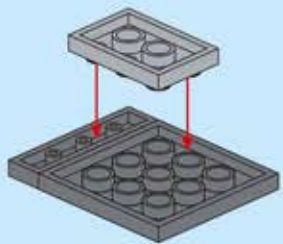
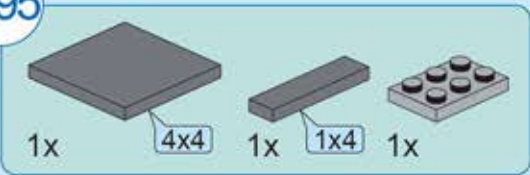

B96

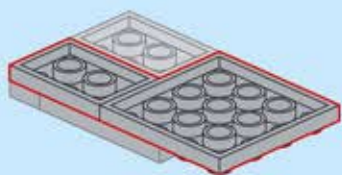
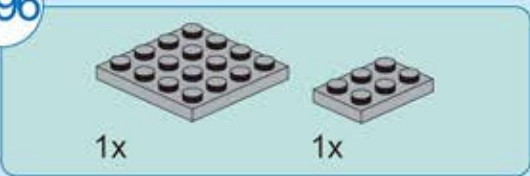

B97

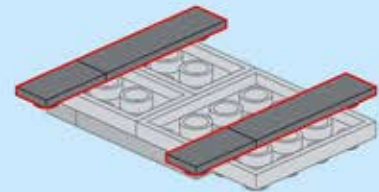

B98

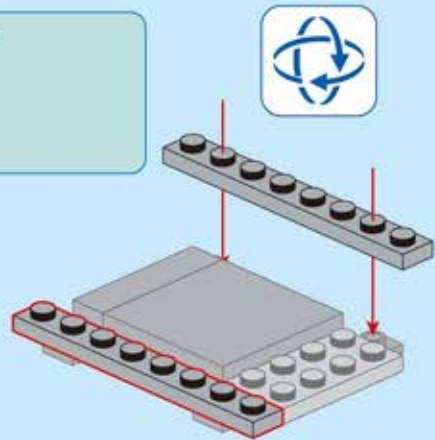
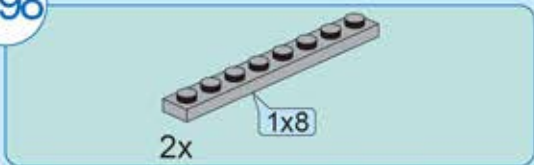

B99

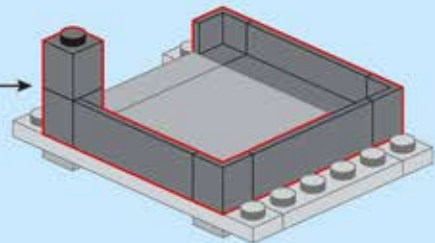
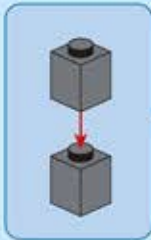
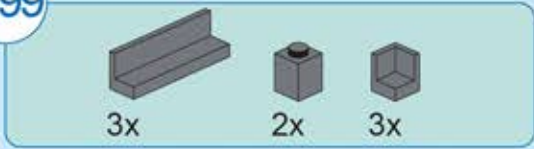

B100

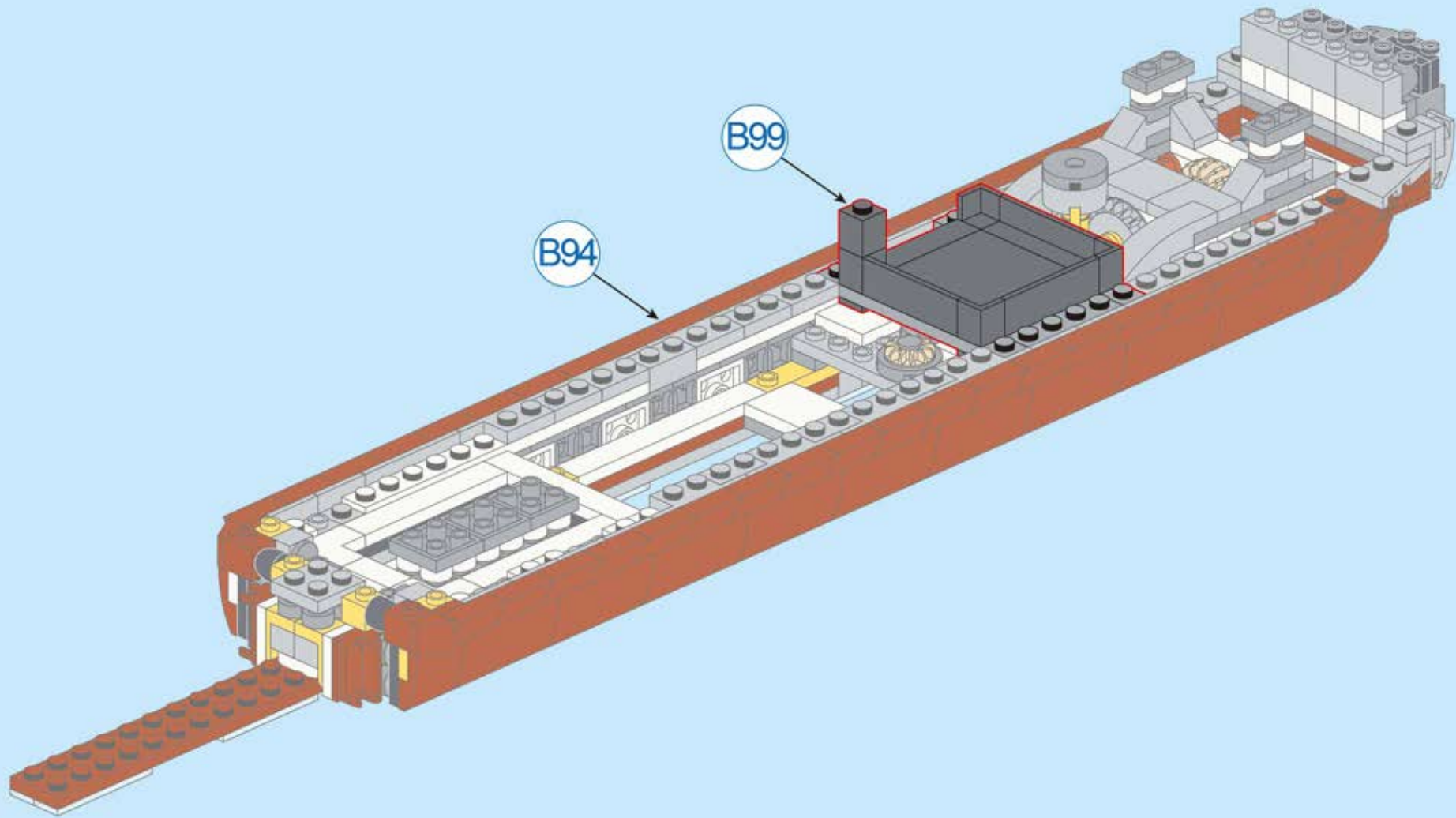

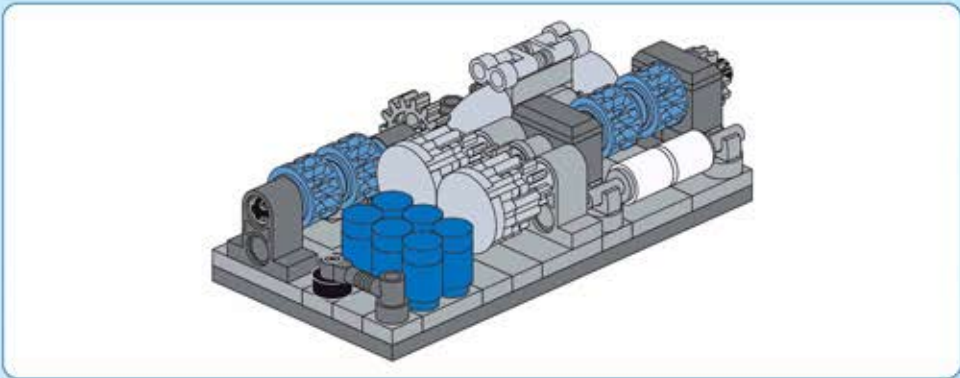

B101

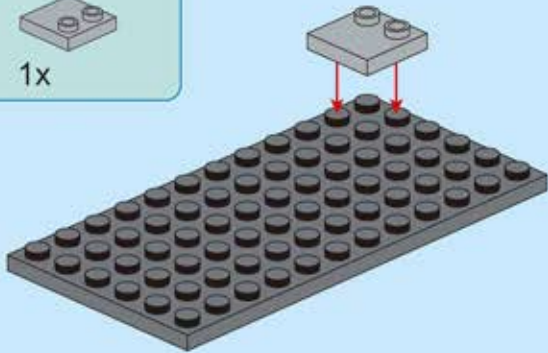
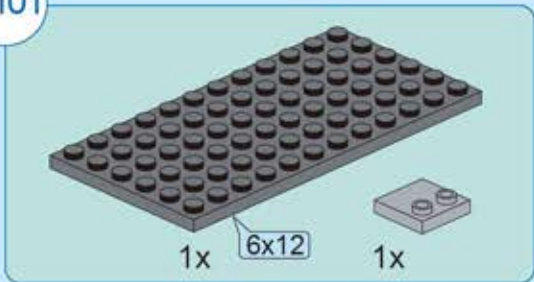

B102

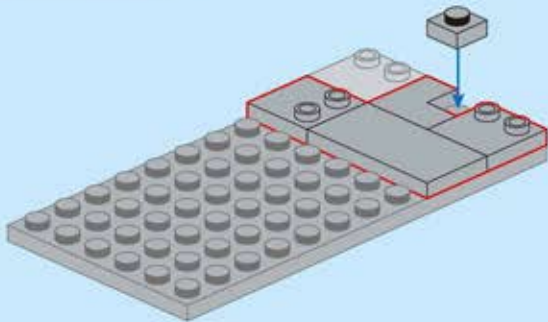
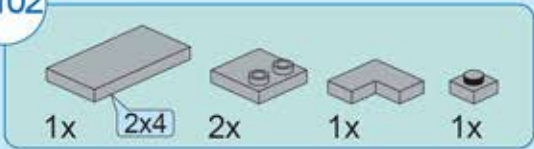

B103

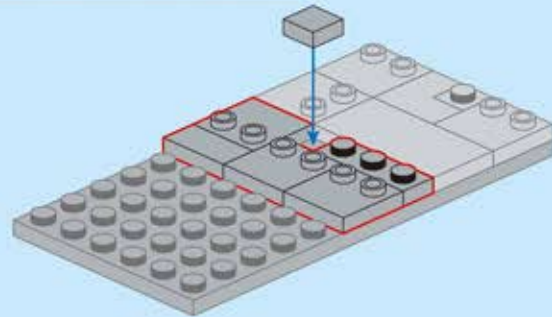
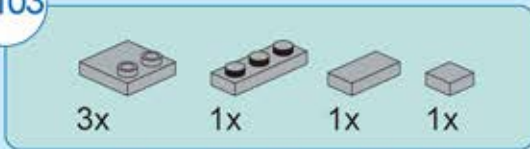

B104

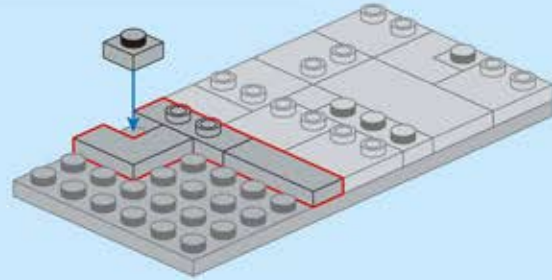
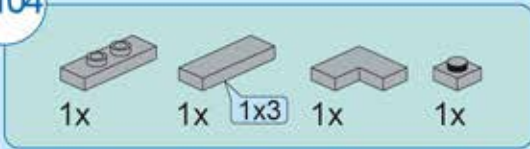

B105

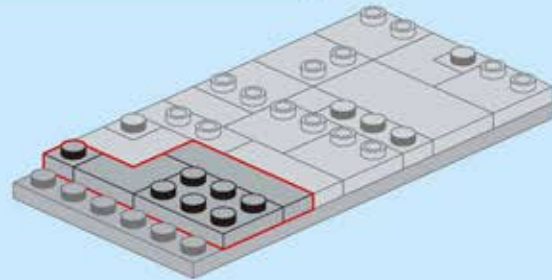
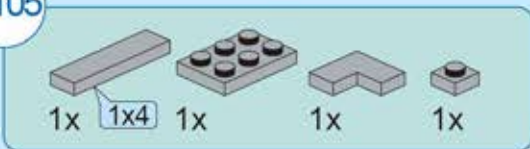

B106

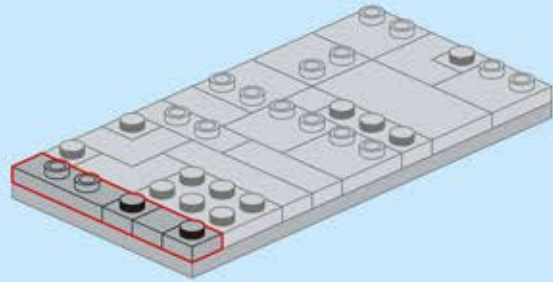
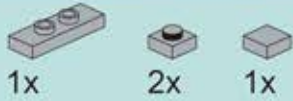

B107

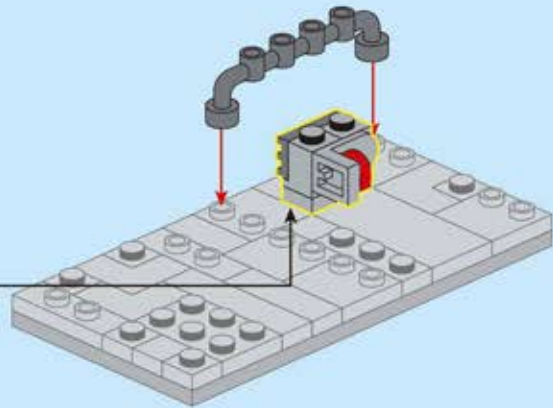
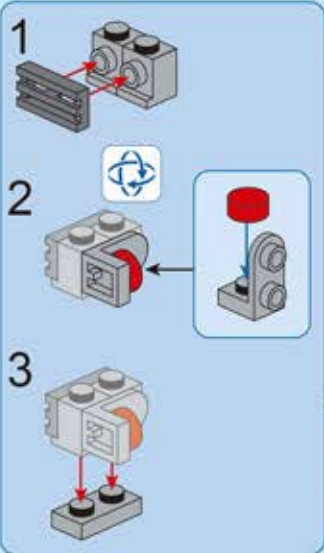
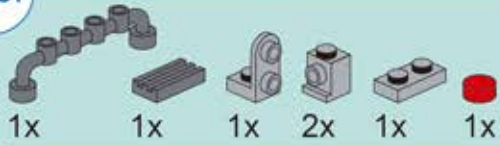

B108

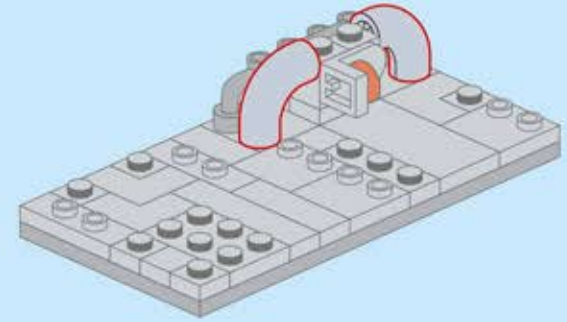

B109

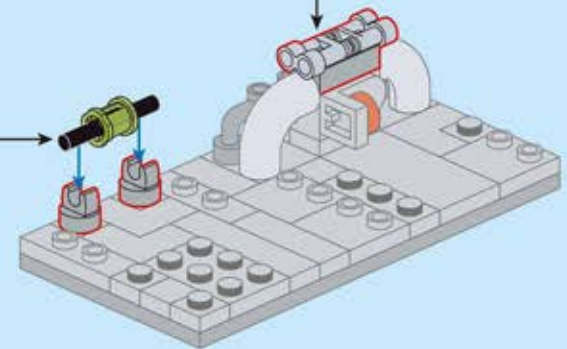
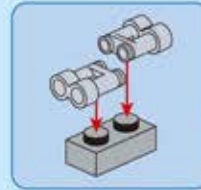
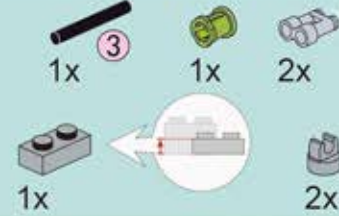

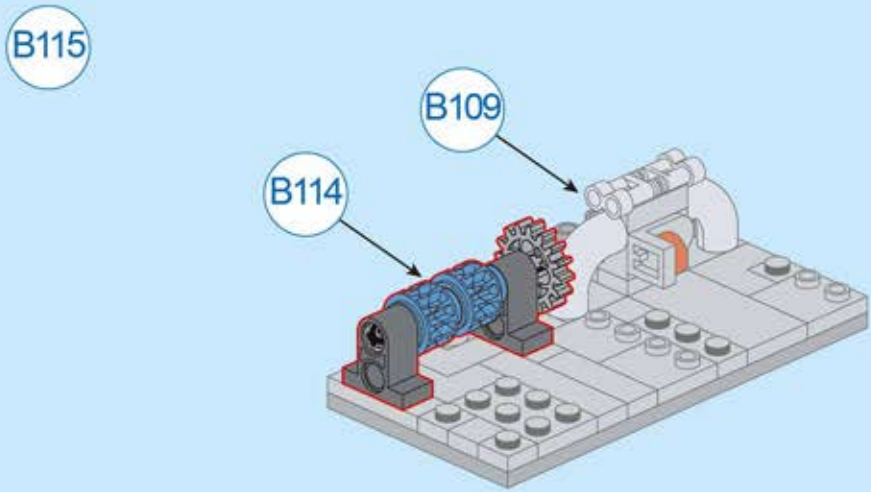
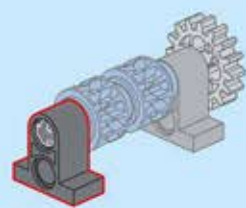
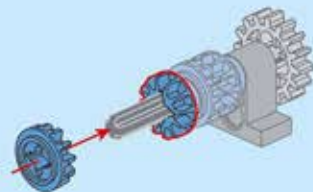
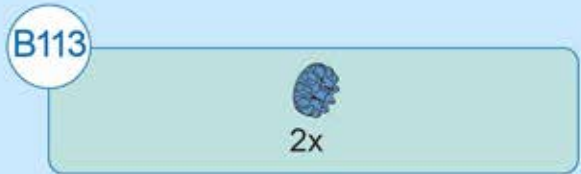
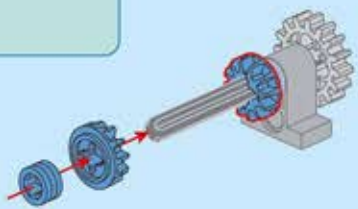
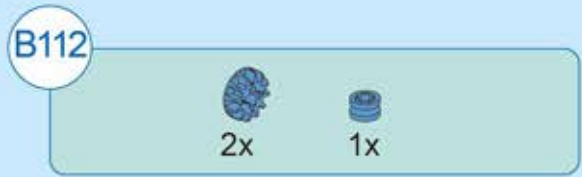
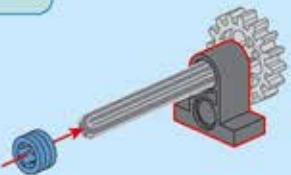
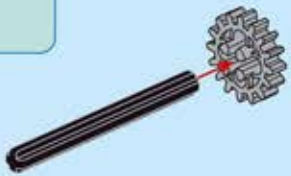
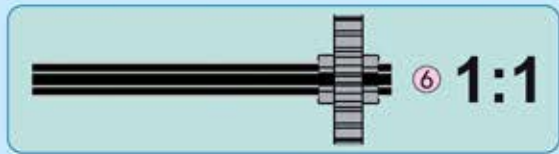
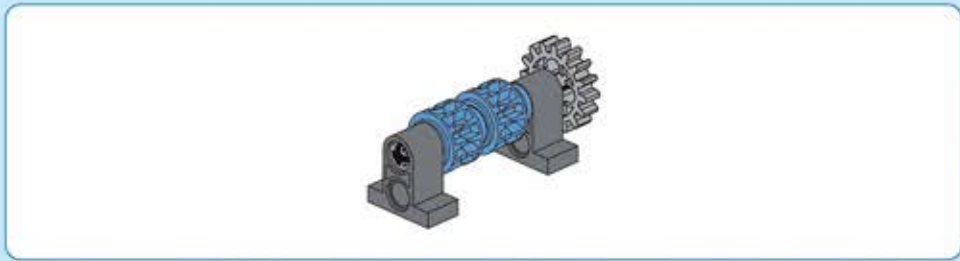

B116

- 2x
- 1x
- 2x
- 2x

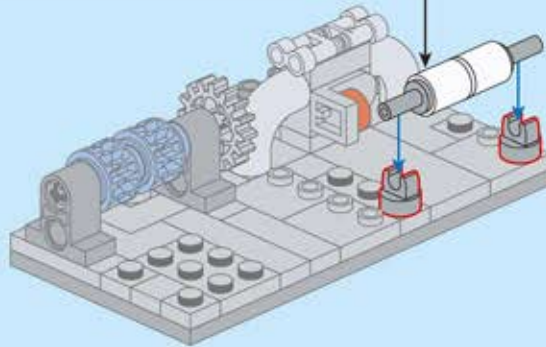
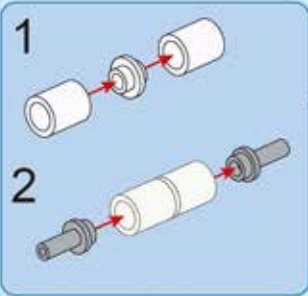

B117

- 2x
- 2x ③
- 2x
- 2x
- 2x
- 2x

③ 1:1

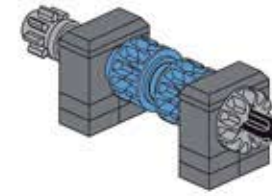
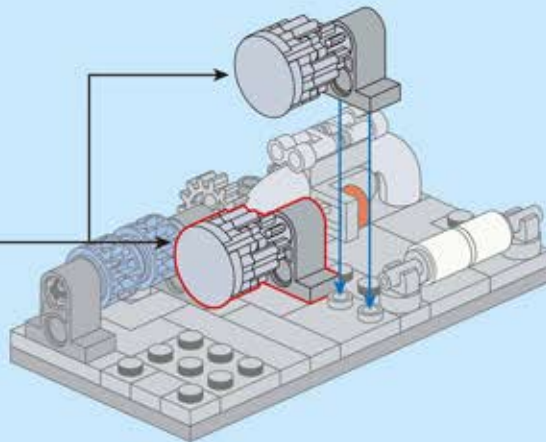
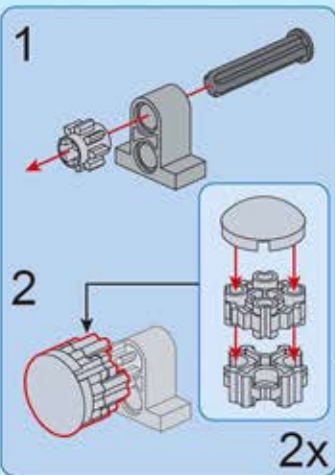

⑧ 1:1

B118

- 1x ⑧
- 1x

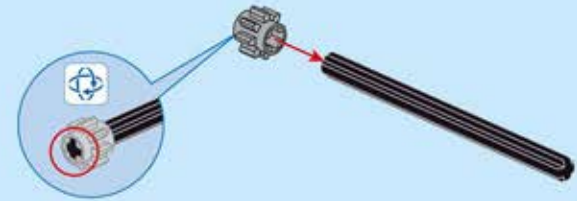

B119

- 1x
- 4x
- 1x
- 1x
- 1x

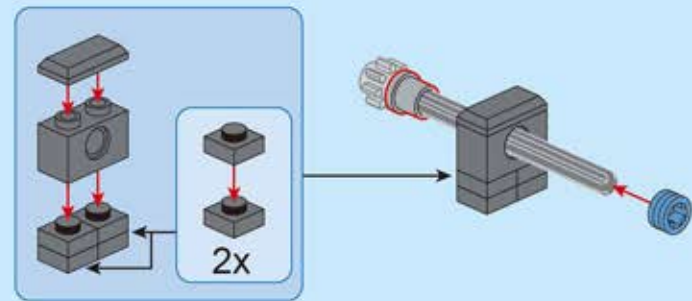

B120

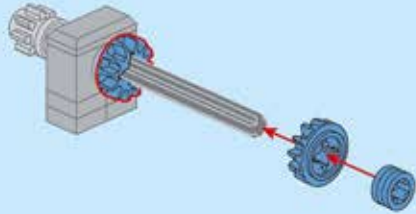

B121

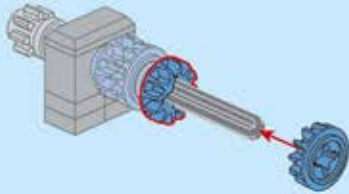

B122

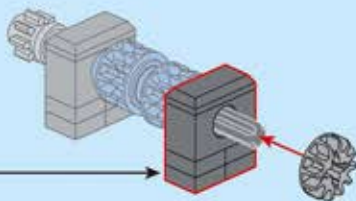
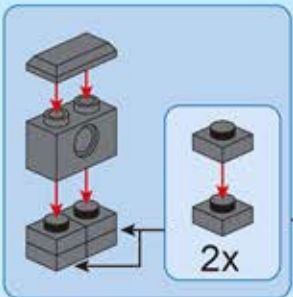

B123

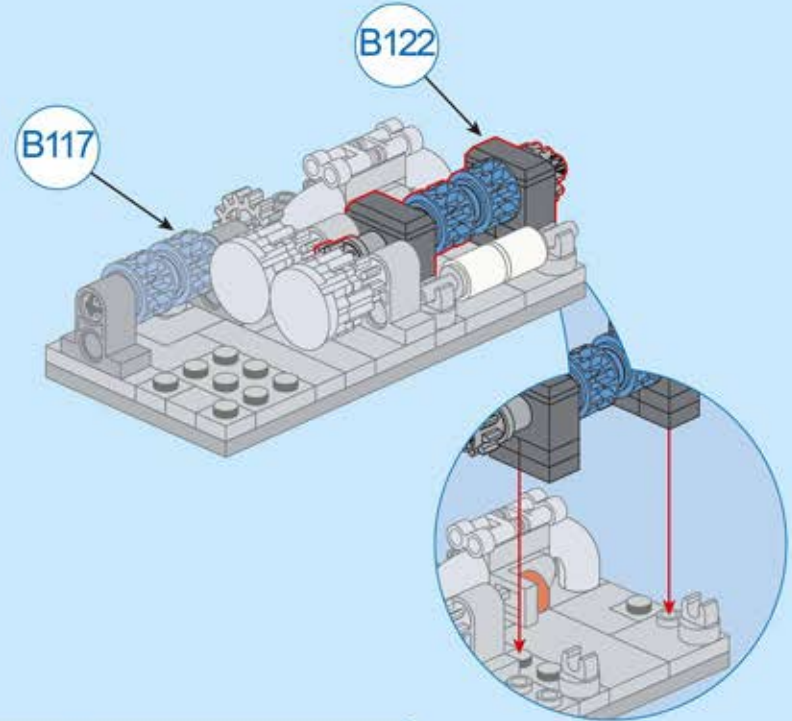

B124

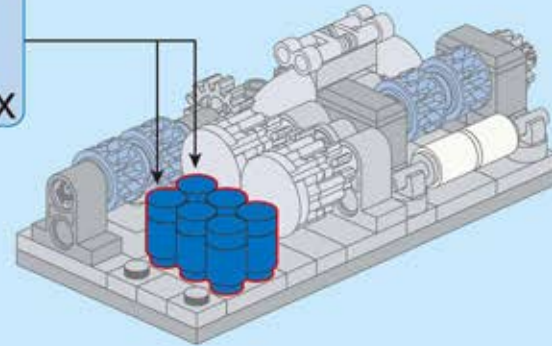

B125

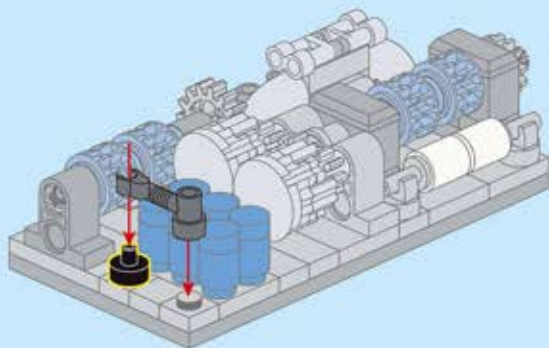

B126

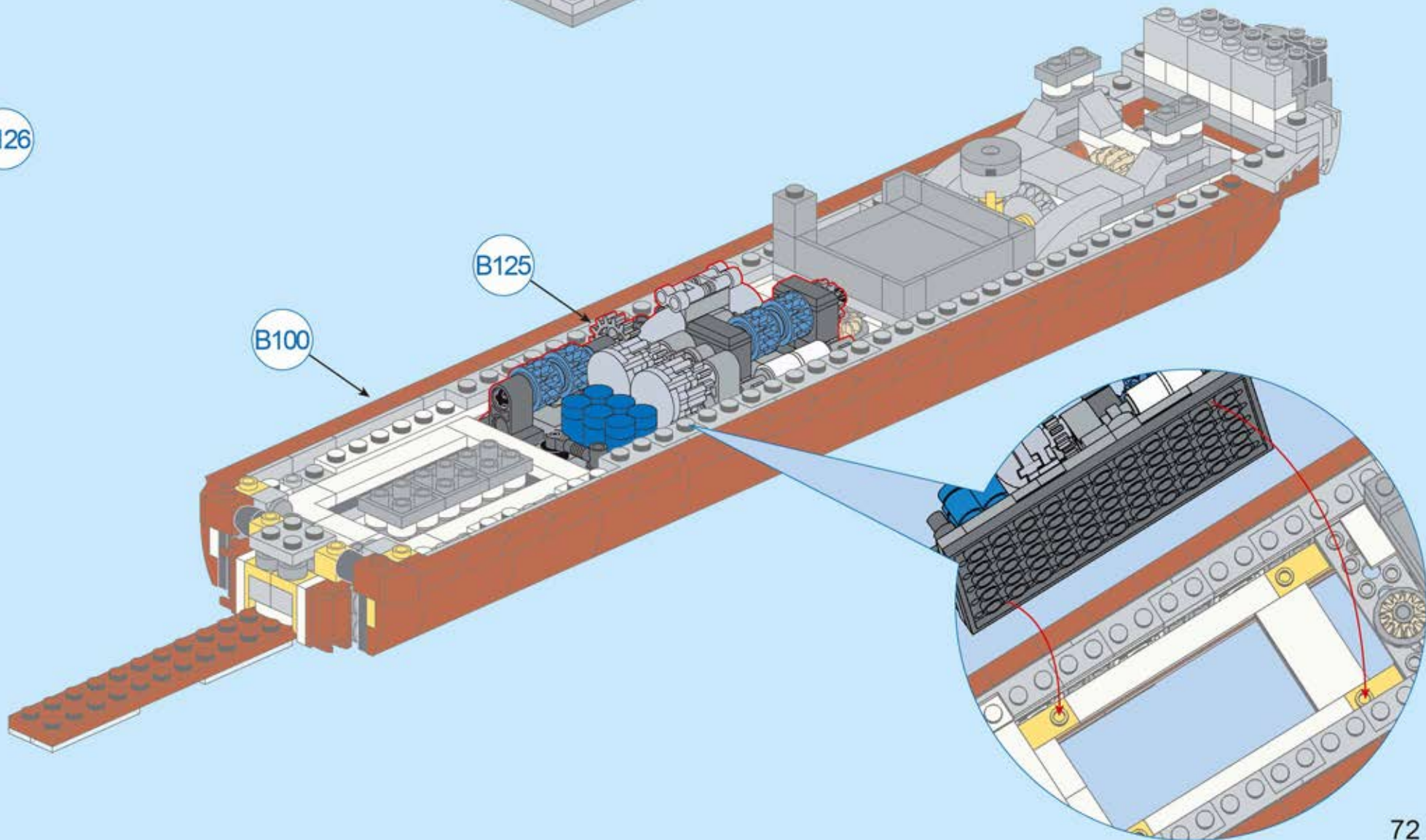

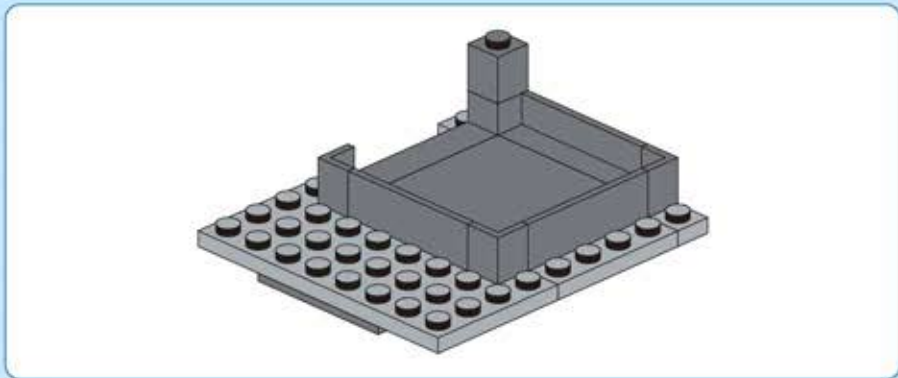

B127

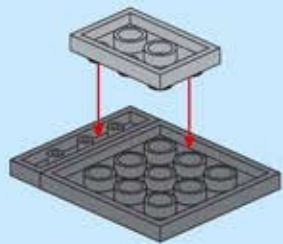
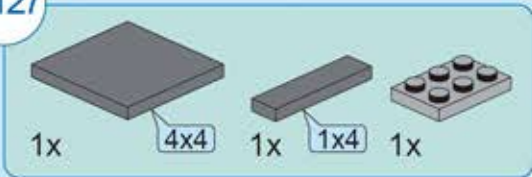

B128

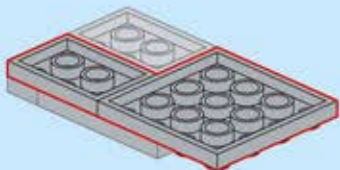
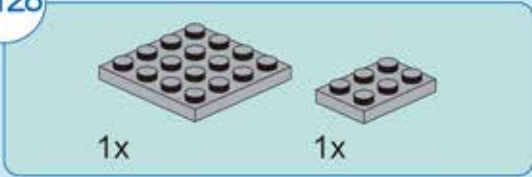

B129

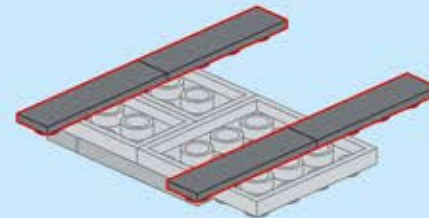
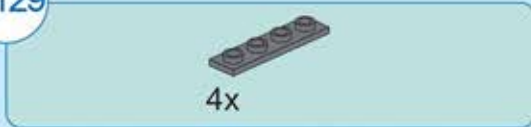

B130

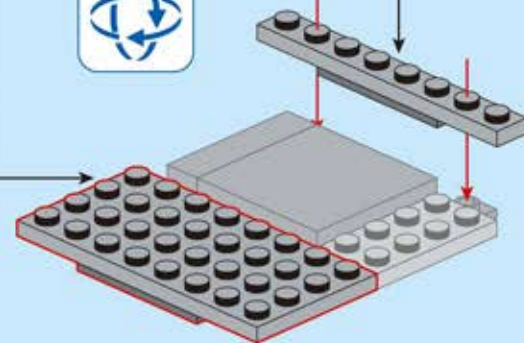
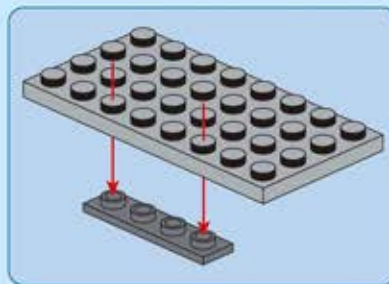
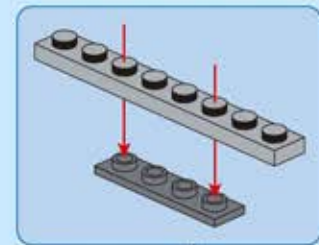
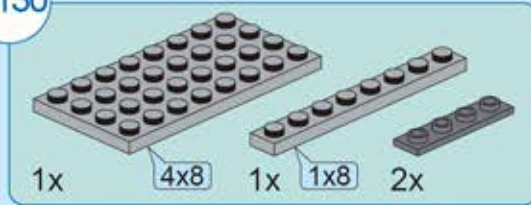

B131

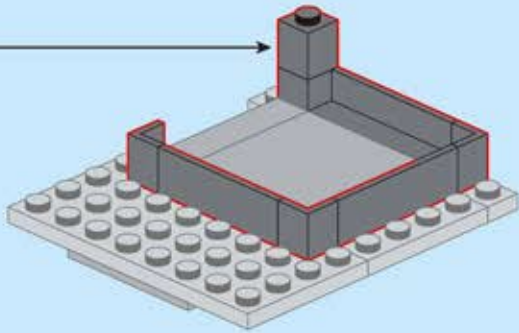
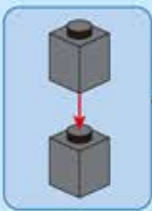
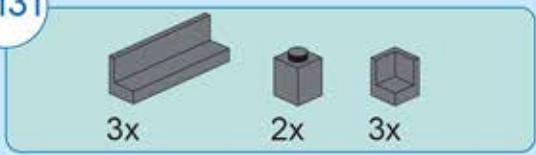

B132

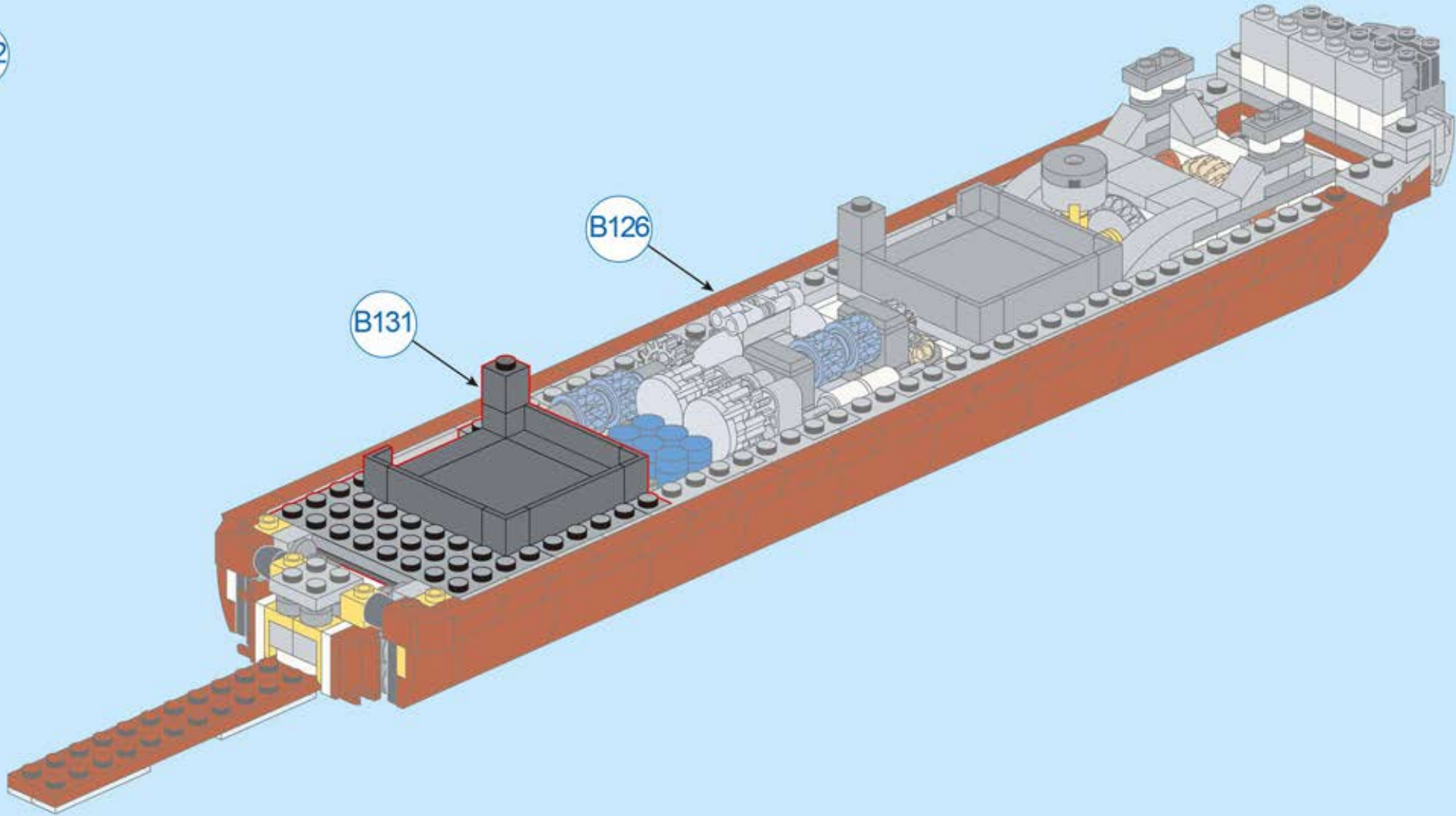

B133

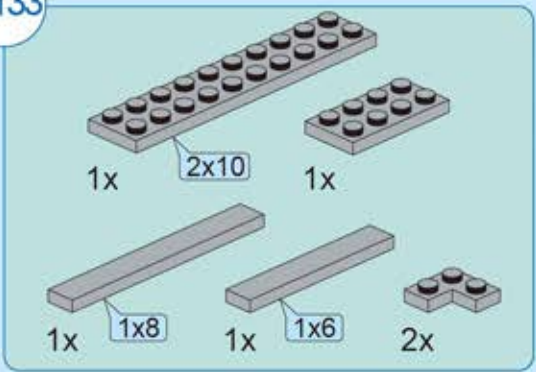

B134

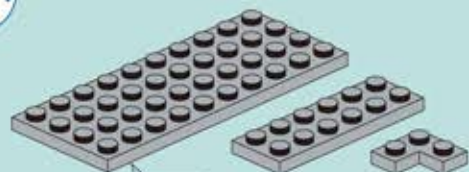

1x

4x10

1x

1x

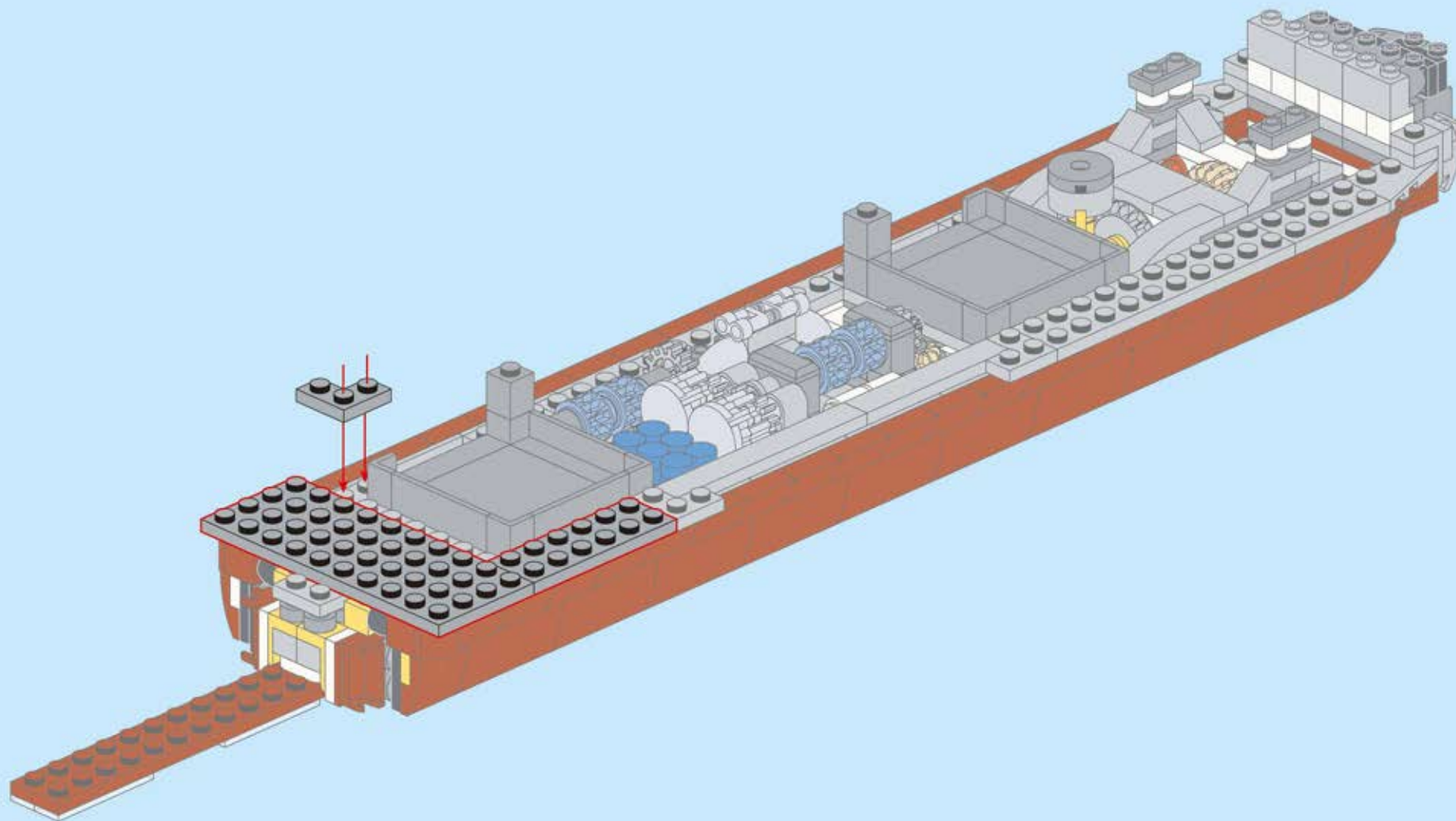

B135

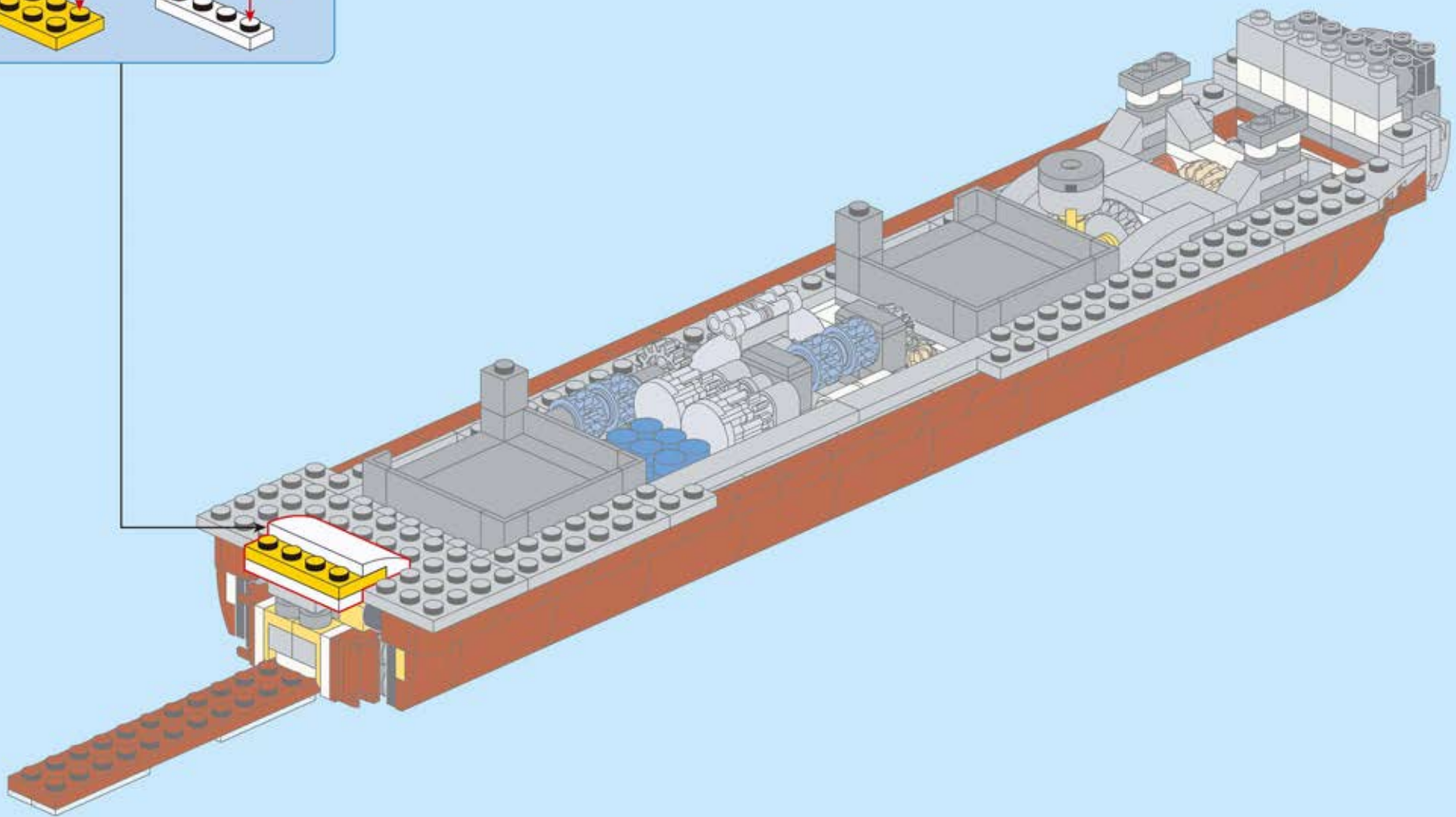
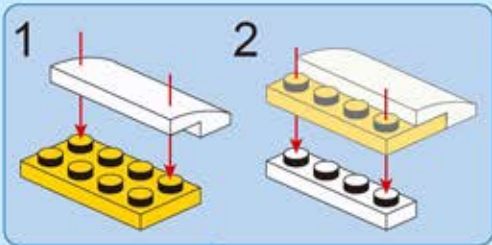
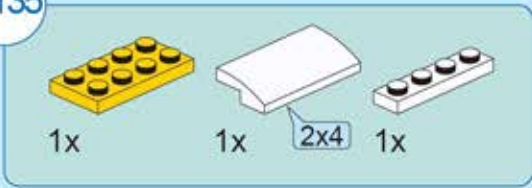

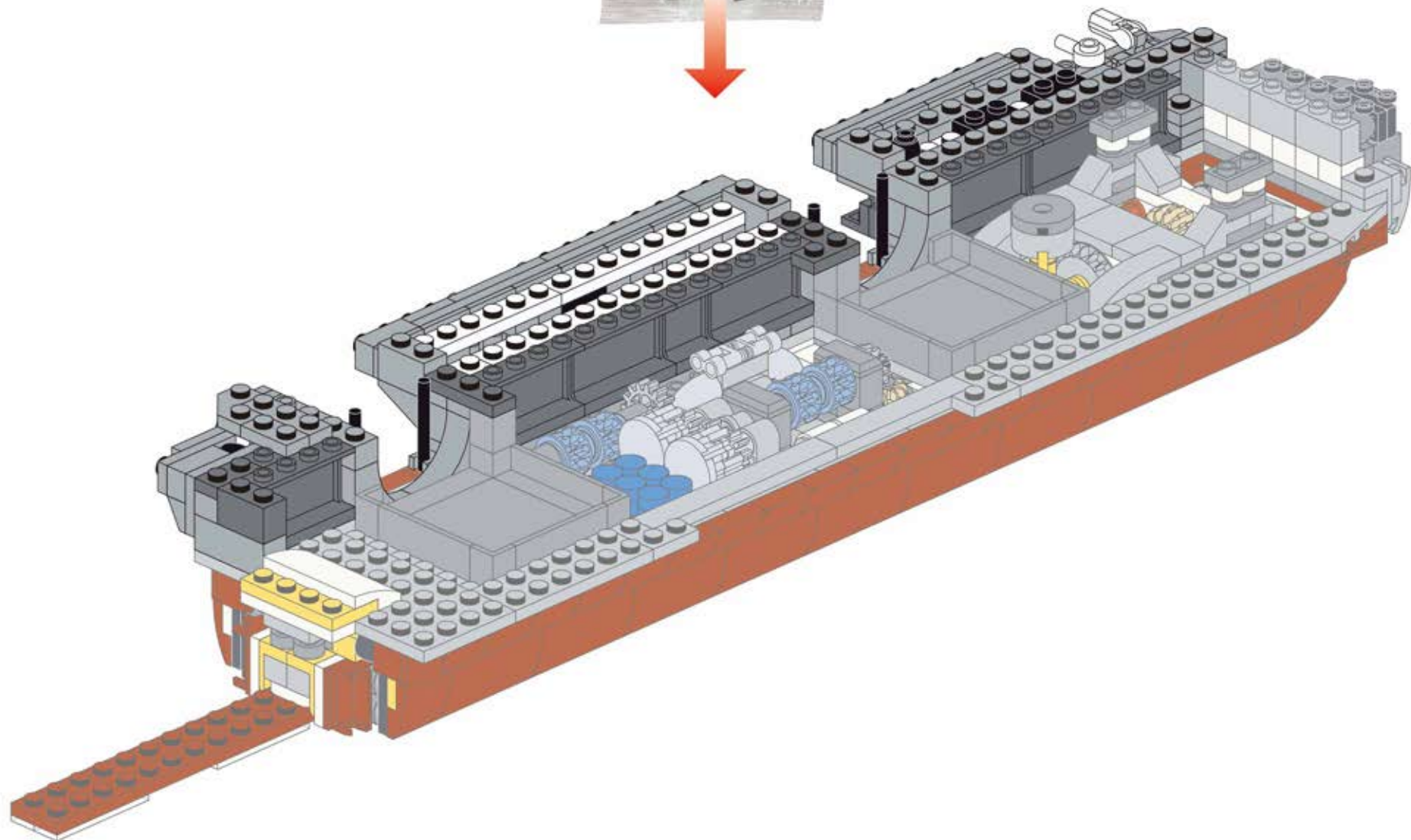

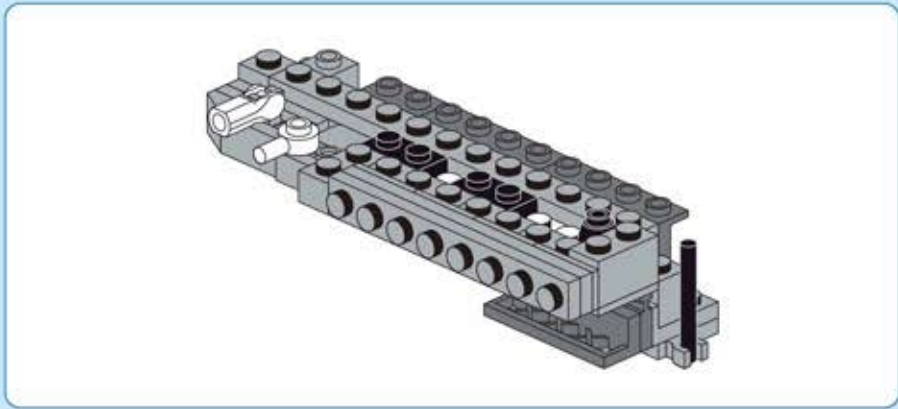

B136

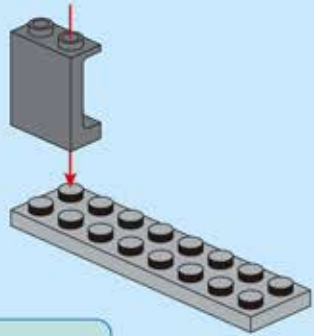
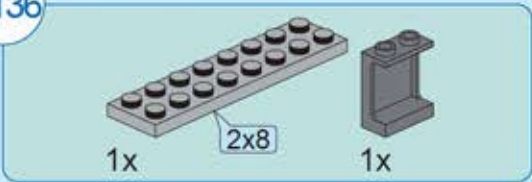

B137

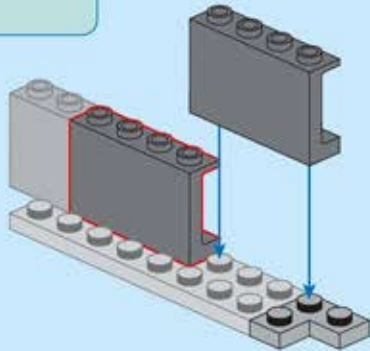
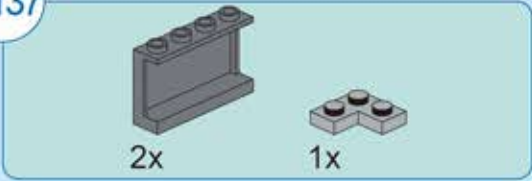

B138

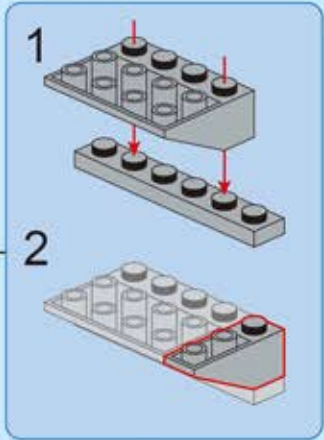
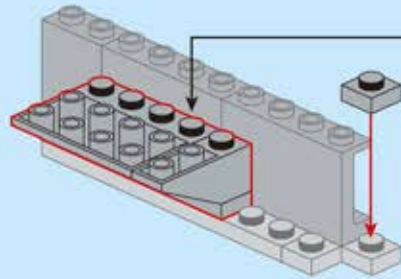
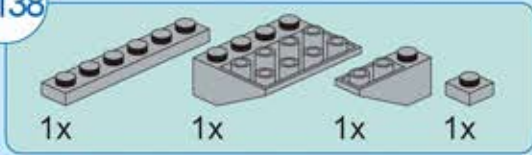

B139

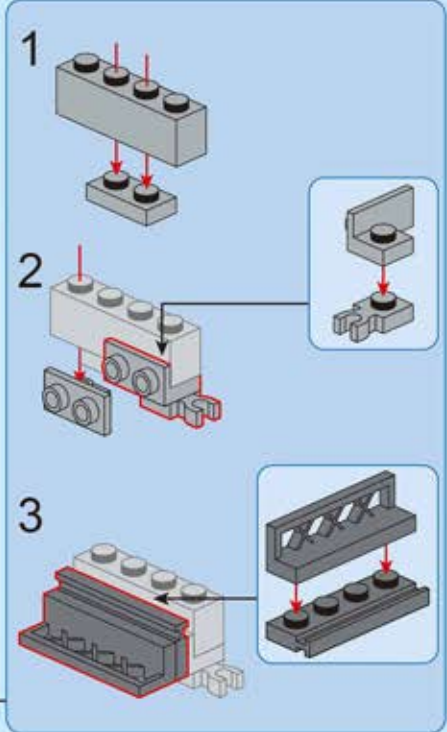
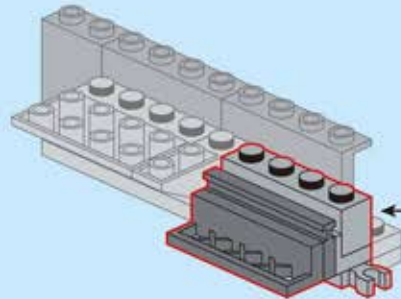
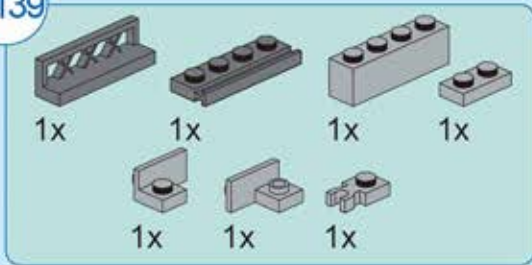

B140

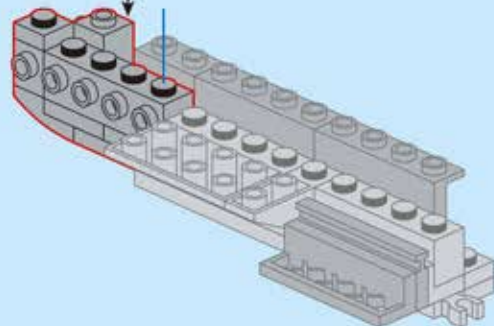
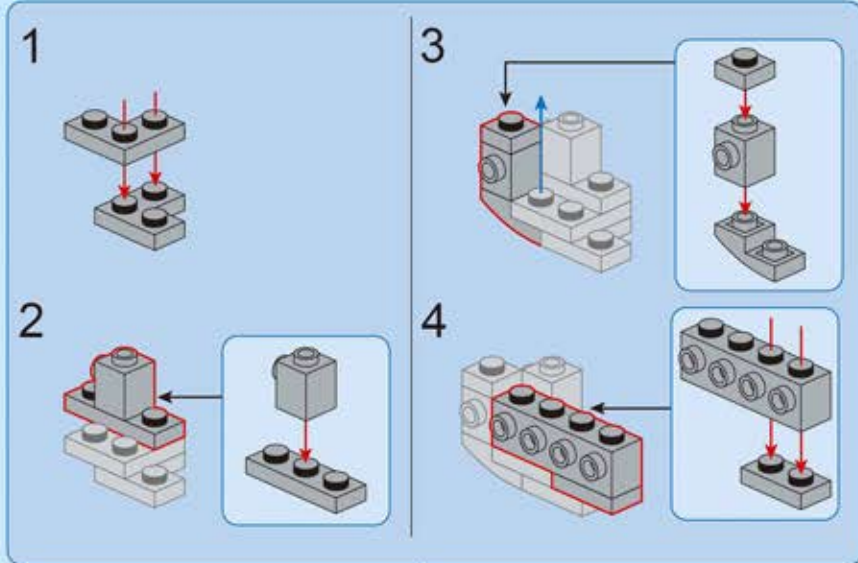
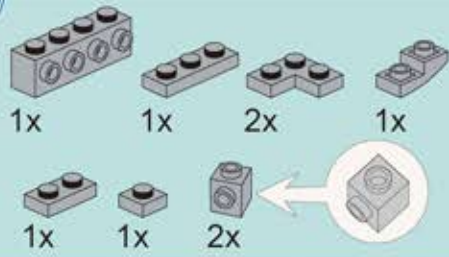

B141

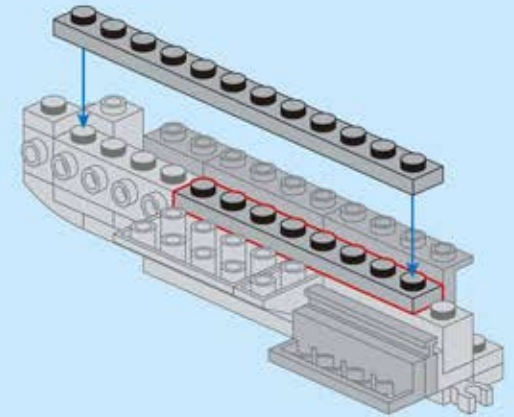
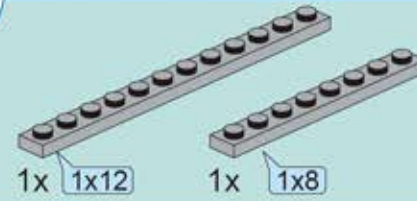

B142

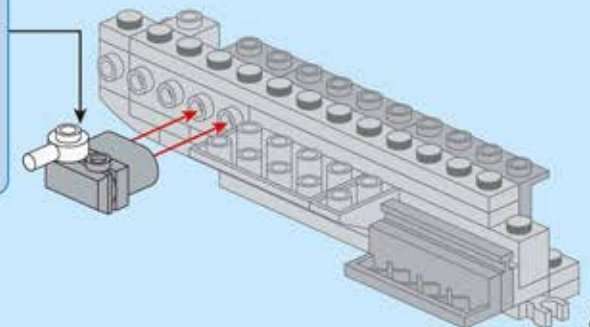
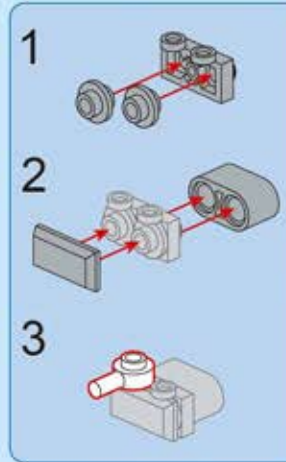
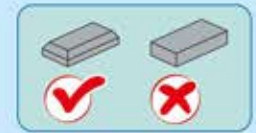
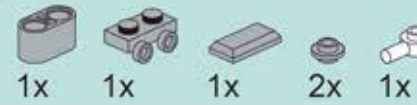

B143

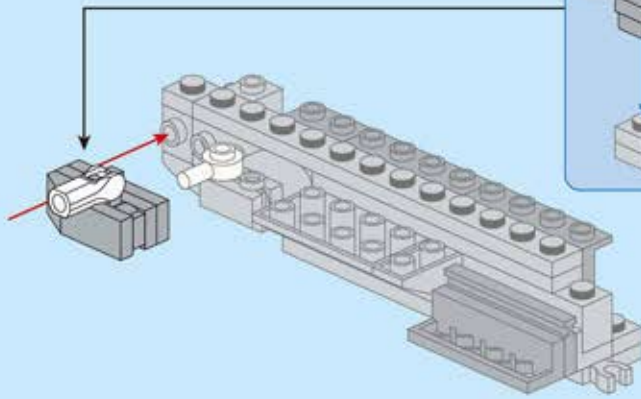
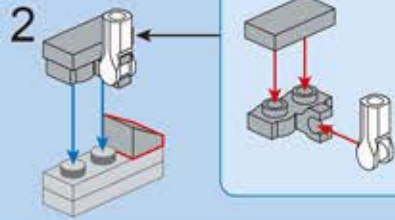
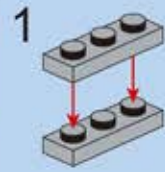
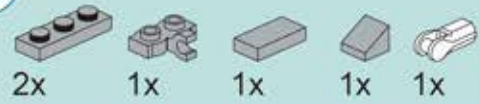

B144

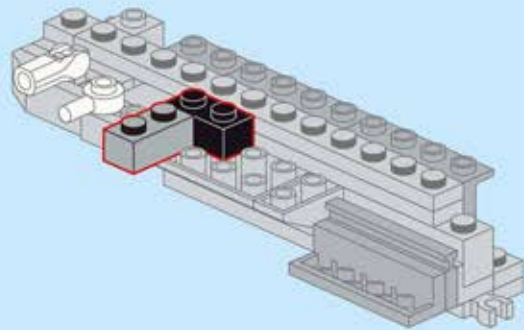
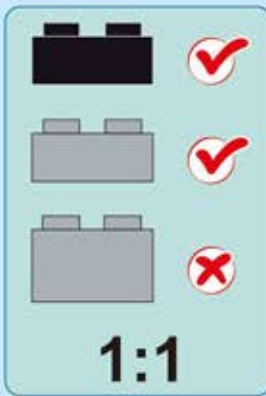
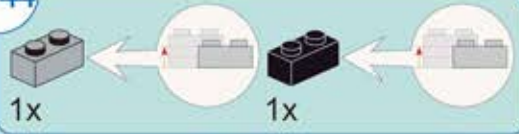

B145

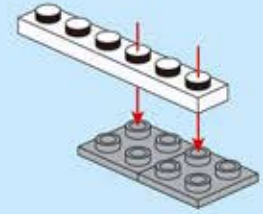
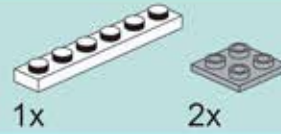

B146

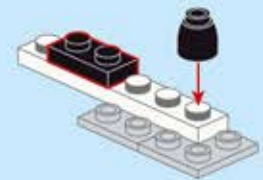

B147

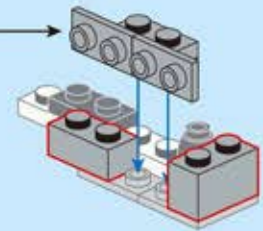
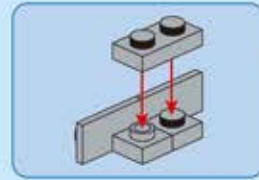
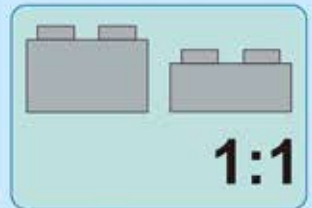
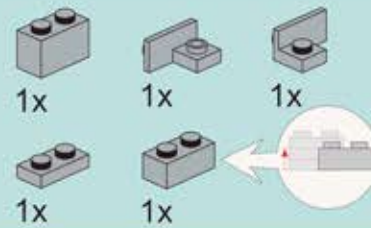

B148

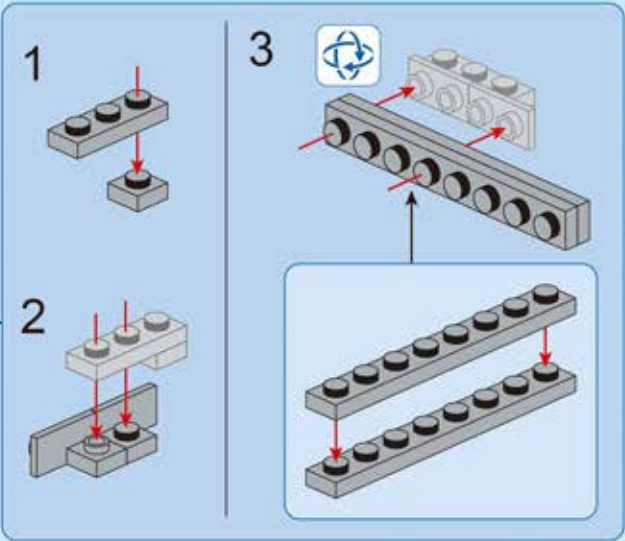
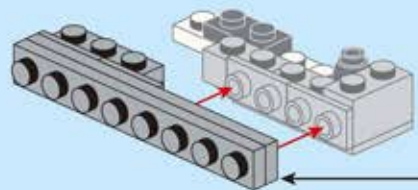
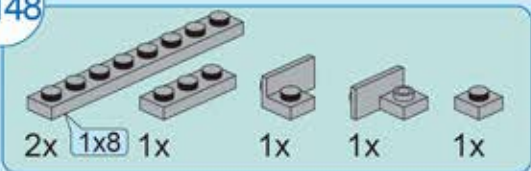

B149

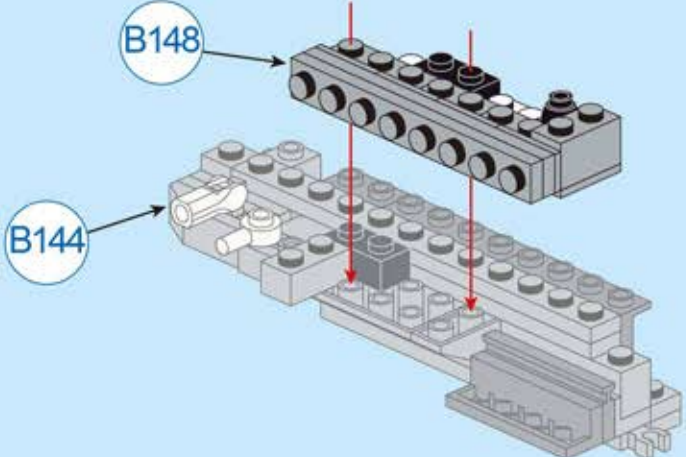

B150

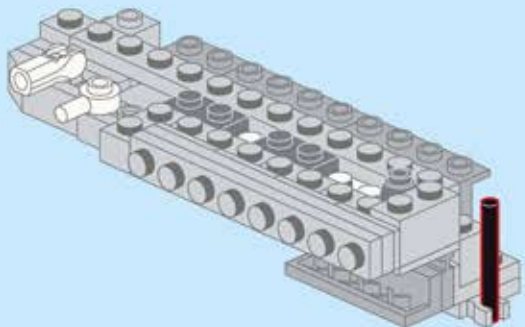

B151

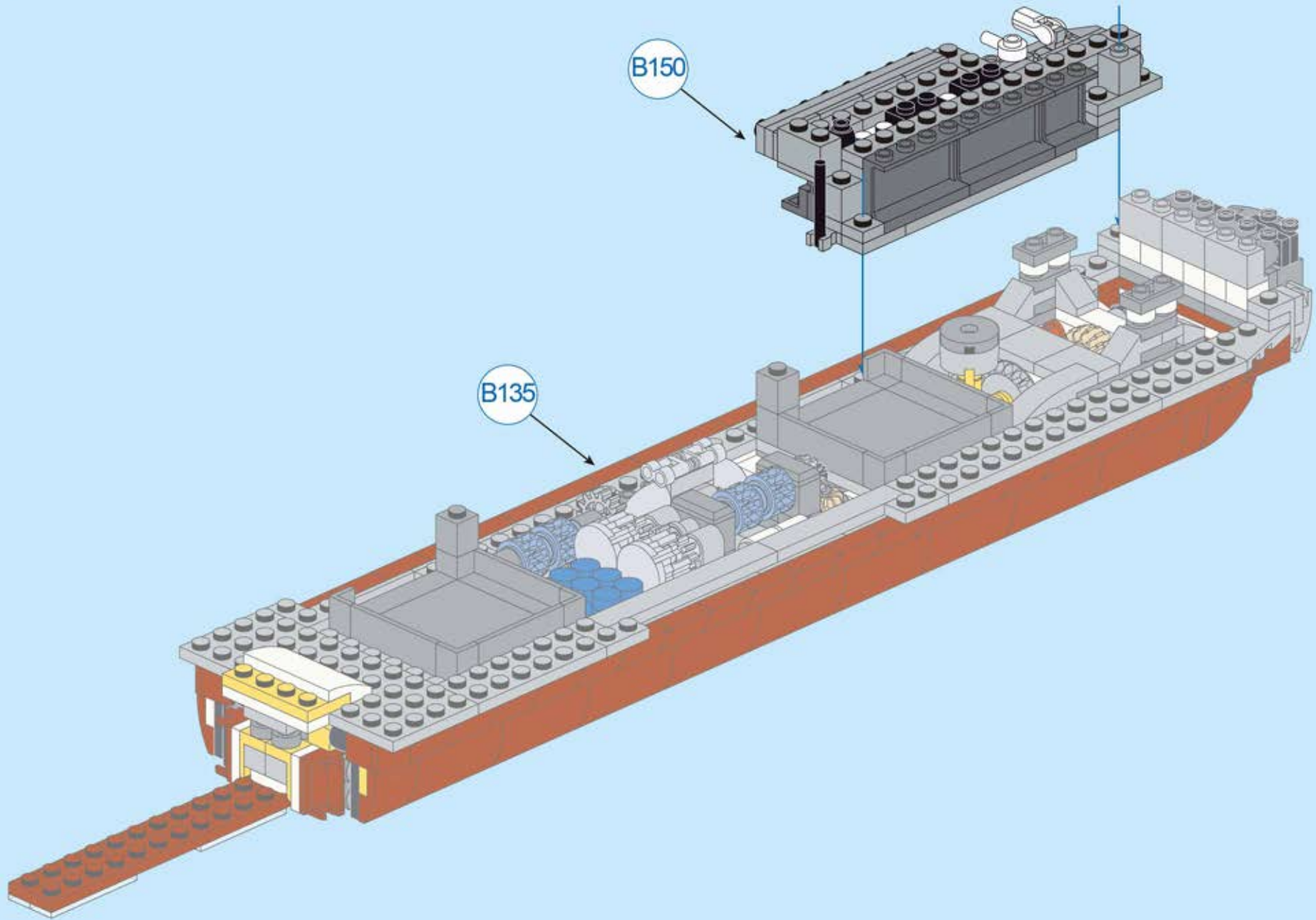

B150

B135

B152

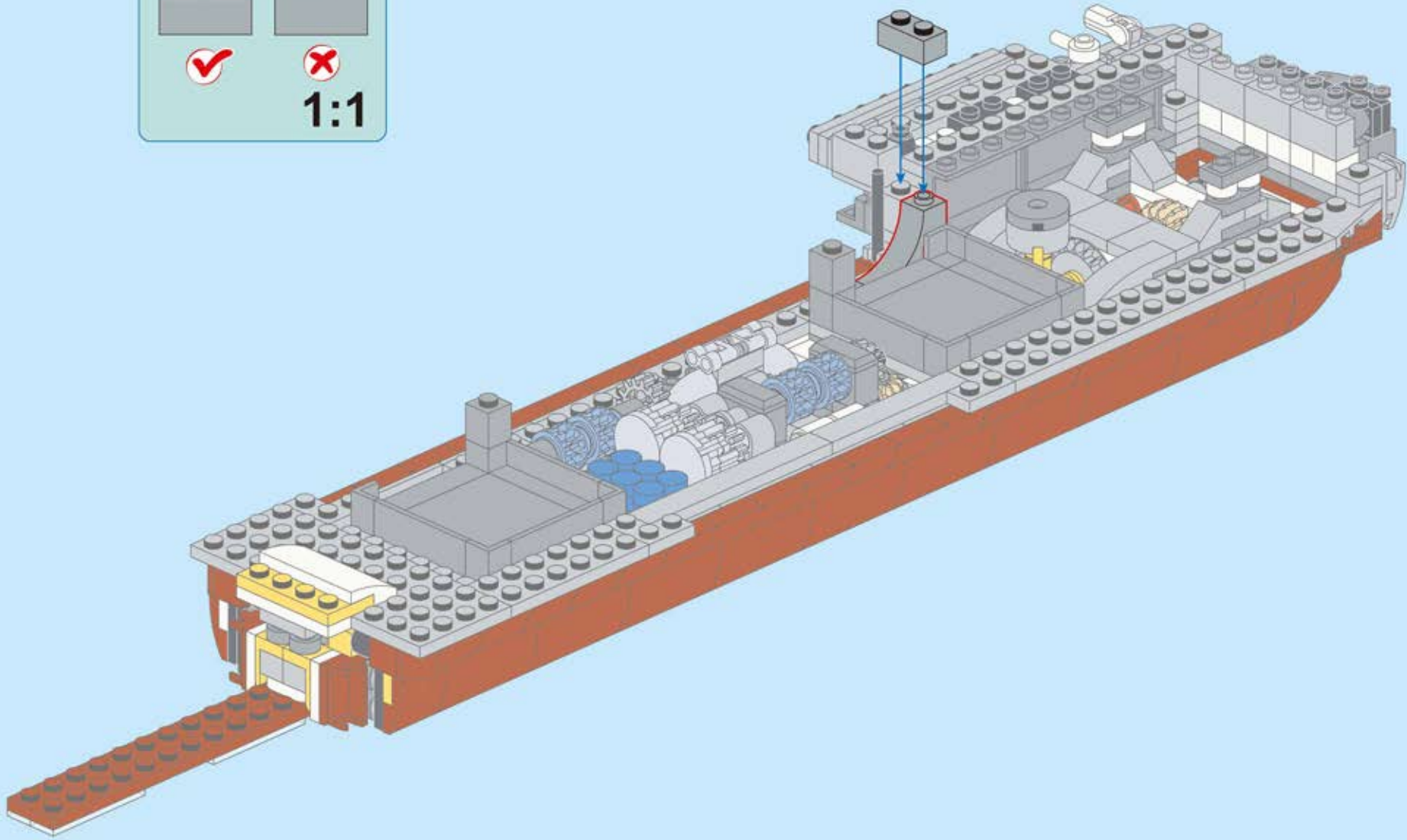
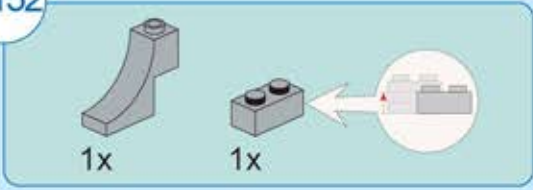

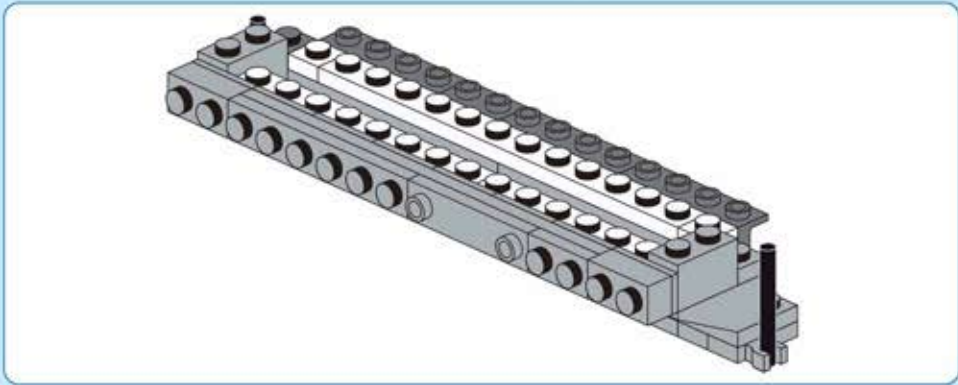

B153

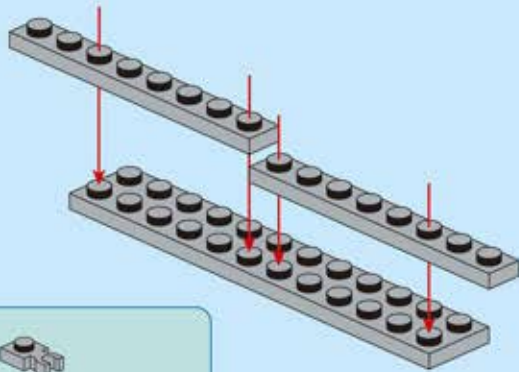
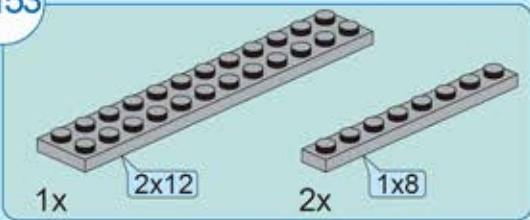

B154

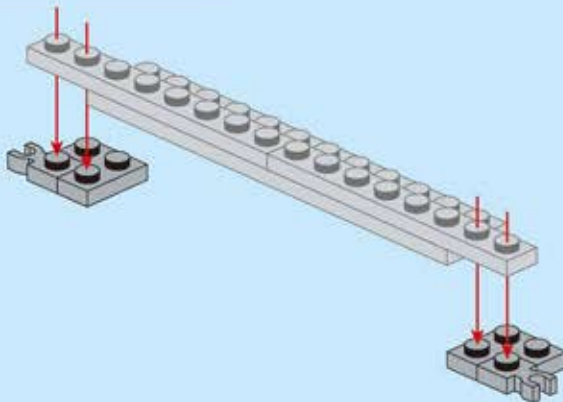

B155

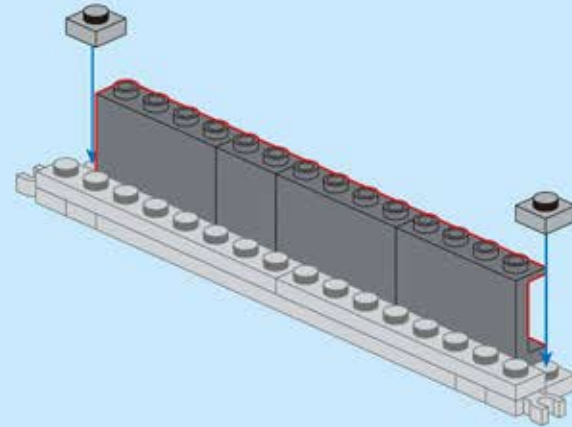
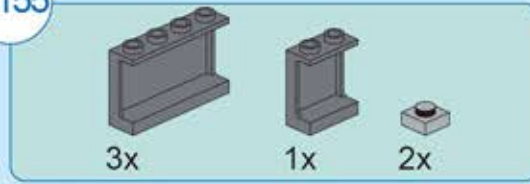

B156

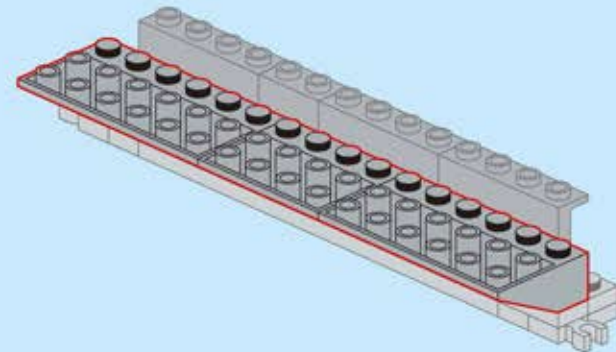
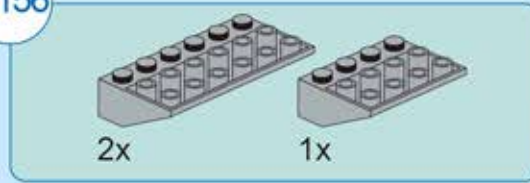

B157

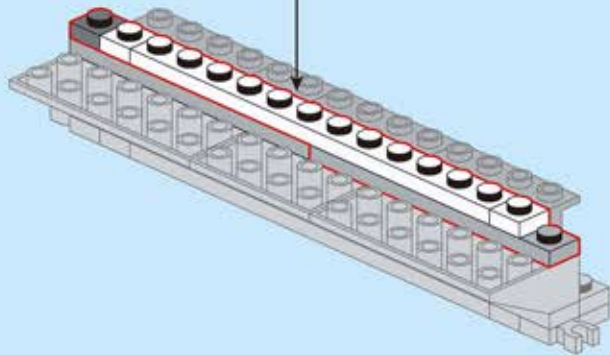
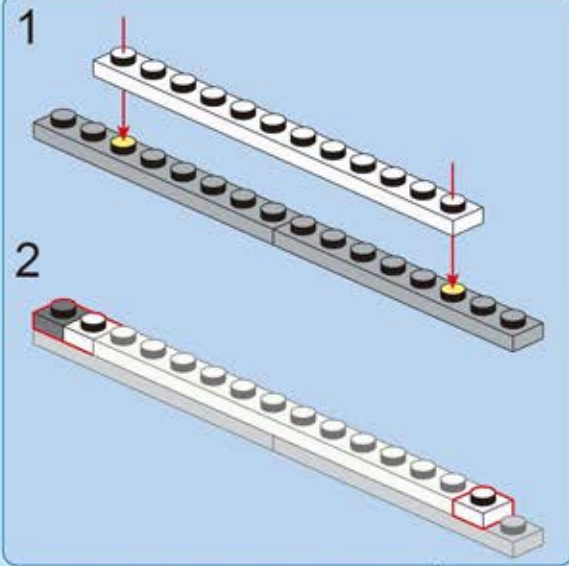
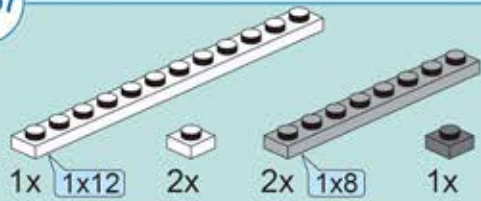

B158

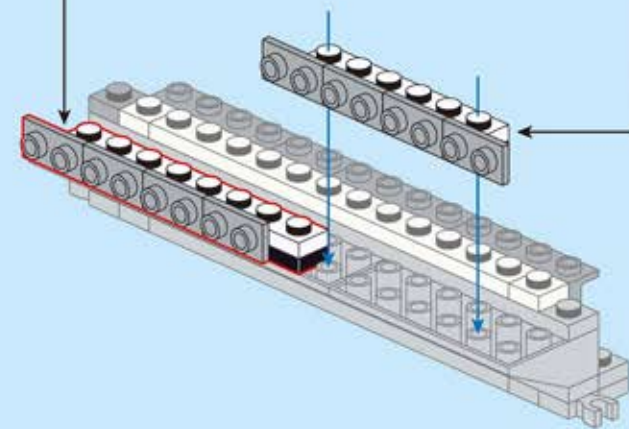
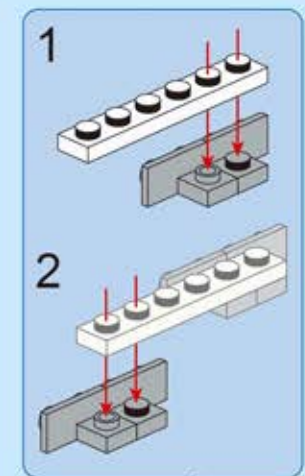
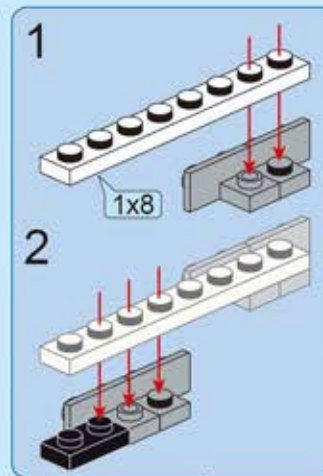
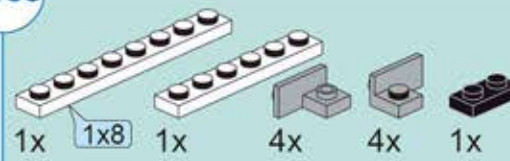

B159



2x

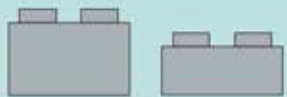

1:1

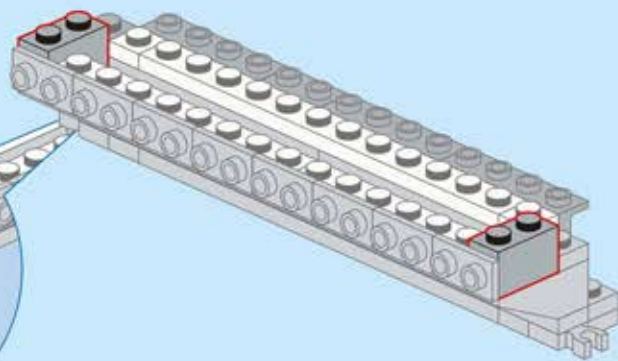
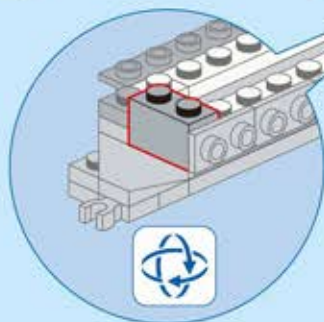

B160

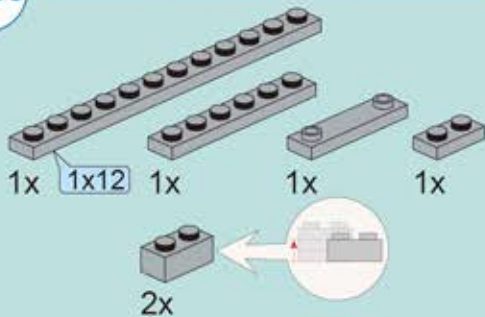

2x



1:1

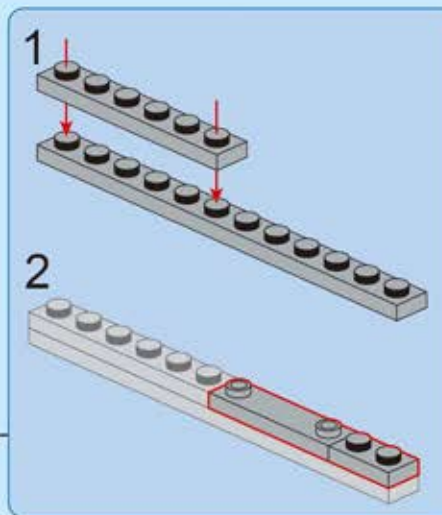
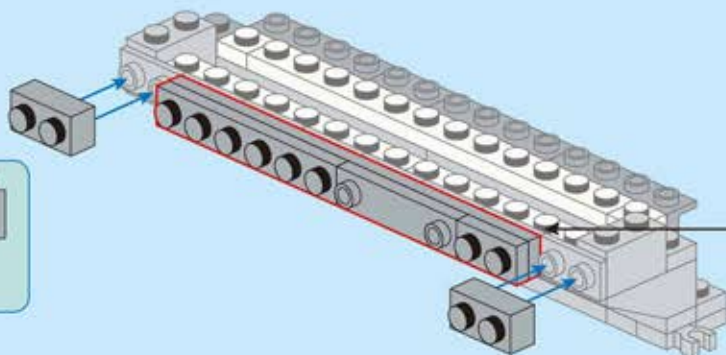

B161



2x

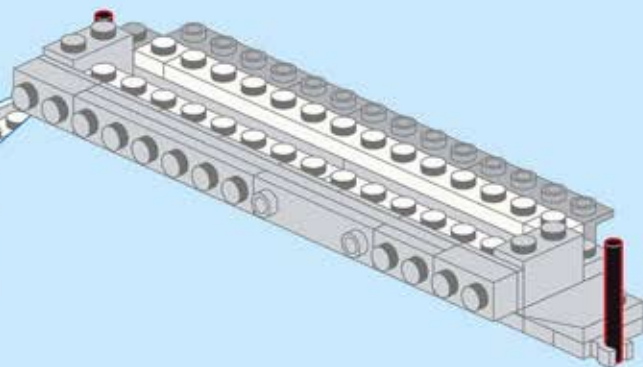
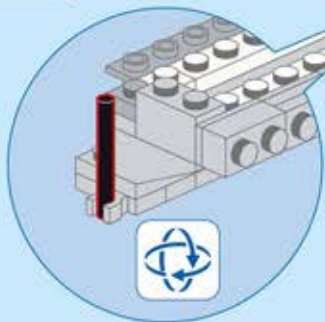

B162

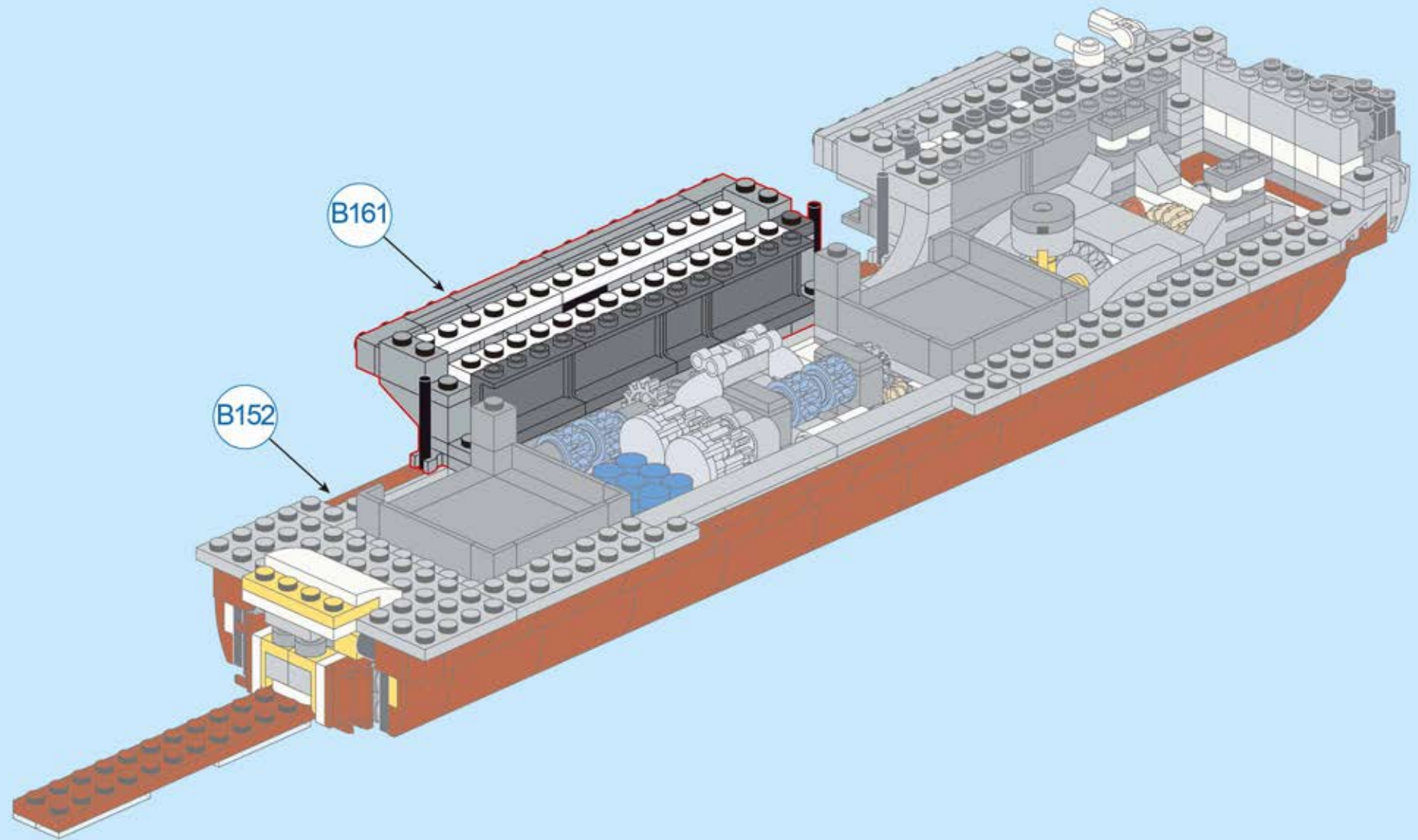

B163

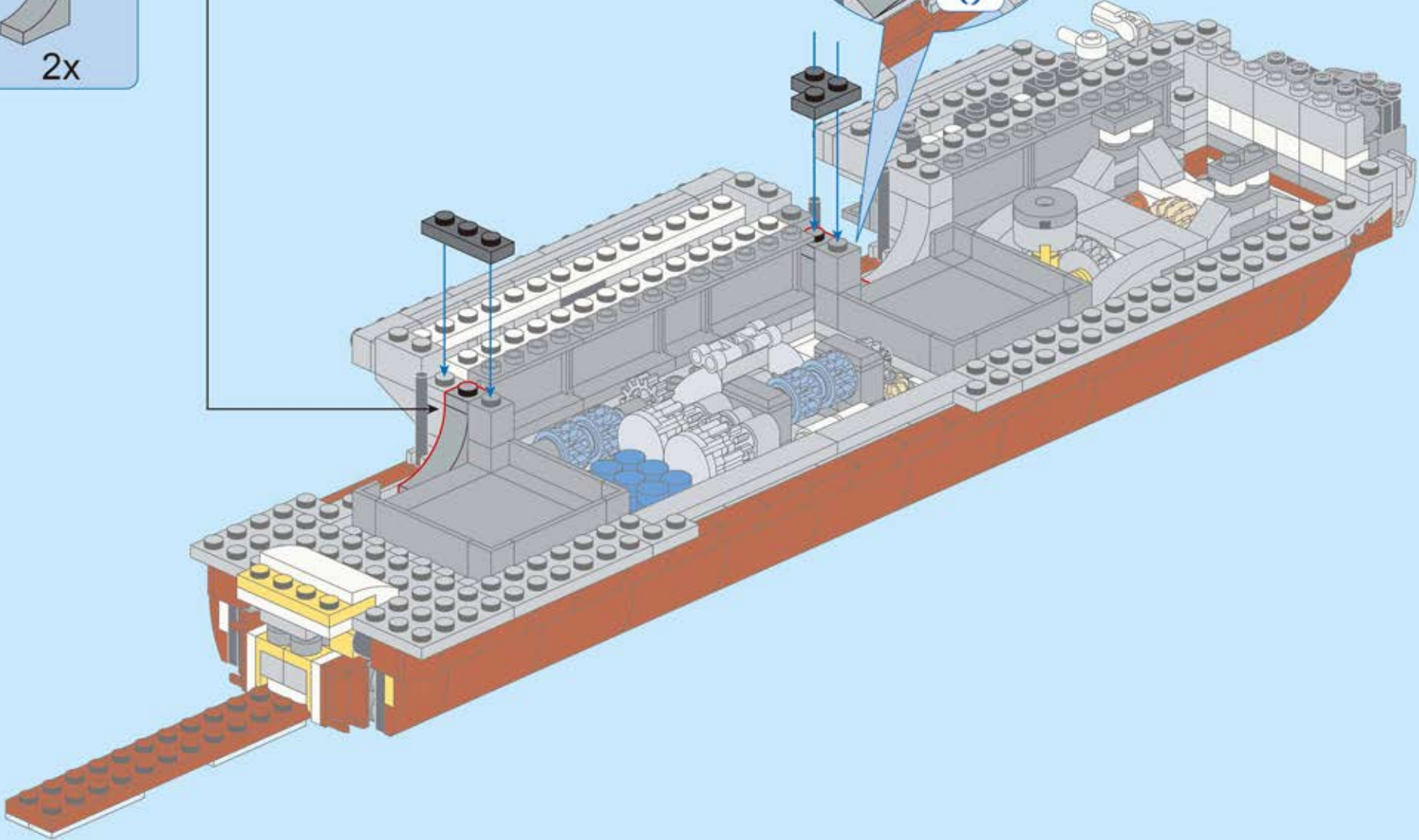
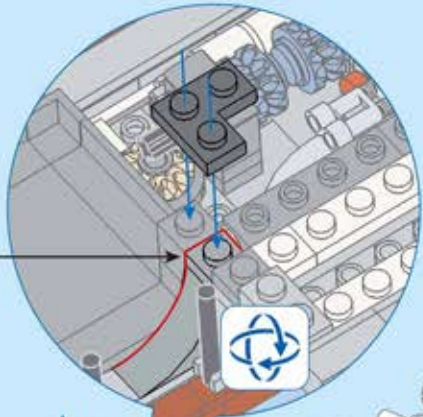
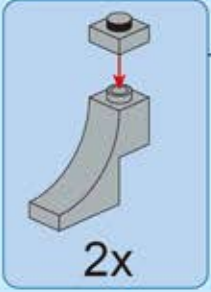
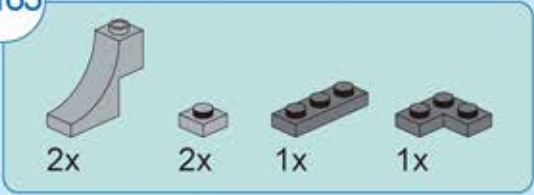

B164

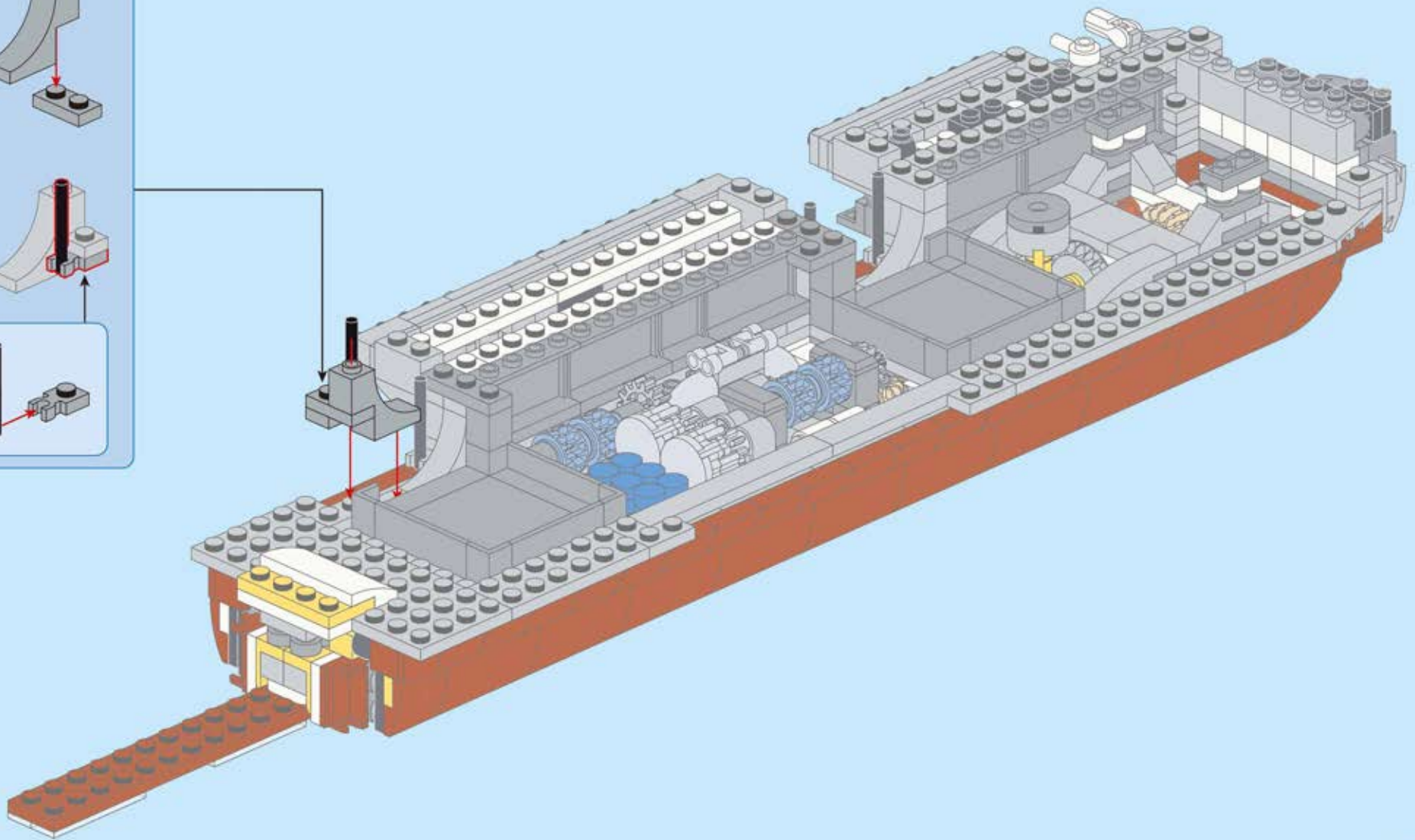
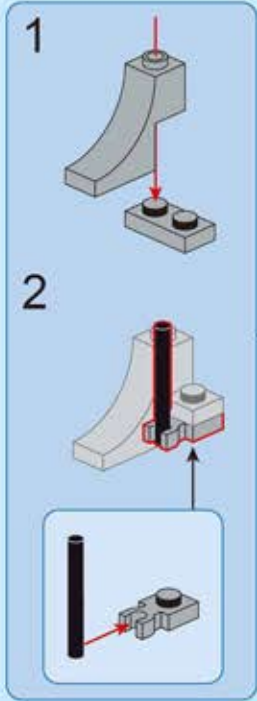
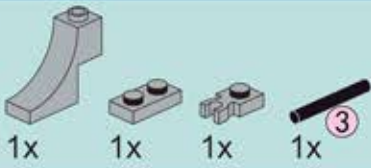

B166



1x



1x



1x

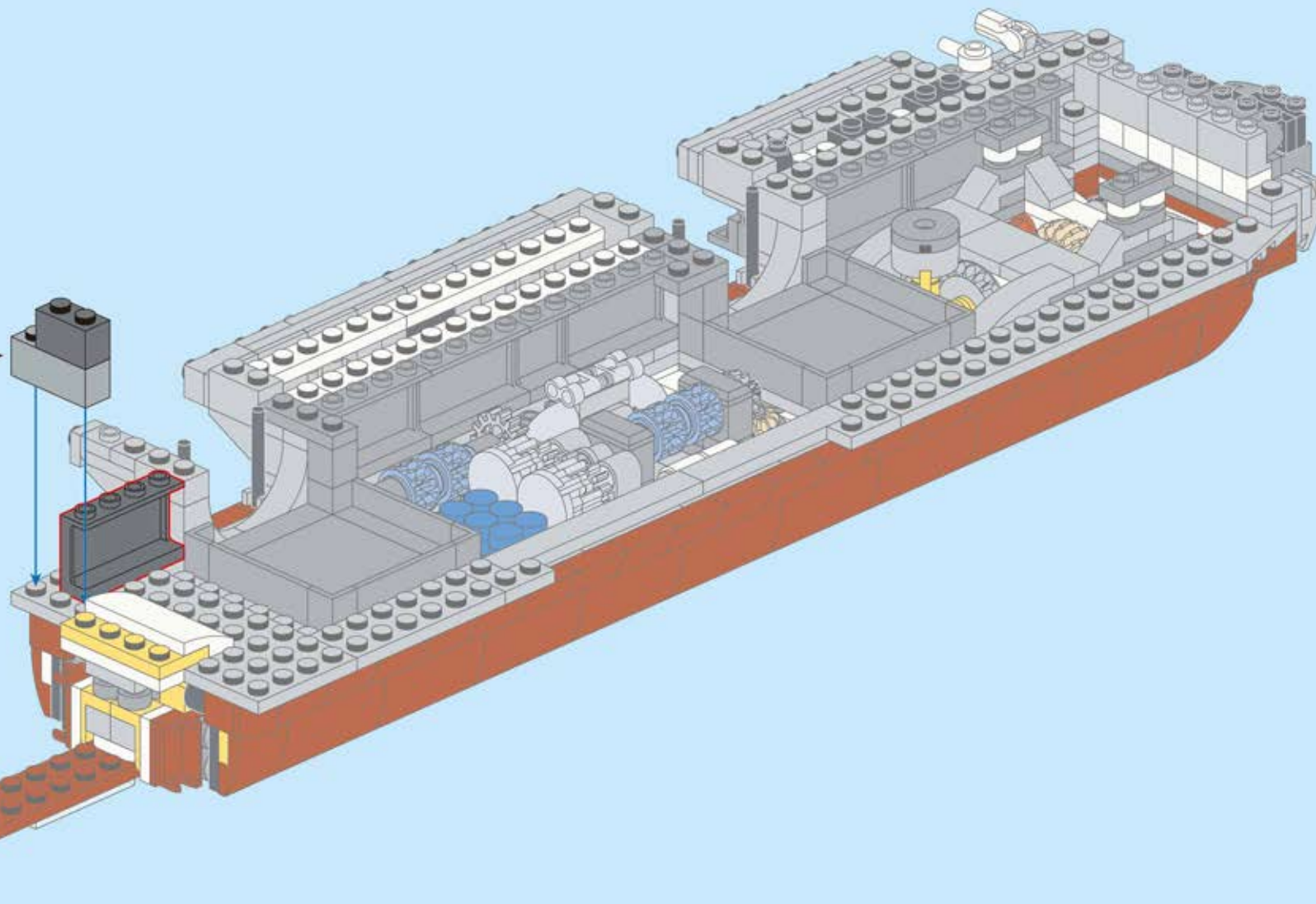
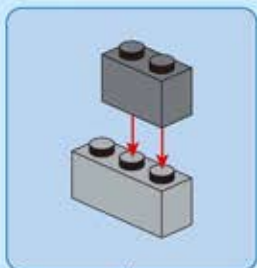

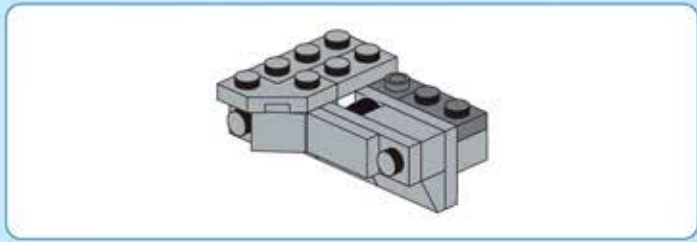

B167

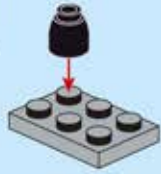

B168

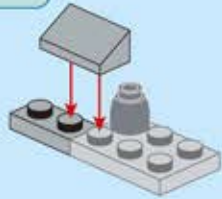

B169

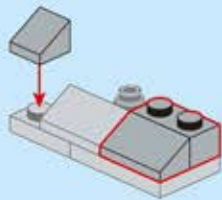
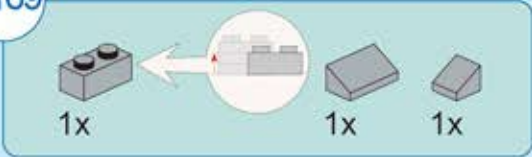

B170

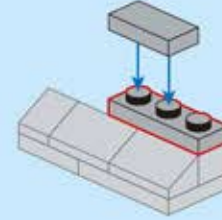
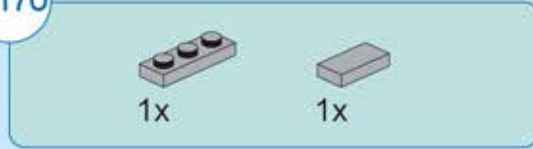

B171

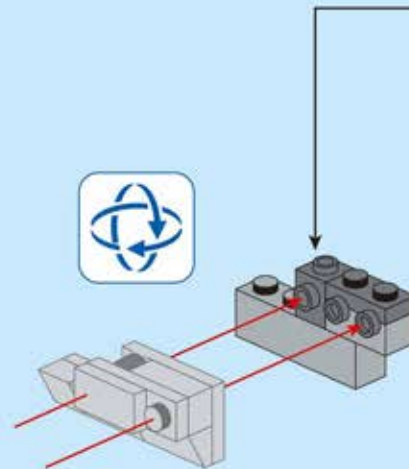
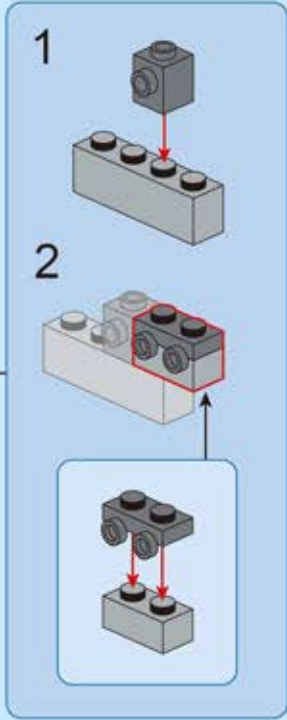
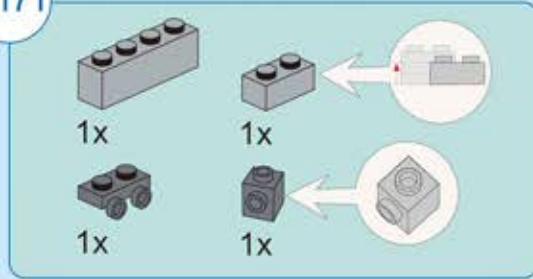



B172

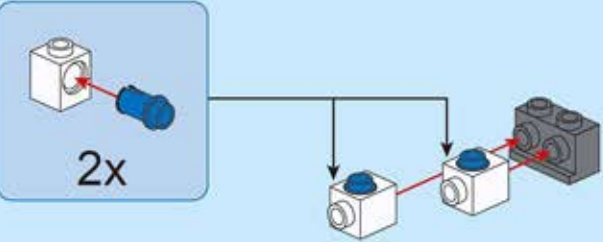

B173

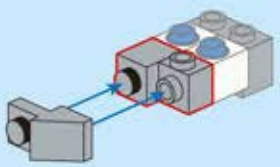
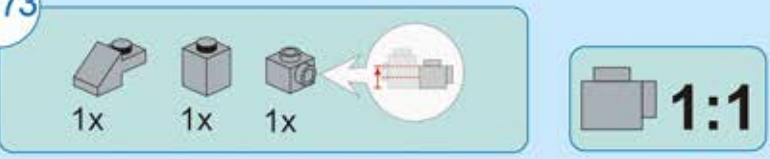

B174

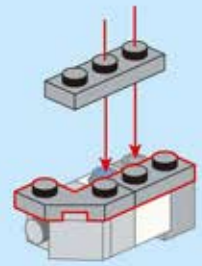
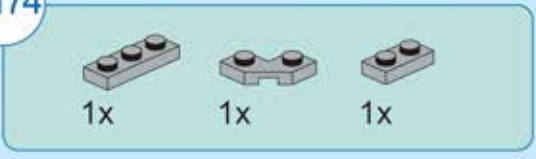

B175

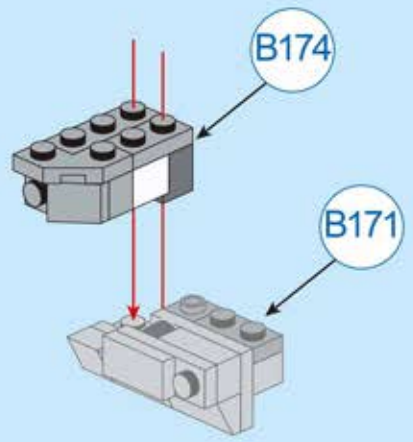

B176



1x

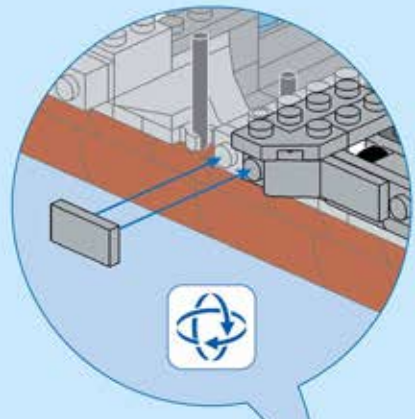

B166

B175

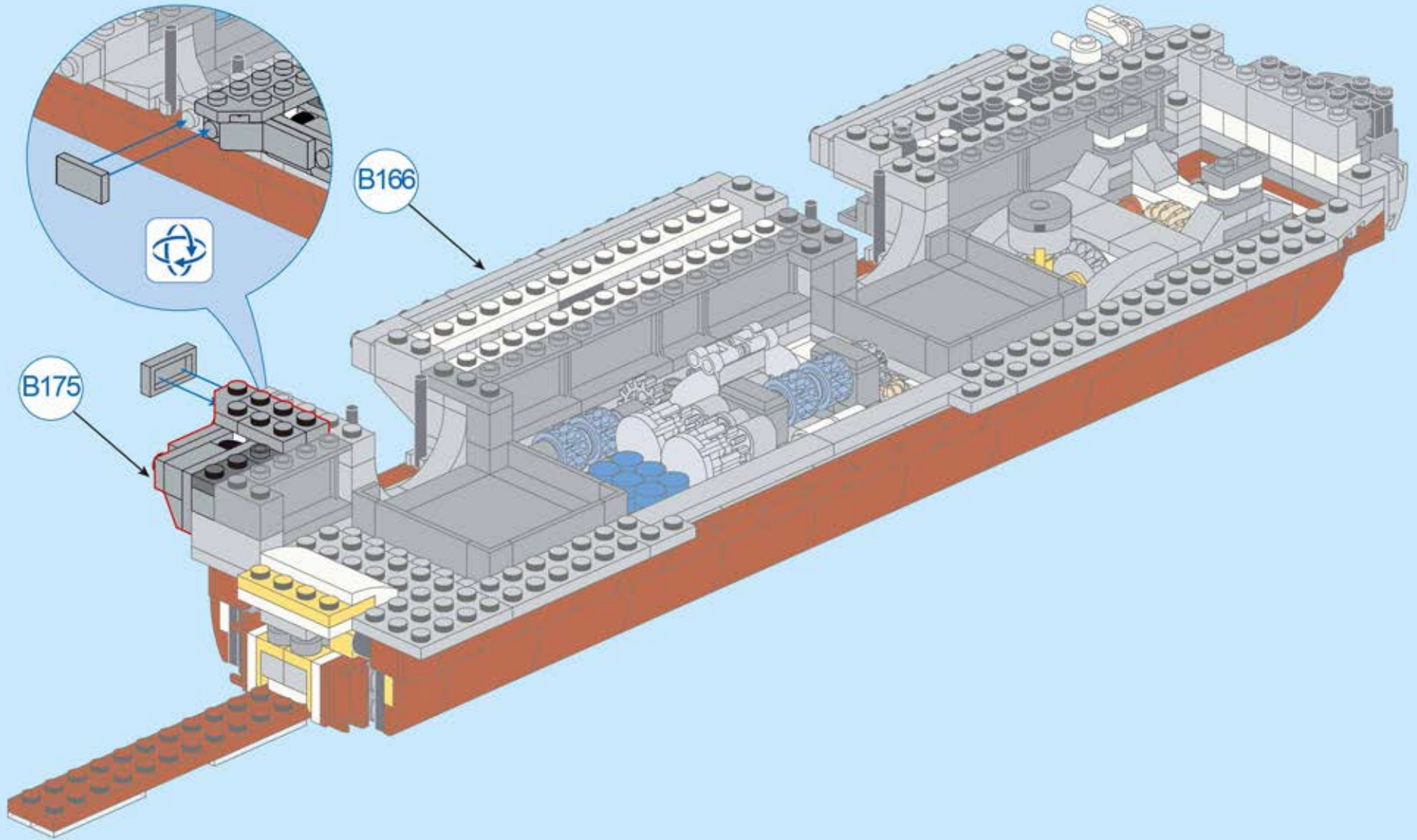

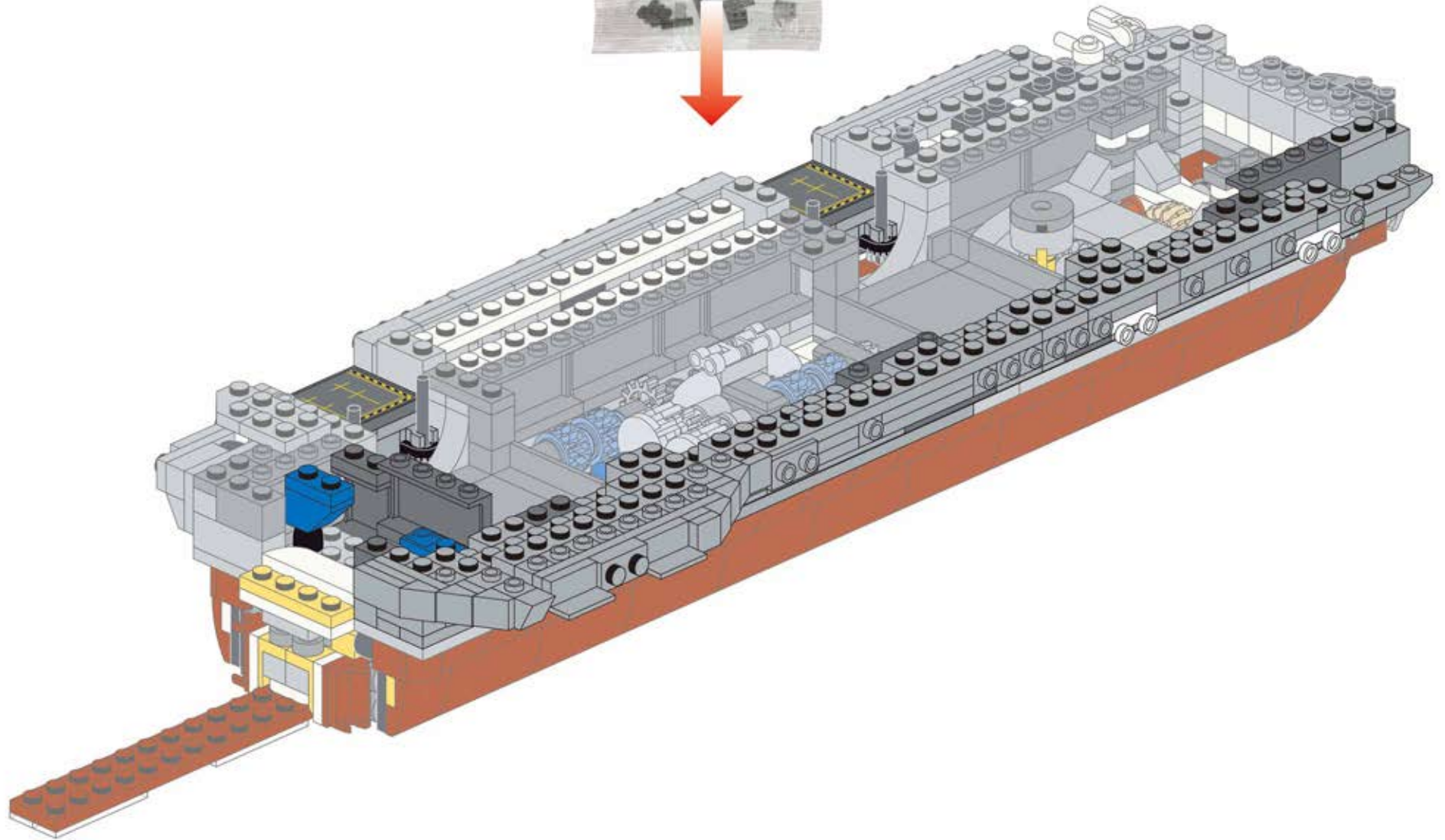

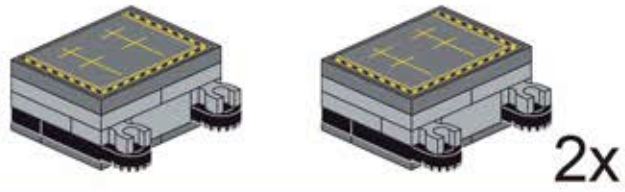

B177

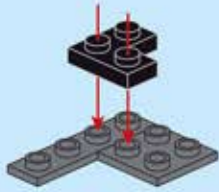

B178



B179

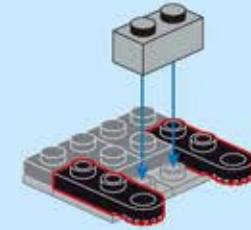
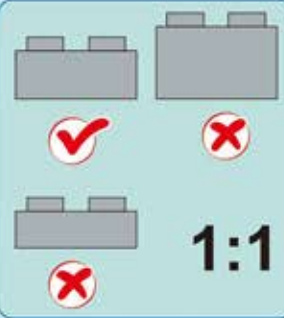
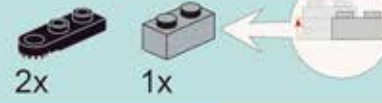

B180

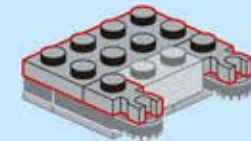

B181

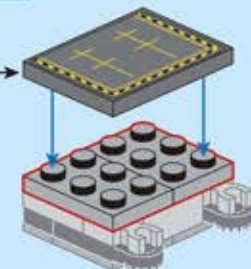
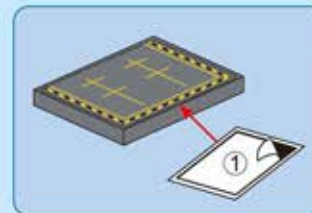
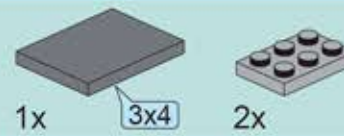

B182

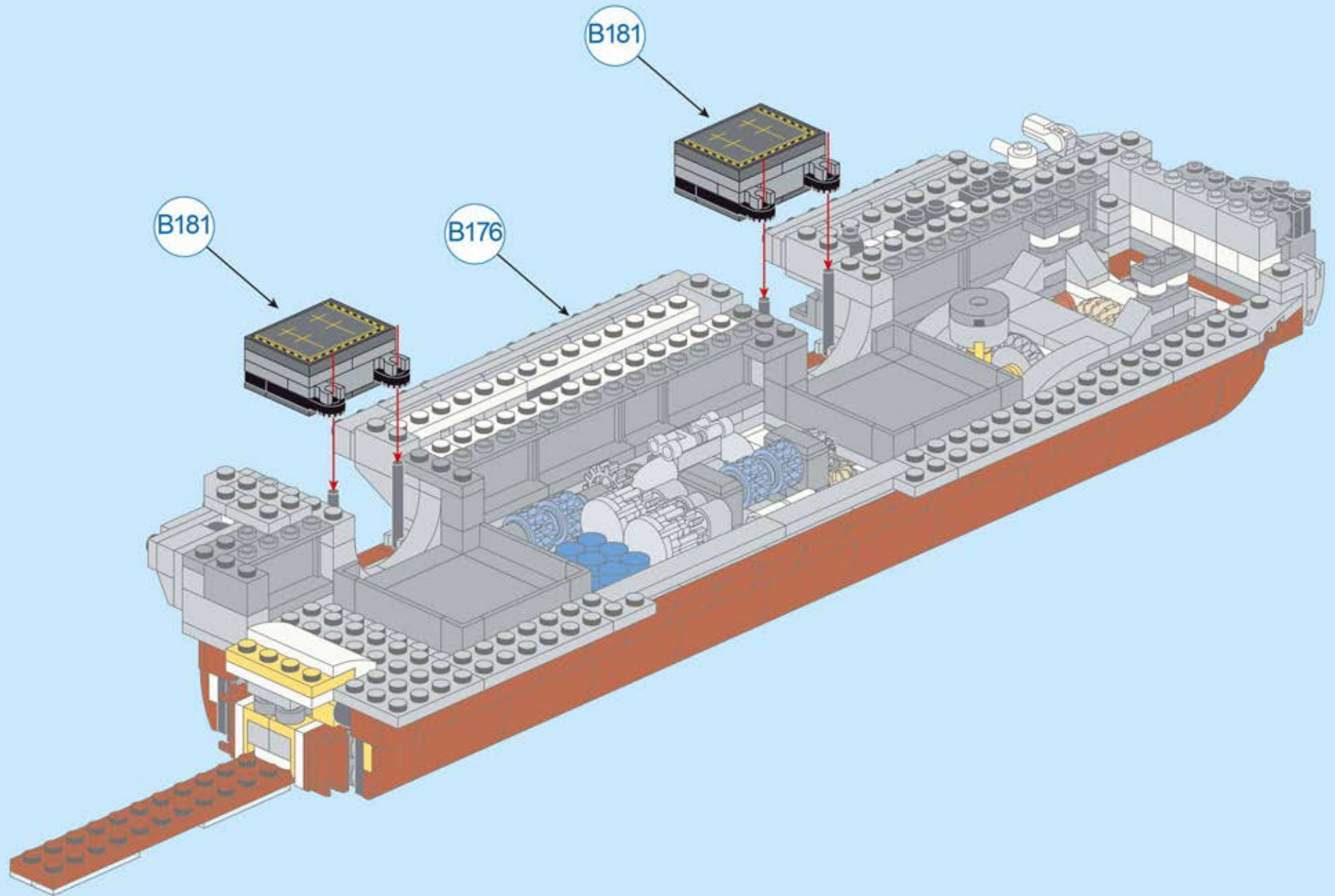

B183

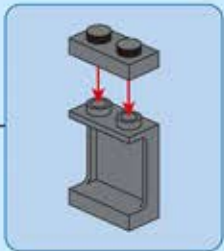
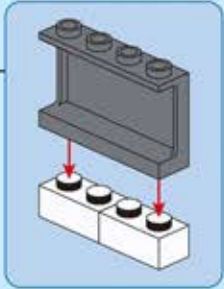
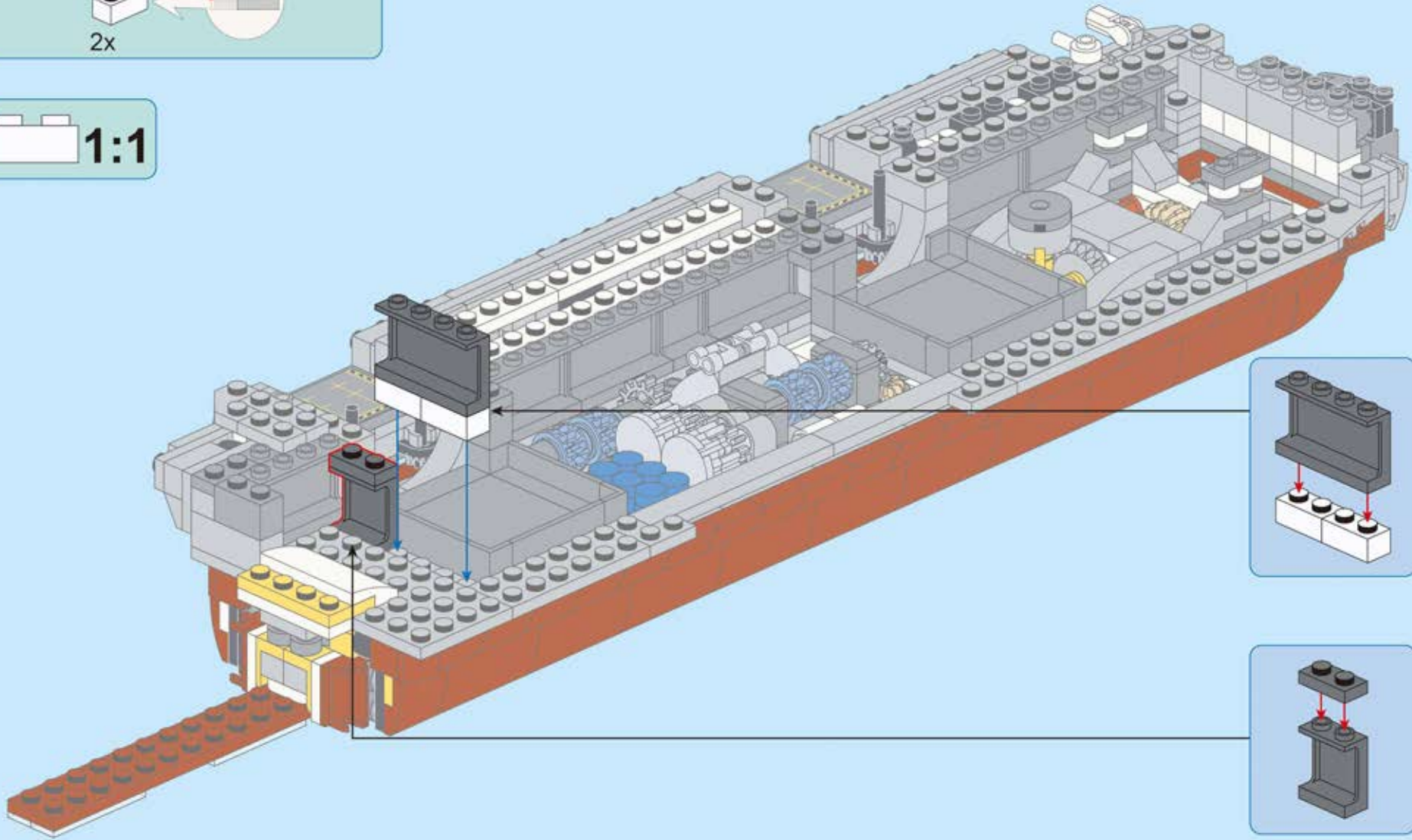
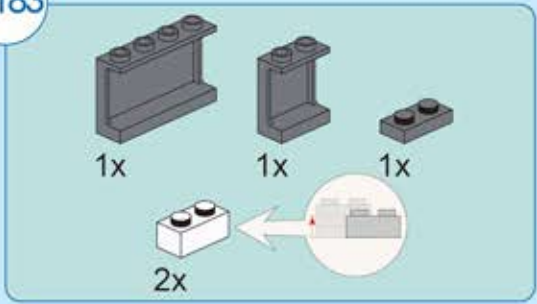

B184



2x



1x



2x



1x



1x

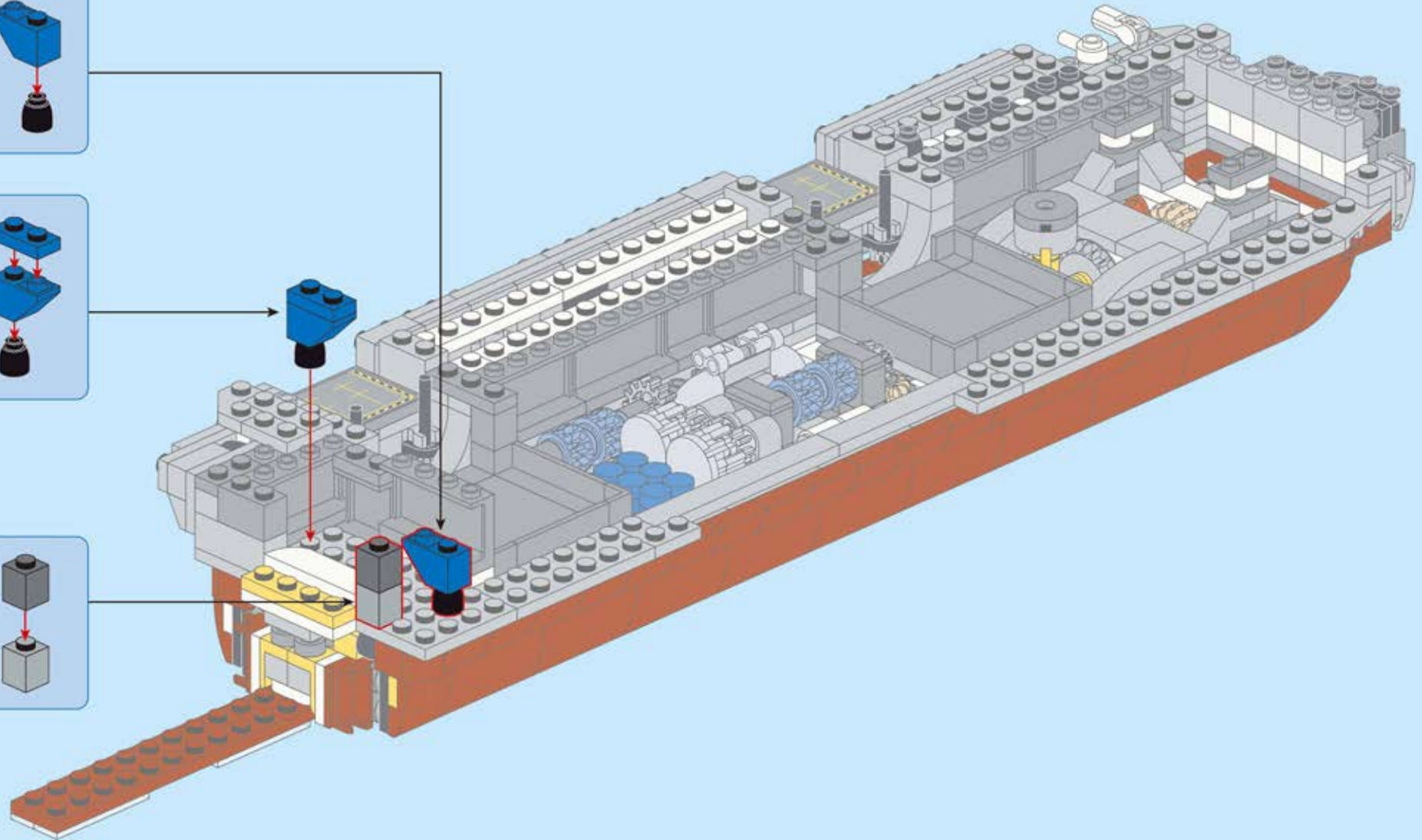
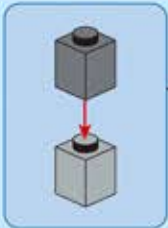
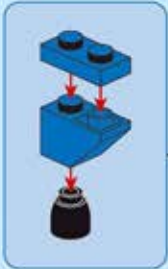

B185



1x



2x

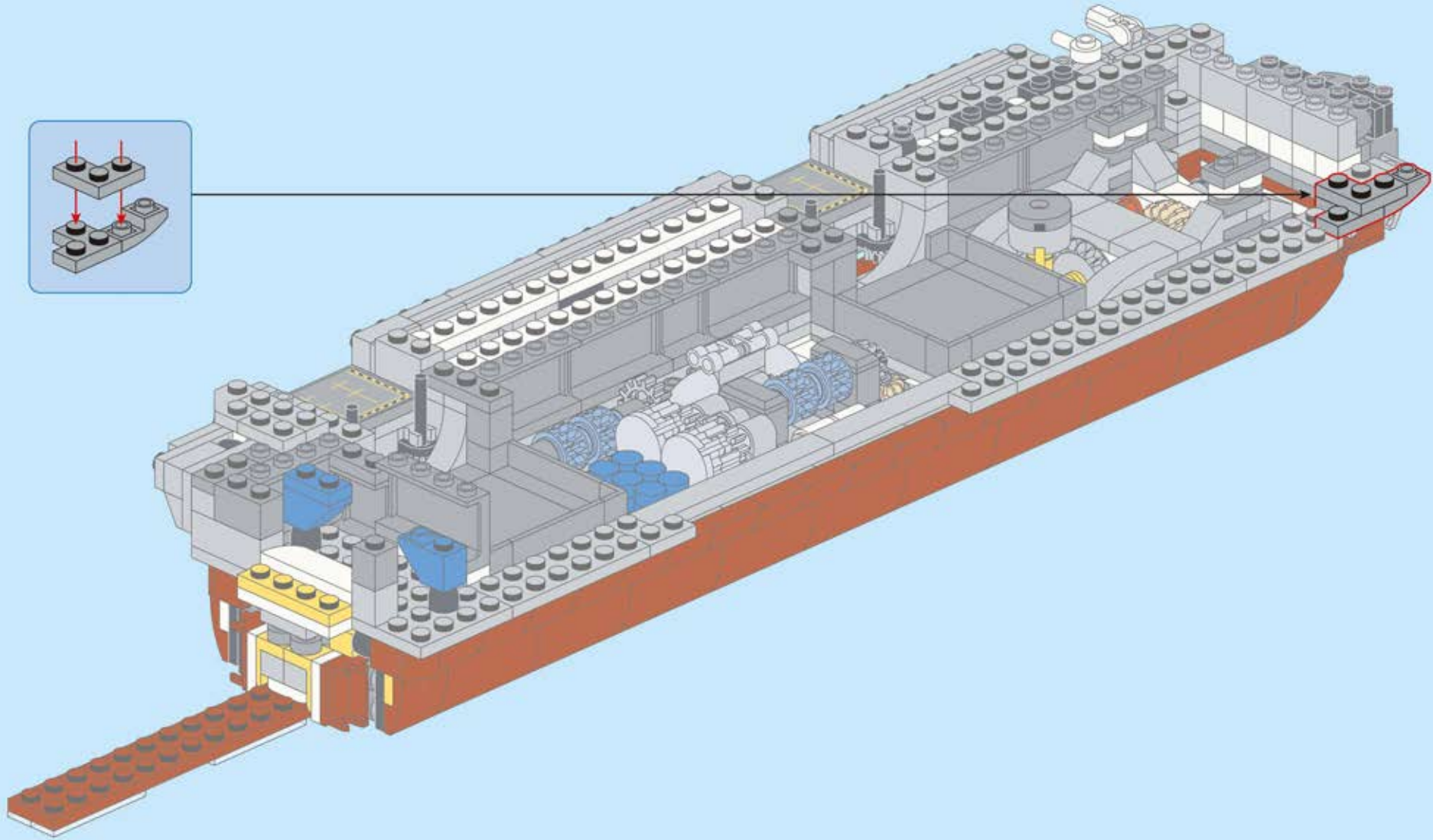
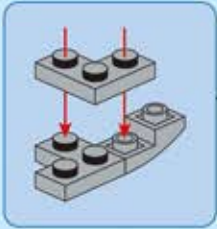

B186



1x



1x



1x

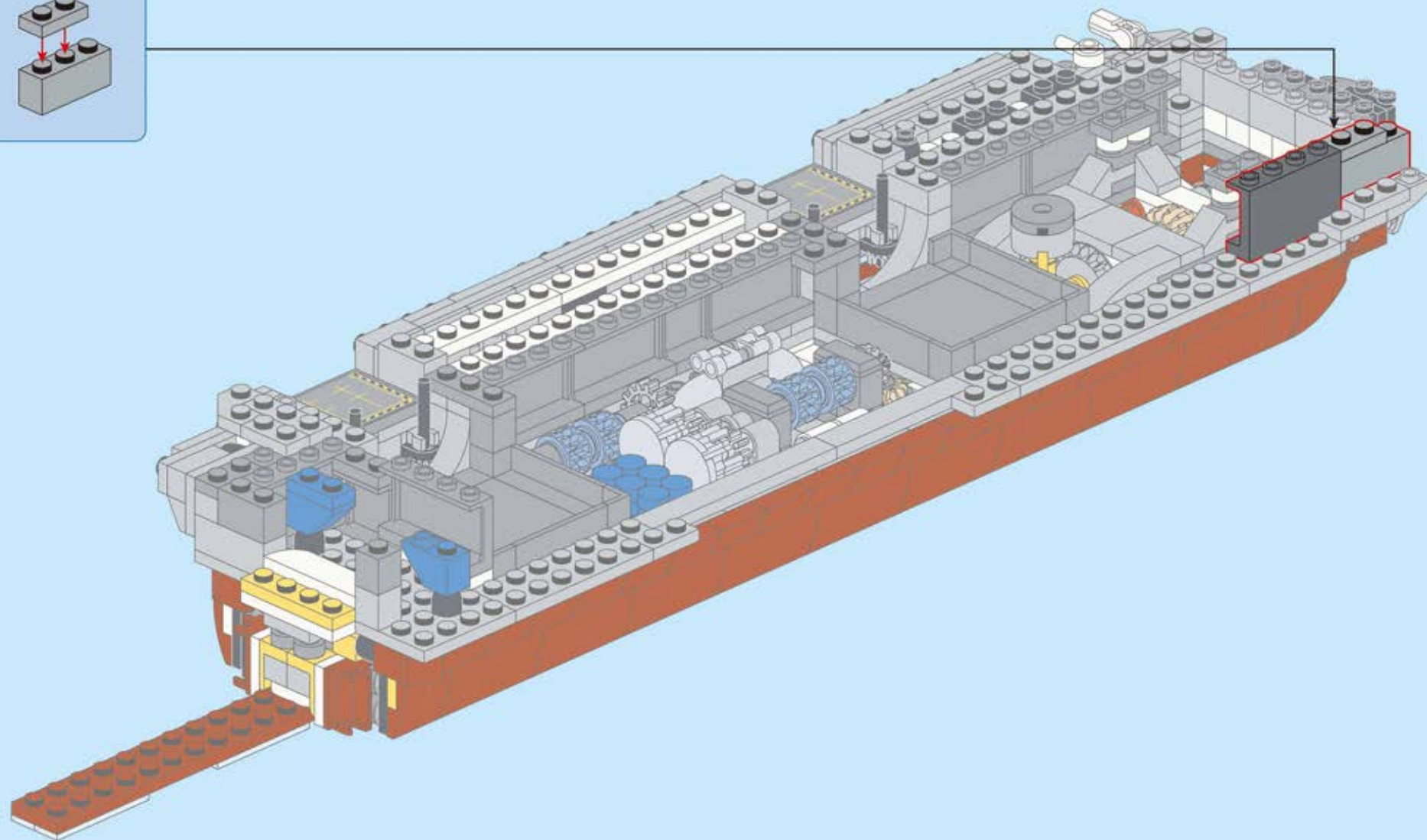
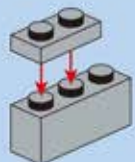

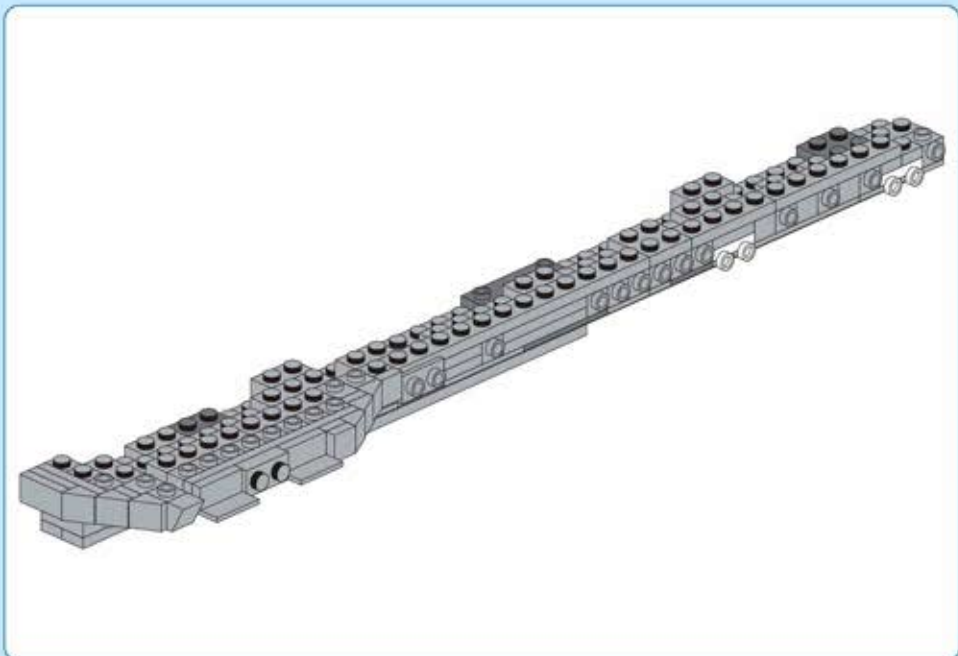

B187

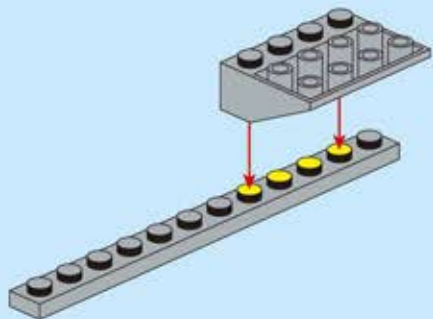
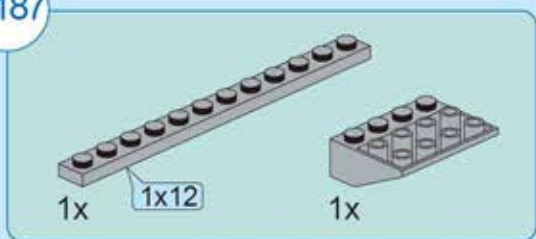

B188

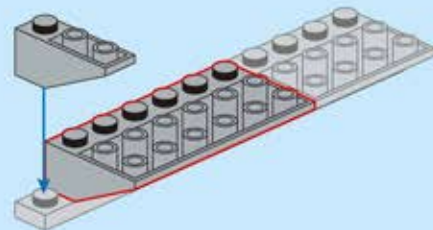

B189

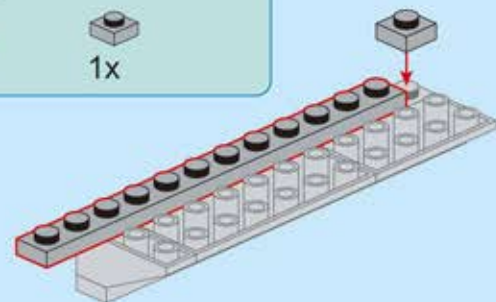
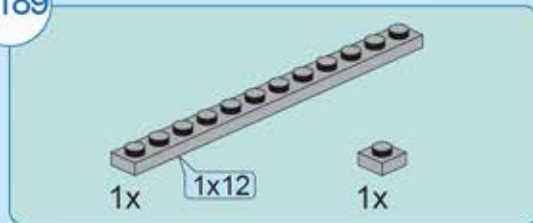

B190

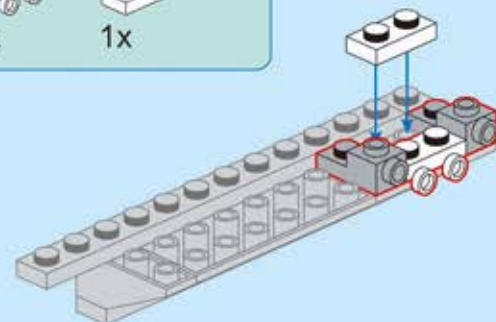
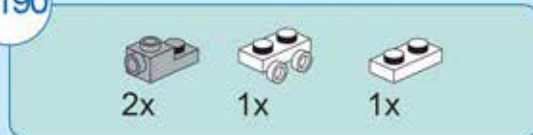

B191

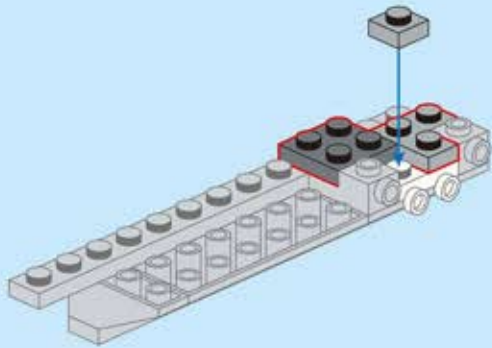
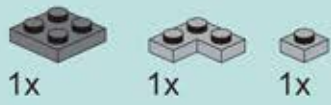

B193

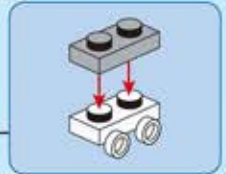
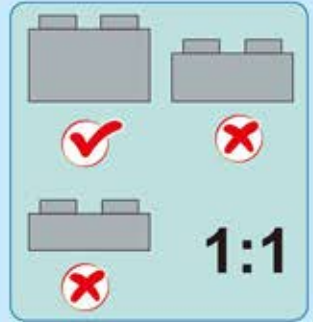
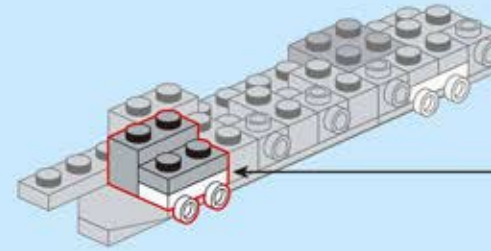
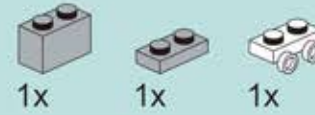

B192

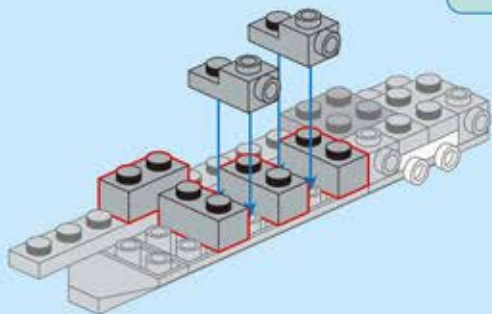
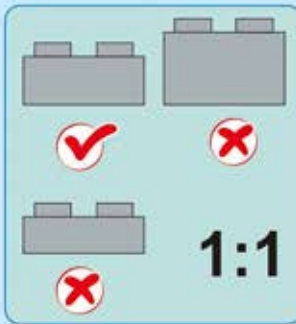

B194

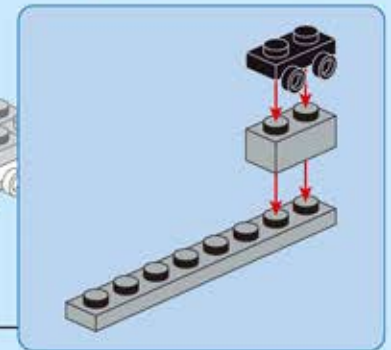
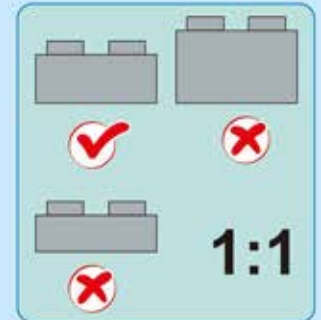
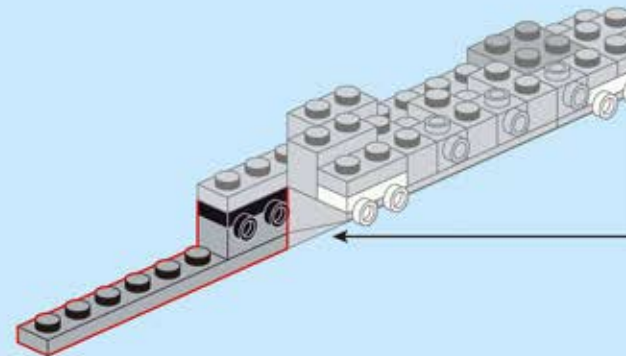
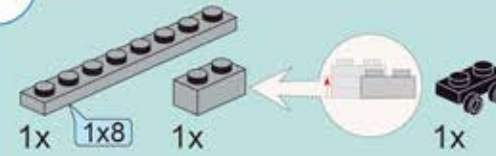

B195

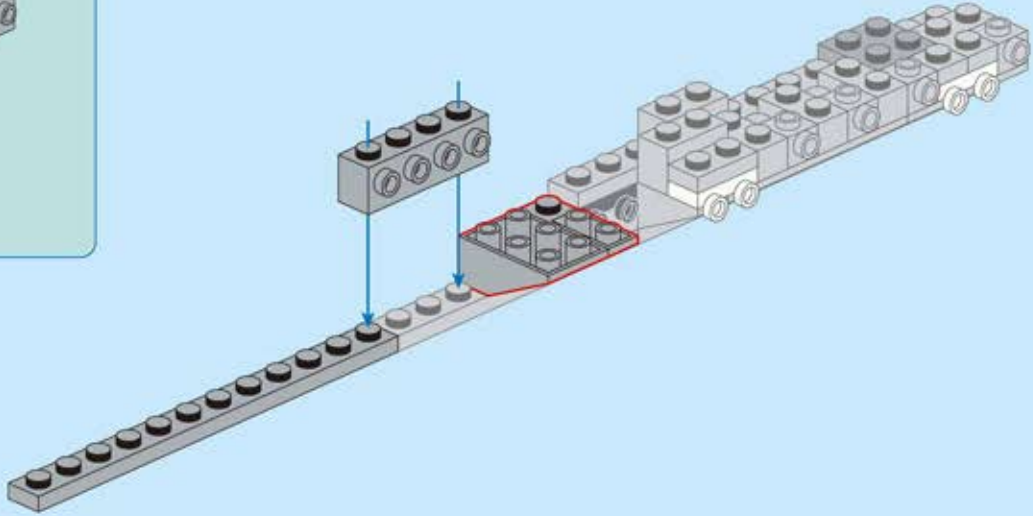
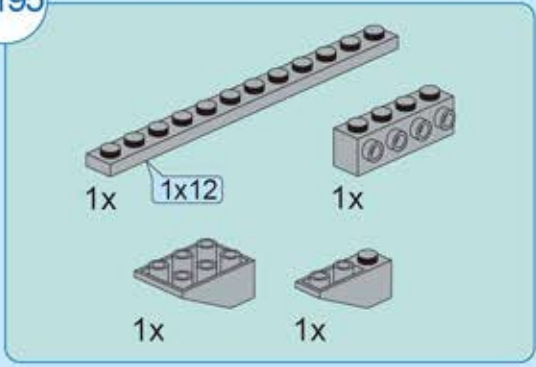

B196

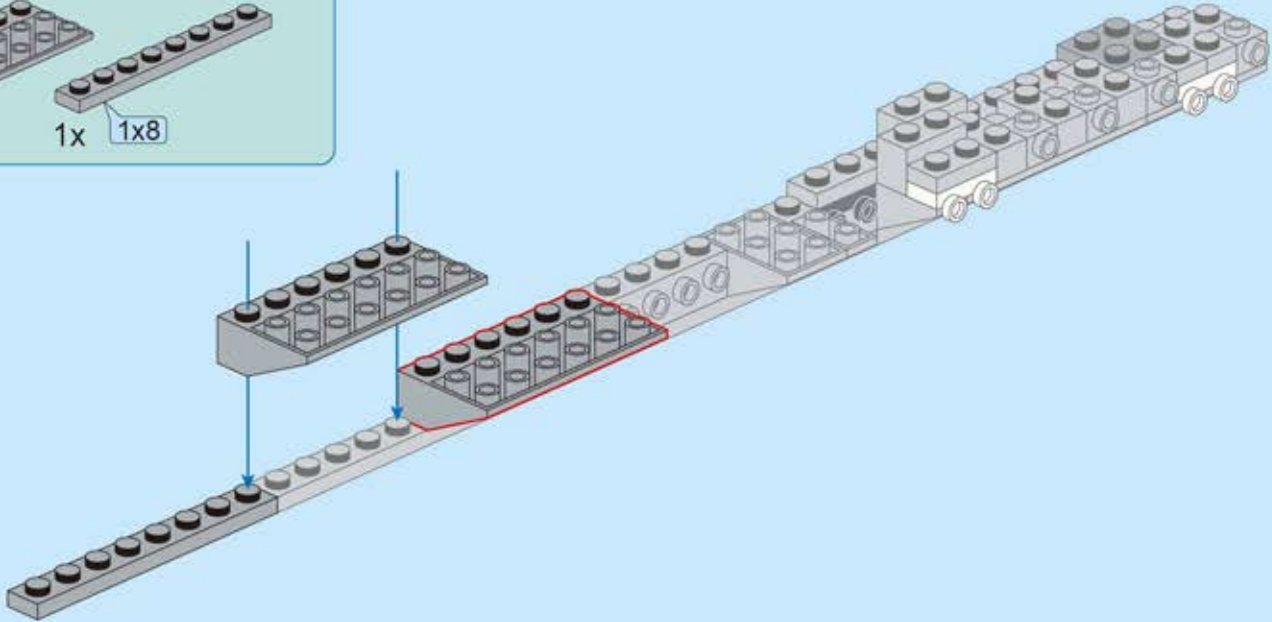
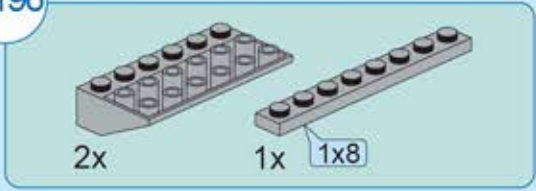

B197

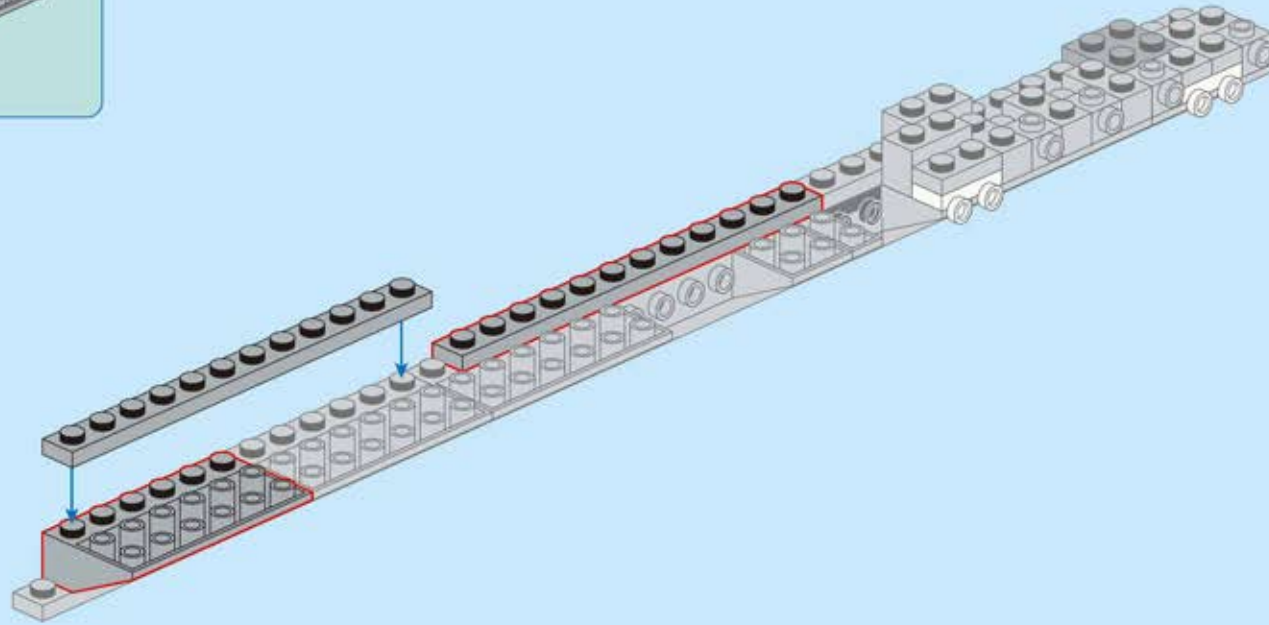
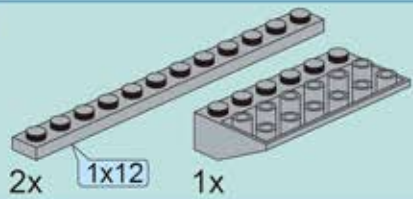

B198

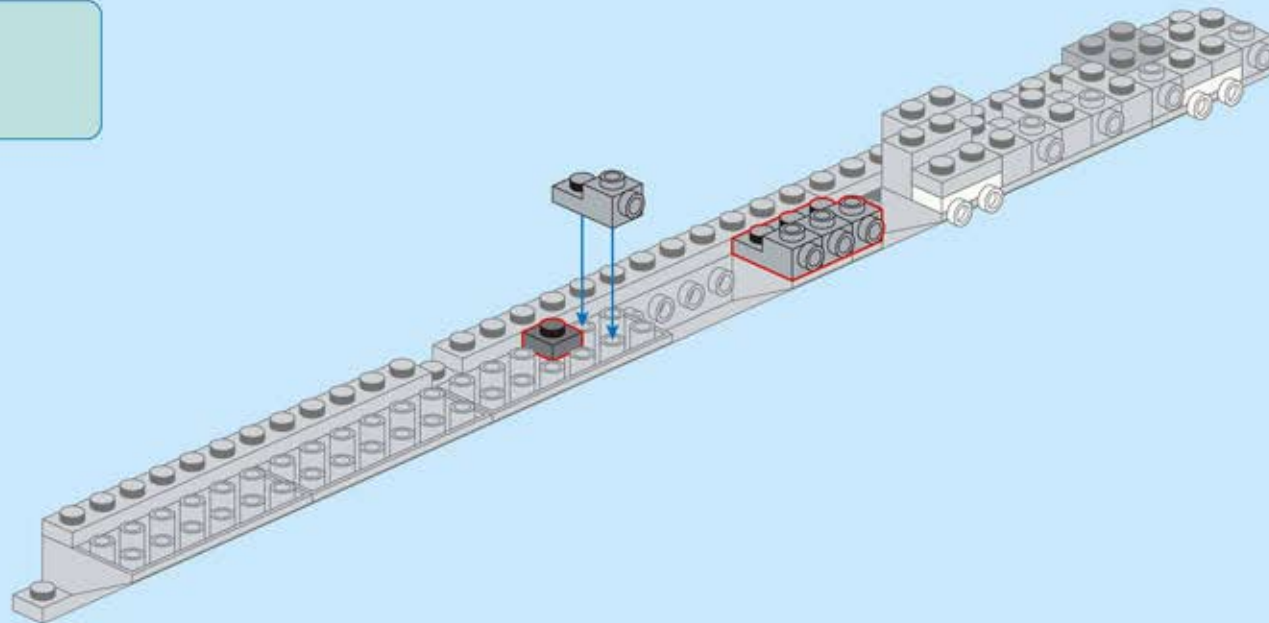

B199

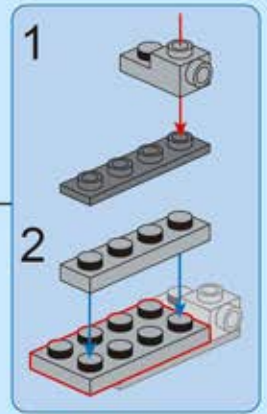
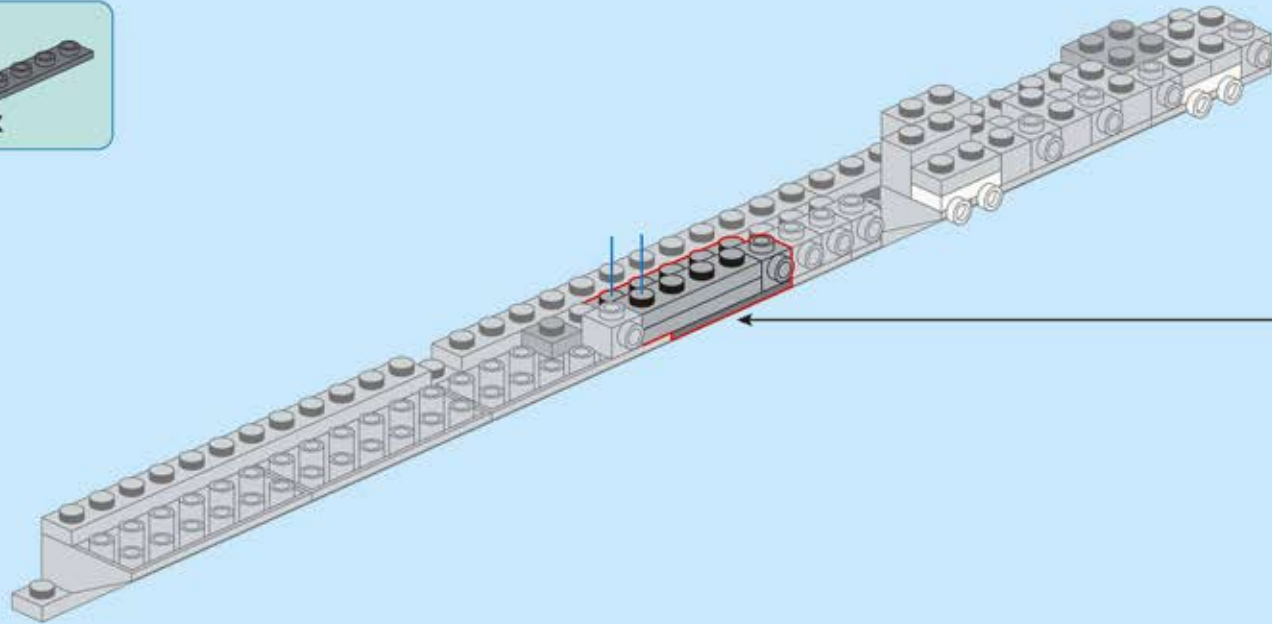
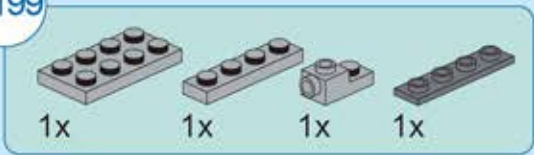

B200

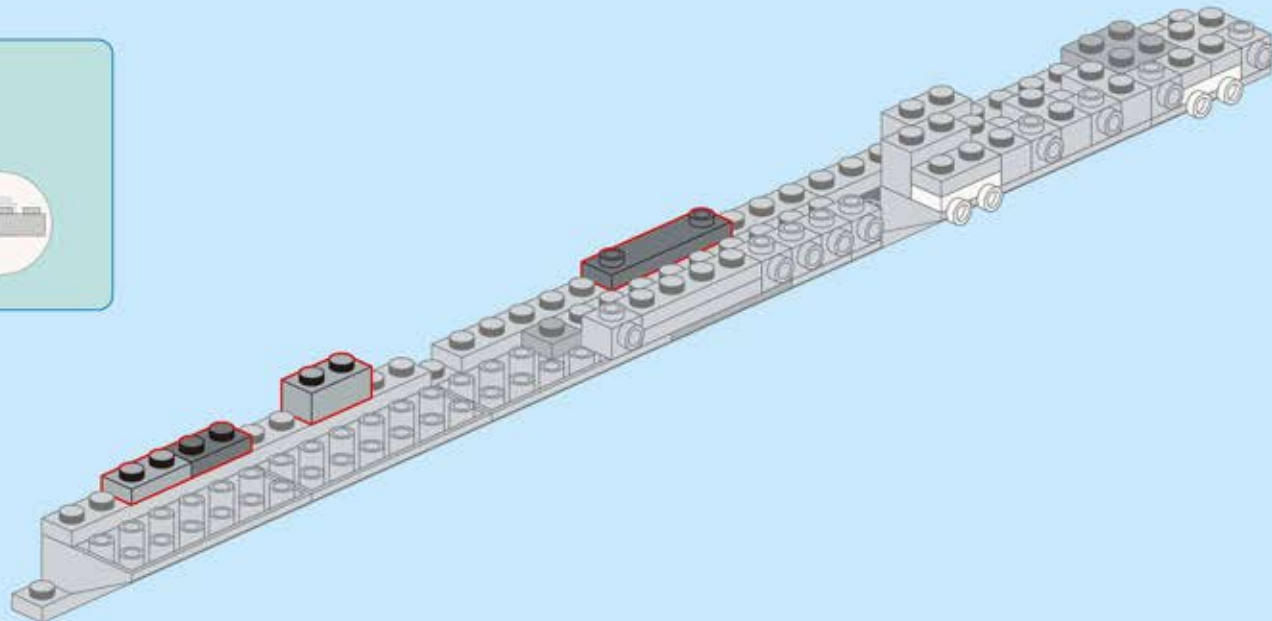
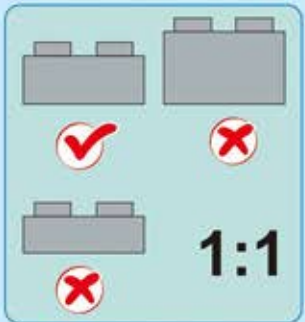
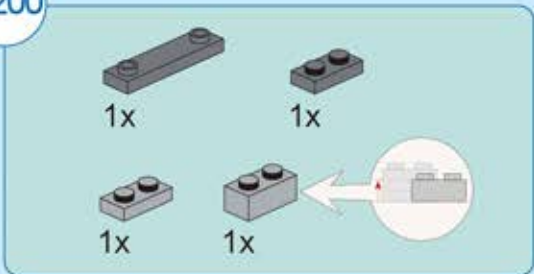

B201

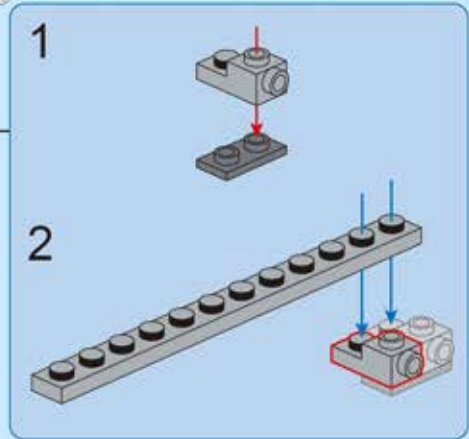
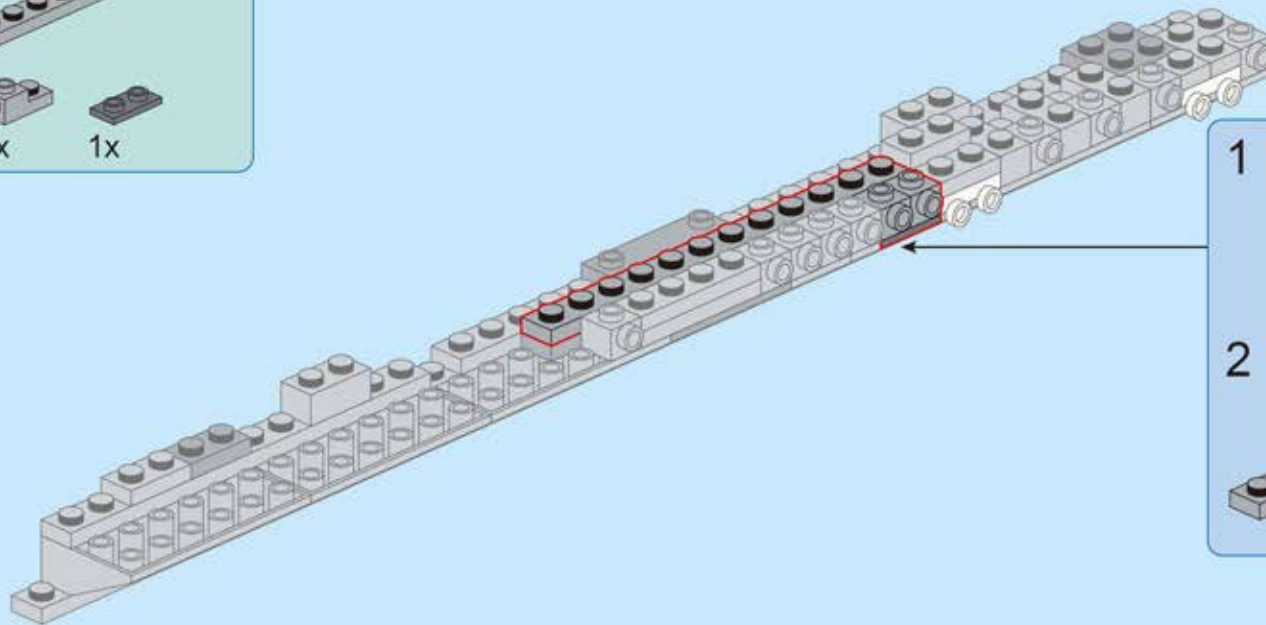
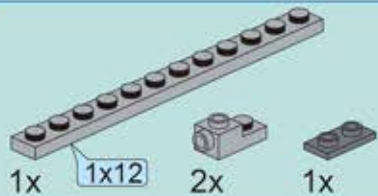

B202

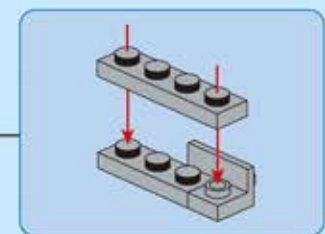
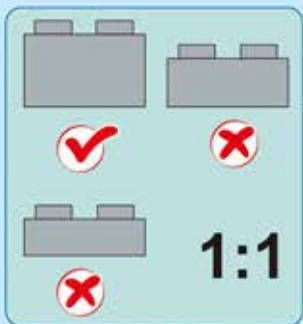
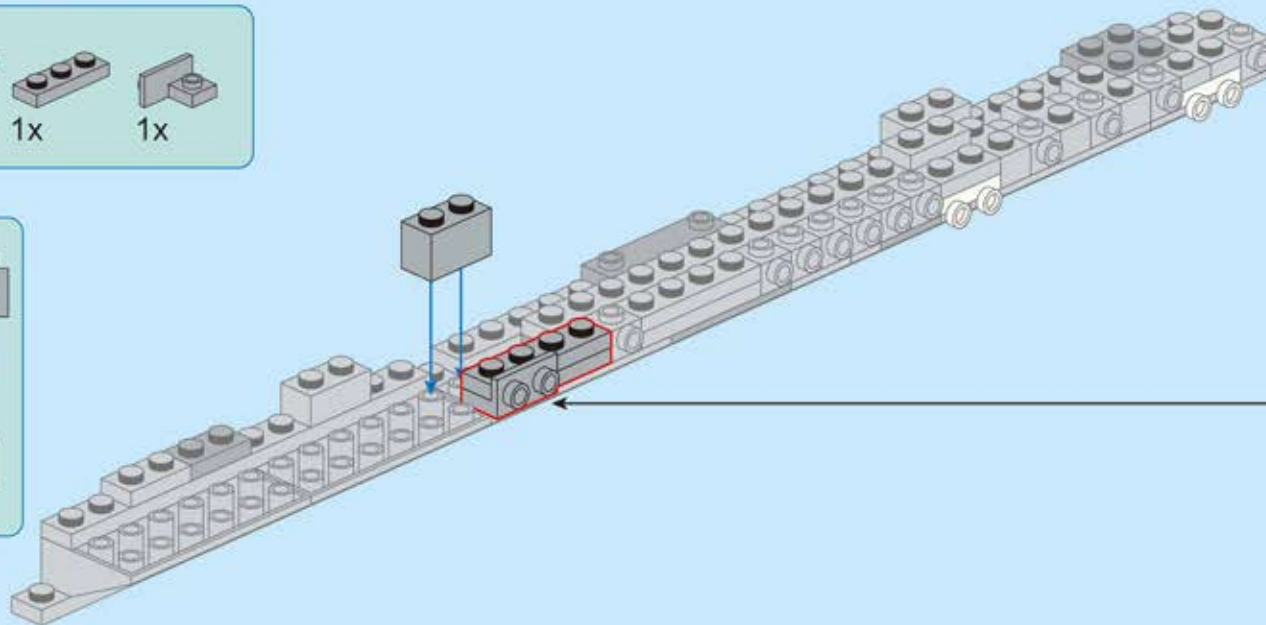
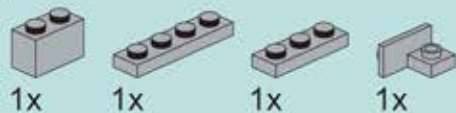

B203

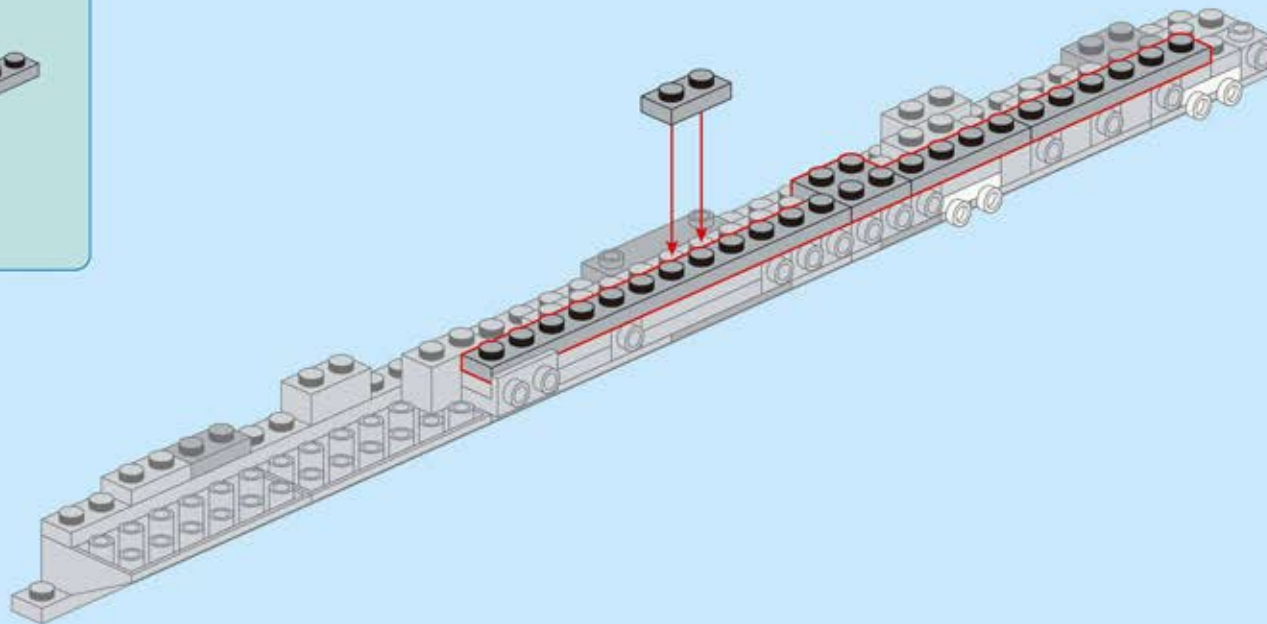
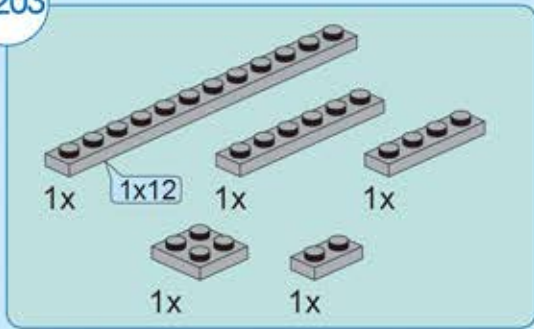

B204

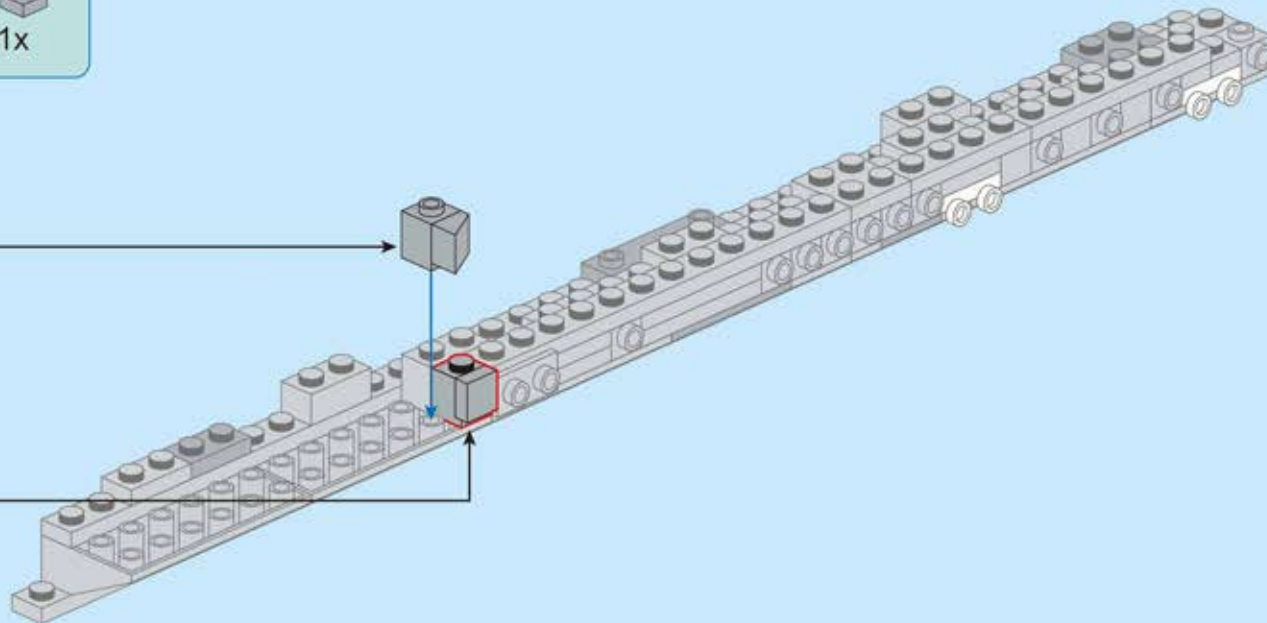
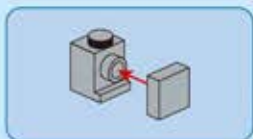
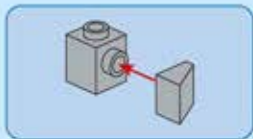

B205

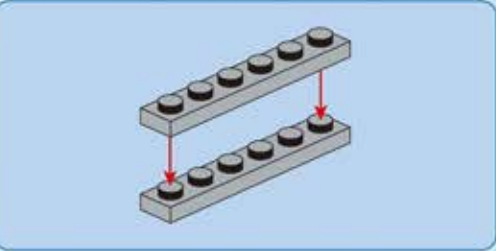
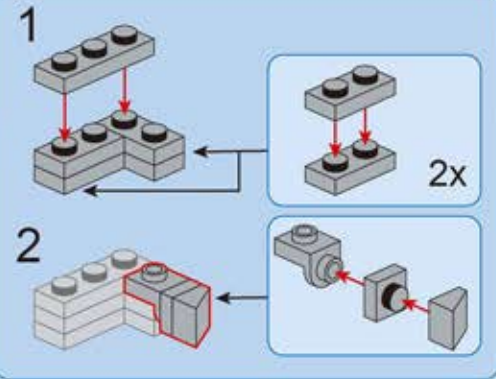
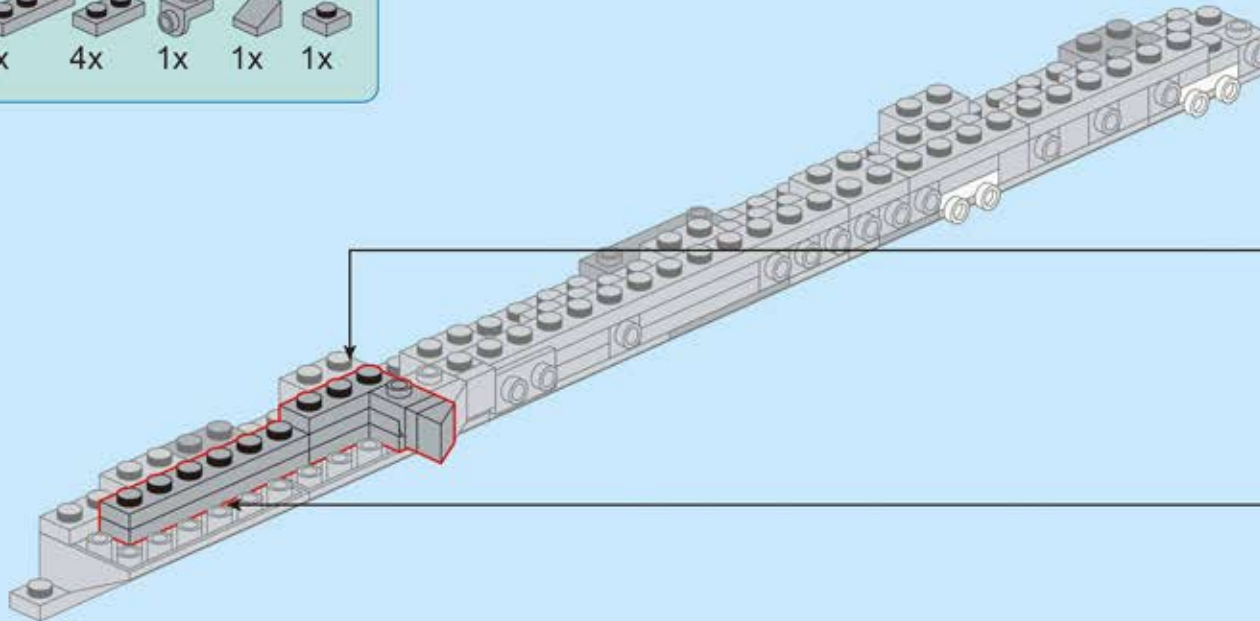
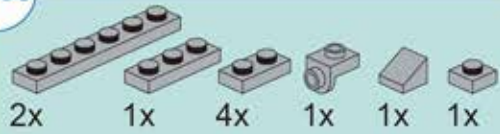

B206

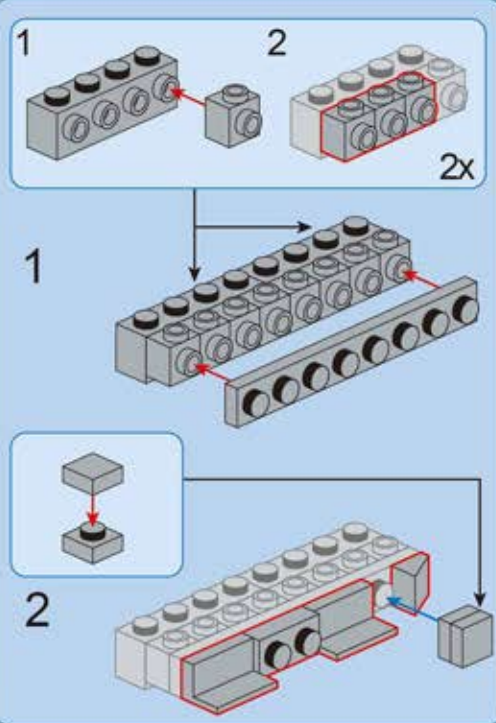
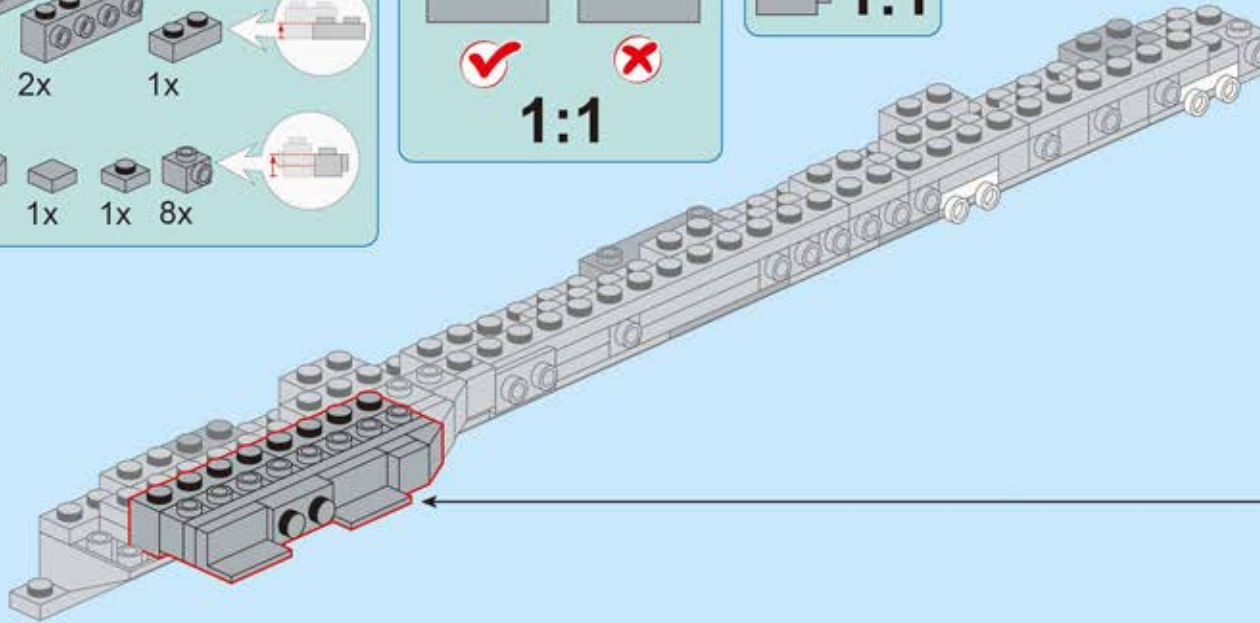
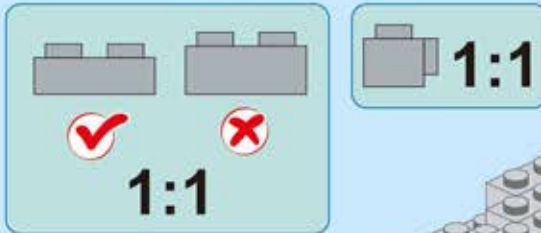
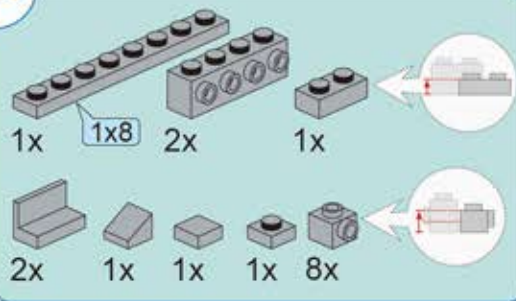

B207

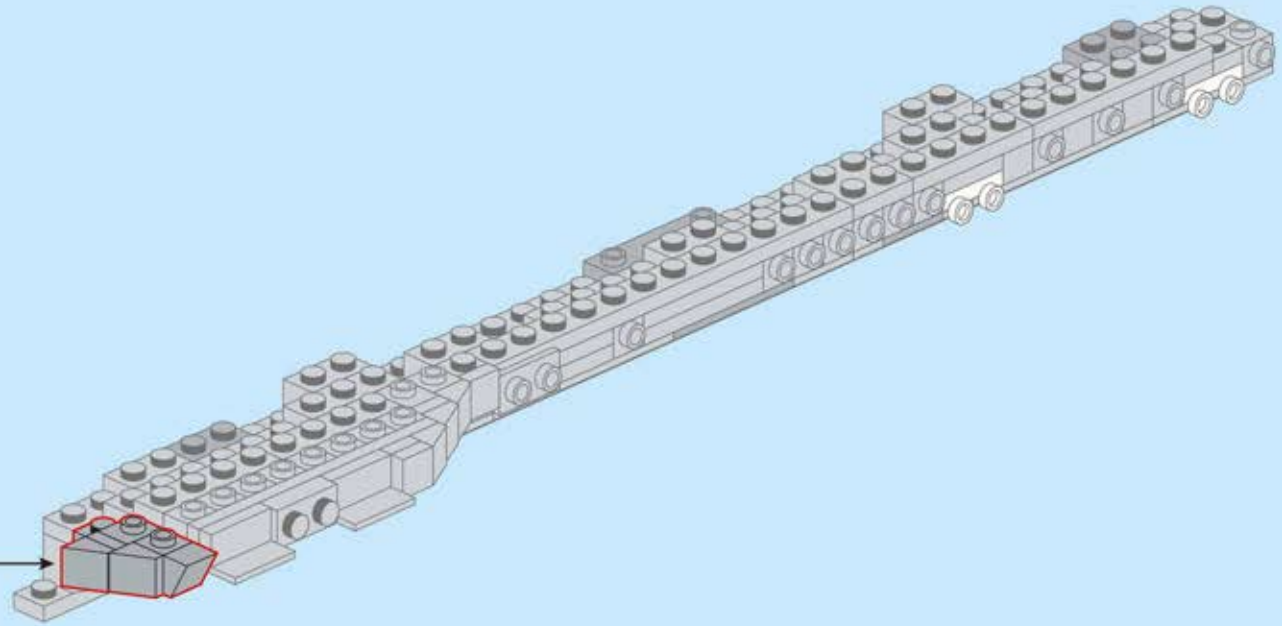
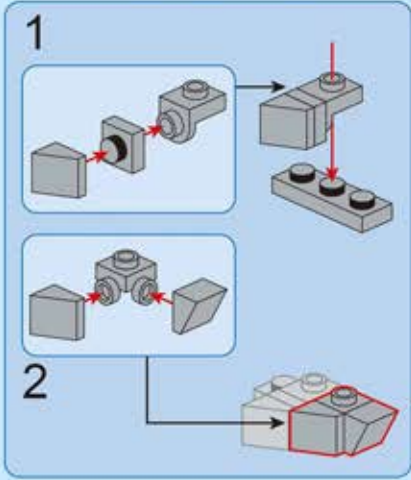
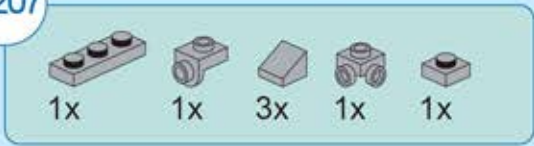

B208

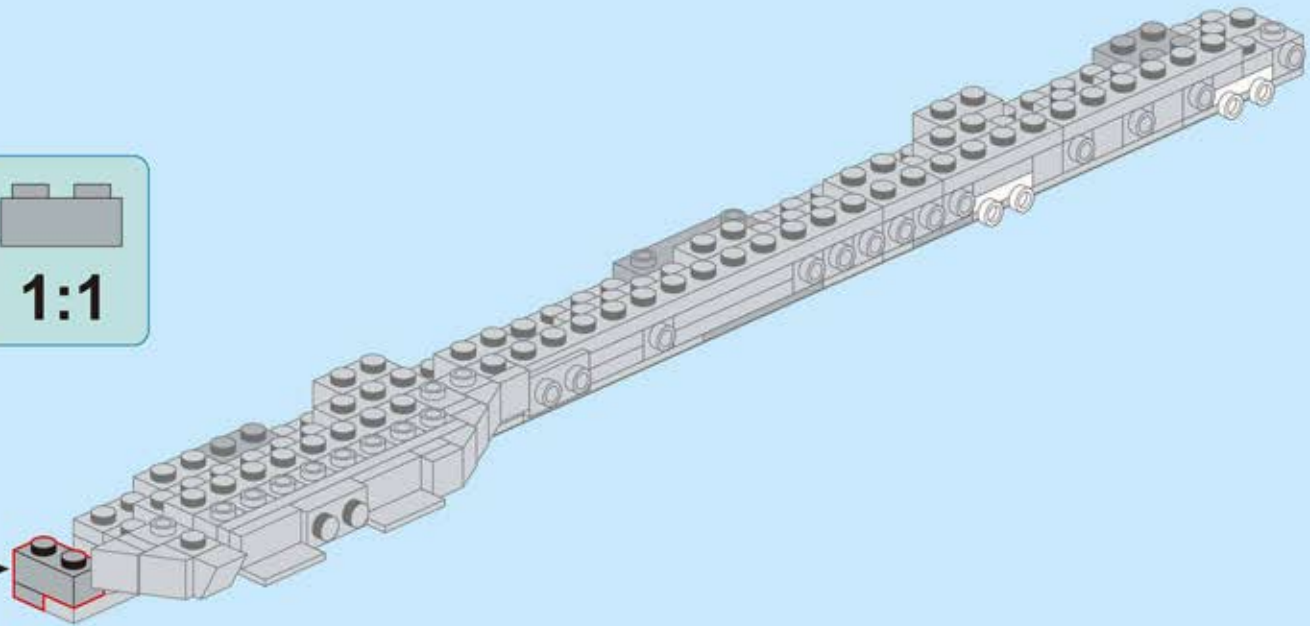
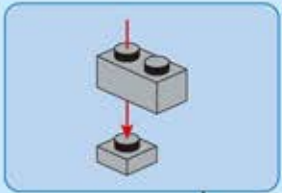
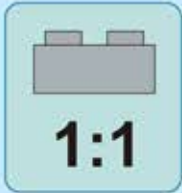
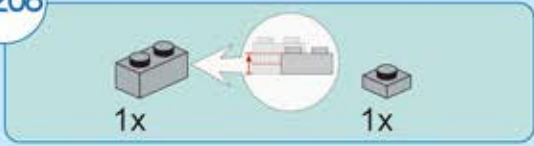

B209

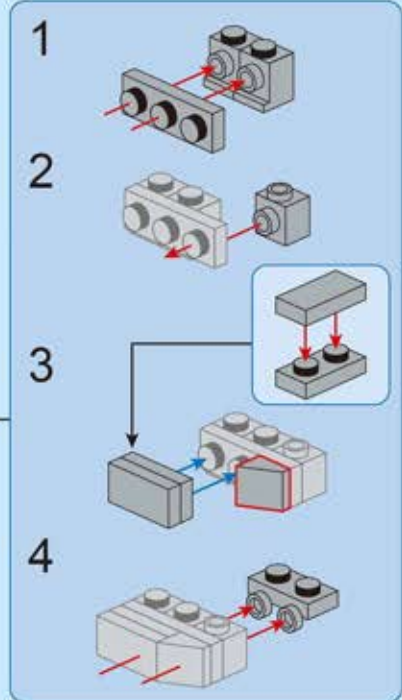
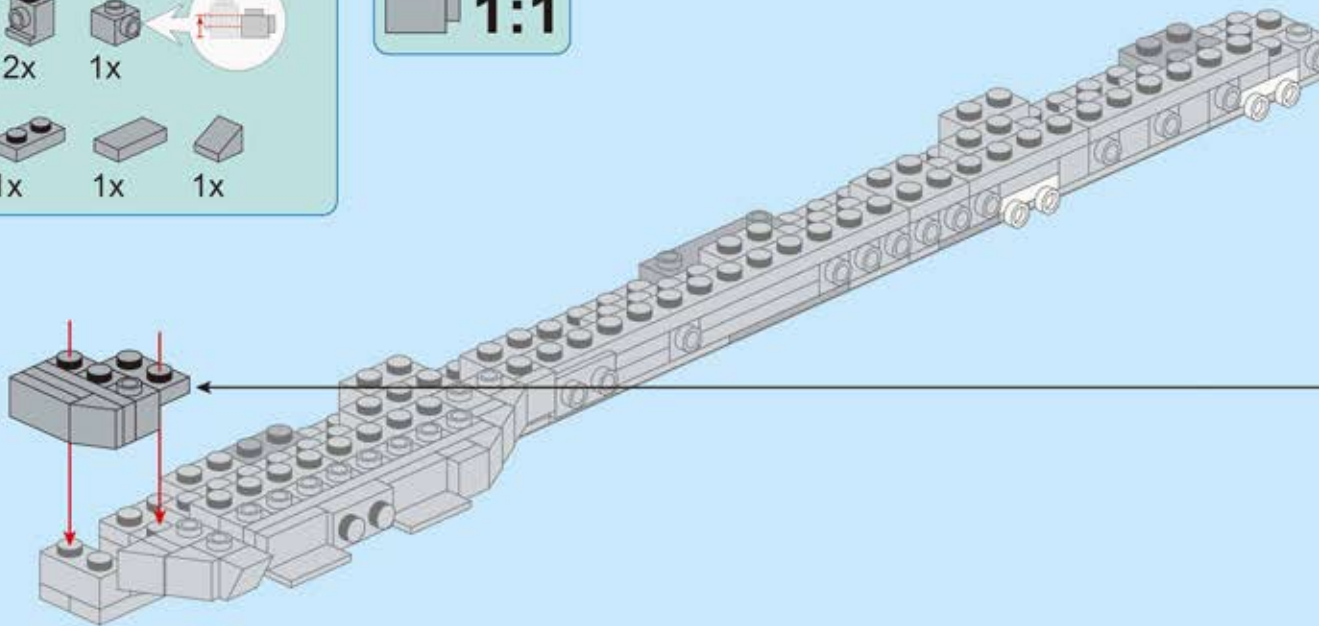
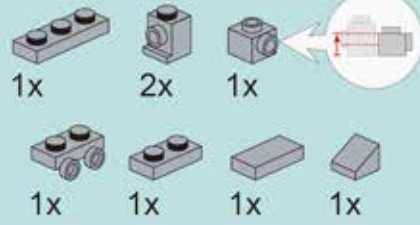

B210

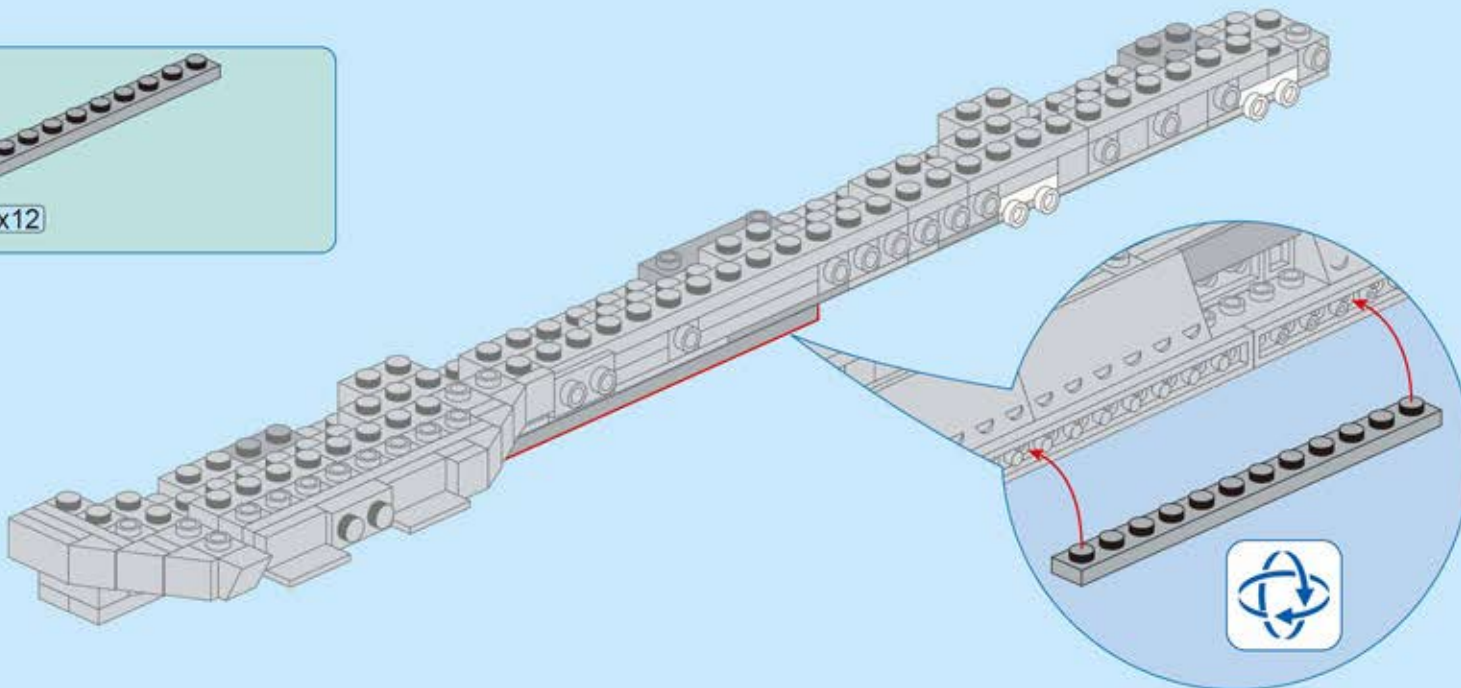
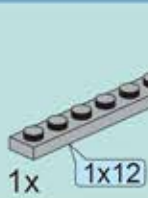

B211

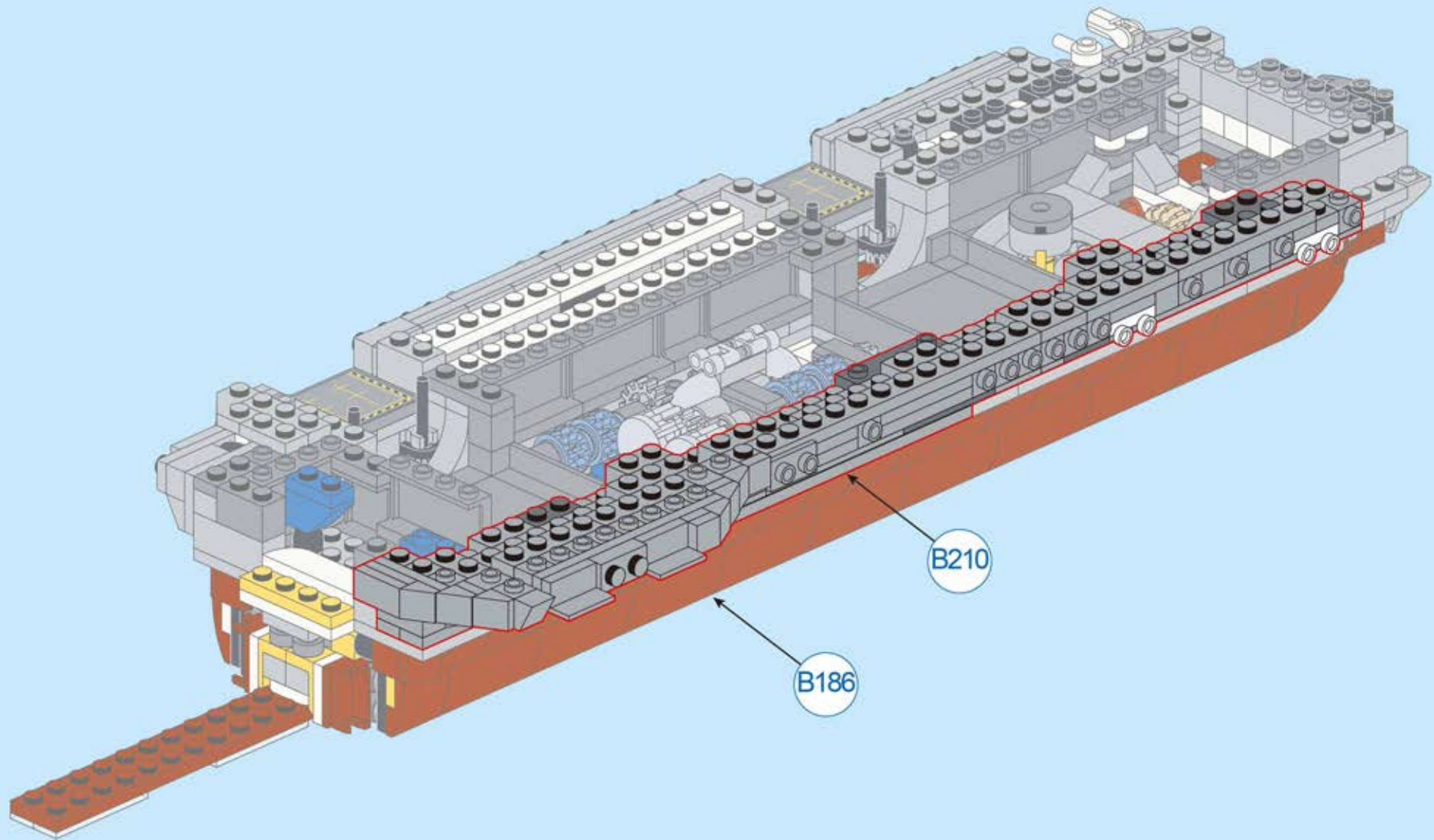

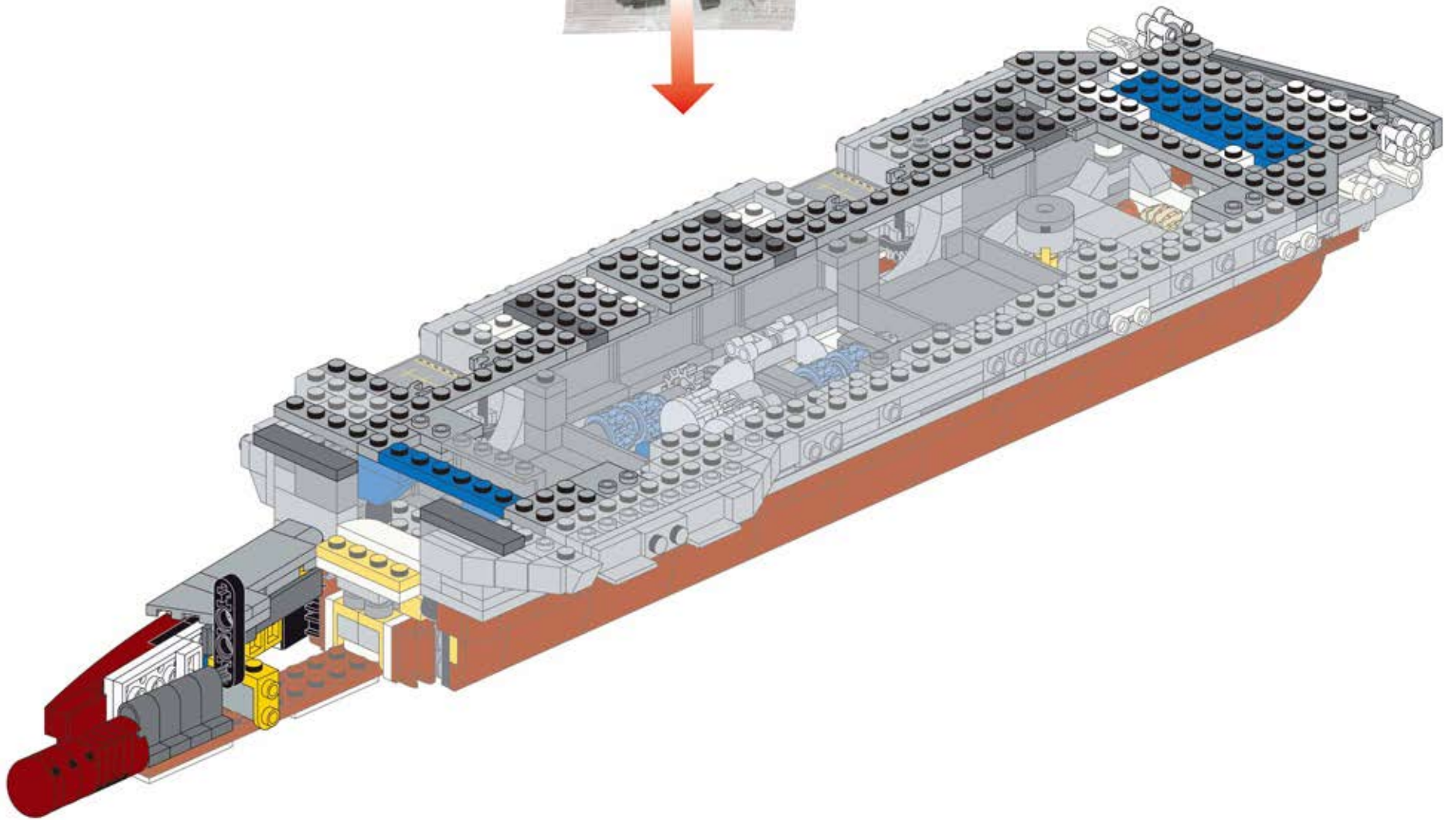

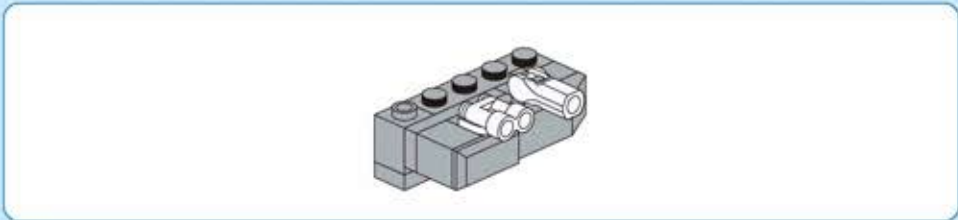

B212

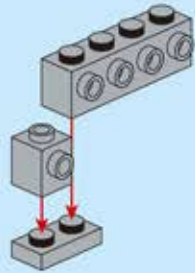
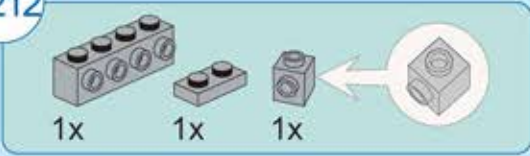

B213

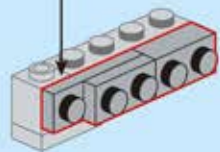
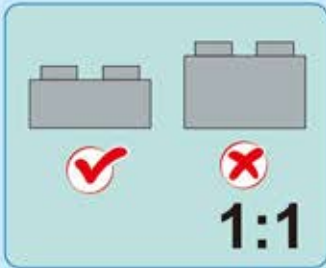
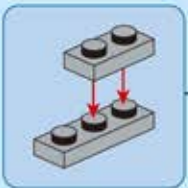
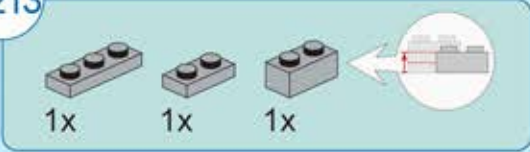

B214

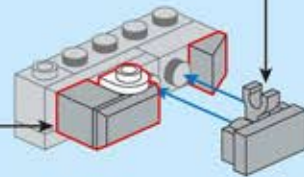
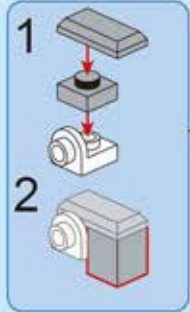
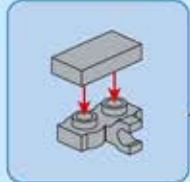
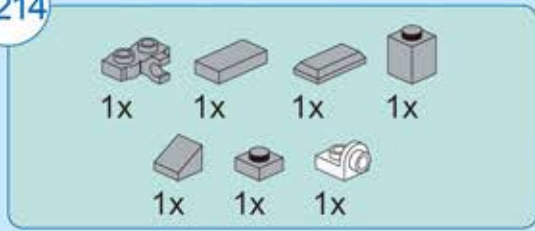

B215

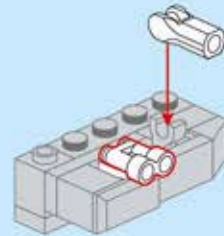

B216

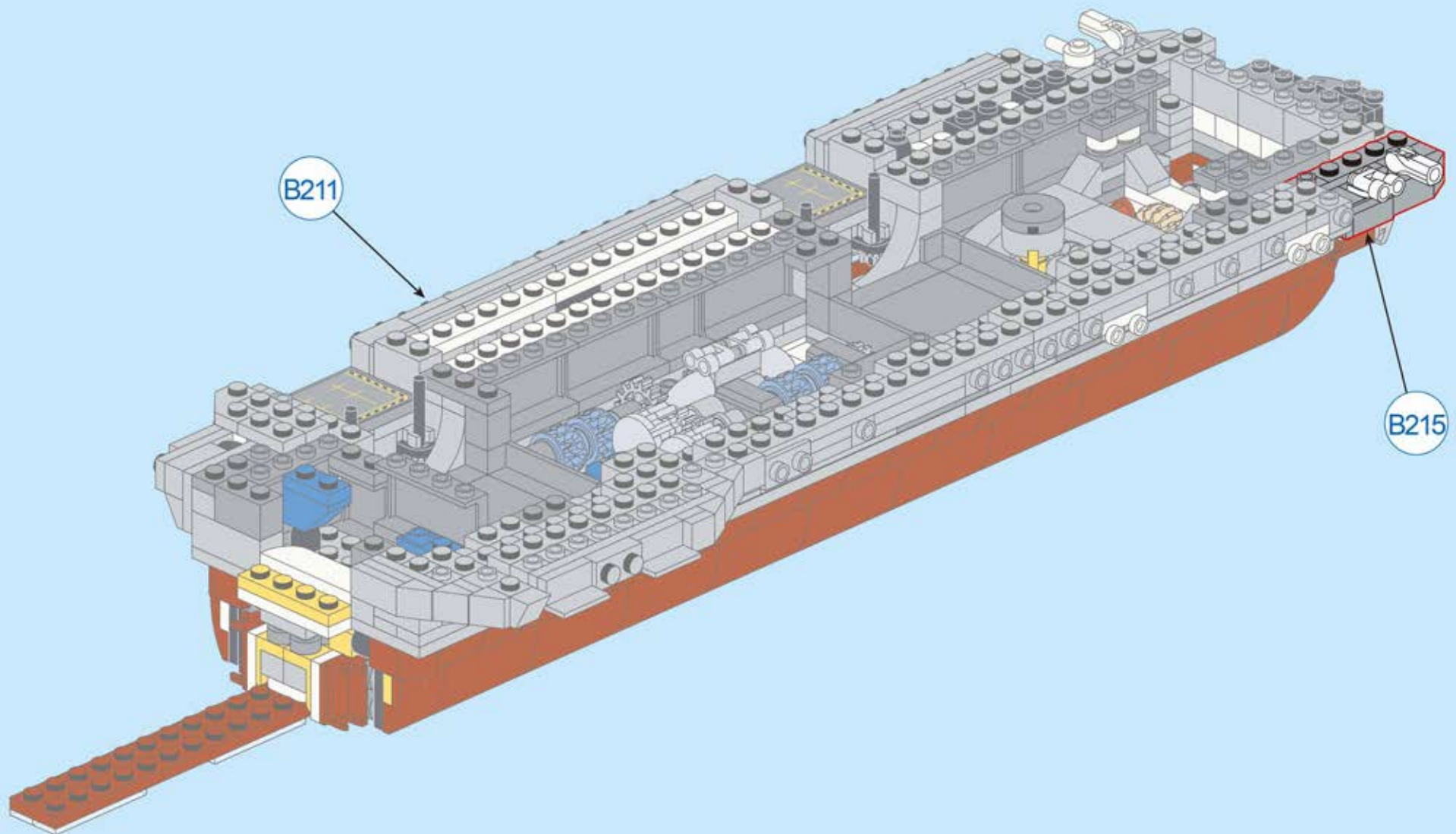

B211

B215

B217



1x



1x



B218

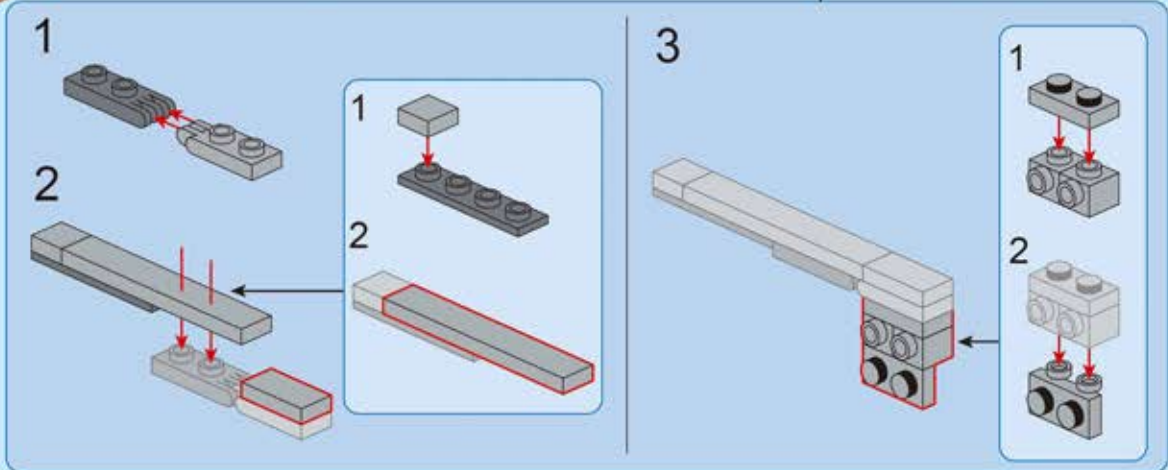
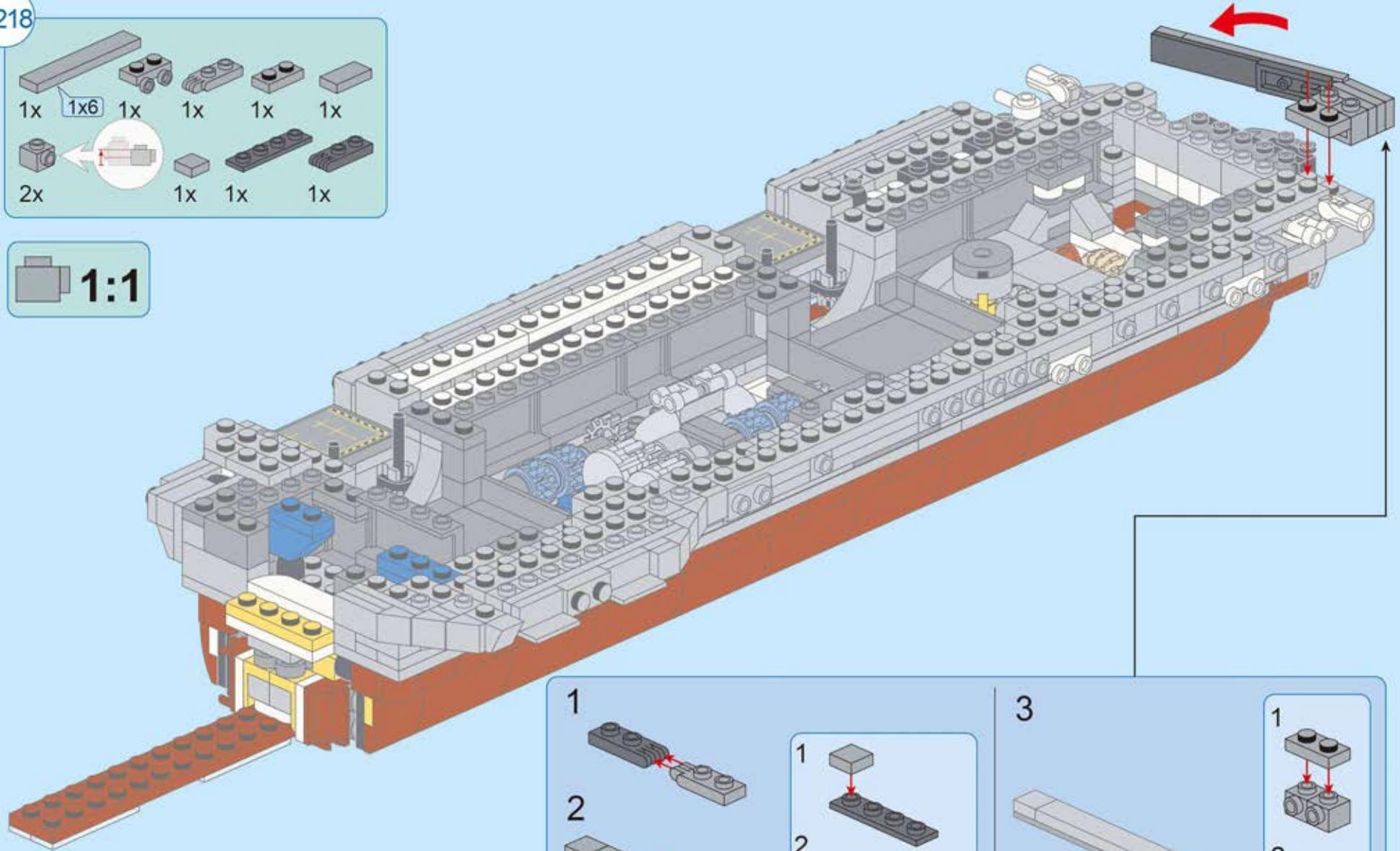
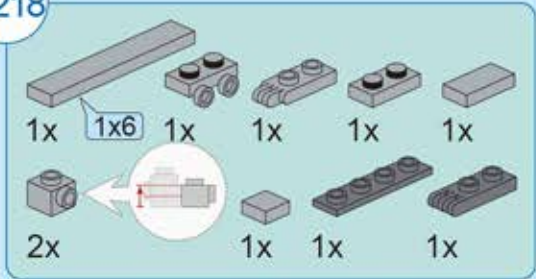

B219

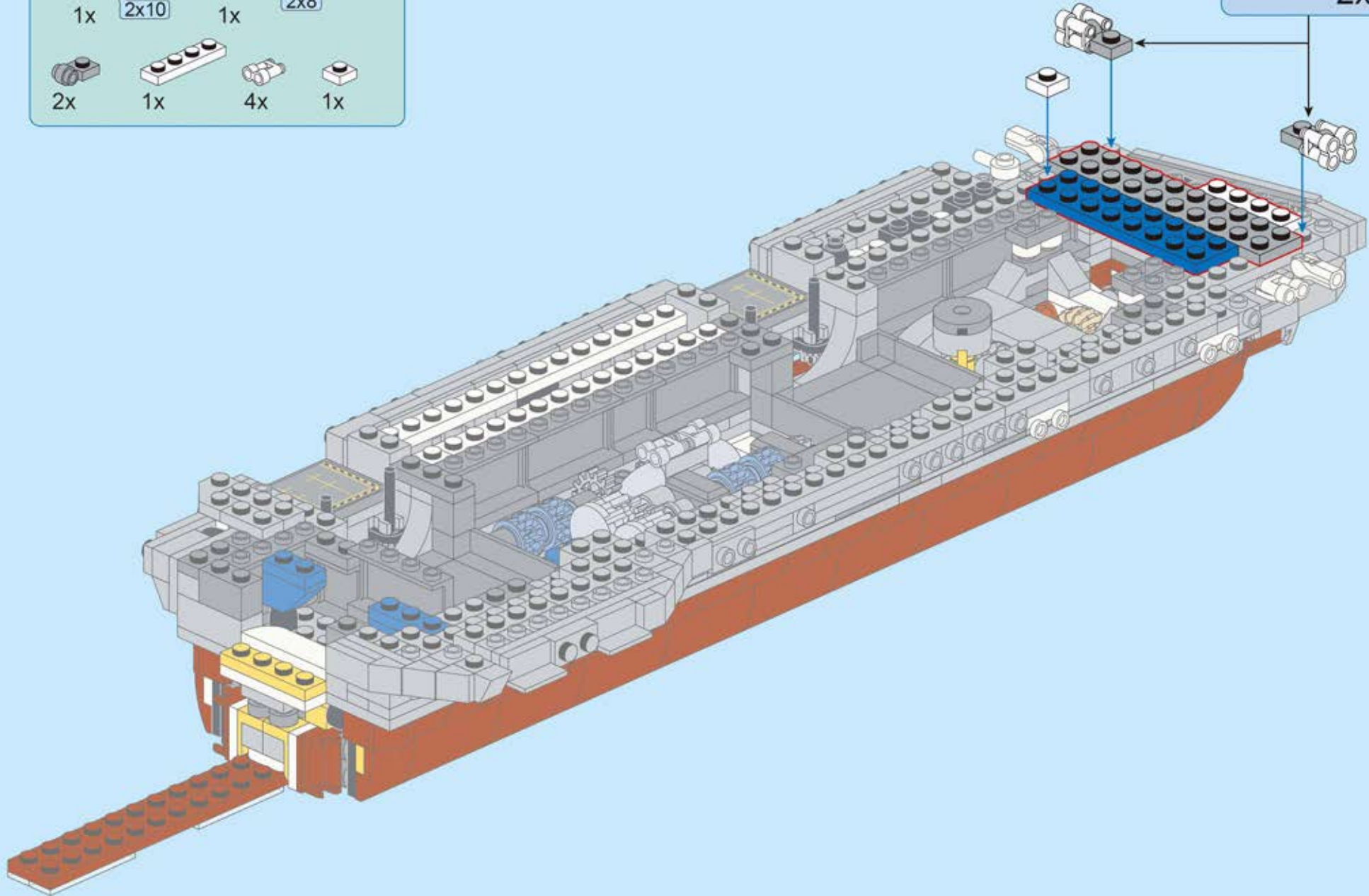
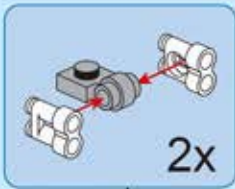
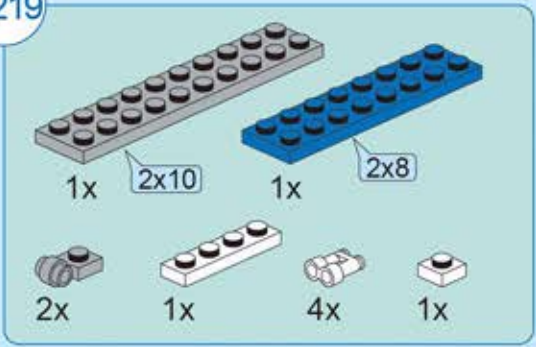

B220

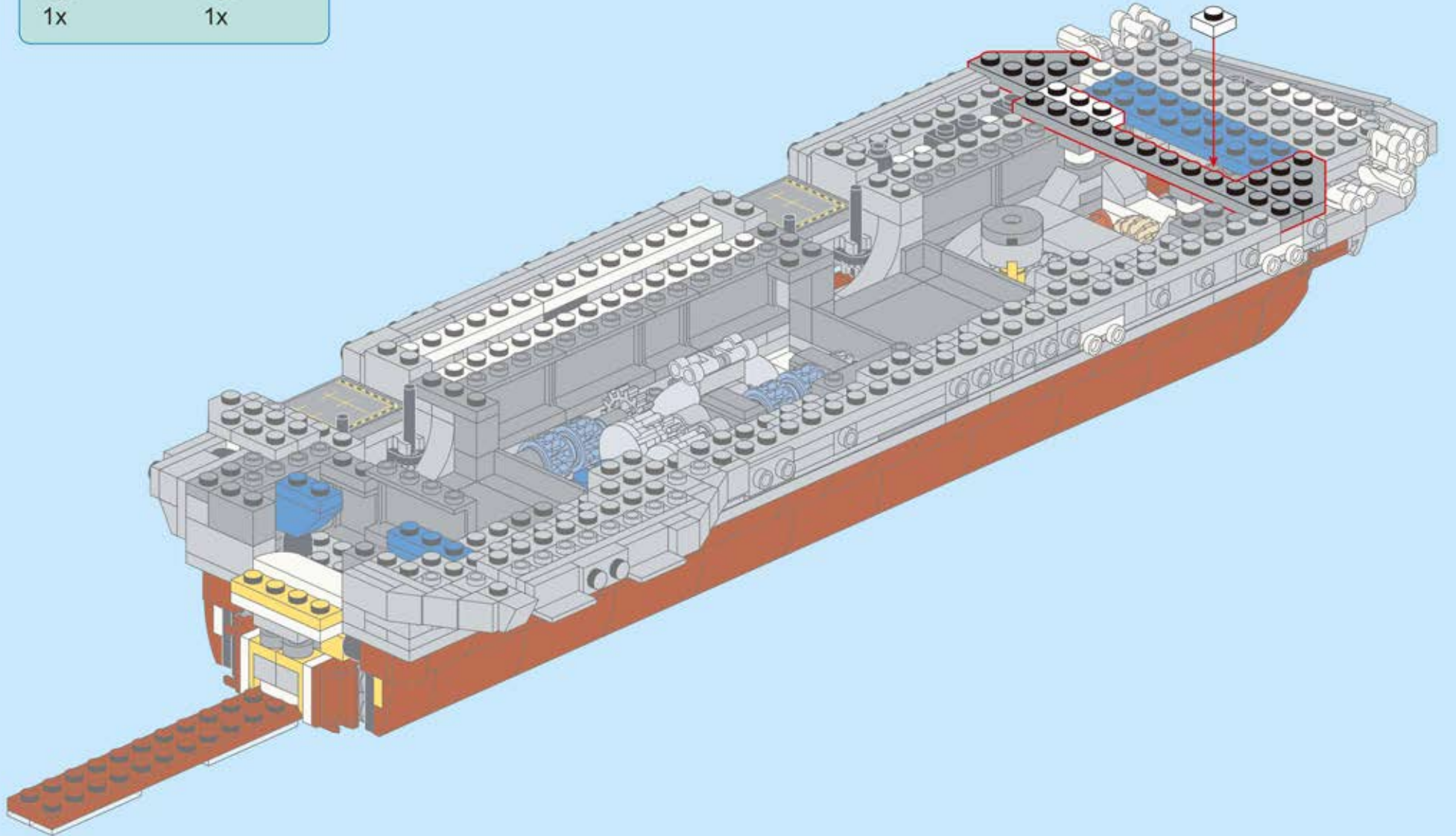
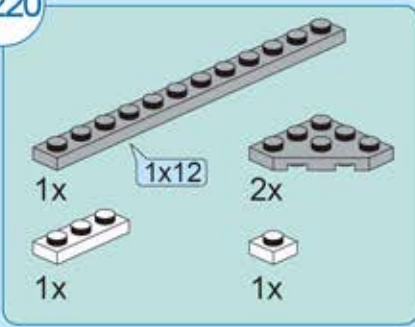



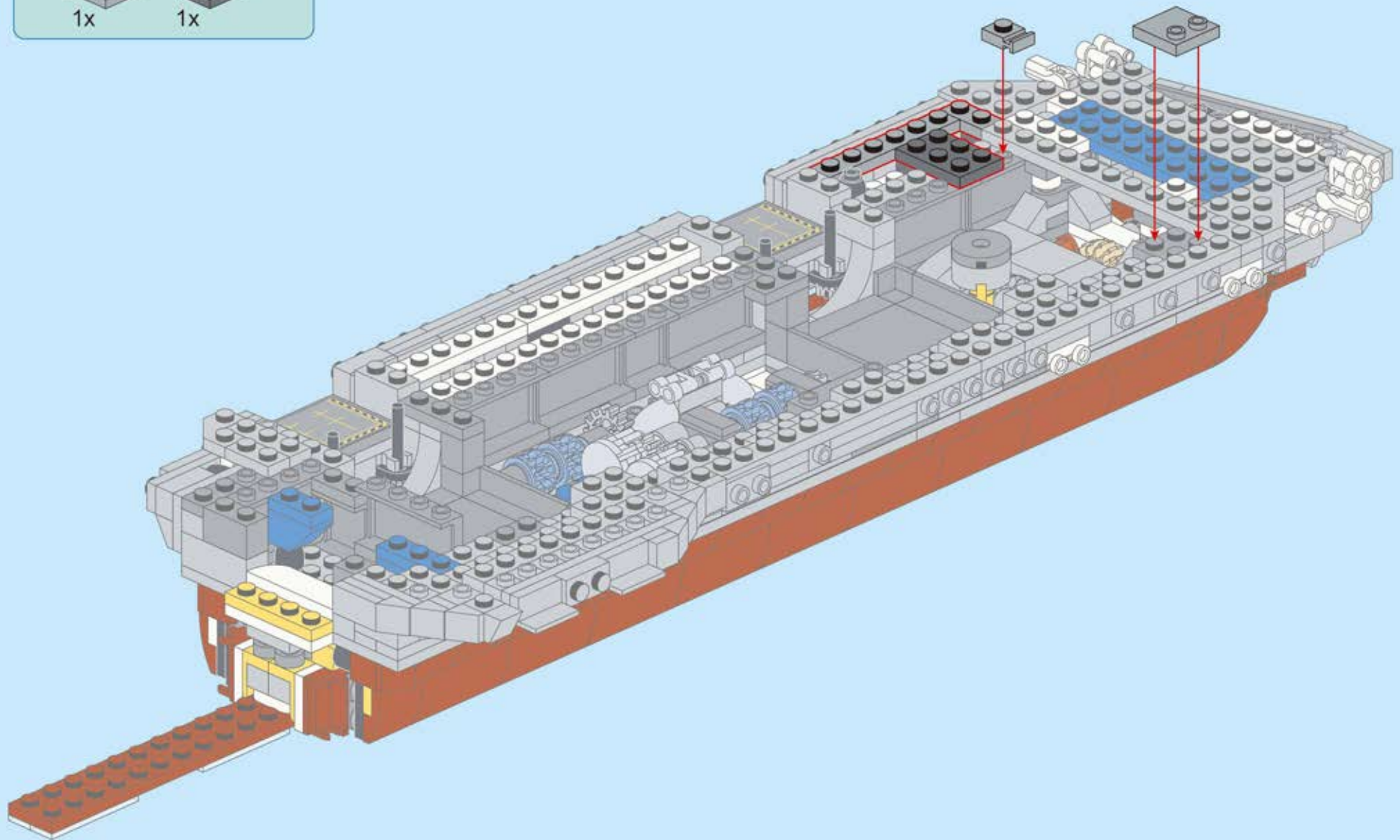
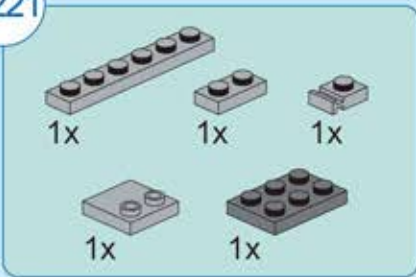

B221

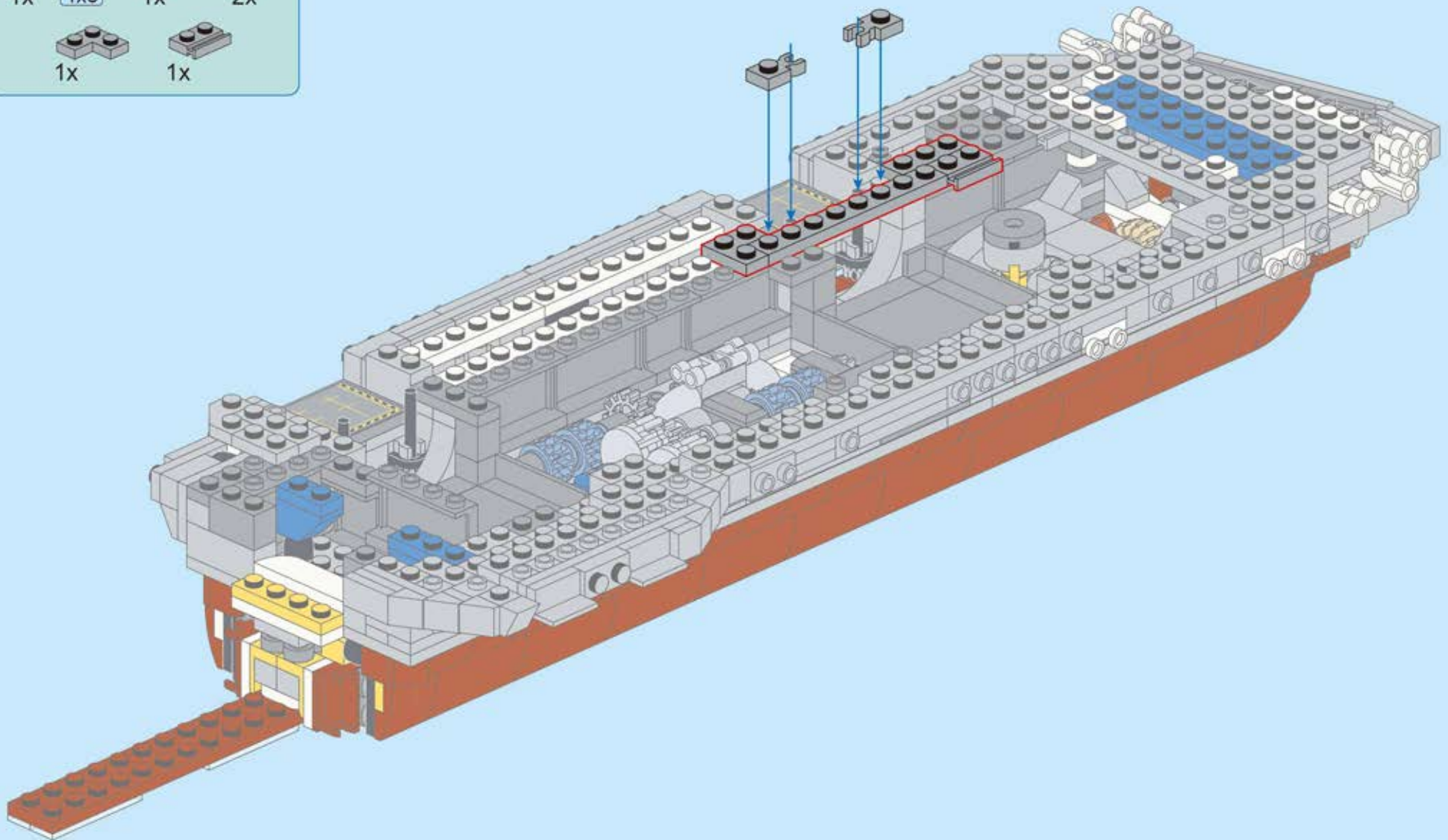
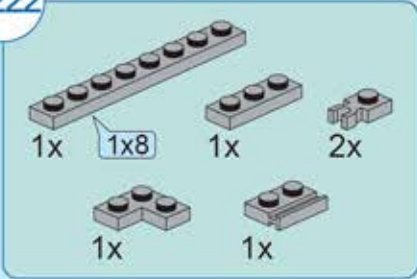

B222



B223

	
3x	1x
	
1x	2x



B224

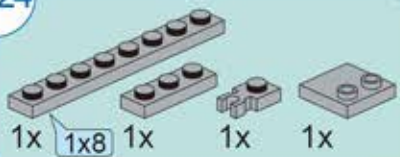

B225



1x



1x



1x



1x

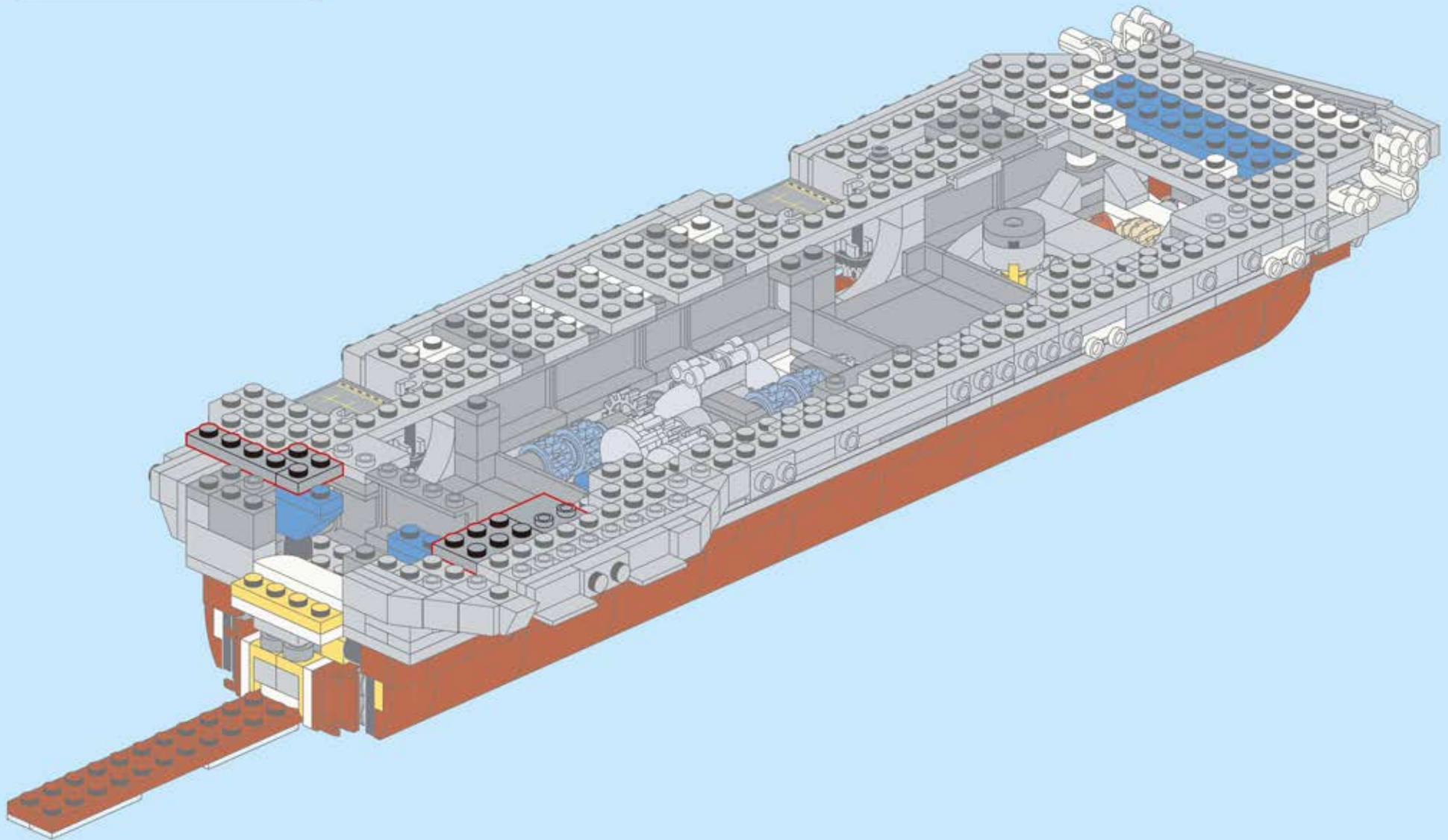

B226



1x



2x

1x4

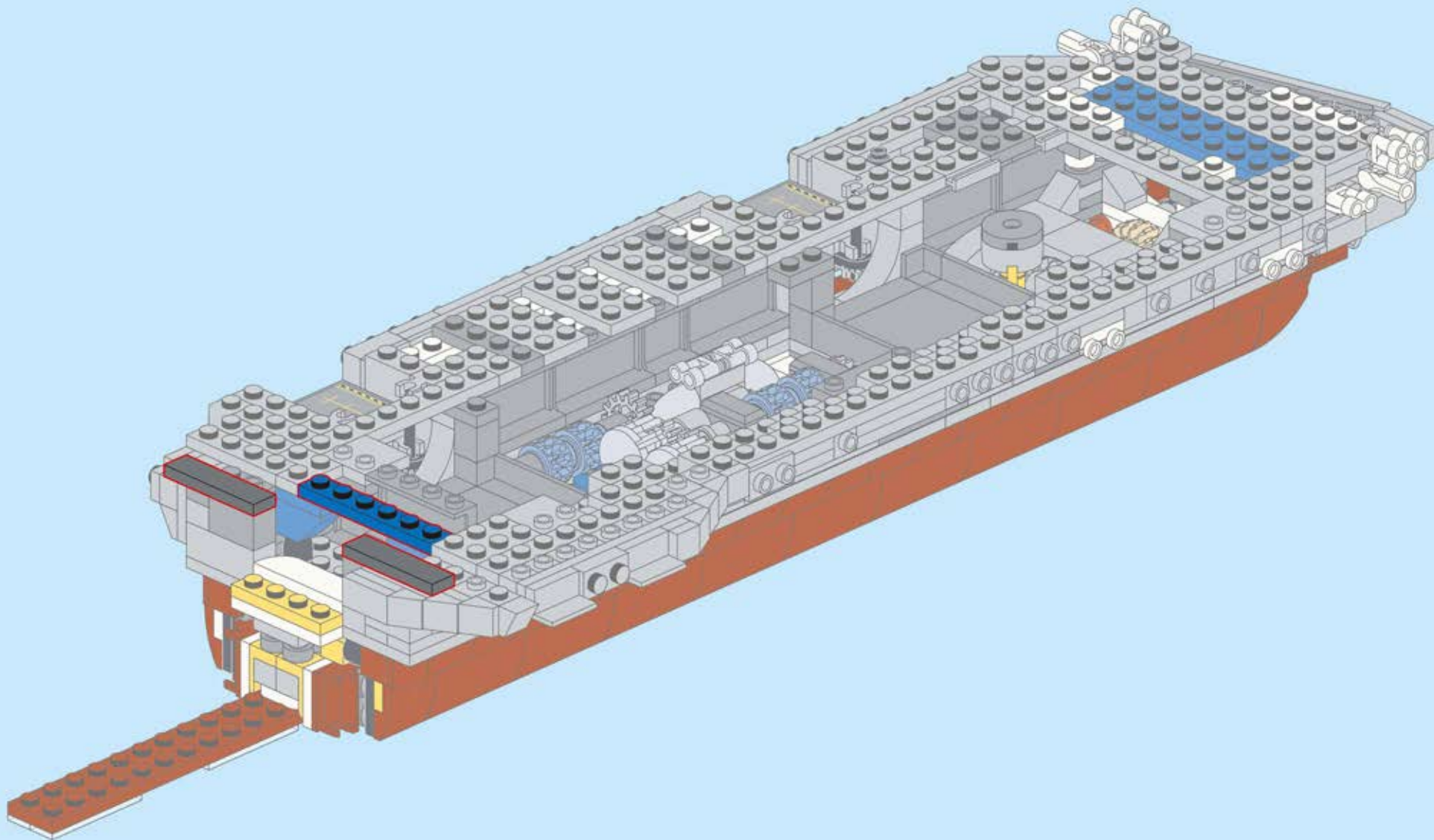

B227



2x



1x

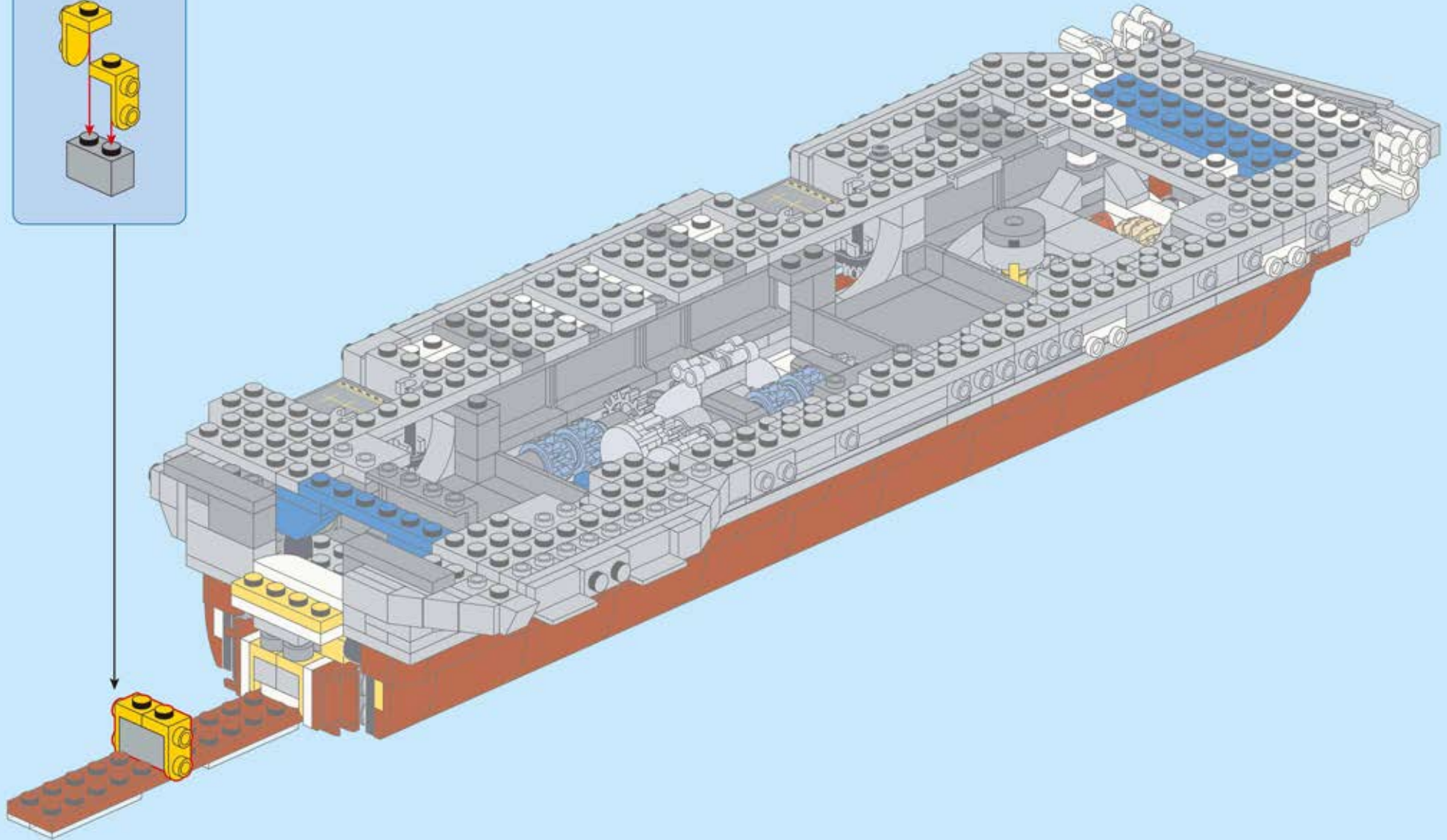
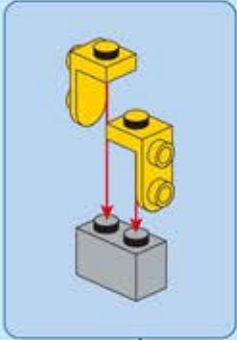

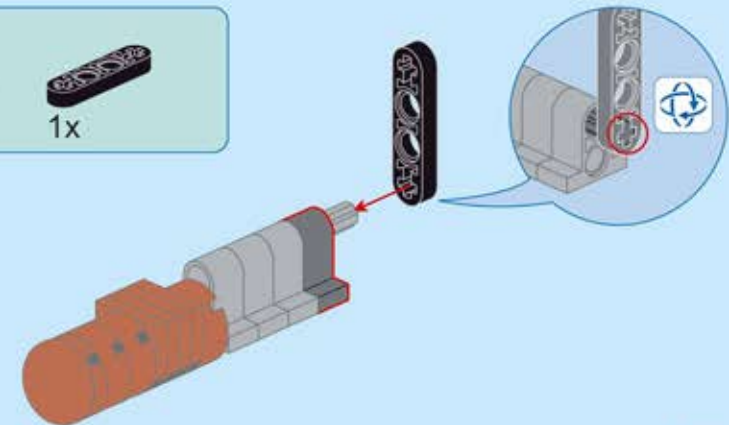
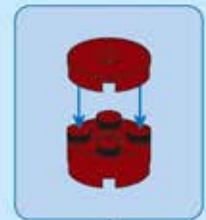
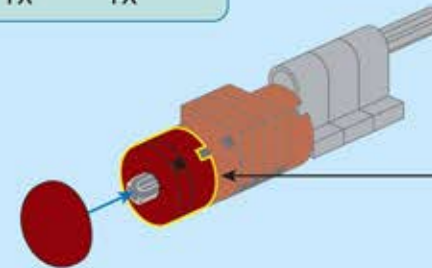
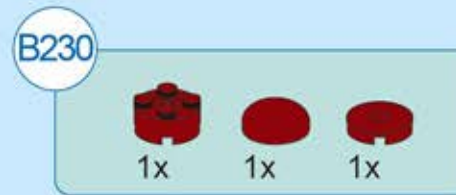
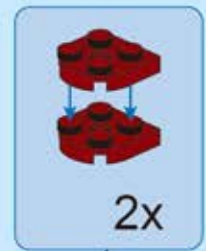
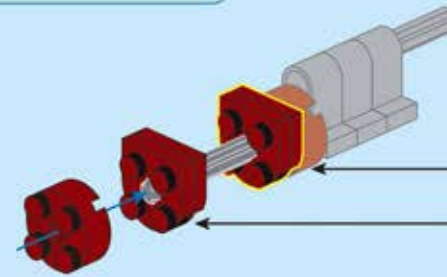
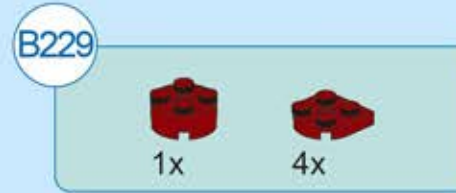
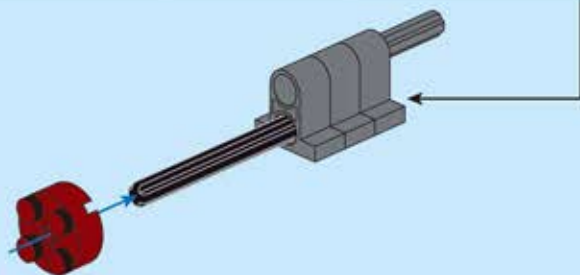
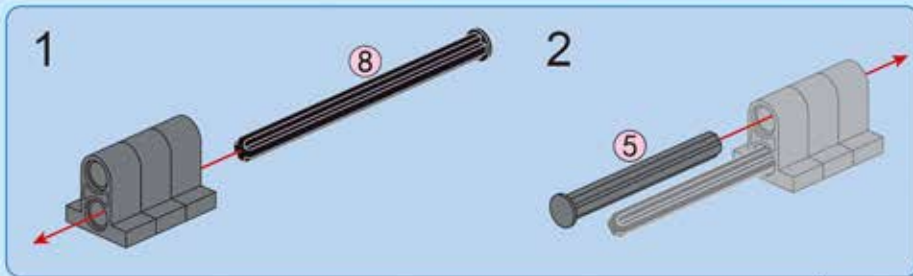
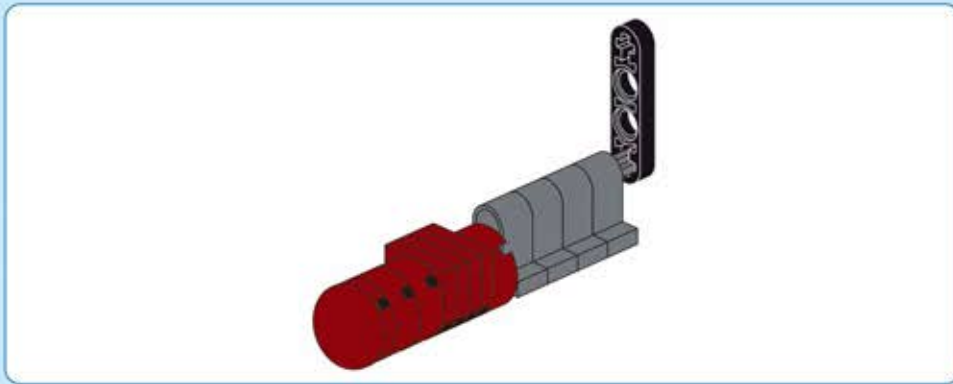

B232

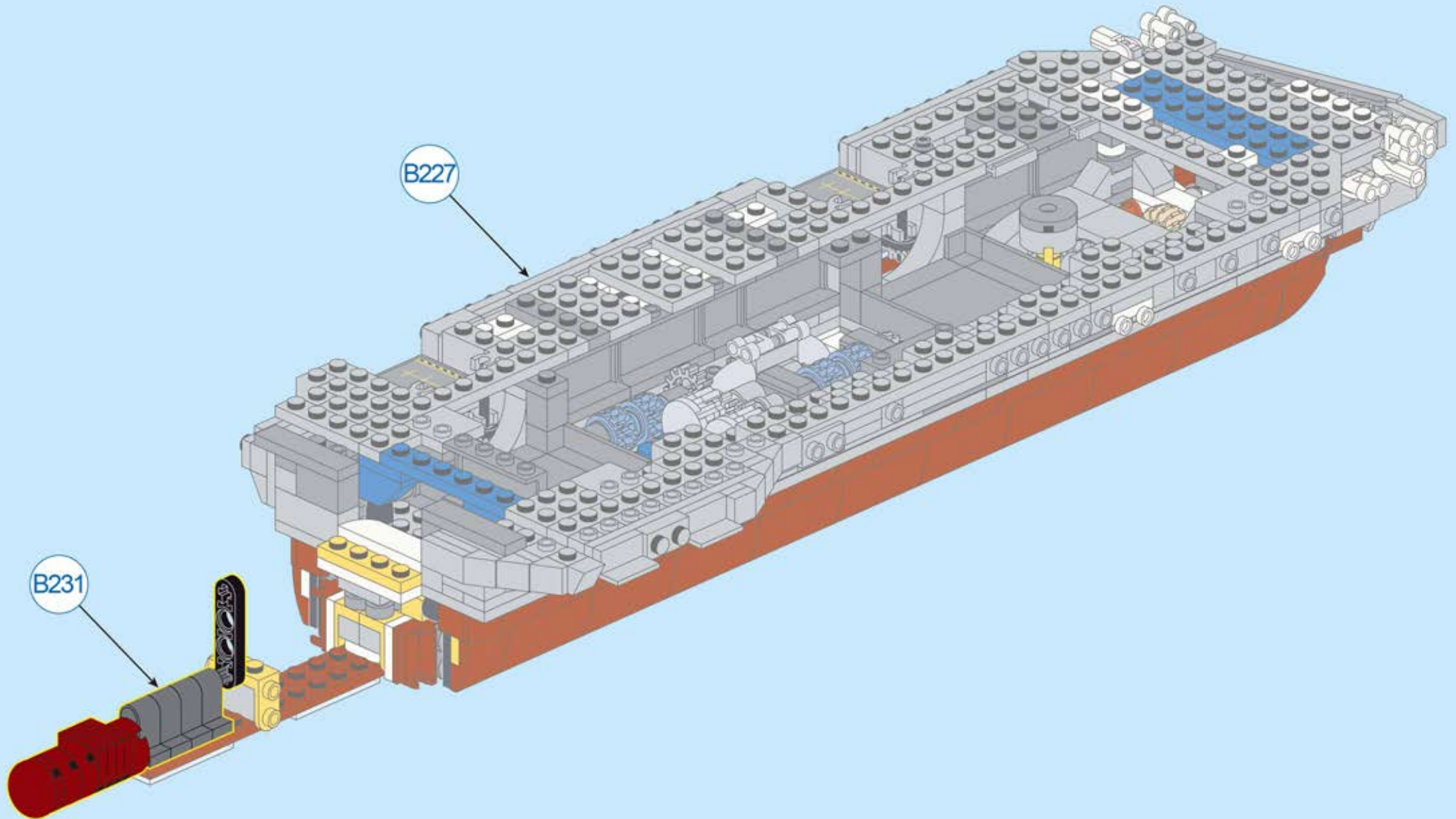

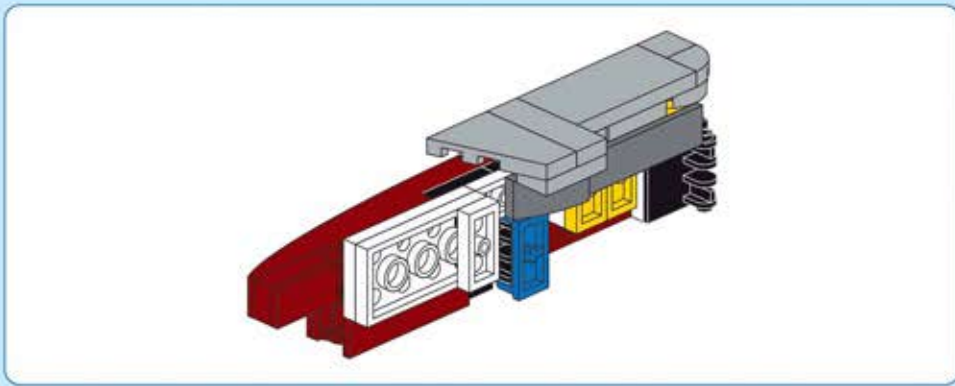

B233

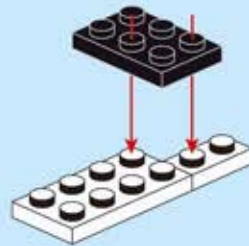
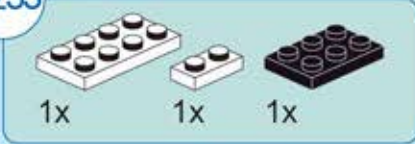

B234

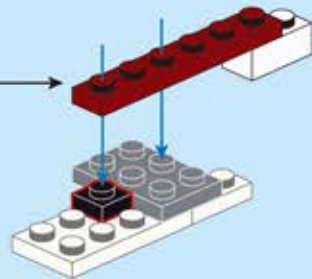
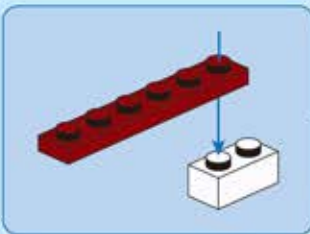
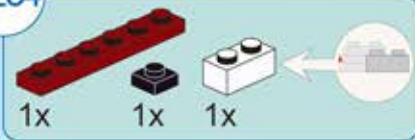

B235

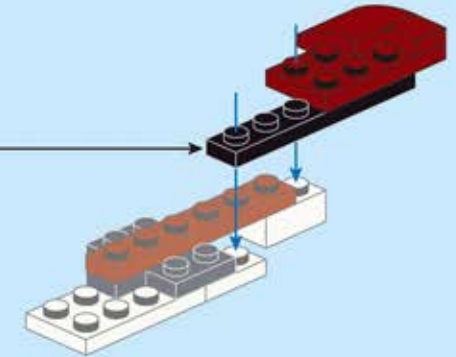
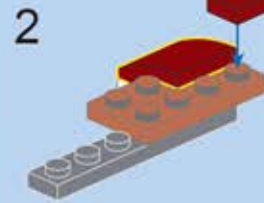
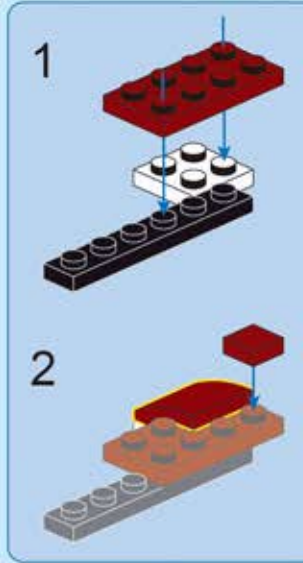
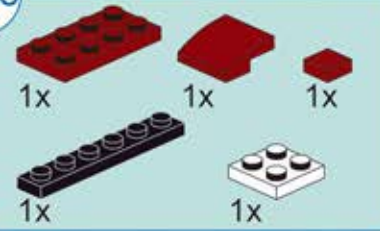

B236

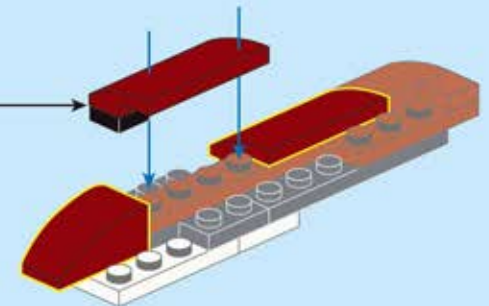
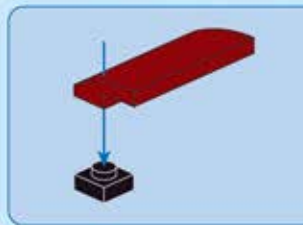
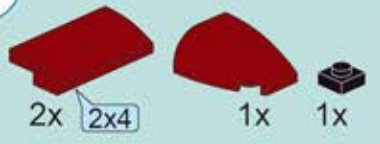

B237

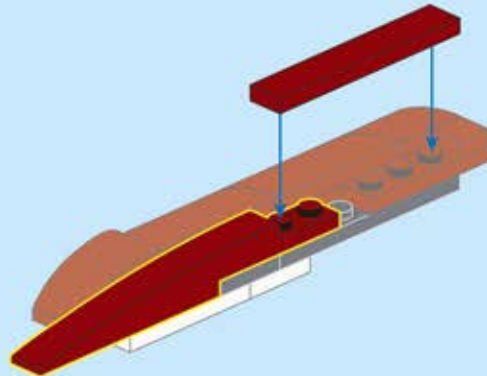
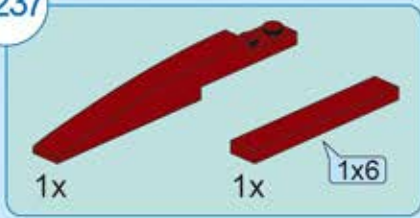

B238

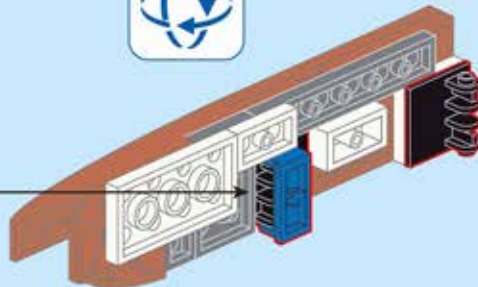

B239

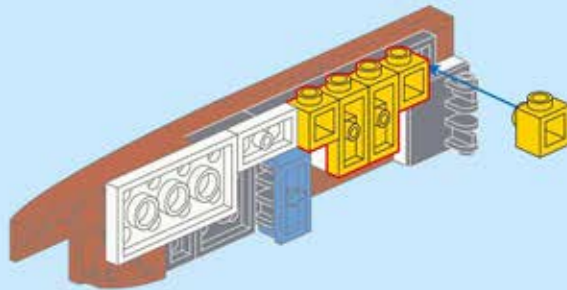

B240

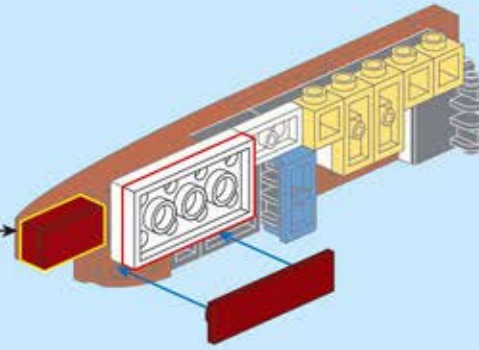
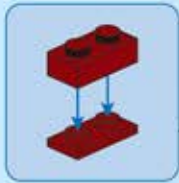
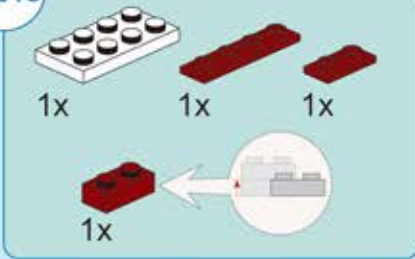

B241

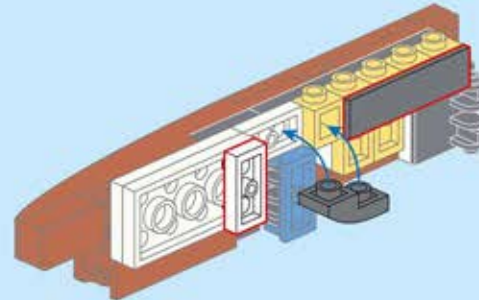
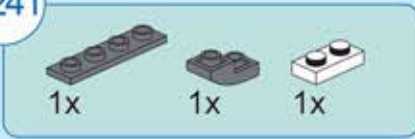

B242

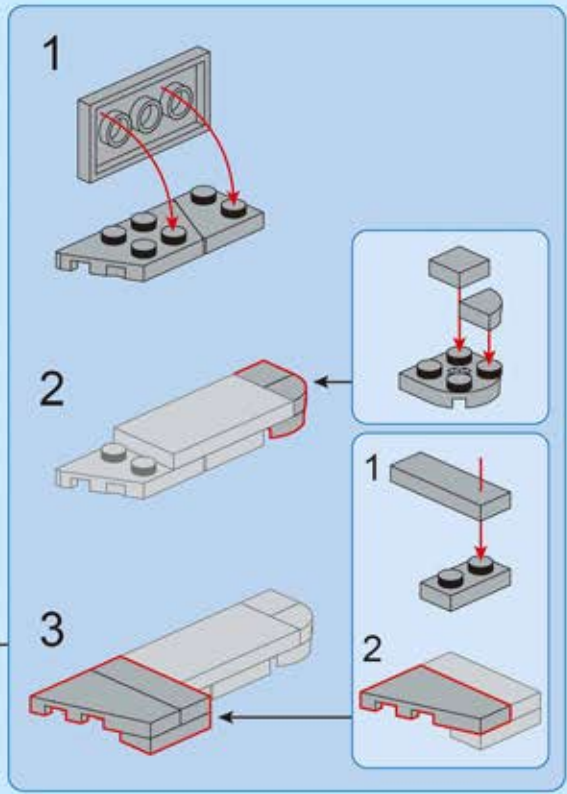
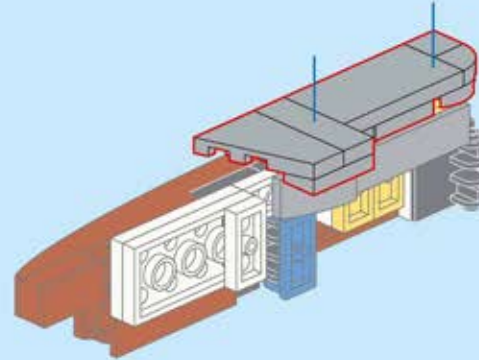
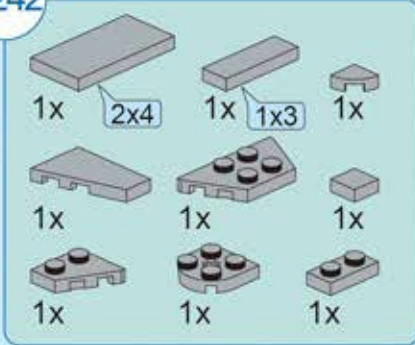

B243

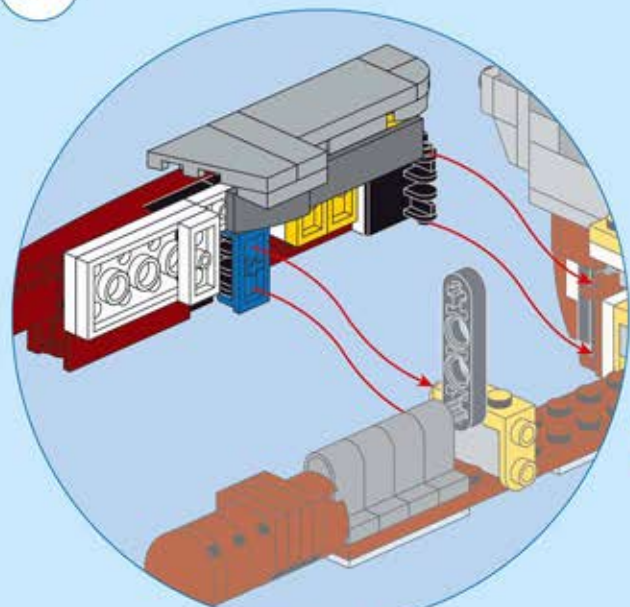

B232

B242

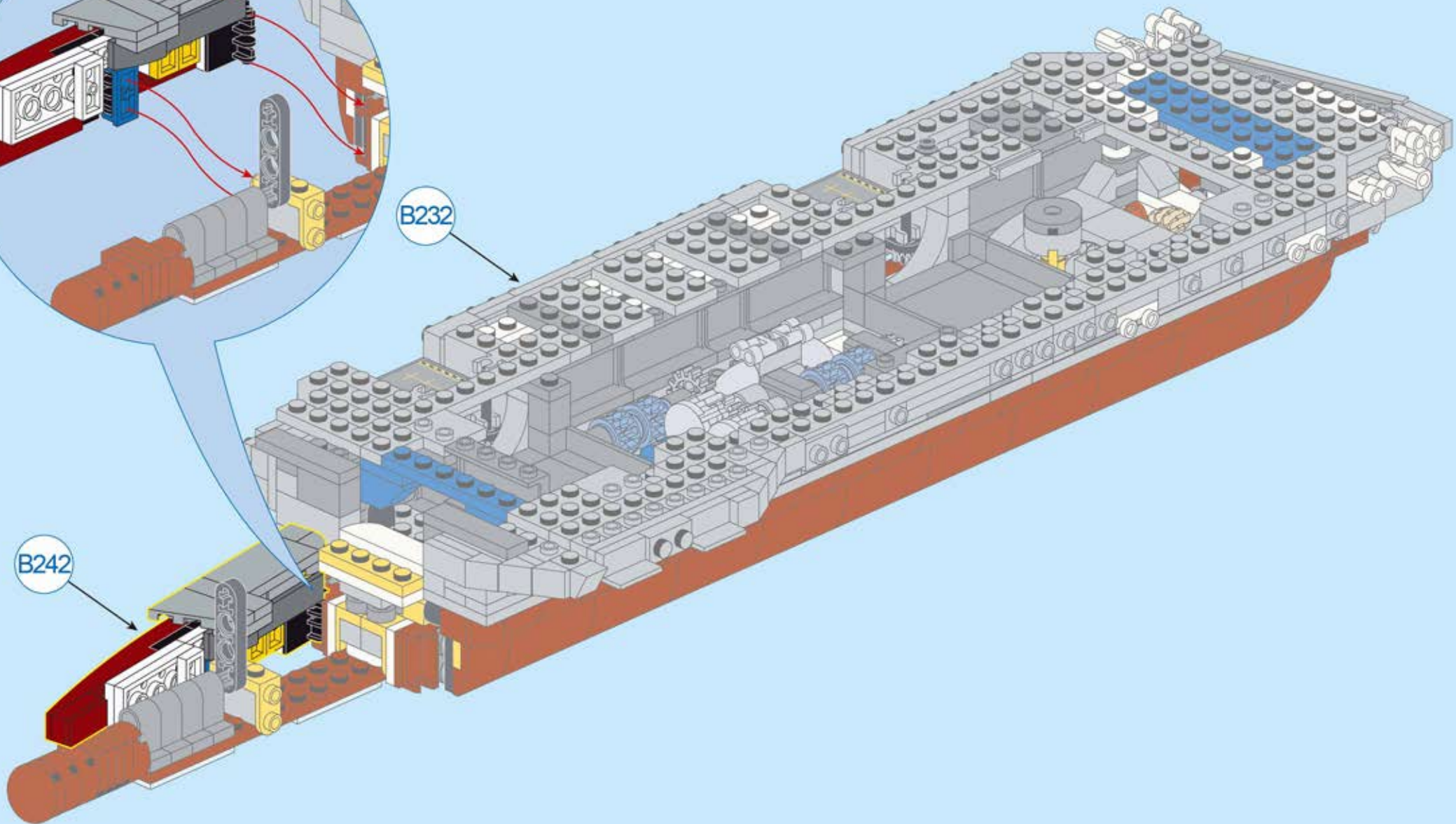

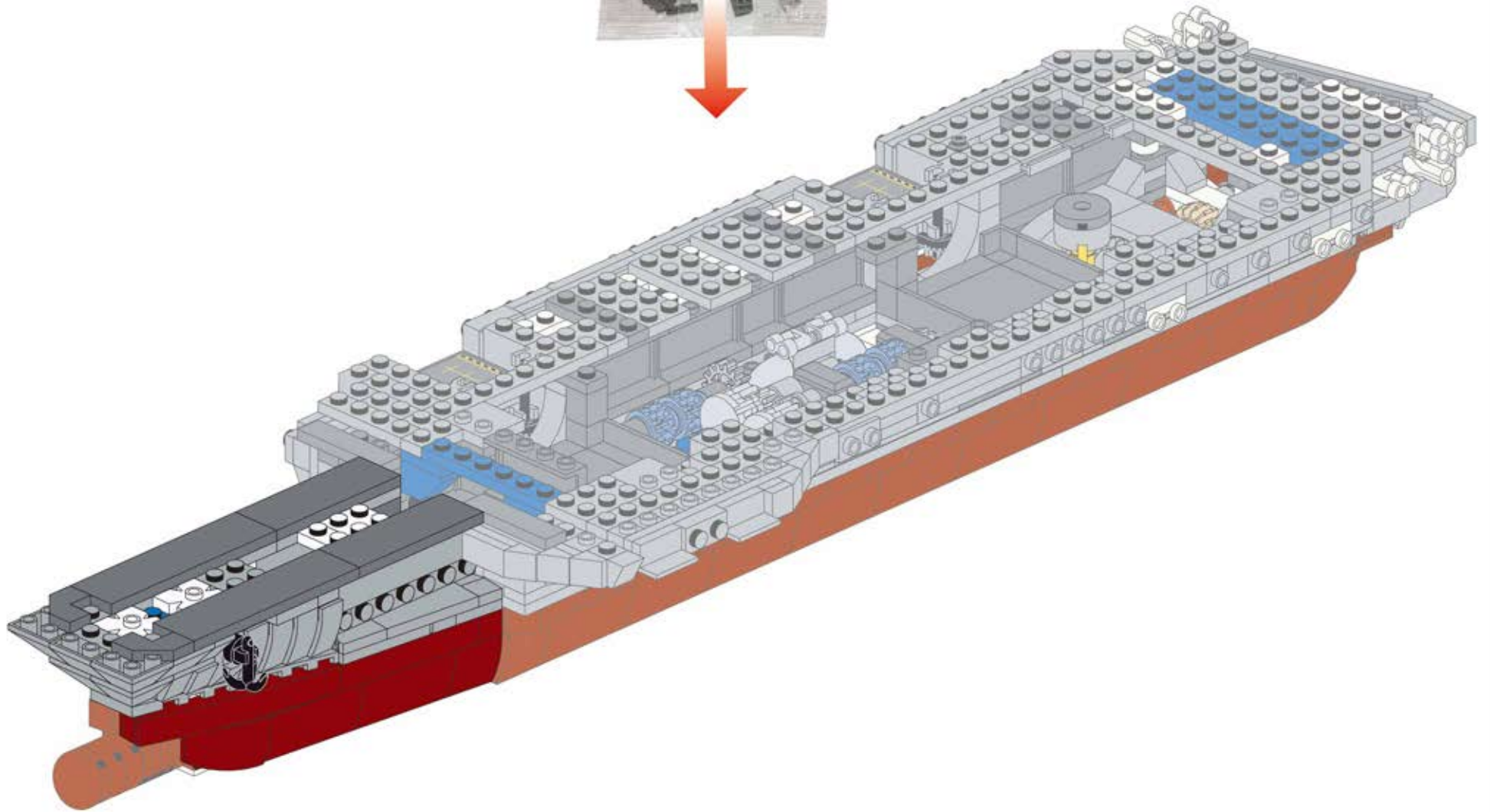

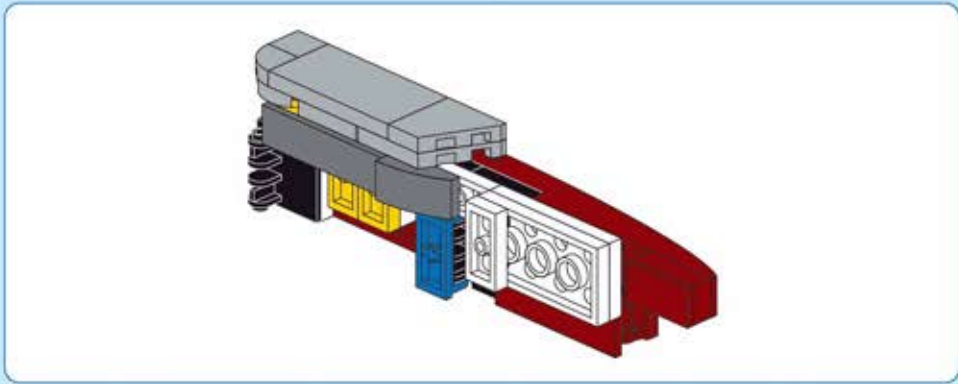

B244

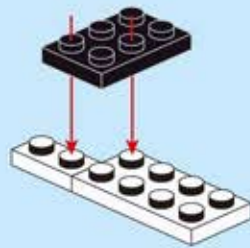
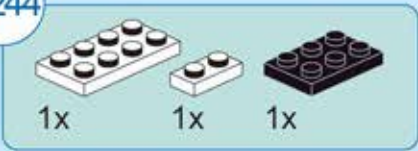

B245

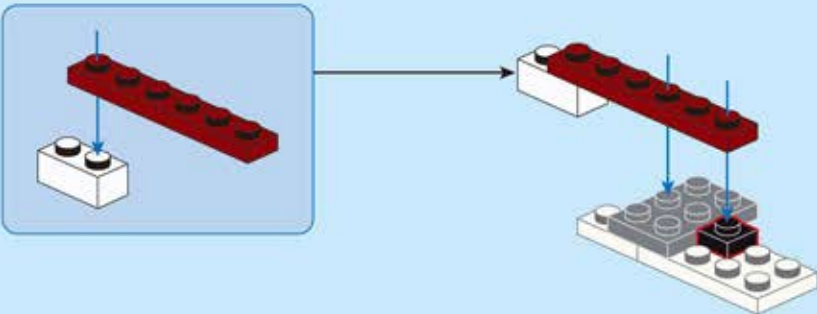
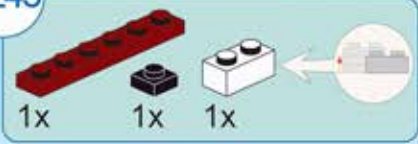

B246

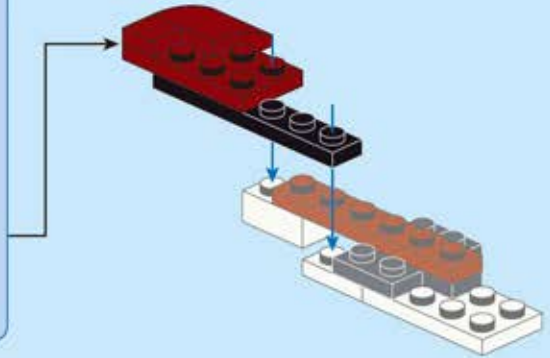
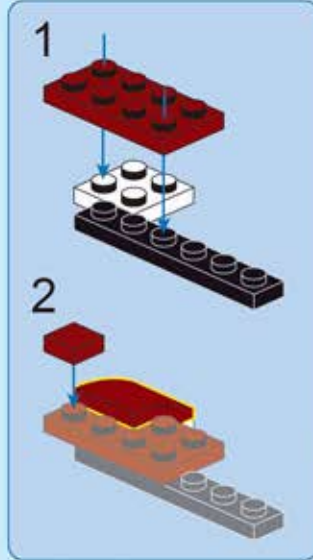
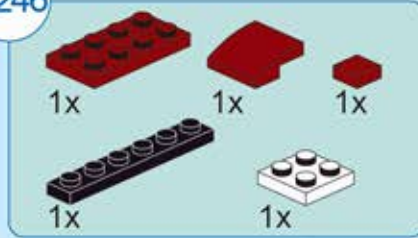

B247

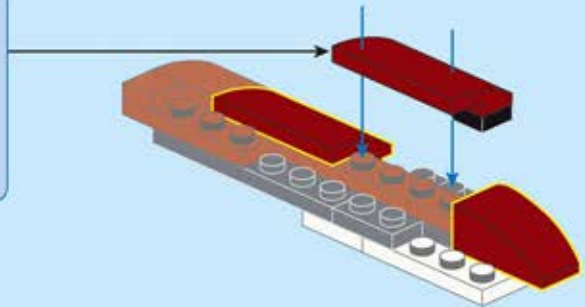
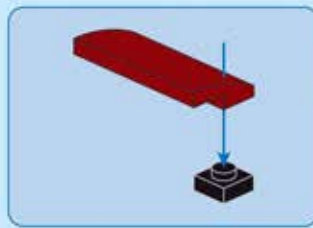
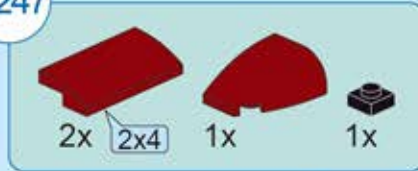

B248

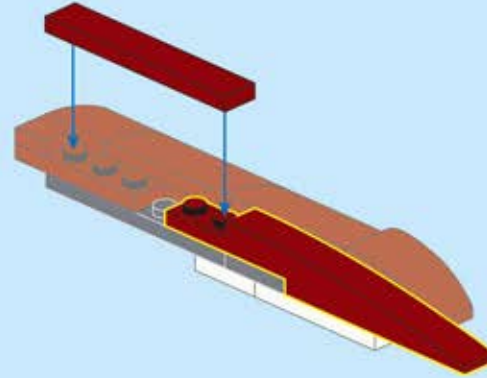
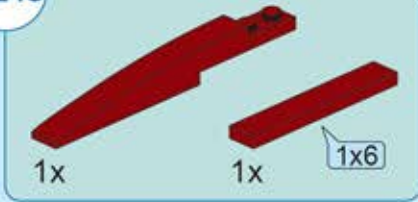

B249

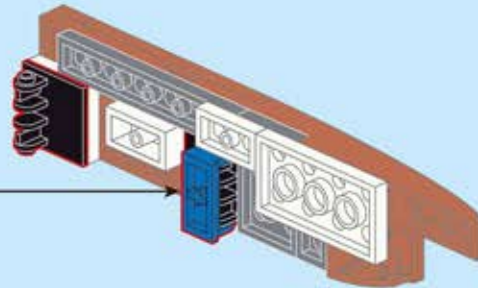

B250

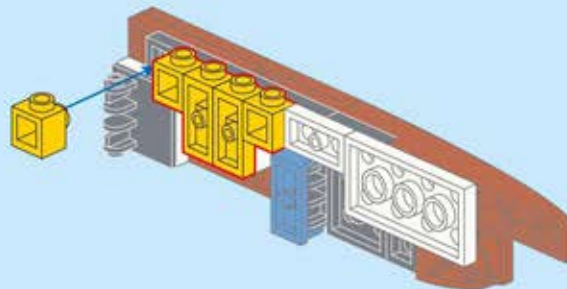

B251

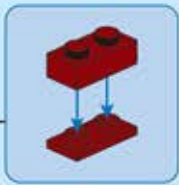
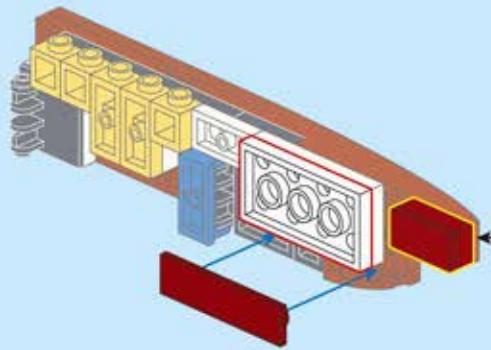
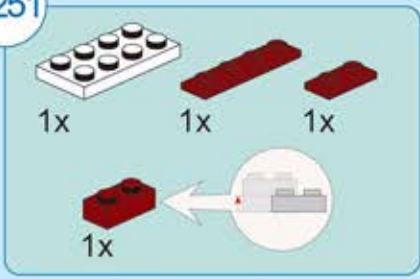

B252

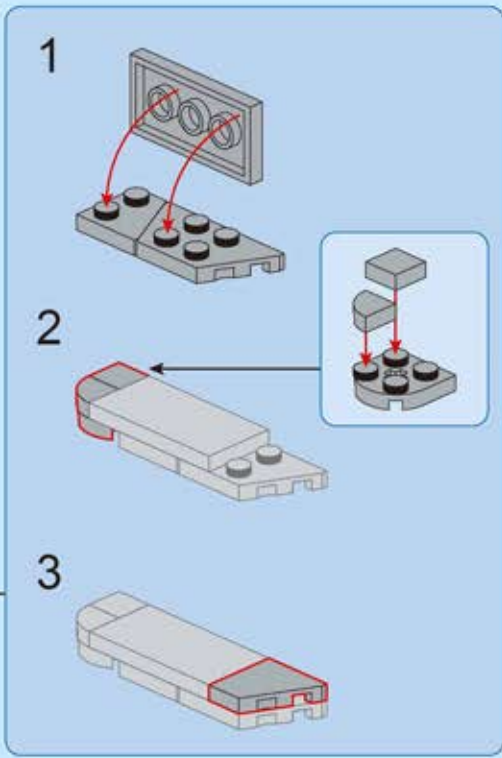
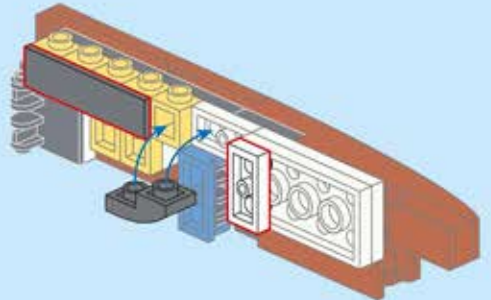
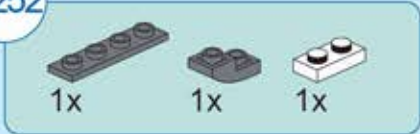

B253

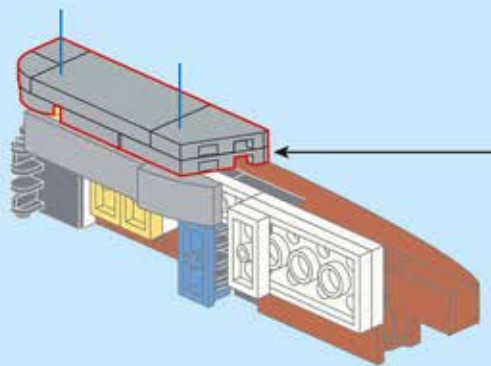
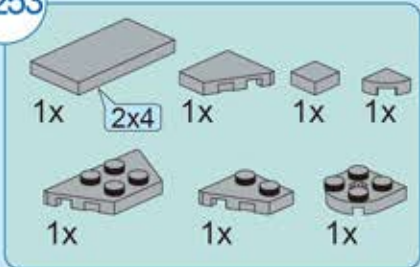

B254

B243

B253

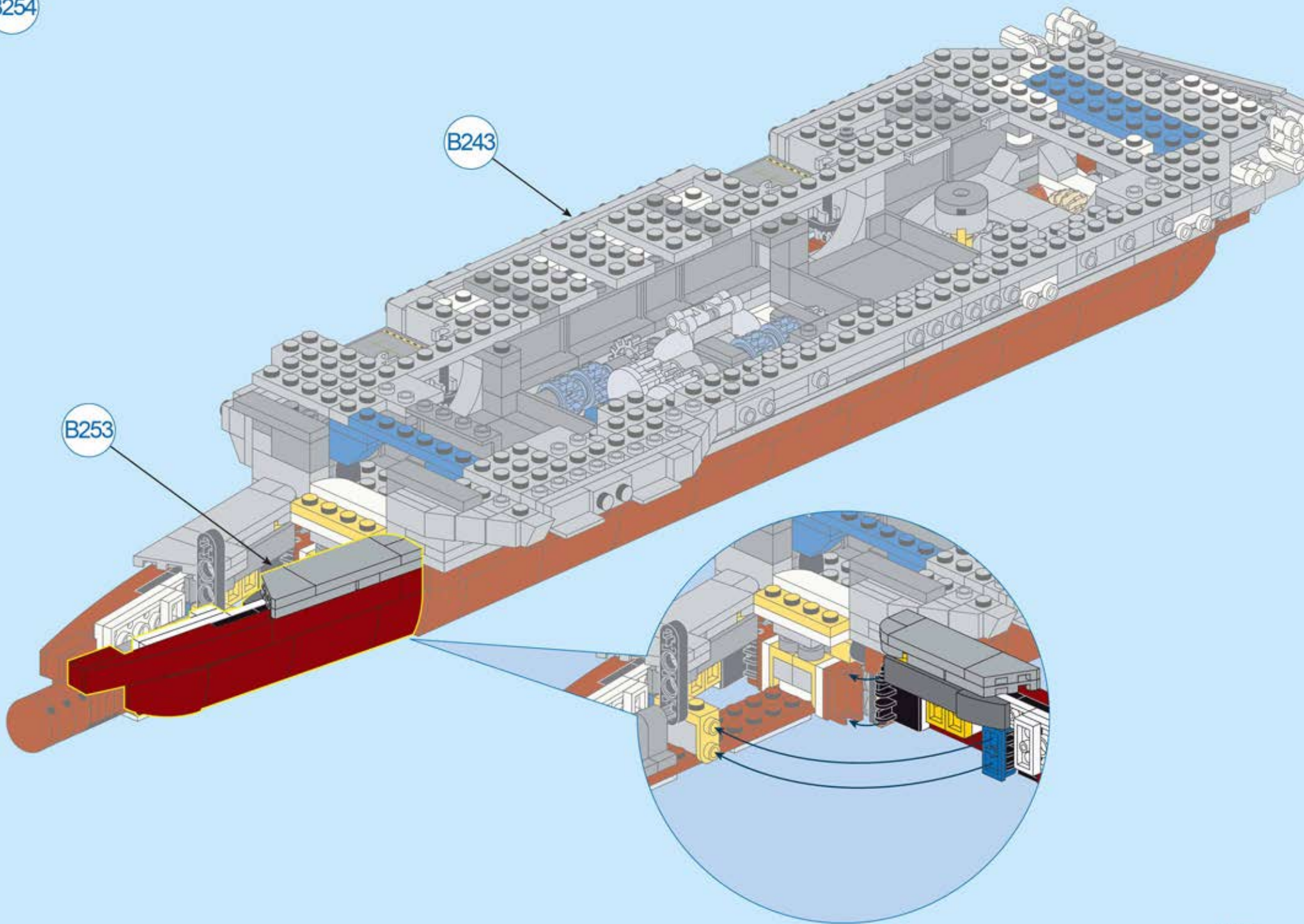

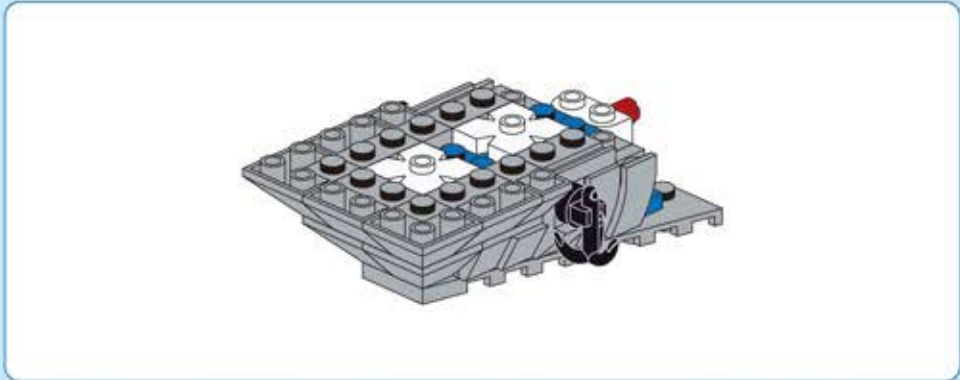

B255

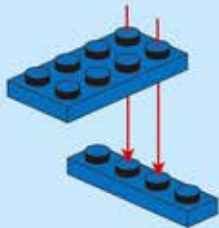
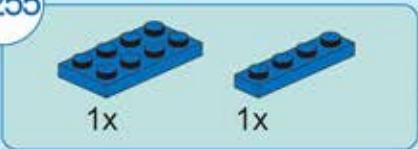

B256



B257

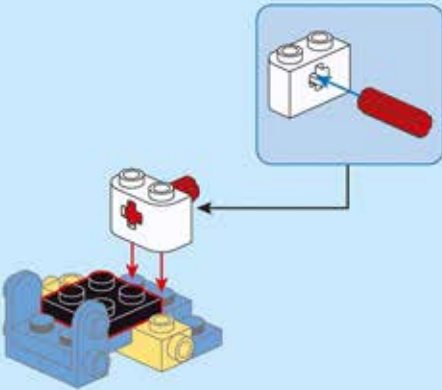

B258



B259

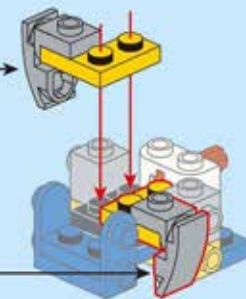
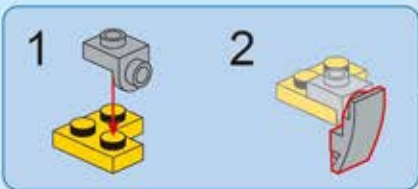
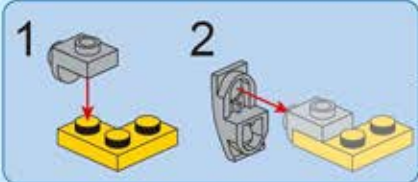

B260

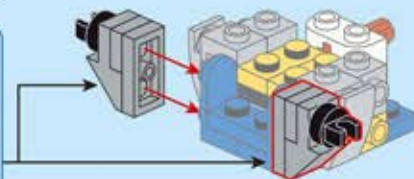
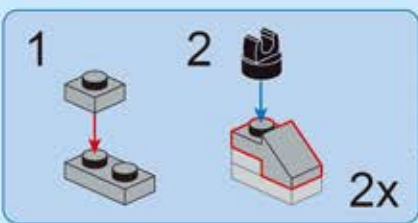

B261

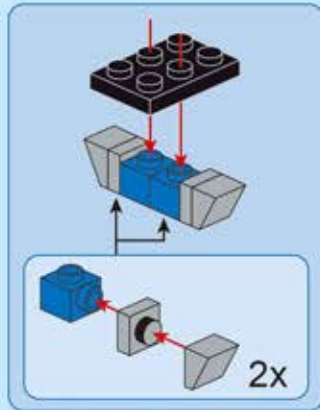

B262

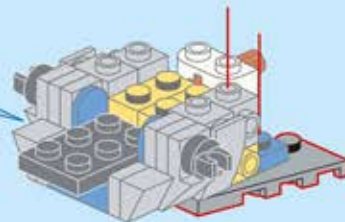
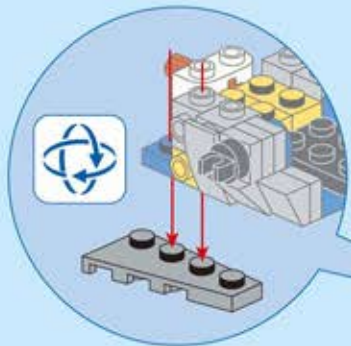
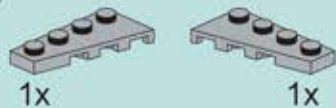

B263

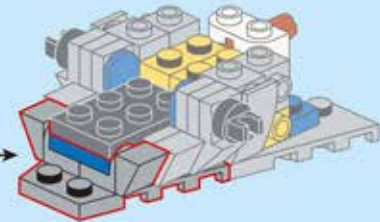
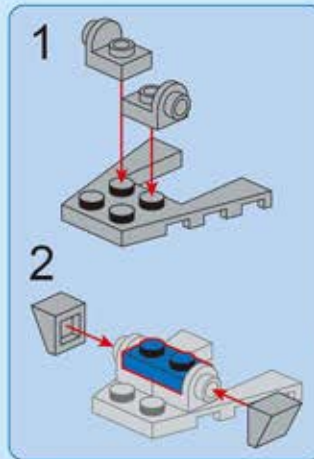
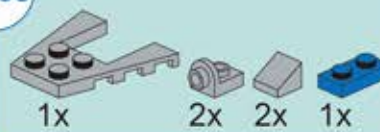

B264

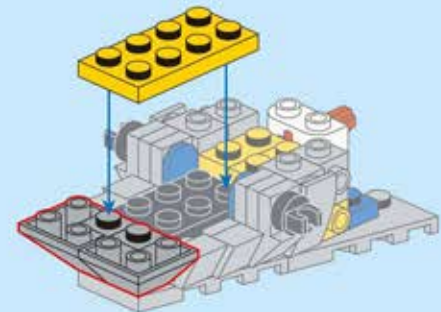

B265

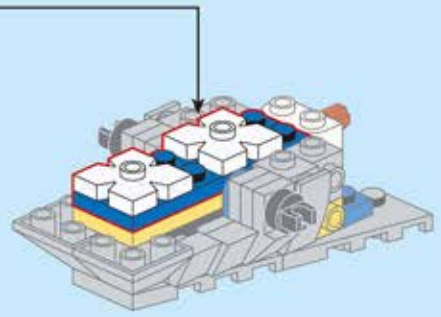
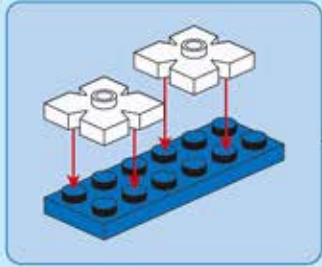
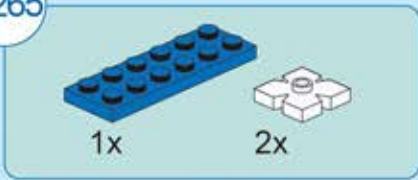

B266

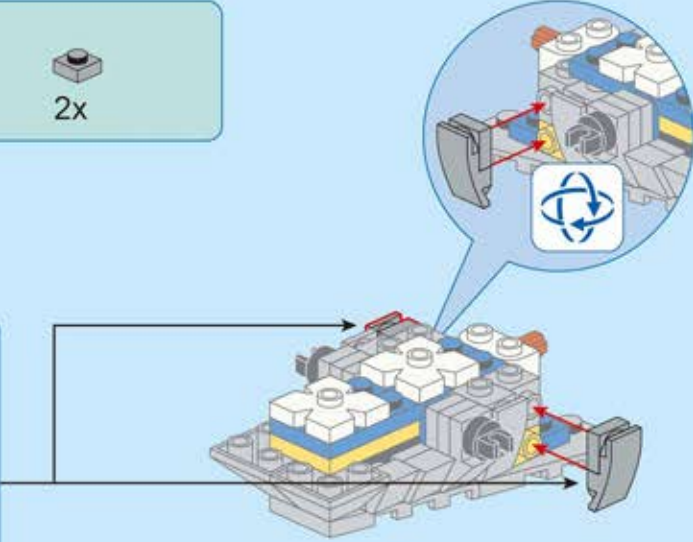
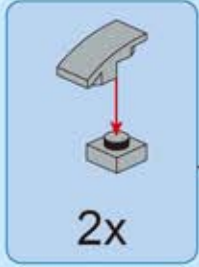

B267

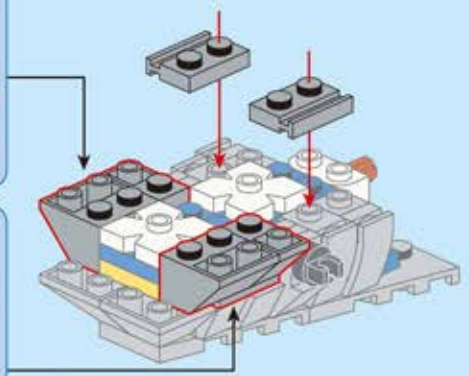
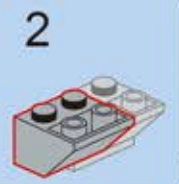
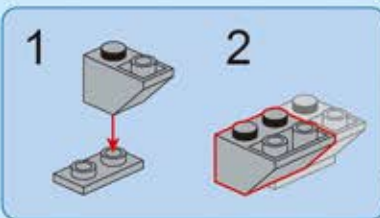
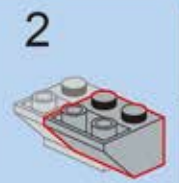
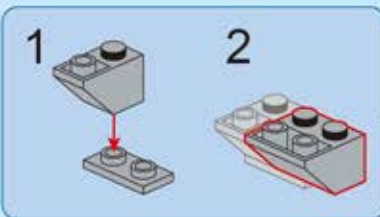
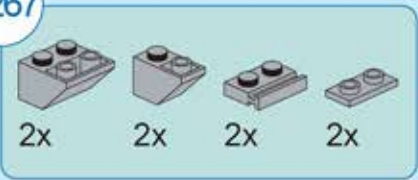

B268

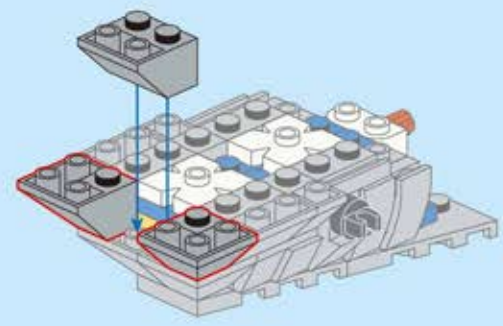
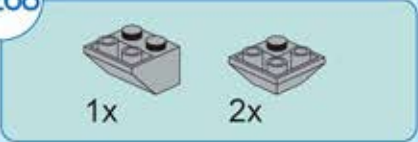

B269

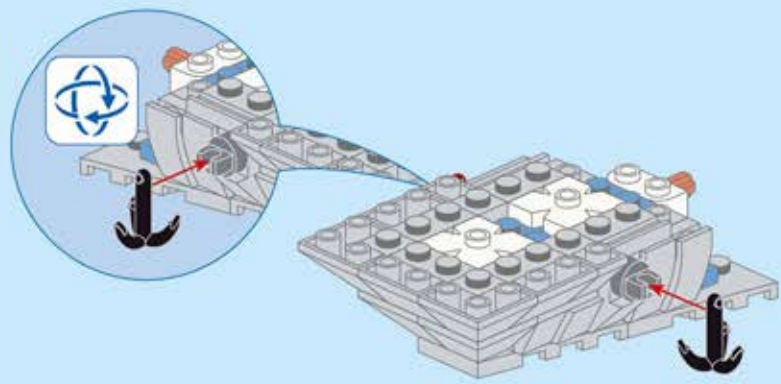

B270

B254

B269

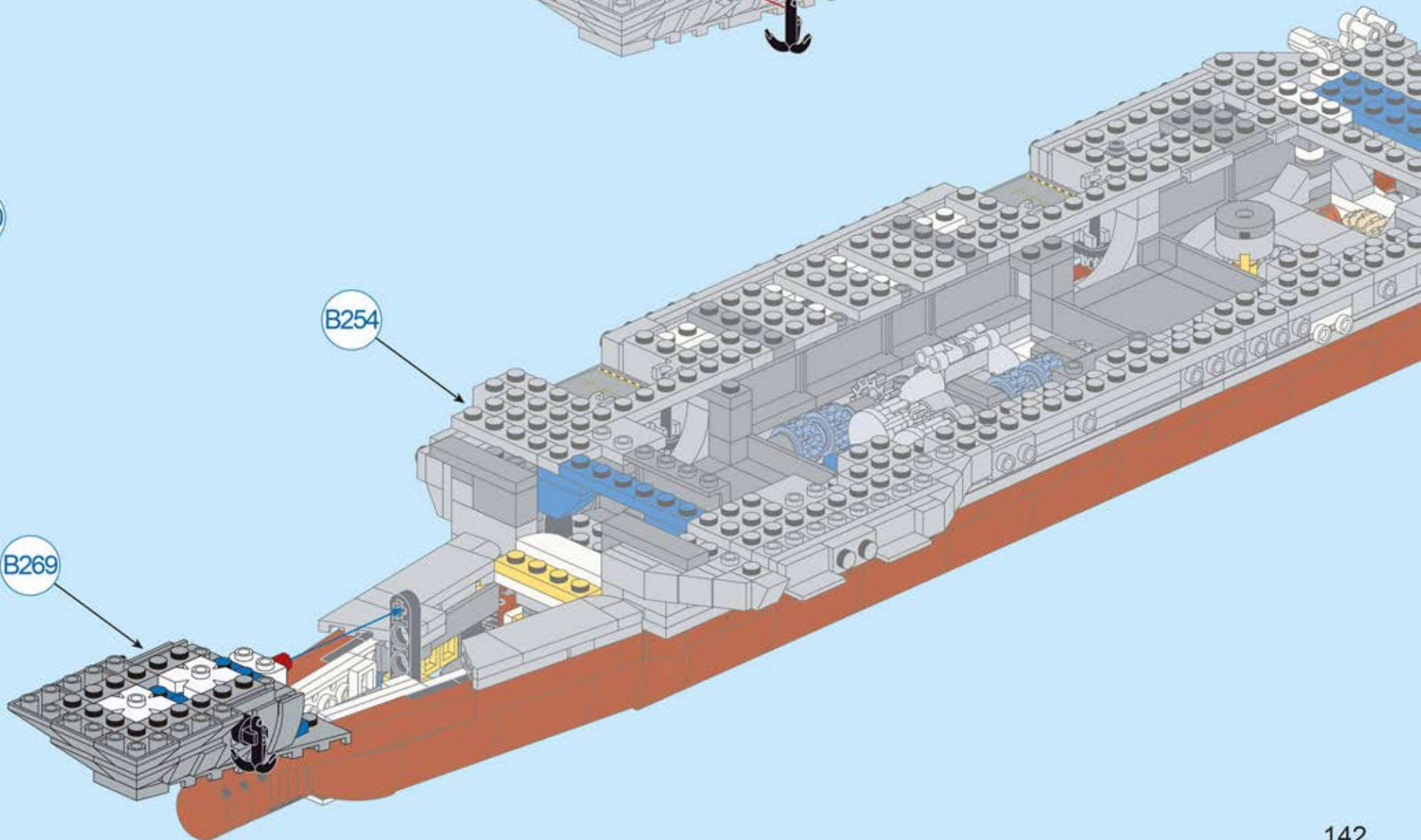

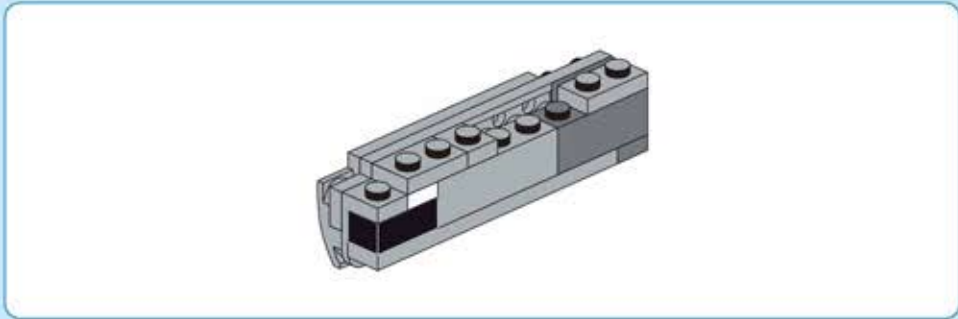

B271

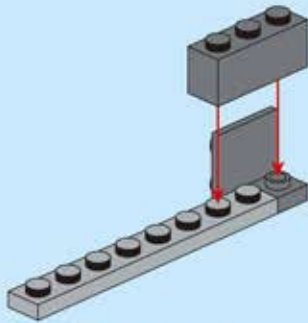
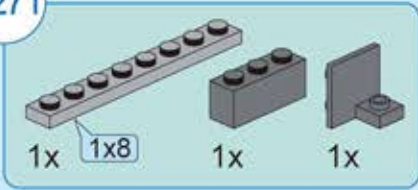

B272

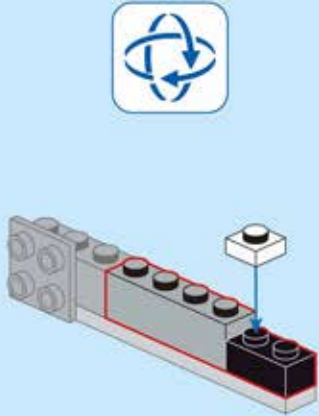
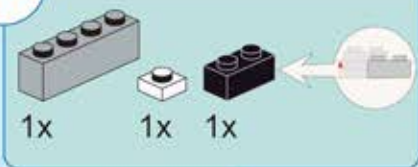

B273

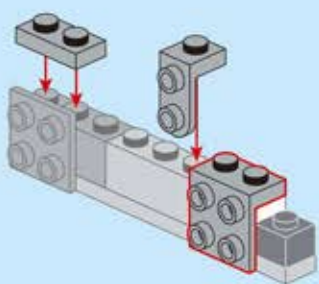
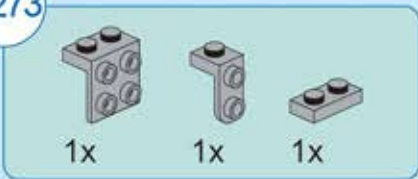

B274

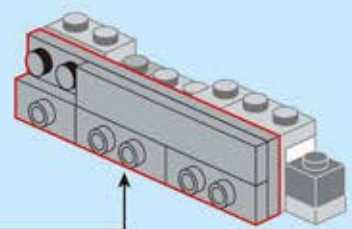
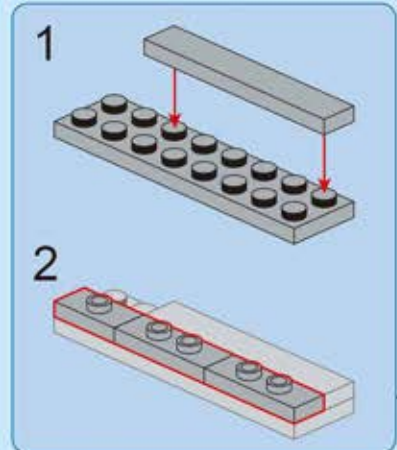
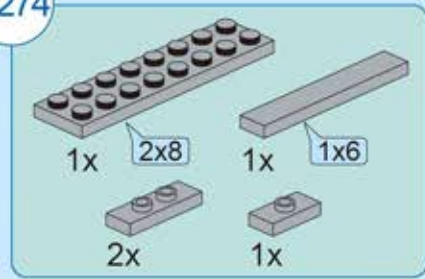

B275

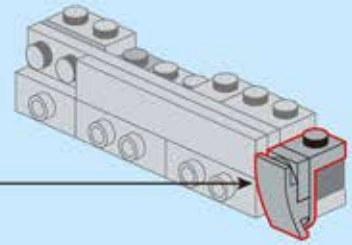
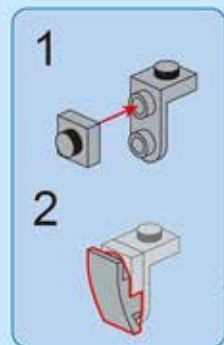
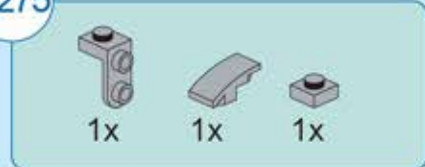

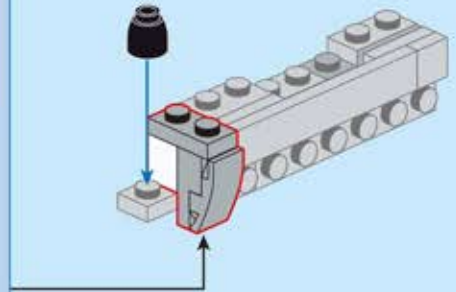
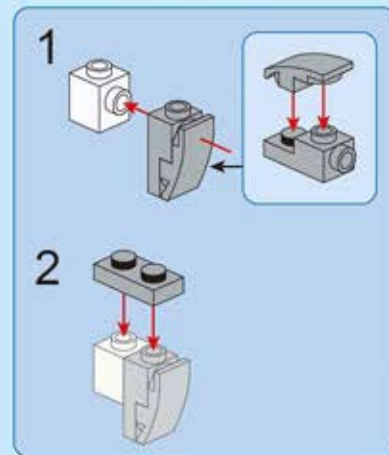
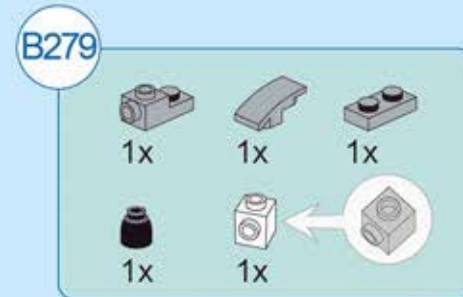
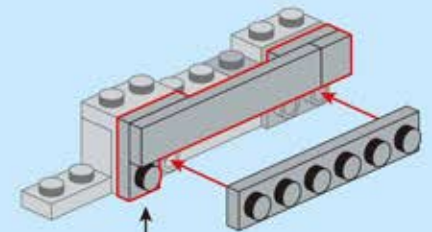
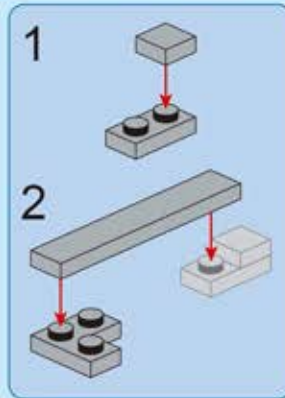
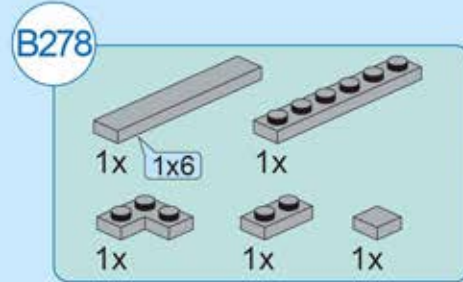
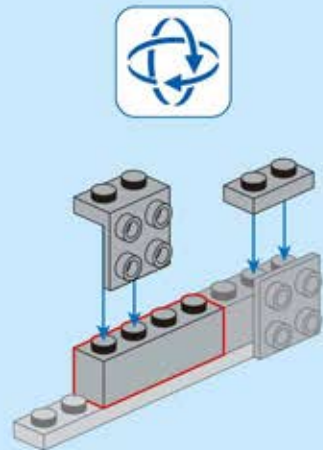
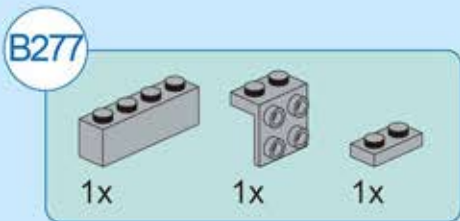
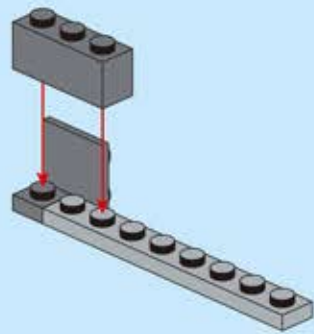
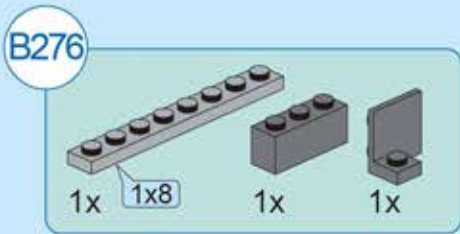
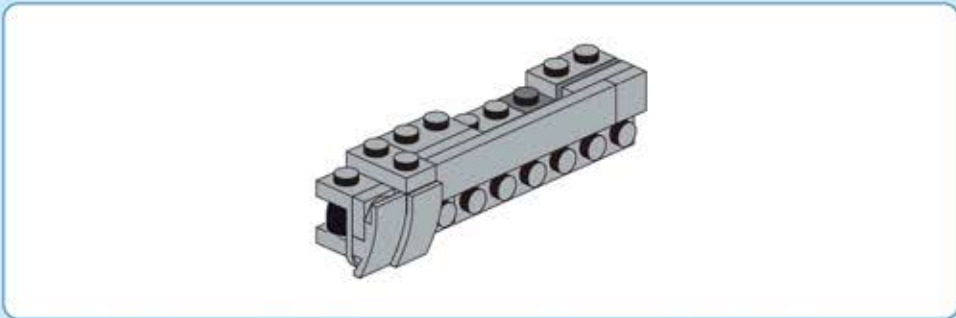

B280

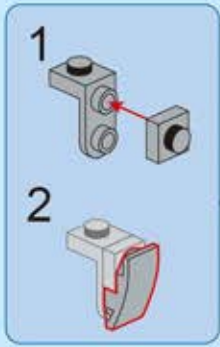
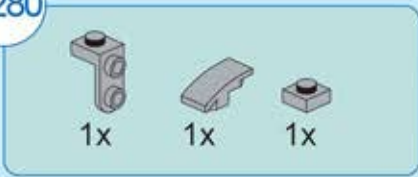

B270

B281

B280

B275



B282

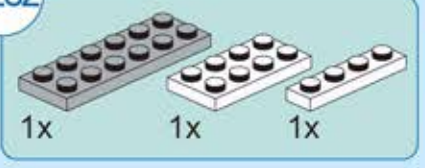

B283

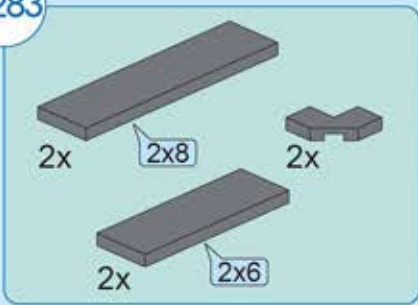

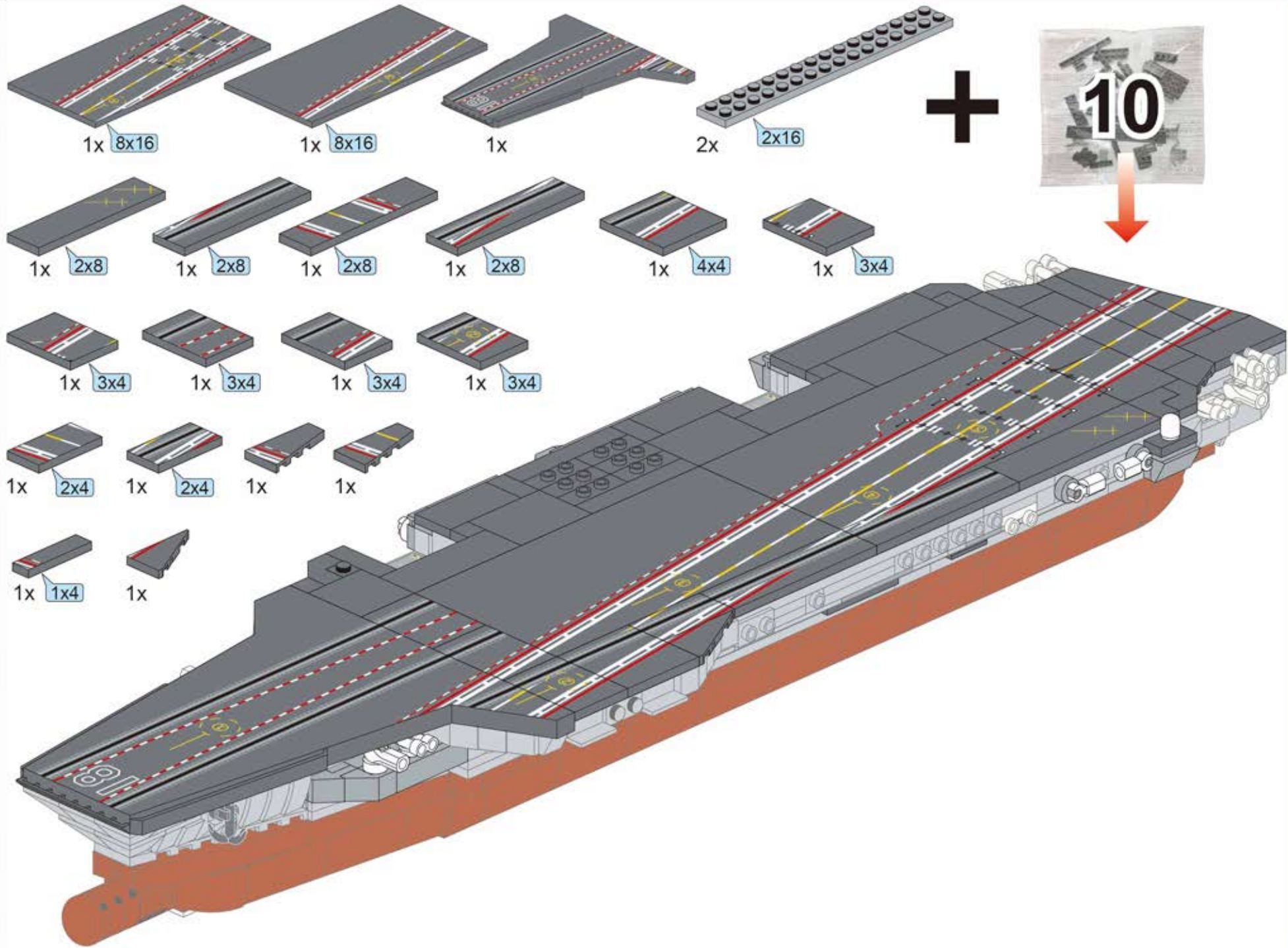



B284

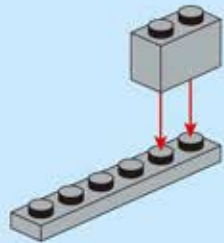
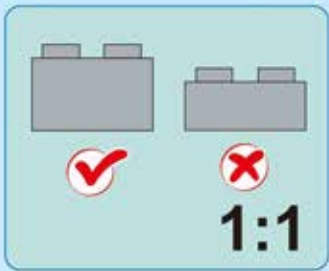
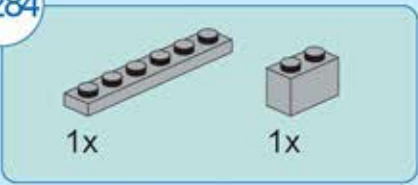

B285

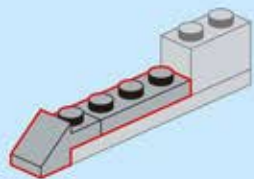
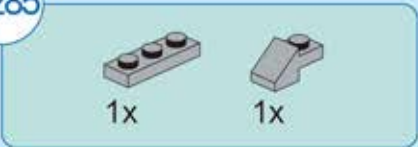

B286

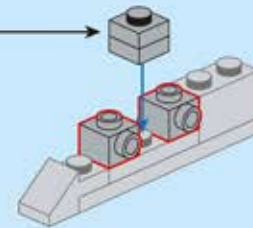
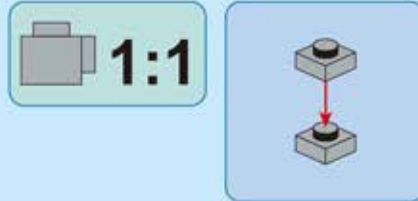
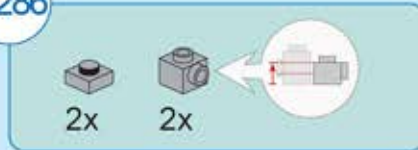

B287

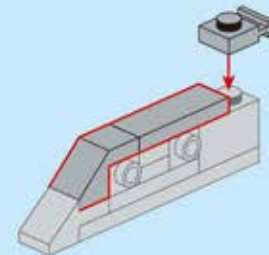
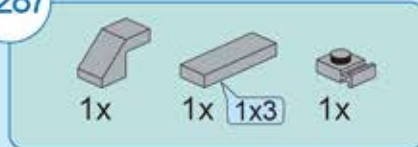

B288

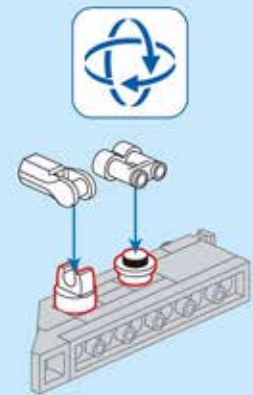

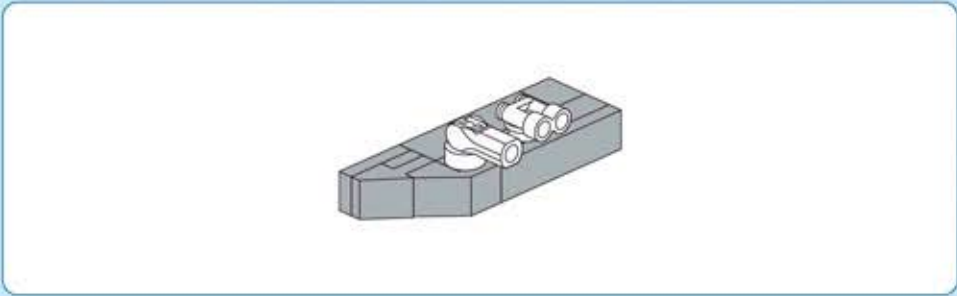

B289

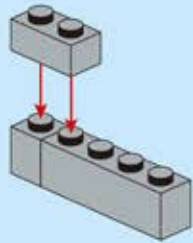
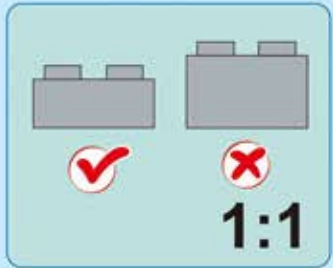
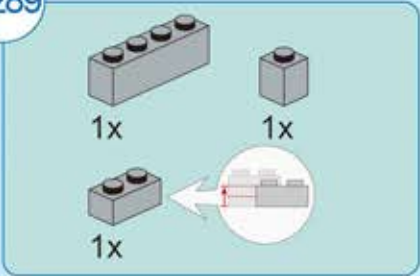

B290

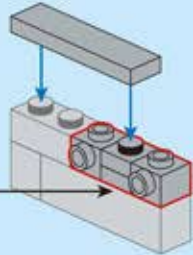
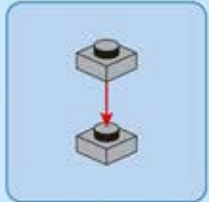
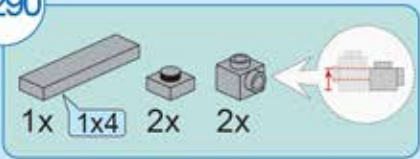

B291

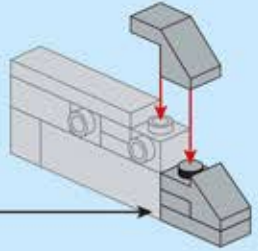
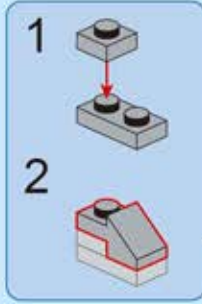
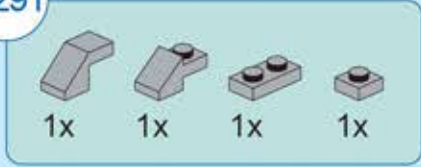

B292

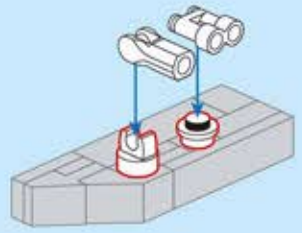

B293

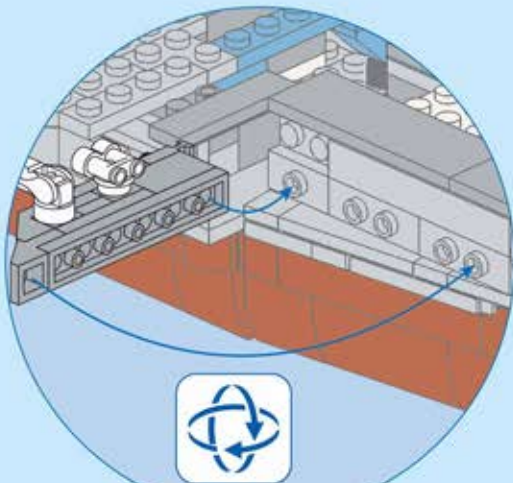

B283

B288

B292

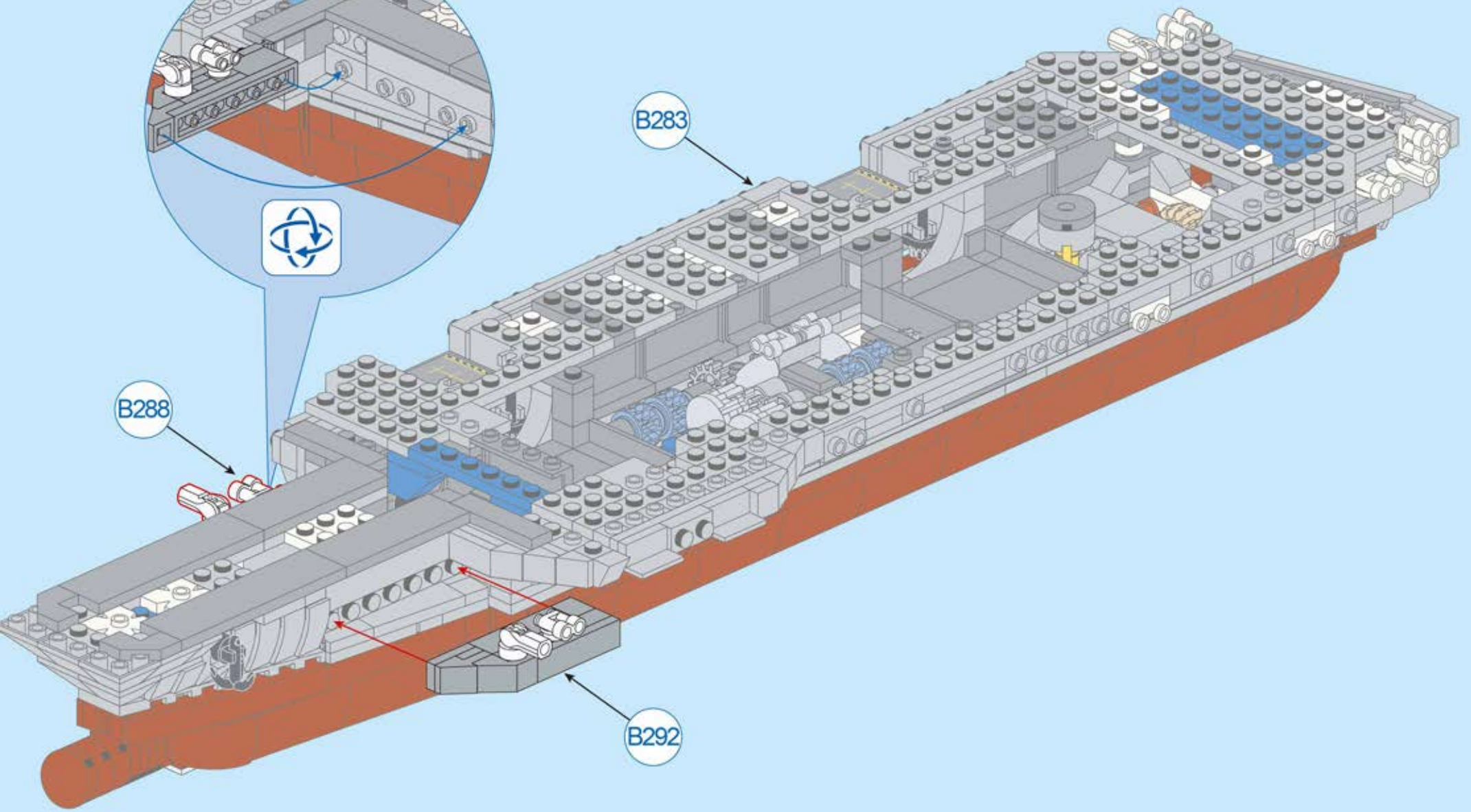

B294

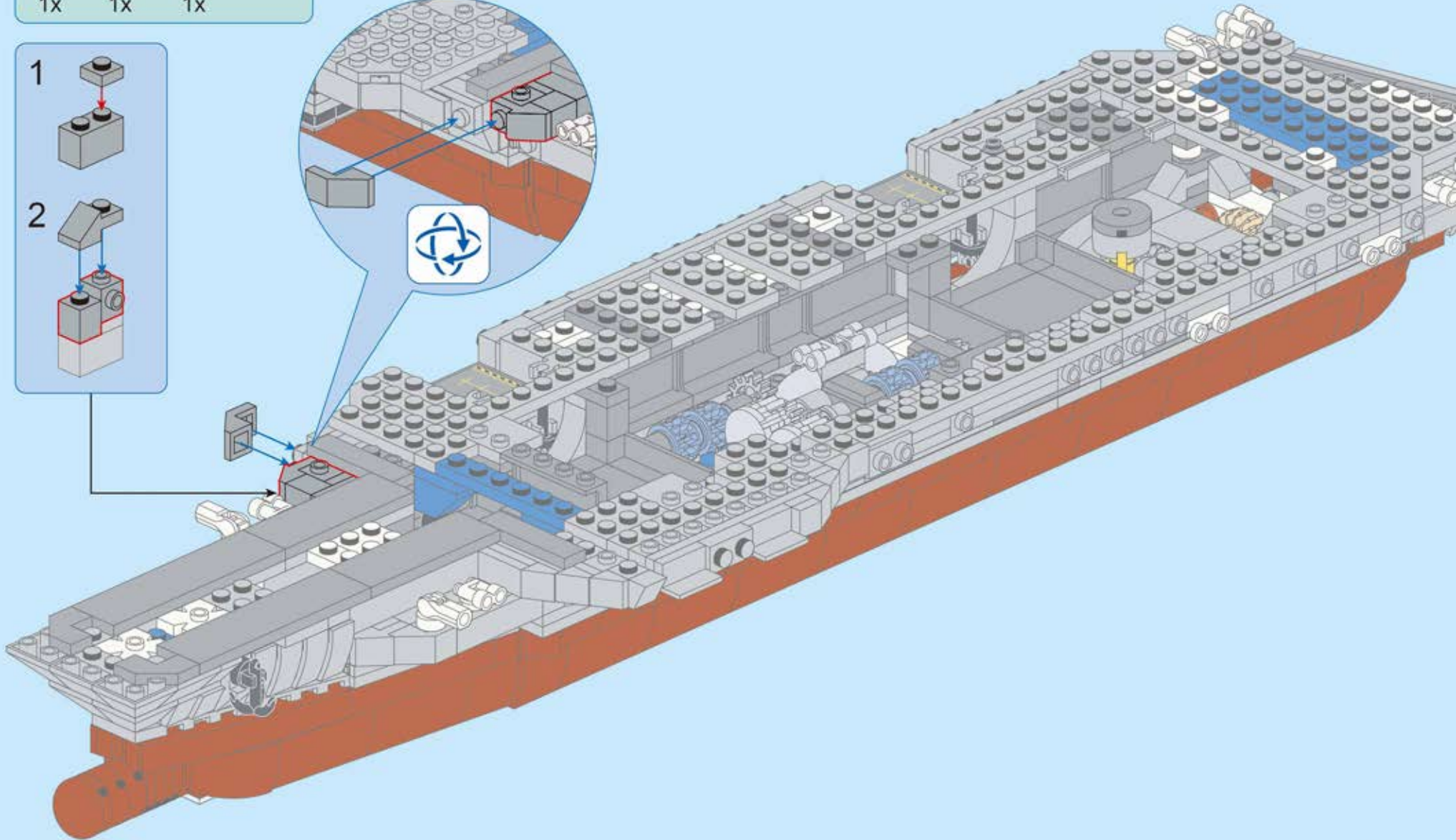
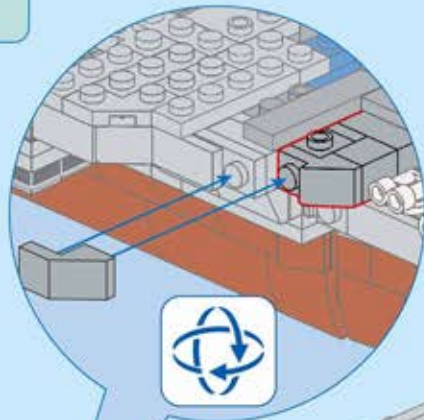
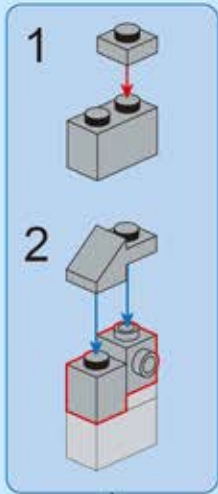
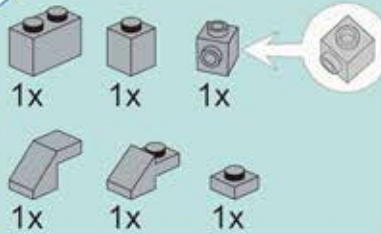

B295

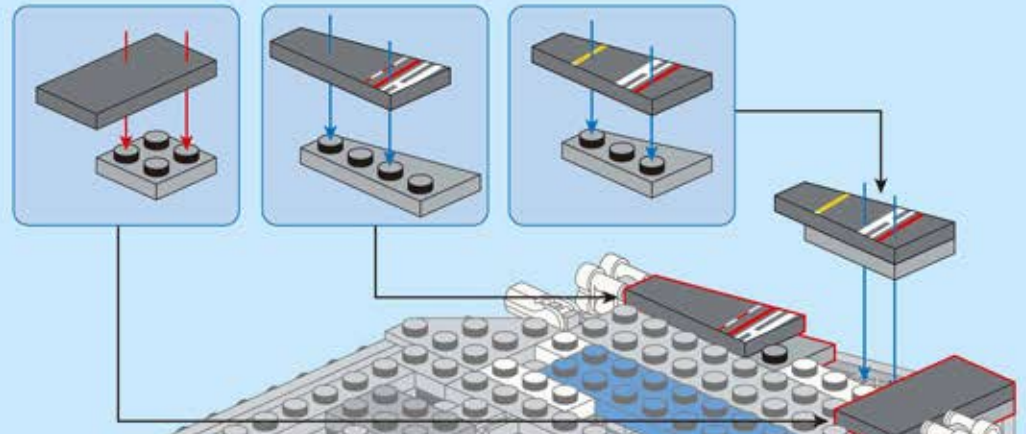
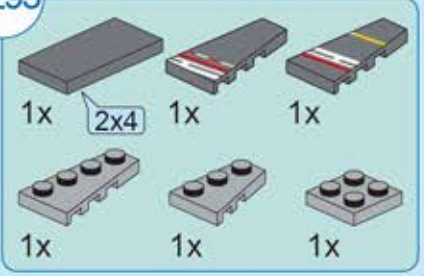

B296

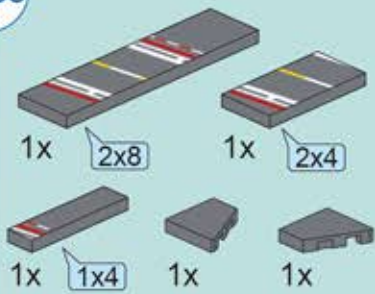

B297

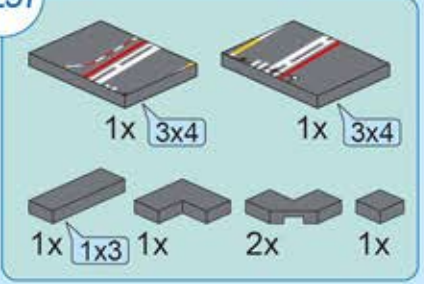

B298

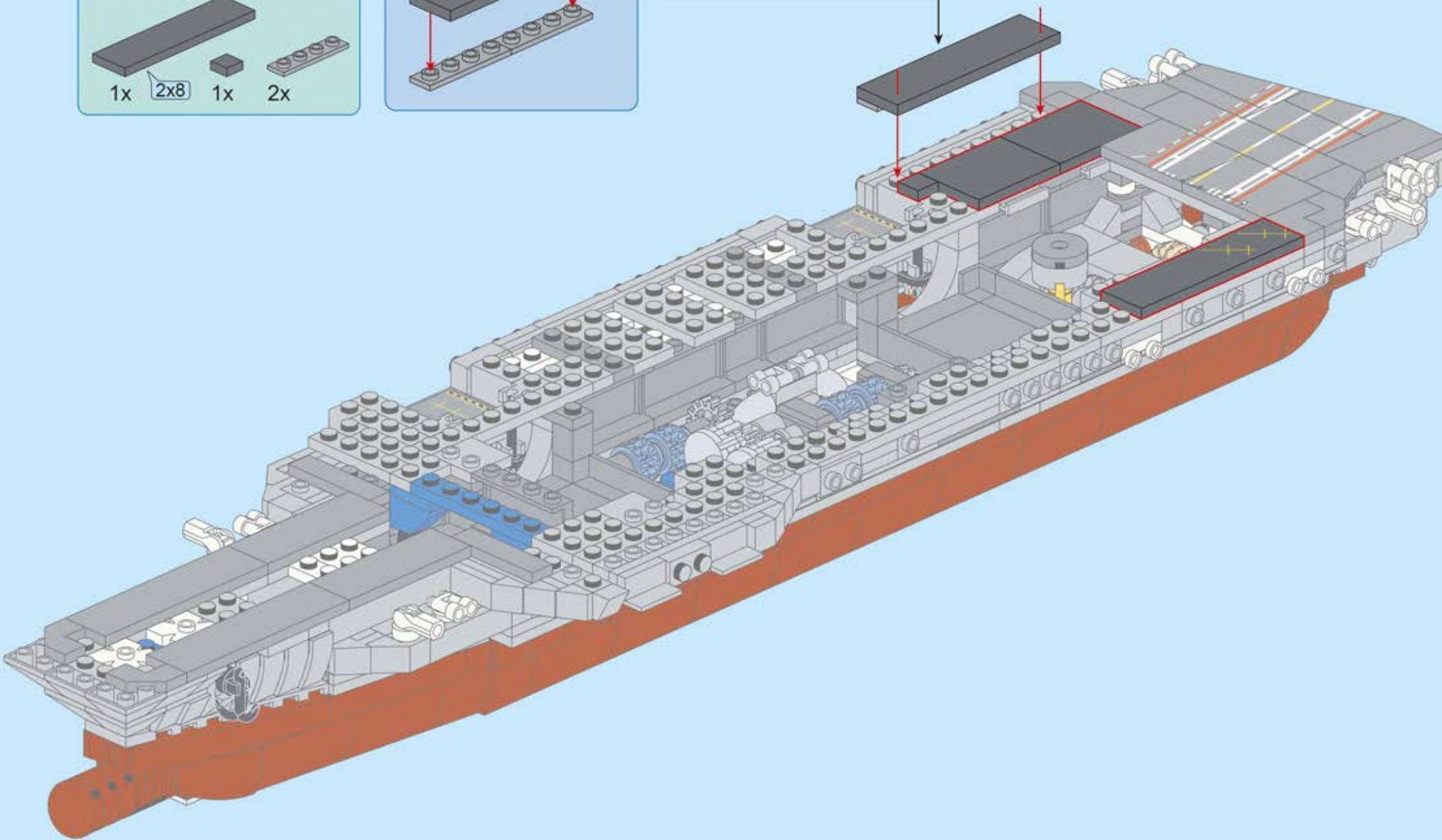
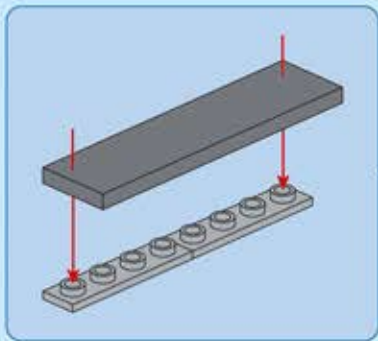
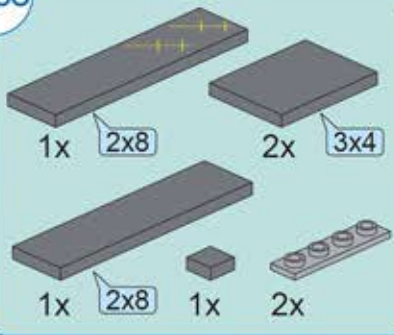

B299

- 1x 2x8
- 1x 3x4
- 1x 2x6
- 1x 2x4
- 1x 1x
- 1x 1x
- 1x 1x
- 1x 1x

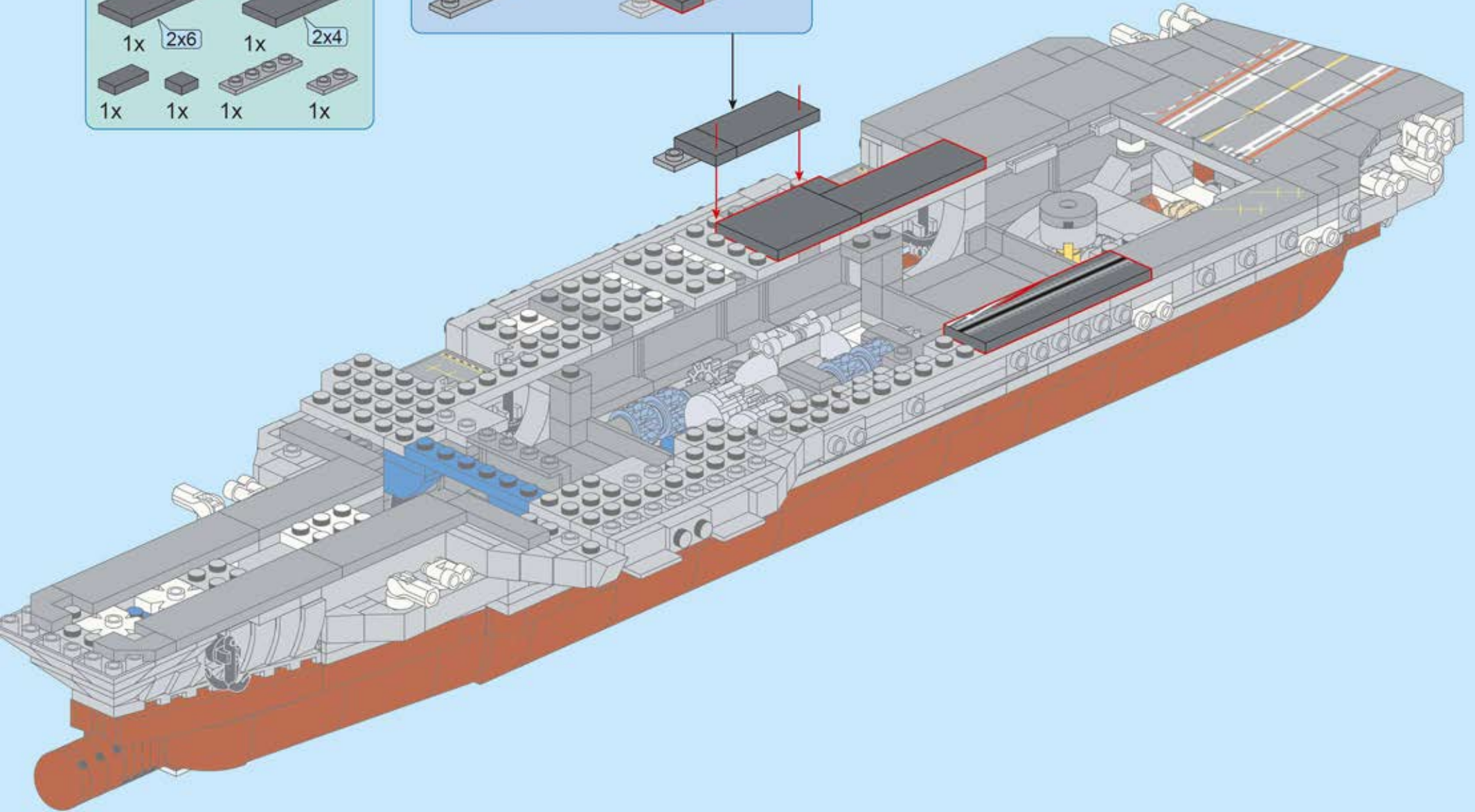
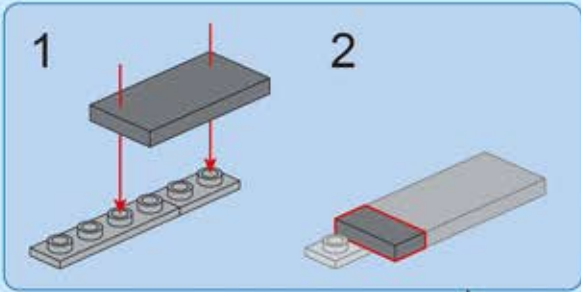

B300

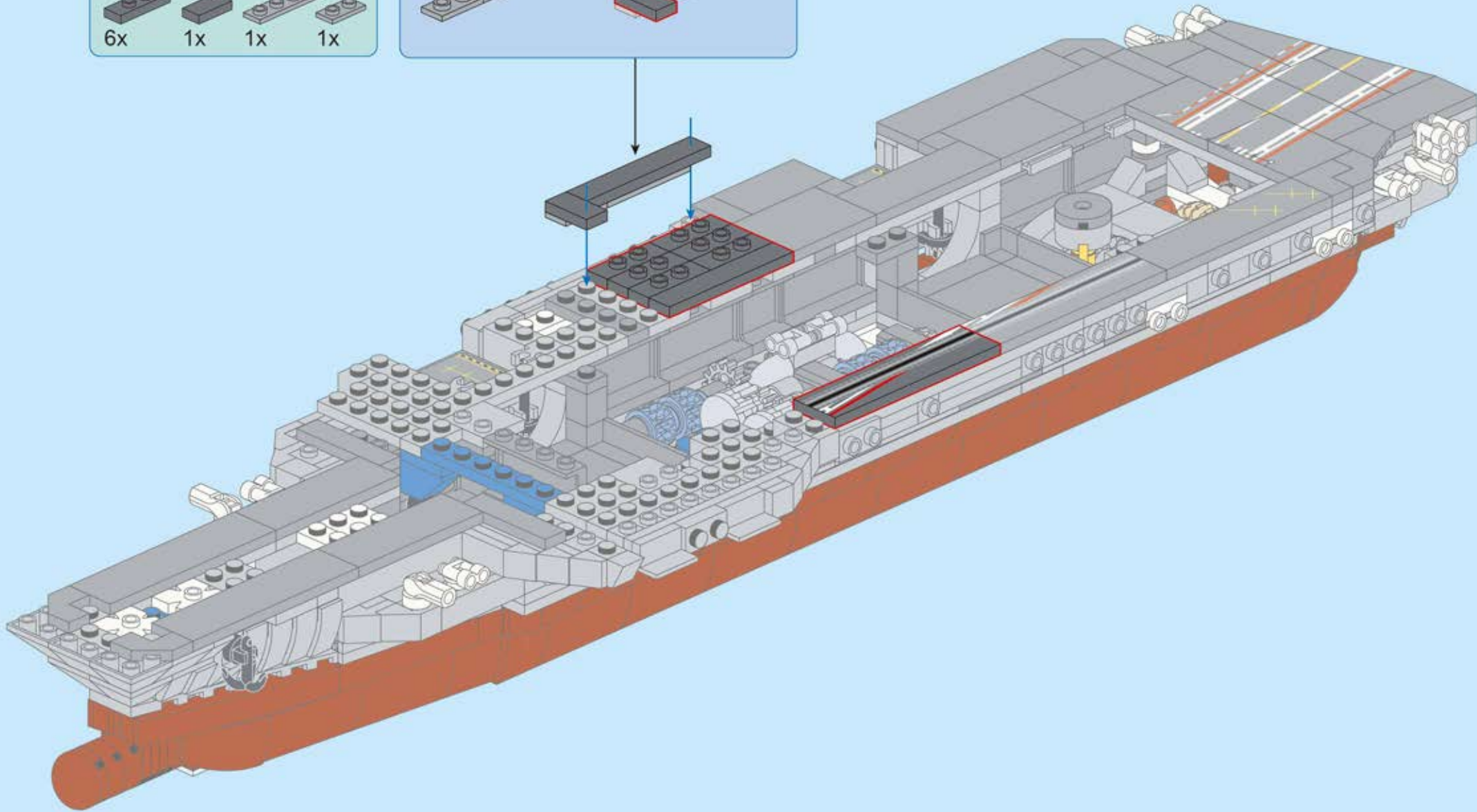
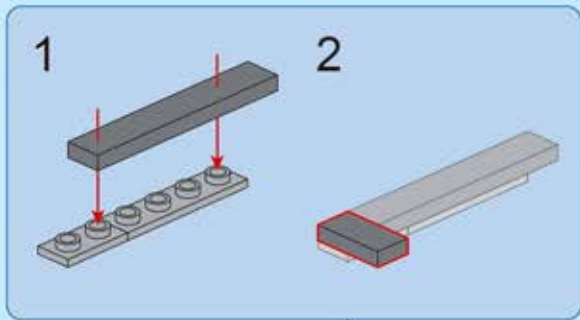
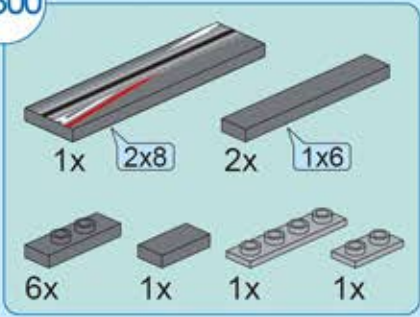

B301

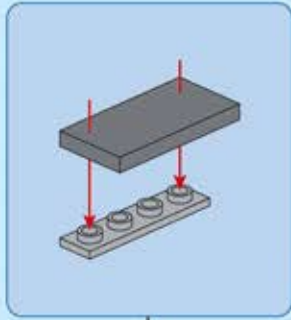
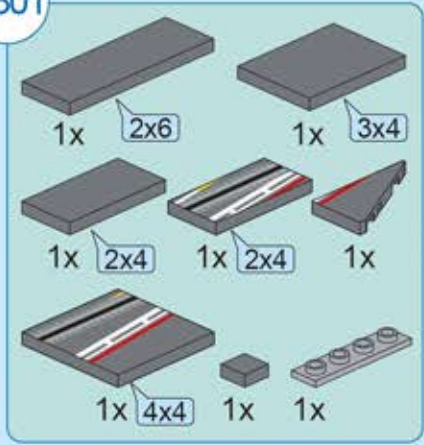

B302

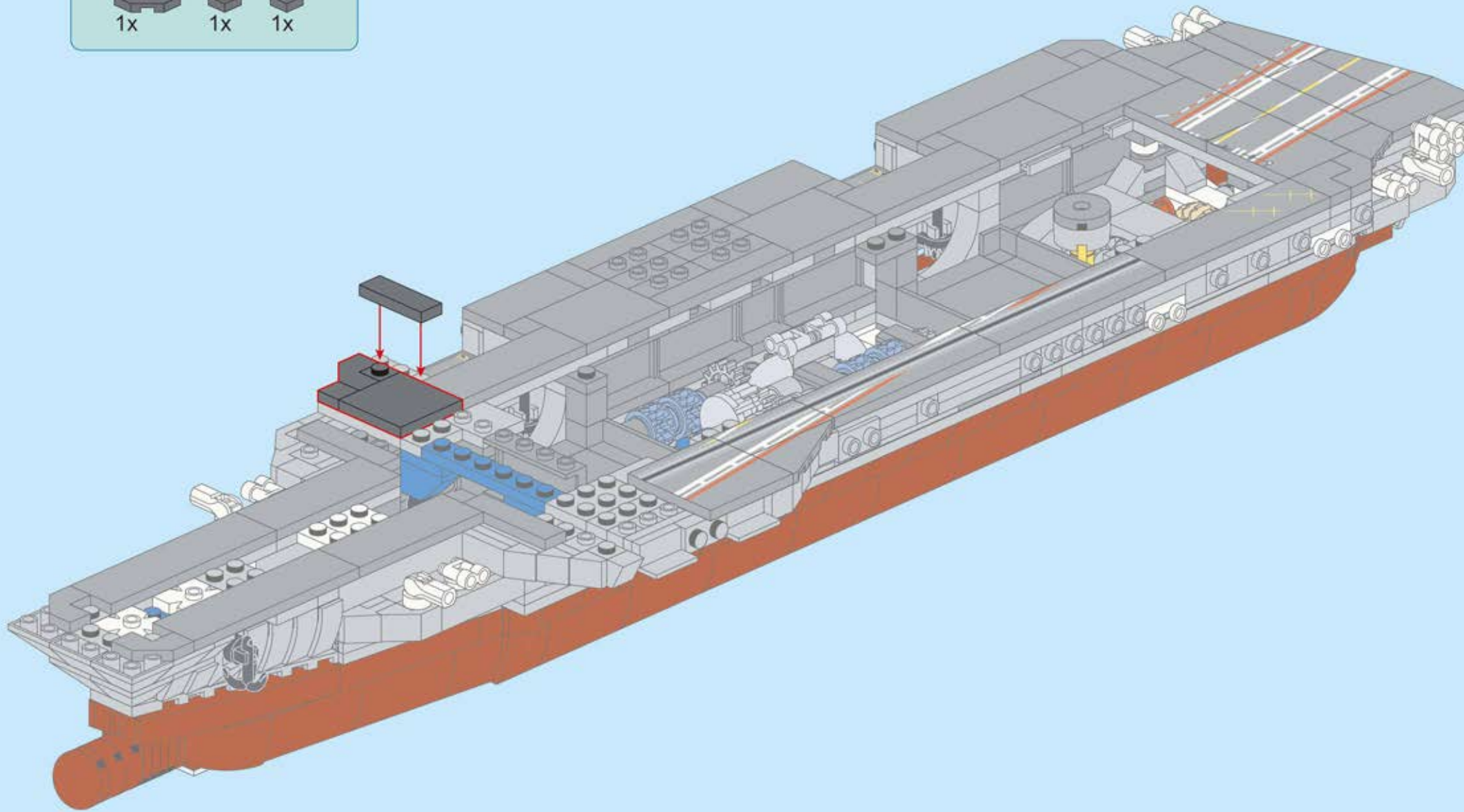
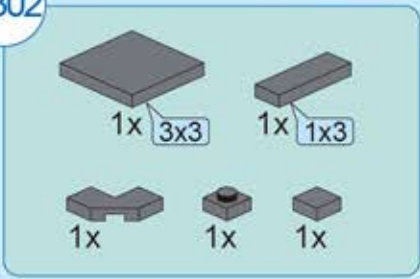

B303

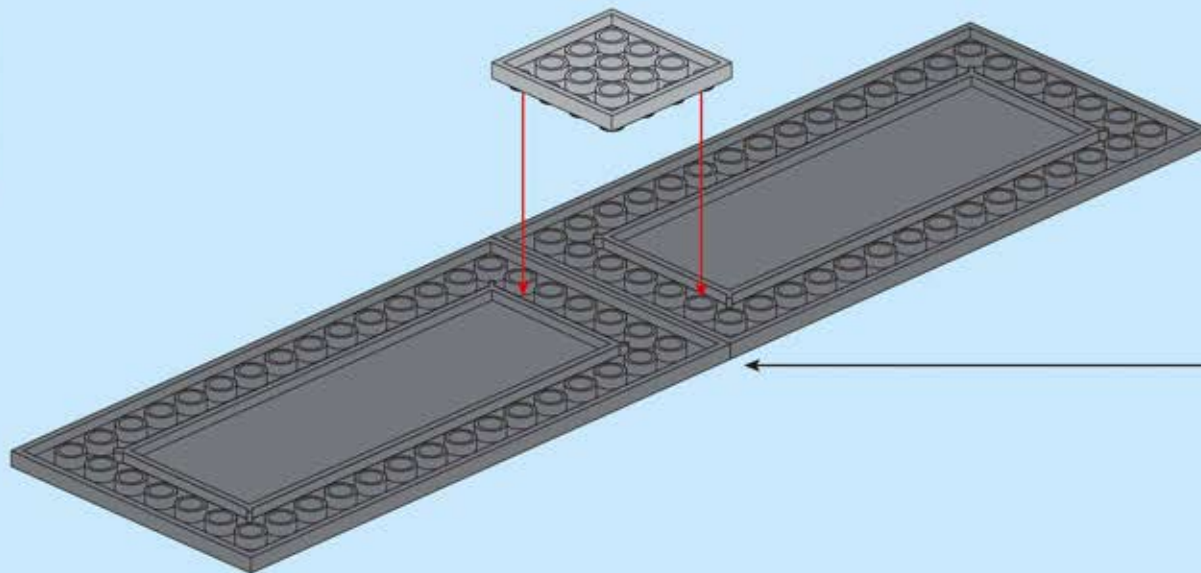
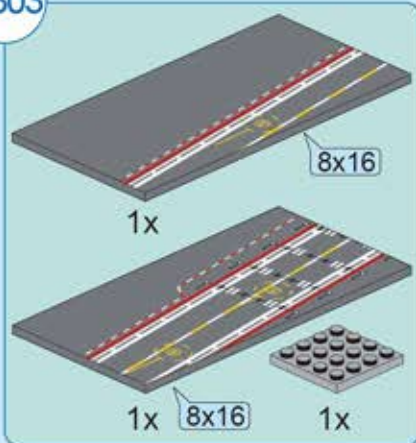

B304

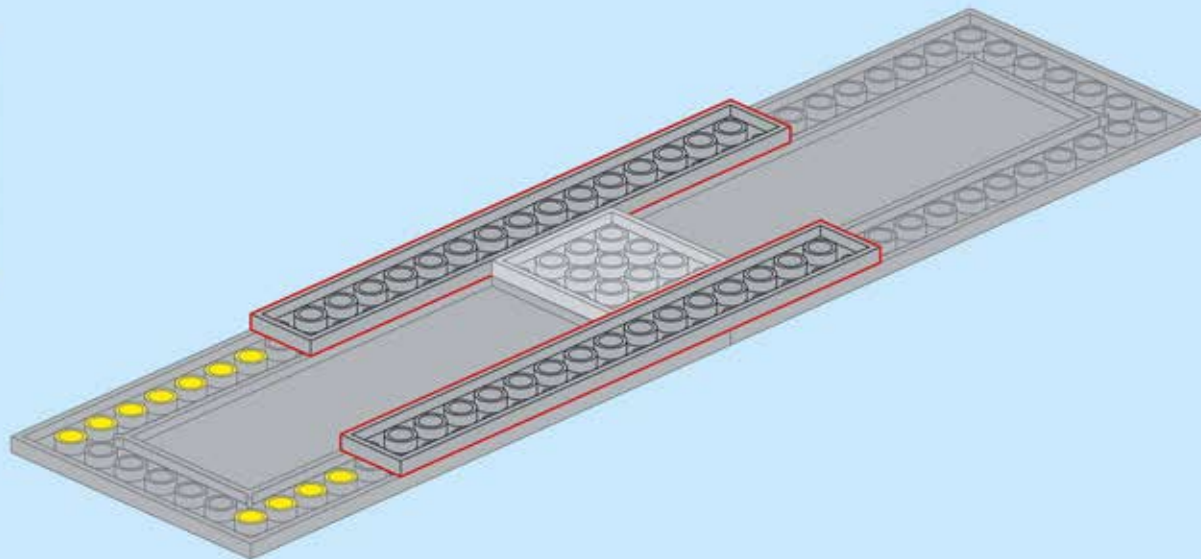
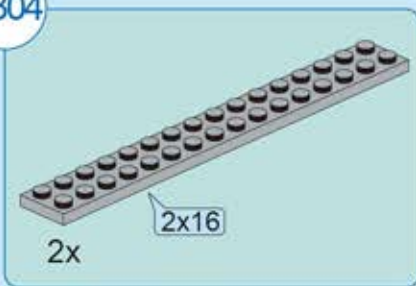

B305

B304

B302

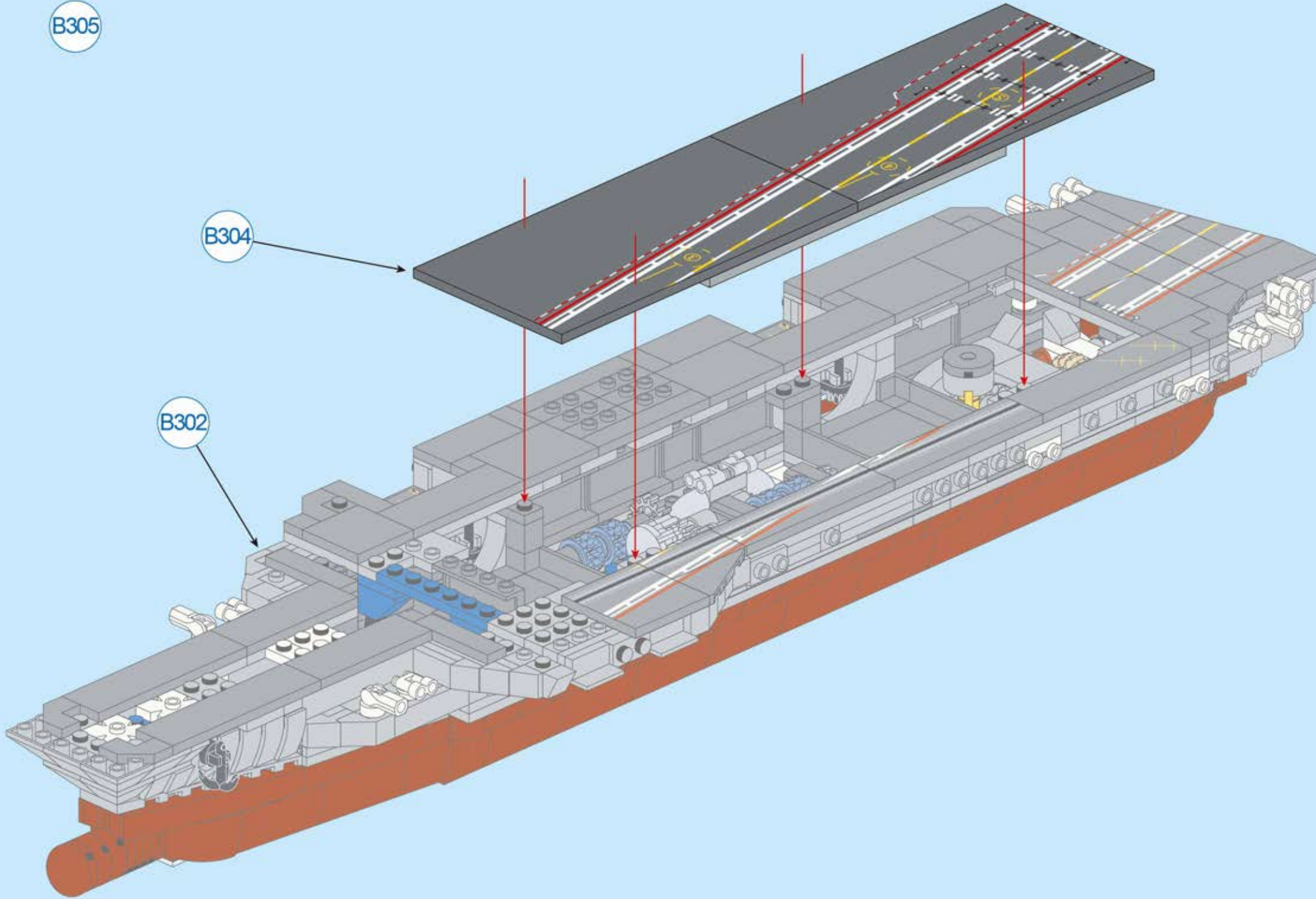

B306

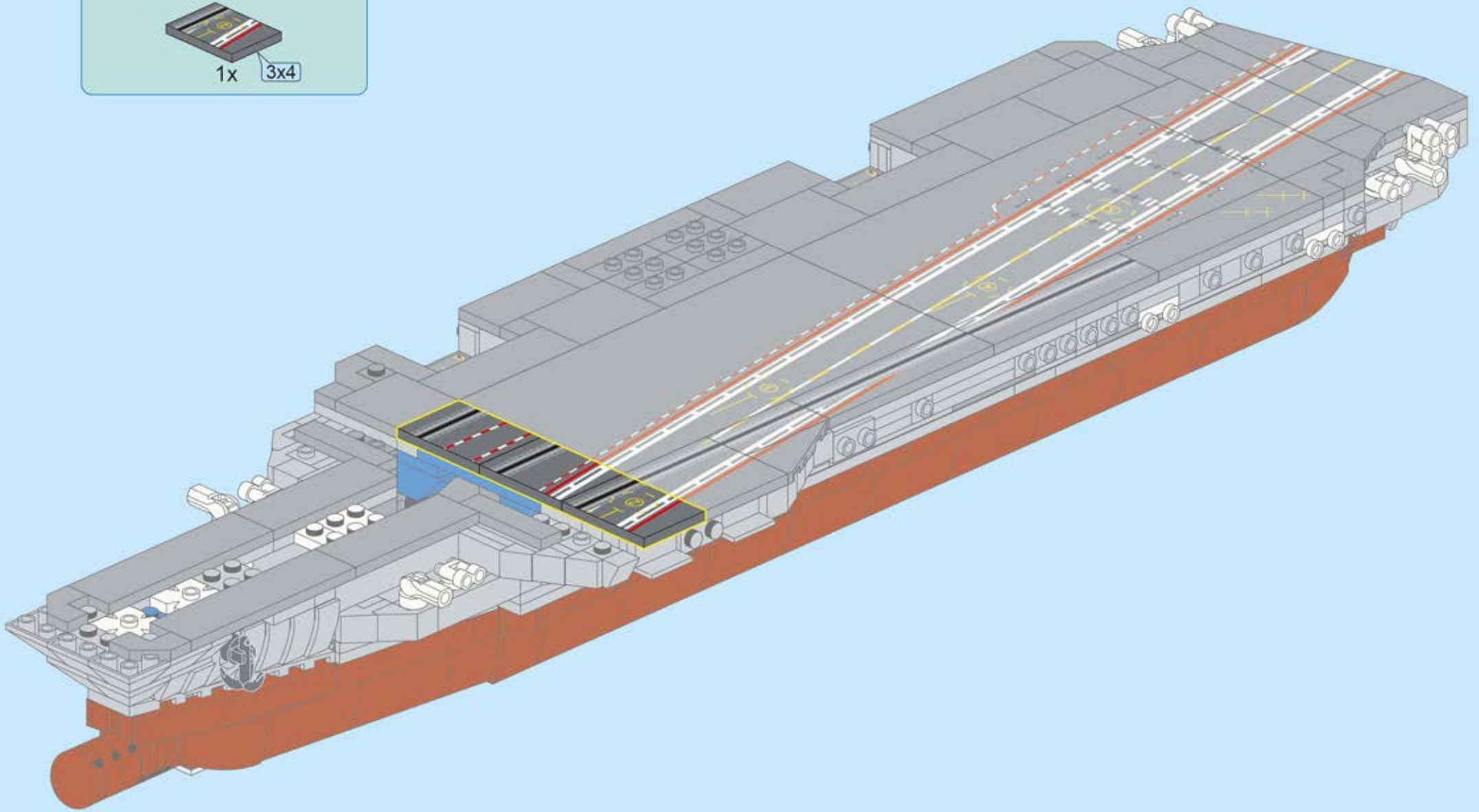
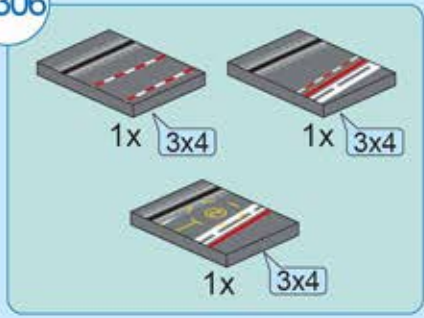

B307

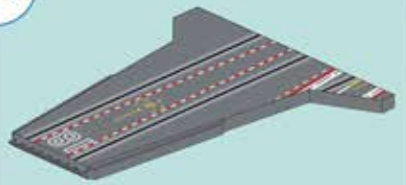

1x



B308

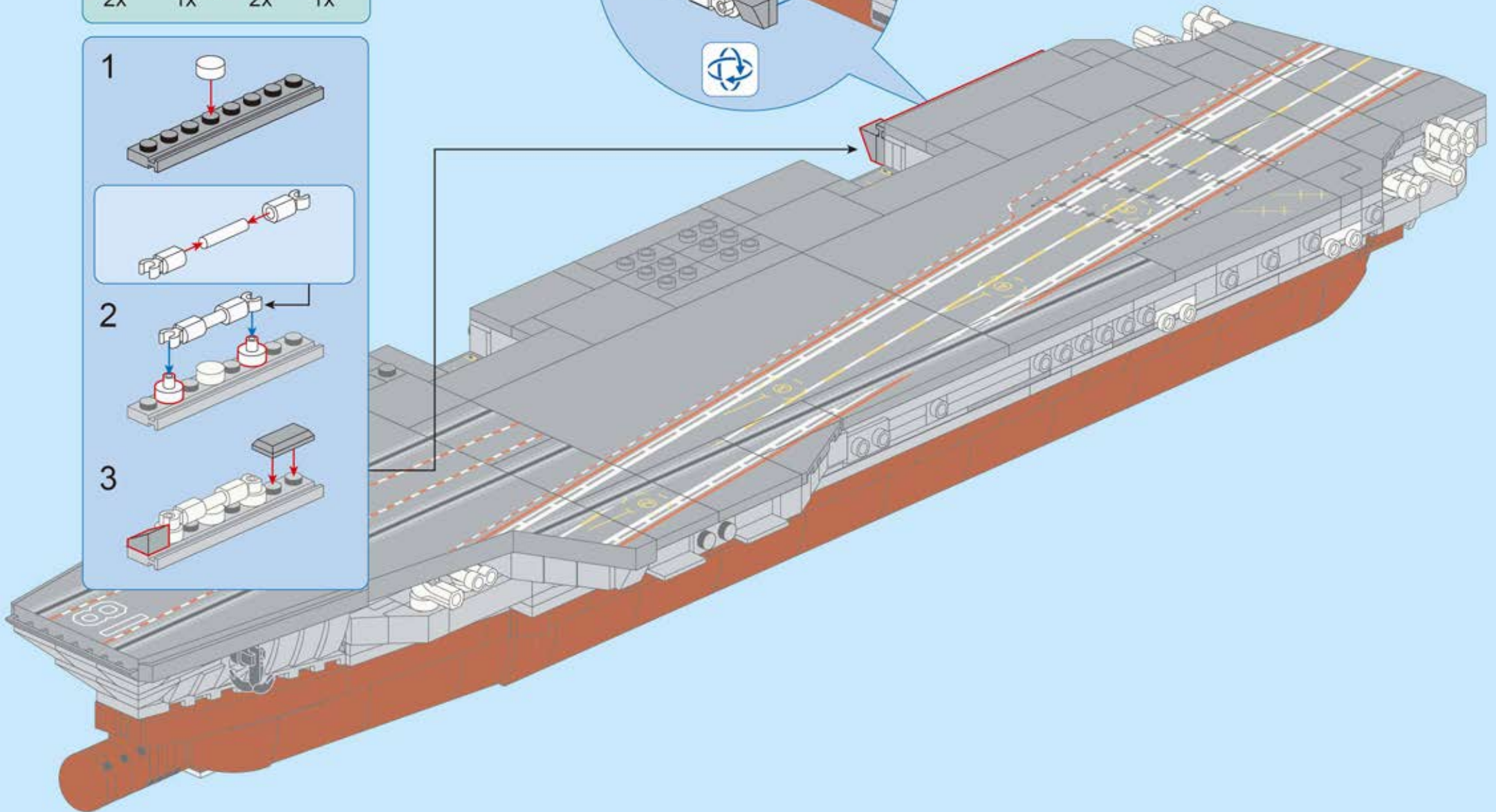
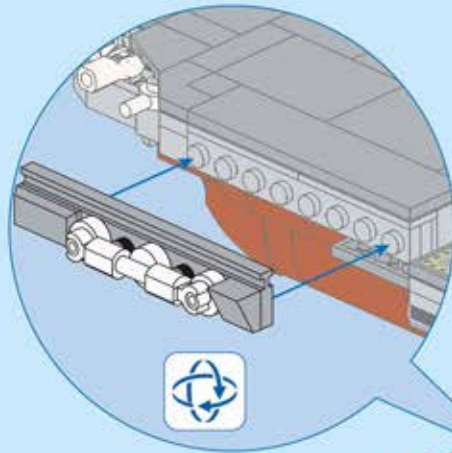
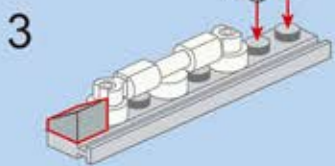
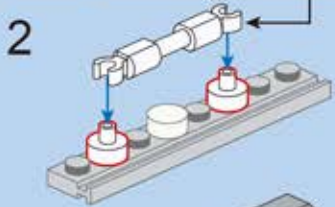
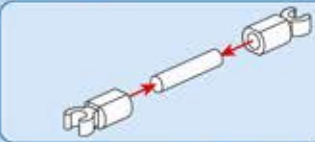
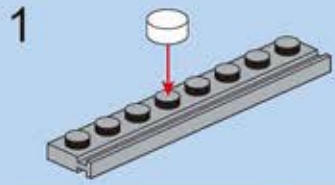
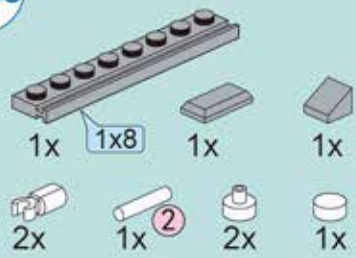

B309

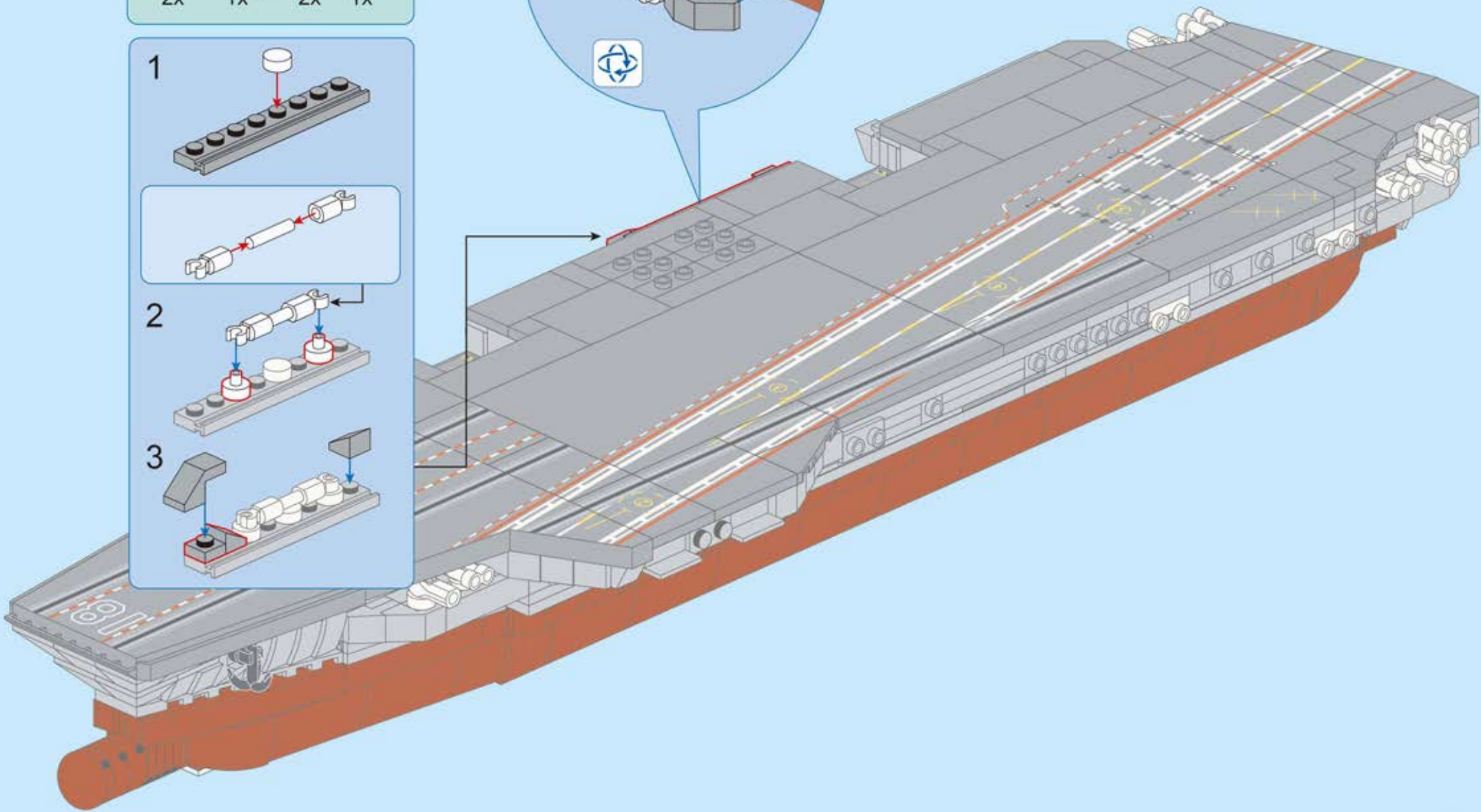
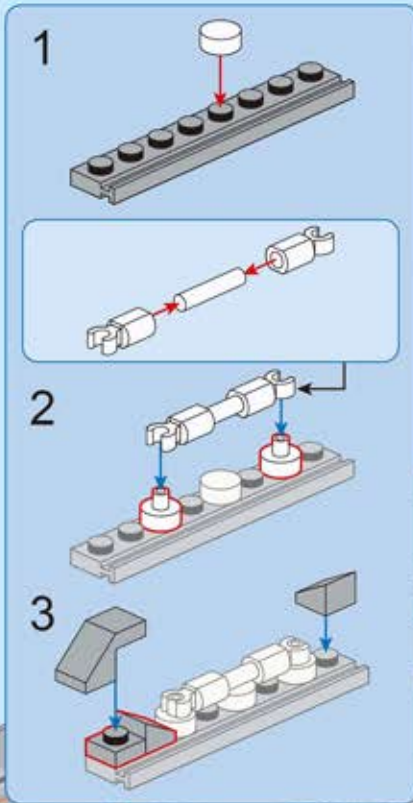
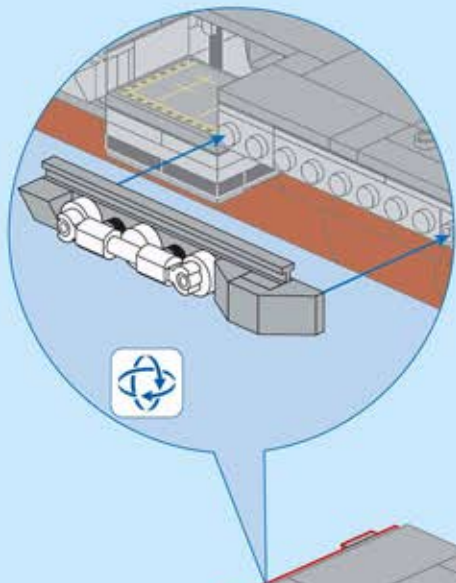
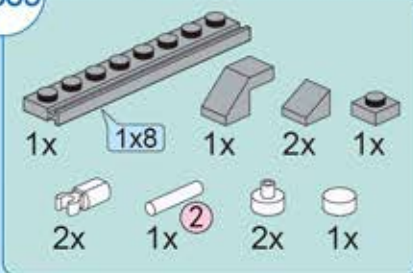

B310

- 1x [Grey 1x4 Technic Beam]
- 1x [Grey 1x2 Technic Beam]
- 2x [Grey Technic Pin]
- 1x [White Technic Pin]
- 2x [White Technic Pin]
- 1x [White Technic Pin]

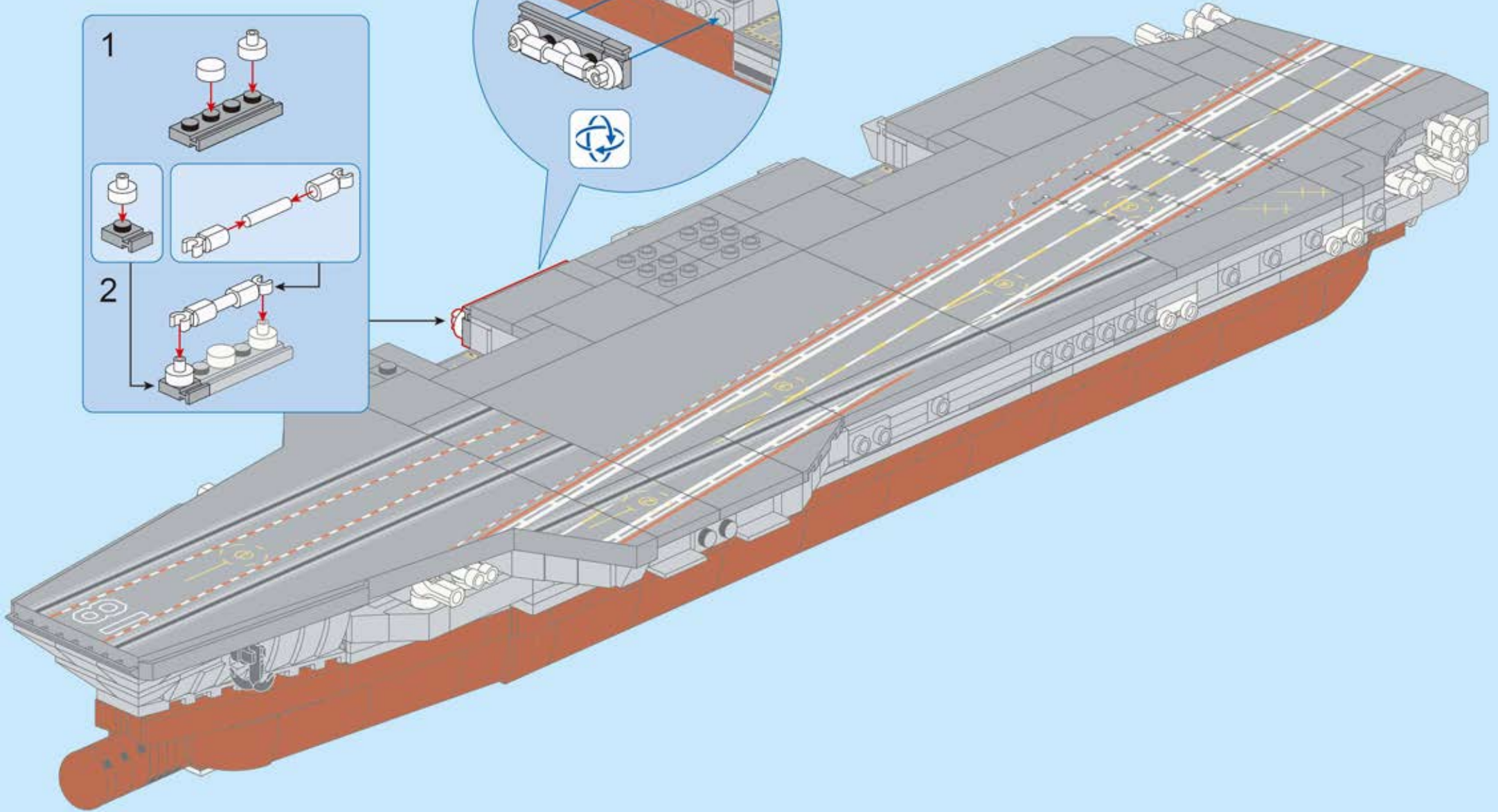
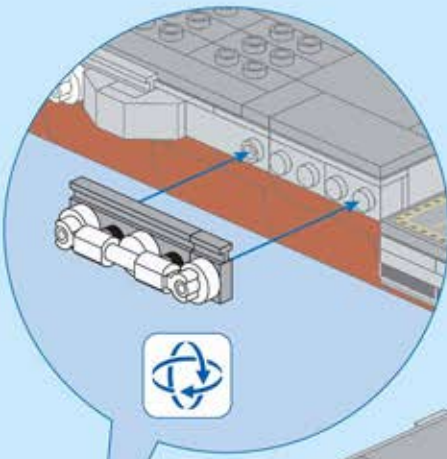
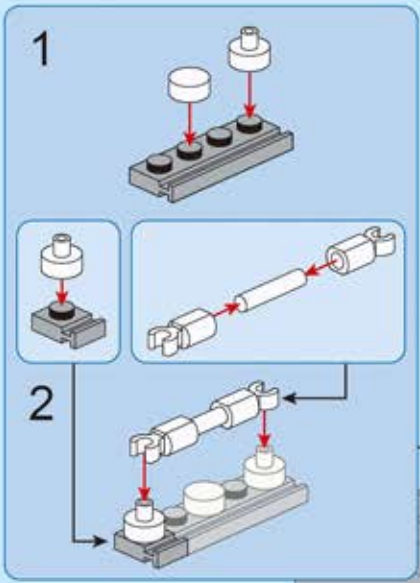

B311

- 1x [1x 1x3 grey Technic beam]
- 1x [1x 1x2 grey Technic beam]
- 3x [3x 1x2 grey Technic pins]
- 2x [2x 1x2 grey Technic pins]
- 6x [6x 1x2 grey Technic pins]
- 2x [2x 1x2 grey Technic pins]

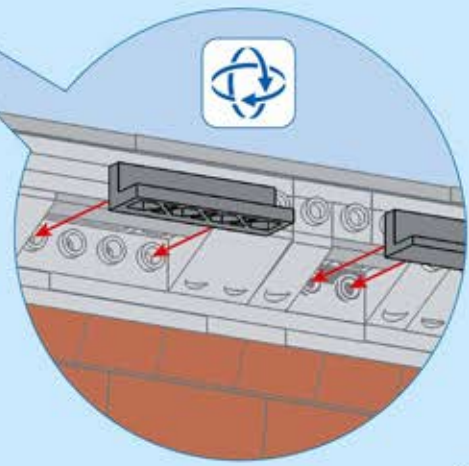
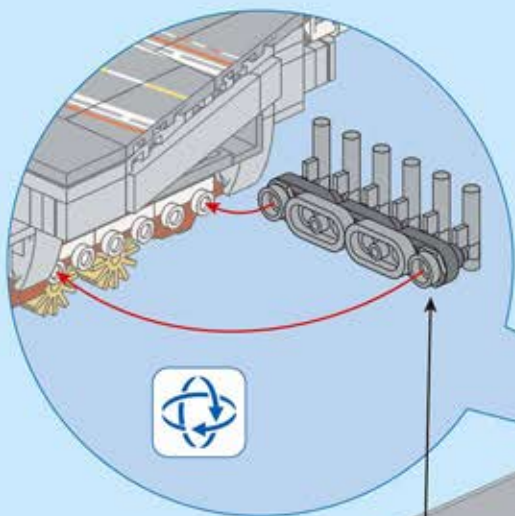
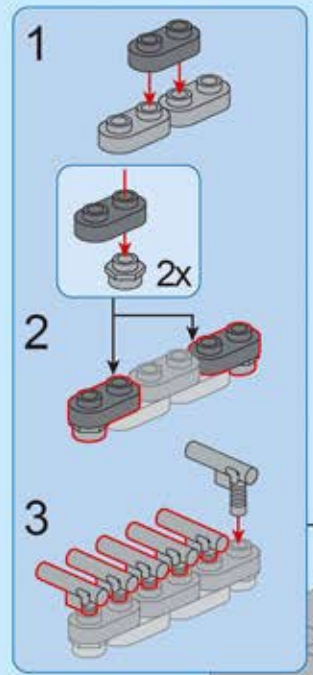

B312

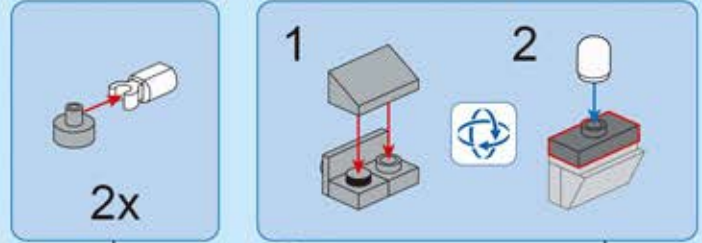
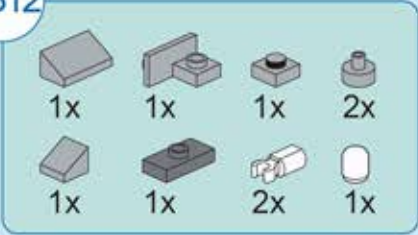

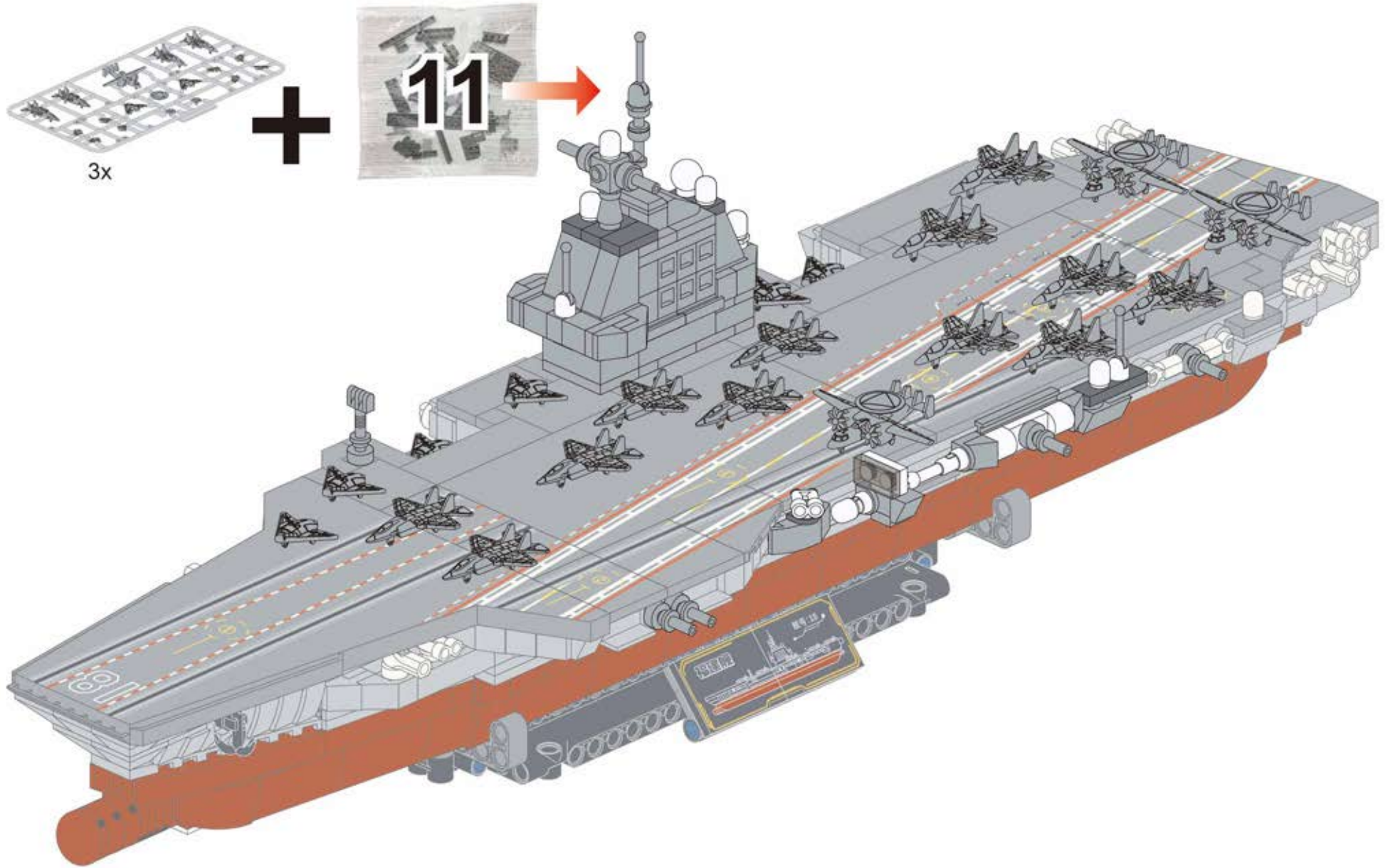

B313

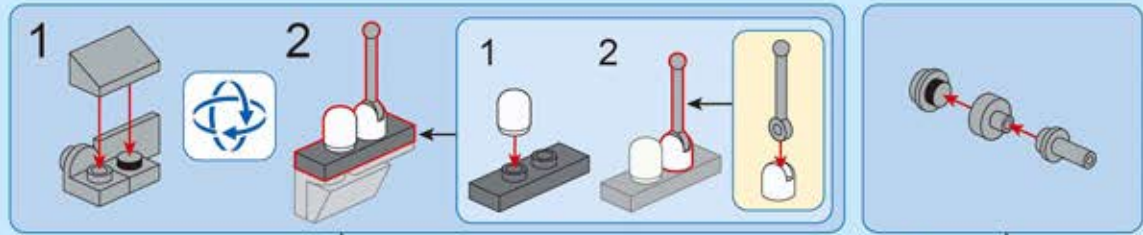
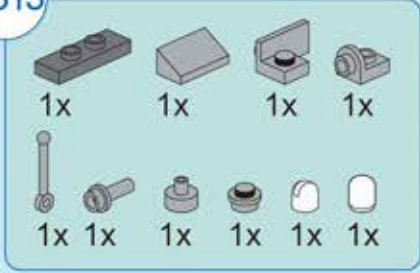

B314

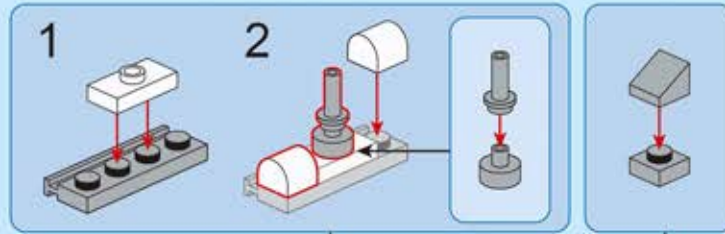
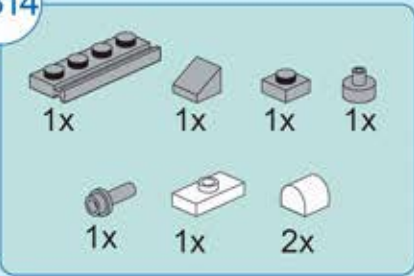

B315

- 1x [Grey 1x3 Technic Brick with Hole]
- 1x [Grey 1x3 Technic Brick with Hole]
- 1x [Grey 1x3 Technic Brick with Hole]
- 2x [Grey 1x2 Technic Brick with Hole]
- 1x [Grey 1x2 Technic Brick with Hole]
- 1x [Grey 1x3 Technic Brick with Hole]
- 1x [Grey 1x3 Technic Brick with Hole]
- 1x [Grey 1x3 Technic Brick with Hole]
- 3x [Grey 1x3 Technic Brick with Hole]
- 1x [Grey 1x3 Technic Brick with Hole]

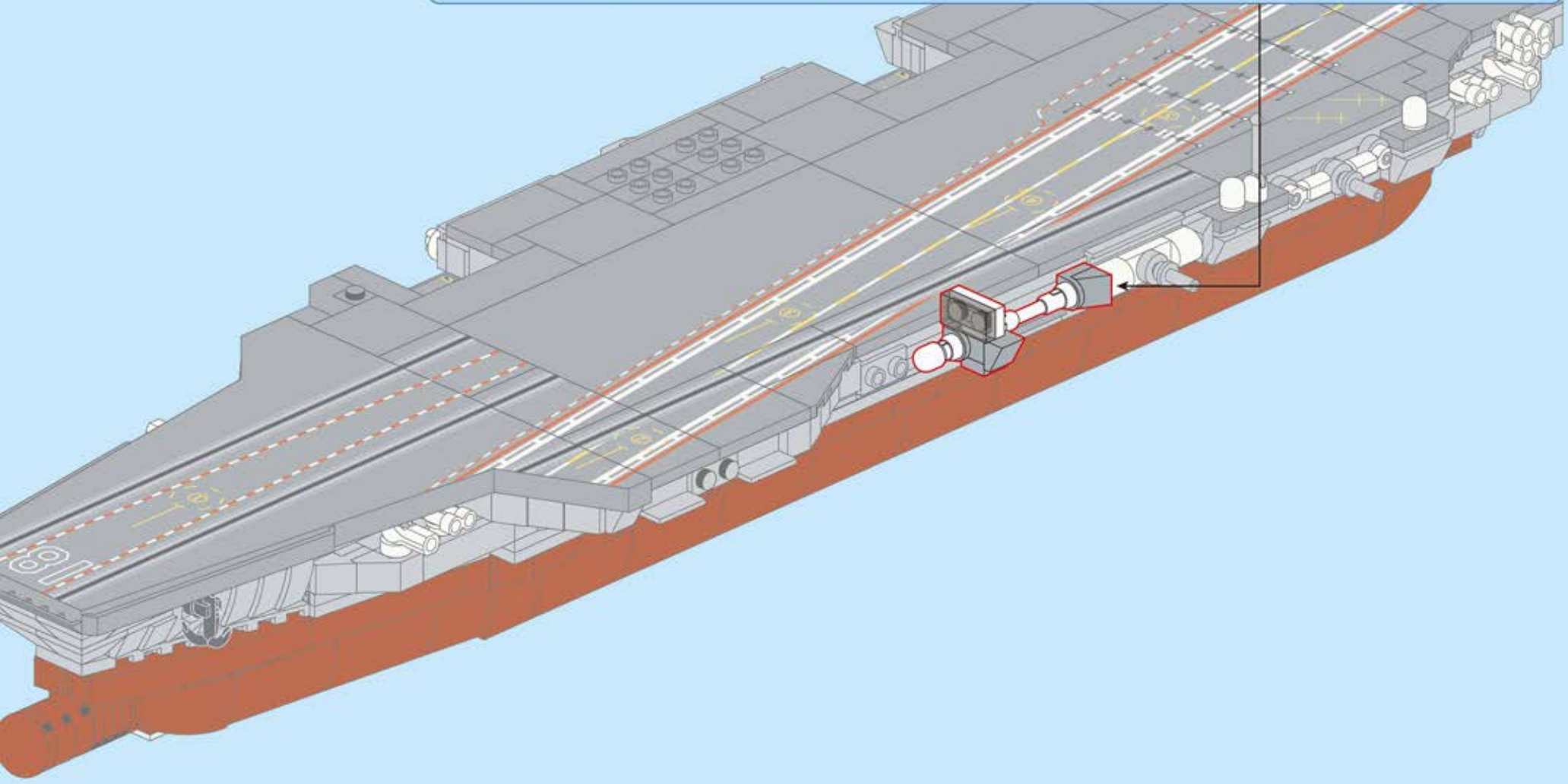
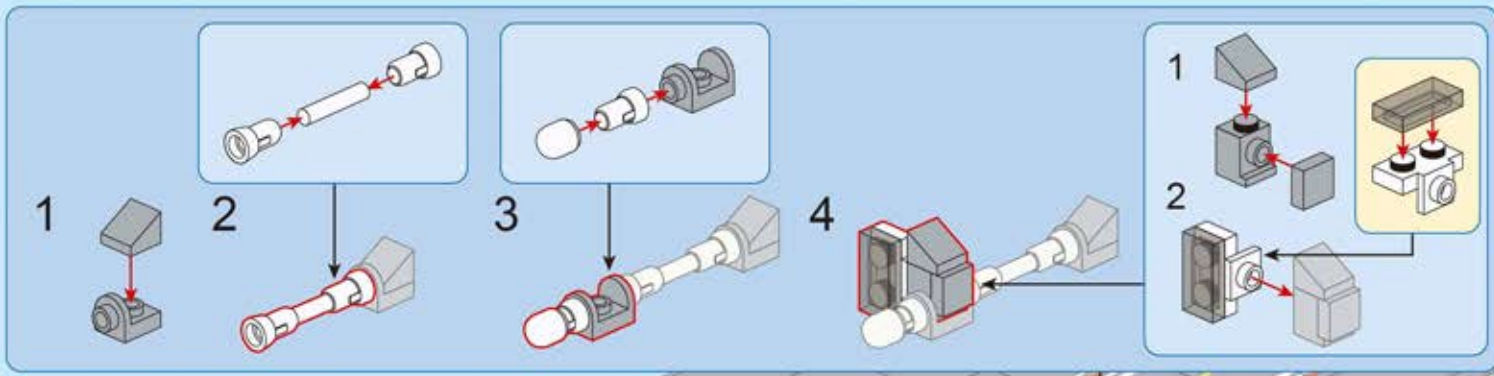

B316

- 1x [Grey Technic Pin]
- 1x [Grey Technic Pin]
- 2x [Grey Technic Pin]
- 2x [Grey Technic Pin]
- 1x [Grey Technic Pin]
- 1x [Grey Technic Pin]
- 1x [Grey Technic Pin]

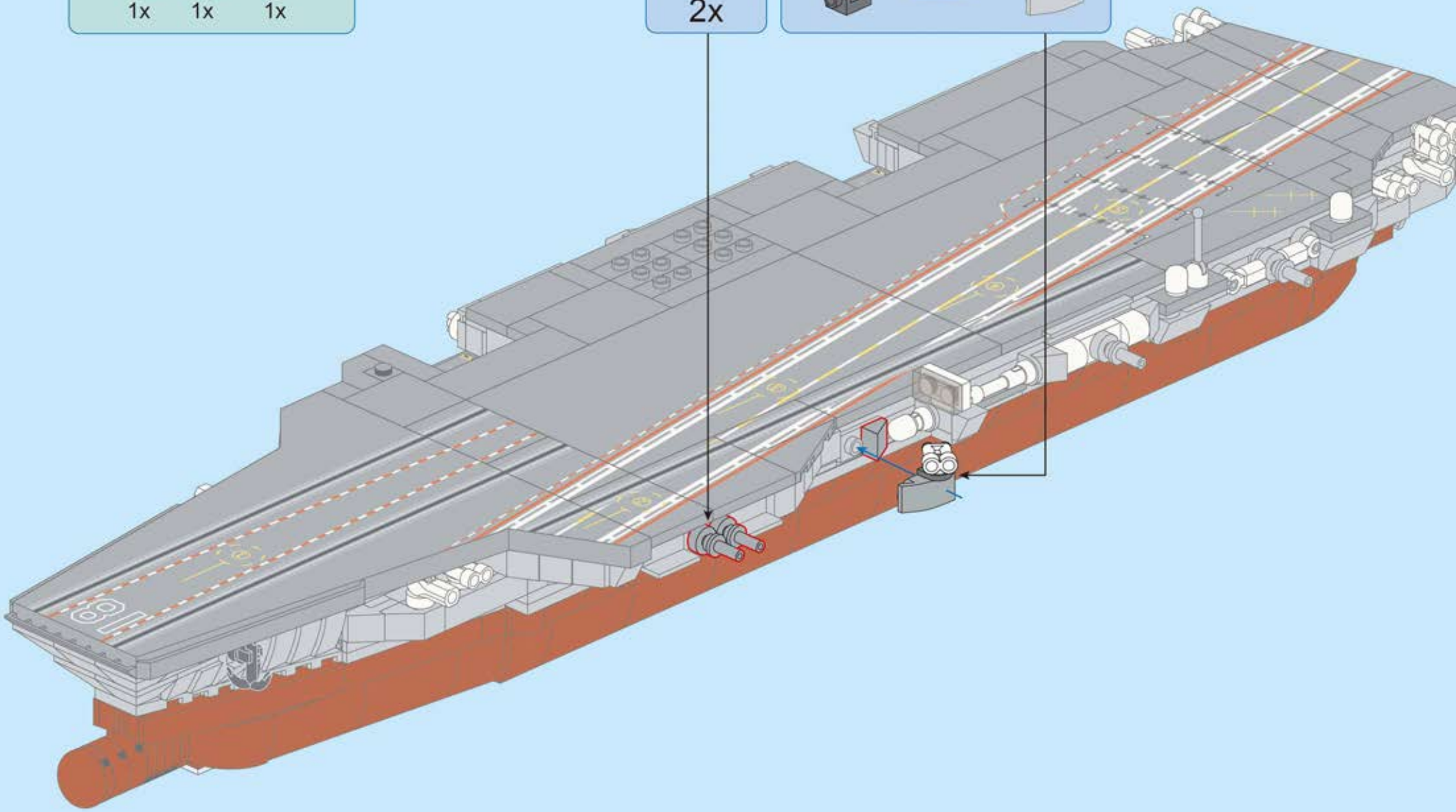
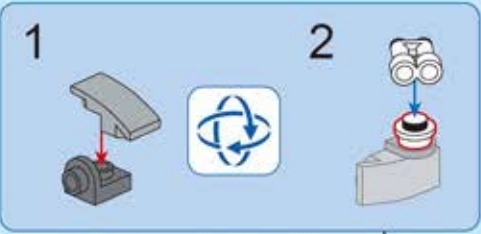
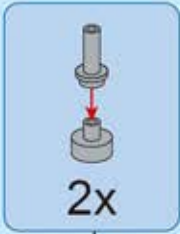

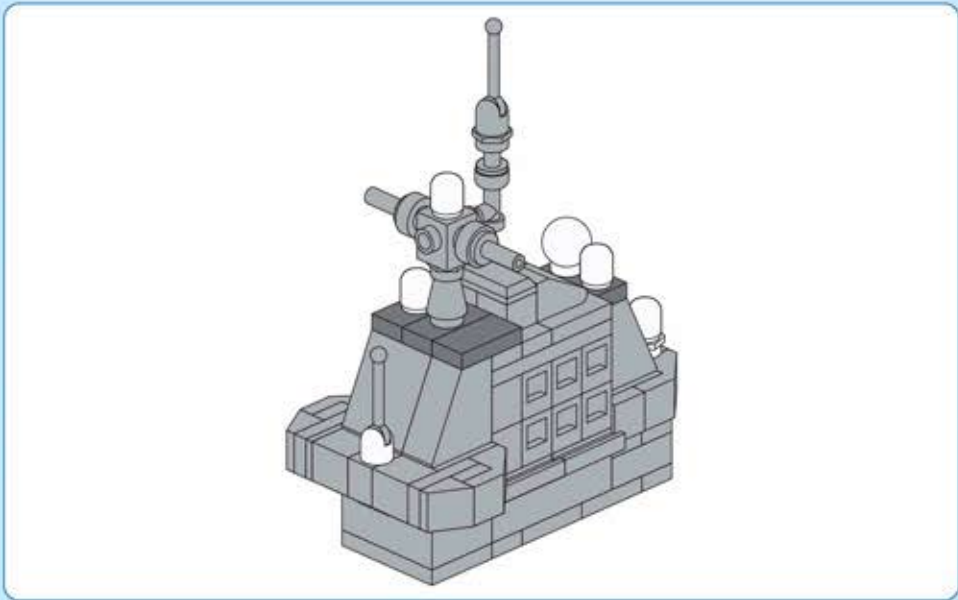

B317

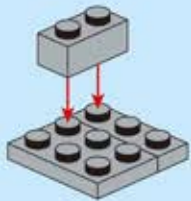
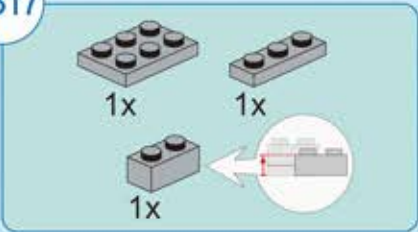

B318

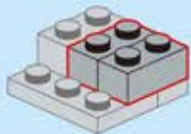
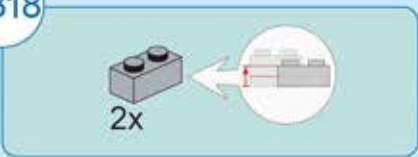

B319

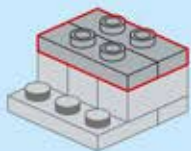

B320

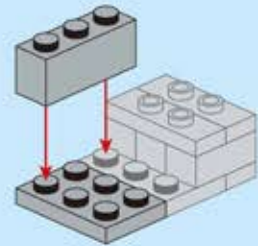
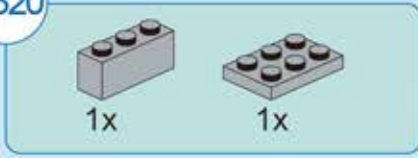

B321

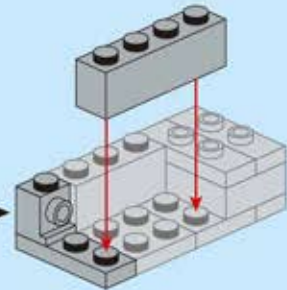
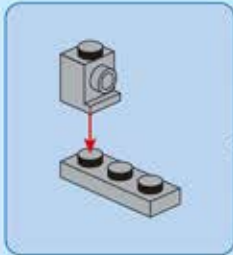
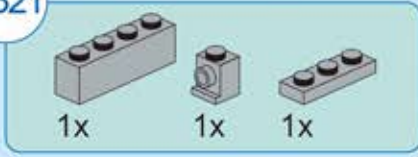

B322

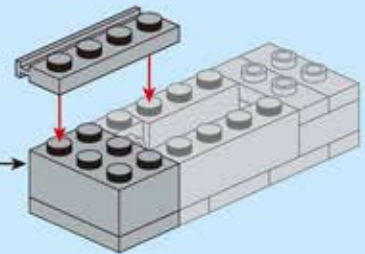
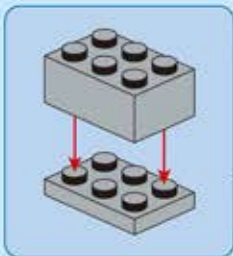
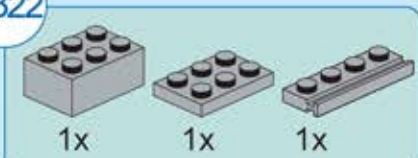

B323

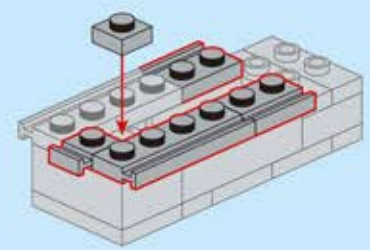
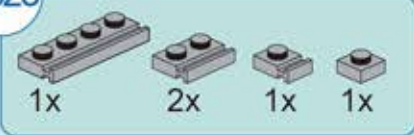

B324

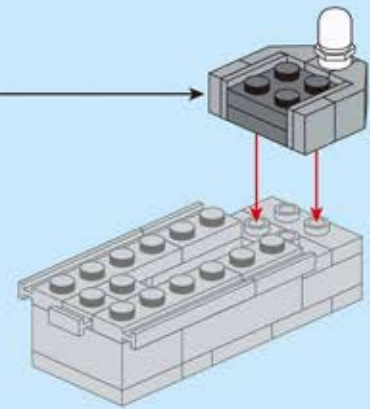
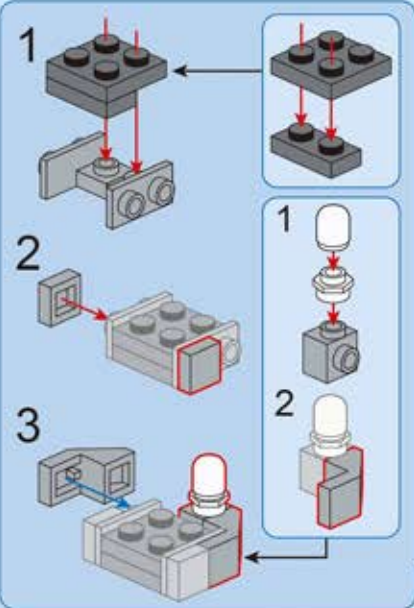
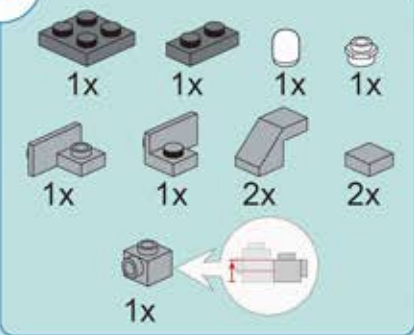

B325

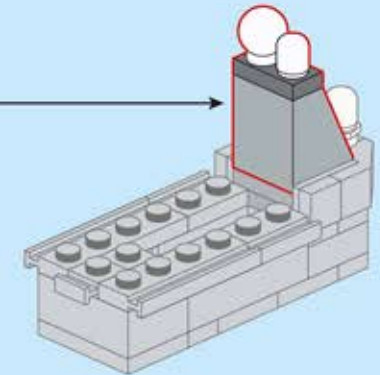
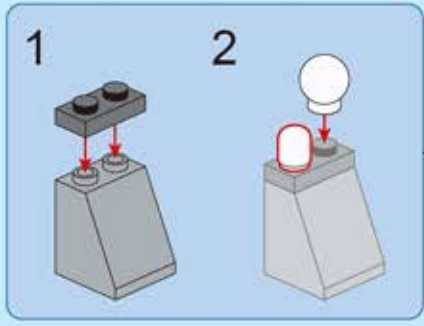
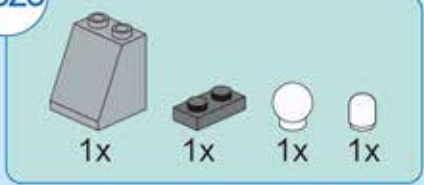

B326

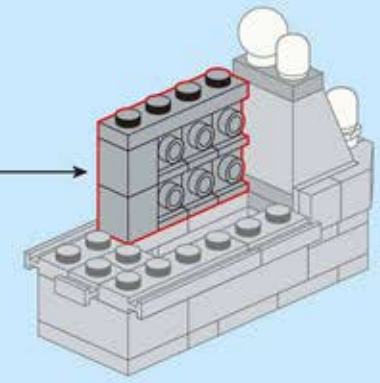
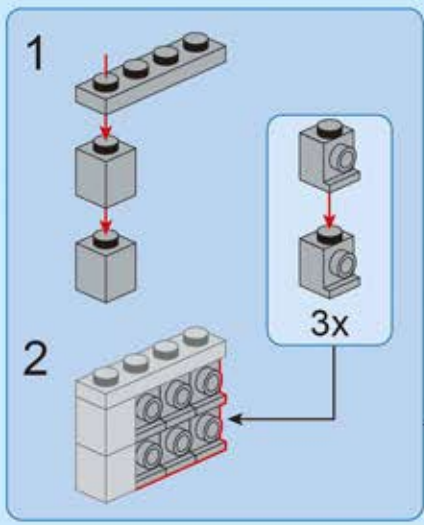

B327

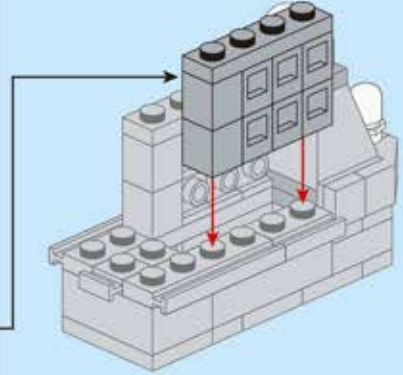
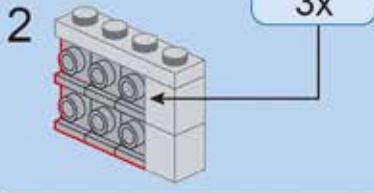
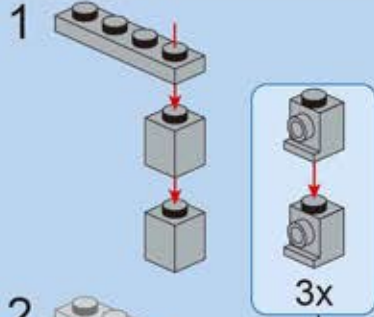
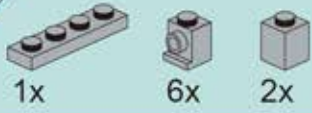

B328

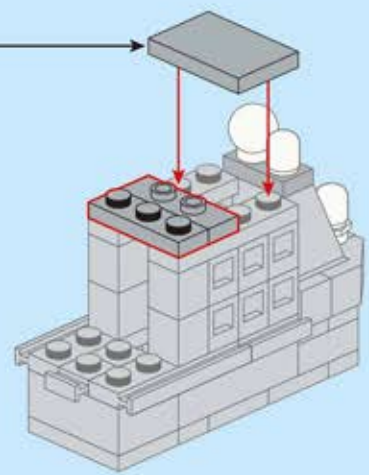
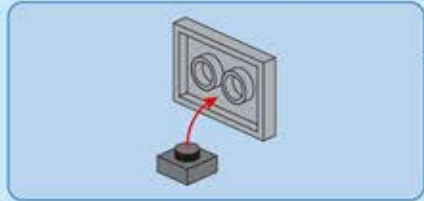
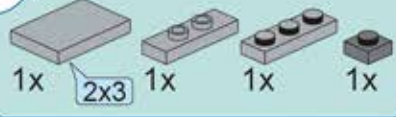

B329

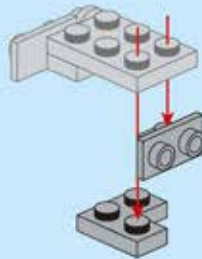
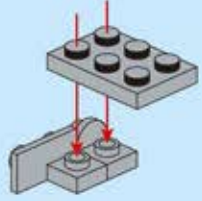
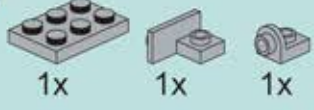

B330

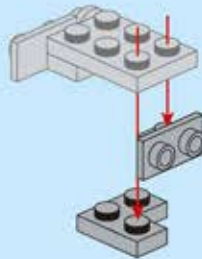

B331

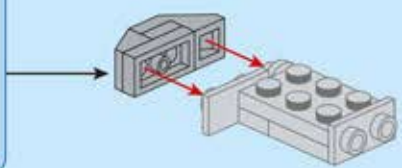
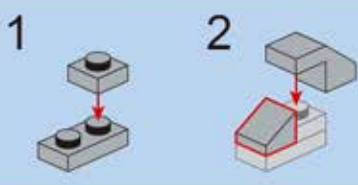
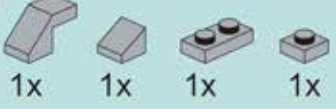

B332

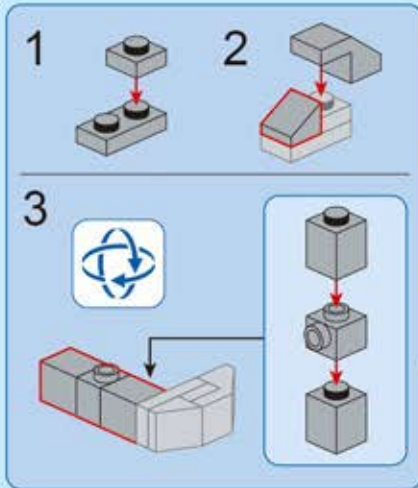
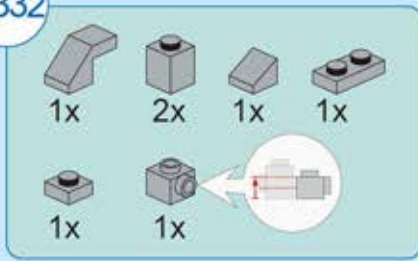

B333

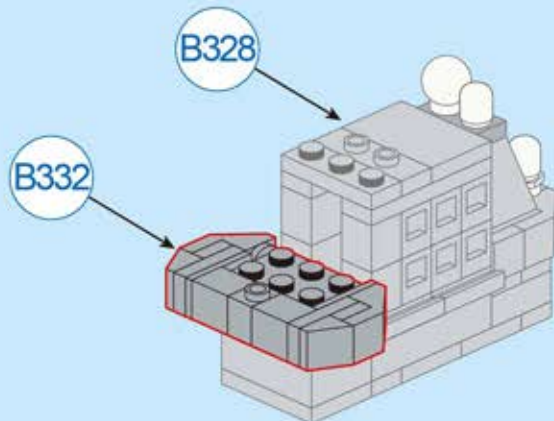

B334

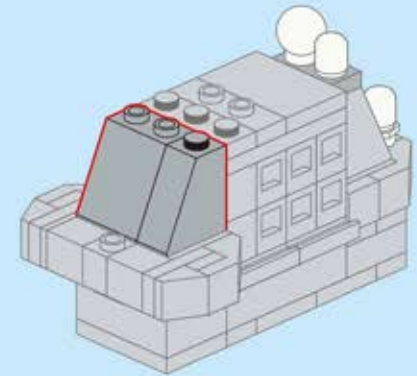
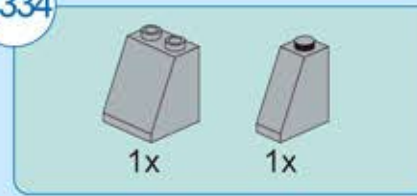

B335

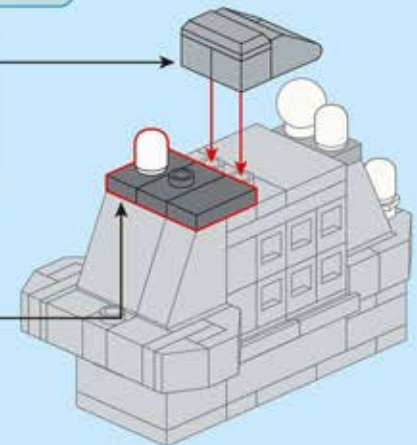
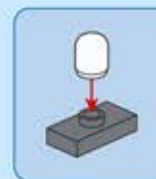
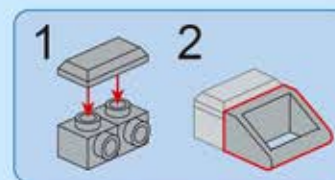
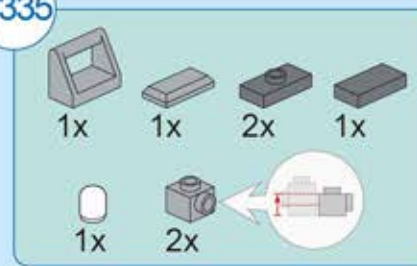

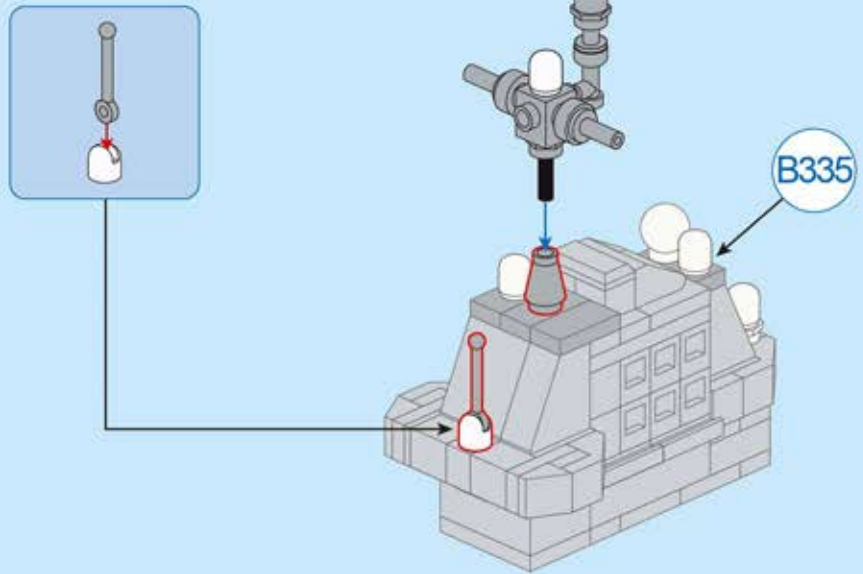
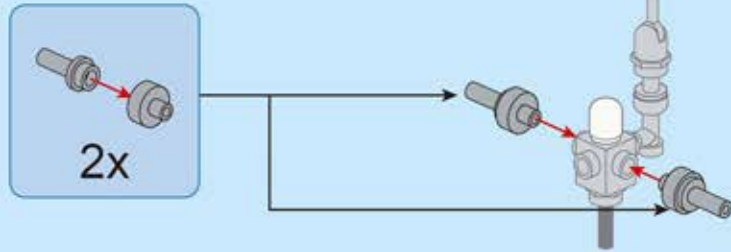
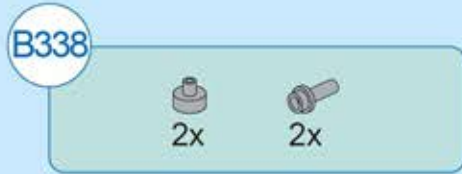
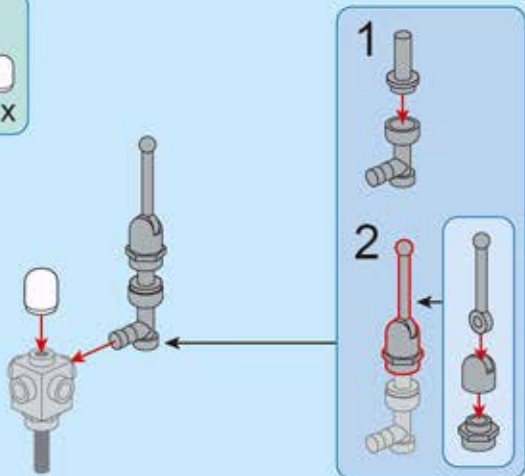
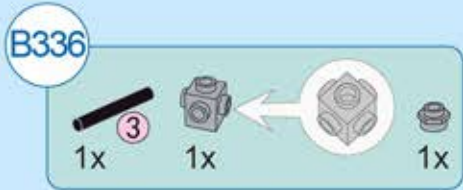
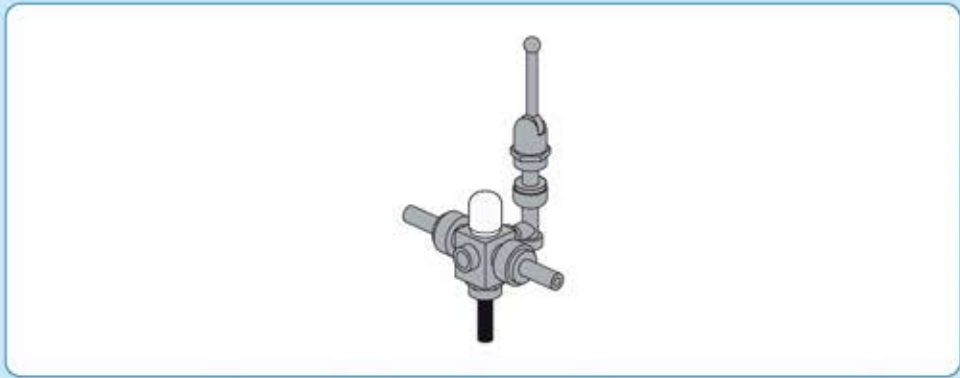

B340

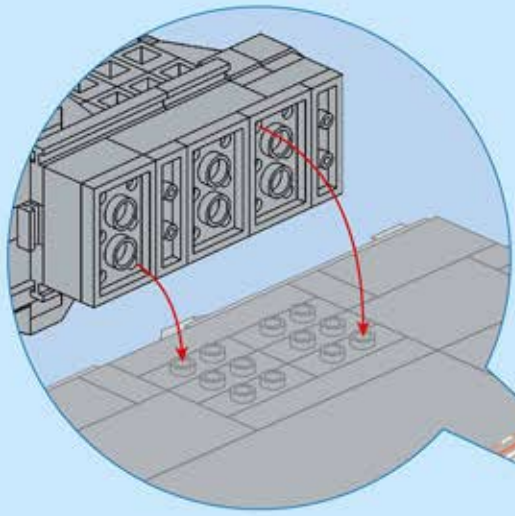

B339

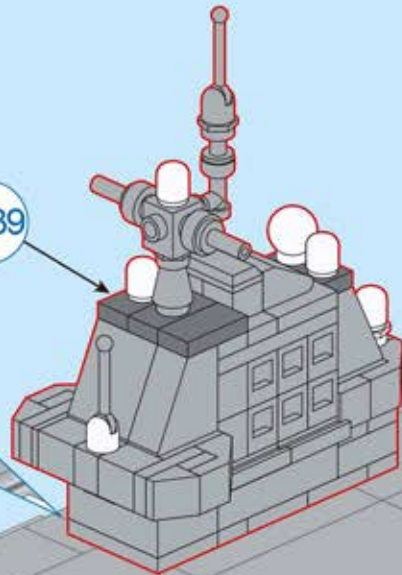

B316

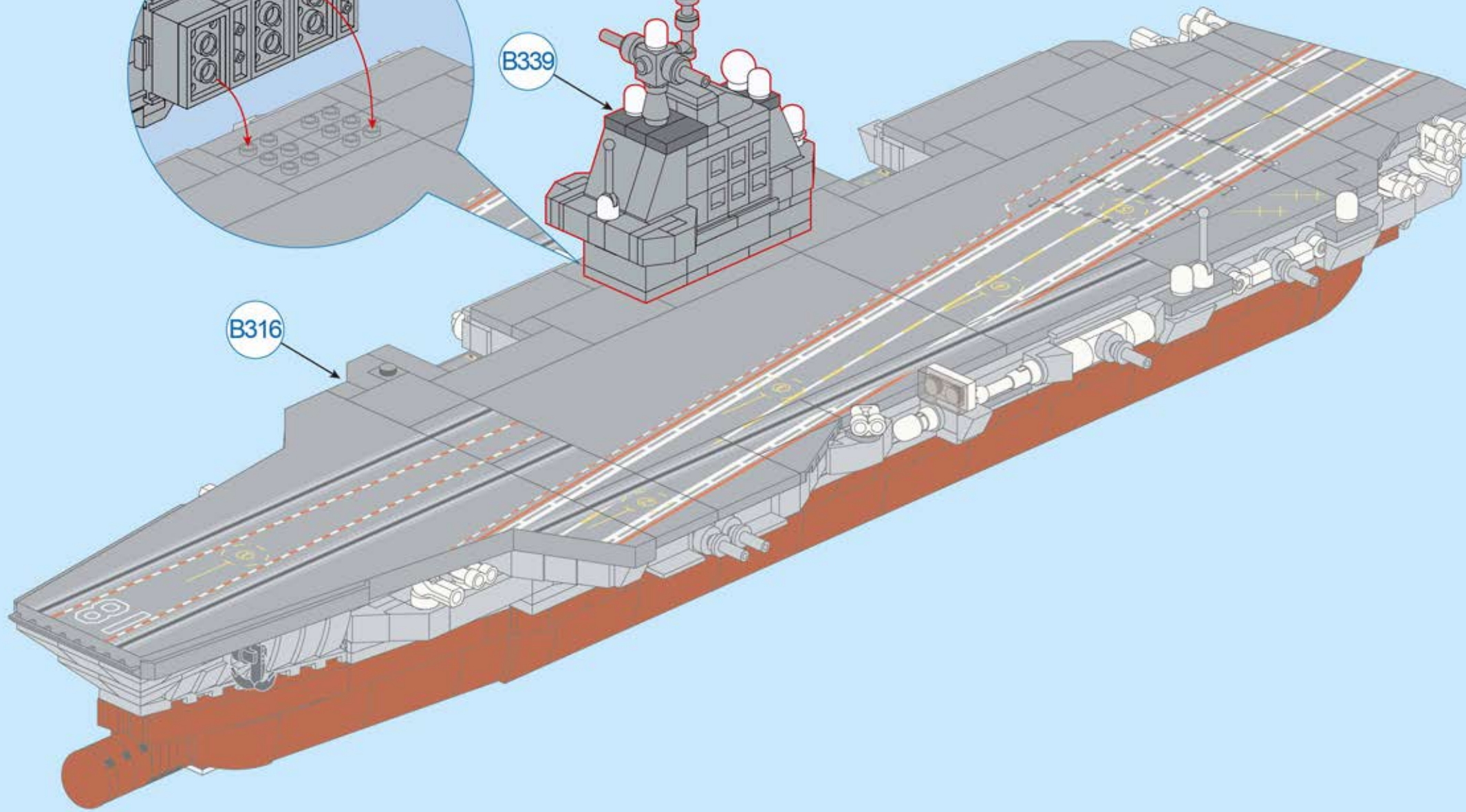

B341

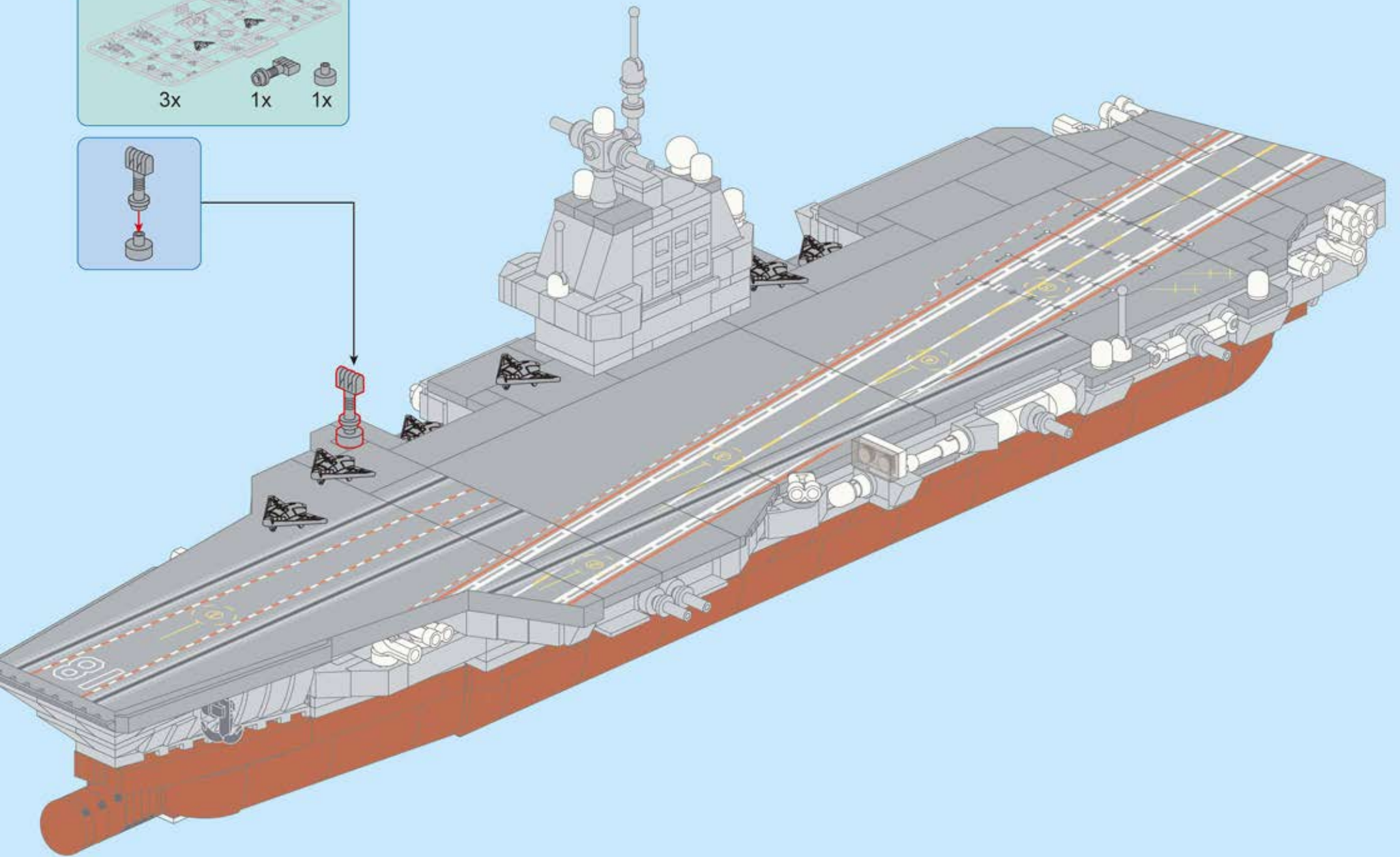
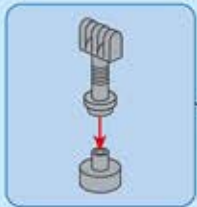
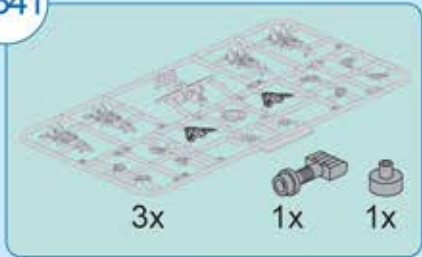

B342

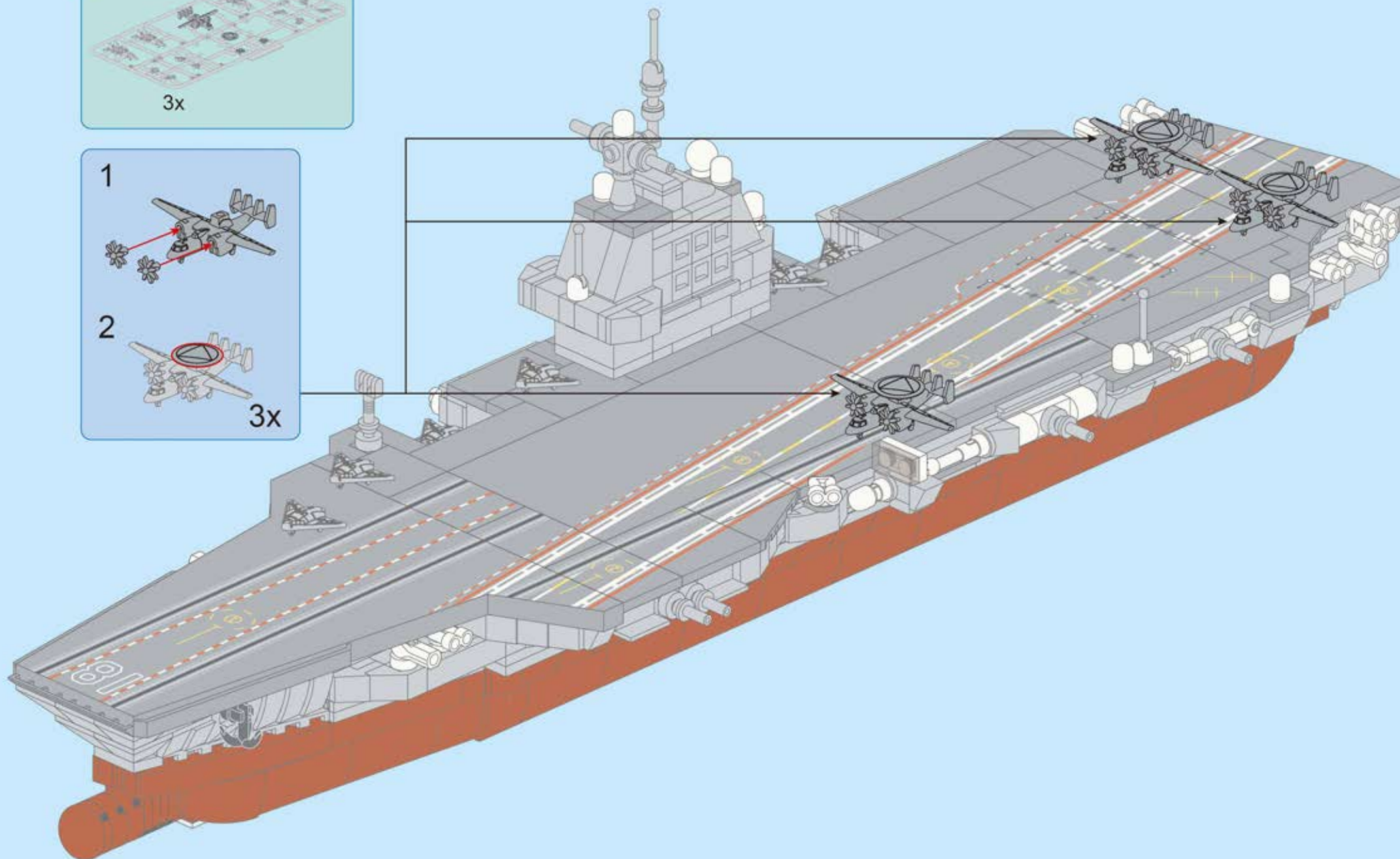
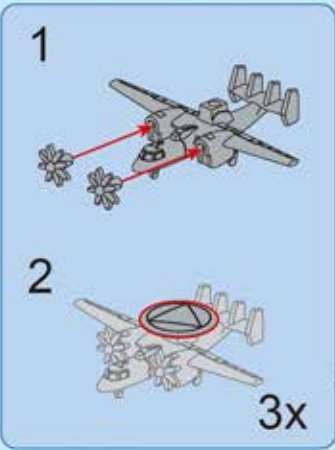
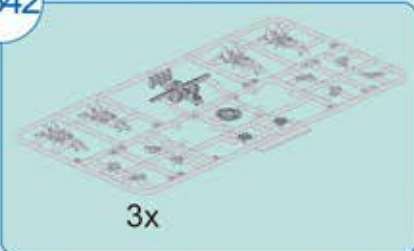

B343

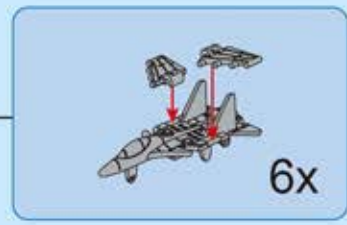
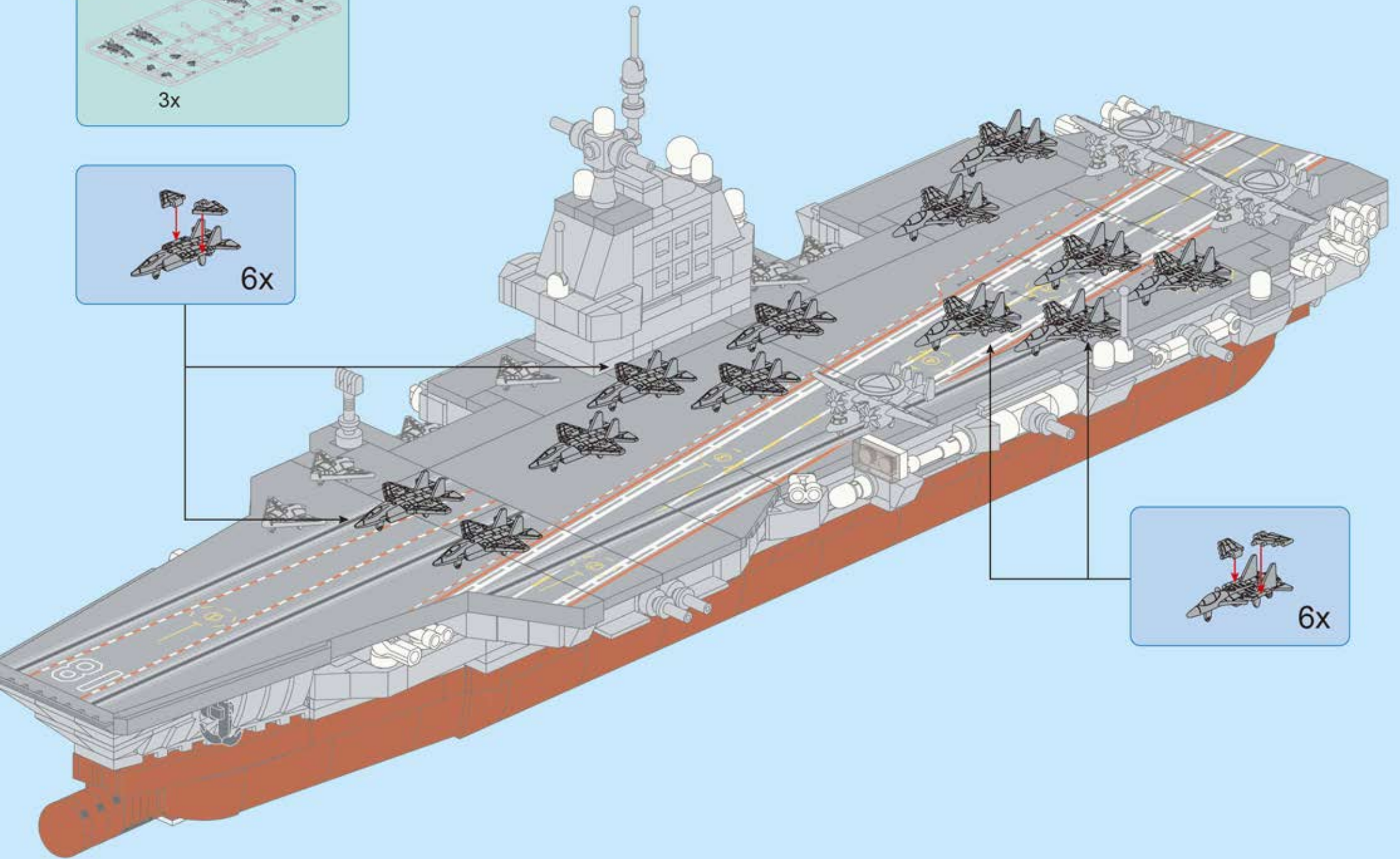
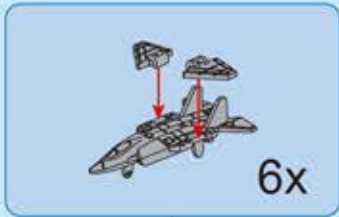
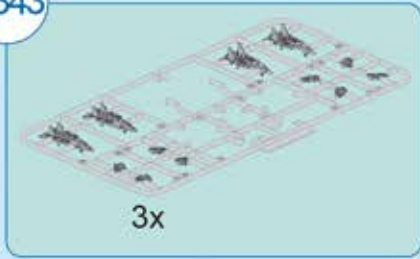

B344

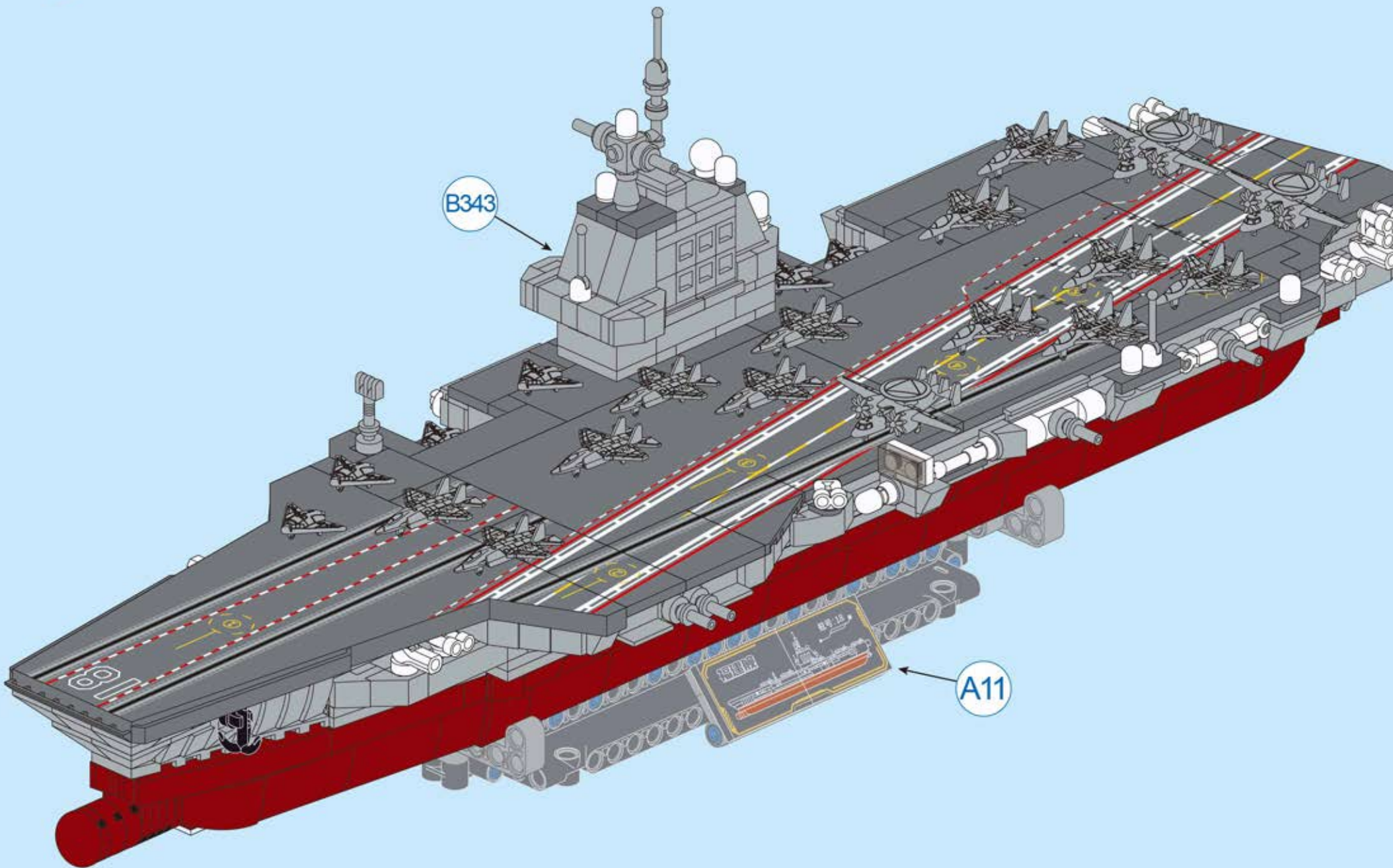

B343

A11

1

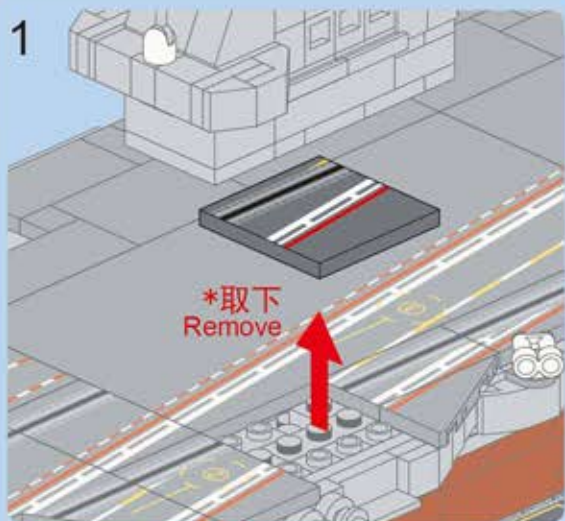

2

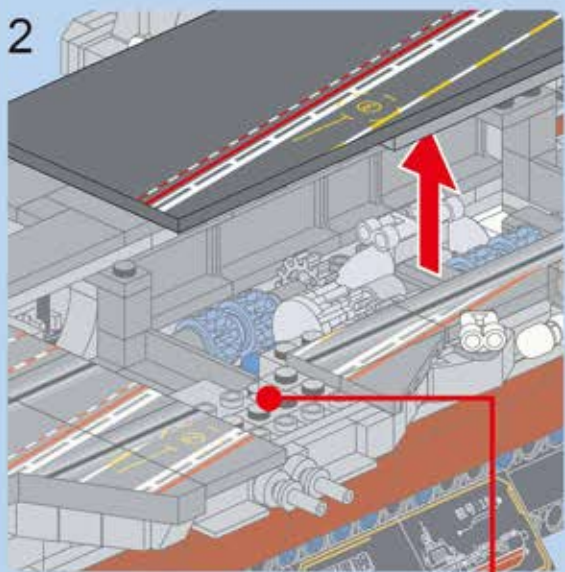

注意：从此处缺口向上取出甲板
Note: Remove the deck from the gap upwards

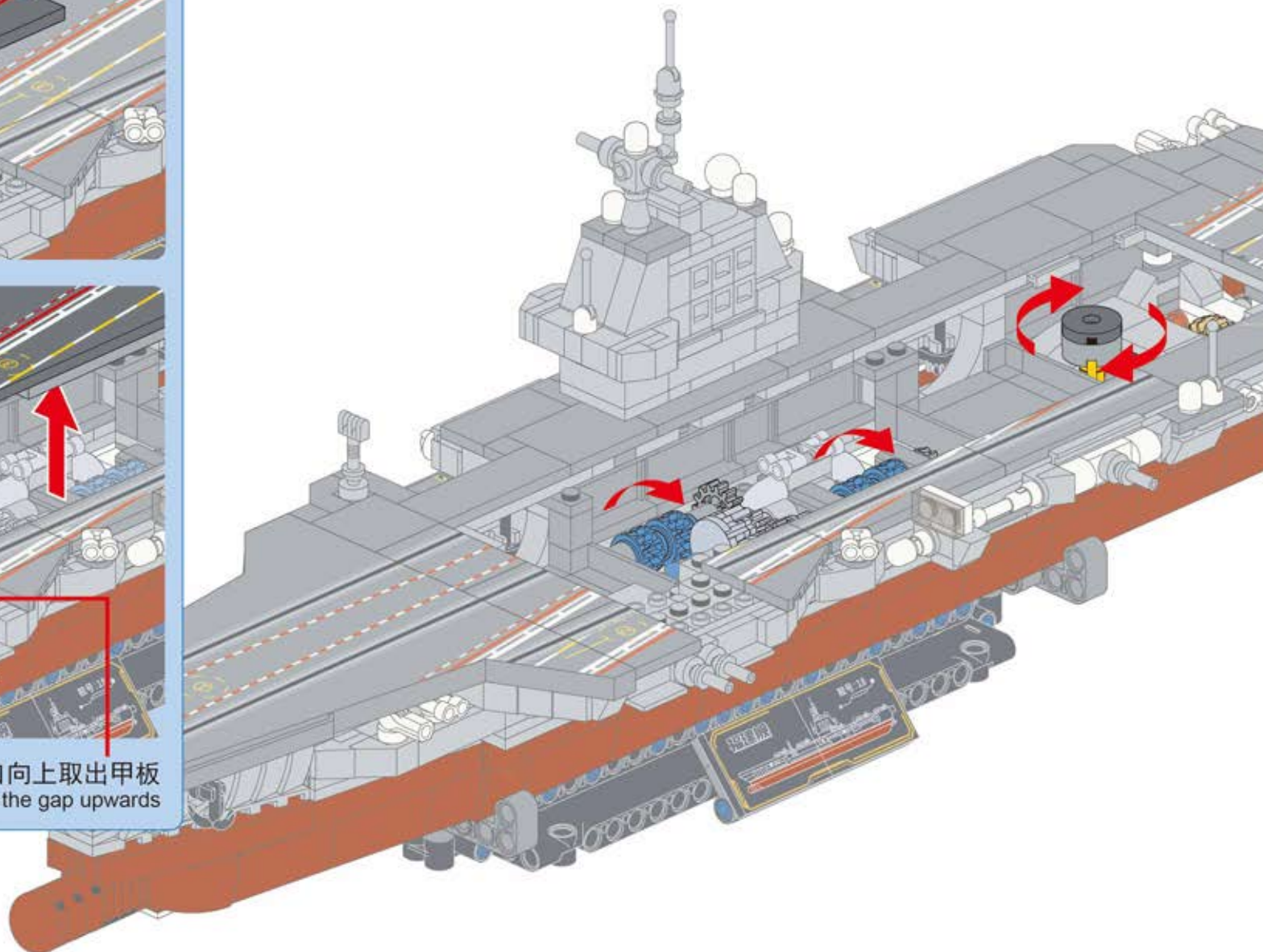

1. 把甲板两端先装进船体
Install both ends of the deck
into the hull first

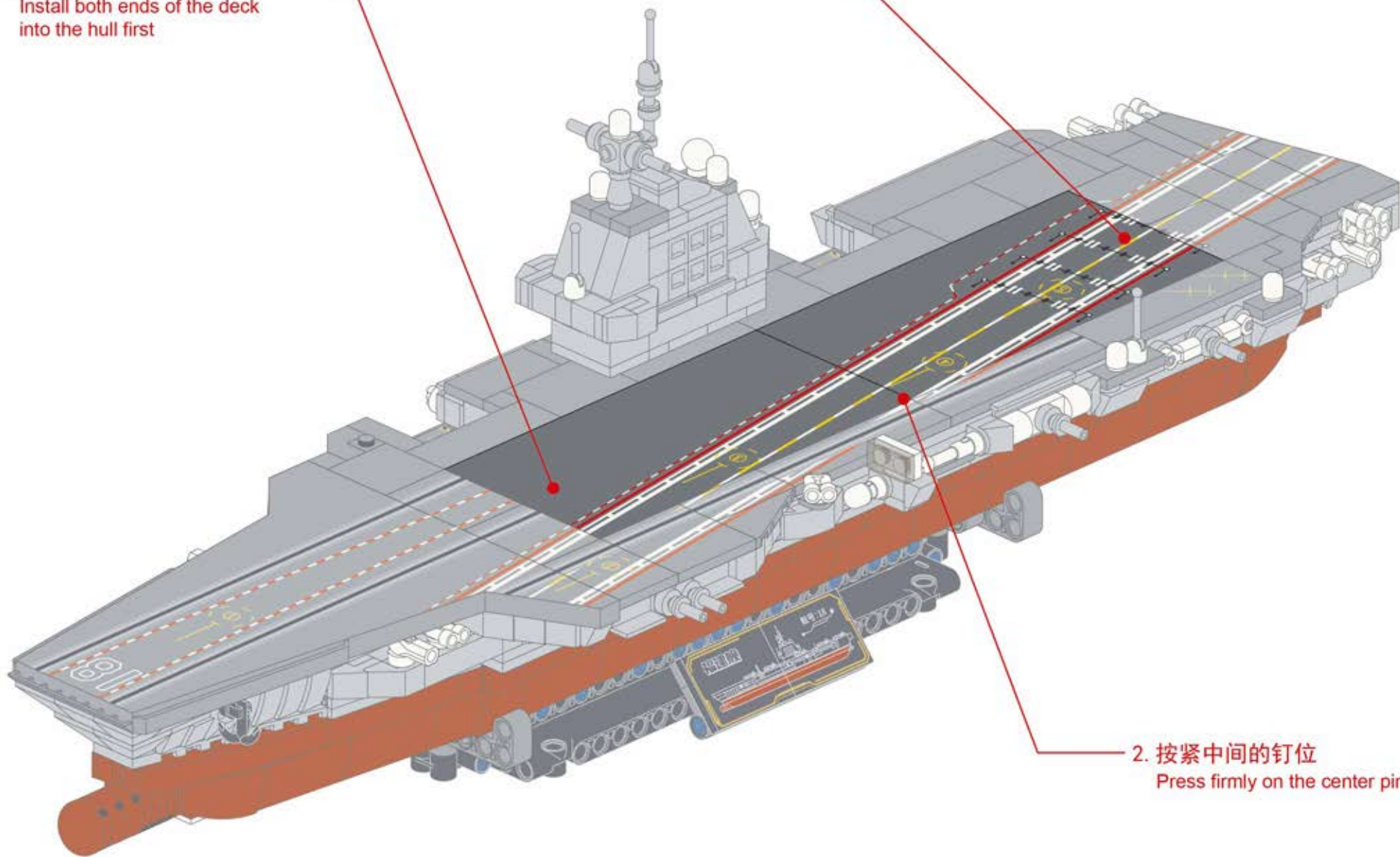

2. 按紧中间的钉位
Press firmly on the center pin

