

K 奇妙积木 KEEP PLEY

王者荣耀



拼装模型
超星版

78037-2

铠 银白咏叹调

◆ 魔神状态 ◆

正版授权积木

©2020 Tencent. All Rights Reserved.
腾讯公司 版权所有

锁

78037-2

银白咏叹调

魔神状态

拼装模型
超星版

限定配色

金属质感成型色，限定黑暗紫



意志的支配者，
何惧宿命的低语。



18处可动关节，更多战斗姿势等你解锁

拼装模型超星版



贴纸使用说明

- 使用贴纸前请确认表面无任何灰尘或油污等物质，以确保最好的粘贴效果。
- 避免过度拉扯或挤压贴纸，以免导致贴纸变形或开裂。
- 较细小的贴纸可以使用镊子、夹子等工具辅助，以获得更好的张贴体验。



板件注意事项

- 产品质量经过严格把控，板件图示与实物可能存在细微差异。
- 如个别板件产生流纹、气泡现象，属正常现象。
- 运输过程如有个别板件脱落，属正常现象。

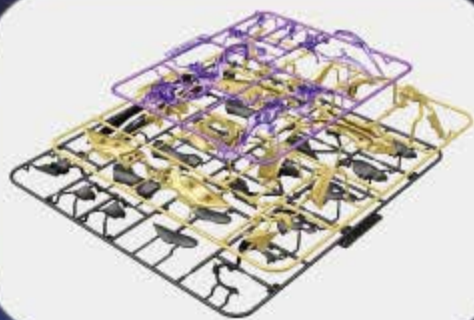

1 头部组件



B1板件

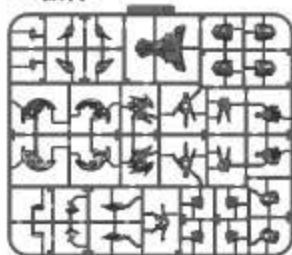

C2板件

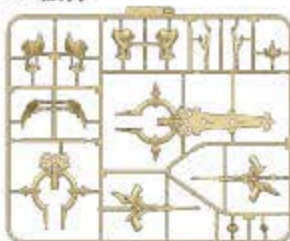

F板件



所需板件

板件编码 零件编码

A1 X



x1

1-1



1-2



1-3



1-4



1-5

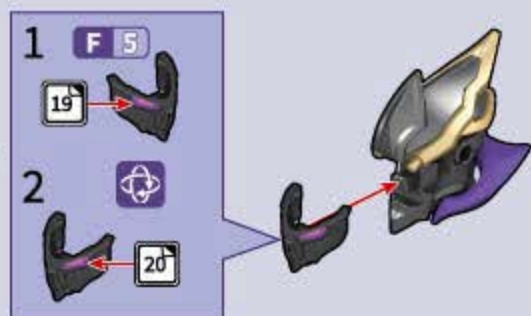

1-6



1-7

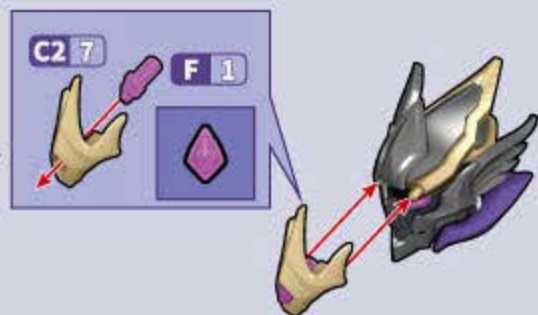

2 身体组件



A板件

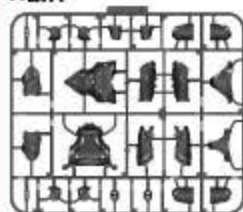

B1板件

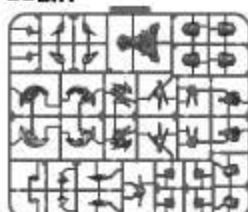

B2板件

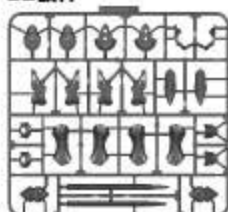

所需板件

C1板件



F板件



板件编码 零件编码

A1 X



2-1

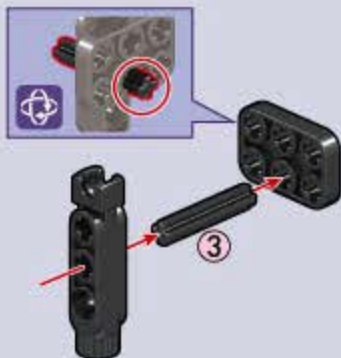

2-2

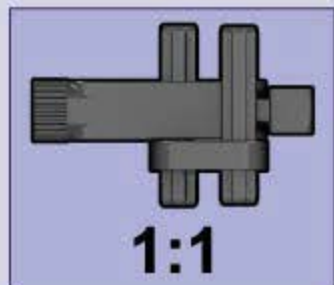
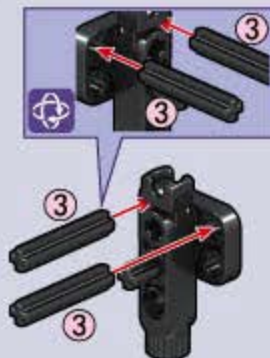

2-3

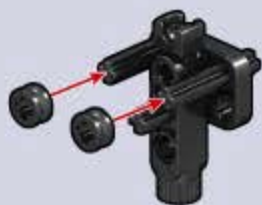

2-4

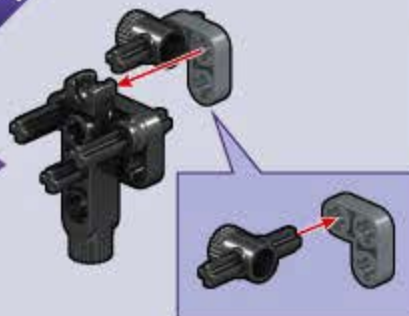

2-5

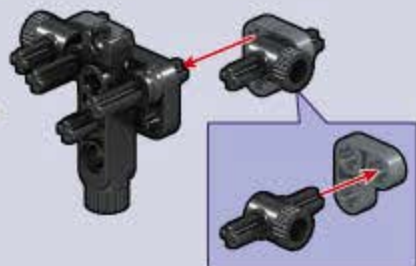

2-6

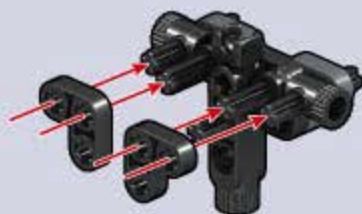

2-7

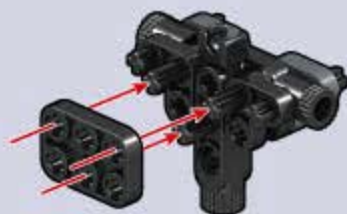

2-8



2-9

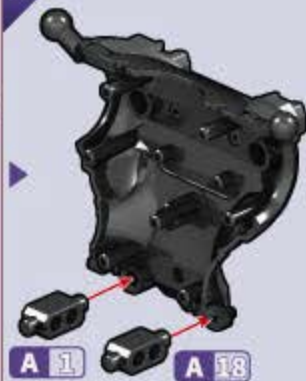

2-10

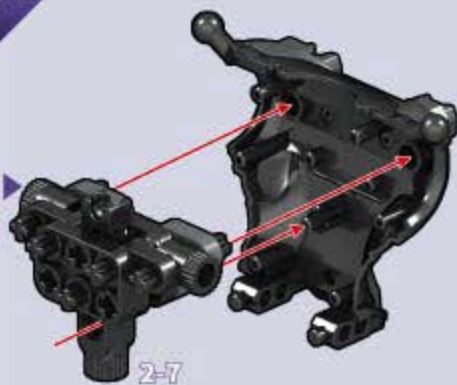

2-11

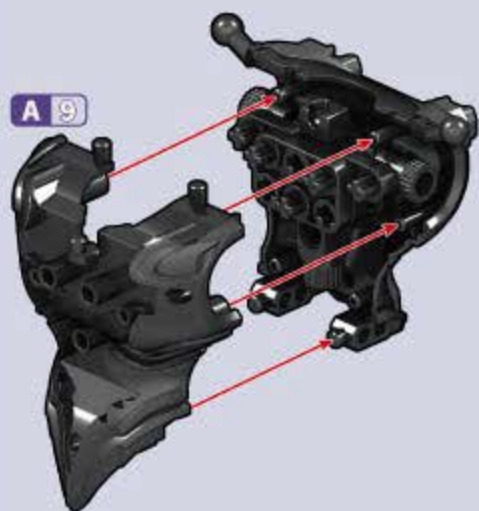

2-12

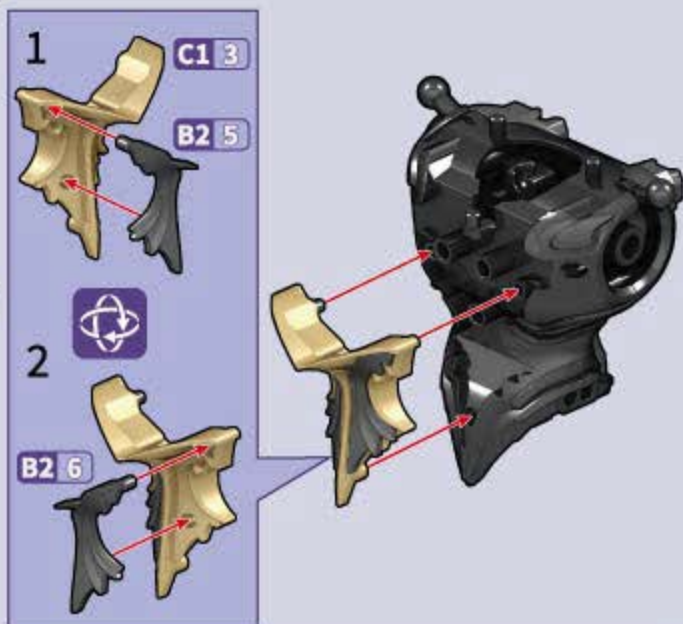

2-13



2-14

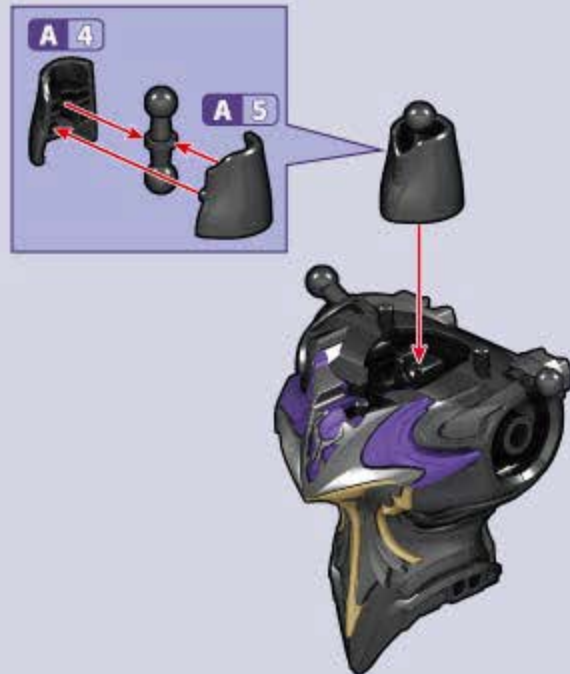

2-15

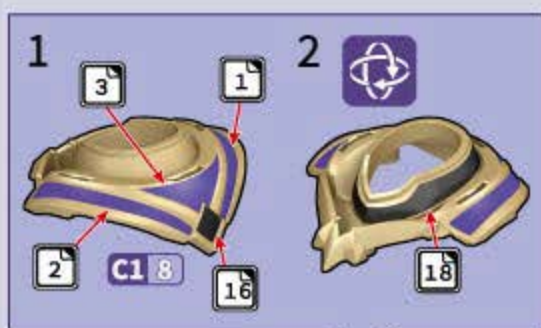

2-16

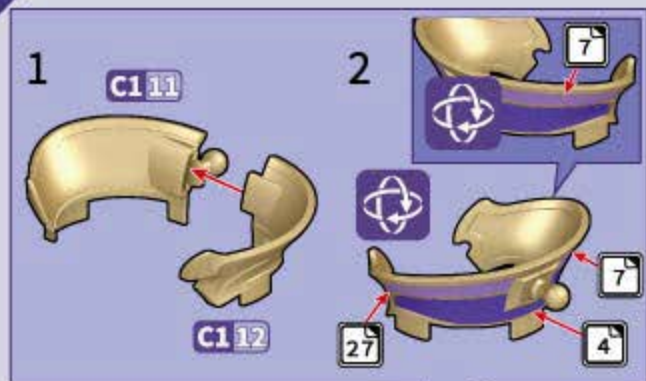
3
腕部组件

A板件

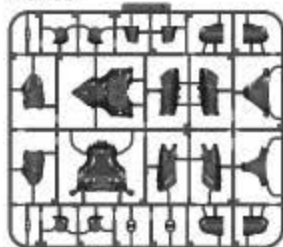

板件编码 零件编码

A1 X



x1



x1



x1

②

所需板件

3-1



3-2



3-3



4 左手组件



A板件

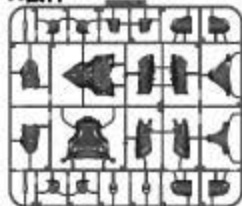

B1板件



所需板件

C2板件

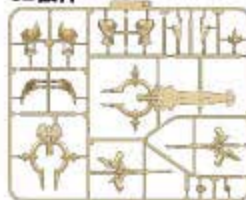

G1板件



板件编码

零件编码

A1 X



x1



x1



x1



x1

4-1



4-2



4-3

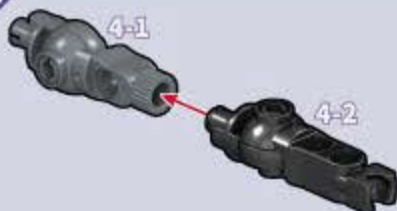

4-4



4-5

拼装顺序: 先绿 → 后红 →

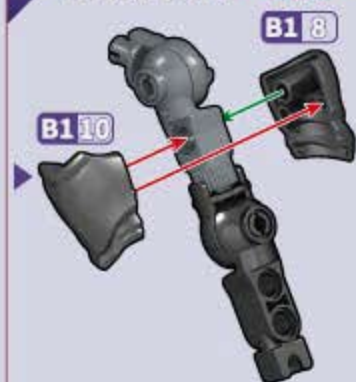

4-6

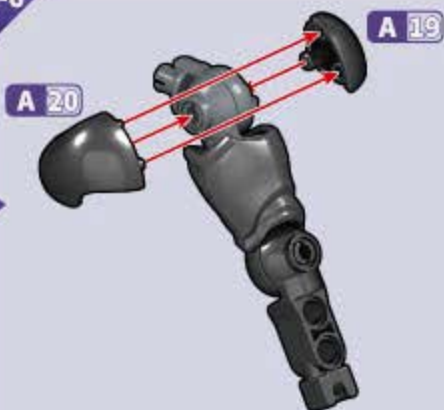

4-7



4-8



4-9

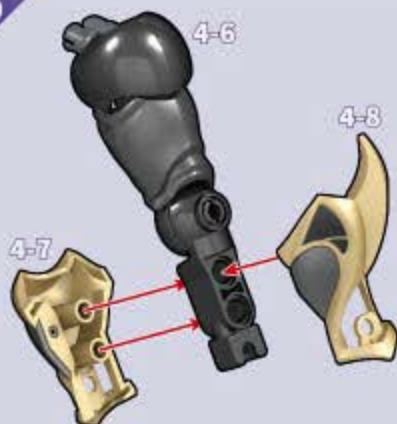

4-10

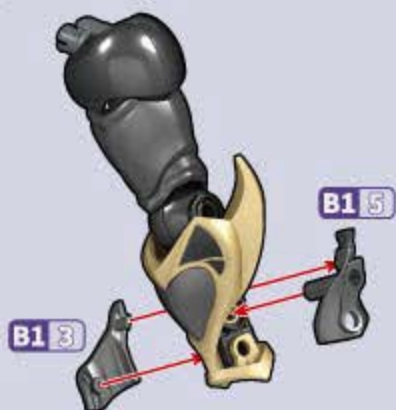

4-11

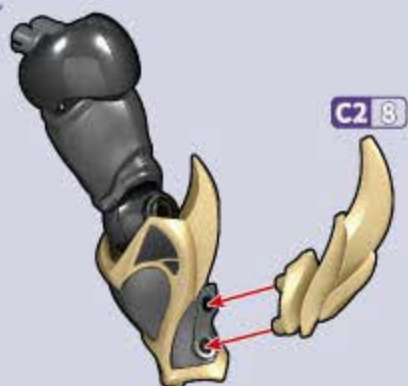

G1 5



可替换

4-12

手势A



B1 22



B1 35



B1 33



4-13

手势B



B1 18



B1 34



B1 21



4-14

手势C



G1 2



G1 1



G1 9



4-17

4-11



A

4-15

G1 3



G1 4



G1 11



G1 10



G1 7



G1 6



4-16

G1 8

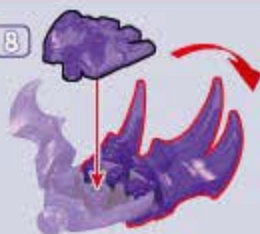

可替换



C



5 右手组件



A板件

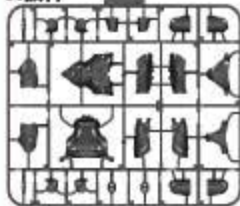

B1板件



C2板件

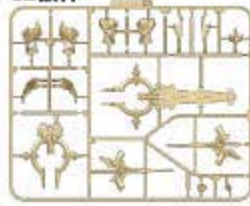

所需板件

G2板件



板件编码

零件编码

A1 X



5-1



5-2



5-3



5-4

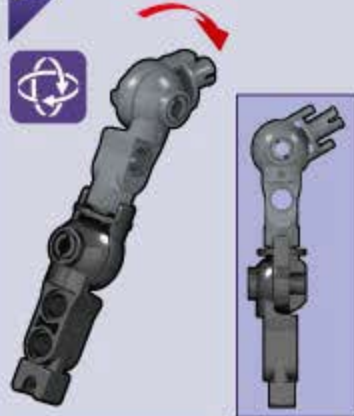

5-5

拼装顺序: 先绿 → 后红 →

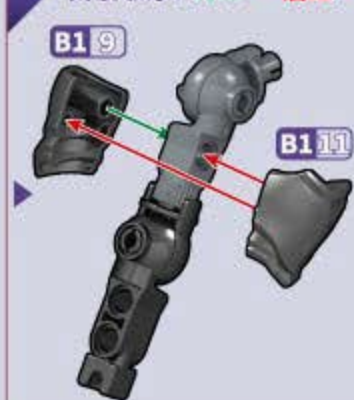

5-6

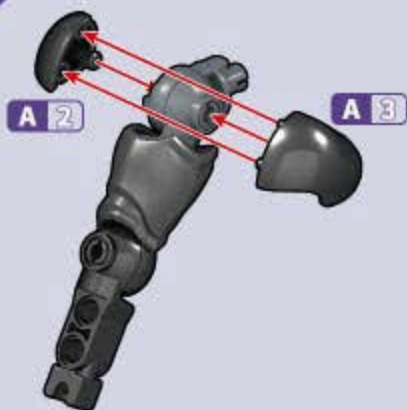

5-7



5-8



5-9

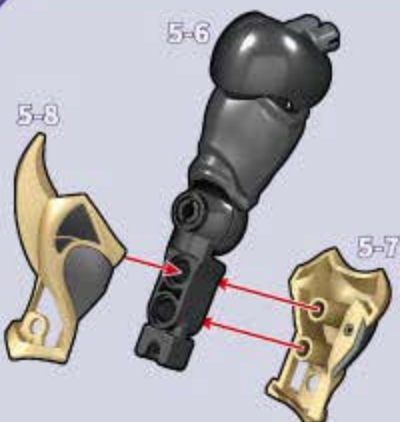

5-10

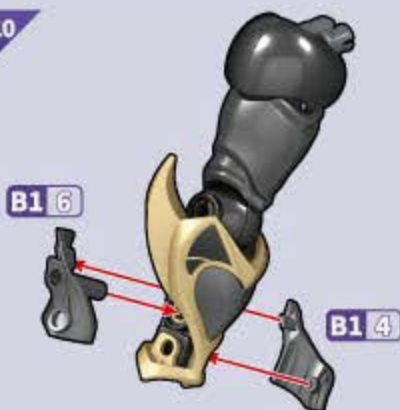

5-11

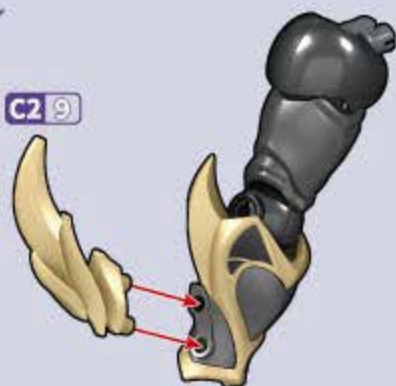

G2 5



可替换

5-12



手势A

5-13

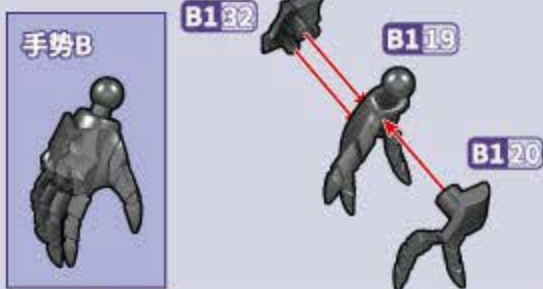

手势B

5-14

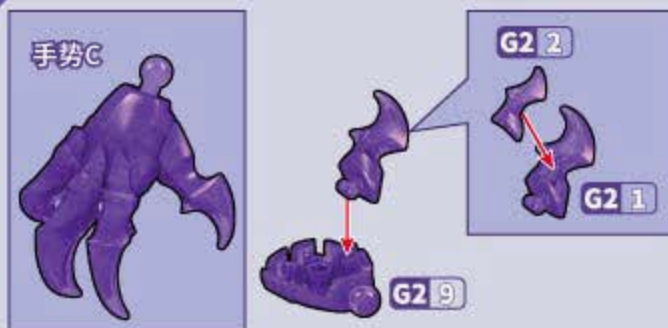

手势C

5-17



5-15

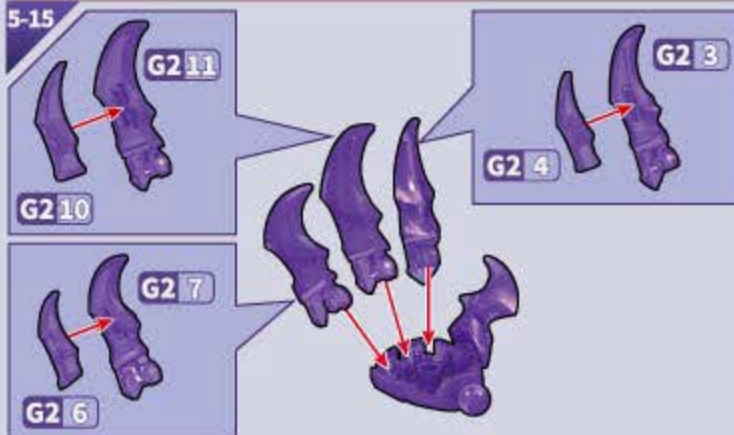

5-16



可替换



6 右腿组件

所需板件

A板件

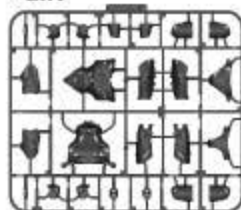

B2板件

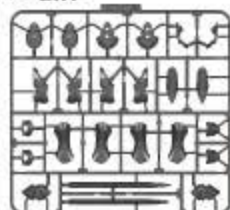

板件编码

零件编码

A1 X



E板件



F板件

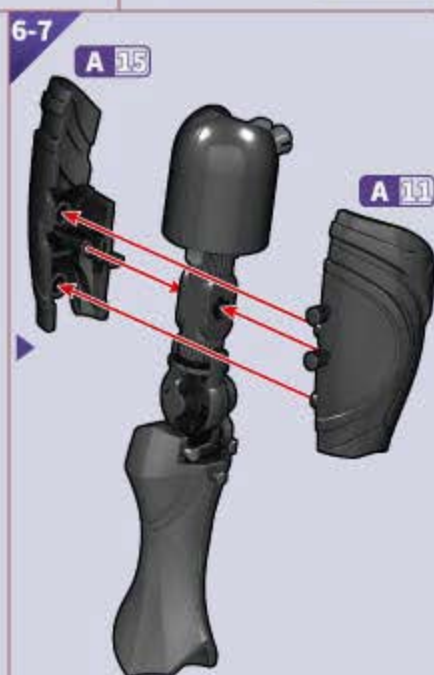
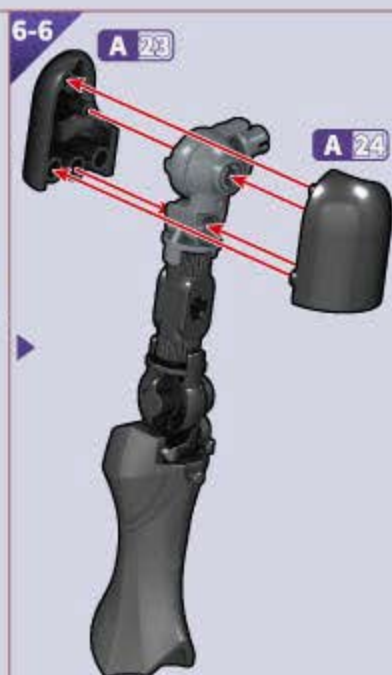
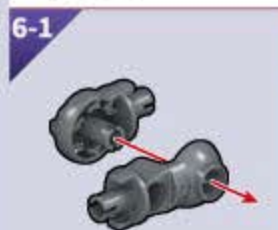

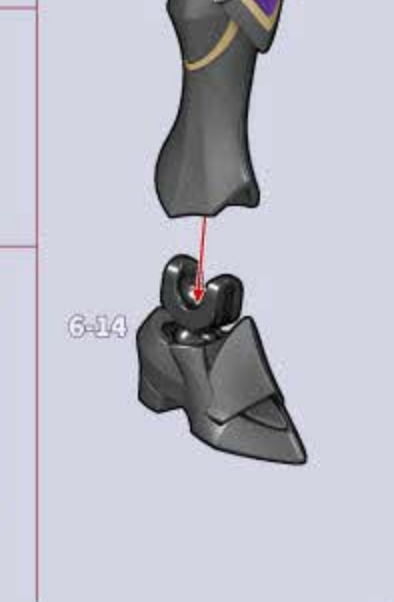
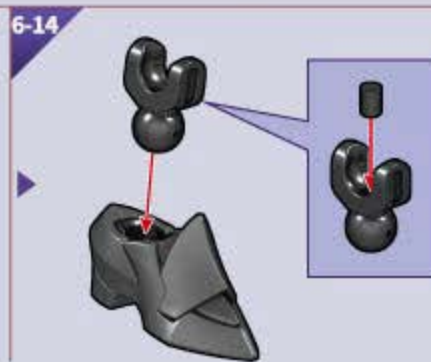
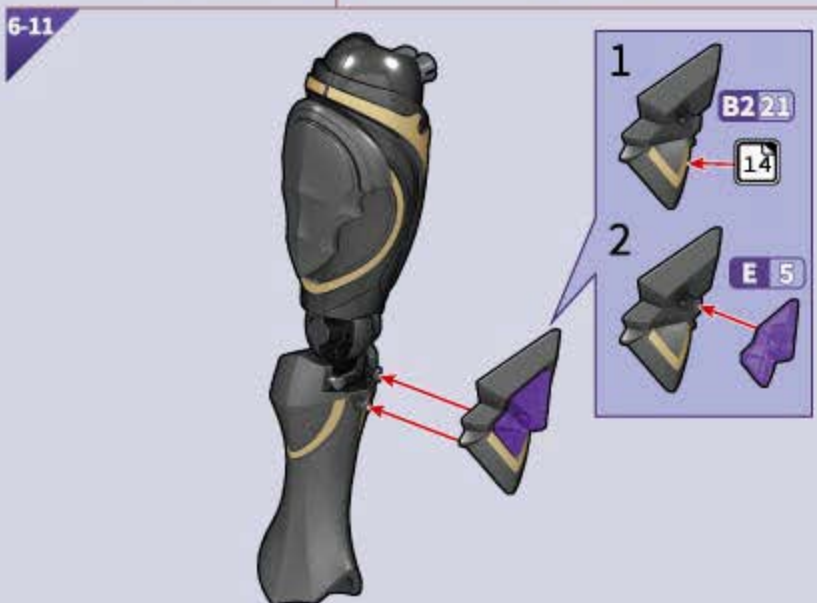
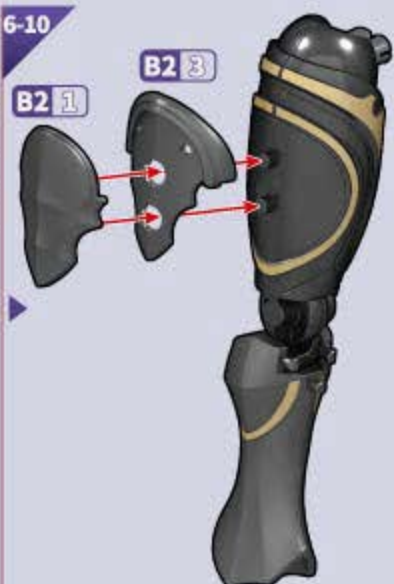
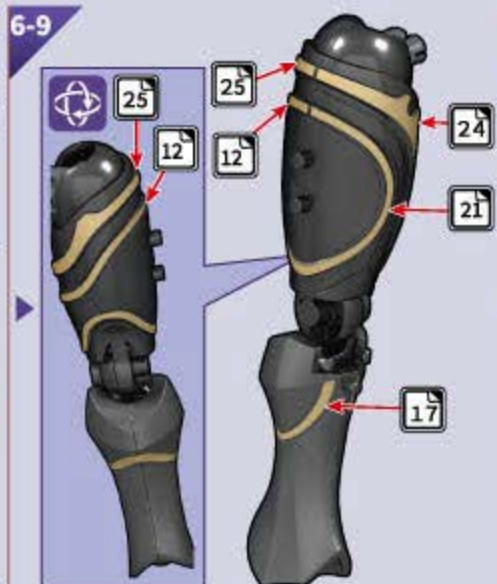

7 左腿组件



A板件

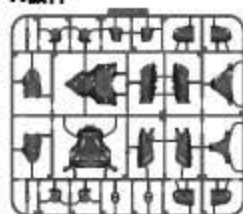

B2板件

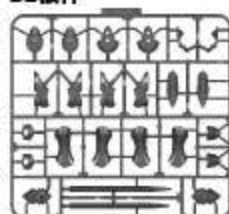

E板件



F板件



板件编码

零件编码

A1 18



所需板件

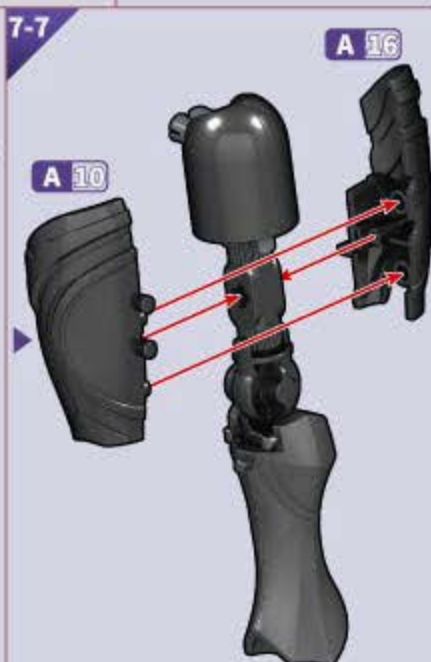
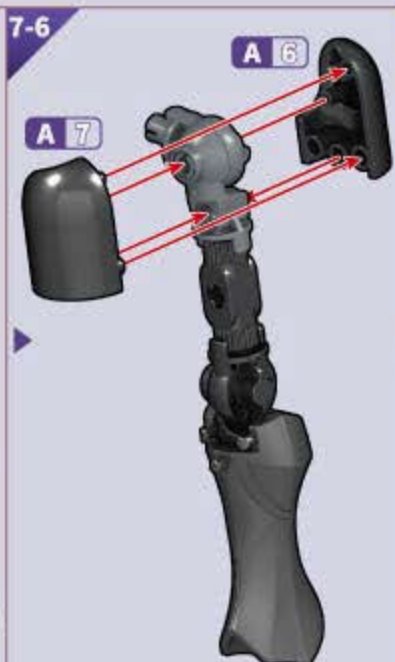
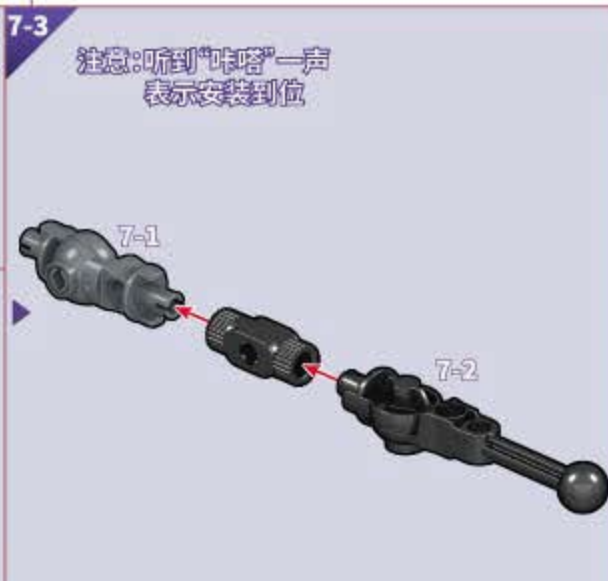
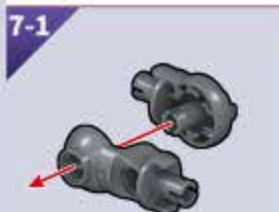

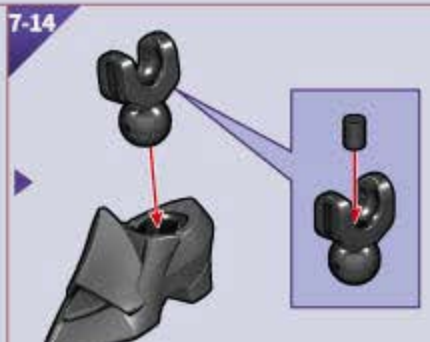
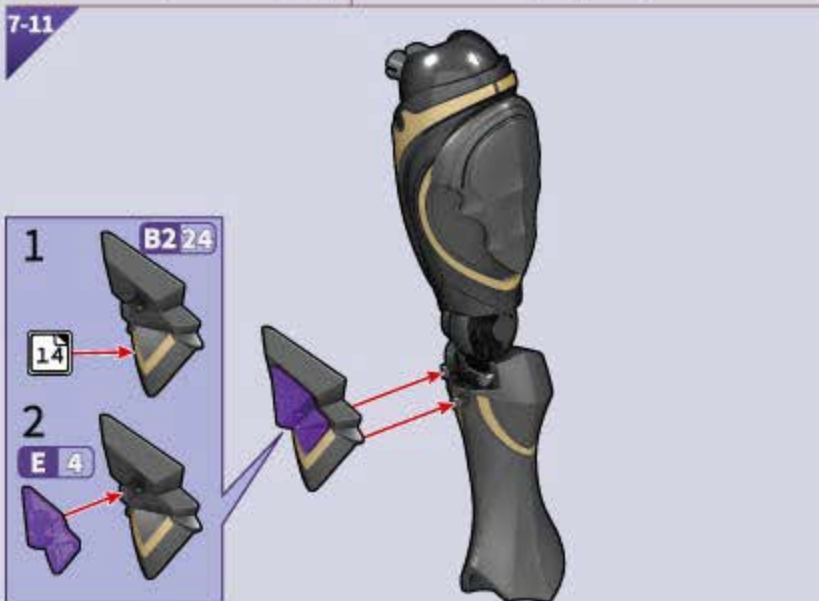
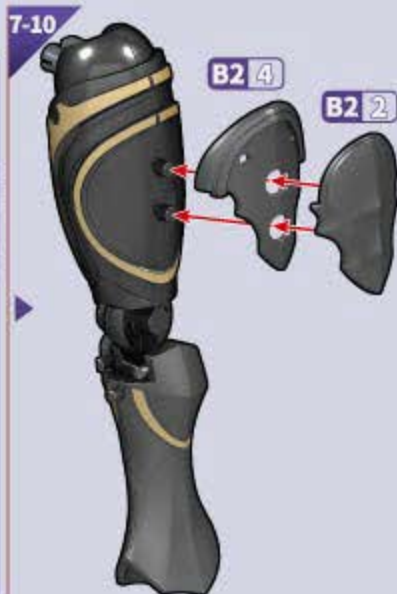
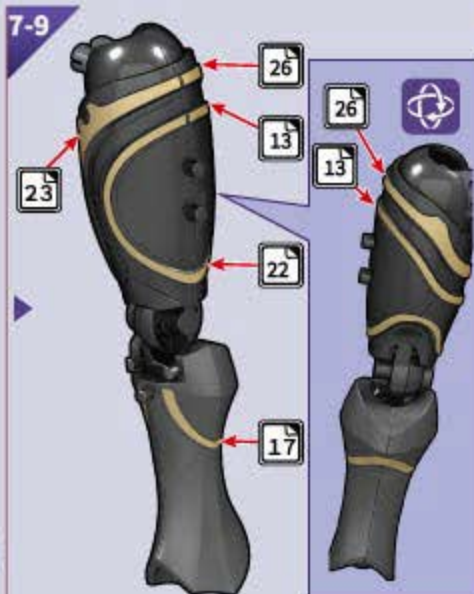

8 右肩甲组件



B1板件

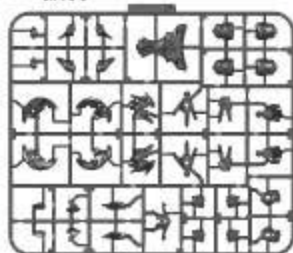

C1板件



E板件



所需板件

板件编码 零件编码

A1 X

8-1

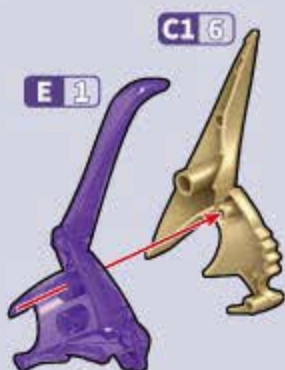

8-2



8-3



8-4



8-5



8-6

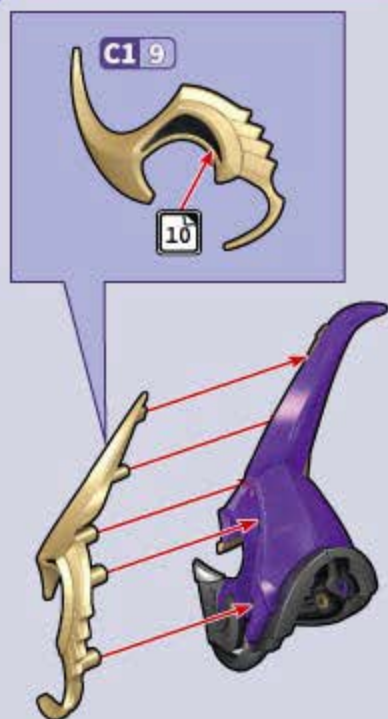

9 左肩甲组件



B1板件

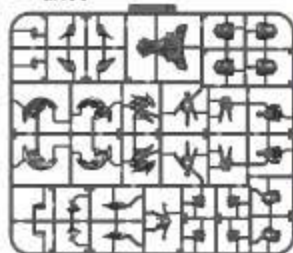

C1板件



E板件



所需板件



9-1

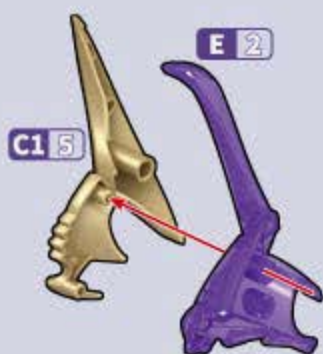

9-2



9-3



9-4



9-5

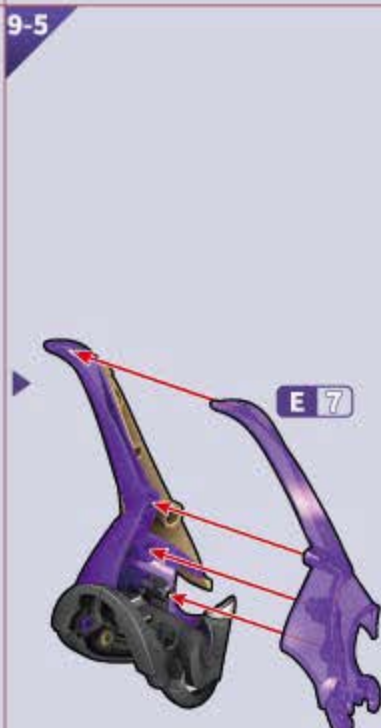

9-6



10 披风组件



所需板件

D板件



板件编码

零件编码

A1 X

10-1

右后披风



D 2



D 1

10-2

左后披风

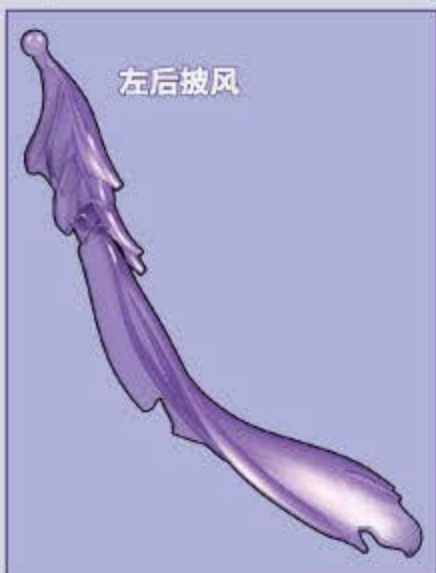

D 3



D 4

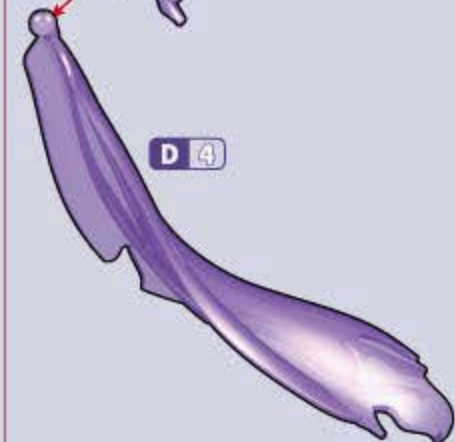

11 头顶组件



E板件

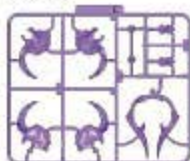

所需板件

11-1

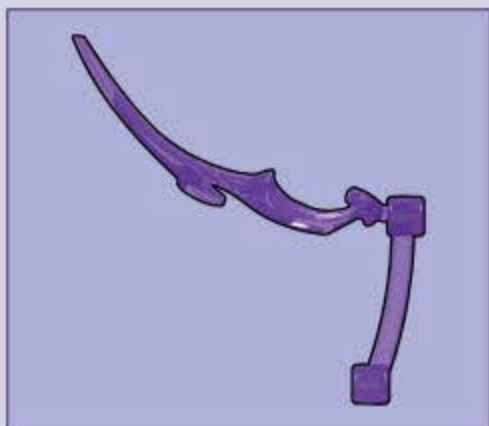
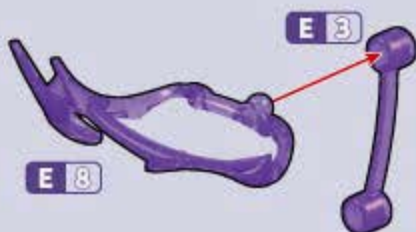

12 裙甲组件



B2板件

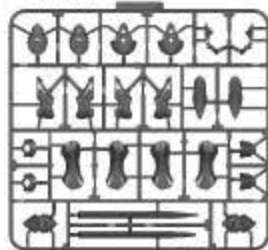

C1板件



所需板件

12-1

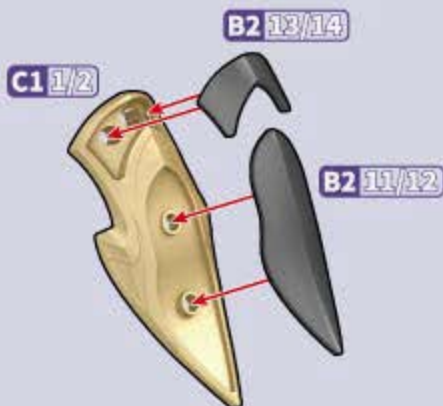

13
武器组件



B2板件

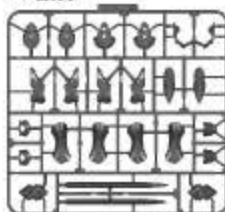

C2板件



所需板件

F板件



板件编码

零件编码

A1 X

13-1

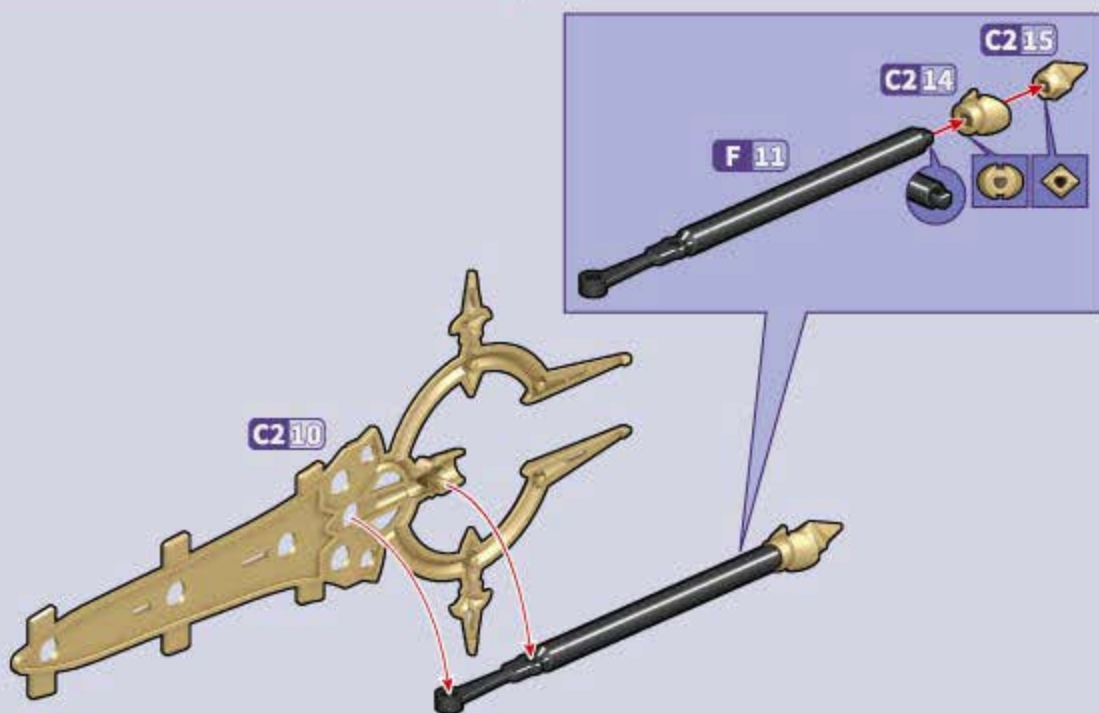

13-2

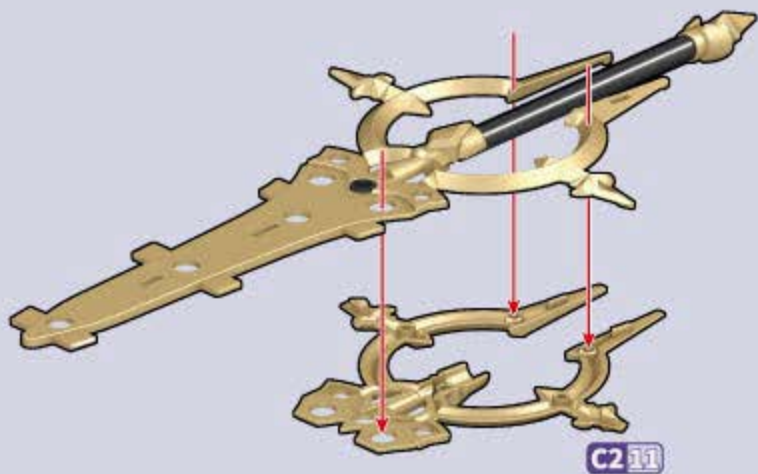

13-3

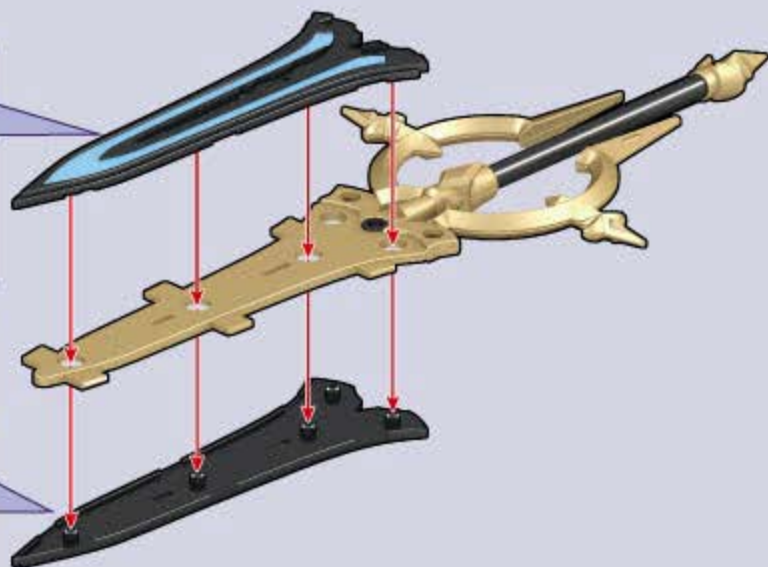
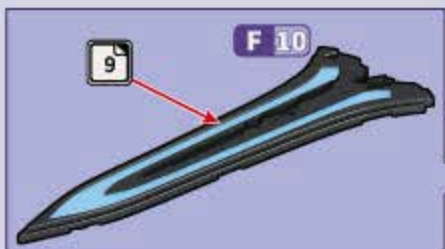
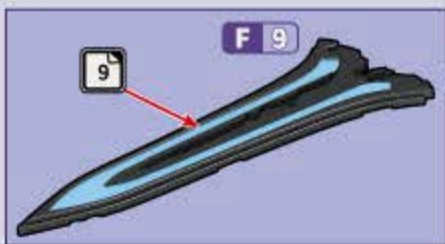

13-4

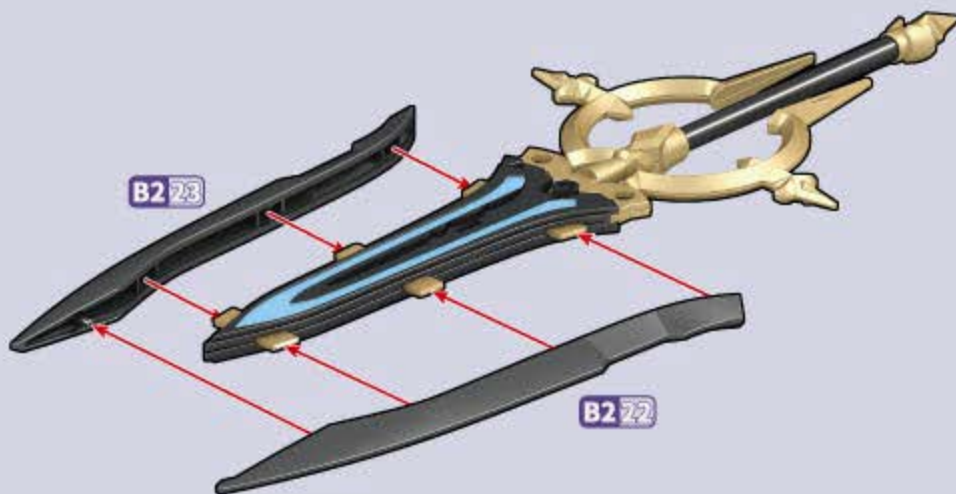

13-5

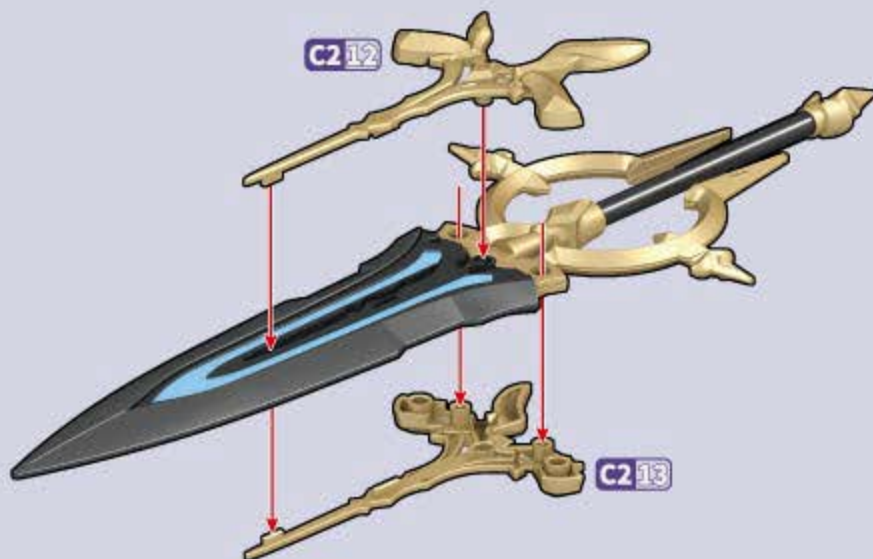

1

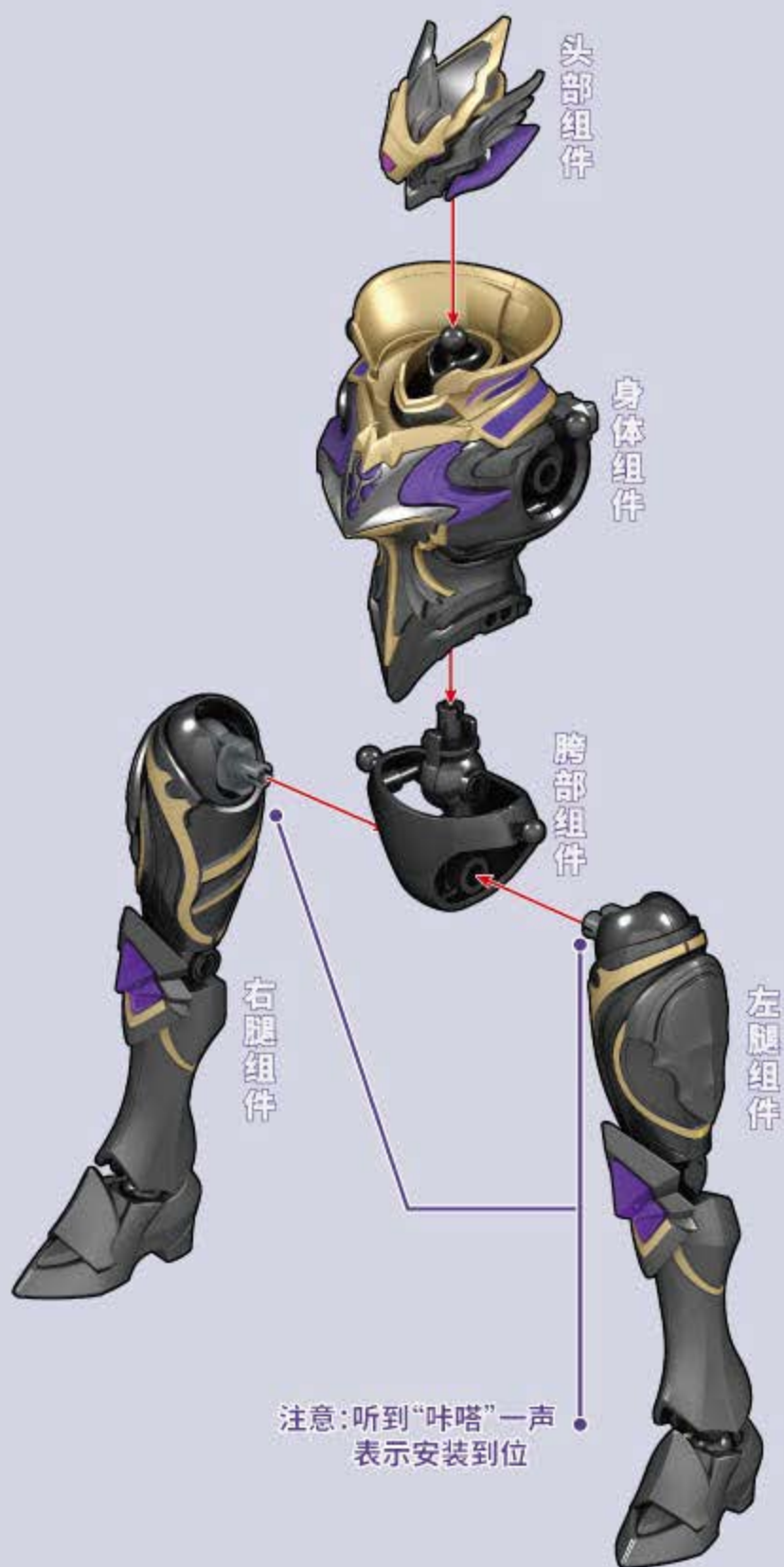

2

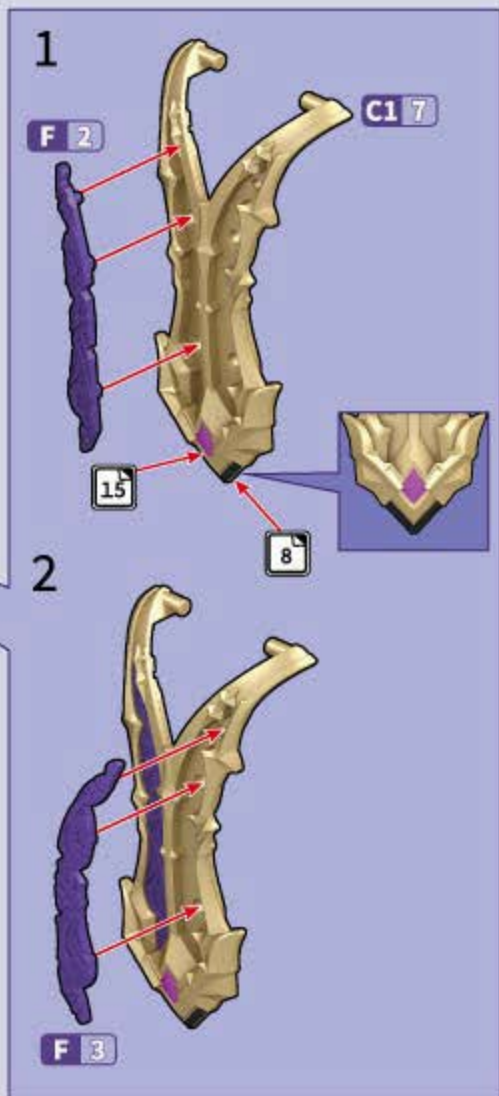
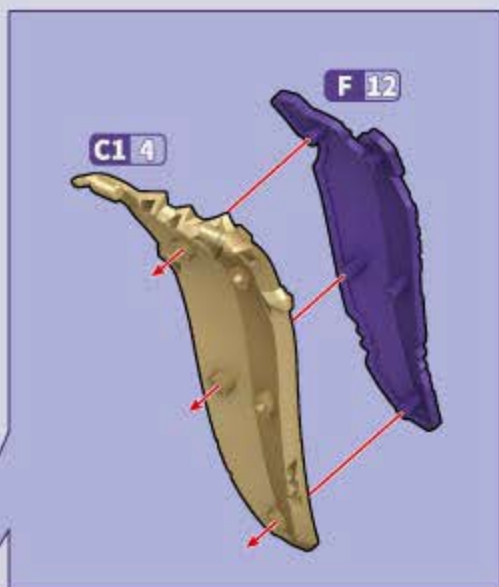

3



右后披风

左后披风



裙甲组件

裙甲组件

4



完成

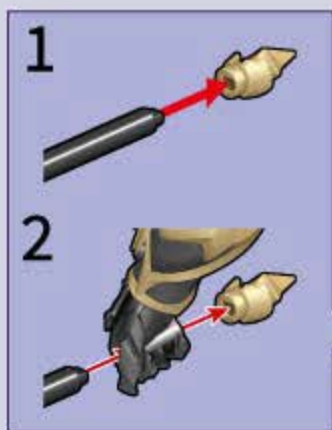



©2026 Tencent. All Rights Reserved.
腾讯公司 版权所有

V1.0