

# 鳄鱼山饼干工厂



上册

正版授权

K20642

图片仅供参考, 请以实物为准。

© USUI YOSHITO 1992-2025 Licensed by Animation Int'l



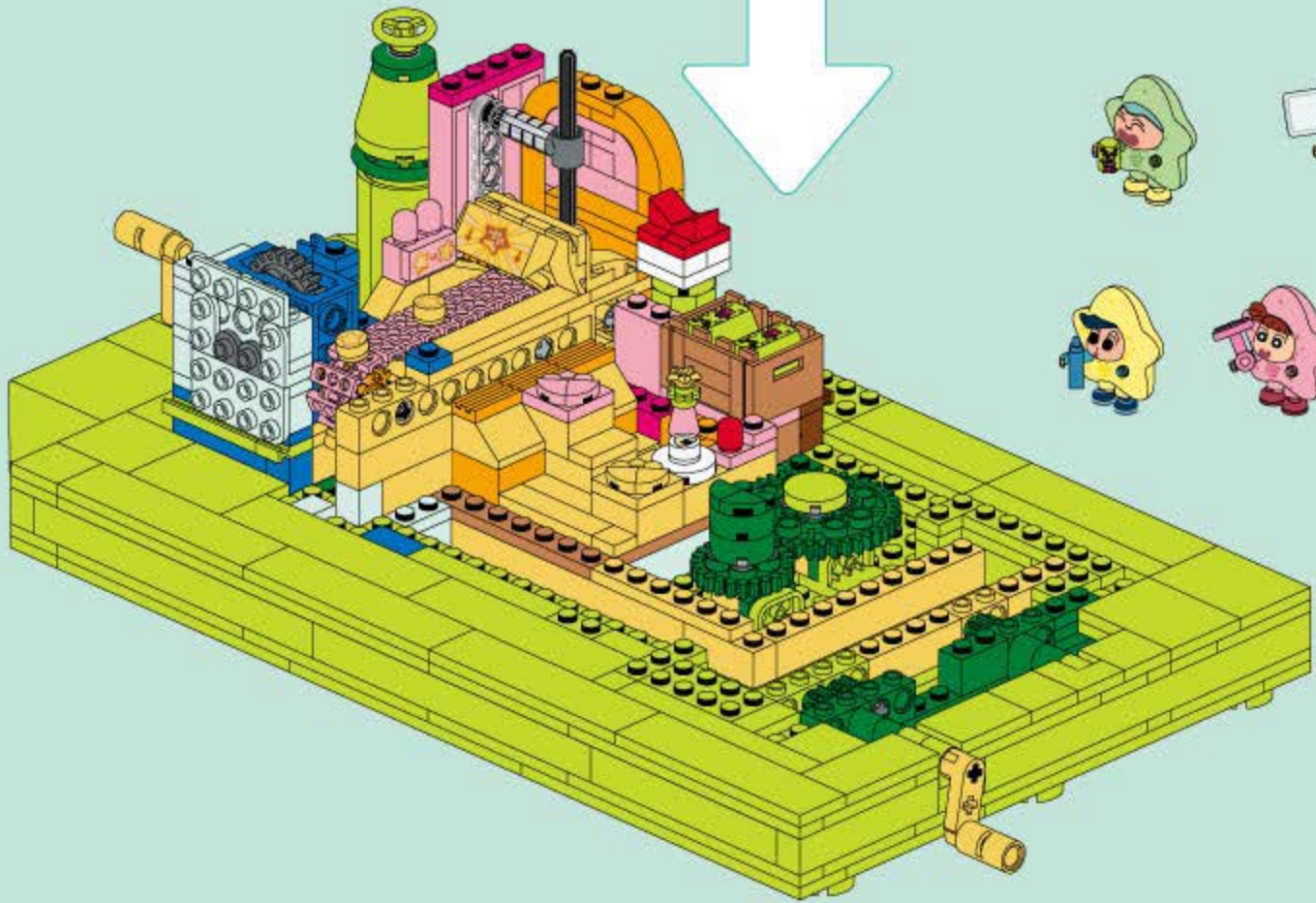

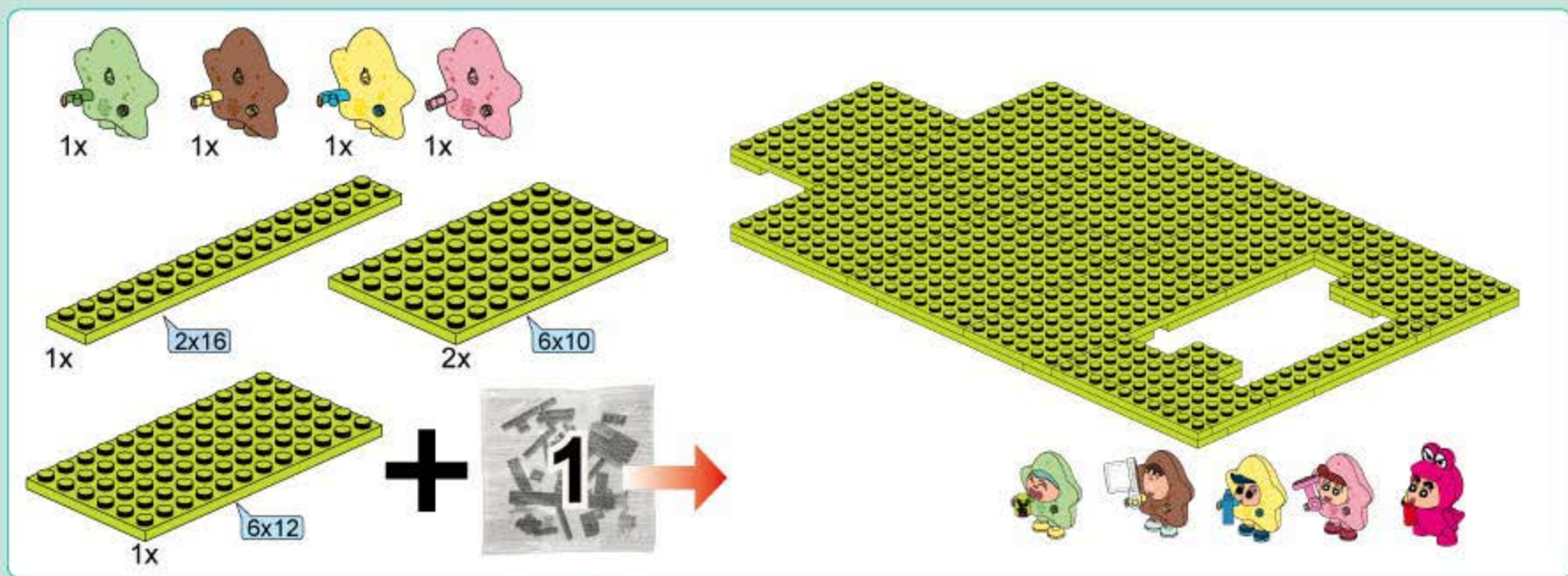

拆件器使用方法，仅为示例

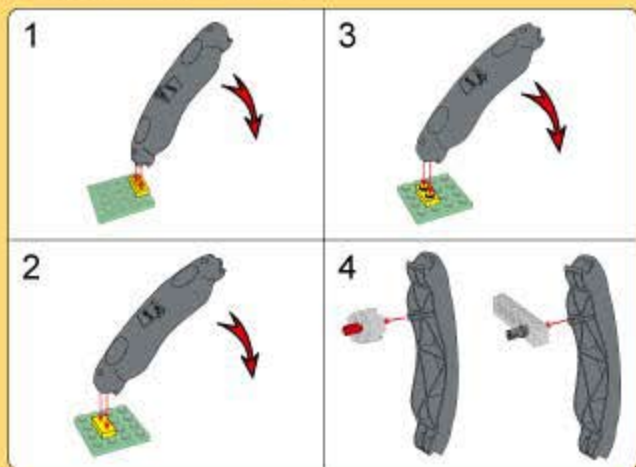



A1

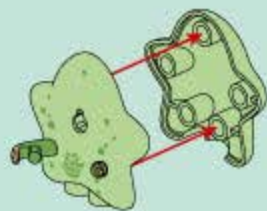
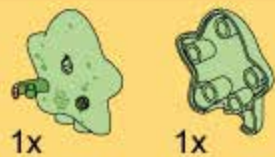

A2

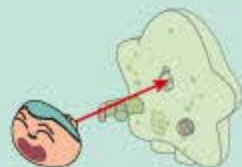

A3



A4



A5

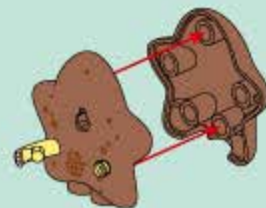

A6



A7



A8





A9

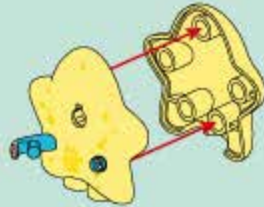
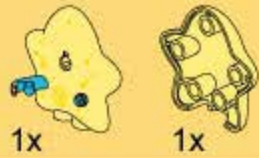

A10



A11



A12



A13

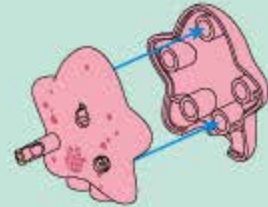

A14



A15



A16





A17

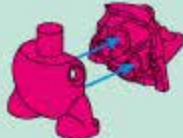
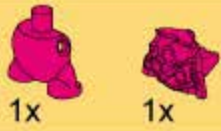

A18



A19

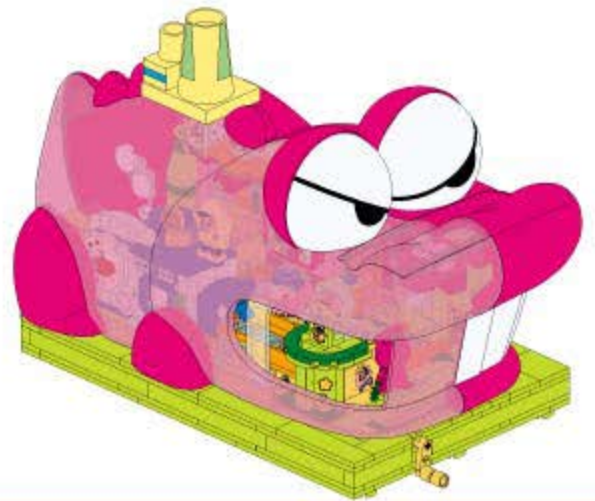
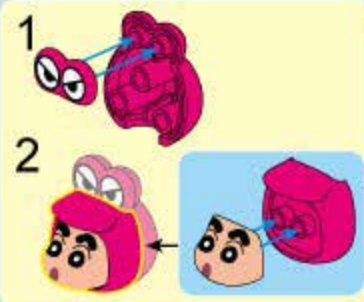

B1

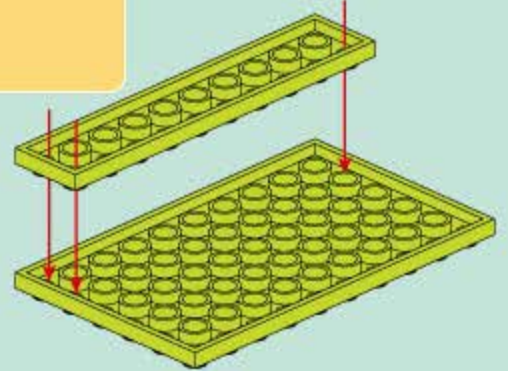
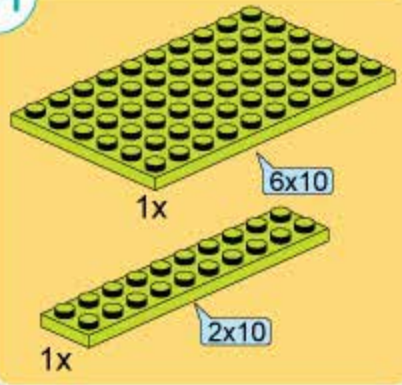

B2

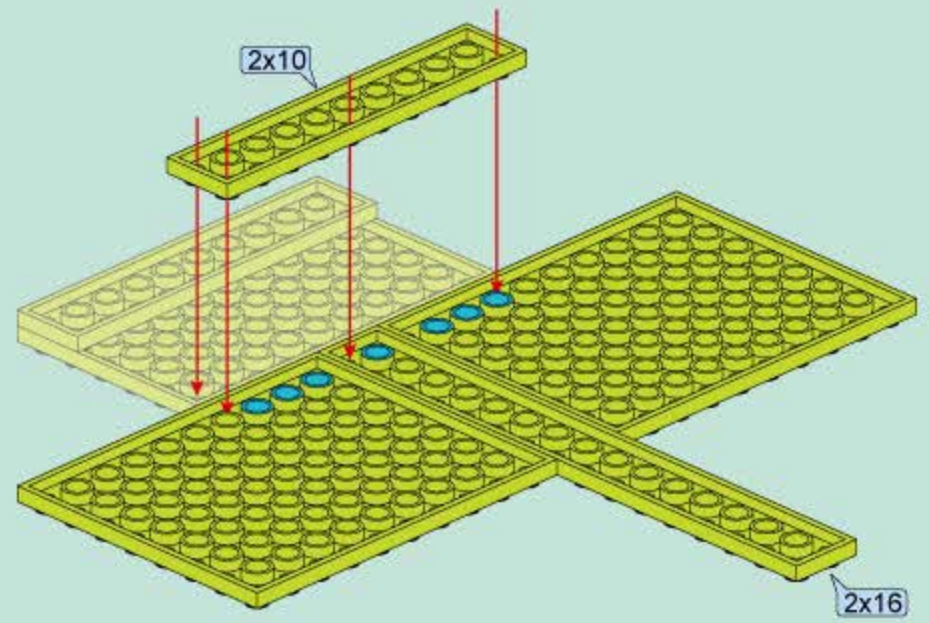
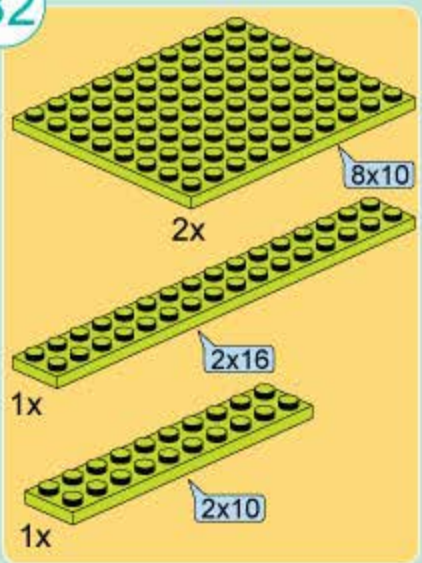

B3

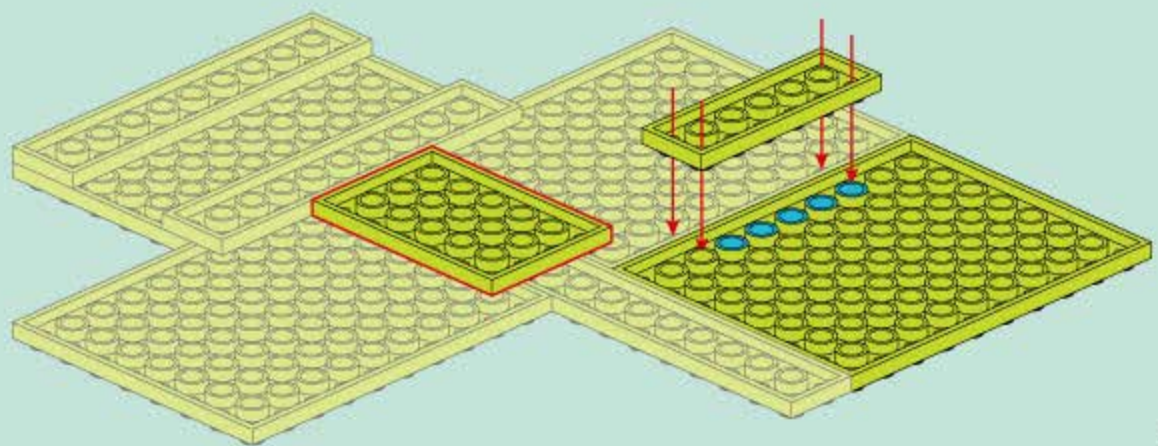
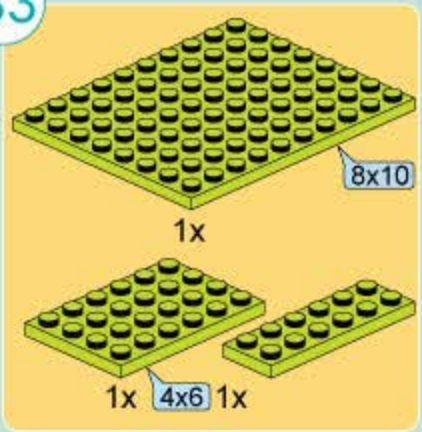

B4

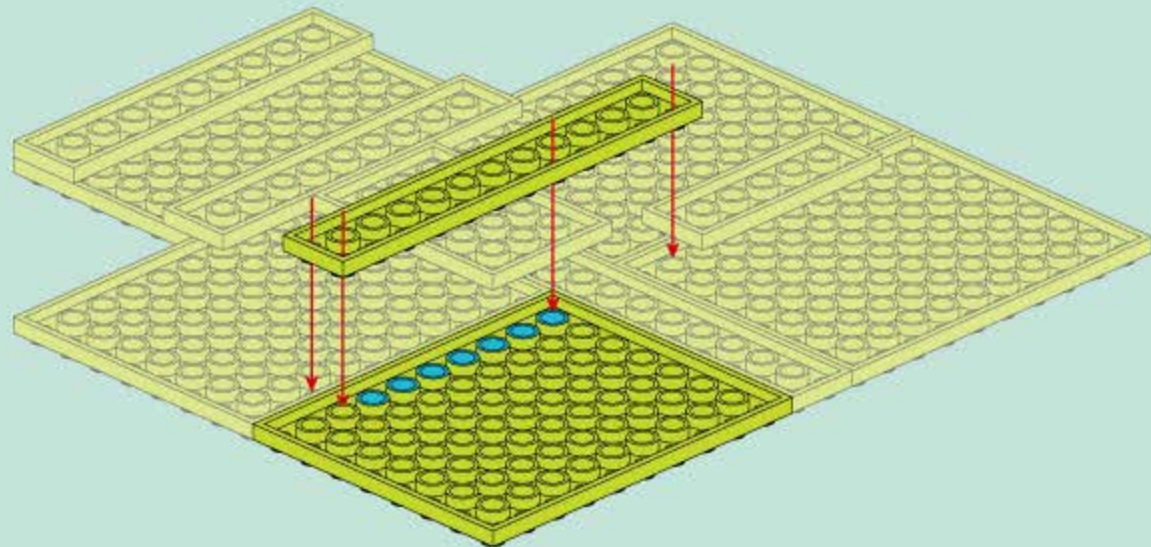
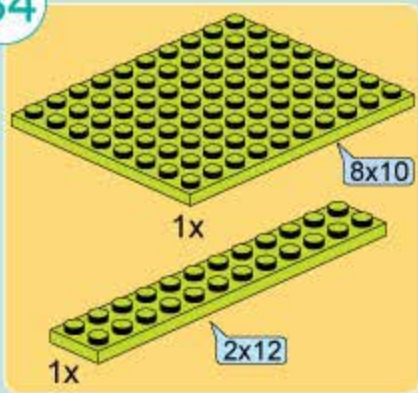

B5

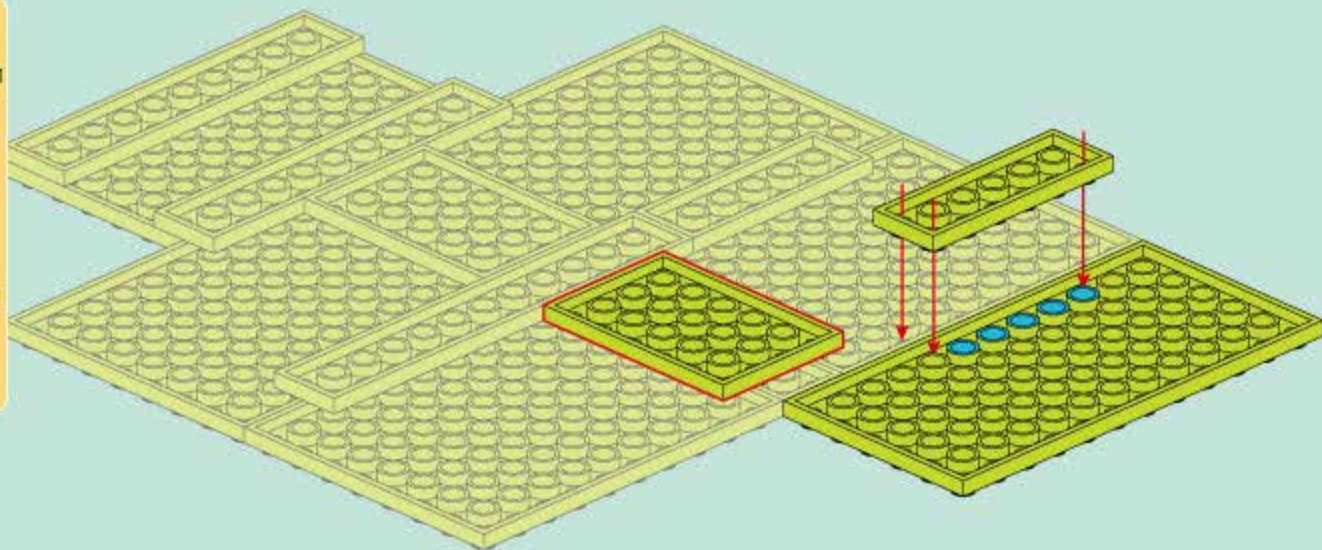
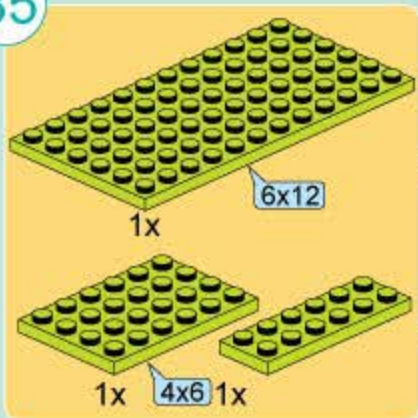

B6

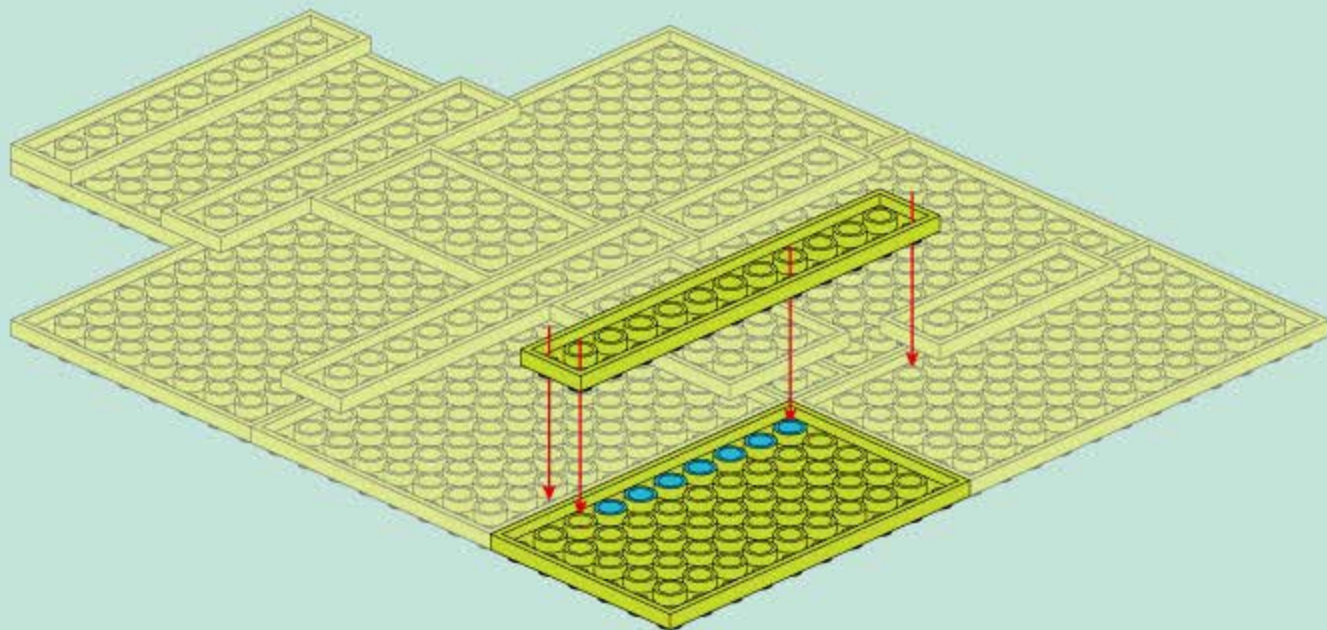
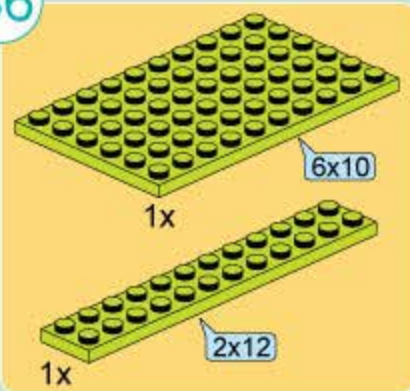

B7

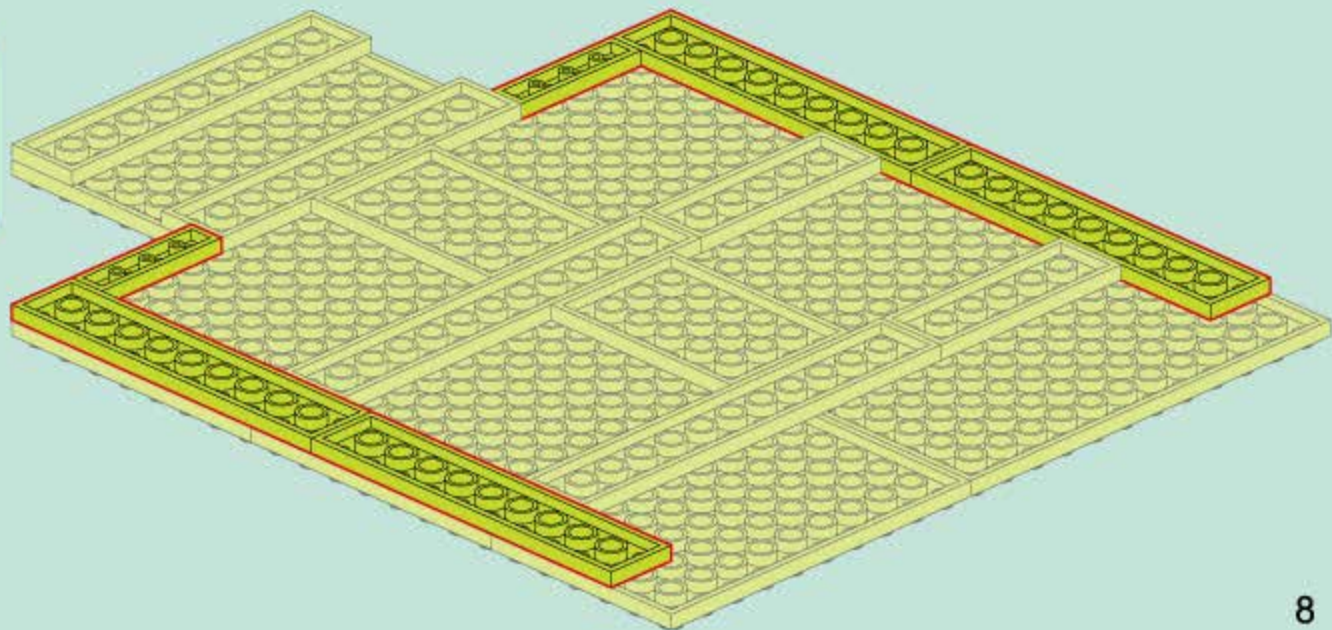
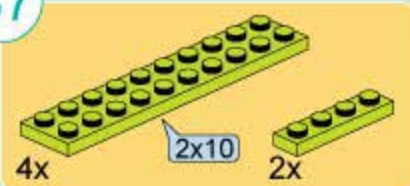

B8

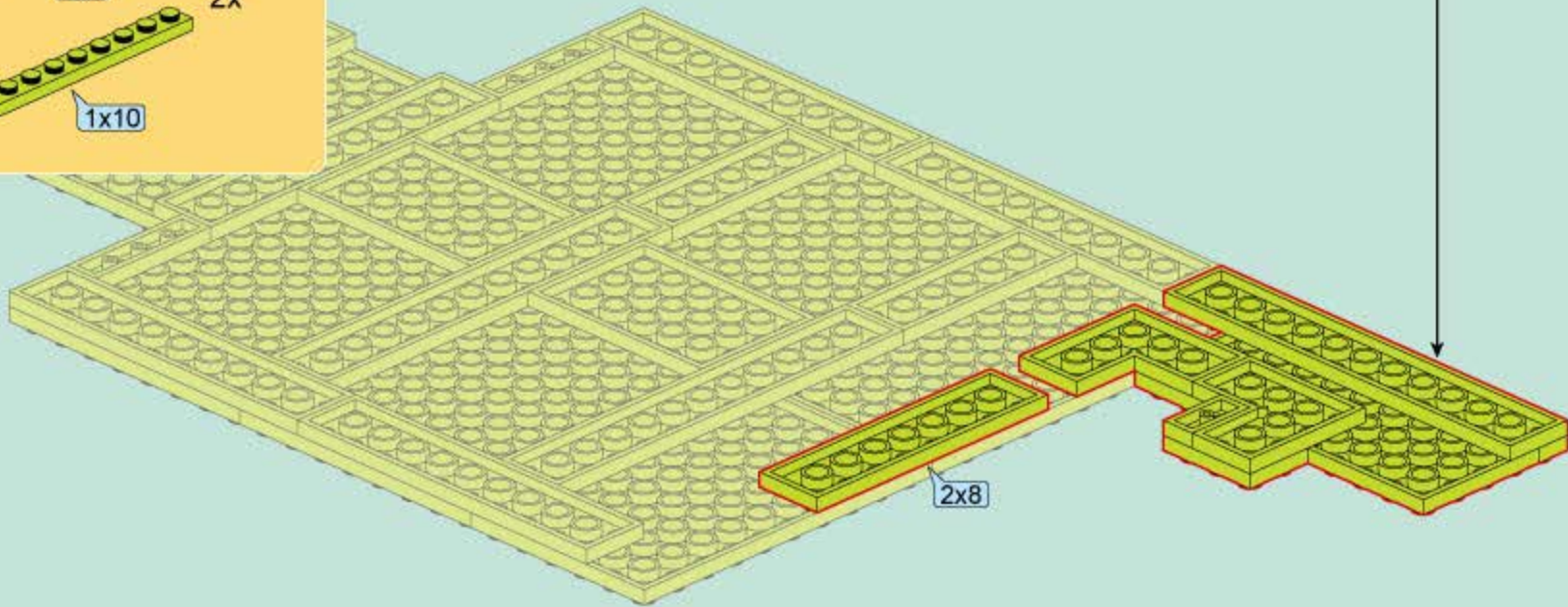
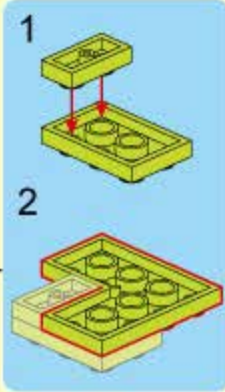
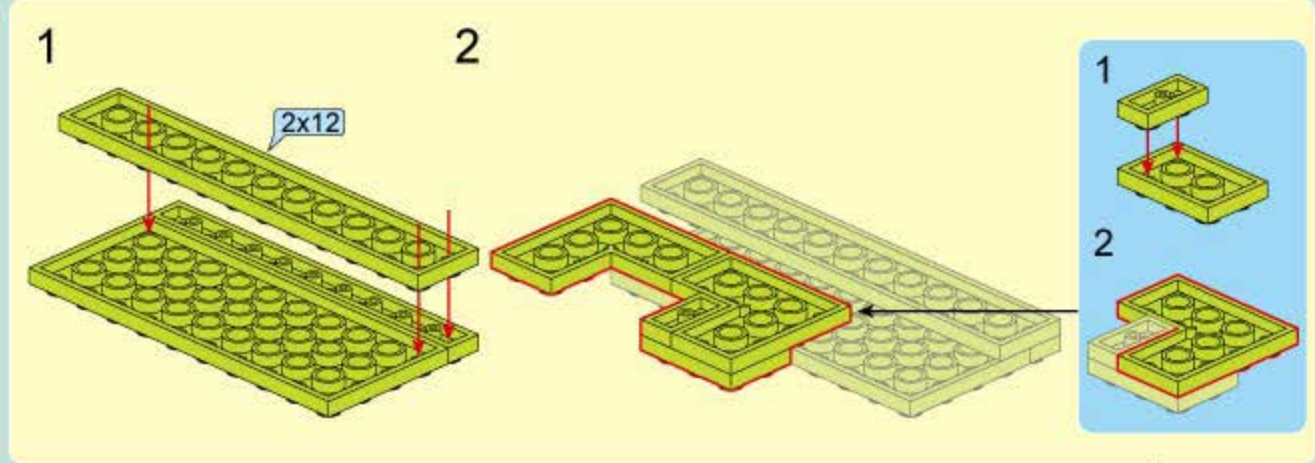
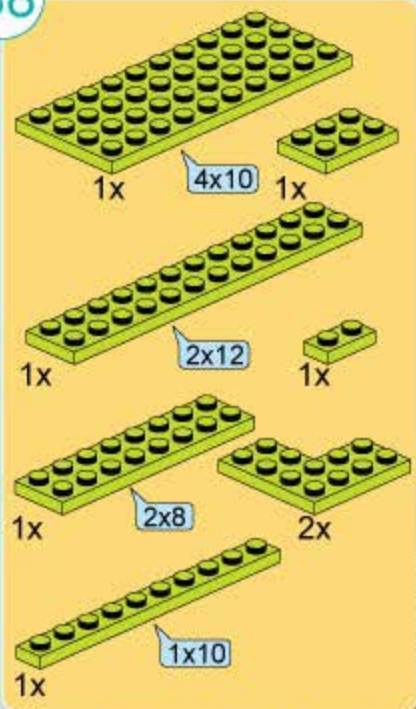

B9

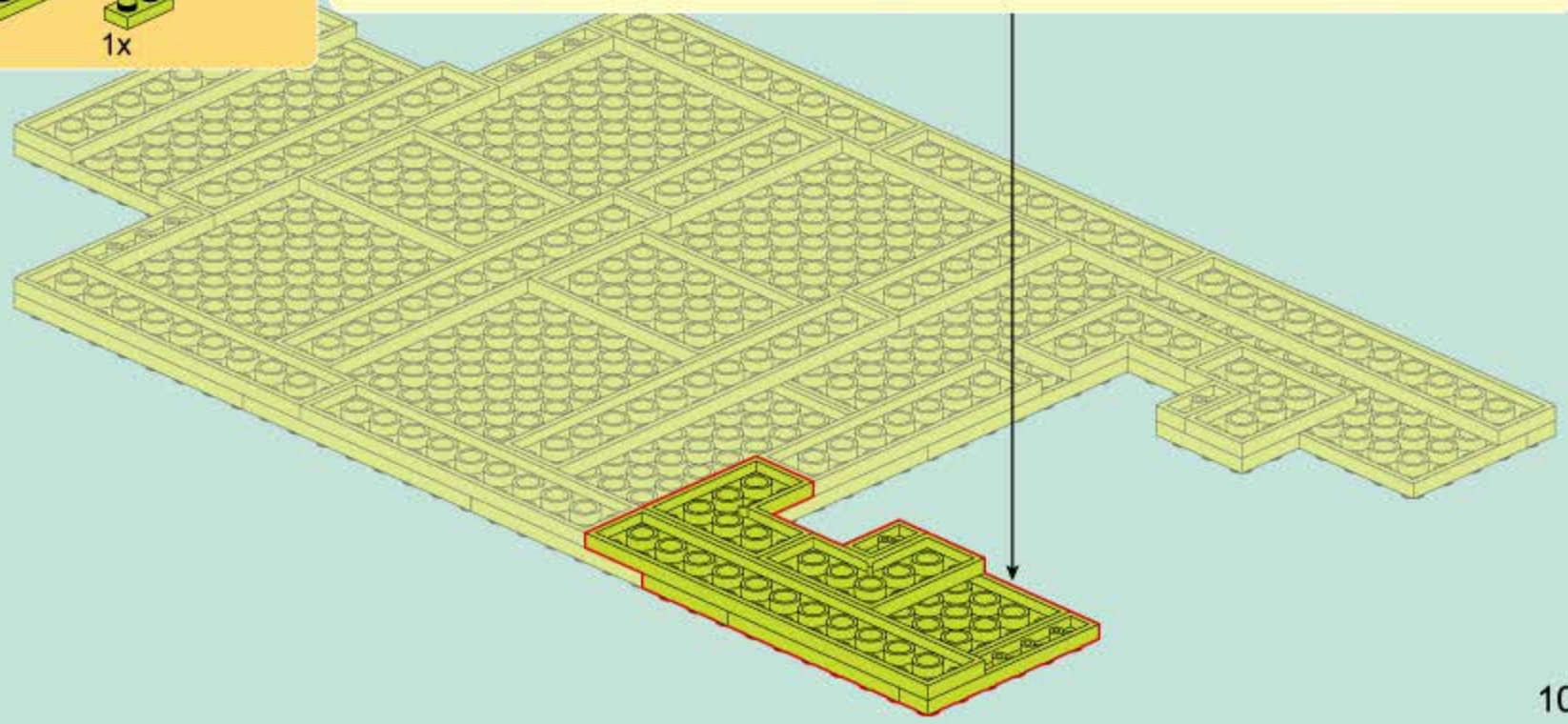
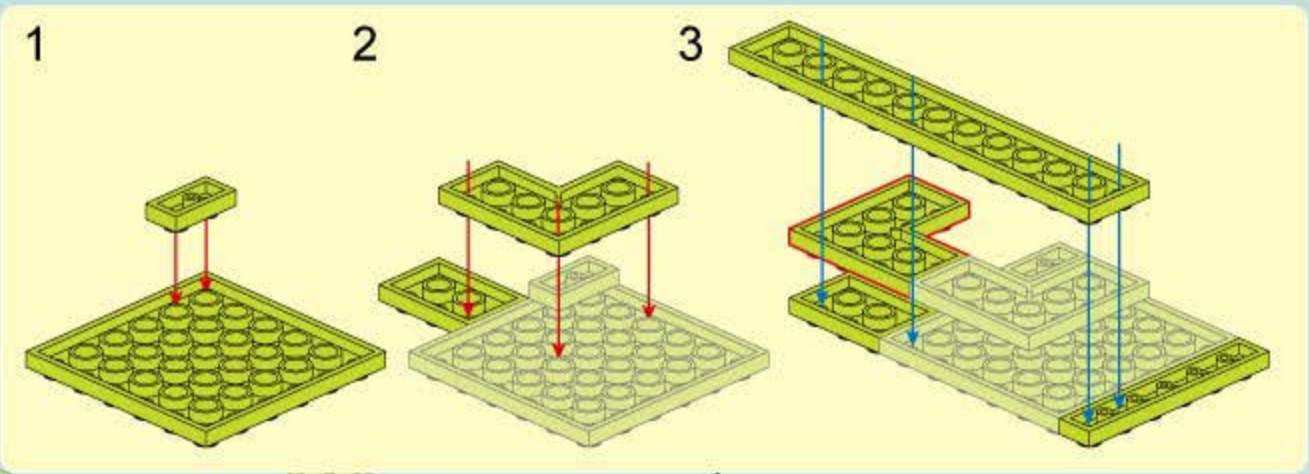
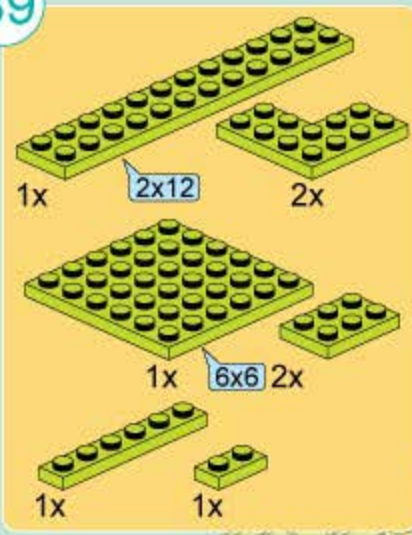

B10

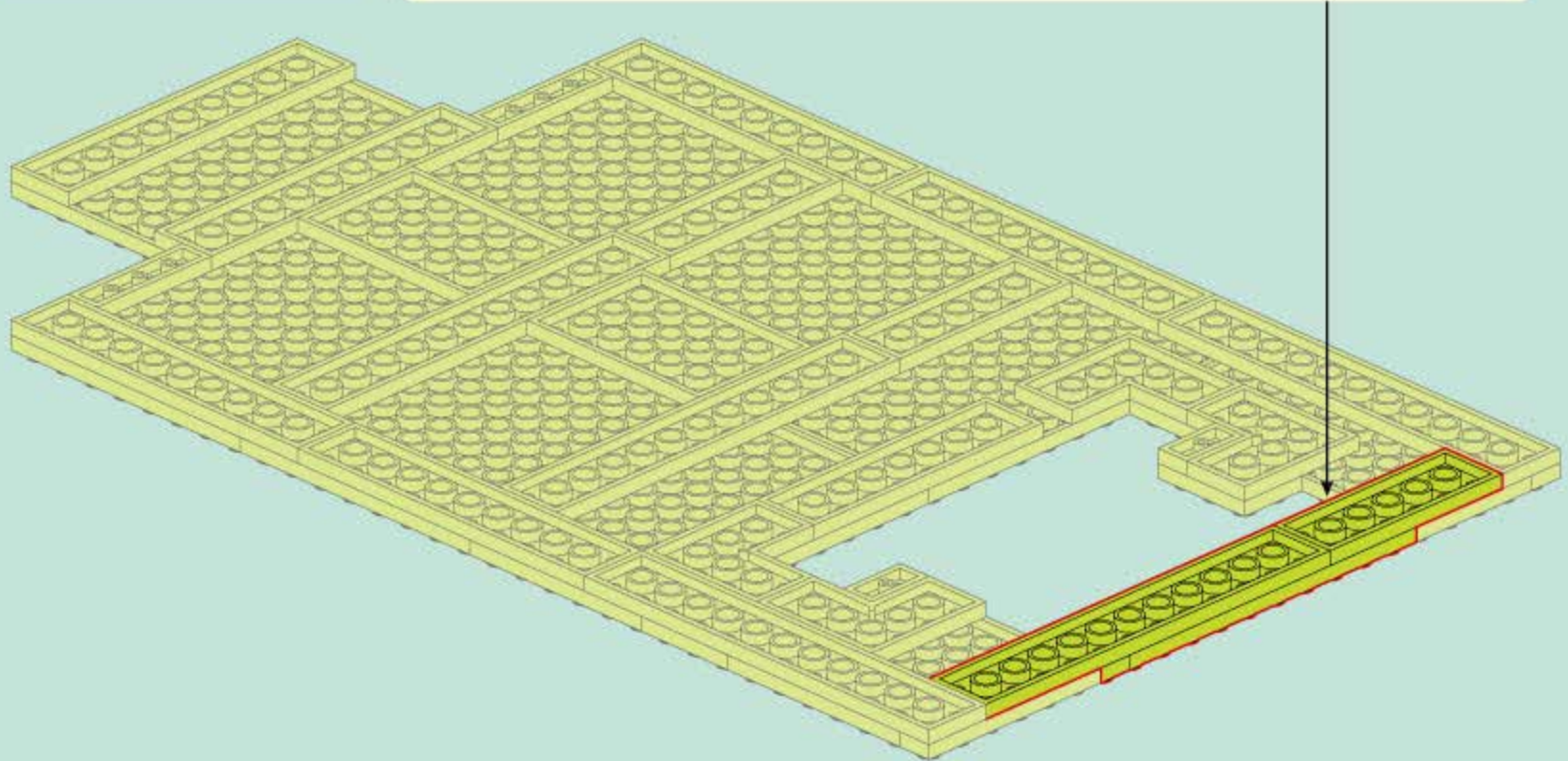
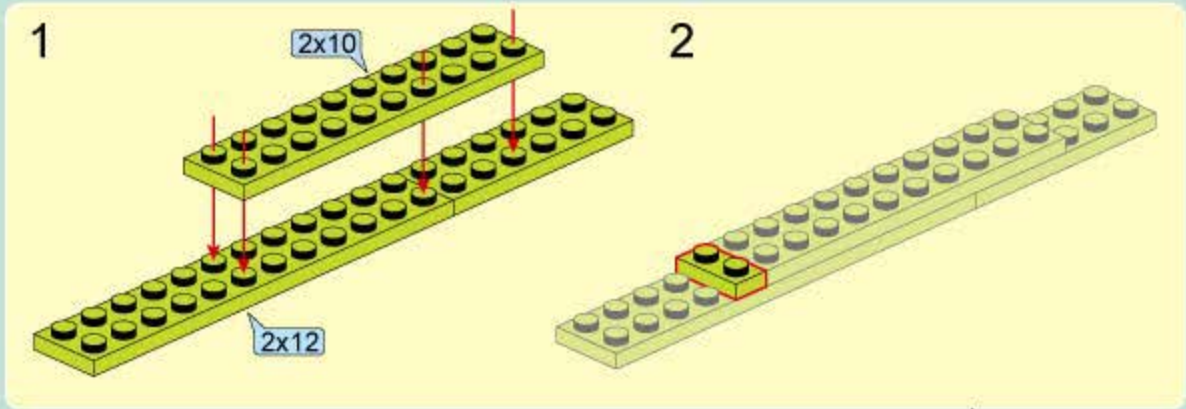
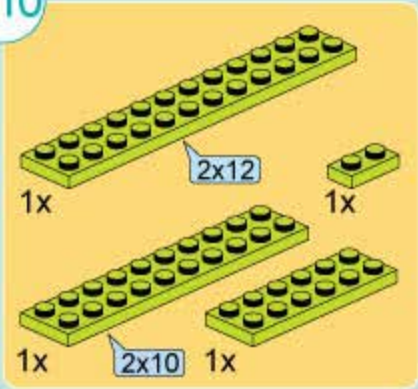

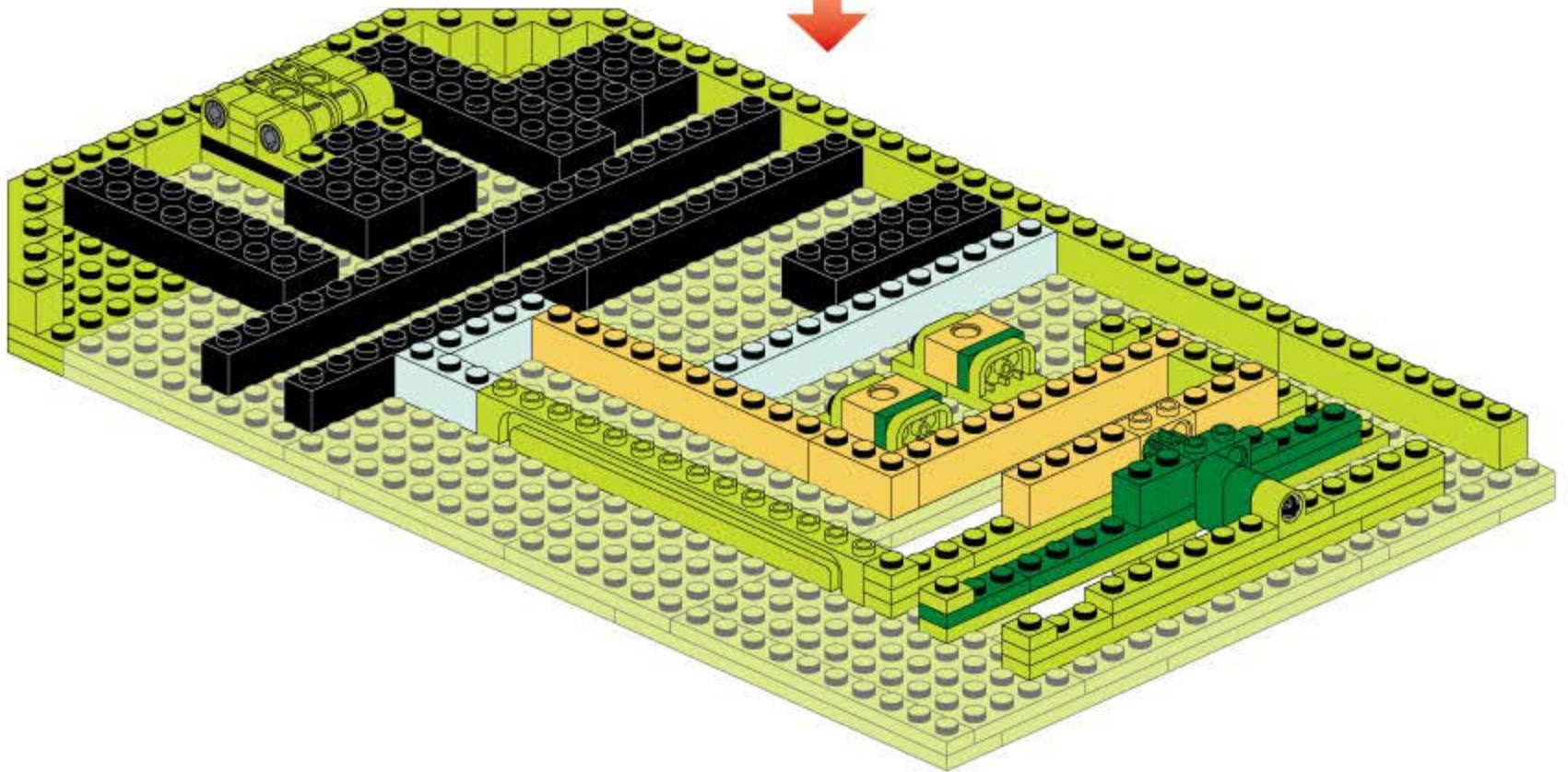



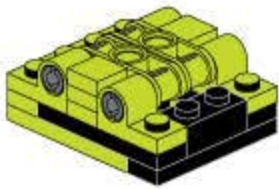

B12

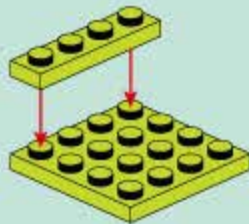
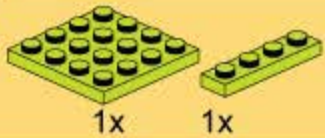

B13

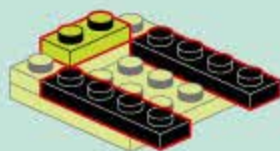

B14

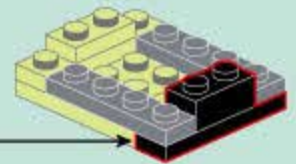
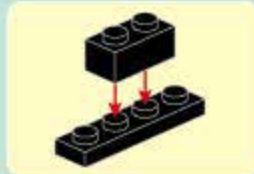

B15

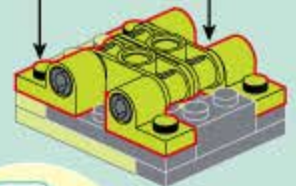
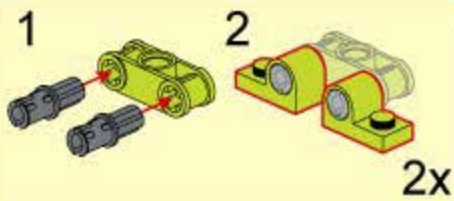

B16

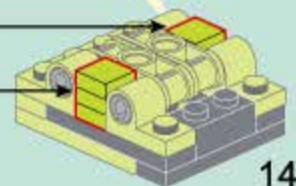
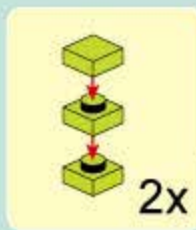

B17

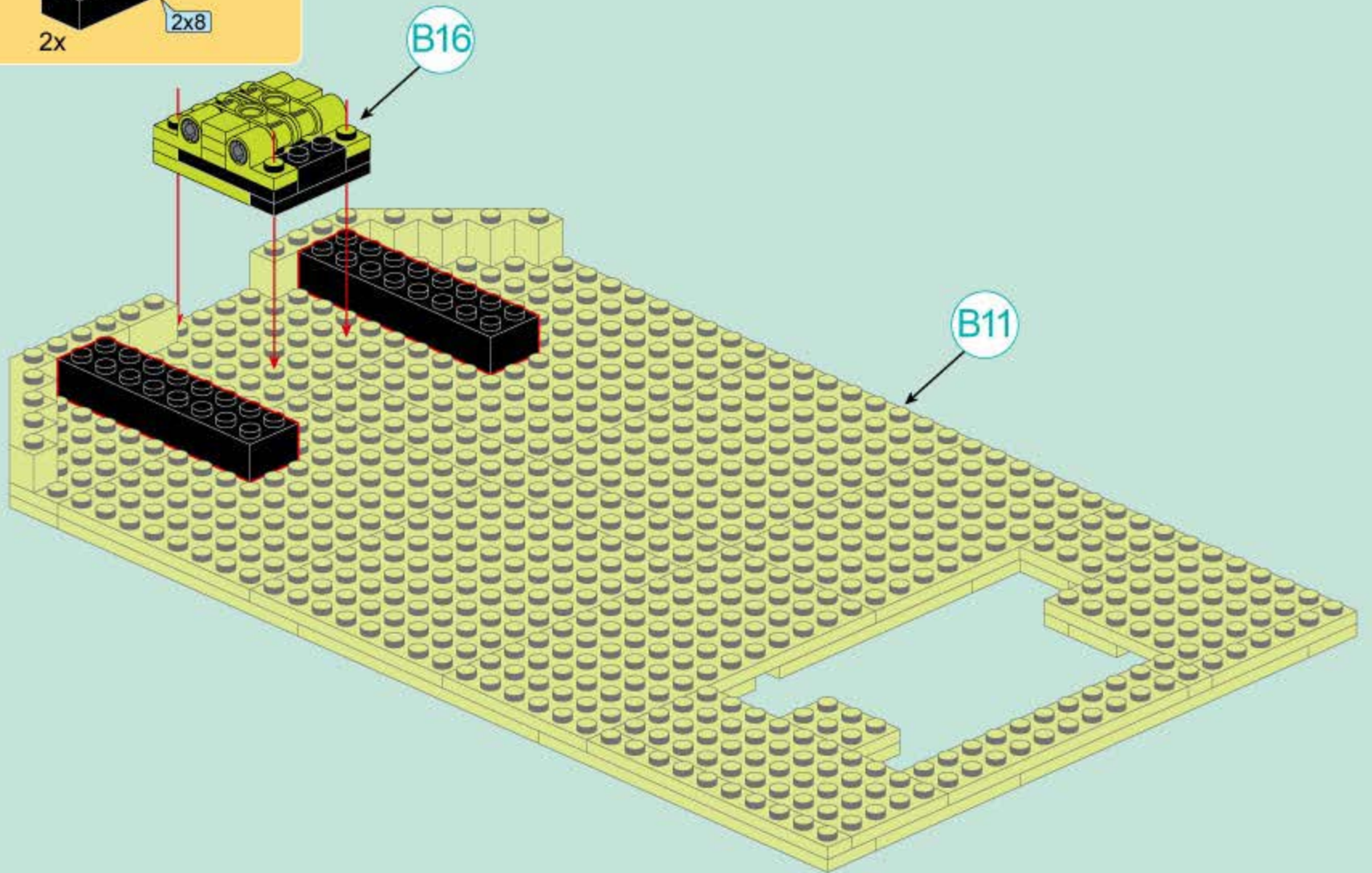
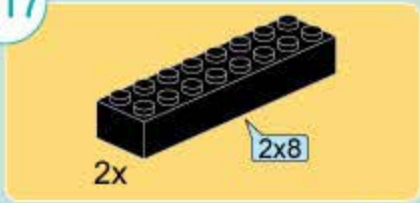

B18

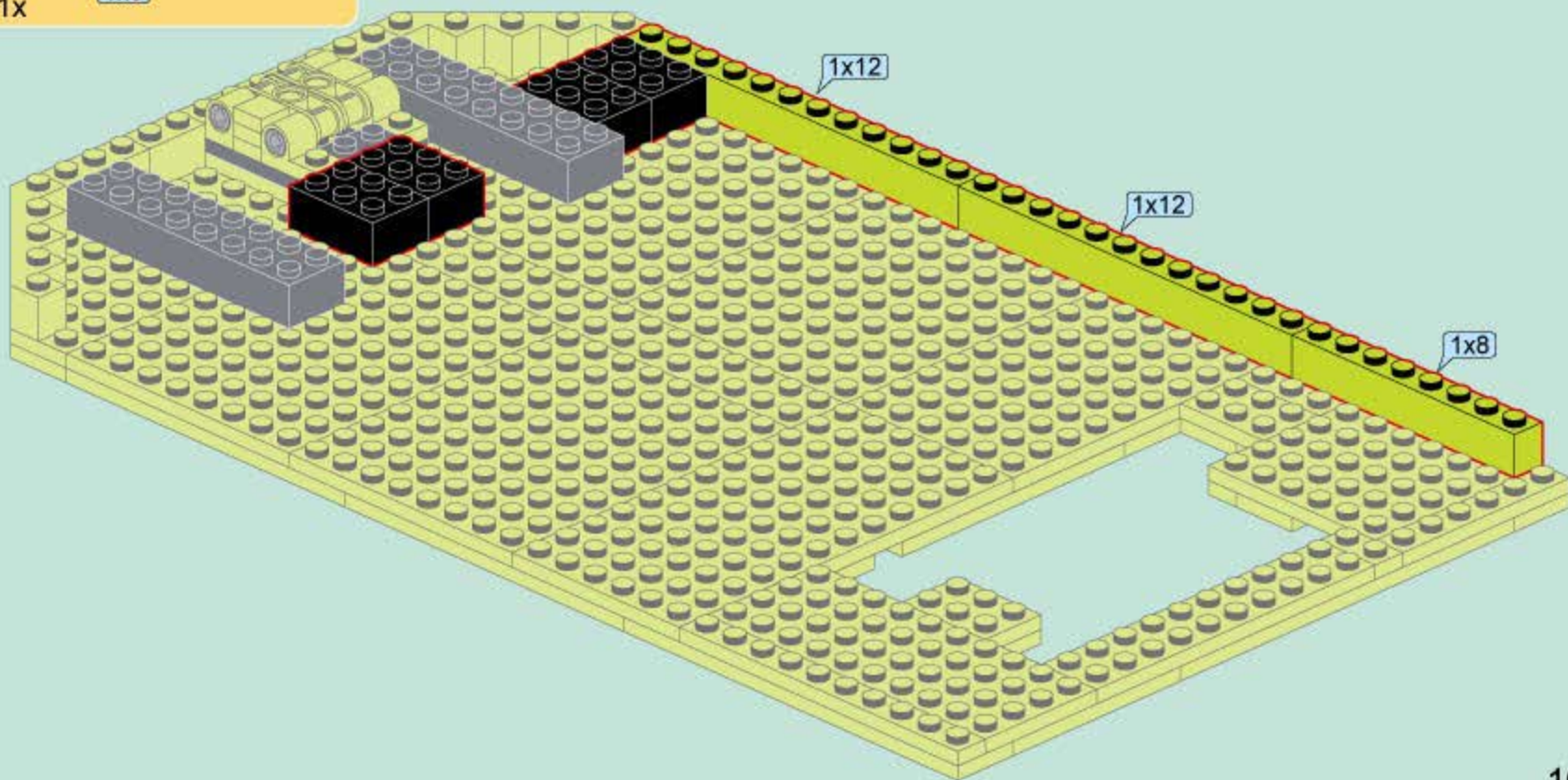
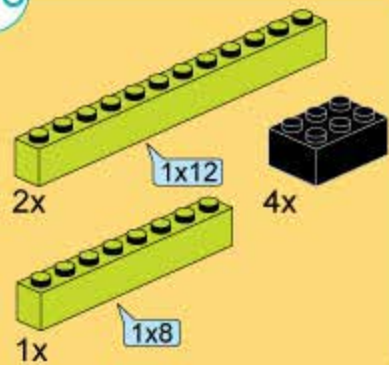

B19

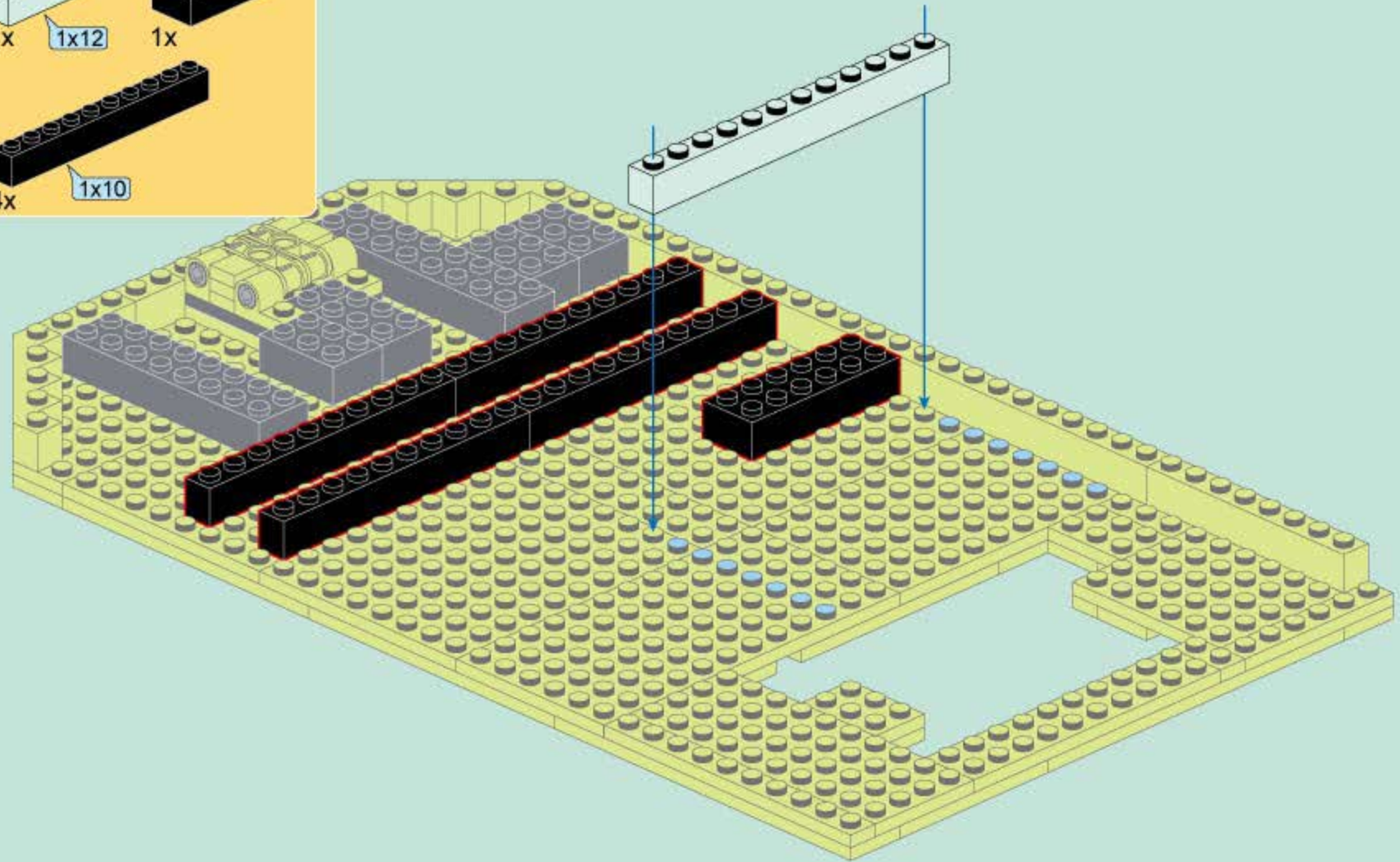
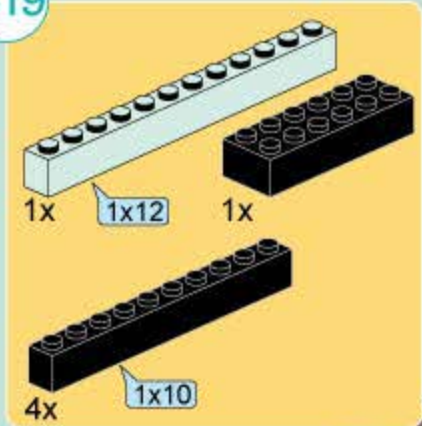

B20

4x  
2x

1x  
2x

1x

1:1

✓ ✗

1 2

2x

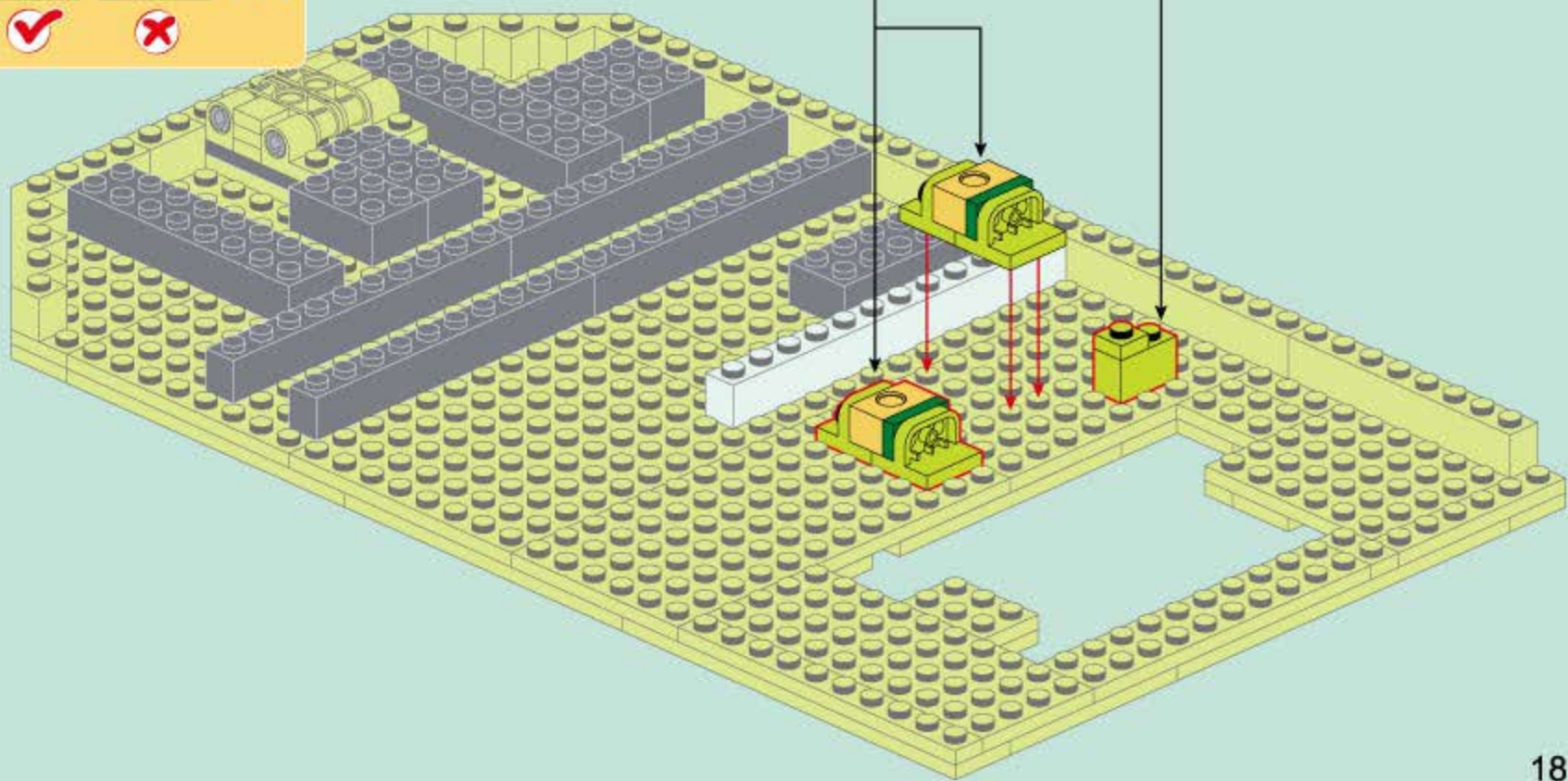

B21

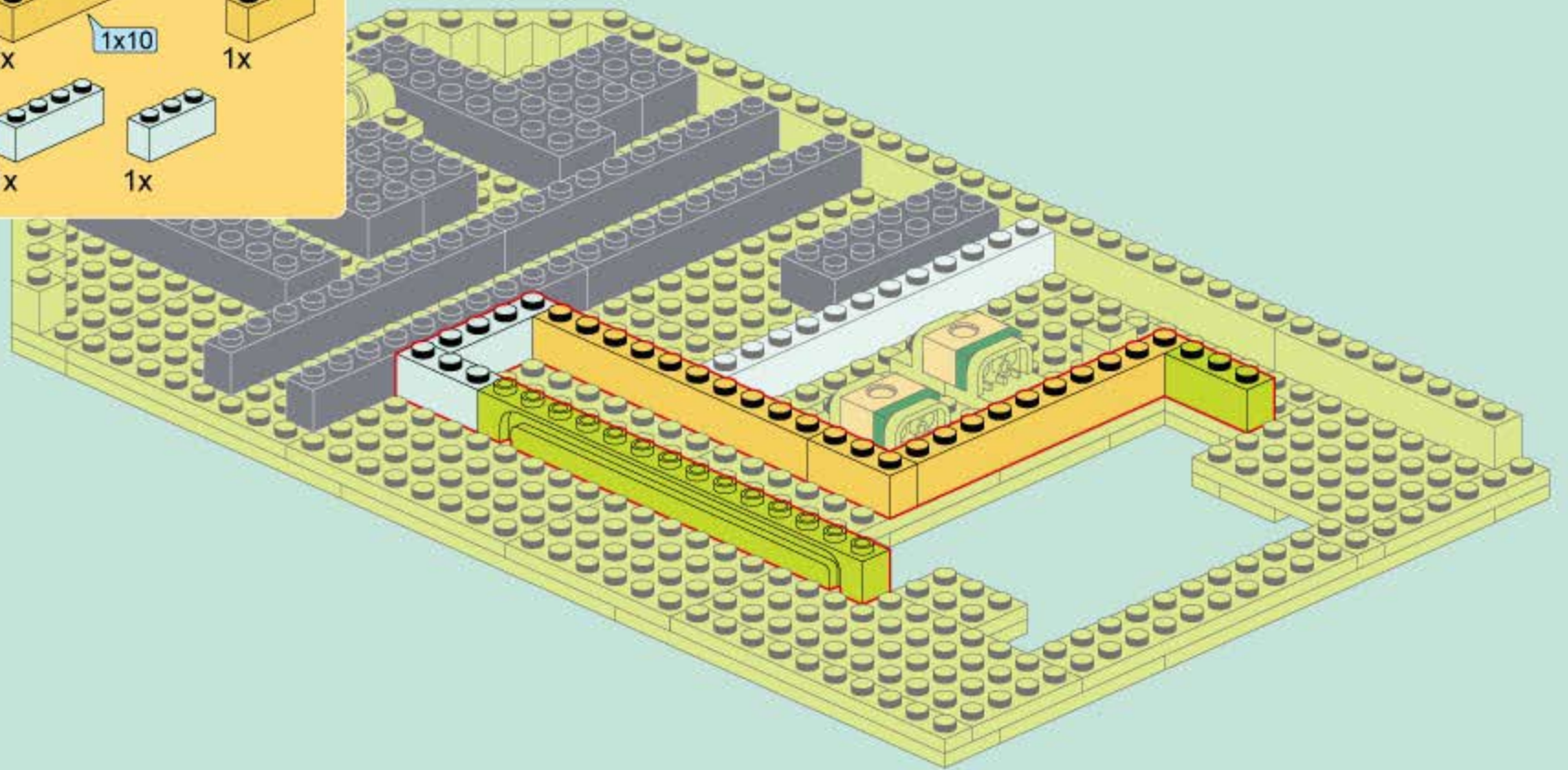
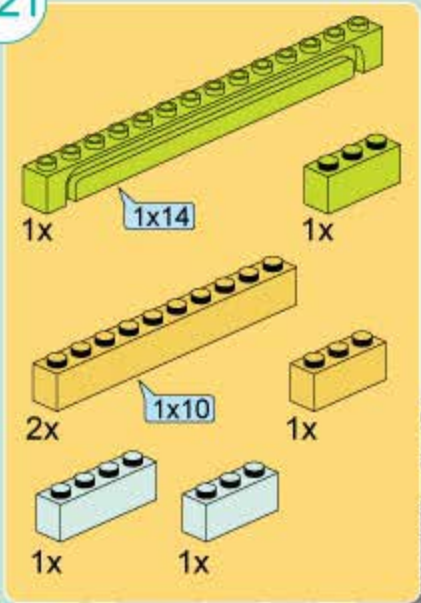

B22

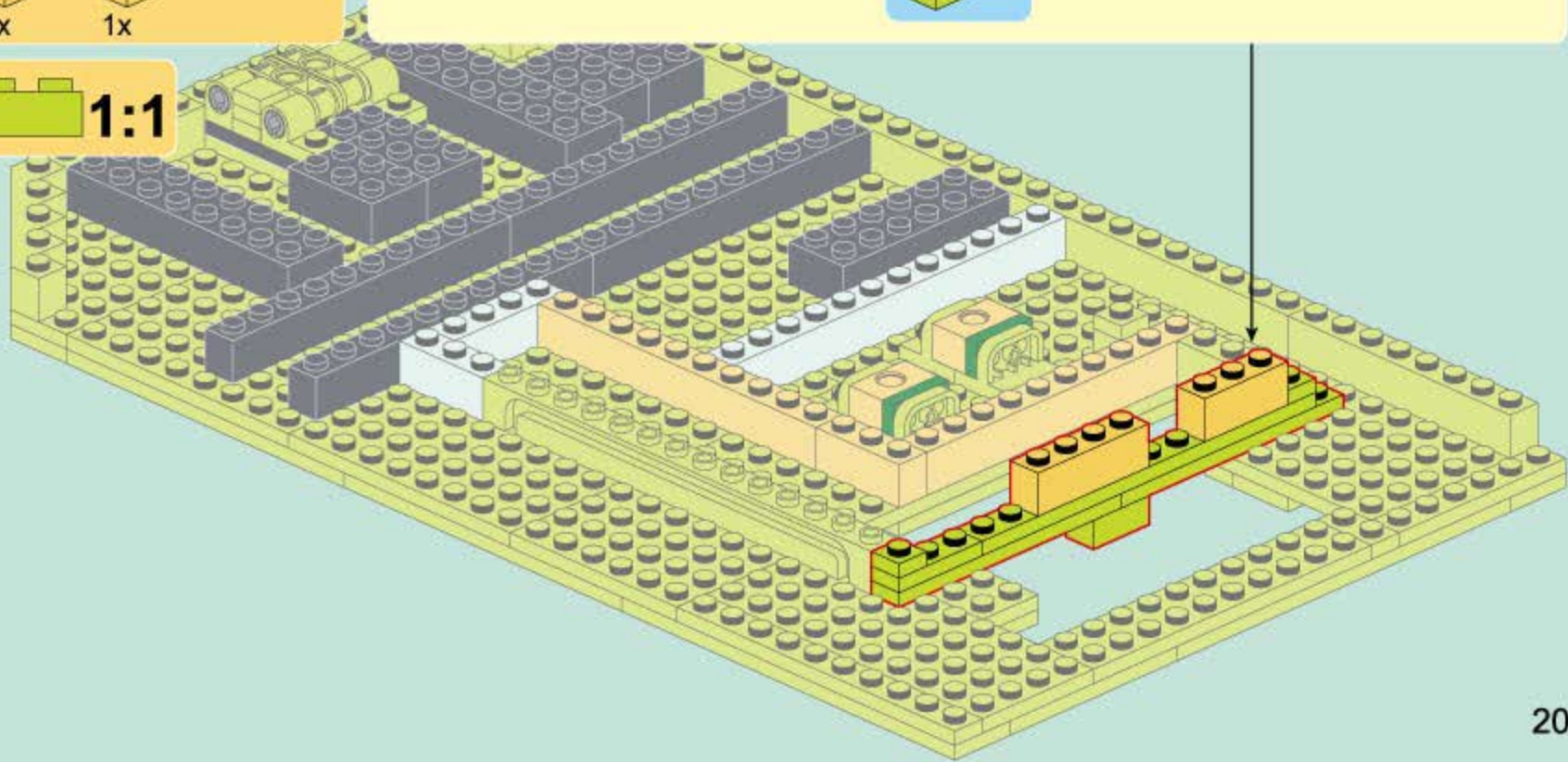
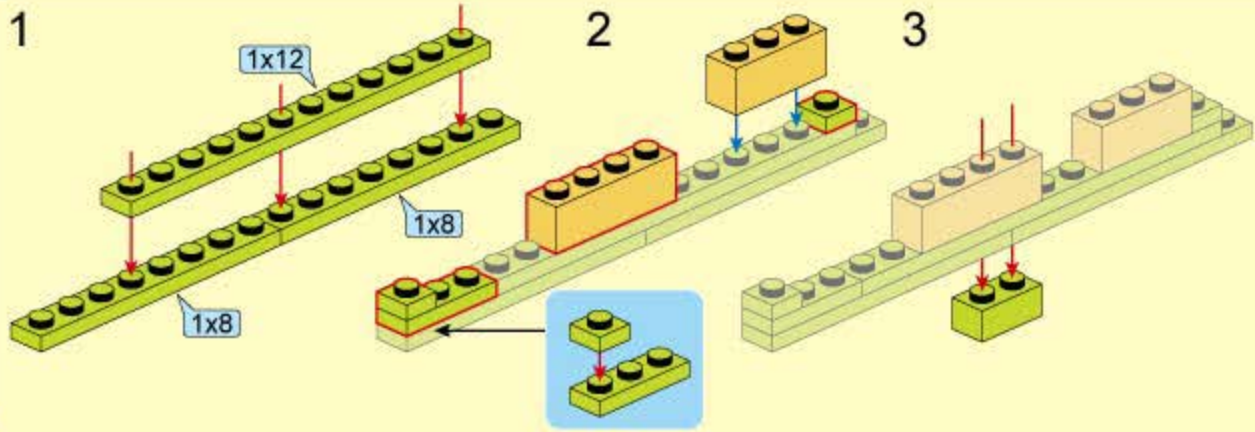
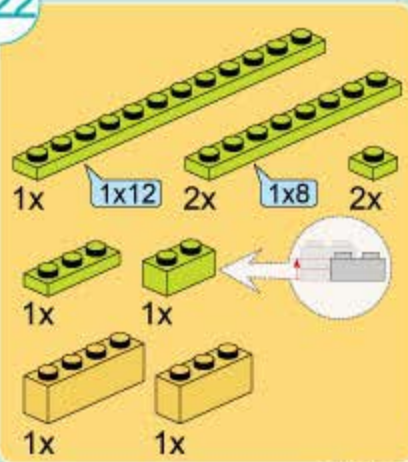

B23

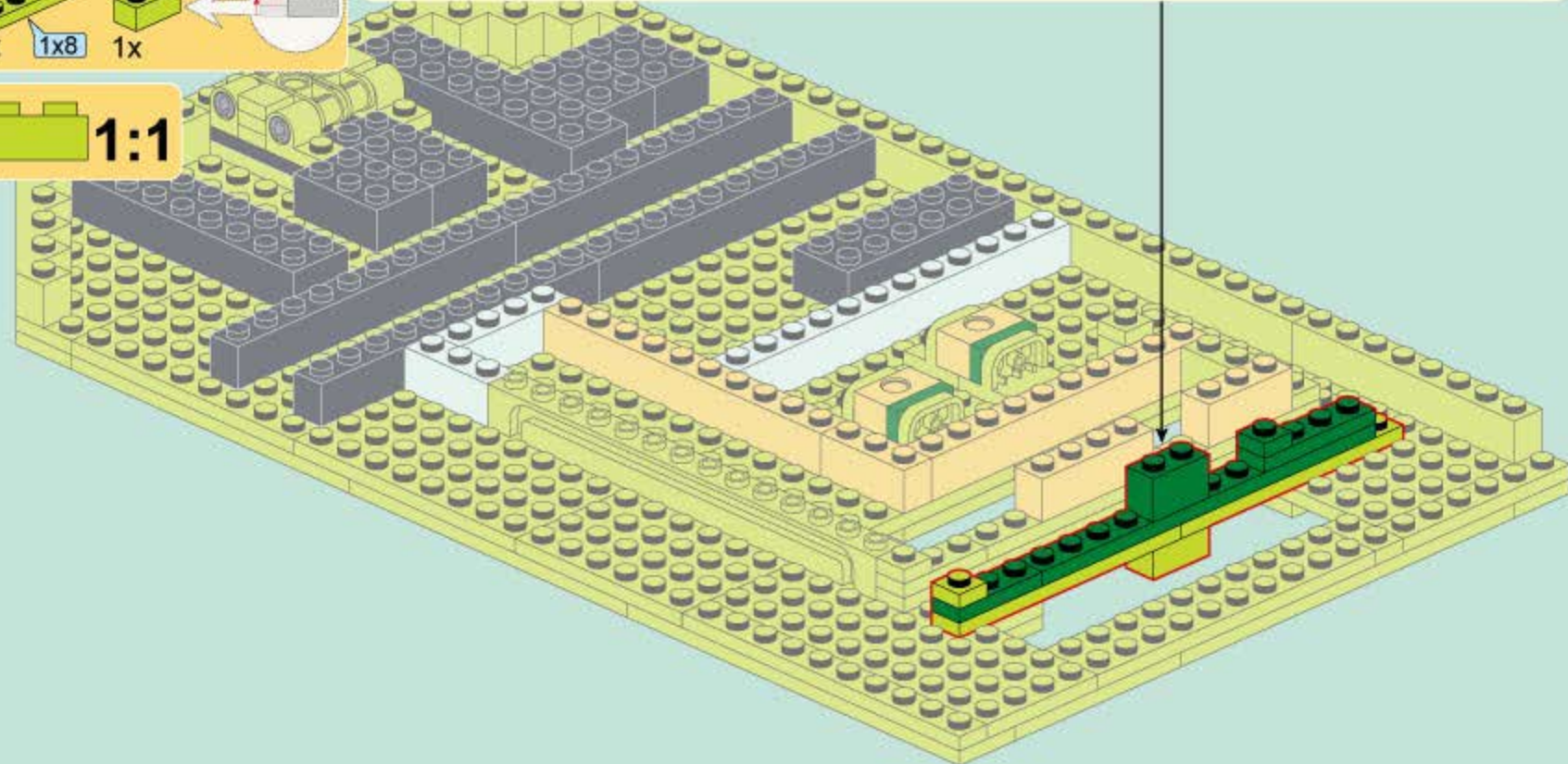
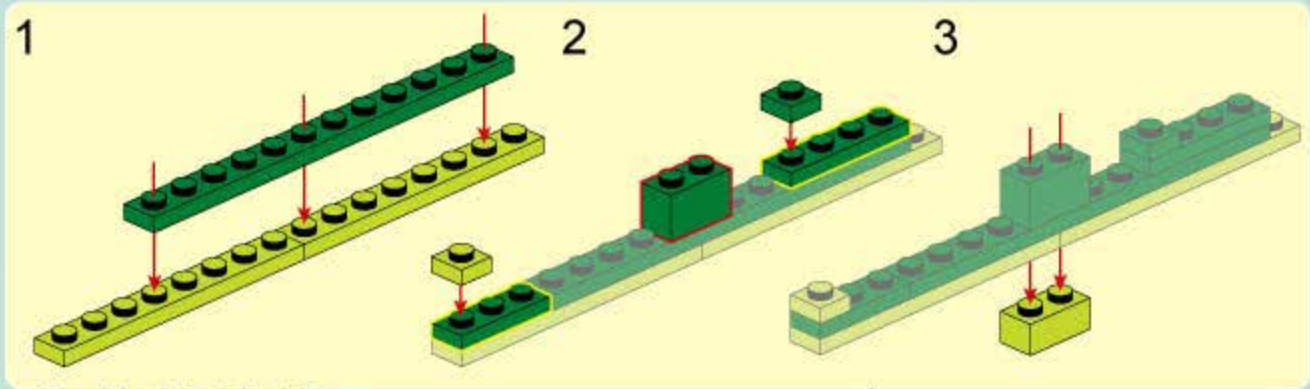
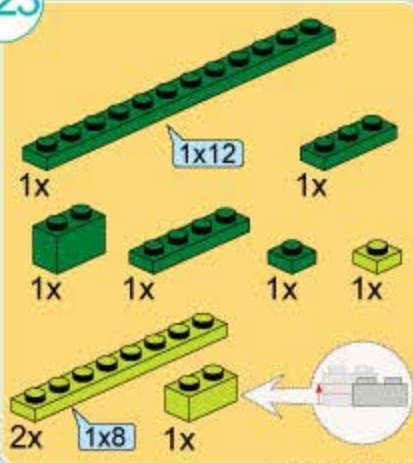

B24

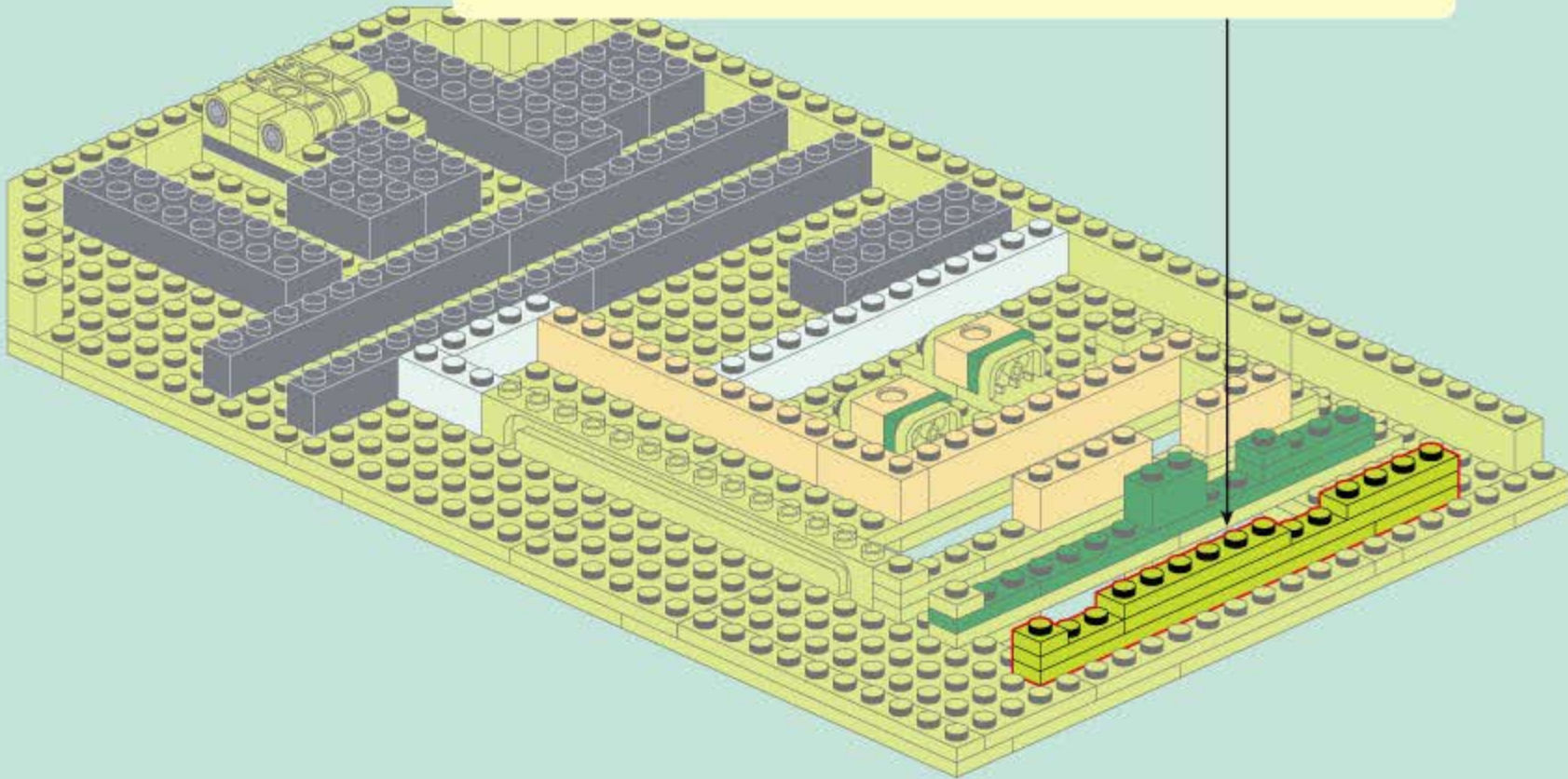
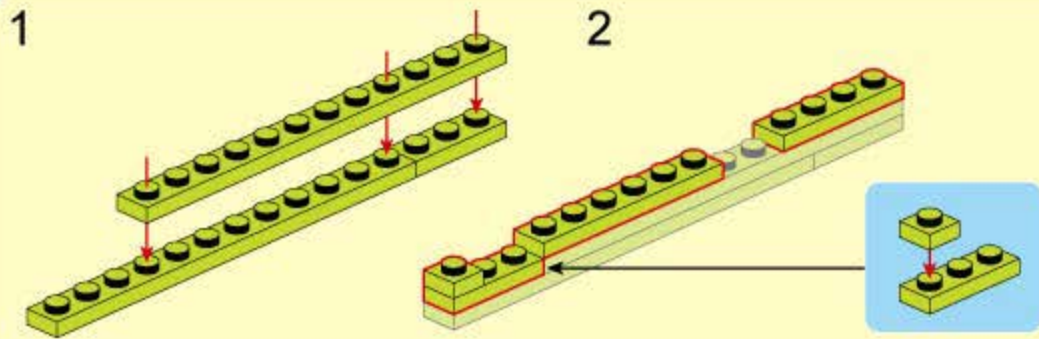
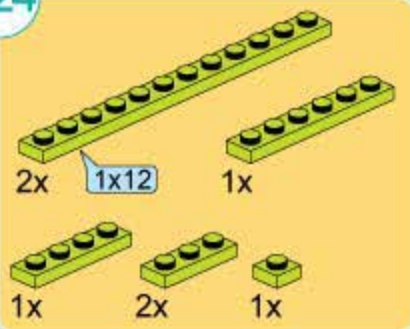

B25

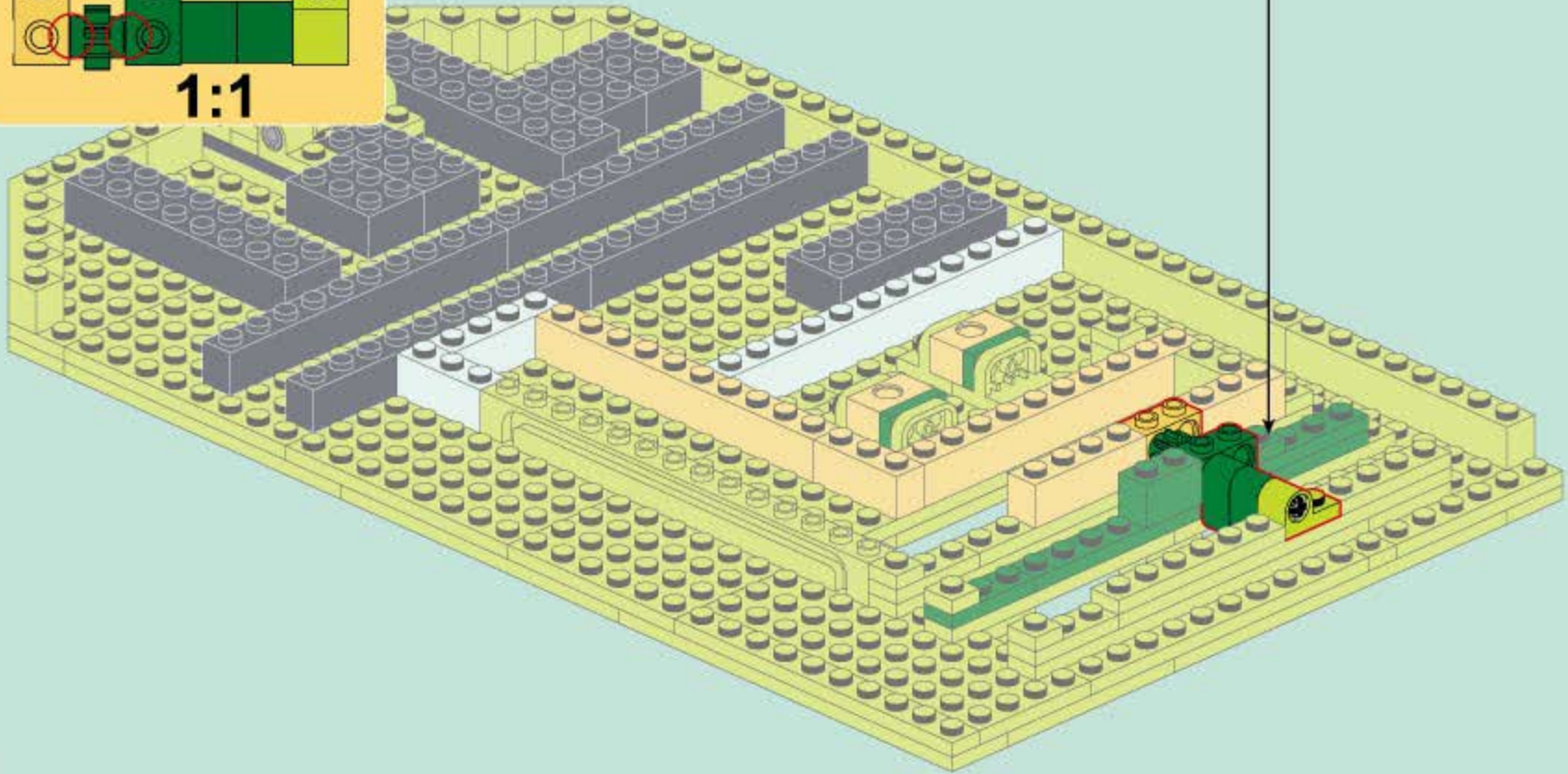
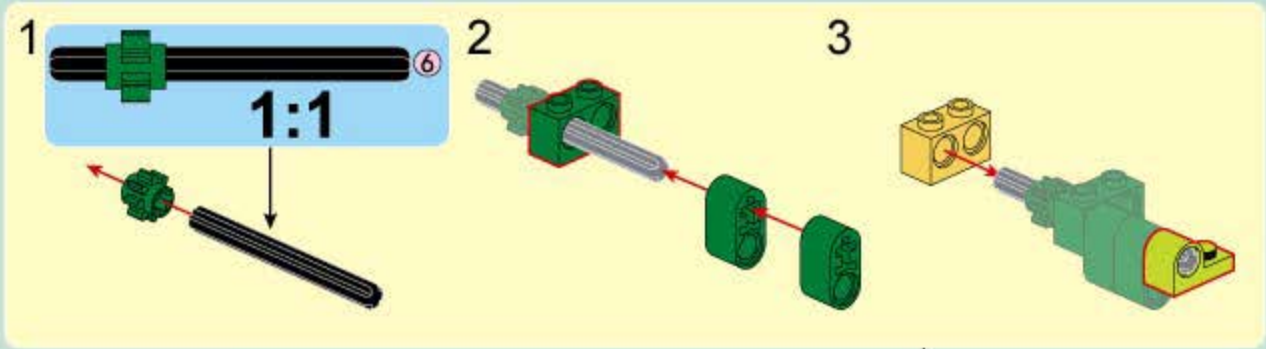
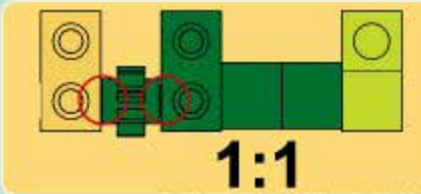
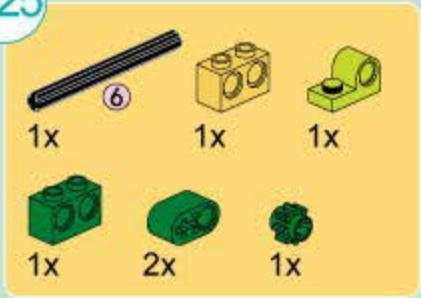

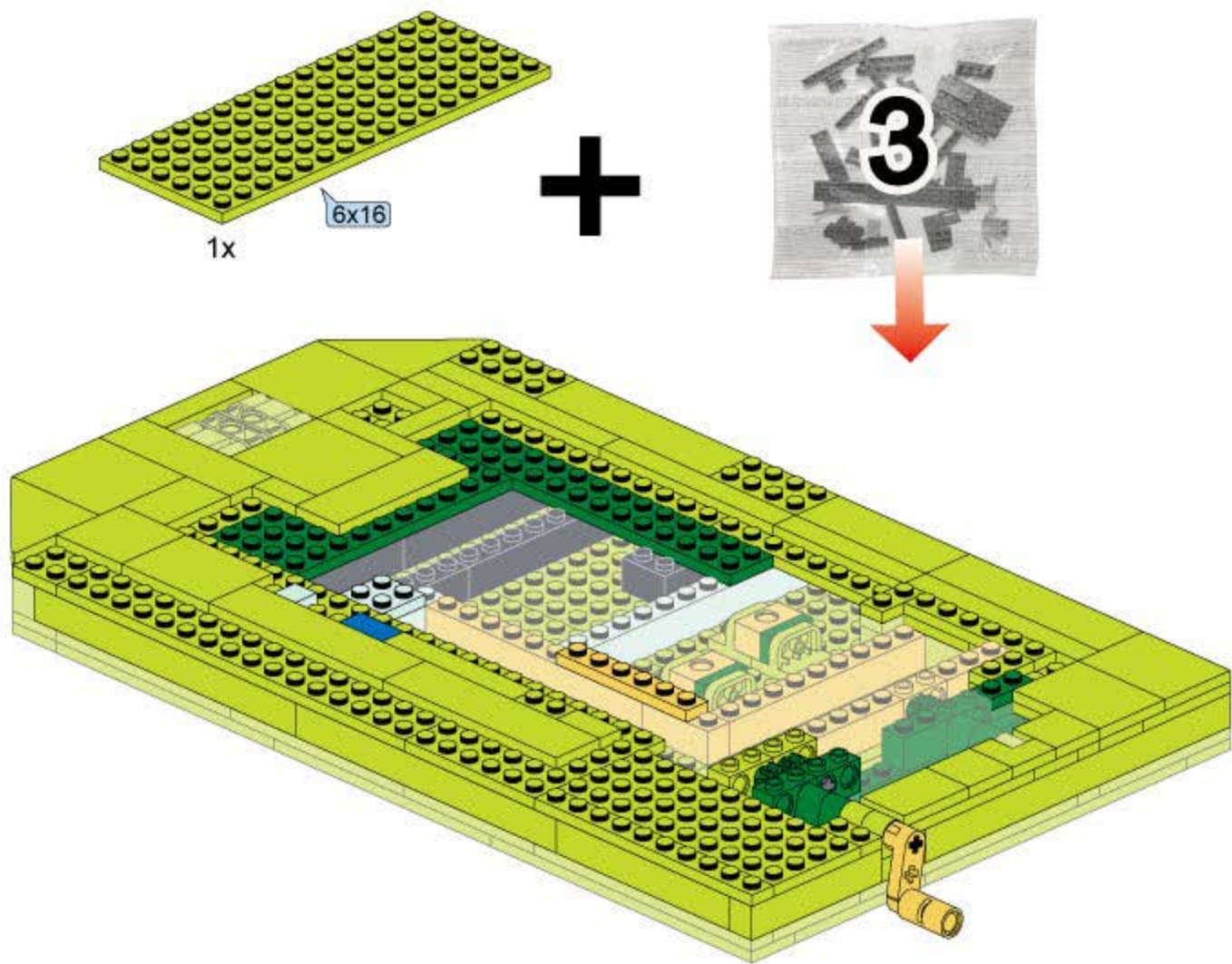

B26

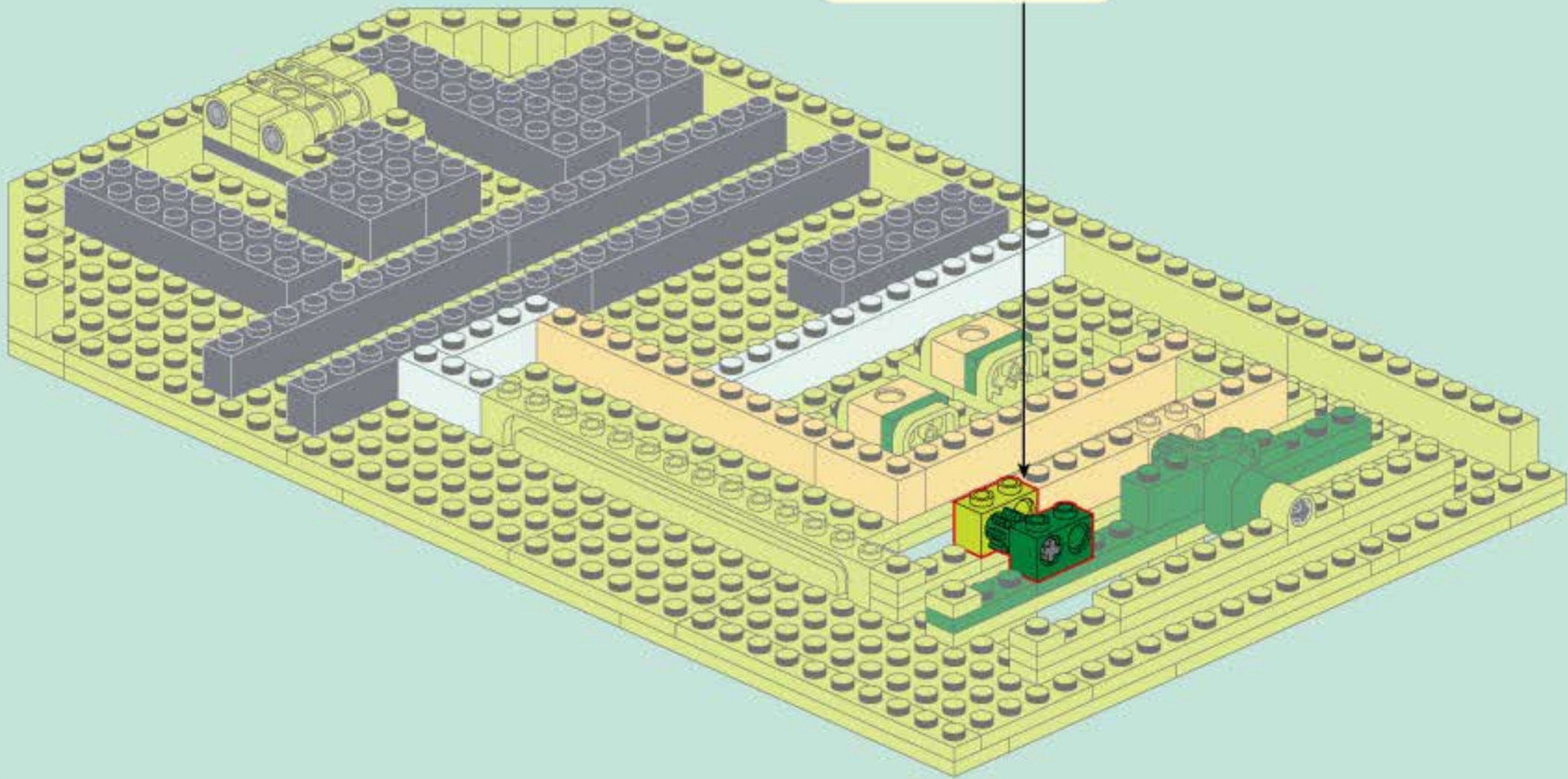
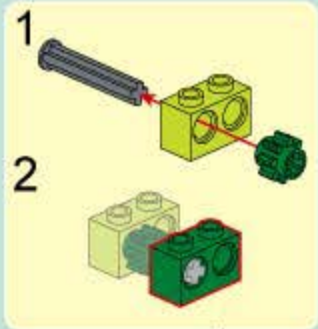



B28

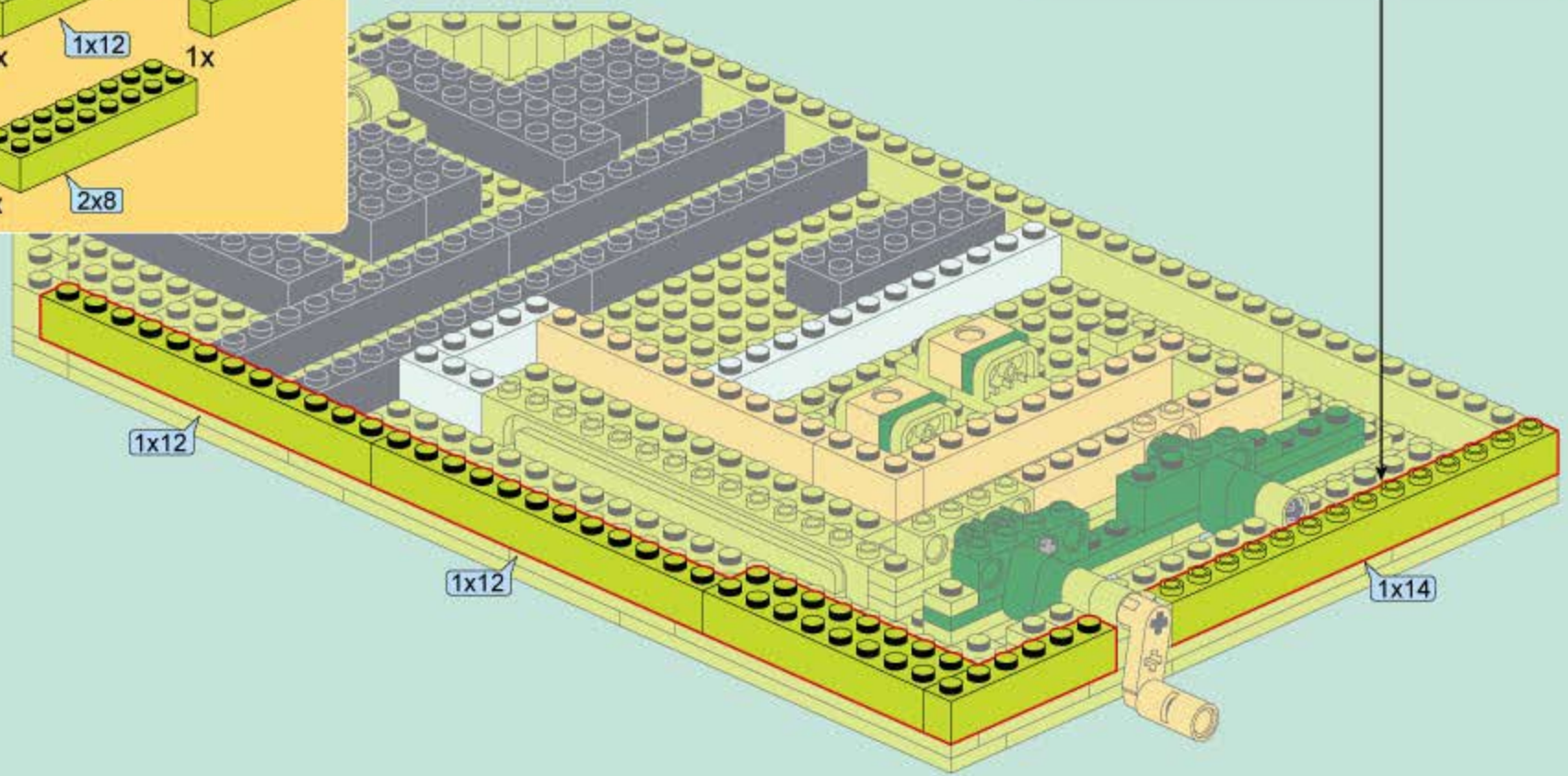
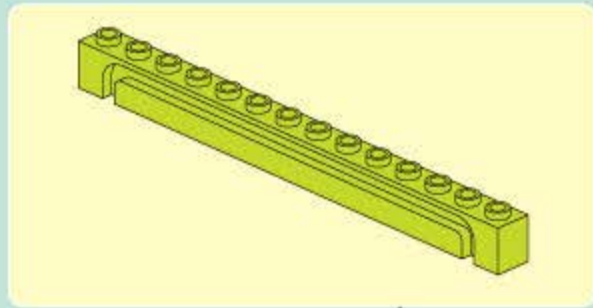
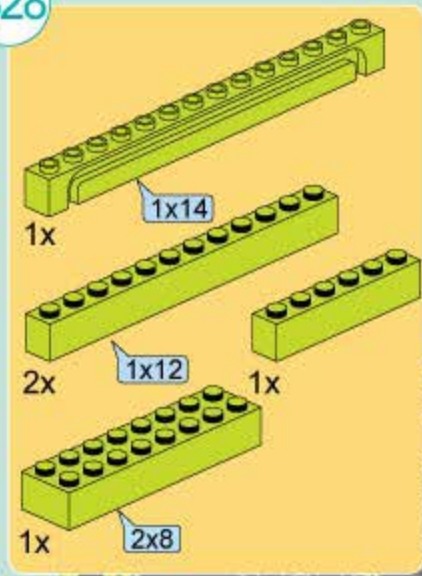

B29

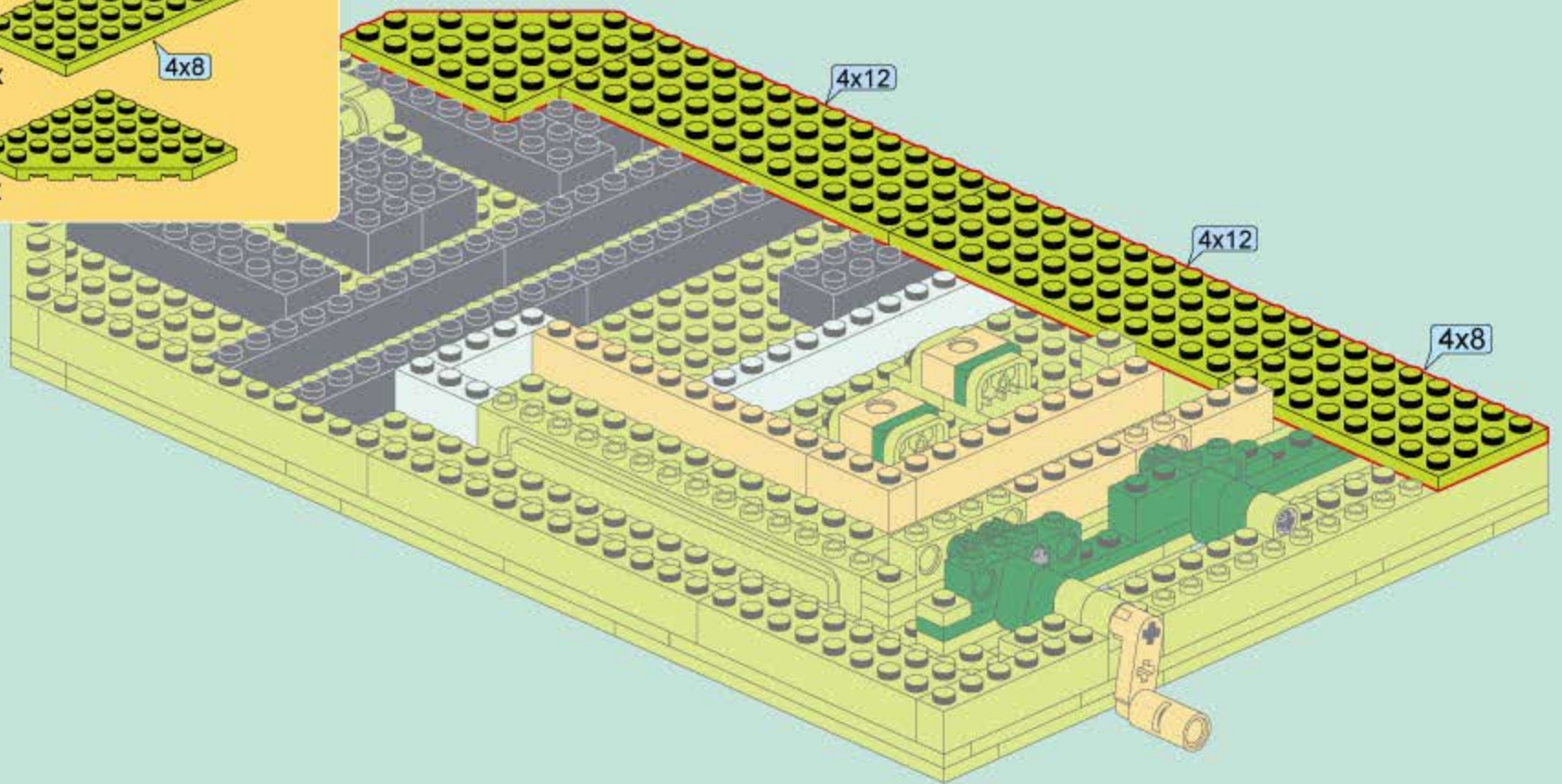
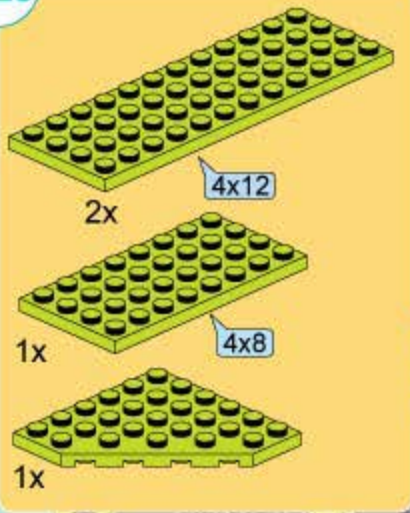

B30

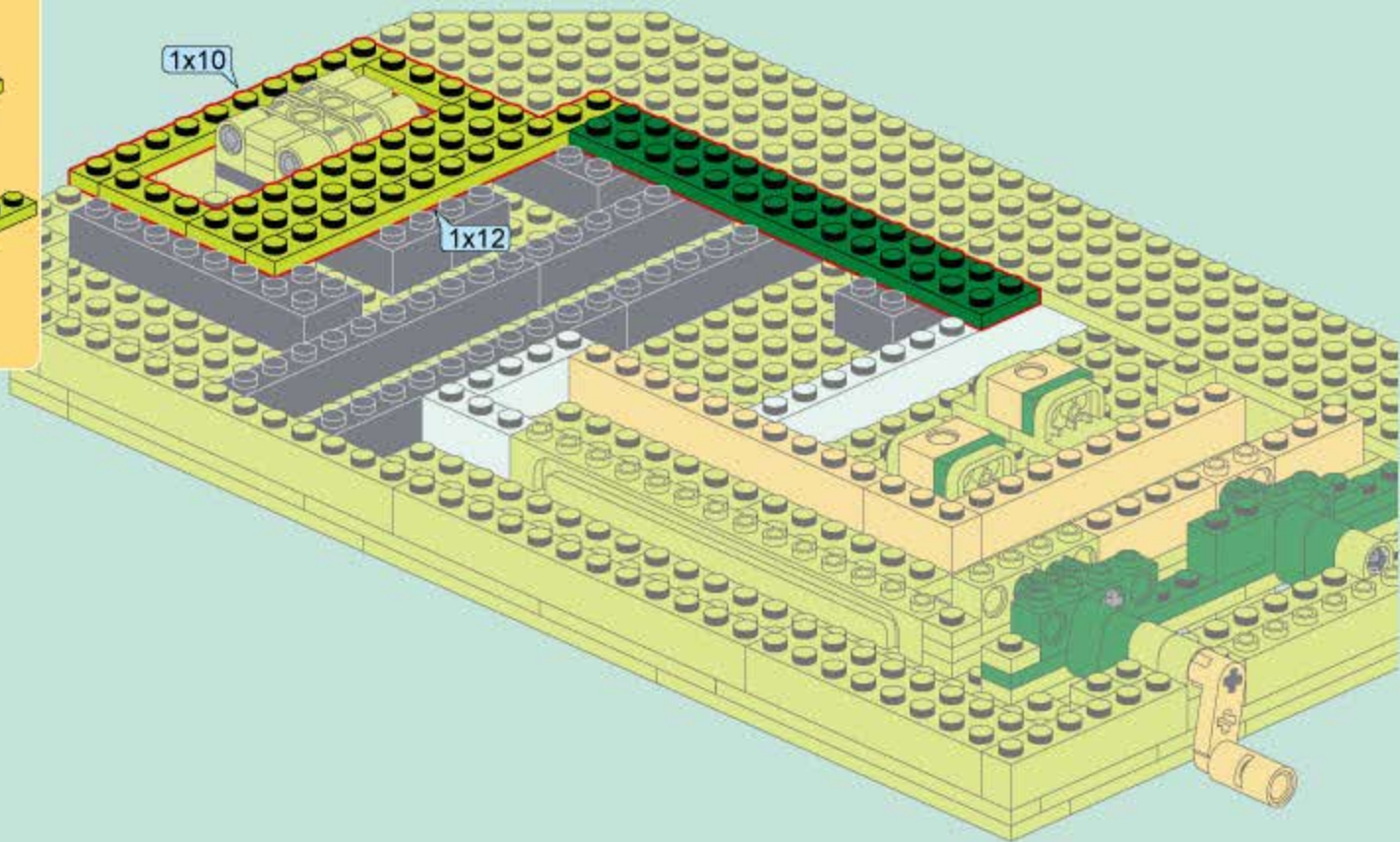
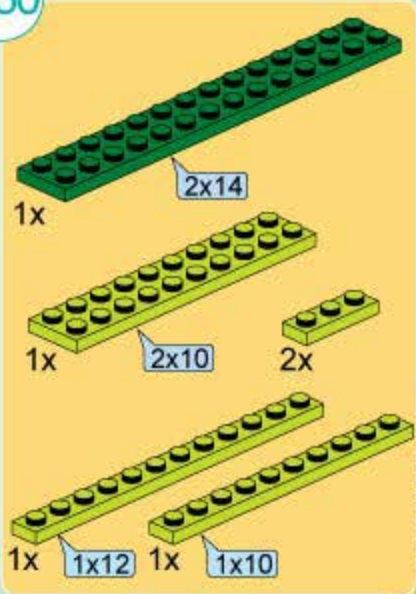



B32

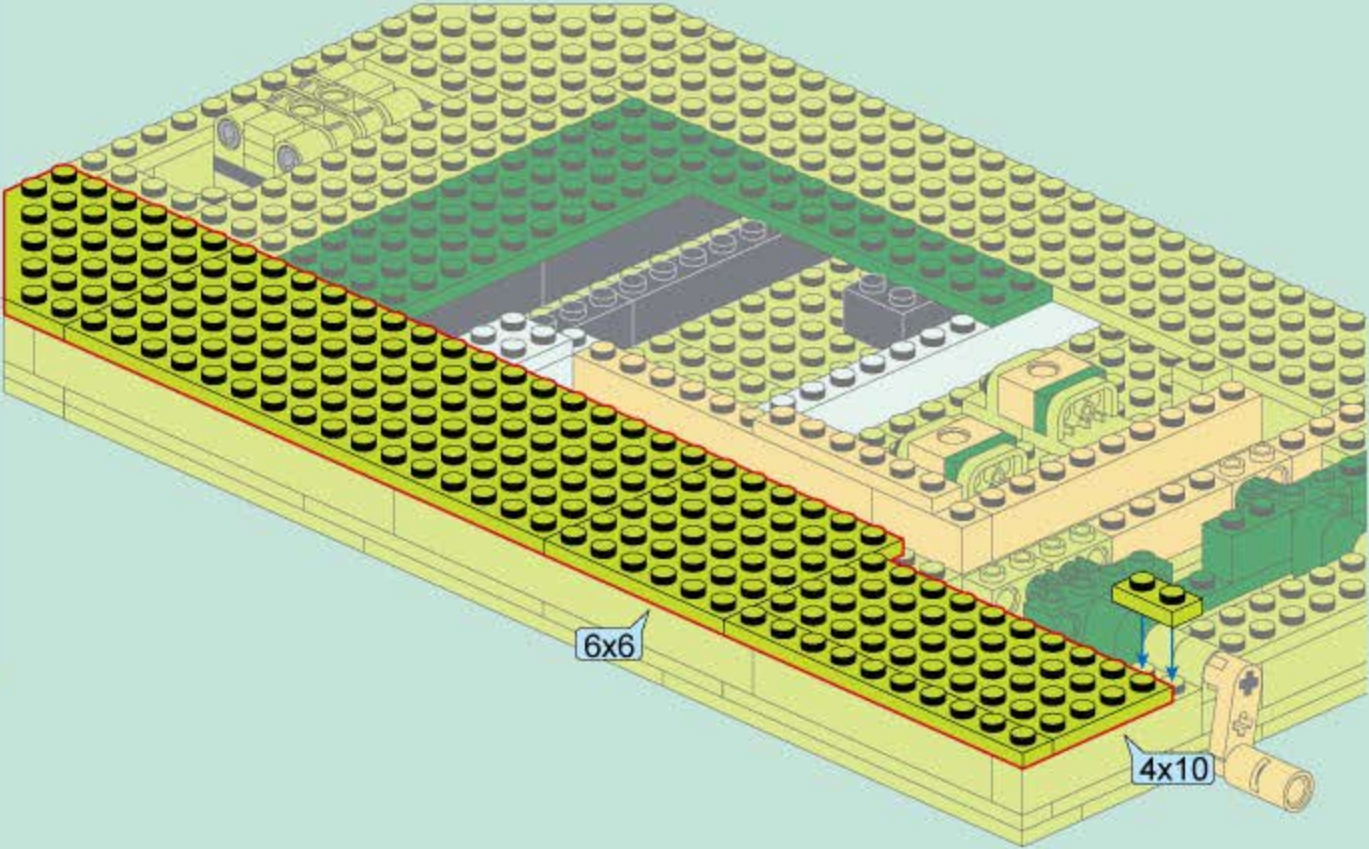
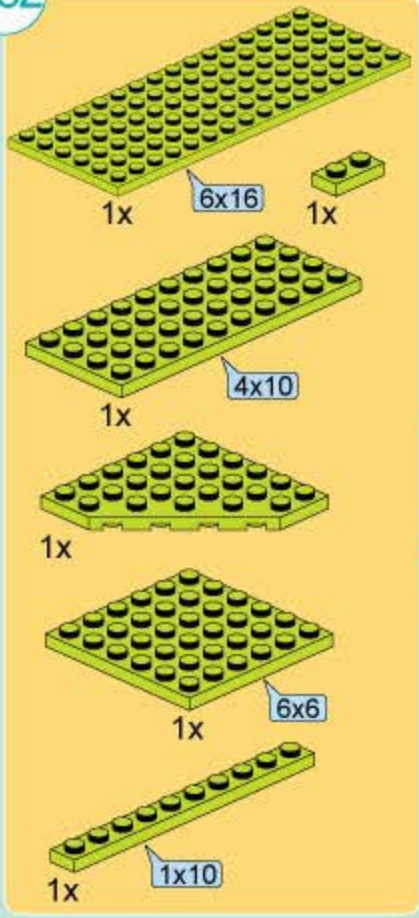

B33

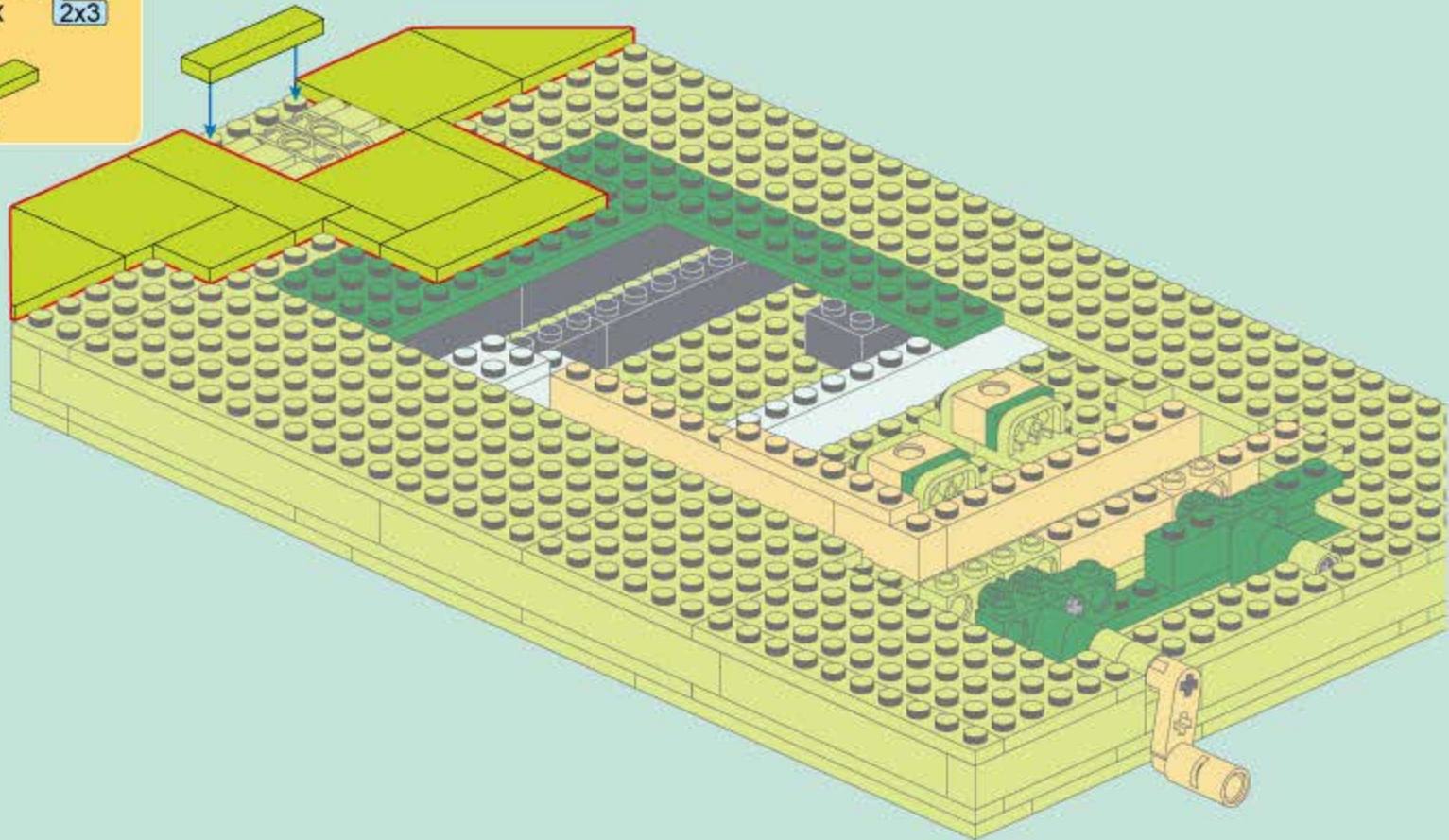
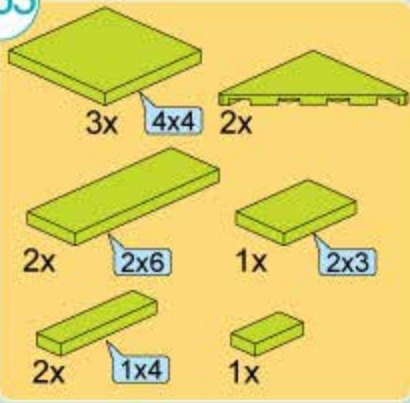

B34

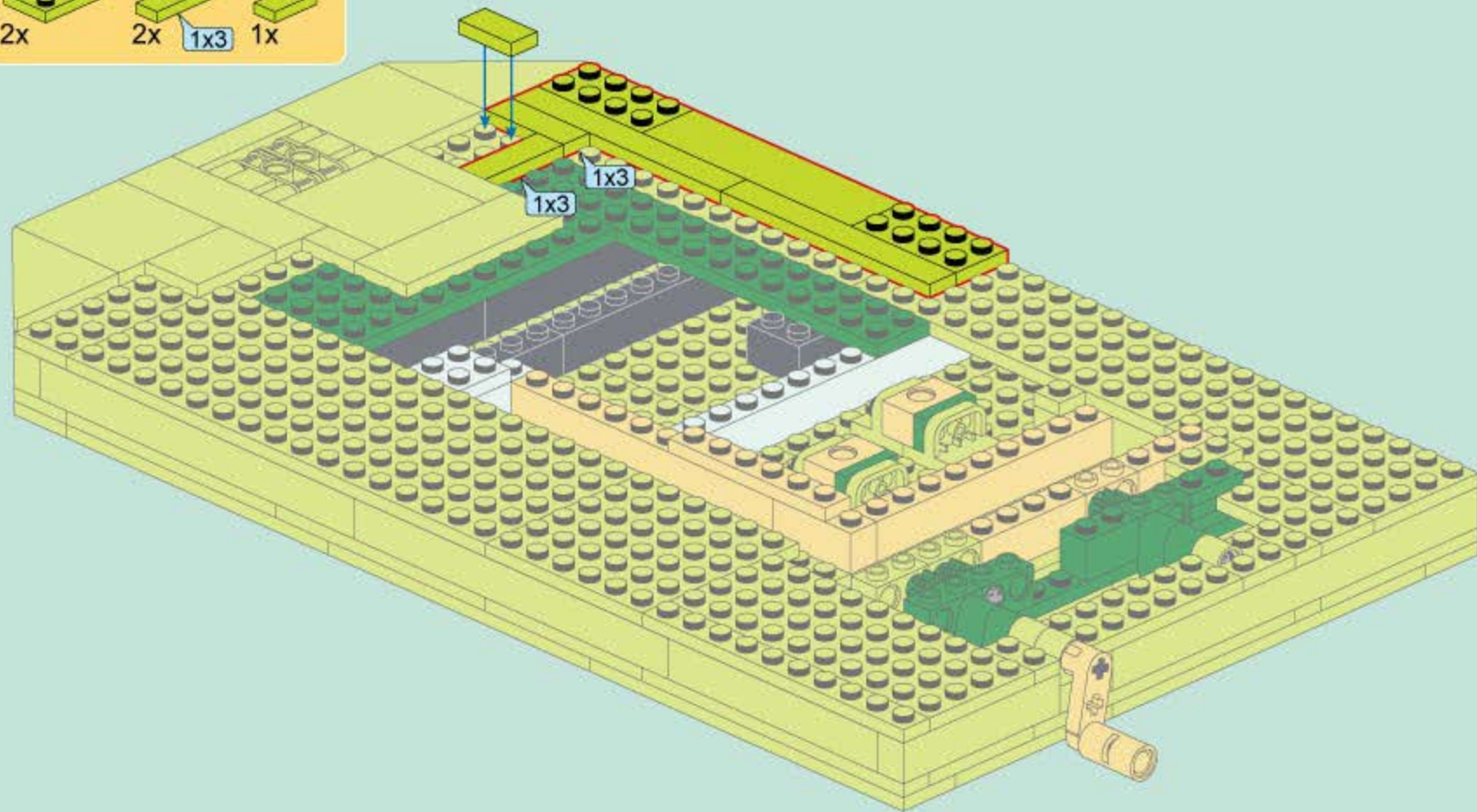
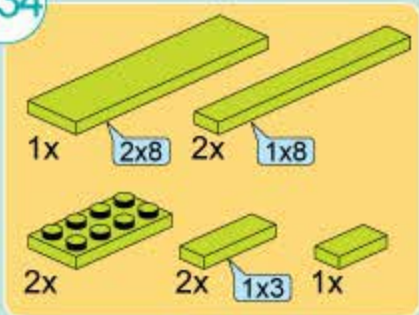

B35

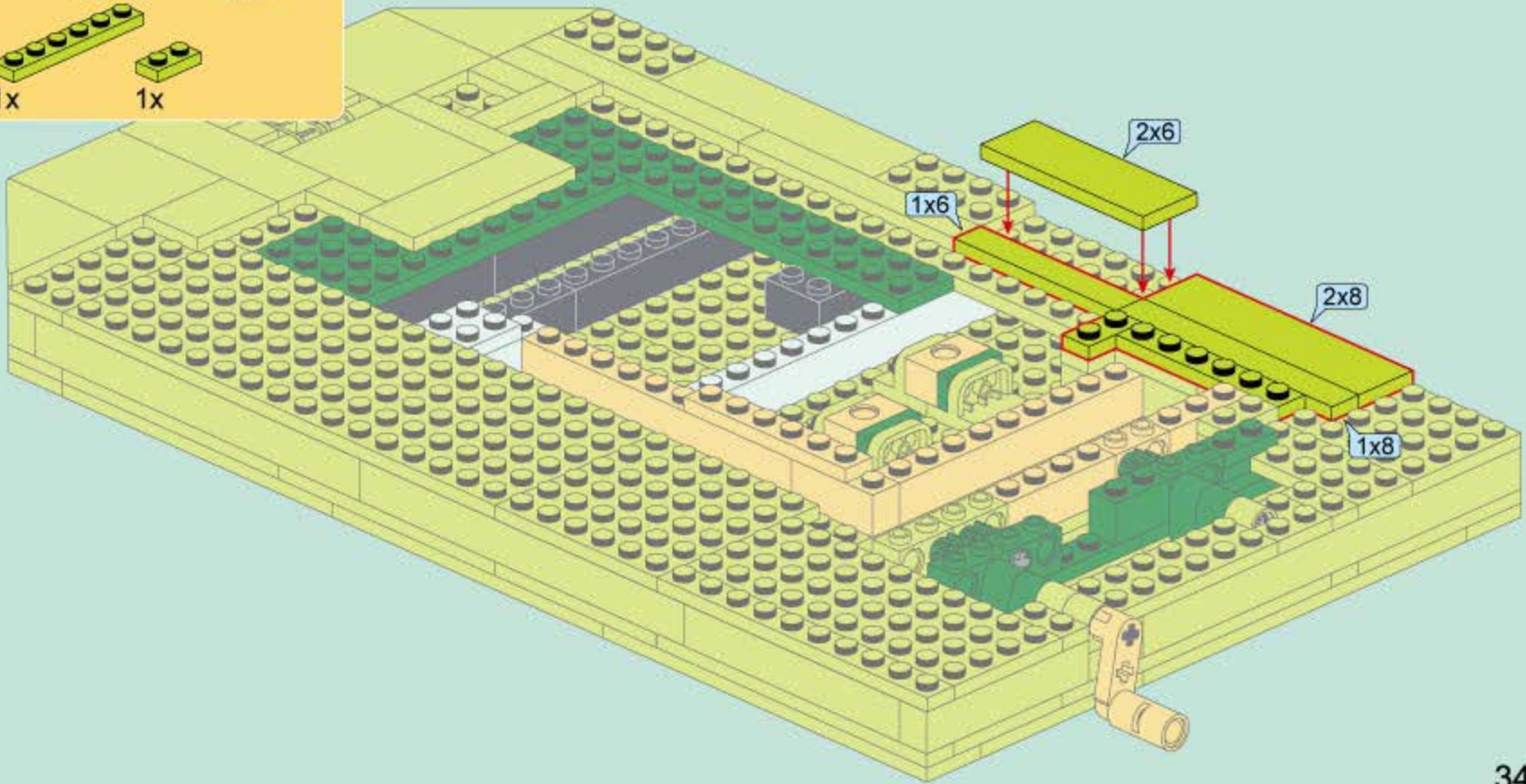
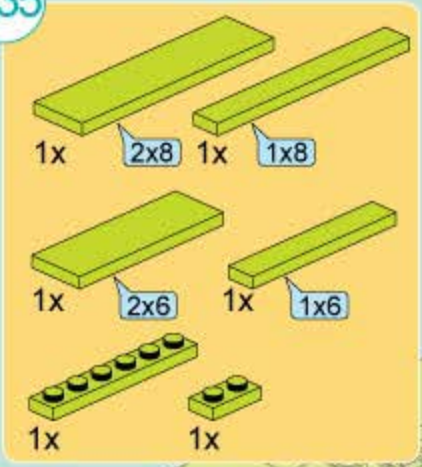

B36

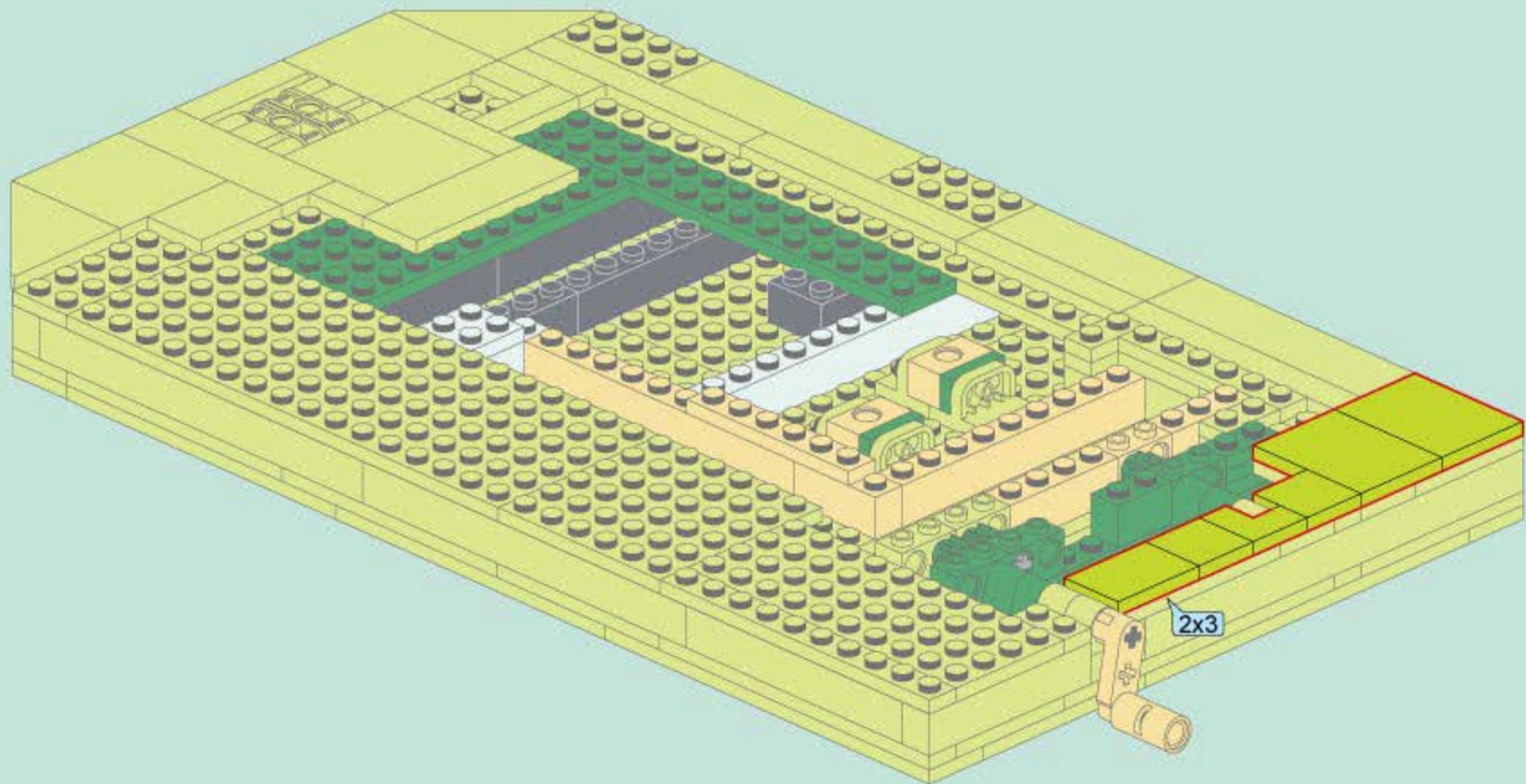
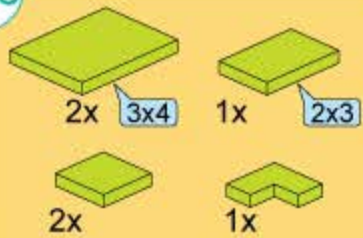

B37

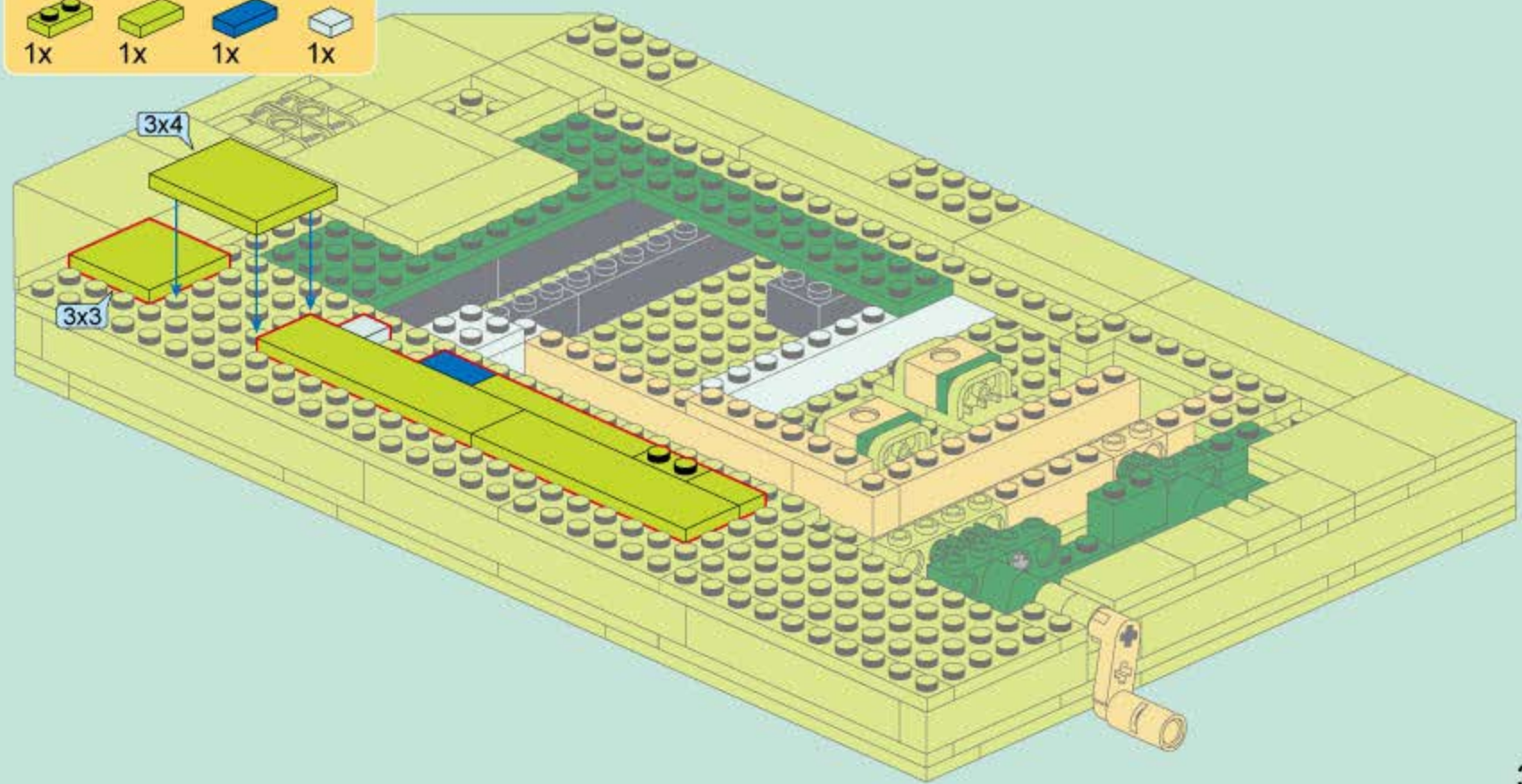
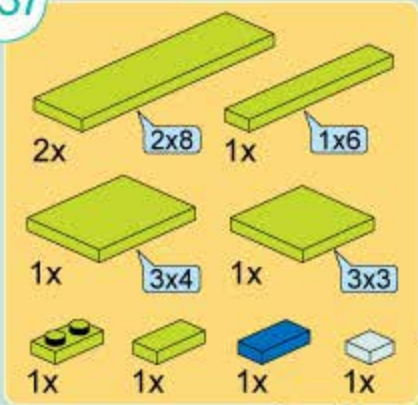



1x

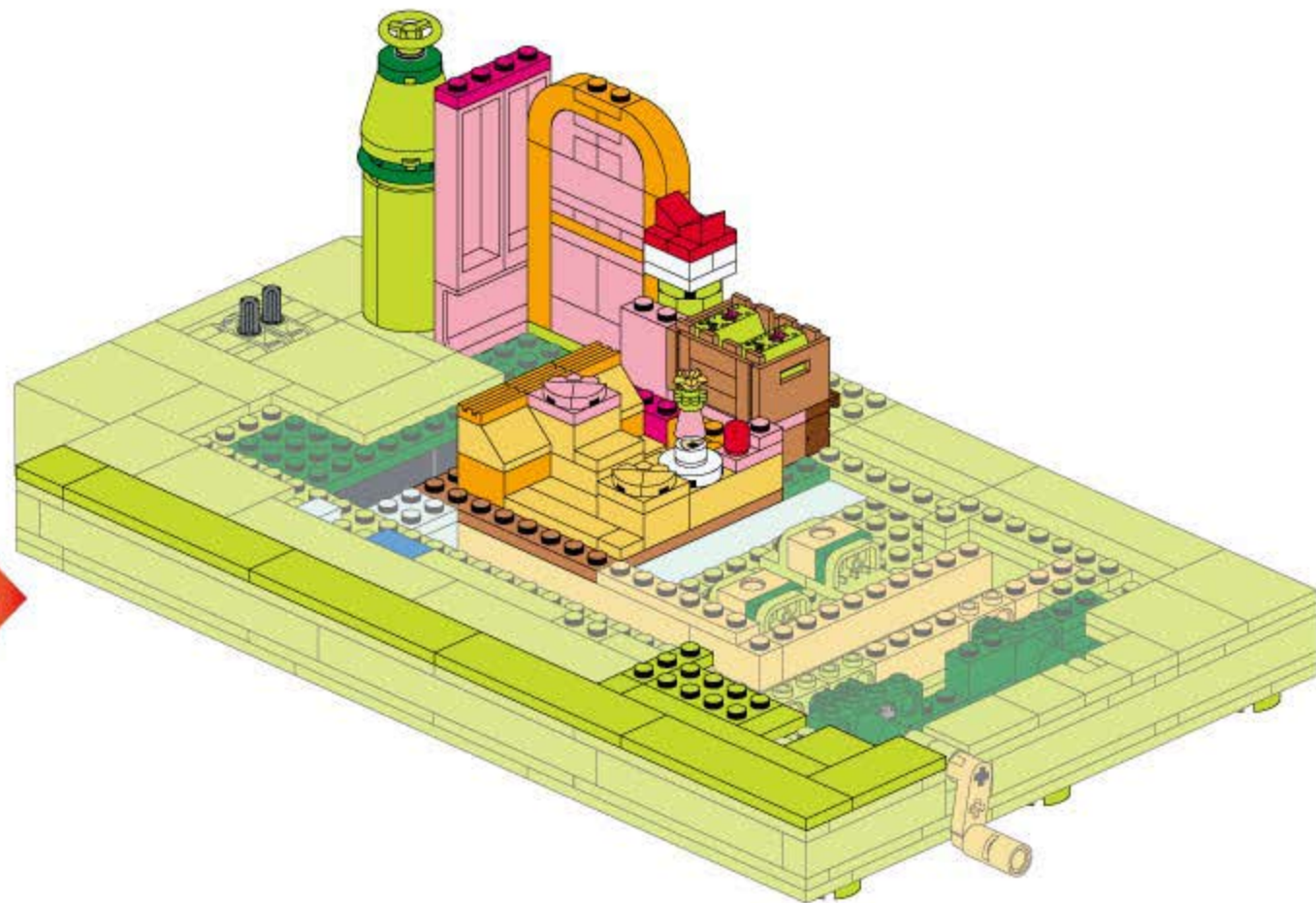

B38

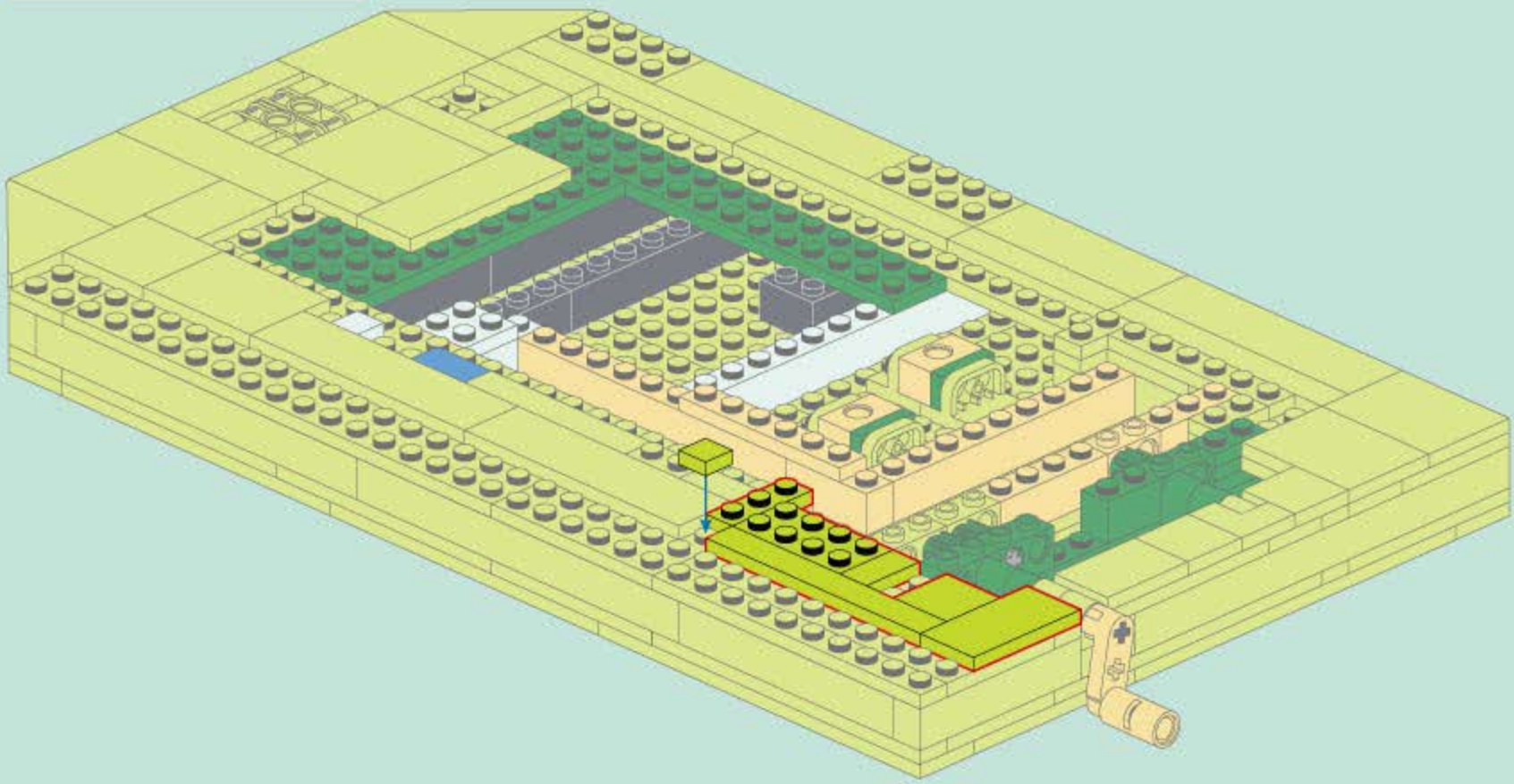
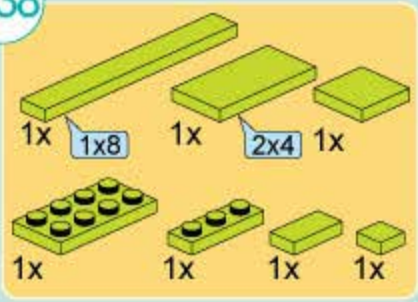

B39

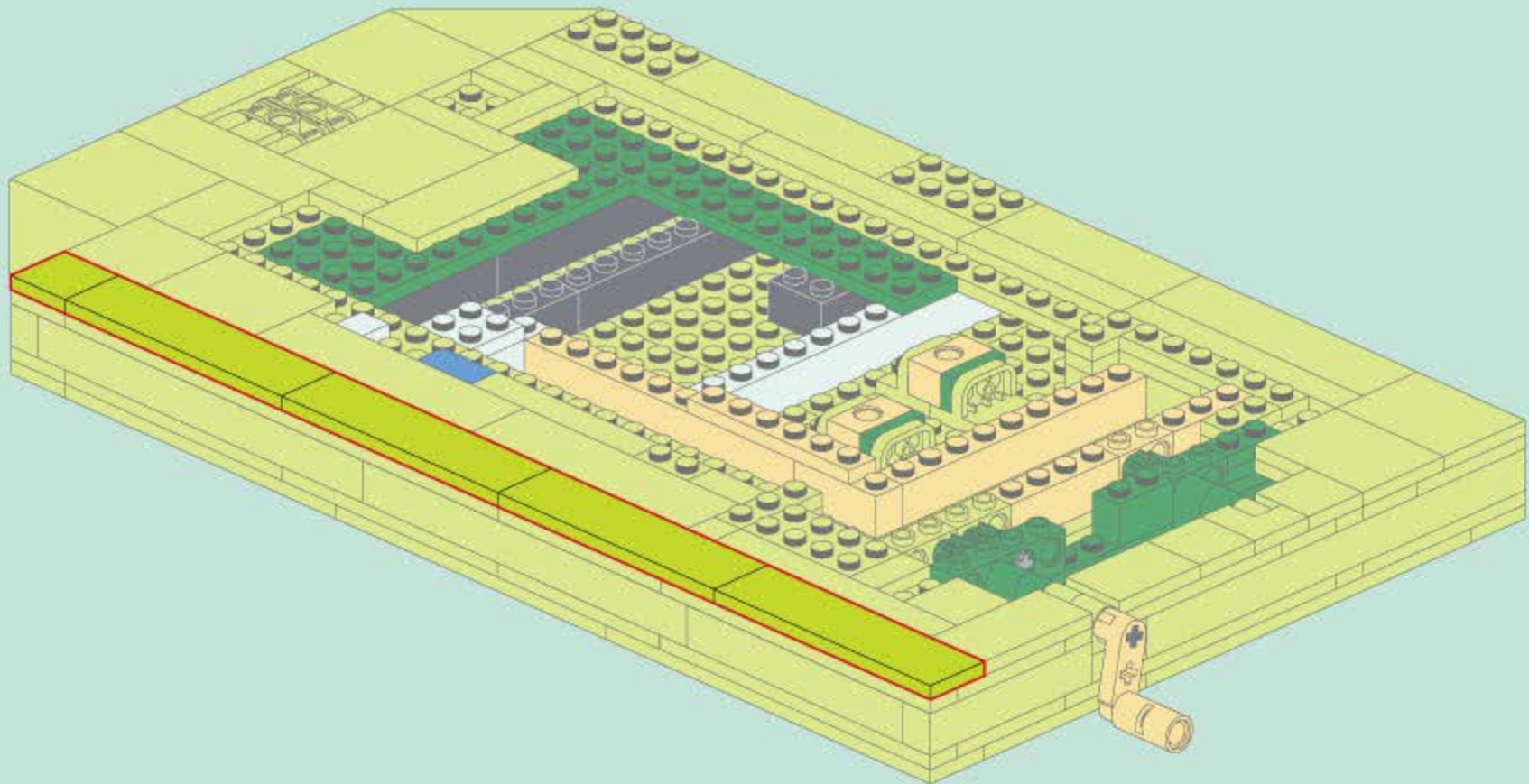
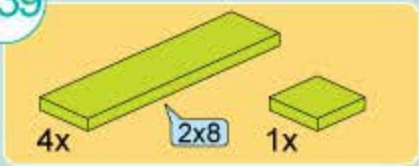

B40



1x



17x



1:1



底视图:

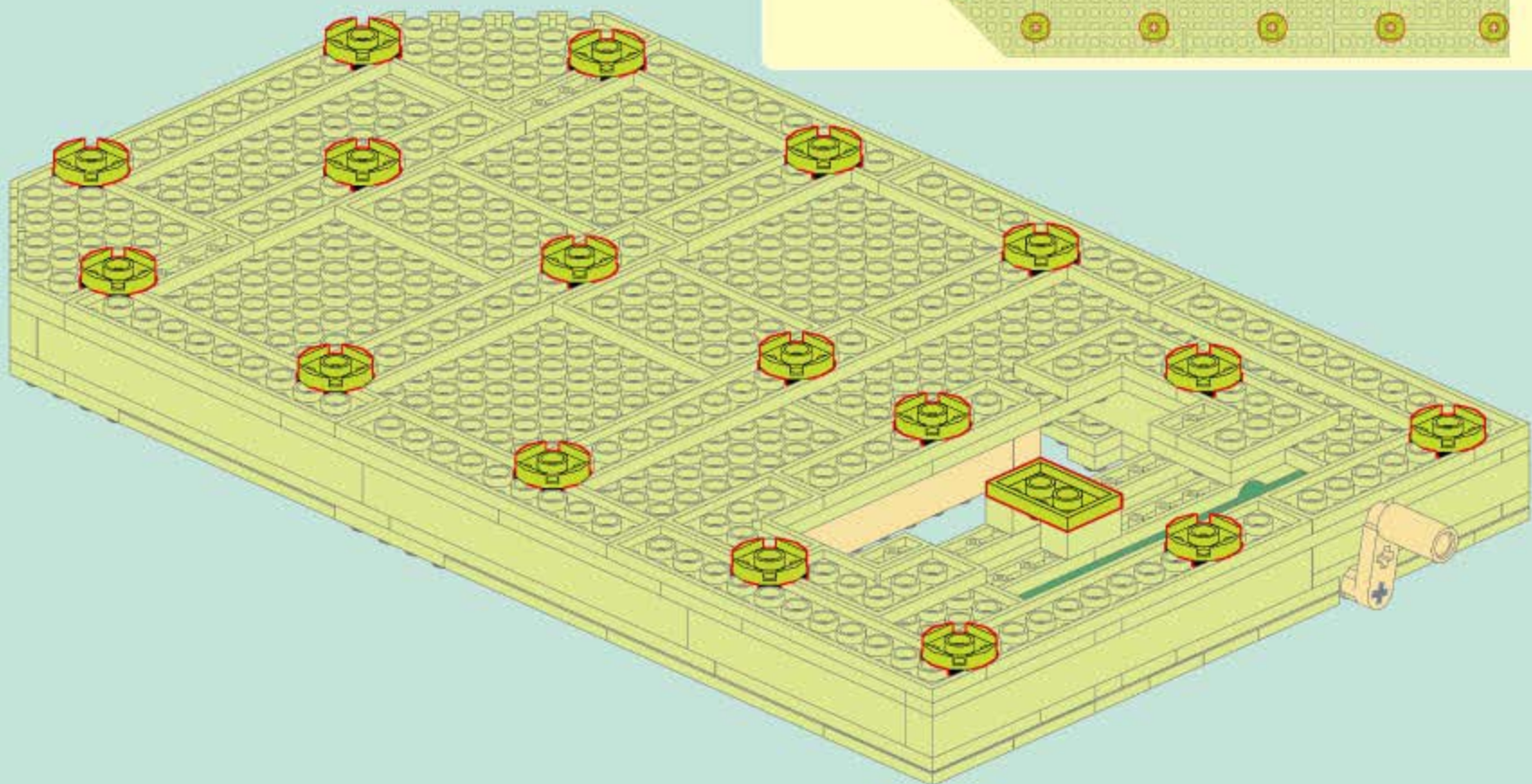
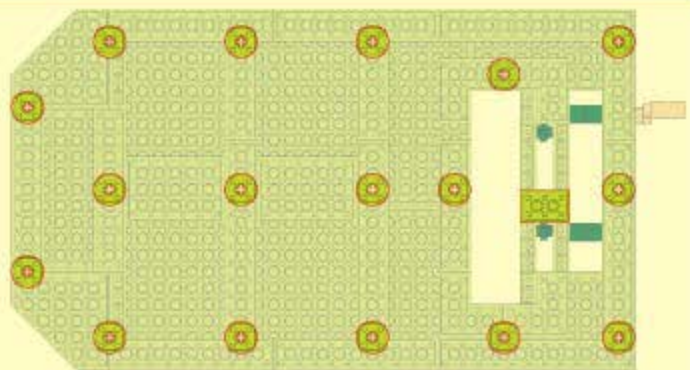



B41



1x

1x



B42



1x

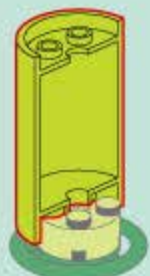

B43

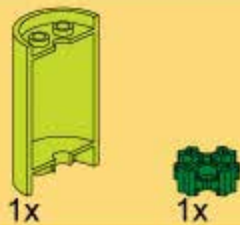

1x

1x



B44



4x

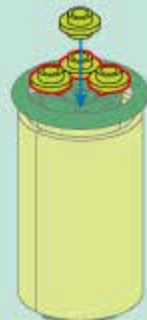

B45



1x

1x

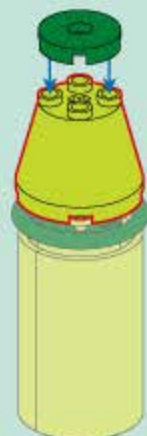

B46



1x

1x



B47



2x

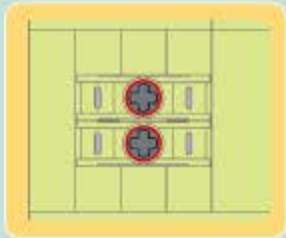

B46



B40

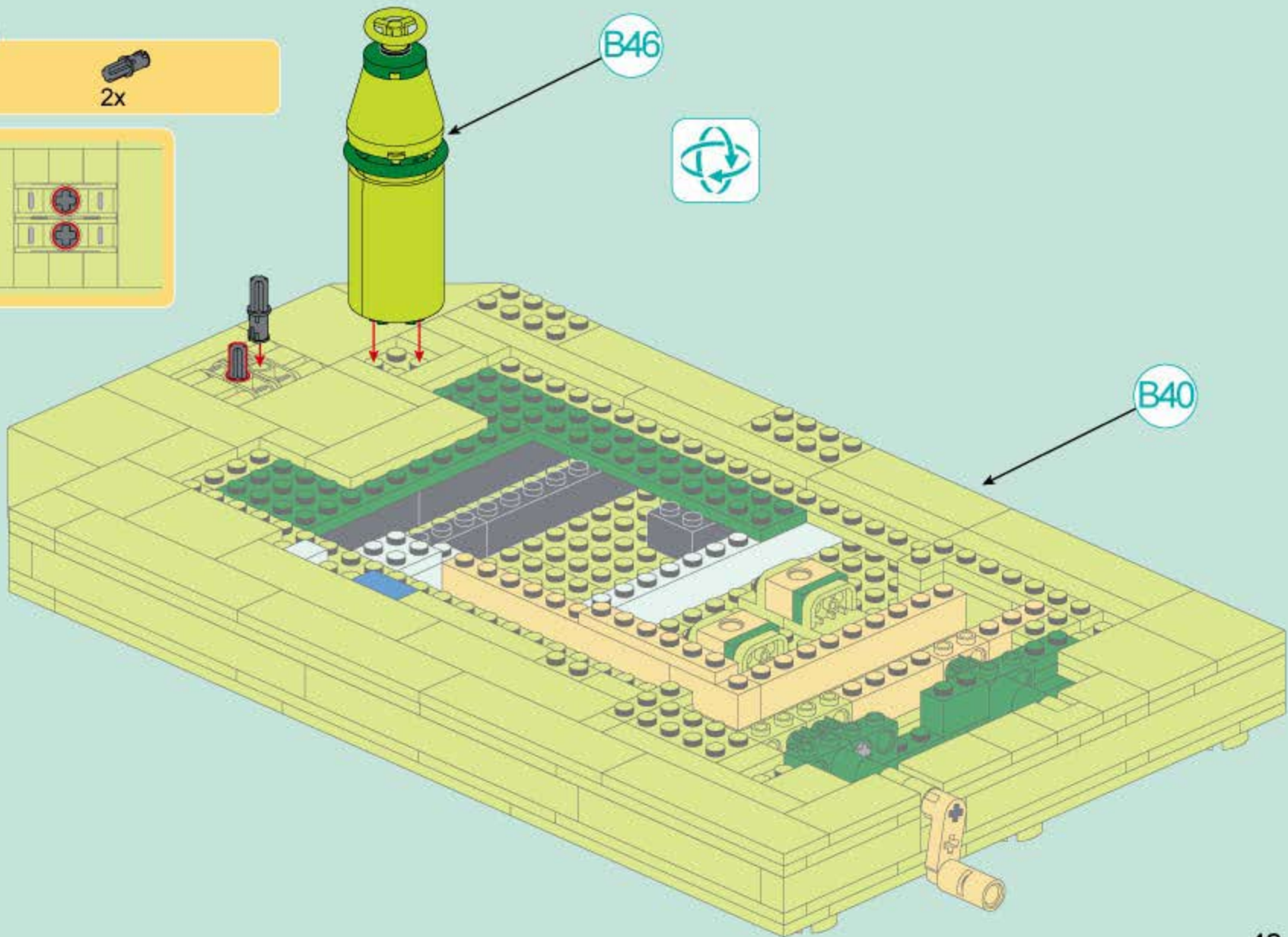

B48

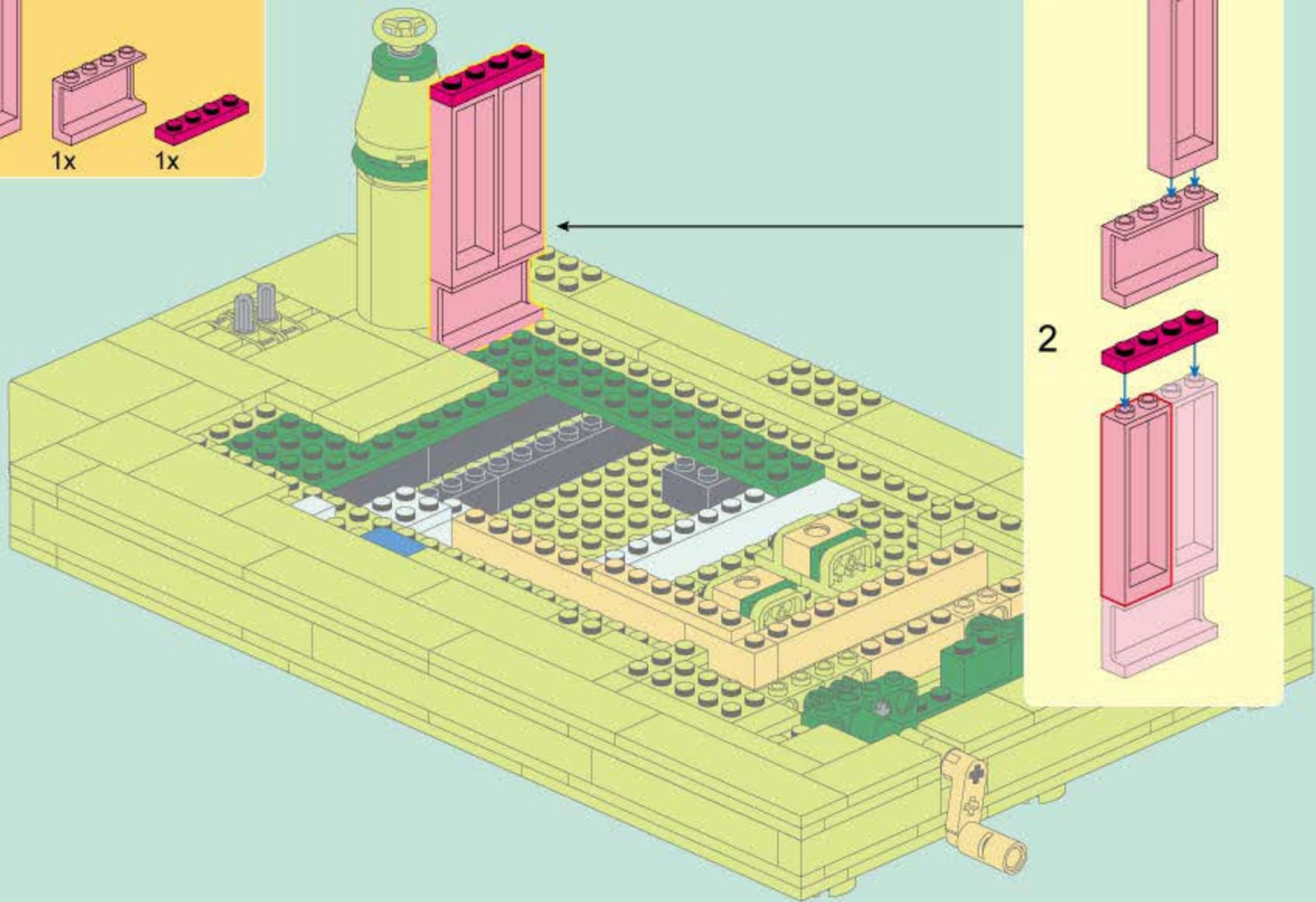
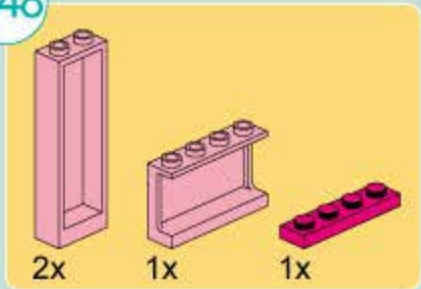



B49

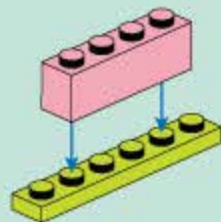
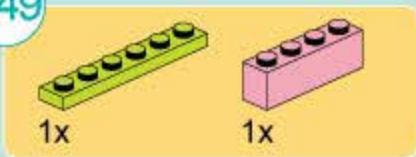

B50

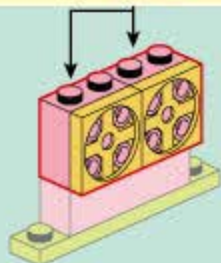
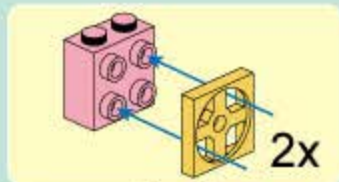
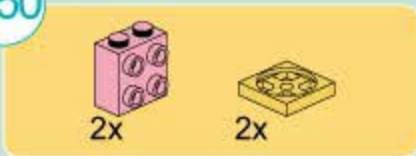

B51

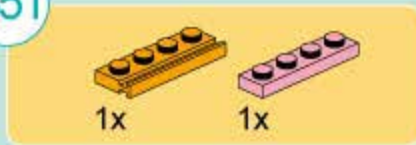

B52

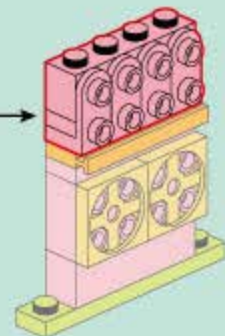
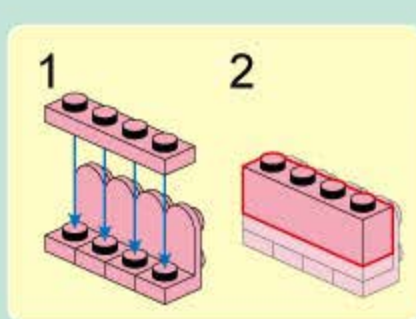
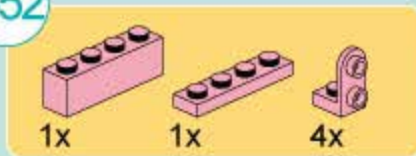

B53

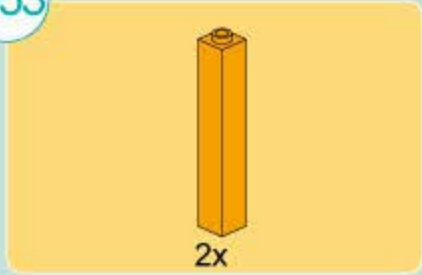

B55

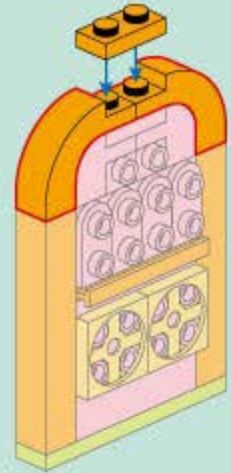
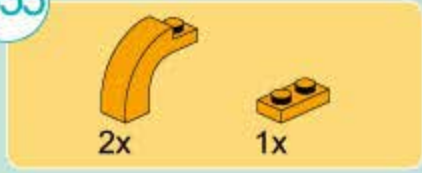

B54

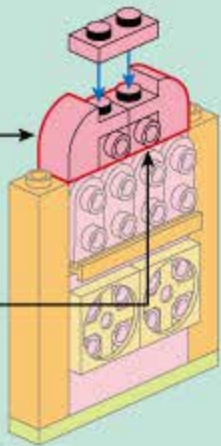
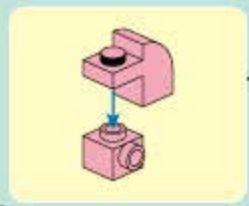
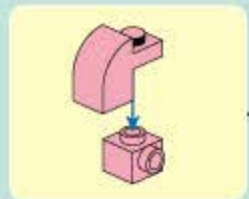

B56

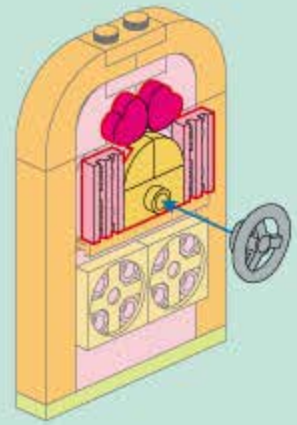

B57

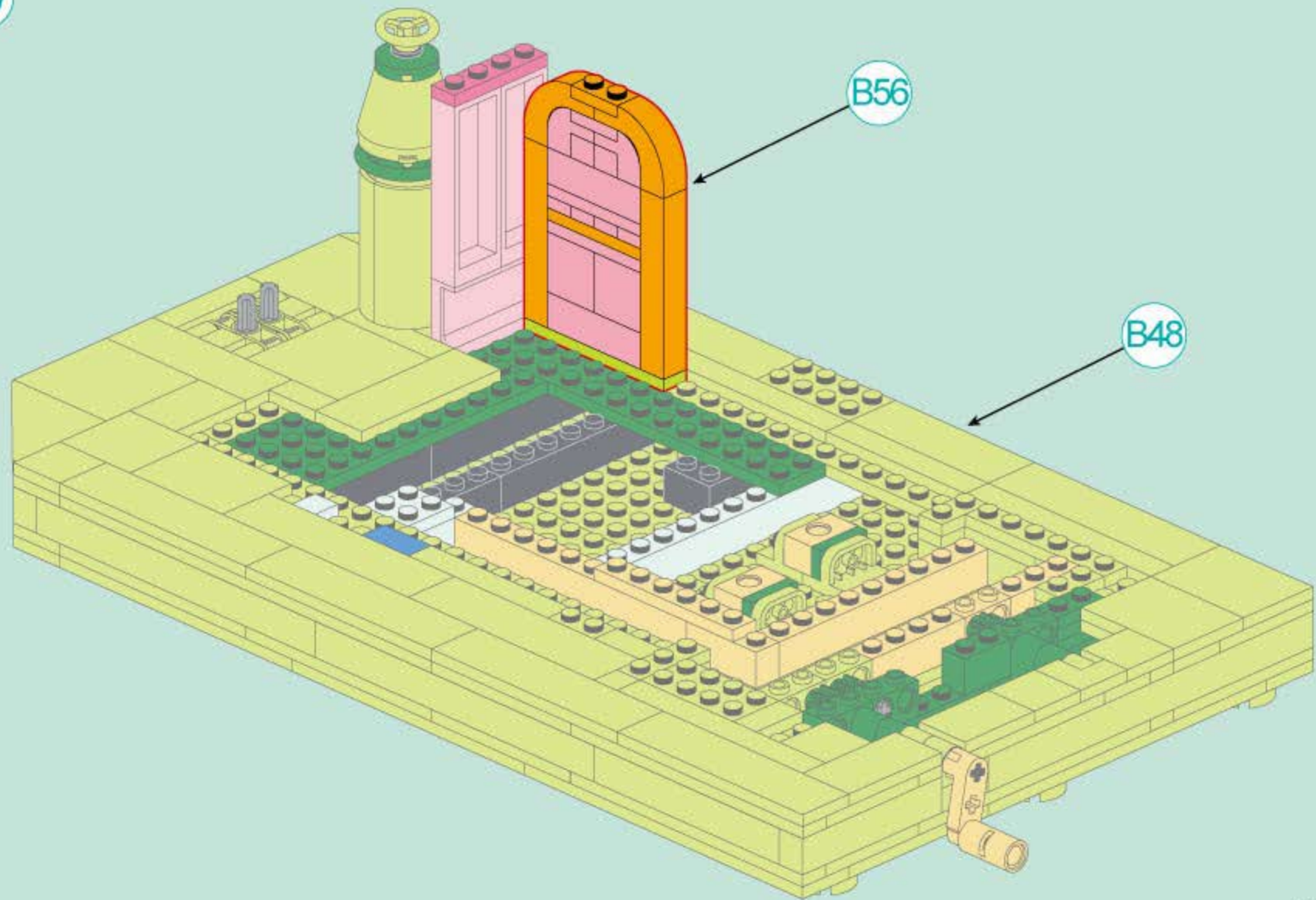

B58

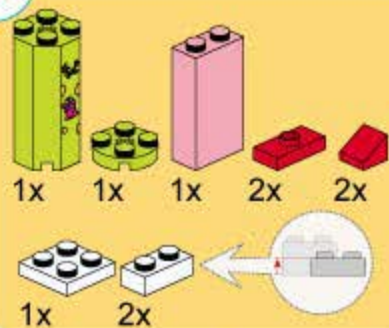

1:1

The 1:1 ratio icon shows two white 1-hole Technic bricks side-by-side, indicating that the parts should be assembled in a 1:1 ratio.

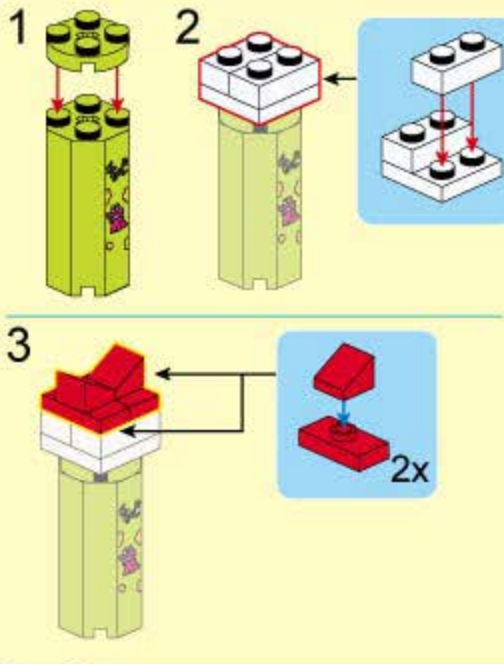
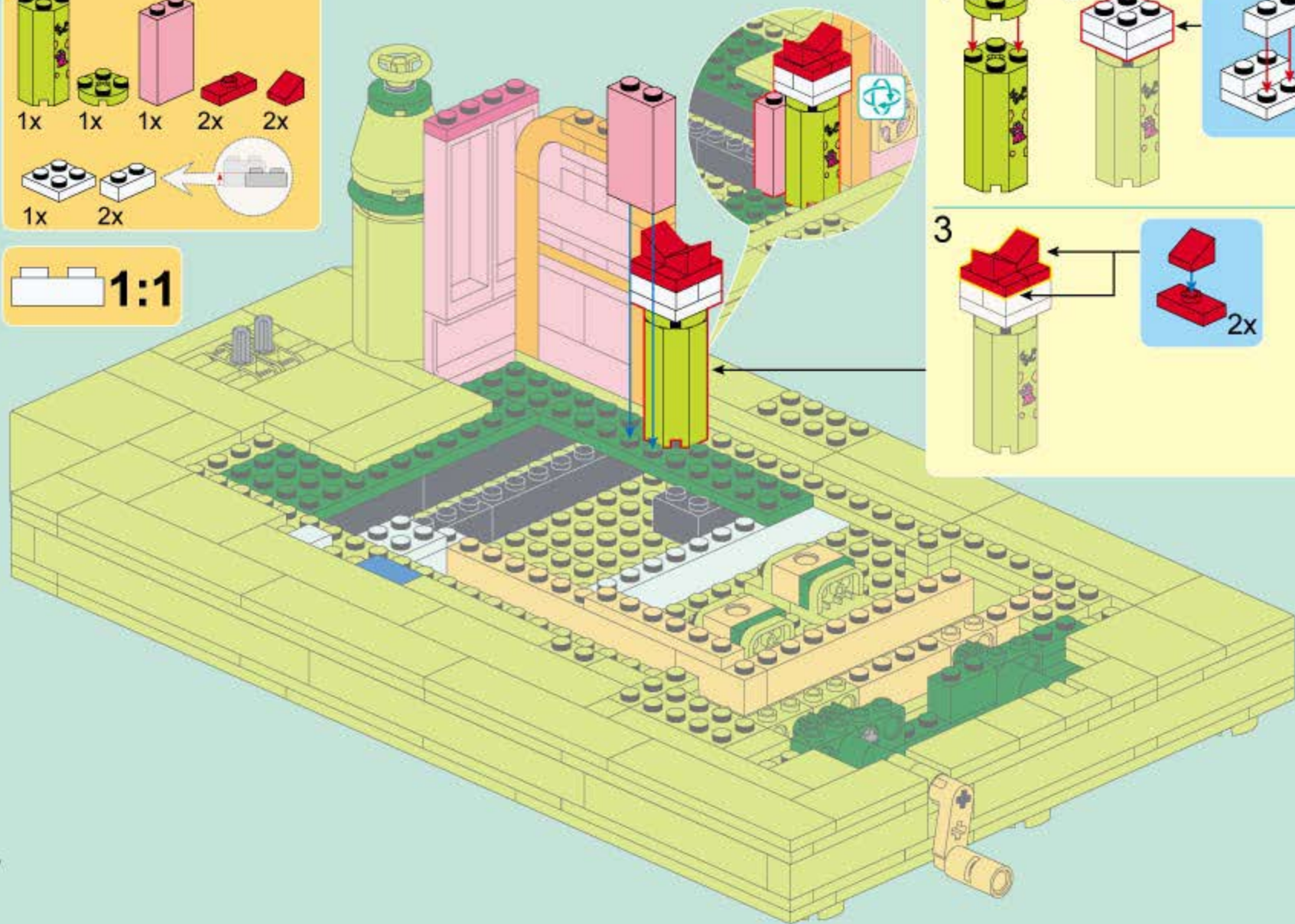

B59

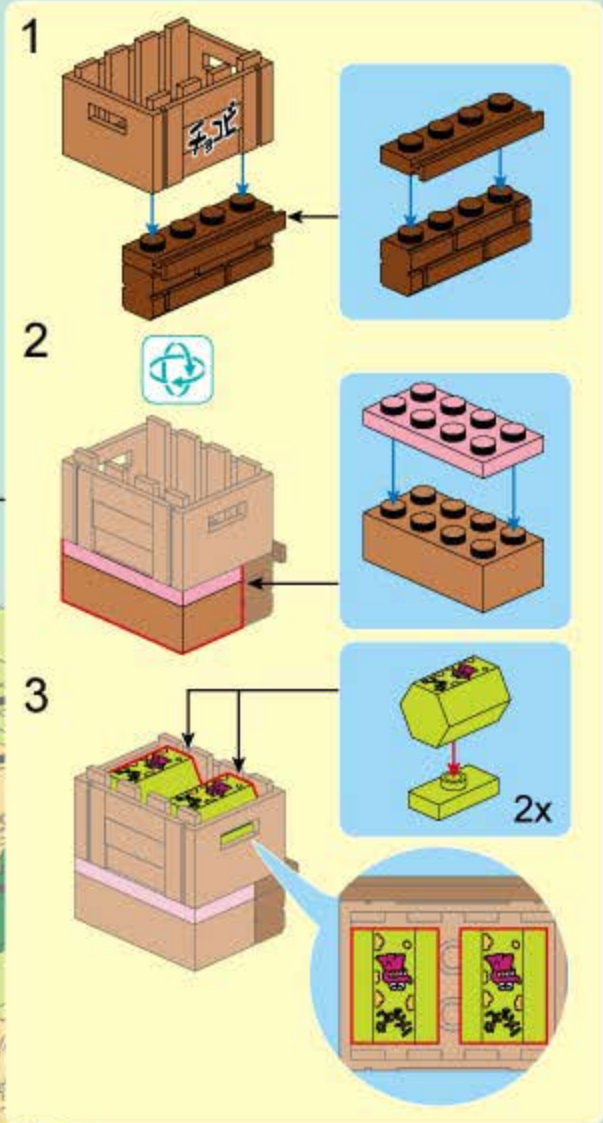
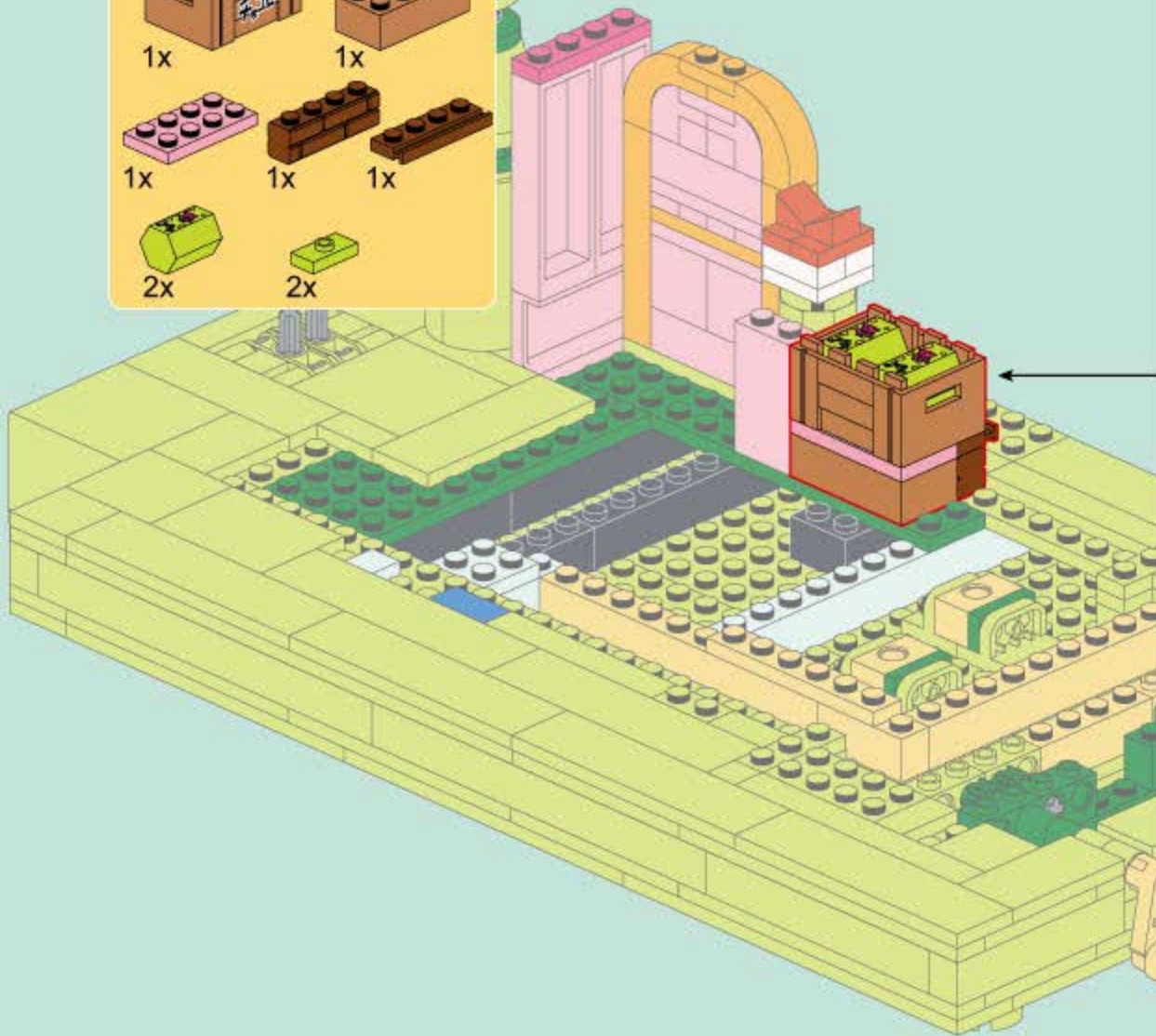
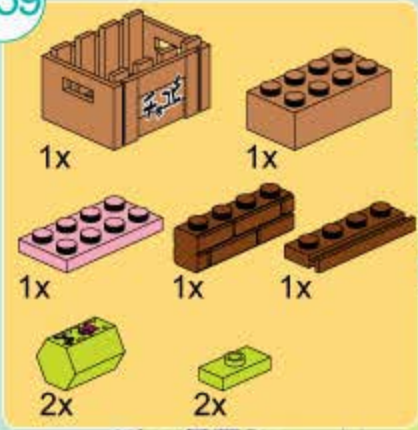

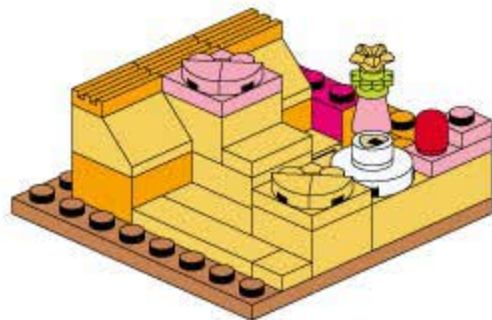

B60

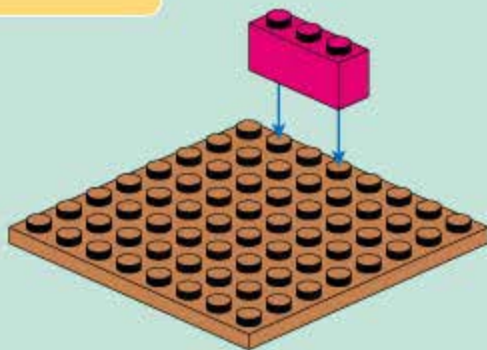
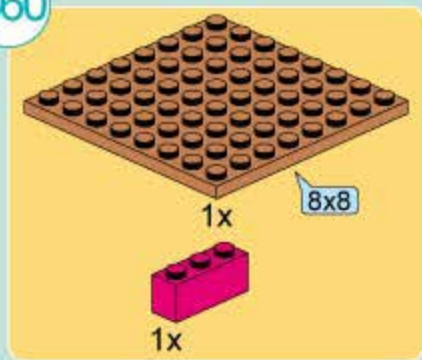

B61

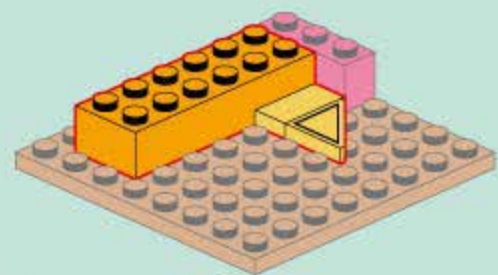
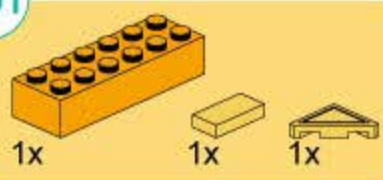

B62

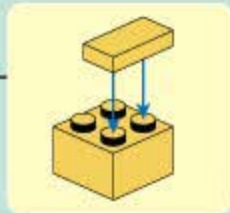
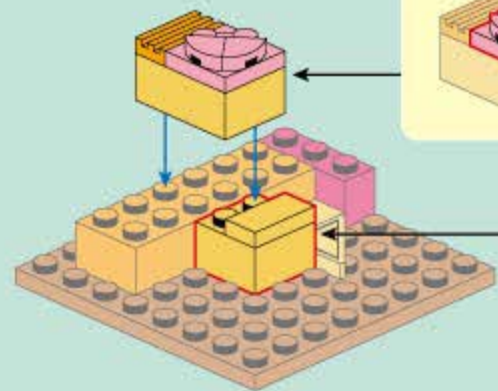
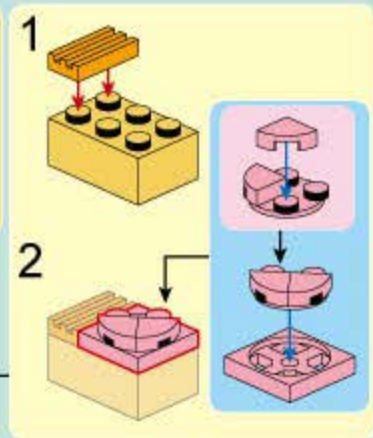
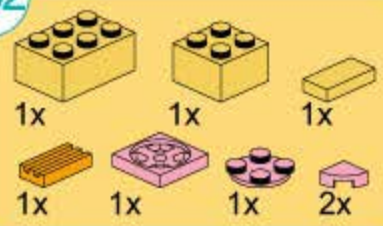

B63

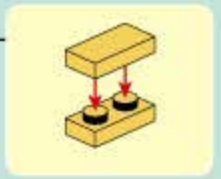
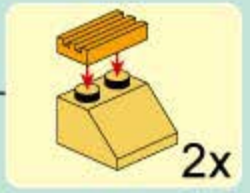
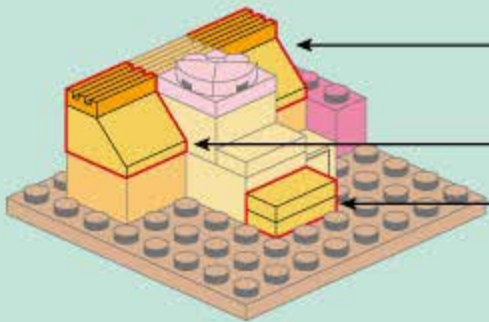
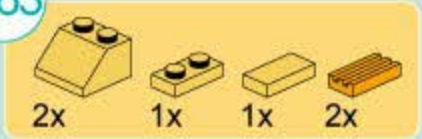

B64

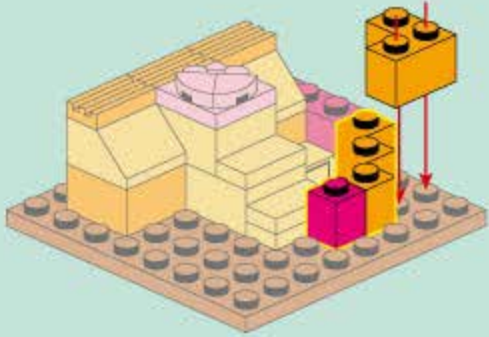
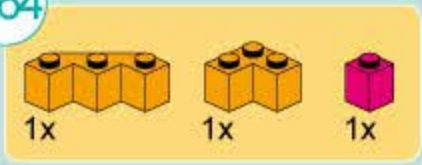

B65

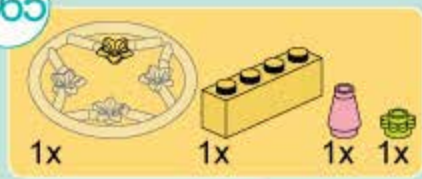



B68

B59

B67

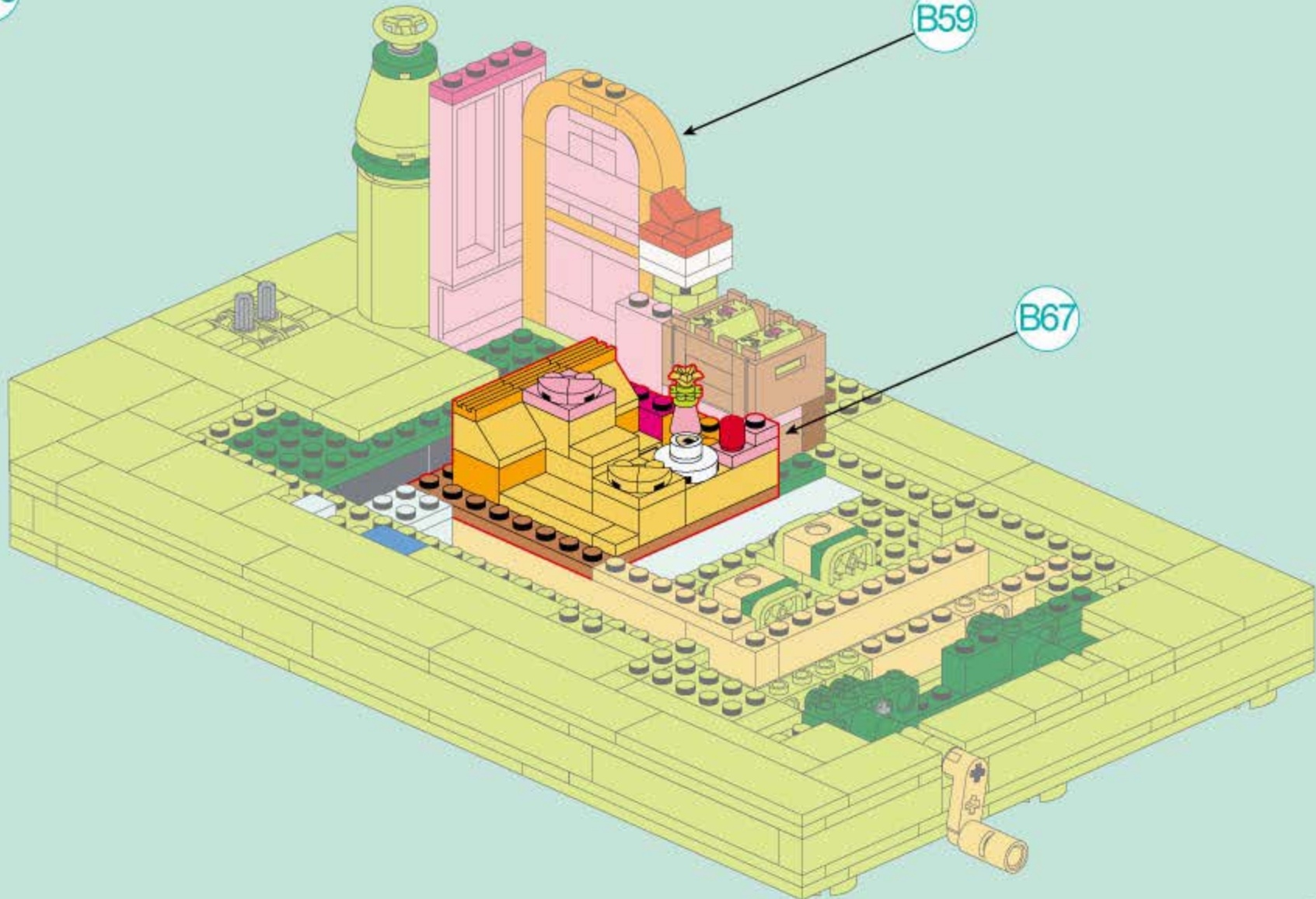



23x

+

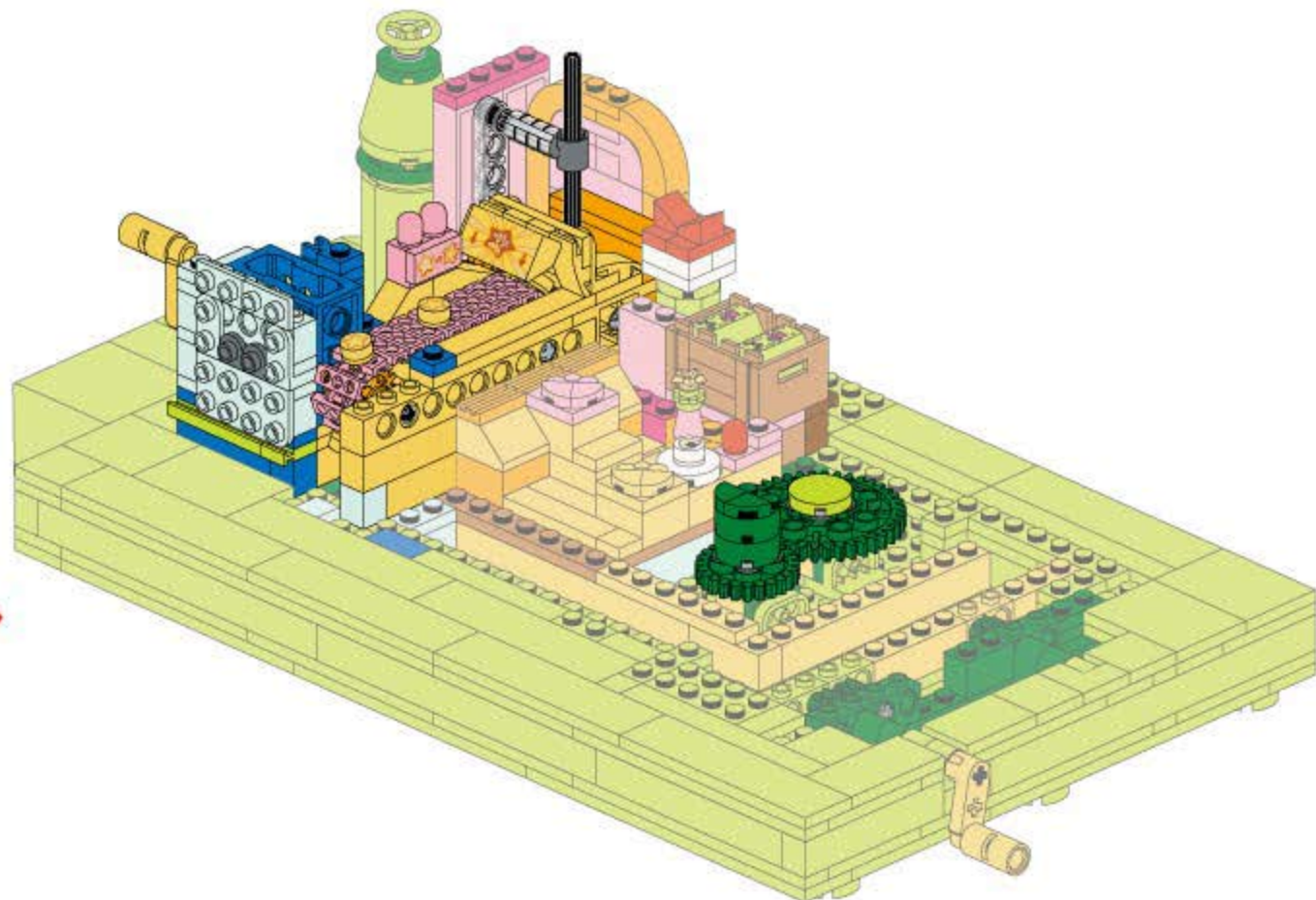

B69



1x



1x



1x



4x

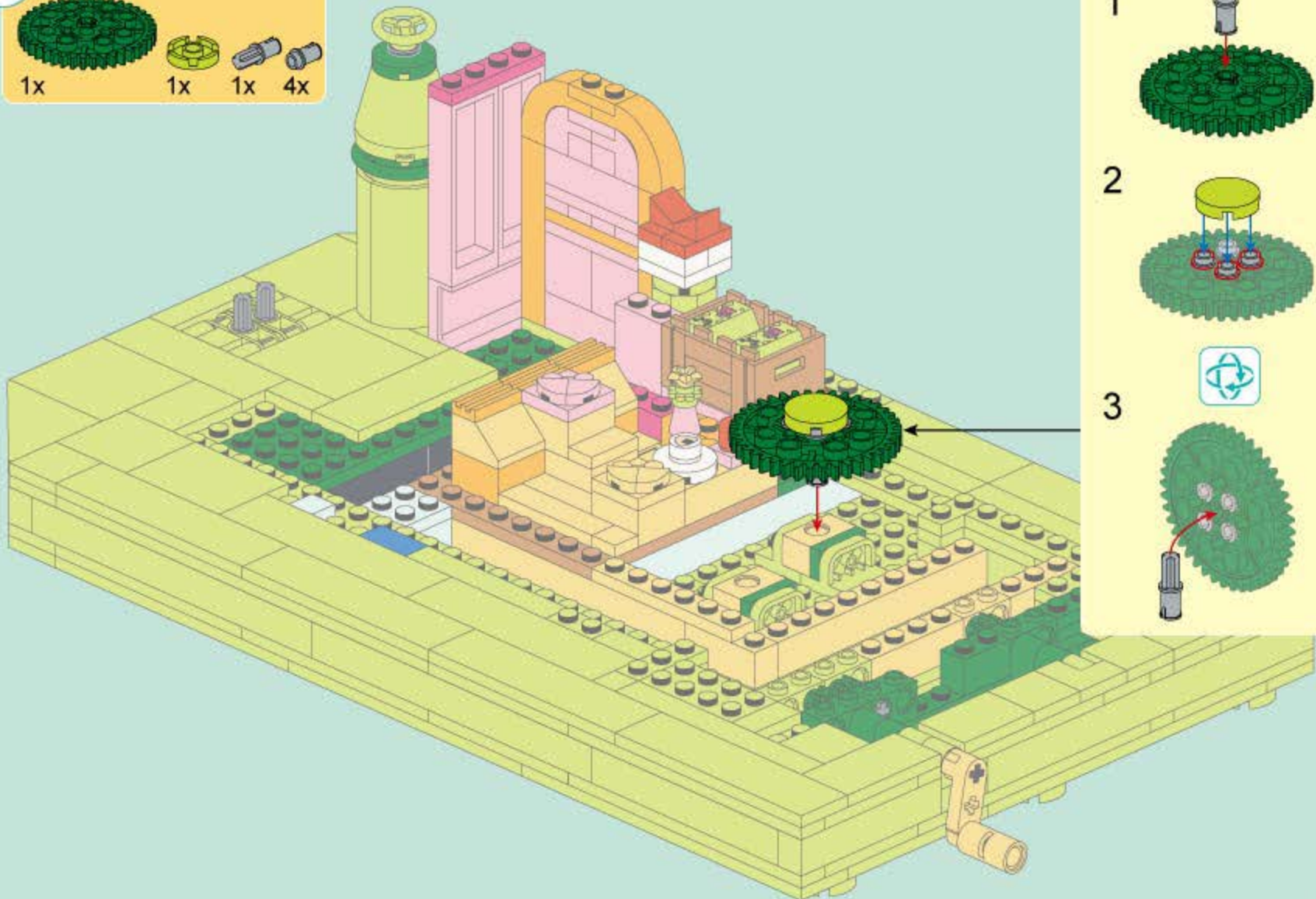

1



2

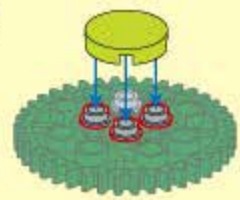

3

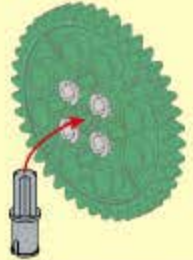

B70



1x



2x



2x



1x



4x

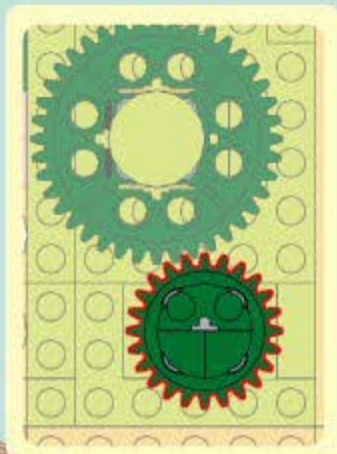

1



2



3



1



2



4



B71

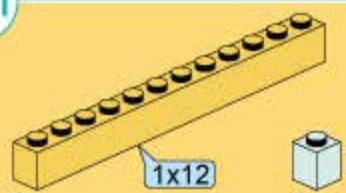

1x12

2x



1x



2x



1x



1x

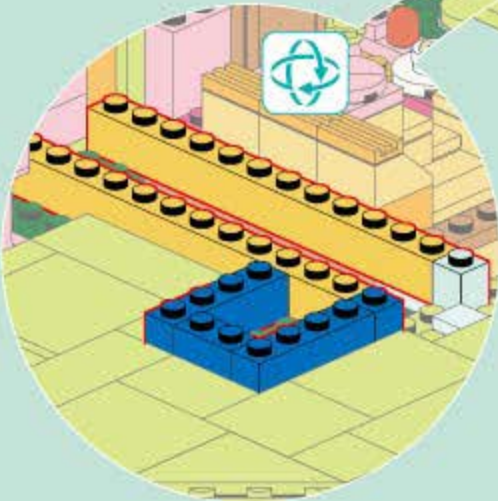
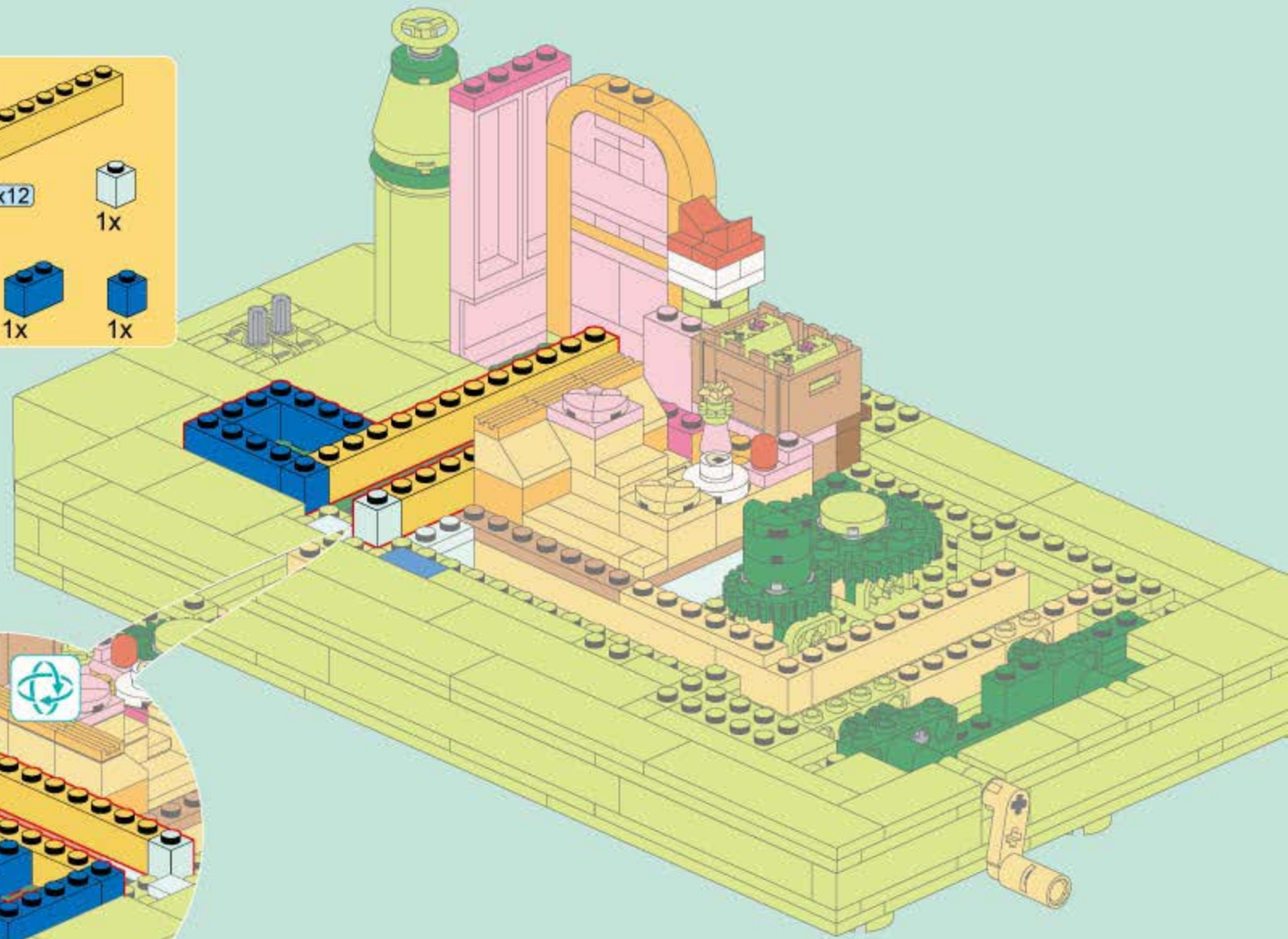

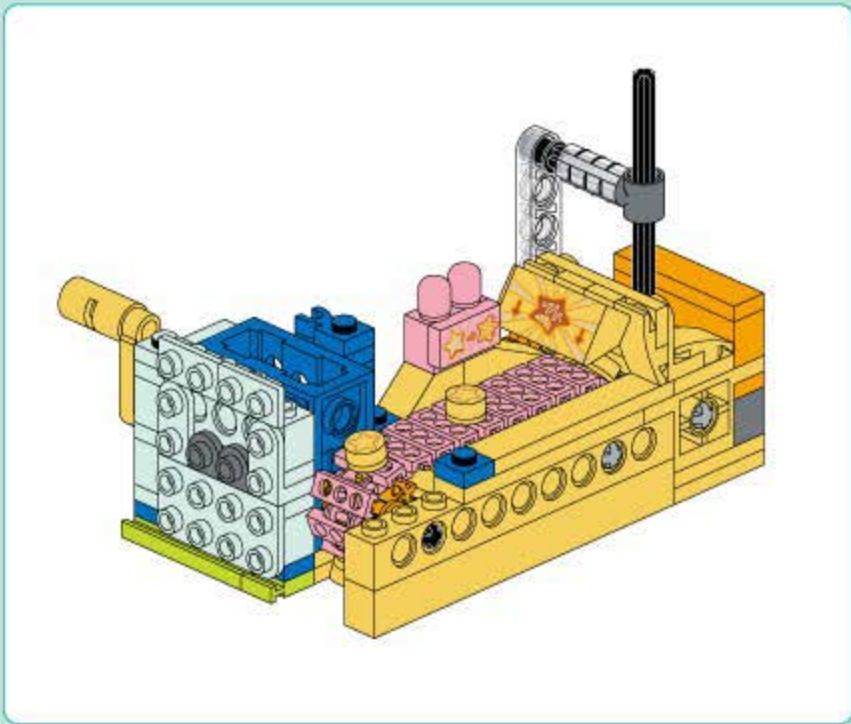

B72

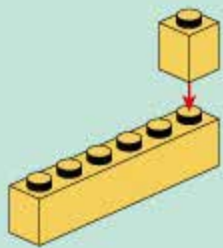
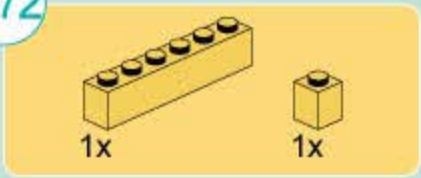

B73

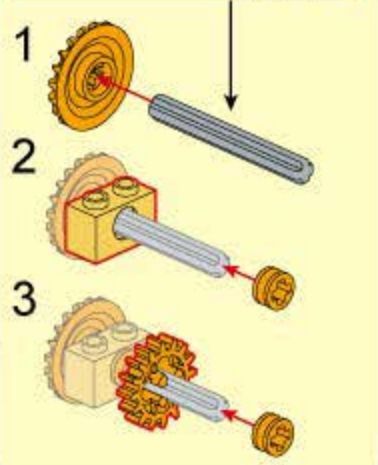
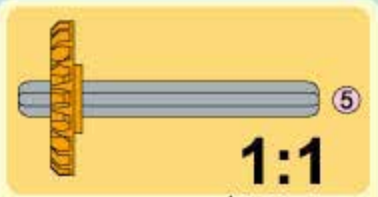
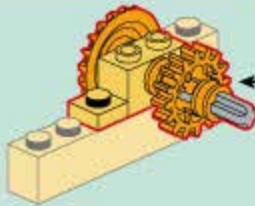
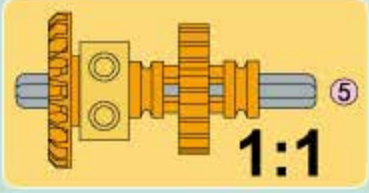
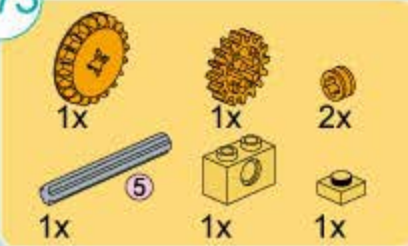

B74

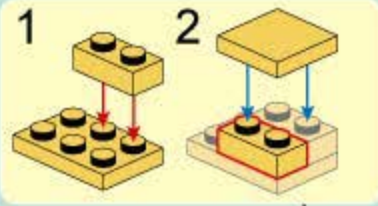
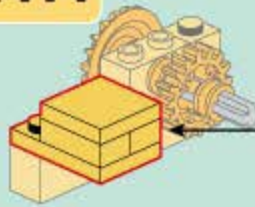
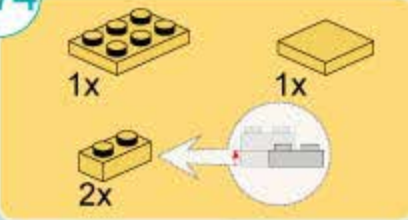

B75

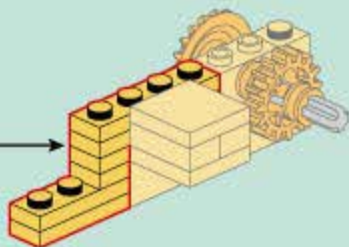
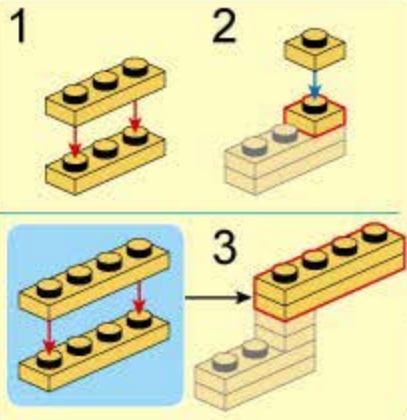
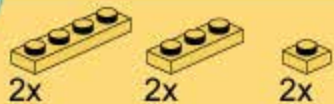

B76

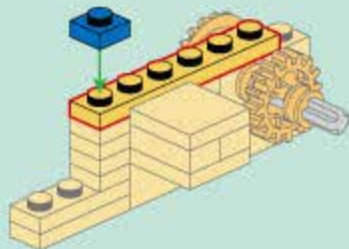

B77

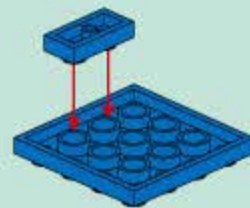
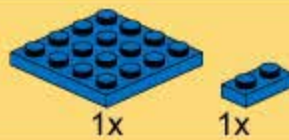

B78

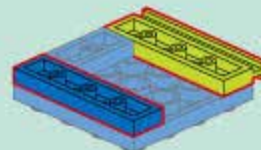
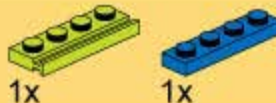

B79

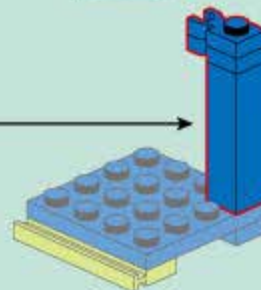
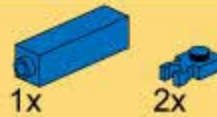

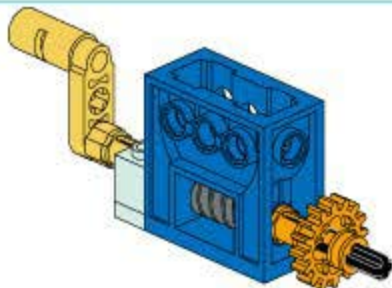

B80



1x

1x

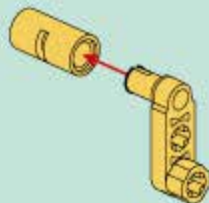

B81



1x

1x



10

1:1

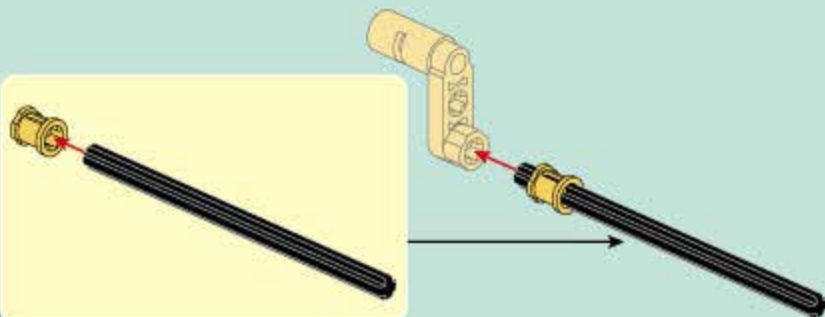

B82



1x



1x



1x



1x



1x

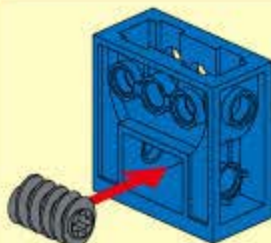
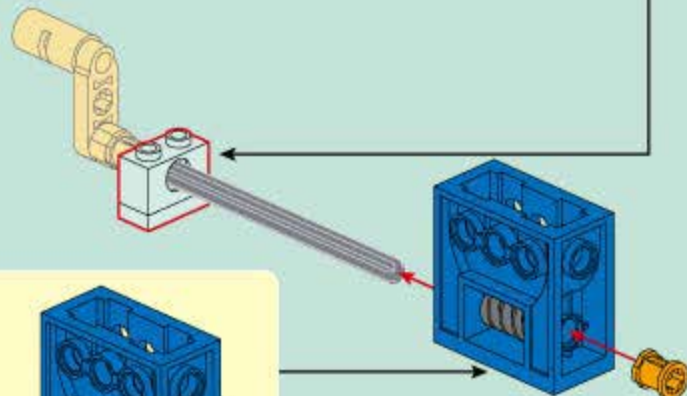
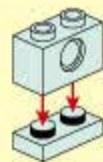

B83



1x



1x

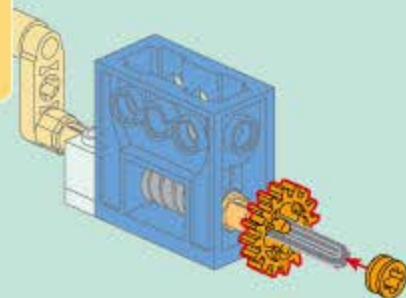

B84

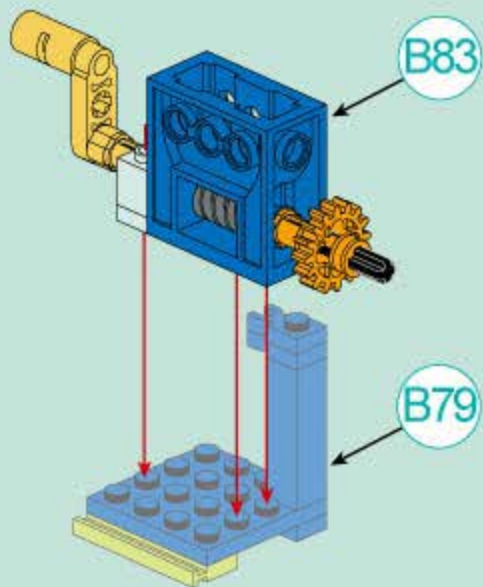

B85

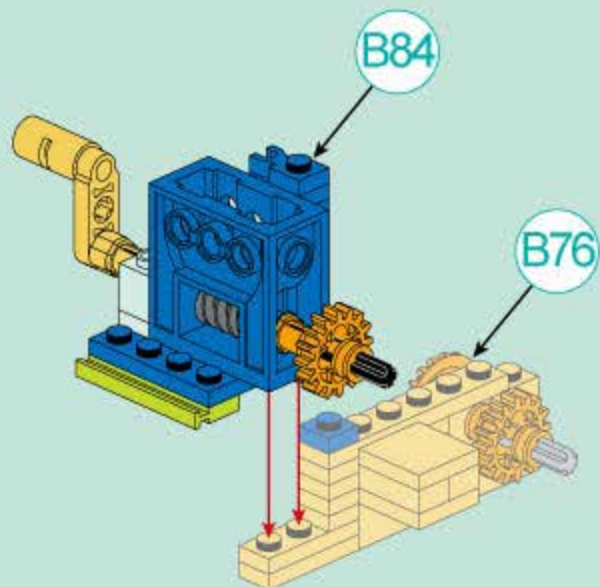

B86

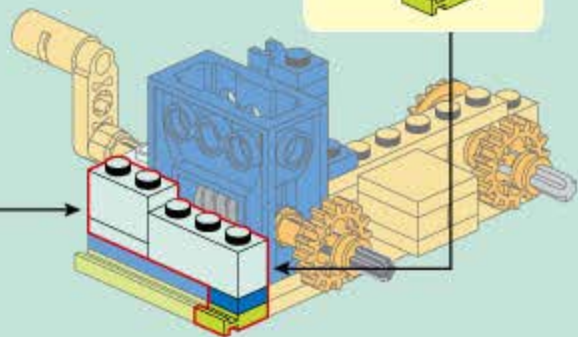
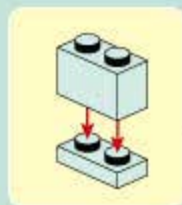
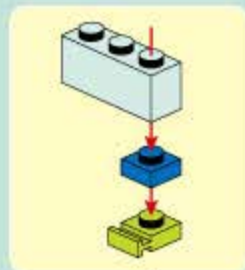
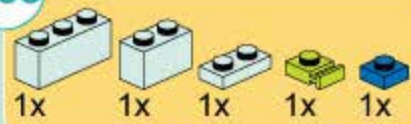

B87

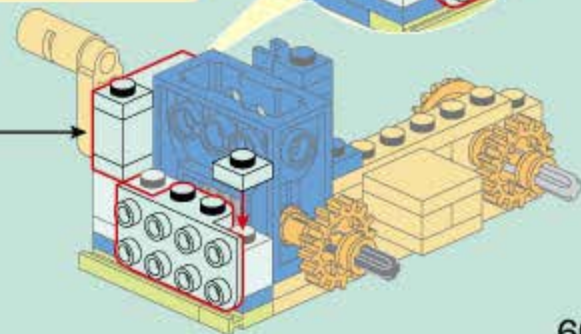
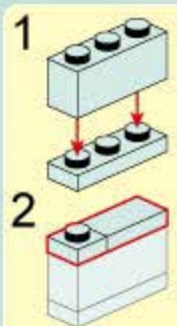
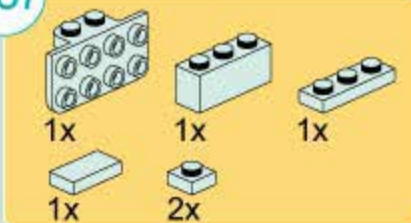



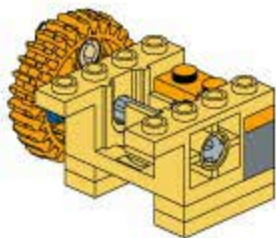

B91

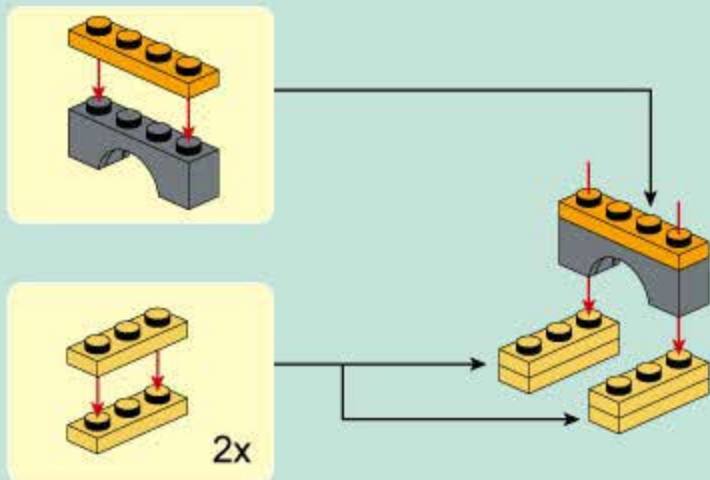
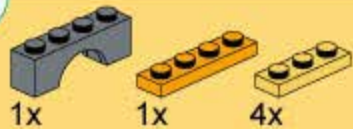

B92

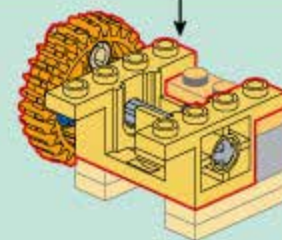
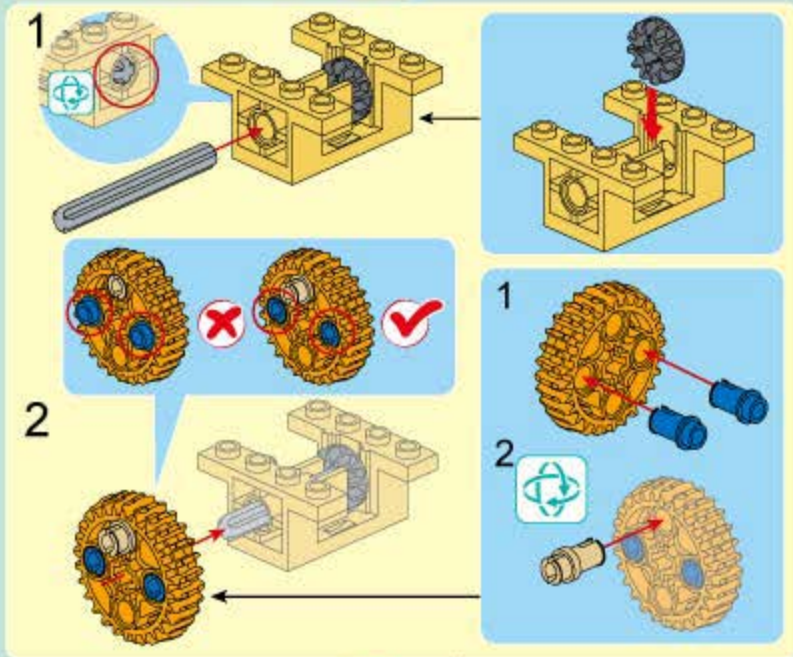
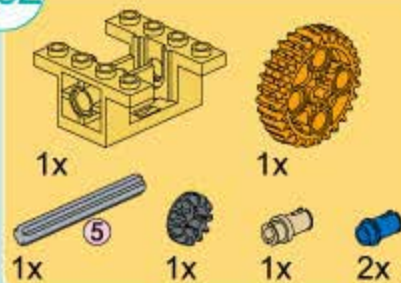

B93



B90

B92

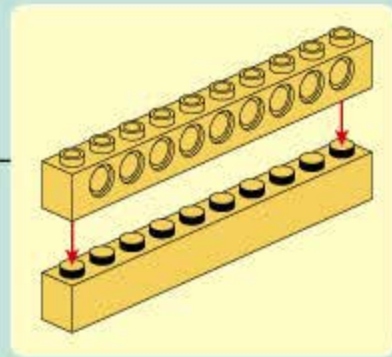
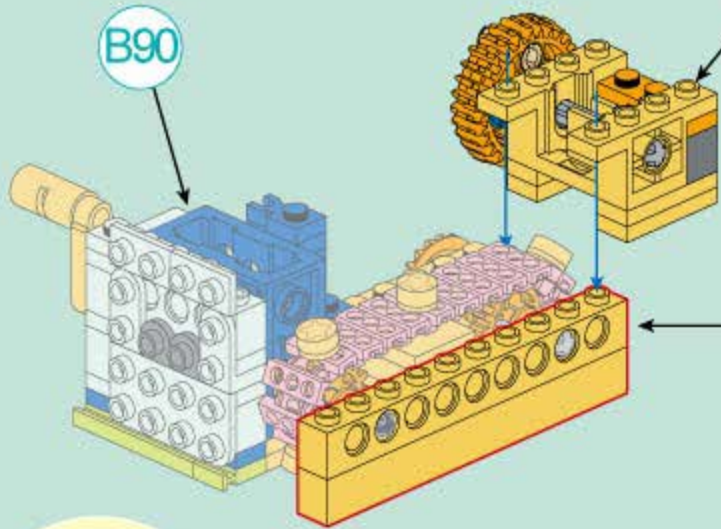

B94

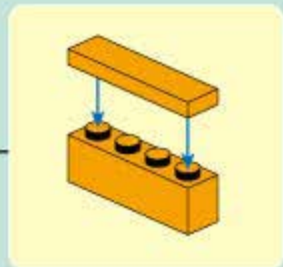
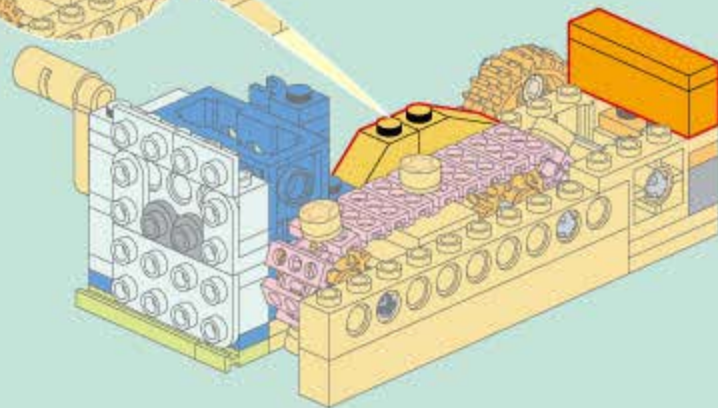
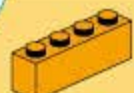

B95

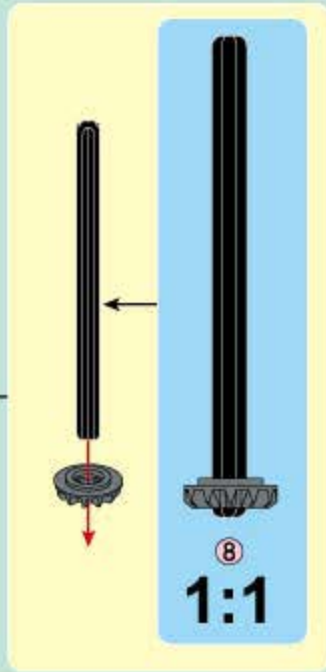
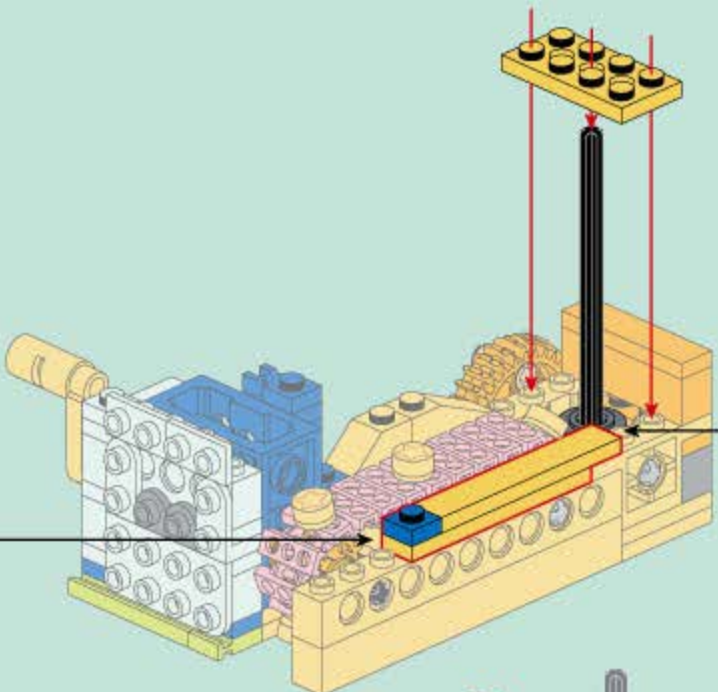
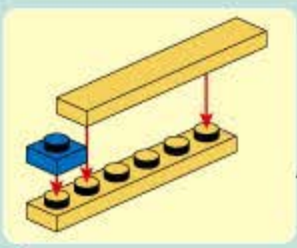
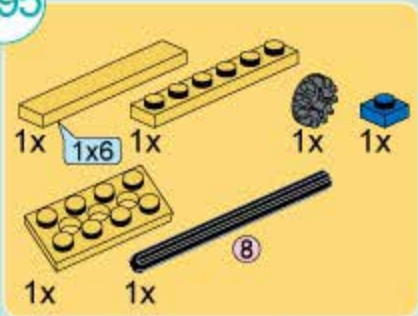

B96

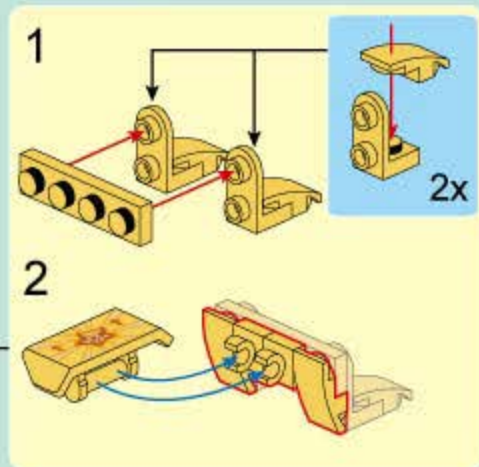
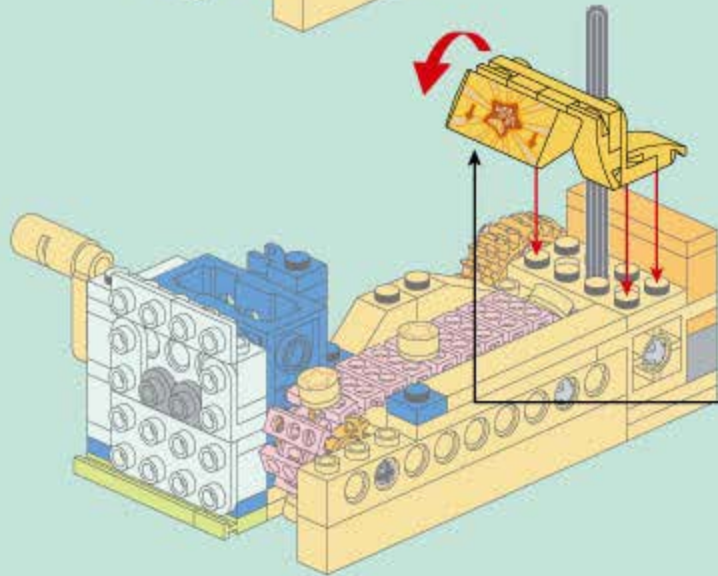
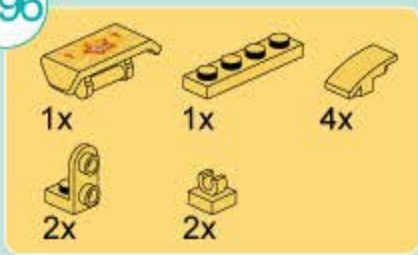

B97

- 1x 5 (grey axle with 5 holes)
- 1x (grey axle with 3 holes)
- 1x (black axle pin)
- 1x (grey axle bush)
- 1x (pink 2-hole Technic brick)
- 1x (pink 1-hole Technic brick)
- 2x (pink Technic pins)

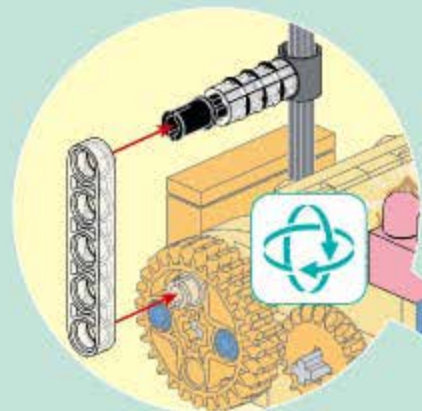

- 1 (pink 2-hole Technic brick and pink 1-hole Technic brick)
- 2 (pink 2-hole Technic brick with two pink Technic pins)

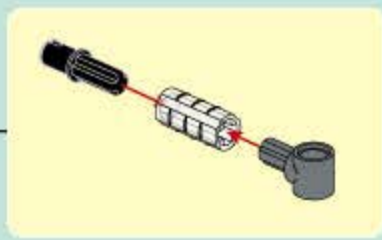
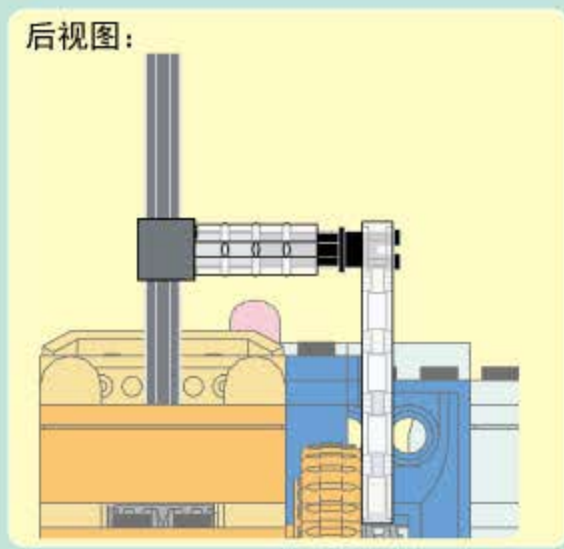
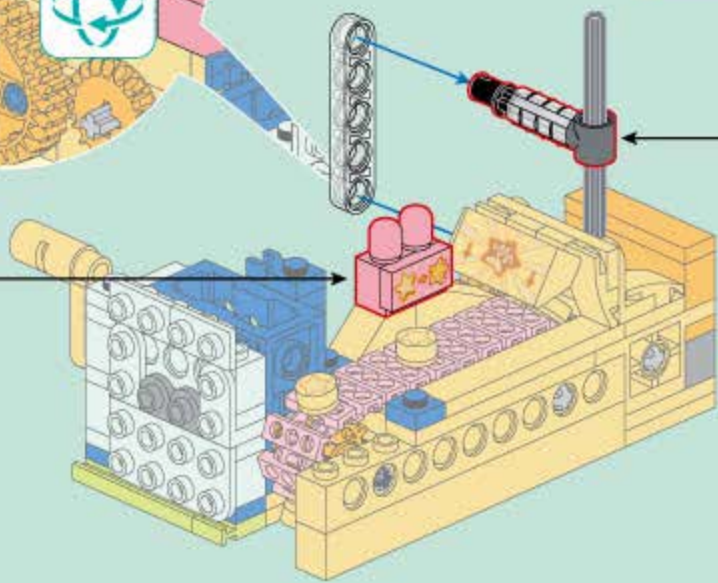

B98

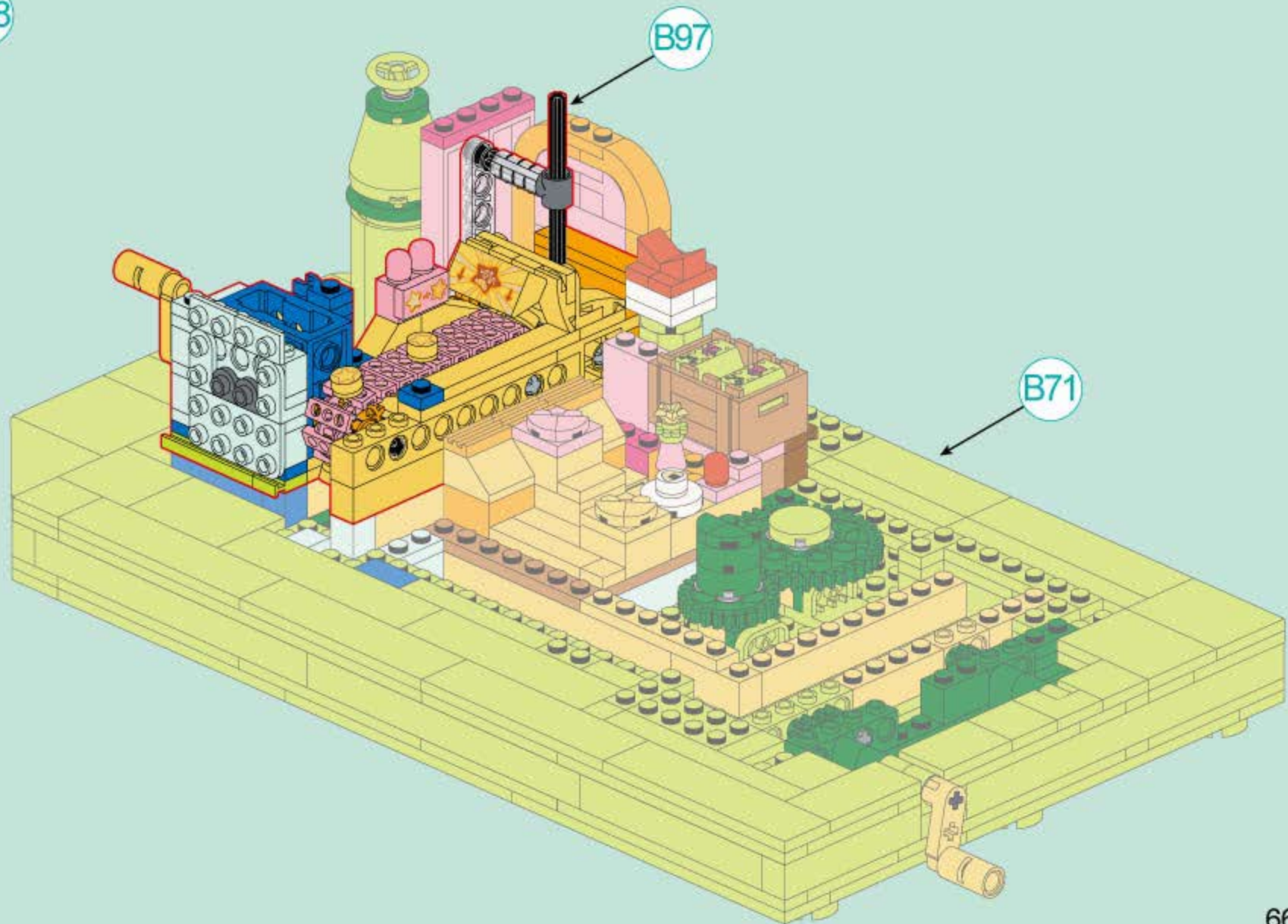



蜡笔小新

# 鳄鱼山饼干工厂



下册

正版授权

K20642

图片仅供参考, 请以实物为准。

© USUI YOSHITO 1992-2025 Licensed by Animation Int'l



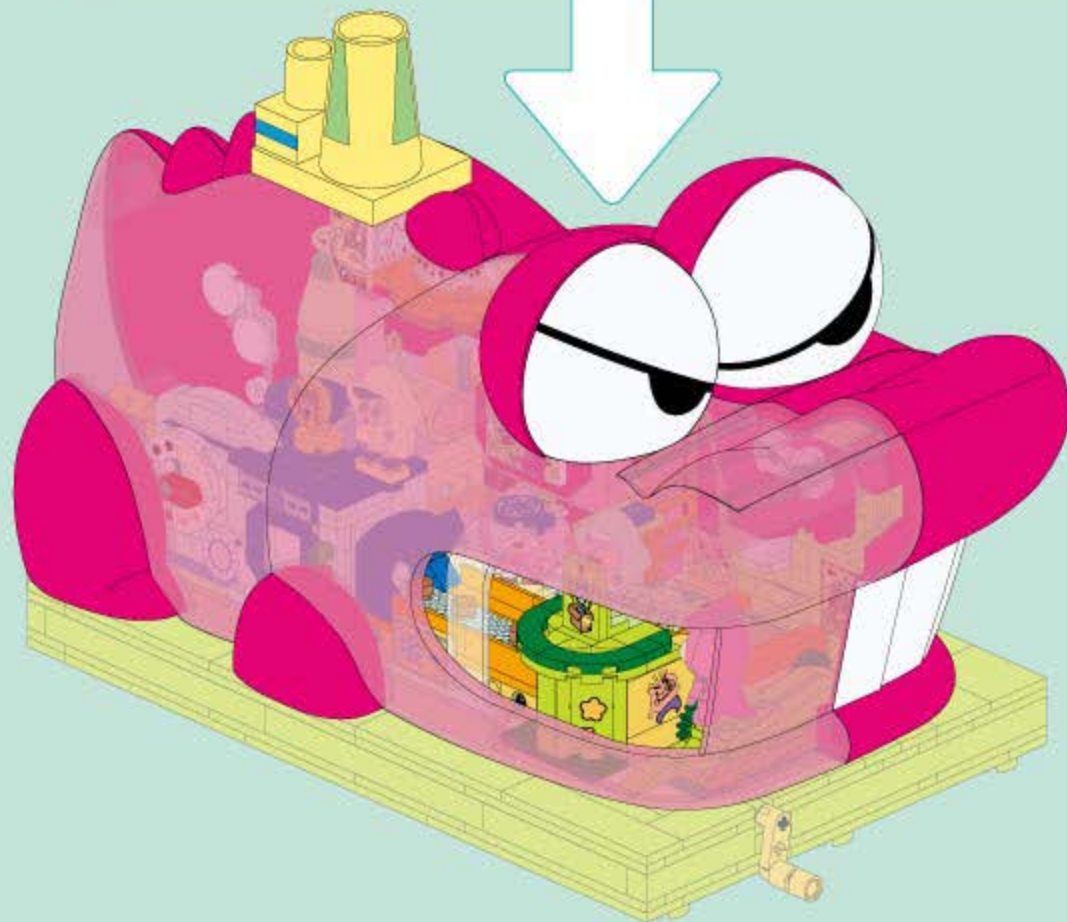



1x



1x

3x4



1x

+



6

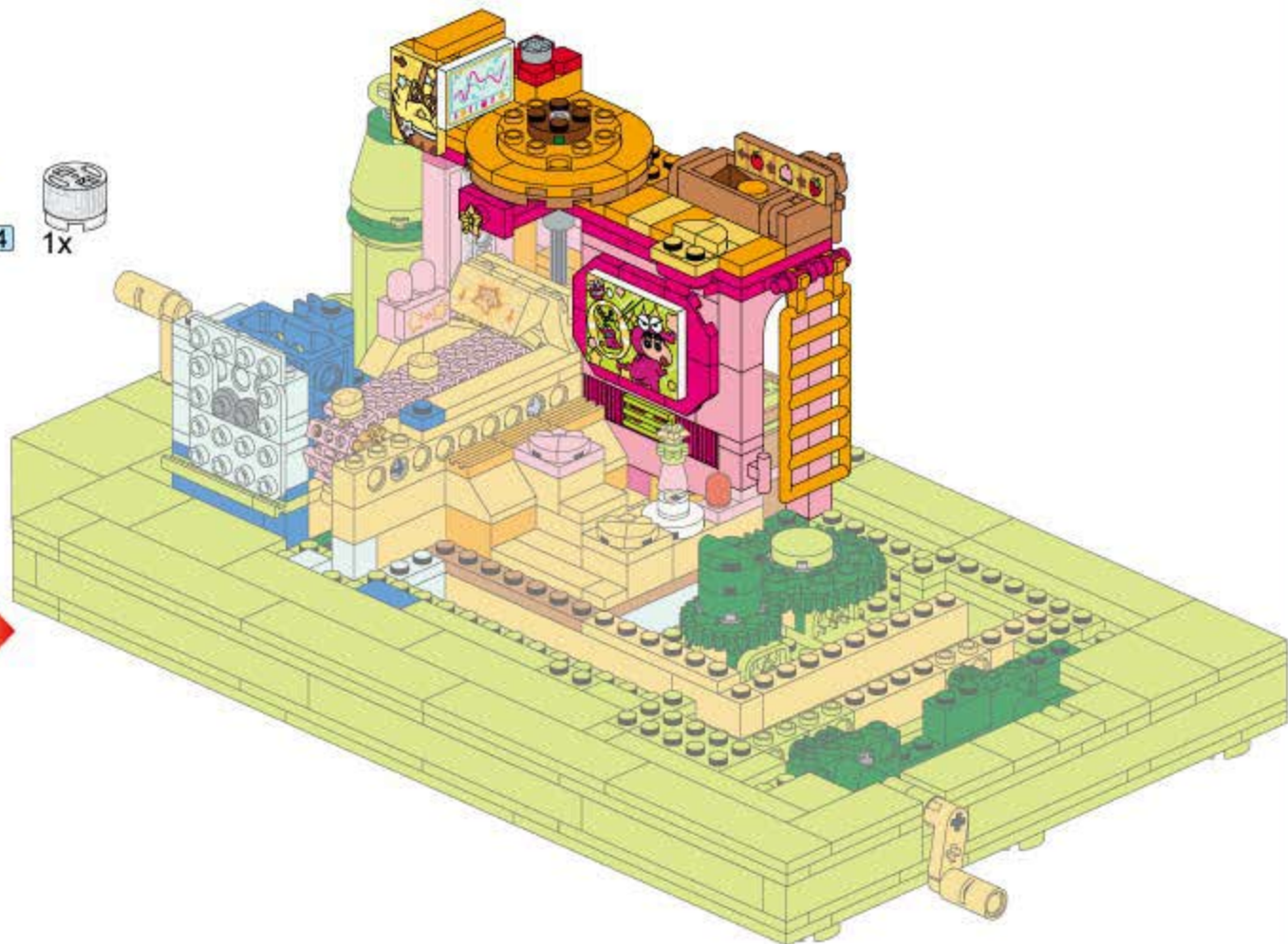



B99

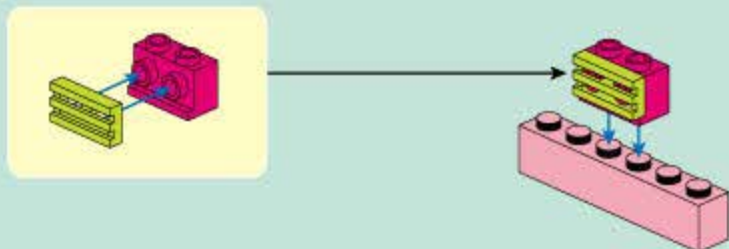
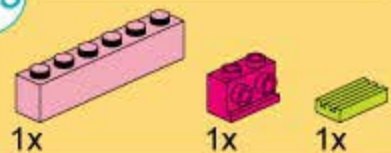

B100

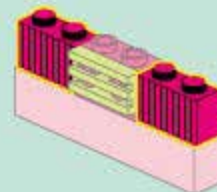

B101

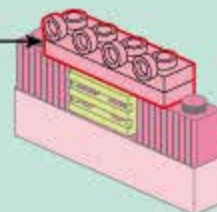
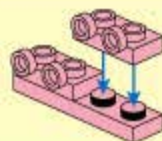
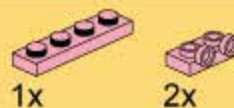

B102

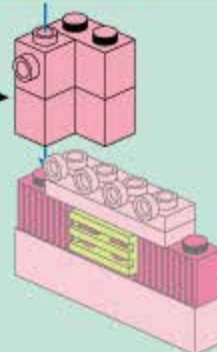
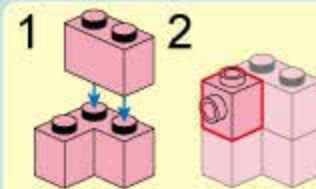
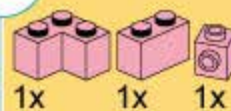

B103

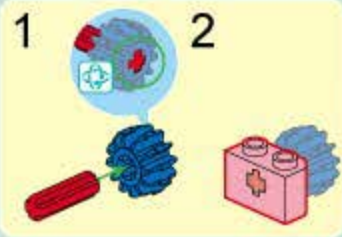

B104

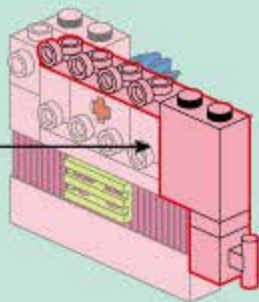
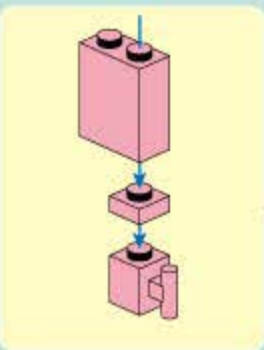
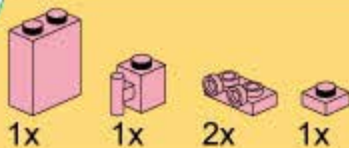

B105

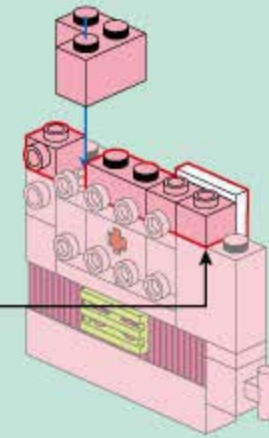
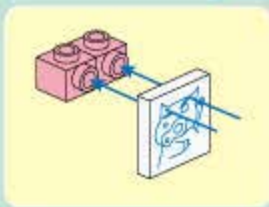
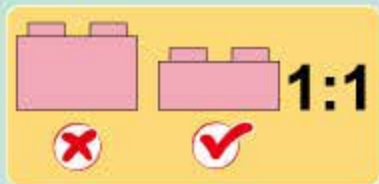
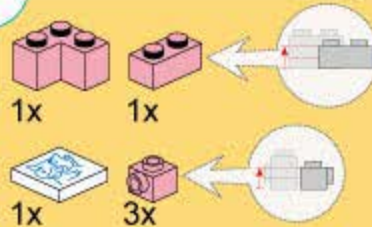

B106

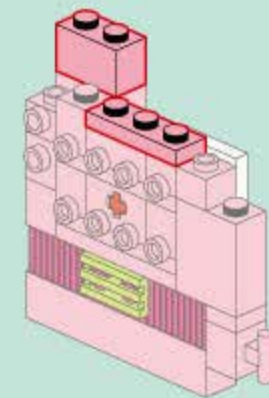
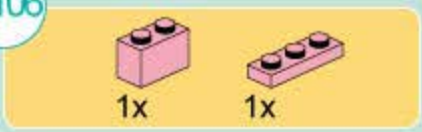

B107

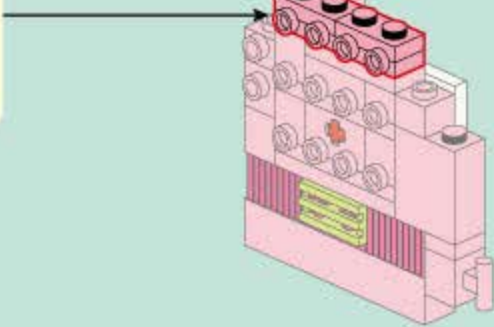
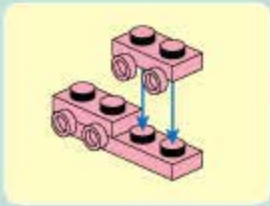
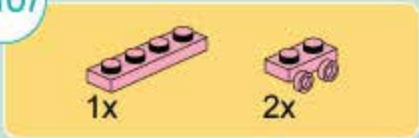

B108

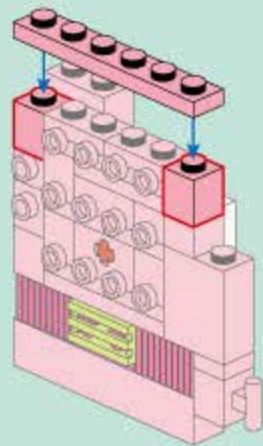
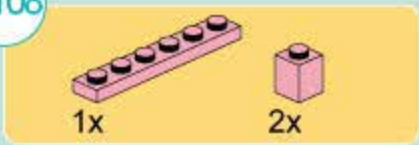

B109

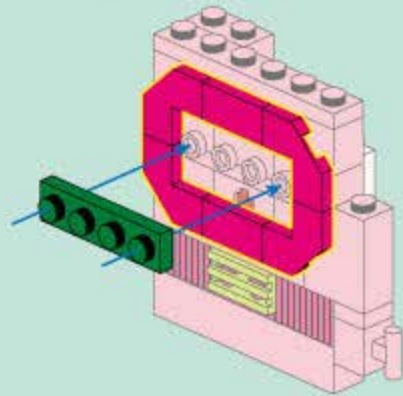
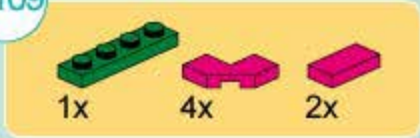

B110

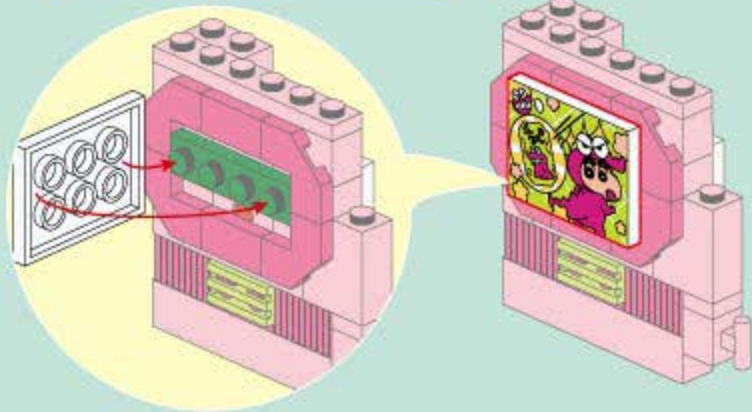

B111

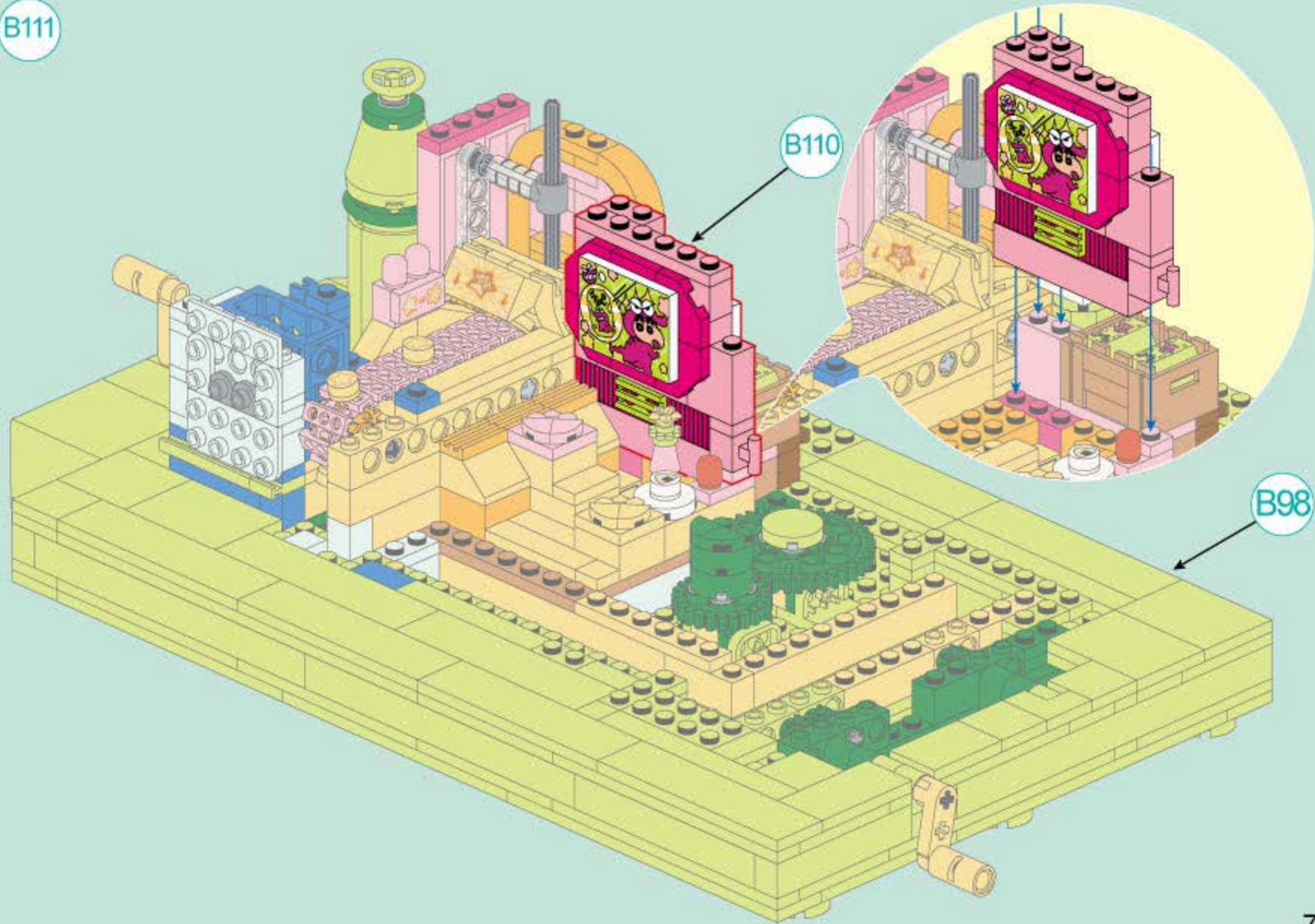

B110

B98

B112

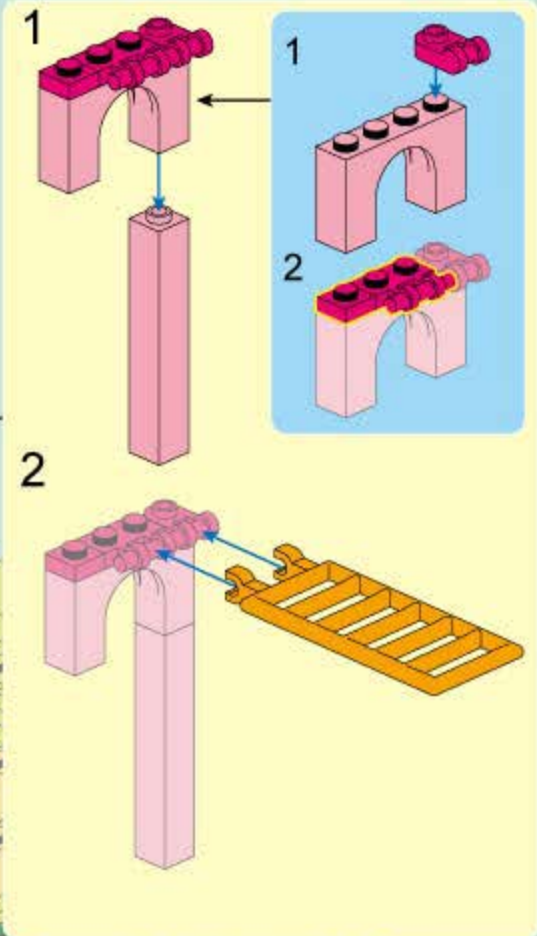
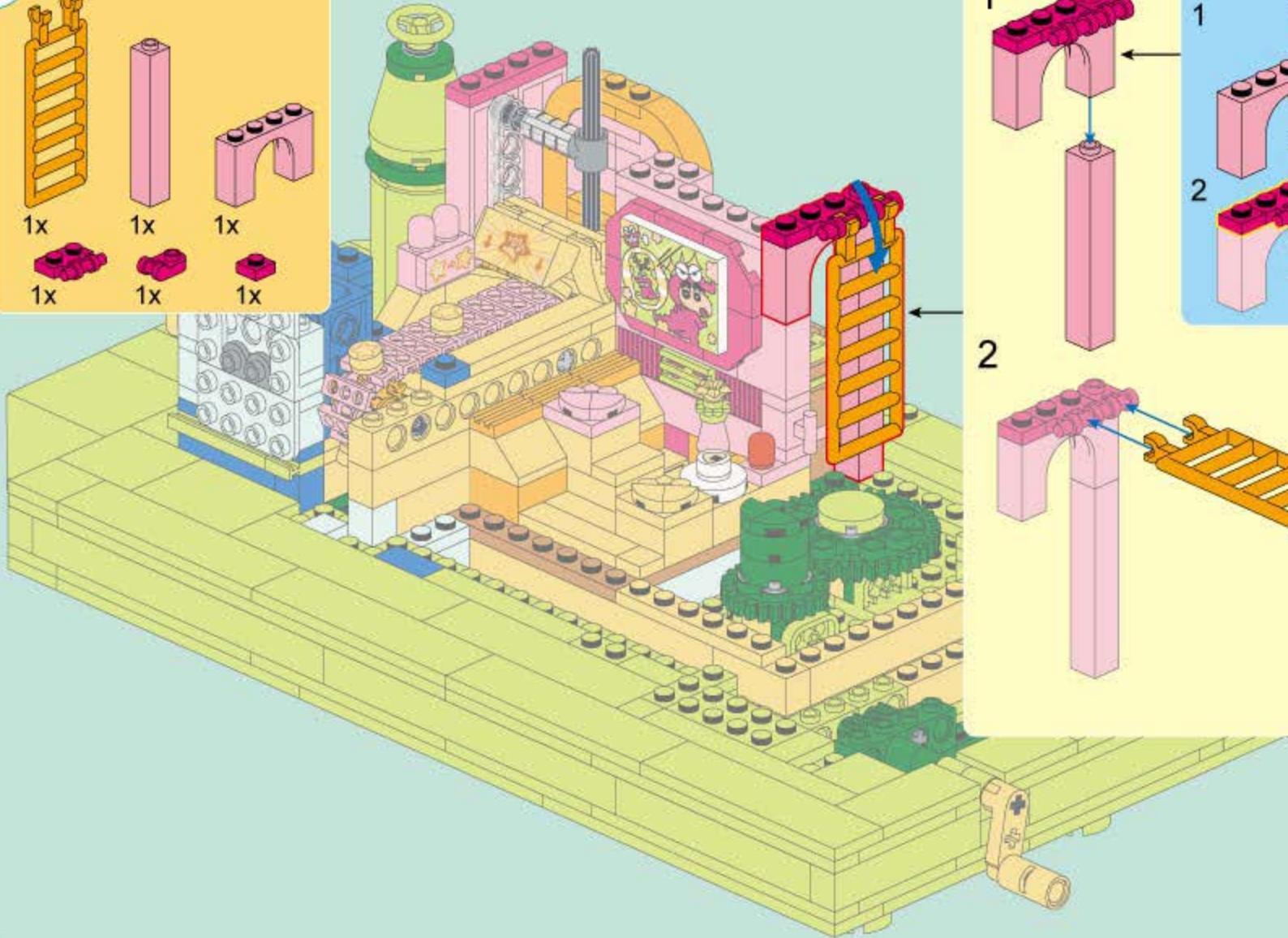
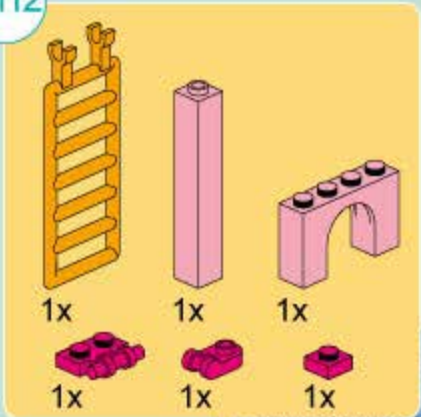

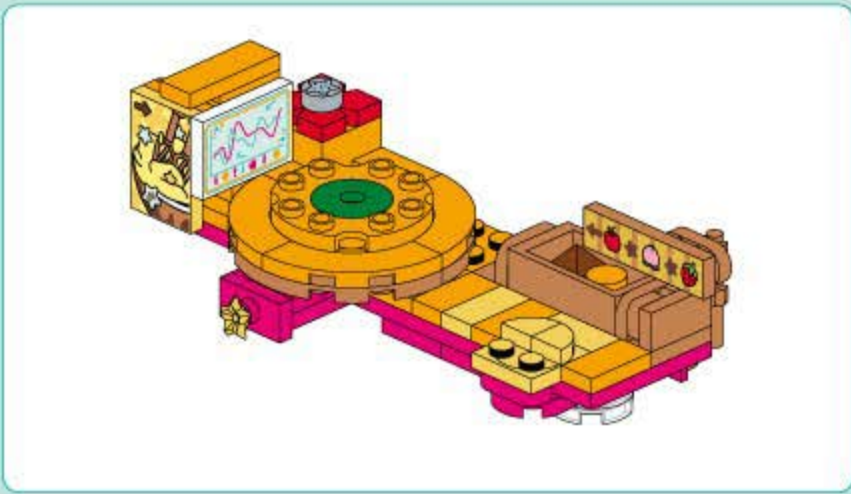

B113

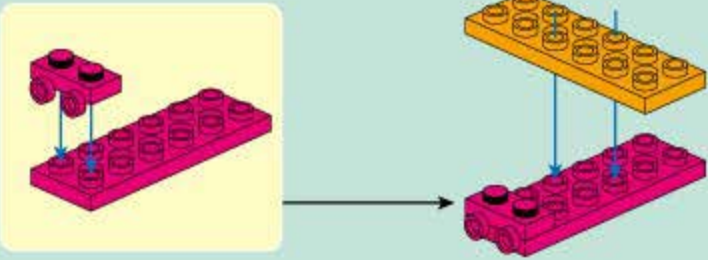
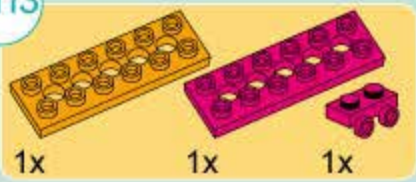

B114

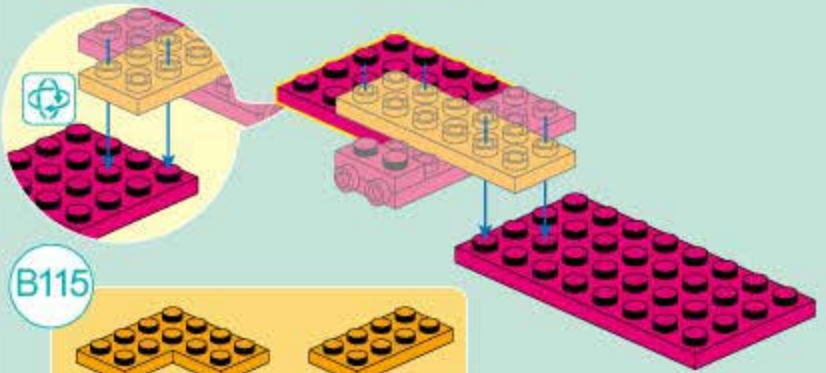
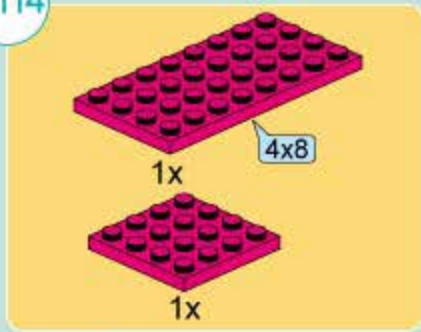

B115

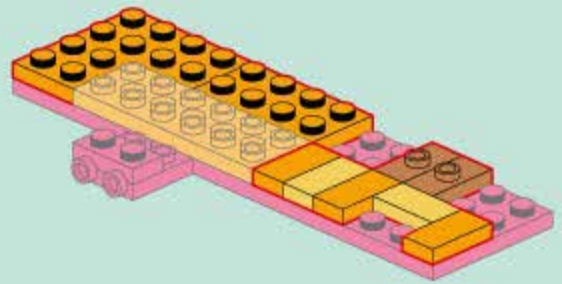
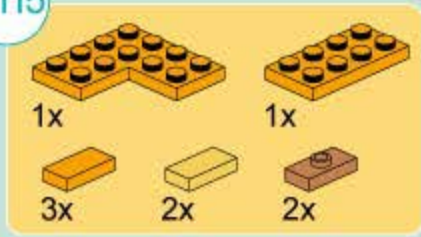

B116

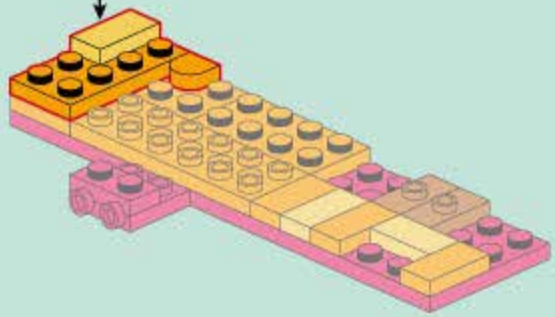
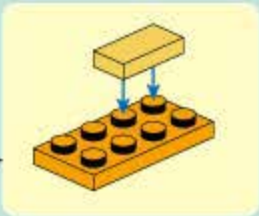
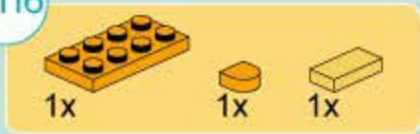

B117

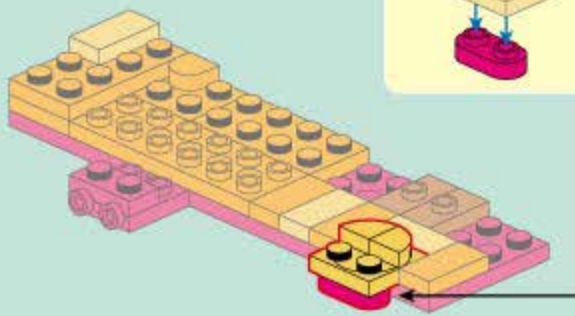
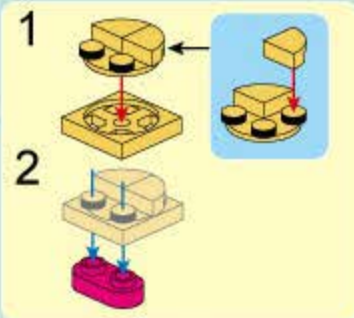

B118

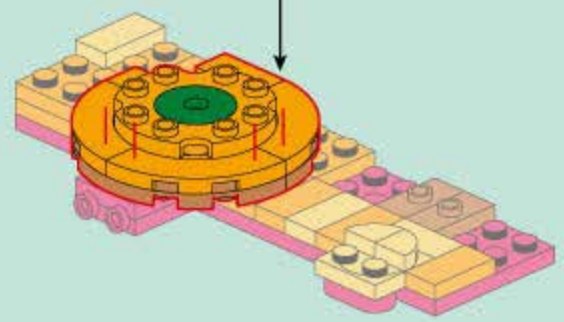
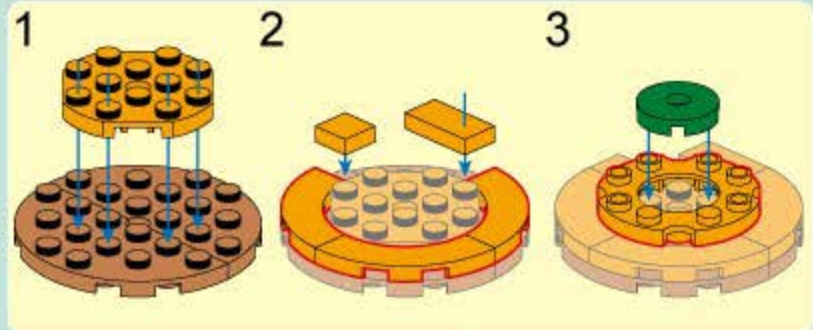
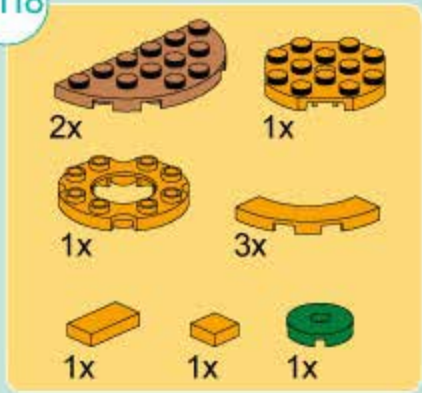

B119

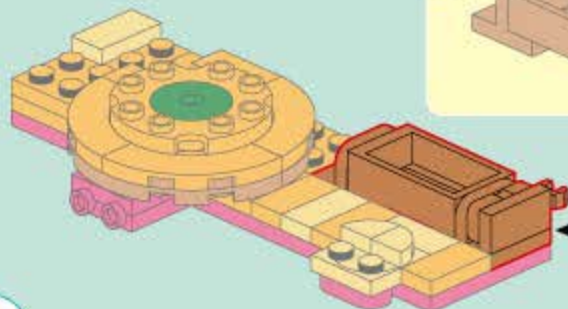
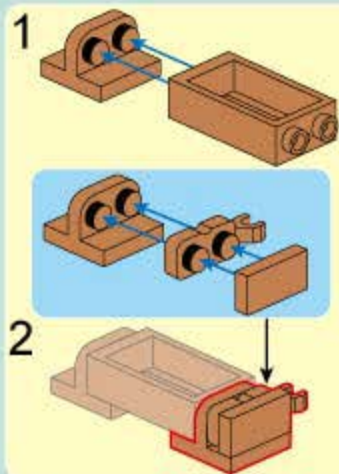
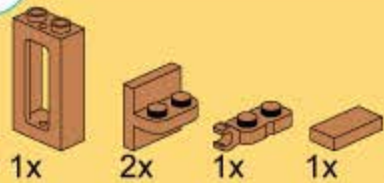

B120

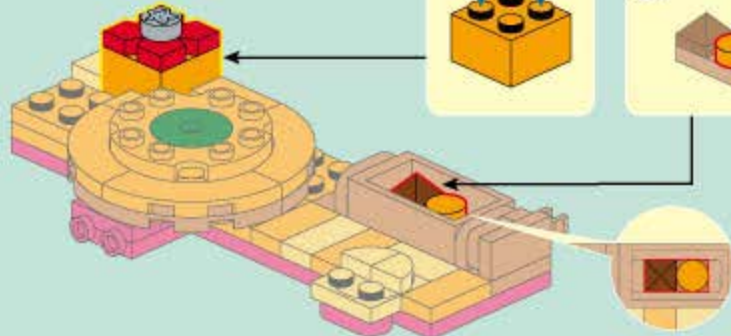
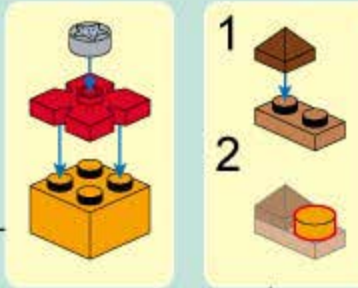
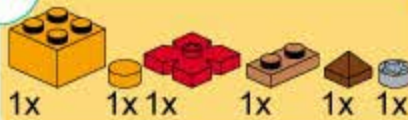

B121

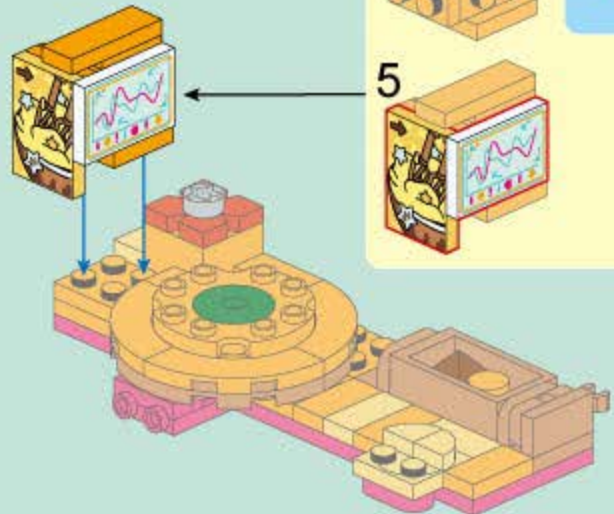
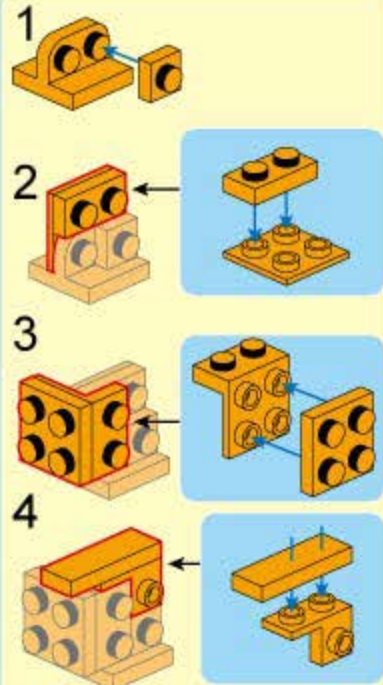
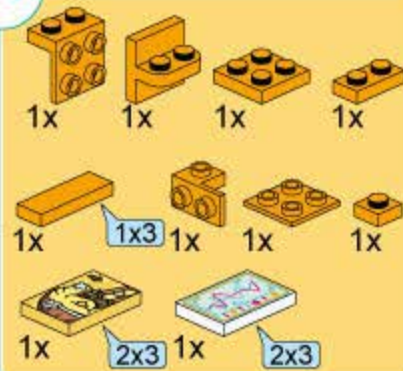

B122

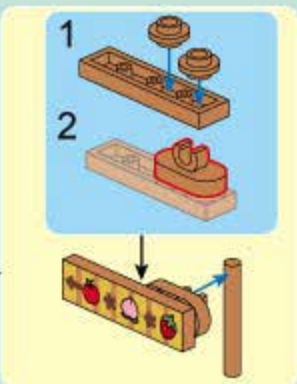
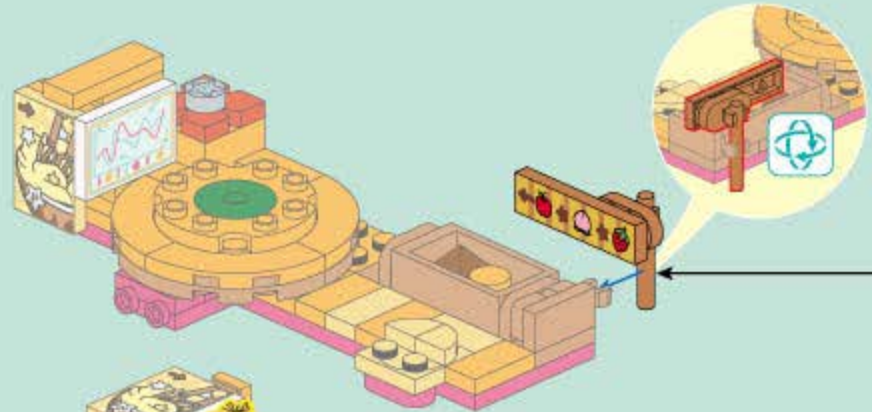
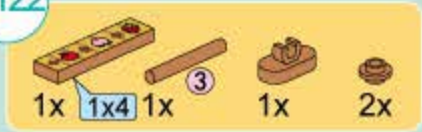

B123

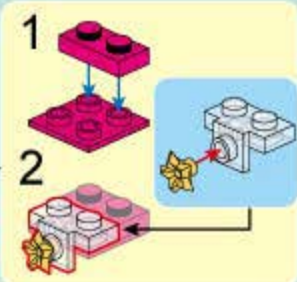
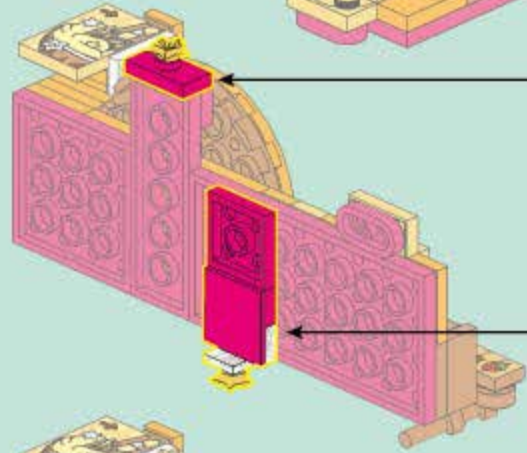
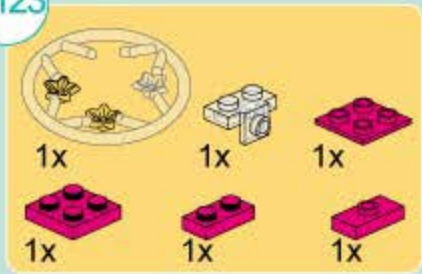

B124

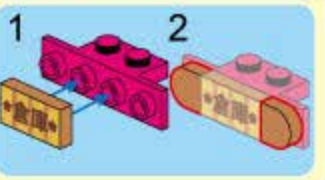
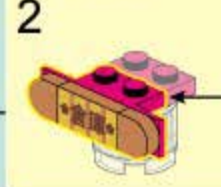
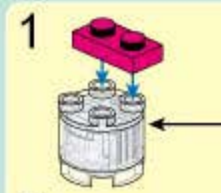
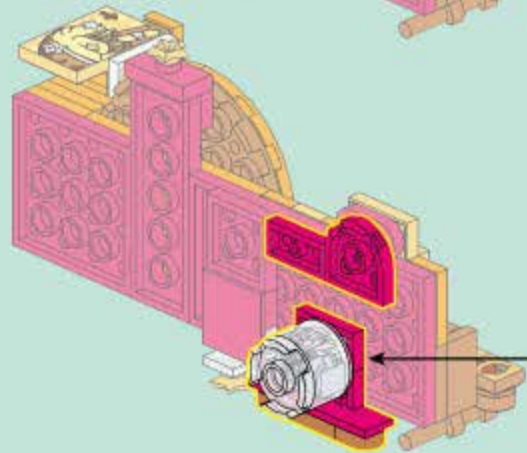
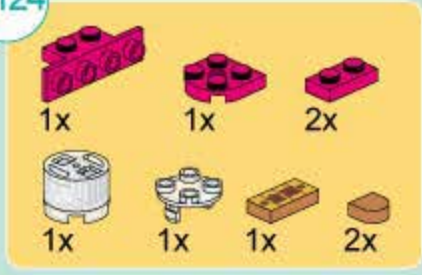

B125



1x

B124



B112

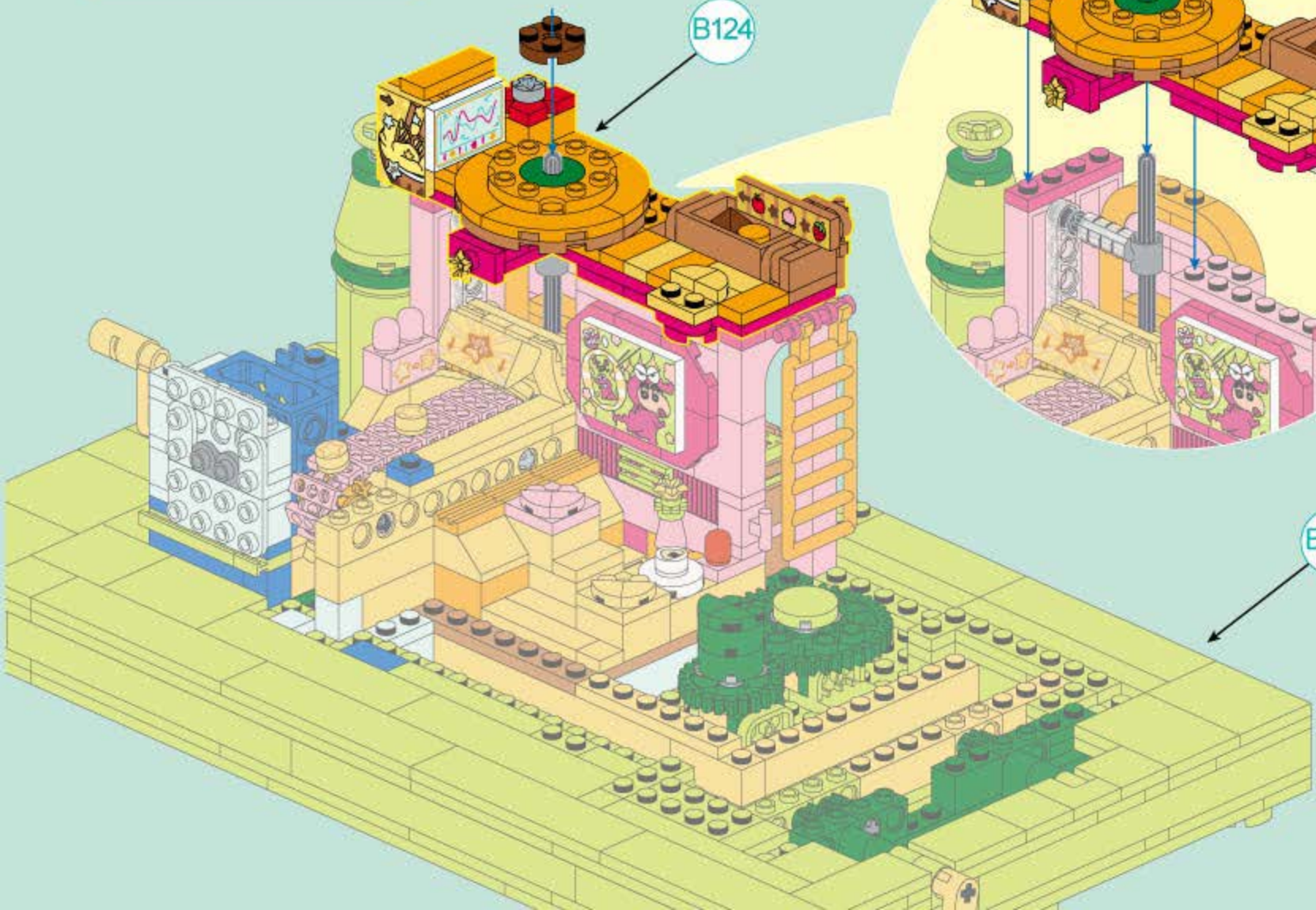



1x

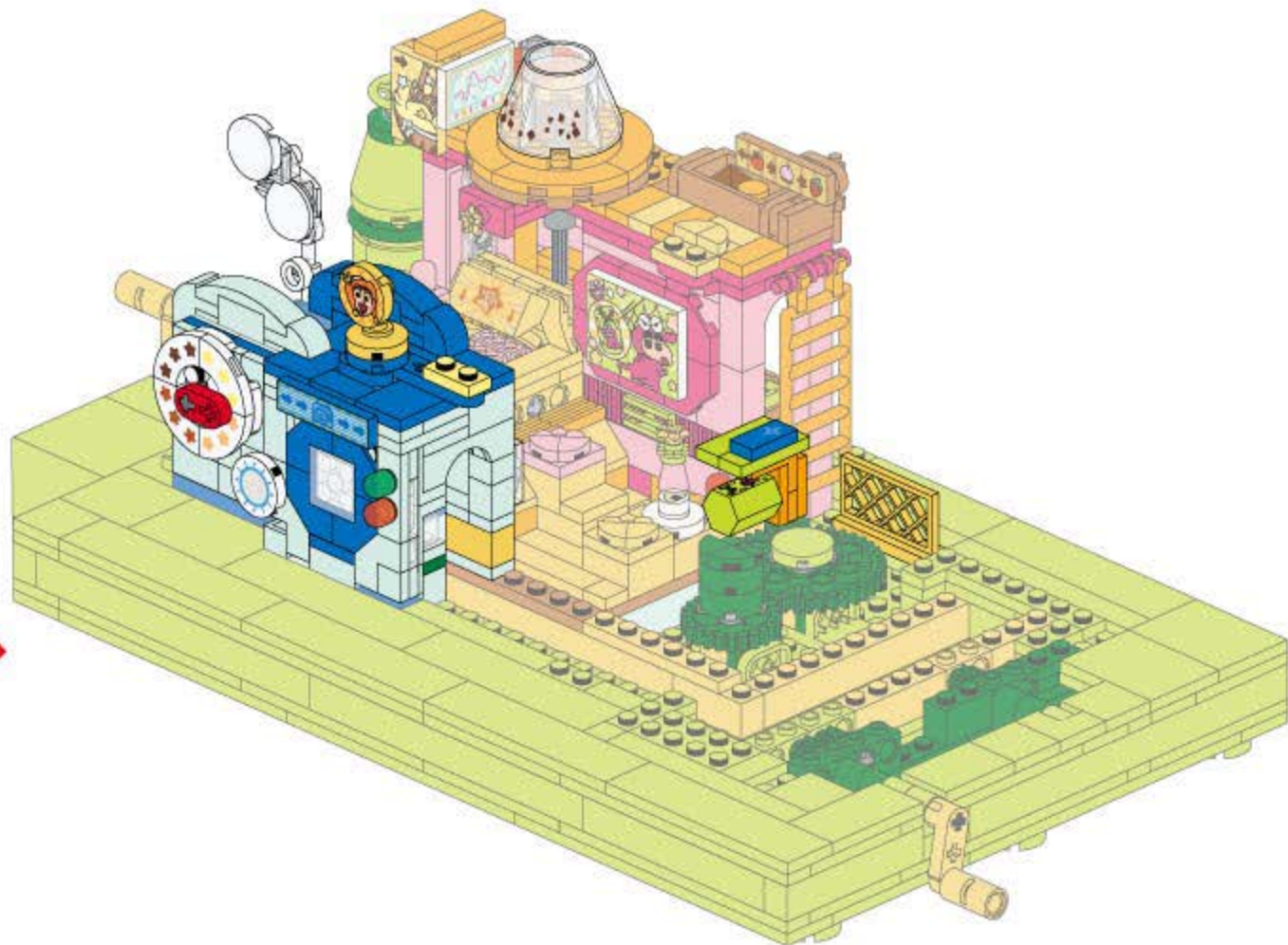



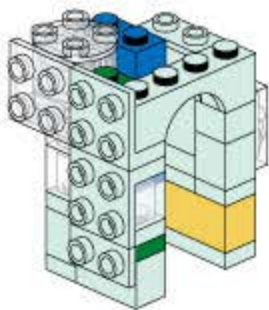

B127

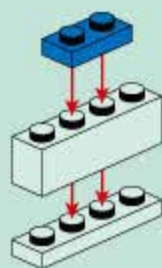
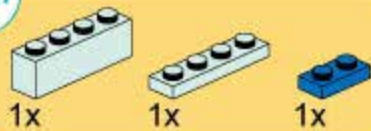

B128

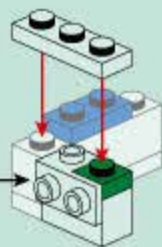
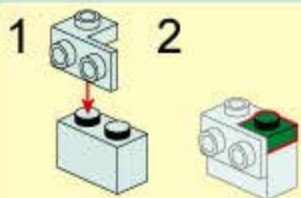
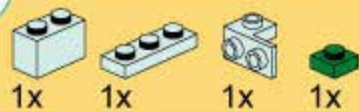

B129

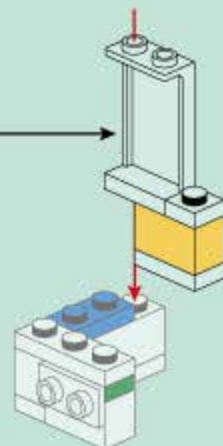
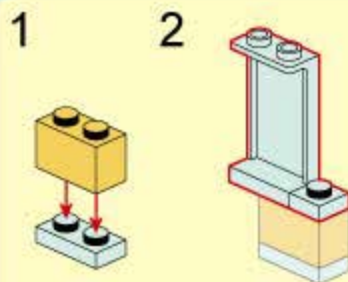
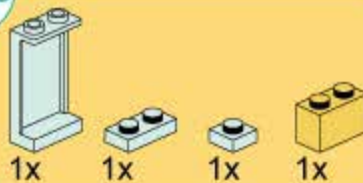

B130

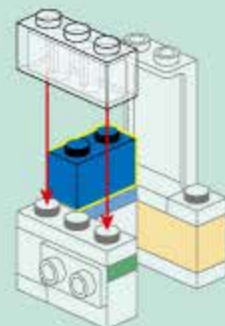
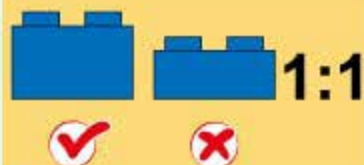

B131

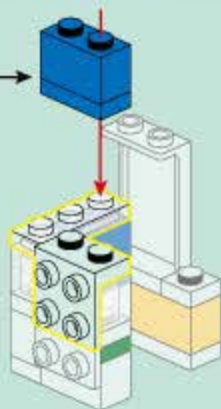
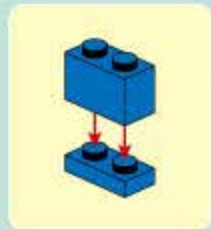
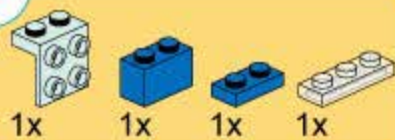

B132

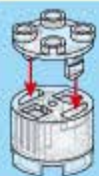
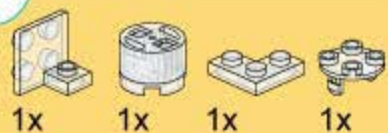

温馨提示：组装完成后，请扭动一下以确保灯光件正常发光。

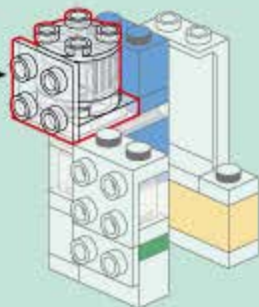
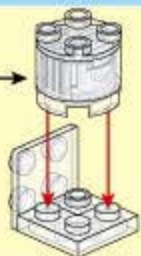

B133

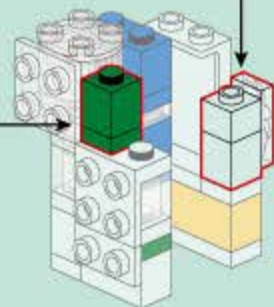
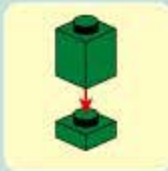
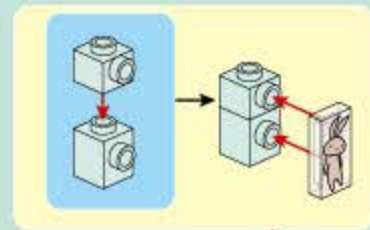
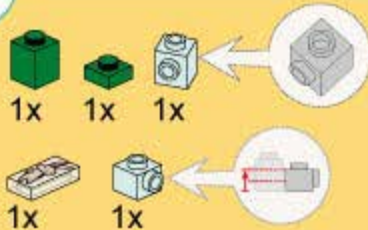

B134

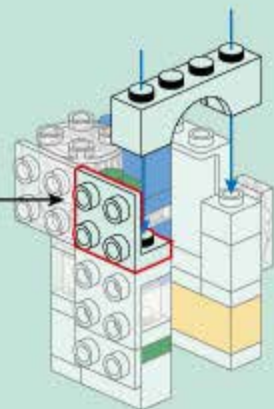

B135

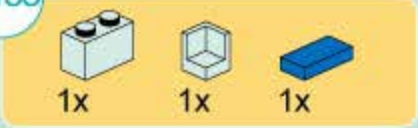

B134

B126

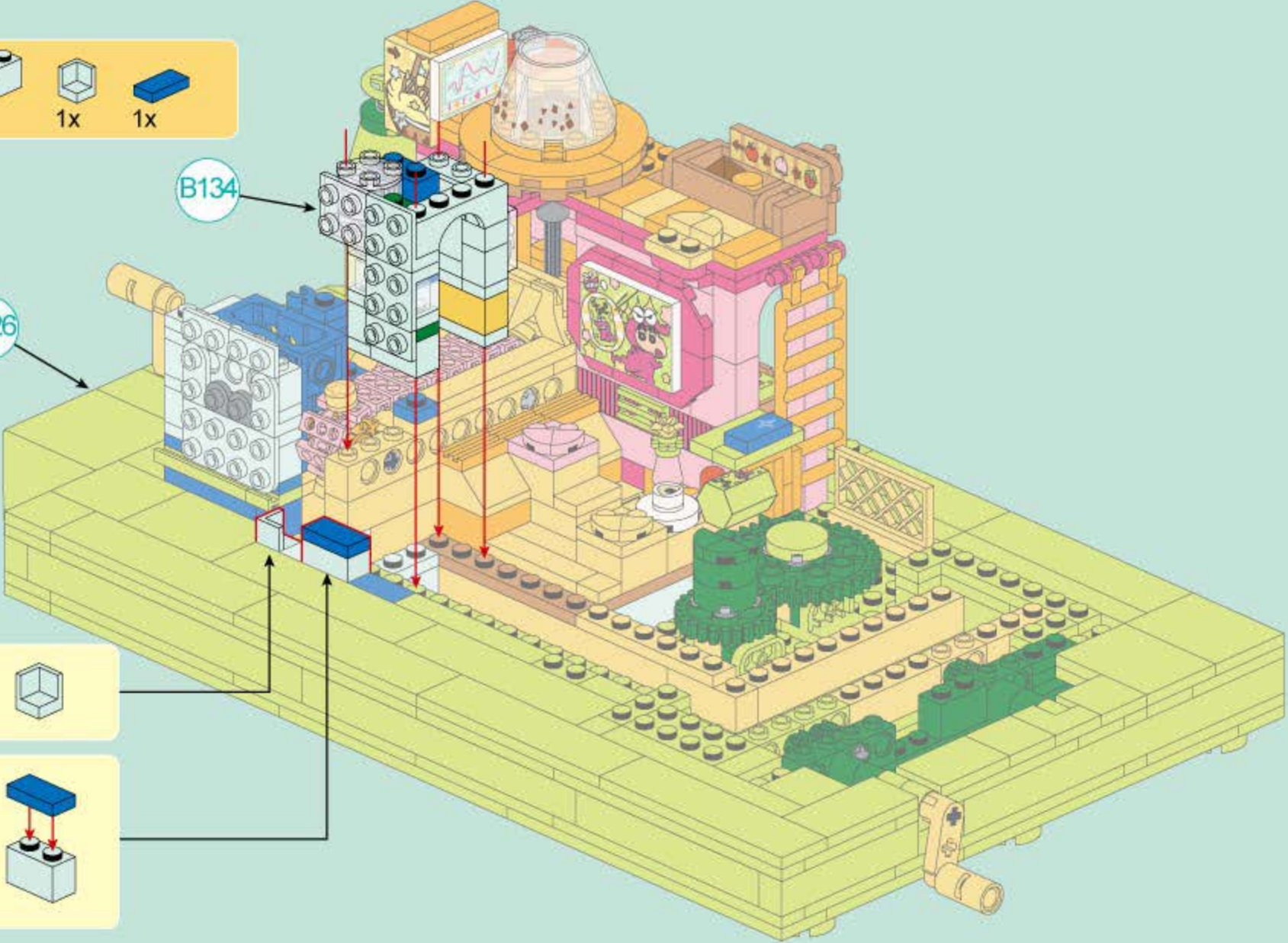

B136

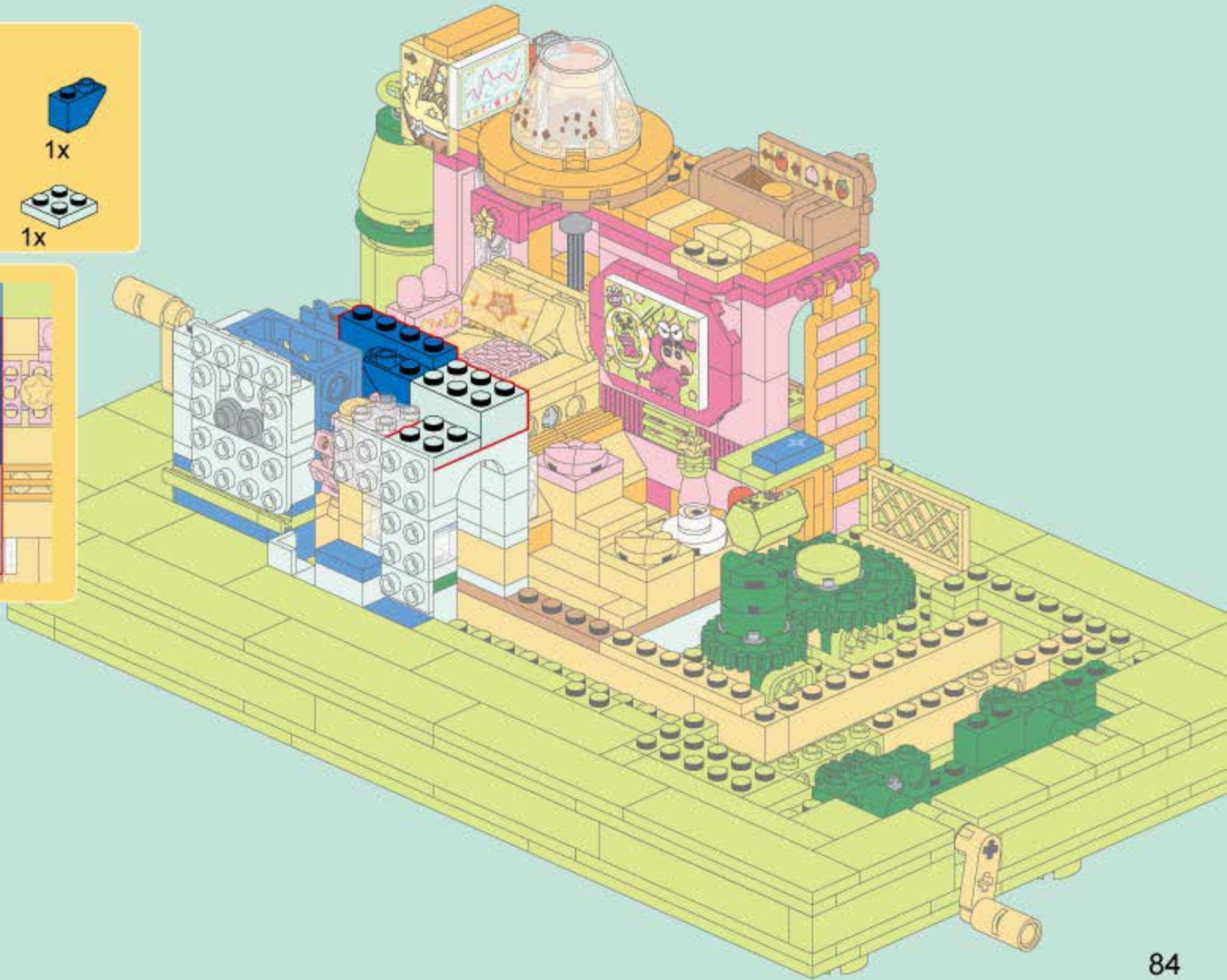
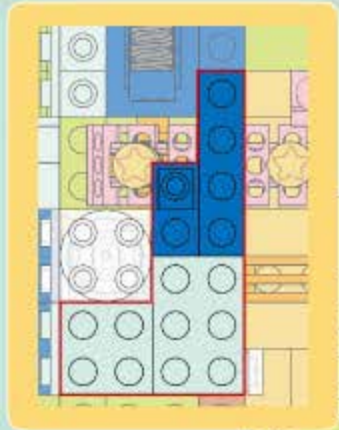
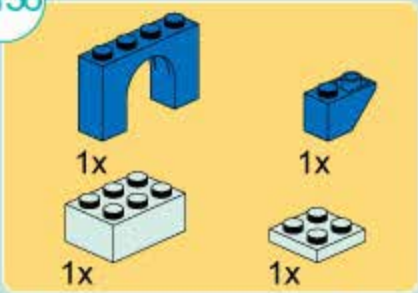

B137

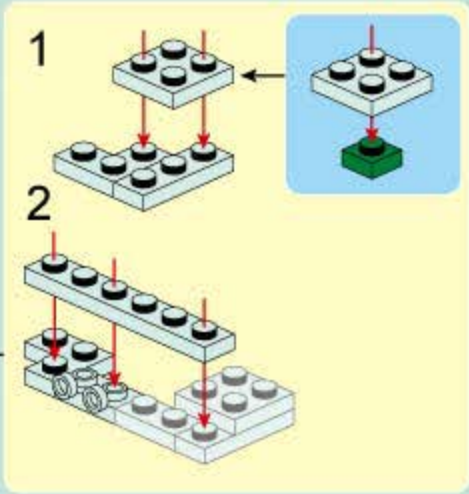
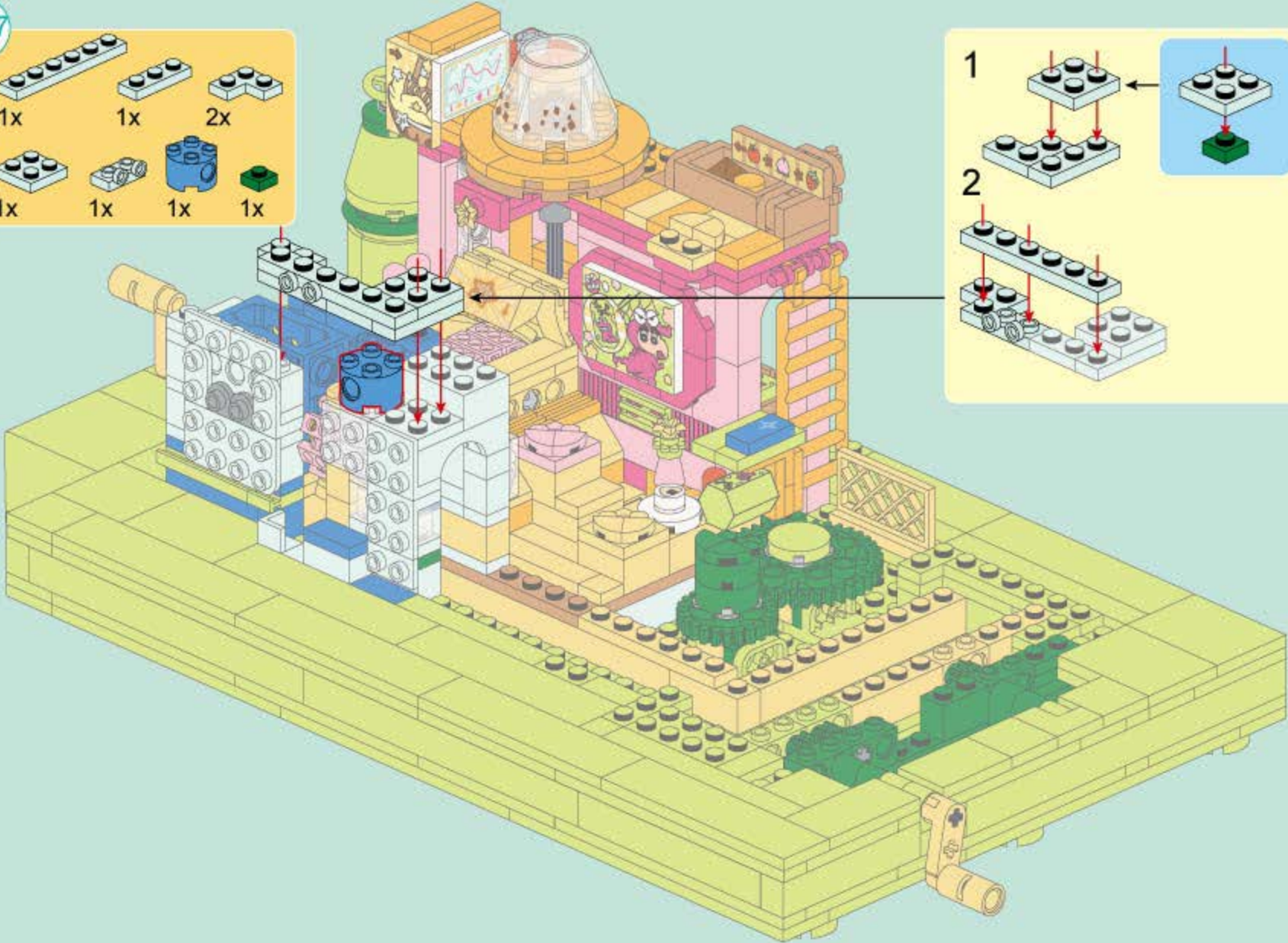
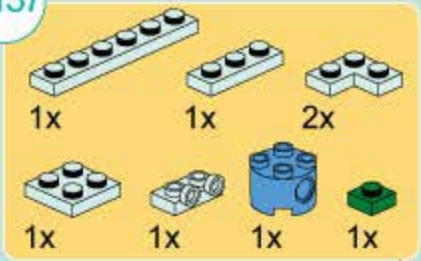

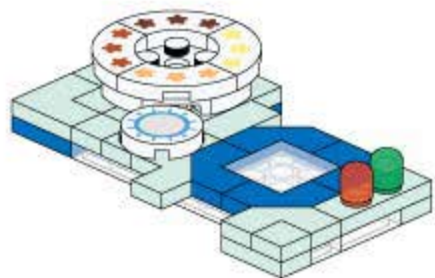

B138

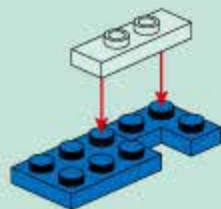
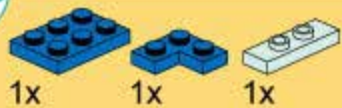

B139

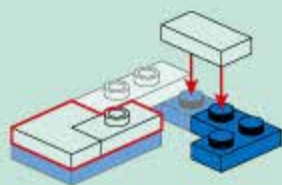

B140

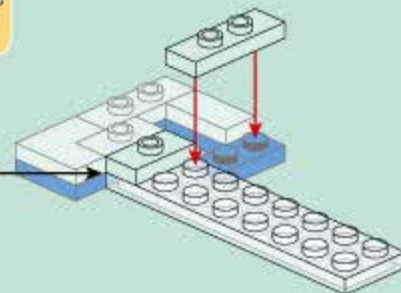
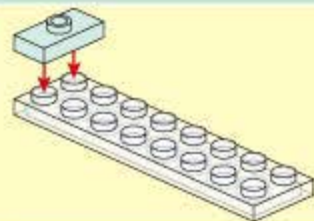
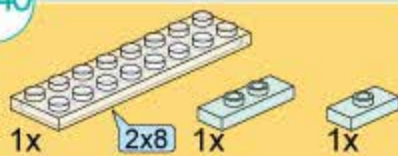

B141

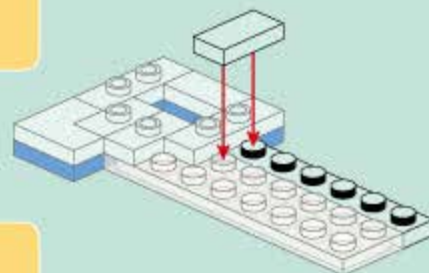
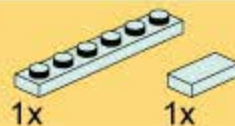

B142

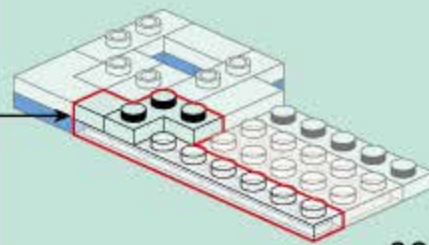
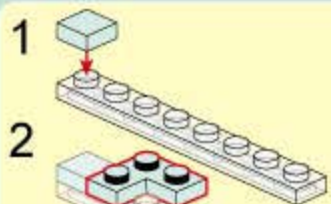
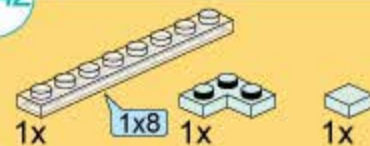

B143

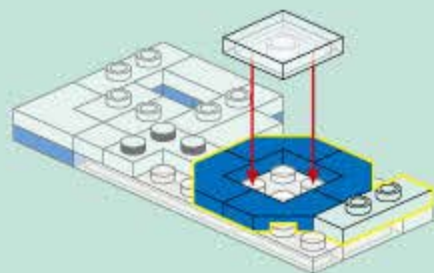

B144

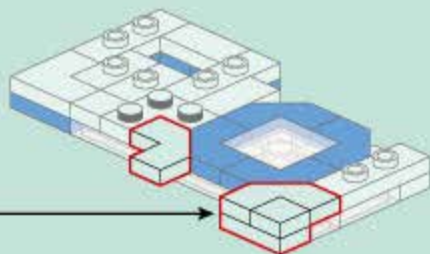
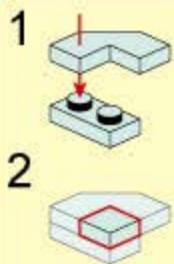

B145

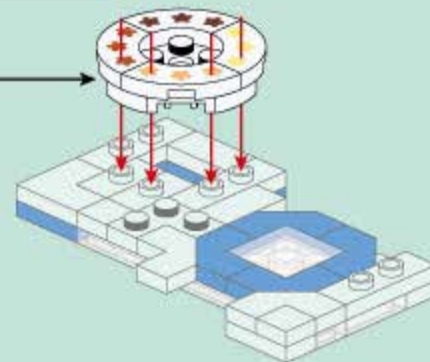
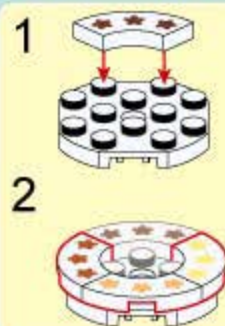
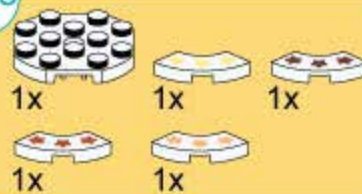

B146



B147

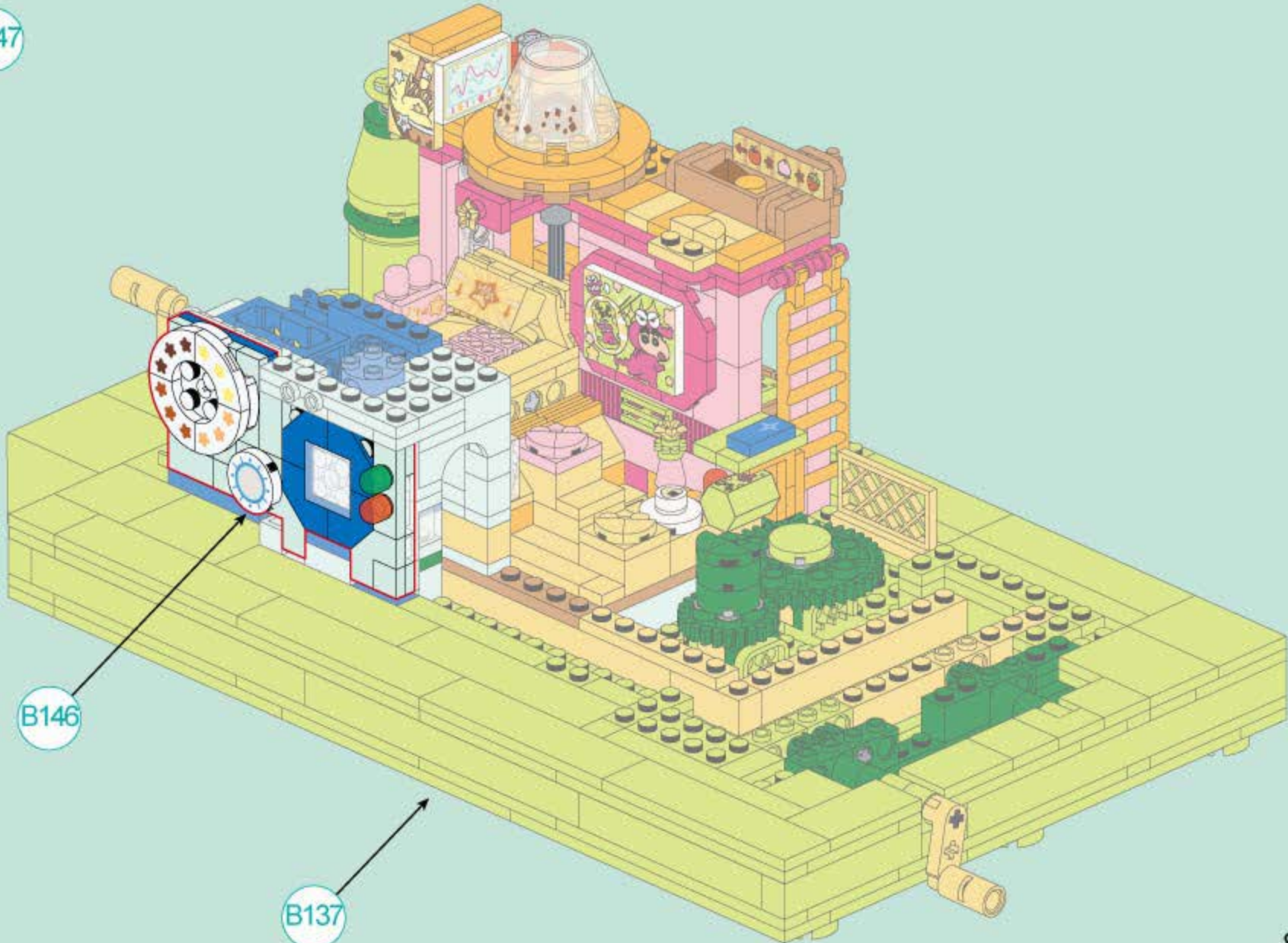

B146

B137

B148

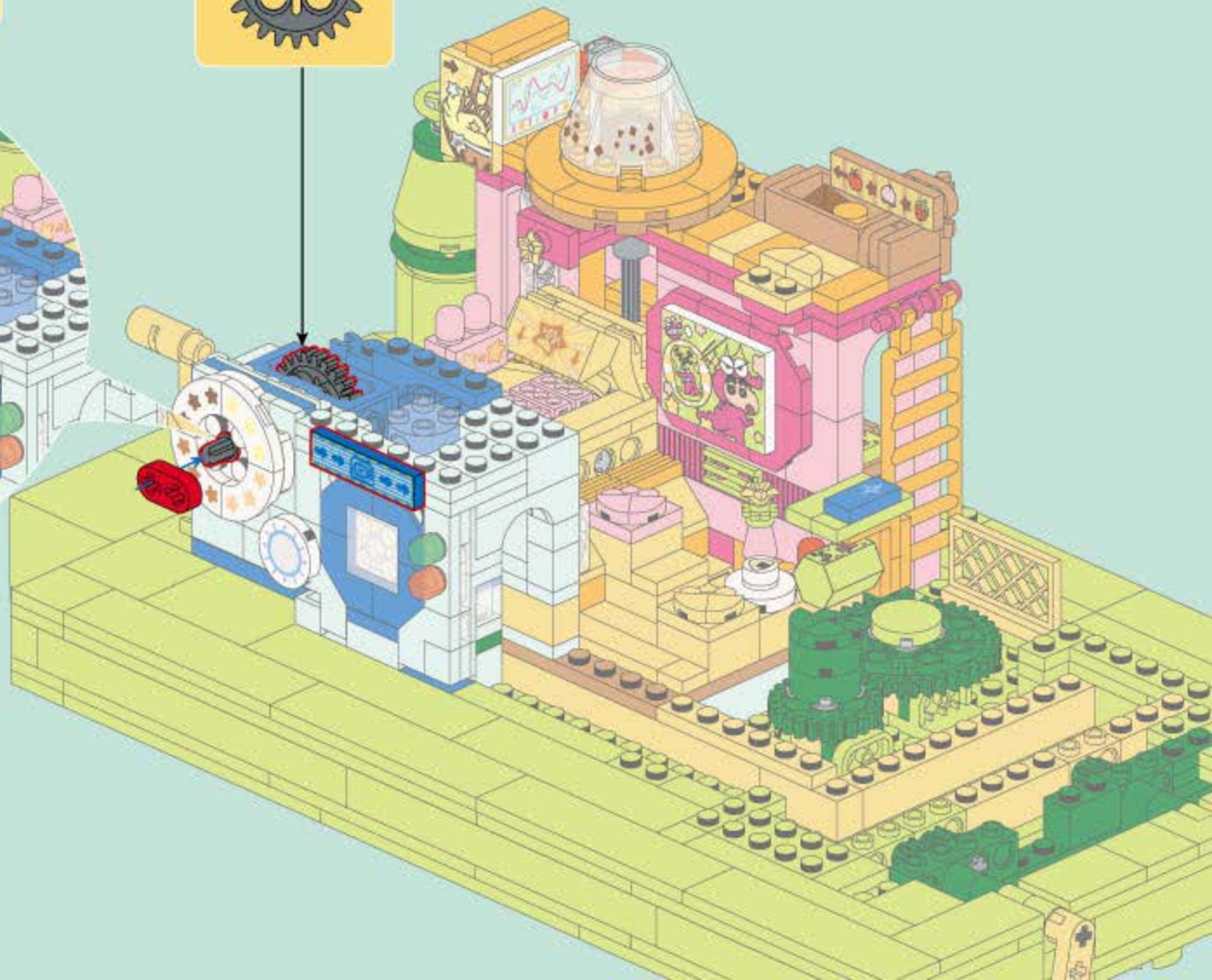
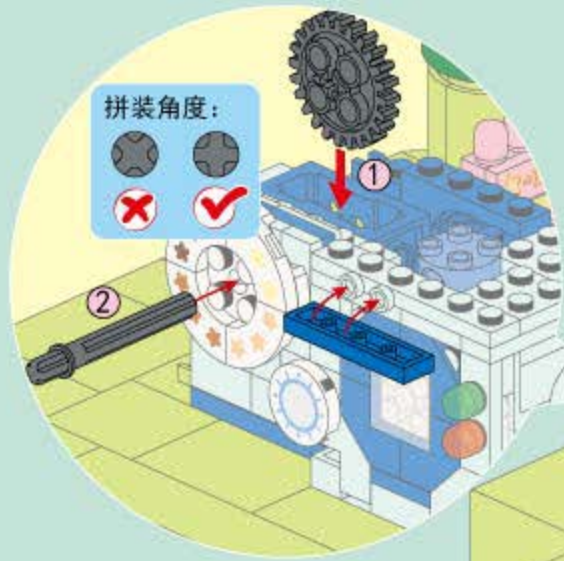
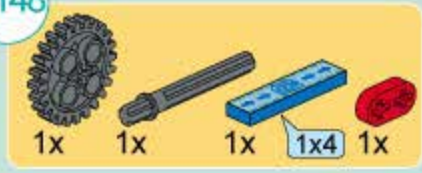

B149

1x 2x 1x

1x

1:1

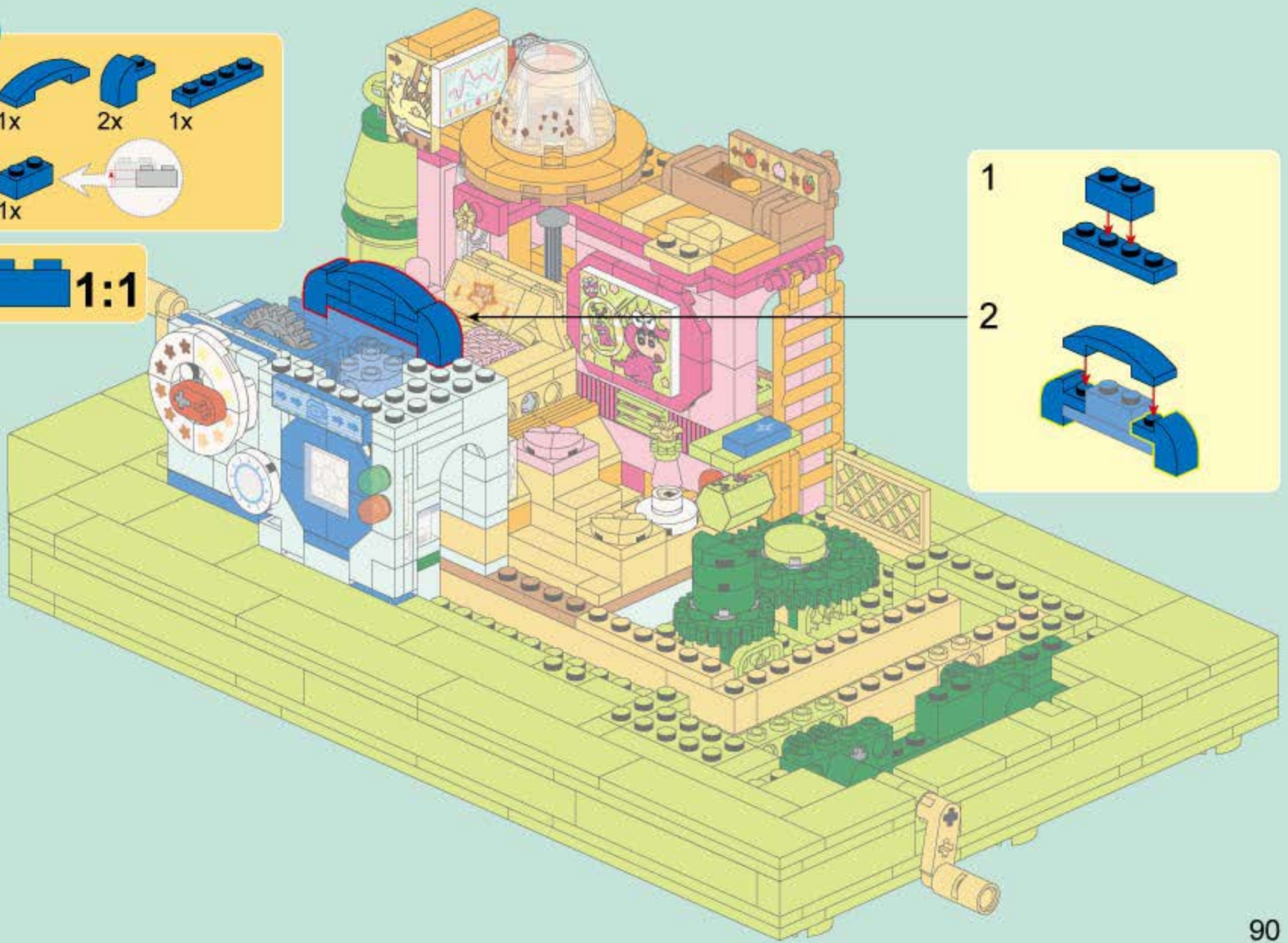

1

2

B150

- 1x 1x4
- 1x 2x3
- 1x 1x2
- 1x 1x3
- 2x 1x2
- 1x 1x2

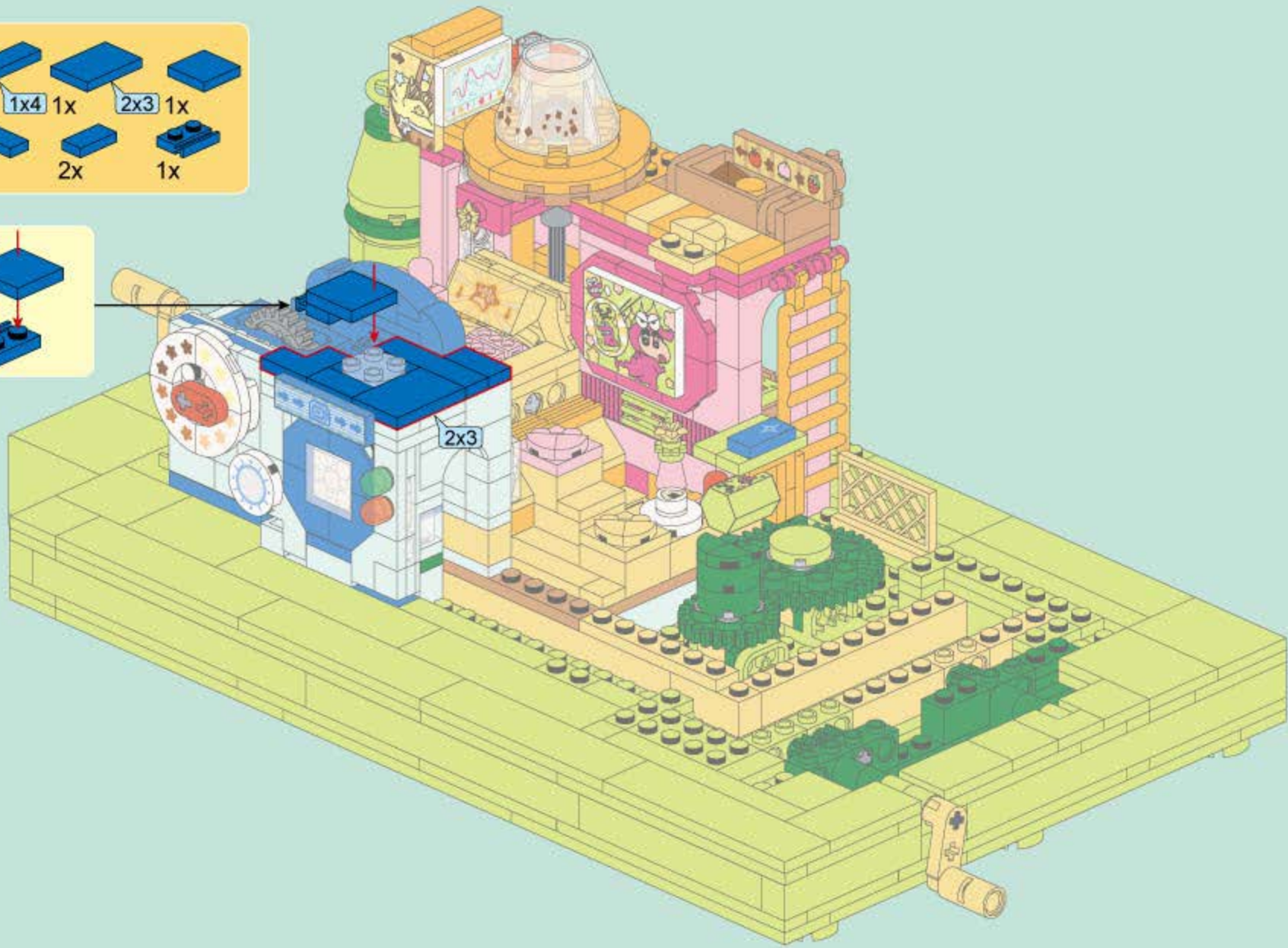
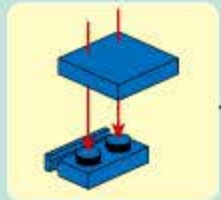

B151

- 1x
- 1x
- 1x
- 2x
- 2x

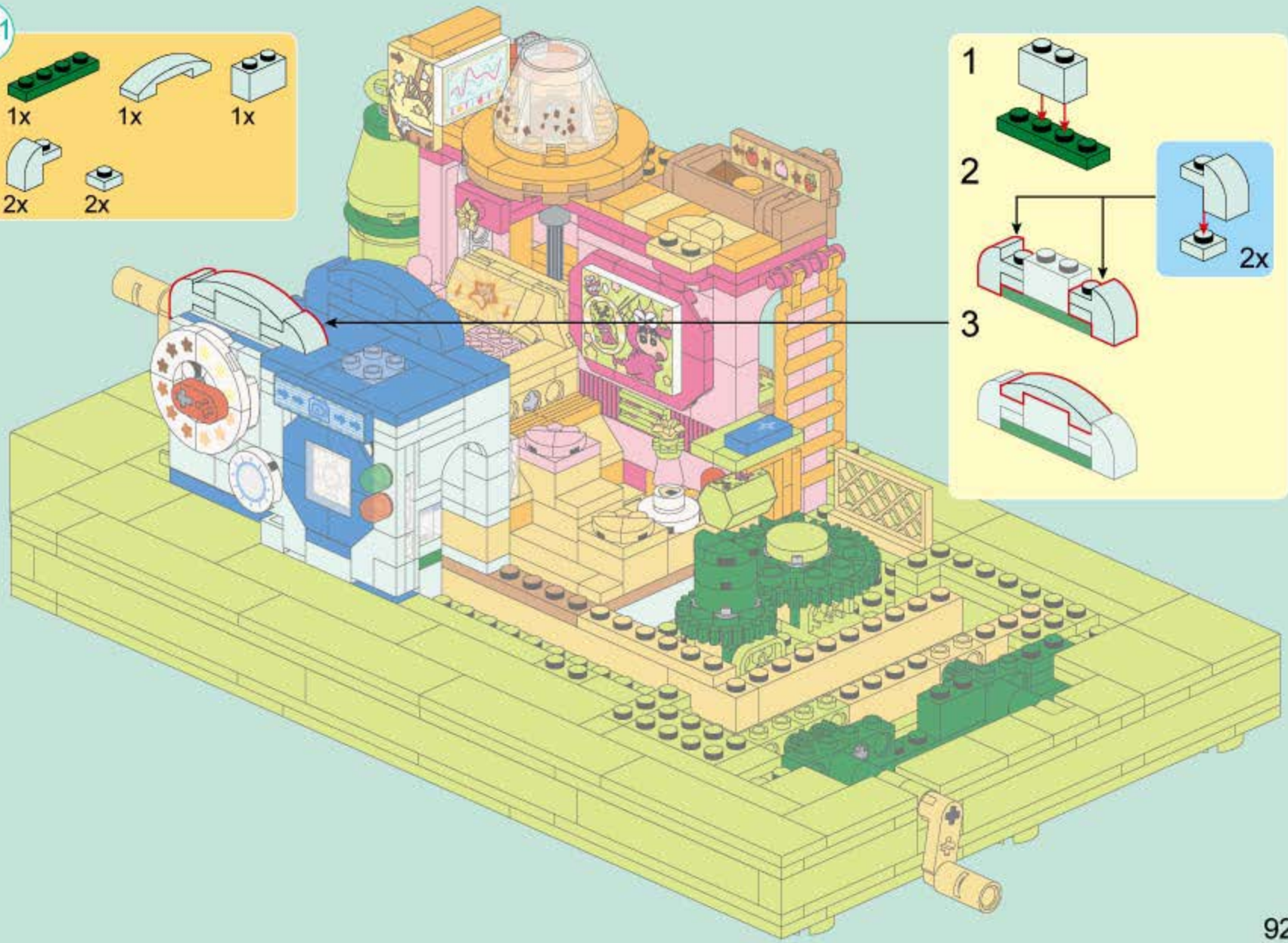

- 1
- 2
- 3

B152

- 1x [Blue 1x3 Technic Beam]
- 1x [Blue 1x1 Technic Pin]
- 1x [Blue 1x2 Technic Pin]
- 1x [Blue 1x1 Technic Pin]
- 1x [Yellow 1x1 Technic Pin]
- 1x [Yellow 1x1 Technic Pin]
- 1x [Yellow 1x1 Technic Pin]
- 2x [Yellow 1x1 Technic Pin]

- 1 [Blue 1x3 Technic Beam] with [Blue 1x2 Technic Pin] and [Blue 1x1 Technic Pin] attached.
- 2 [Yellow 1x1 Technic Pin] being inserted into the [Blue 1x3 Technic Beam] assembly.
- 3 [Yellow 1x1 Technic Pin] being inserted into the [Yellow 1x1 Technic Pin] from step 2.

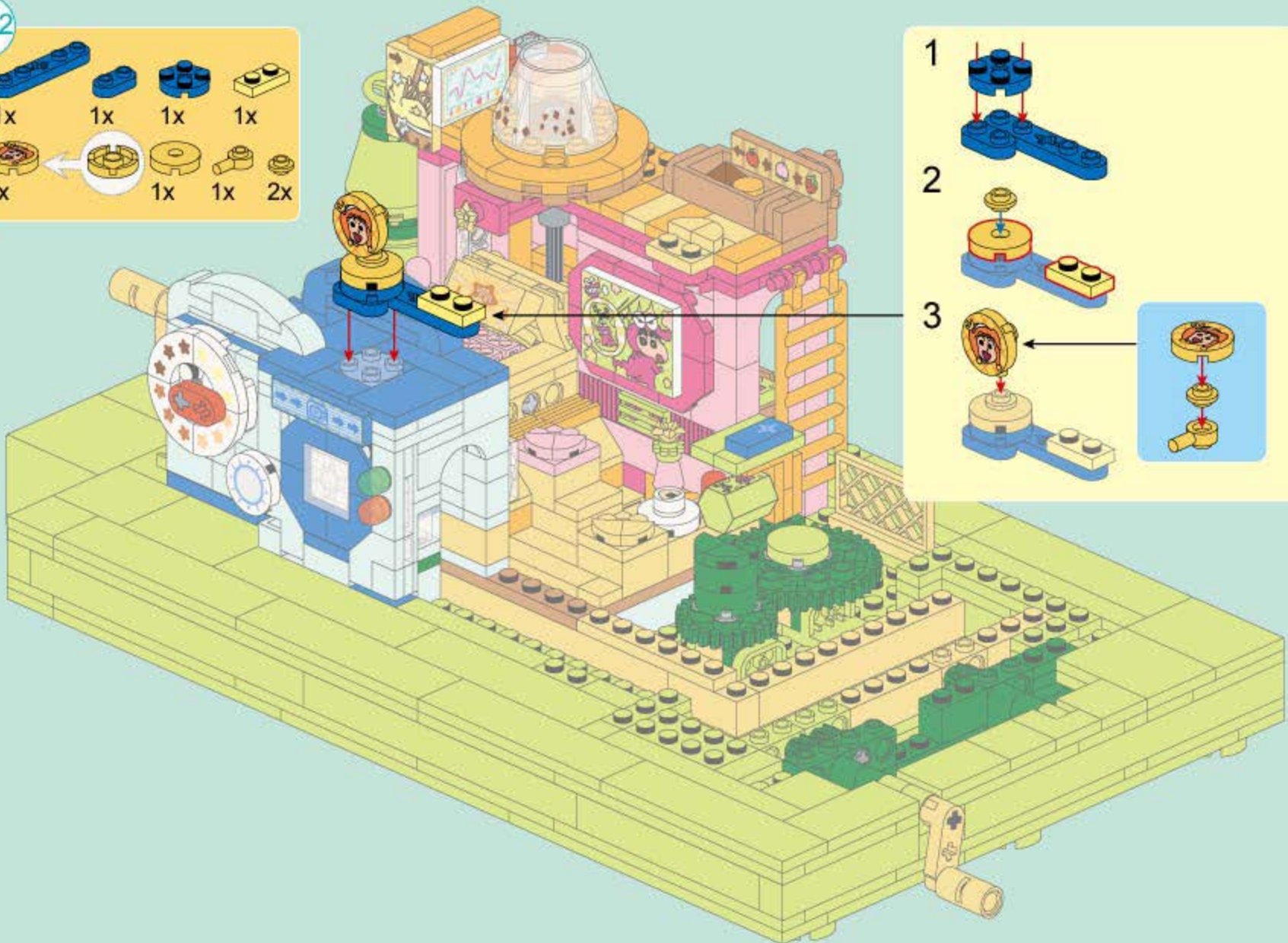

B153

- 1x 4
- 1x
- 1x
- 1x
- 1x
- 1x
- 1x
- 1x

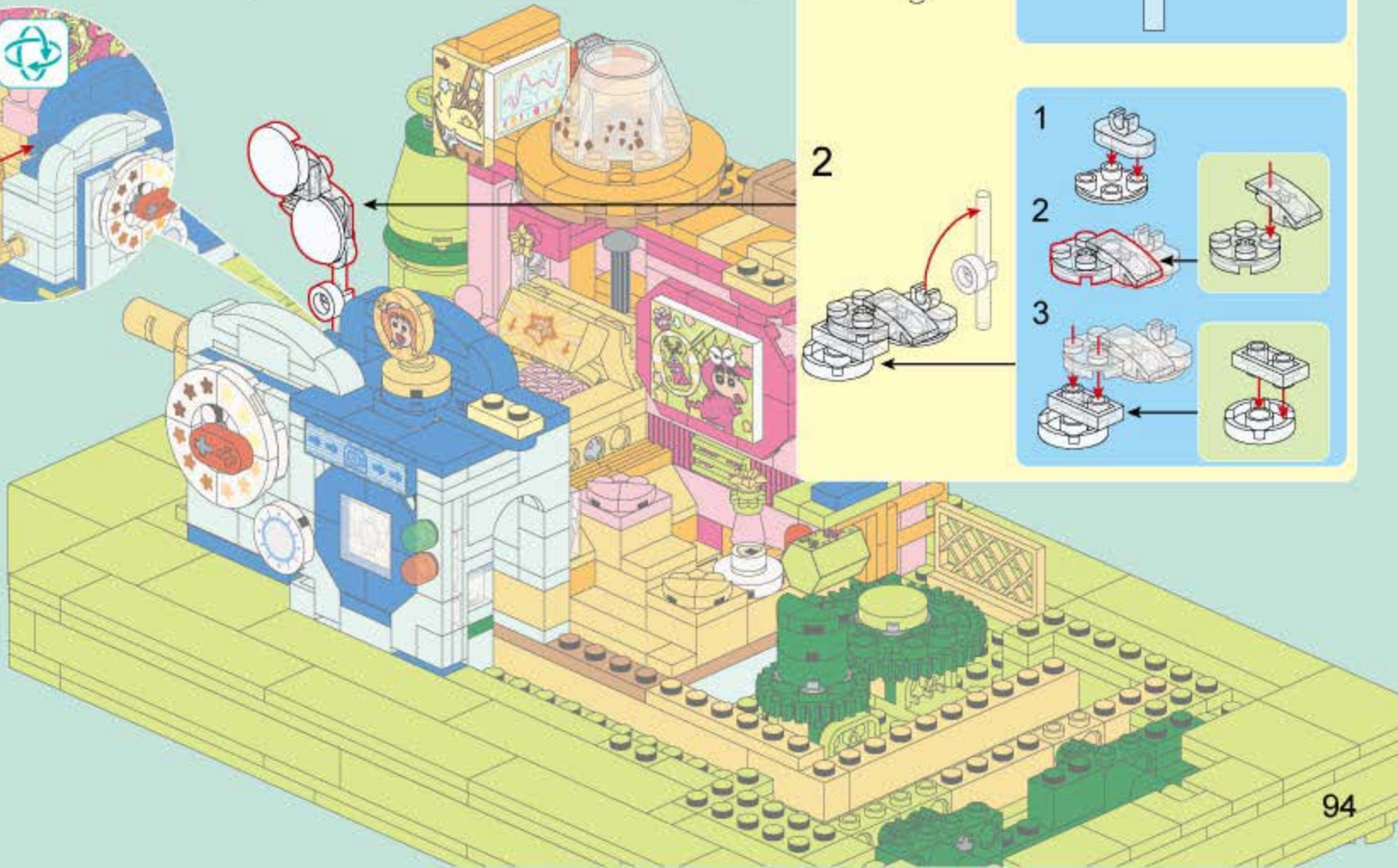
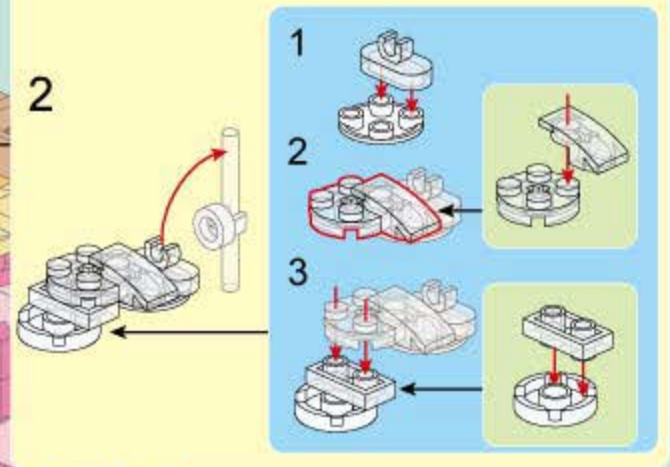
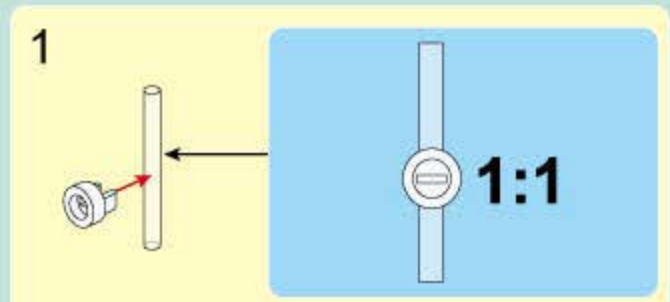
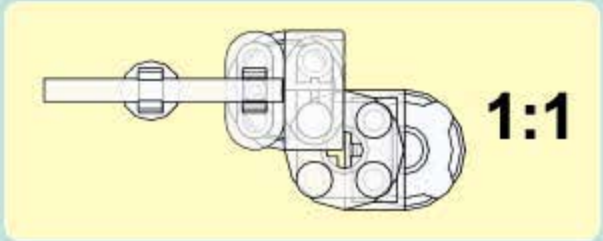

23x

28x

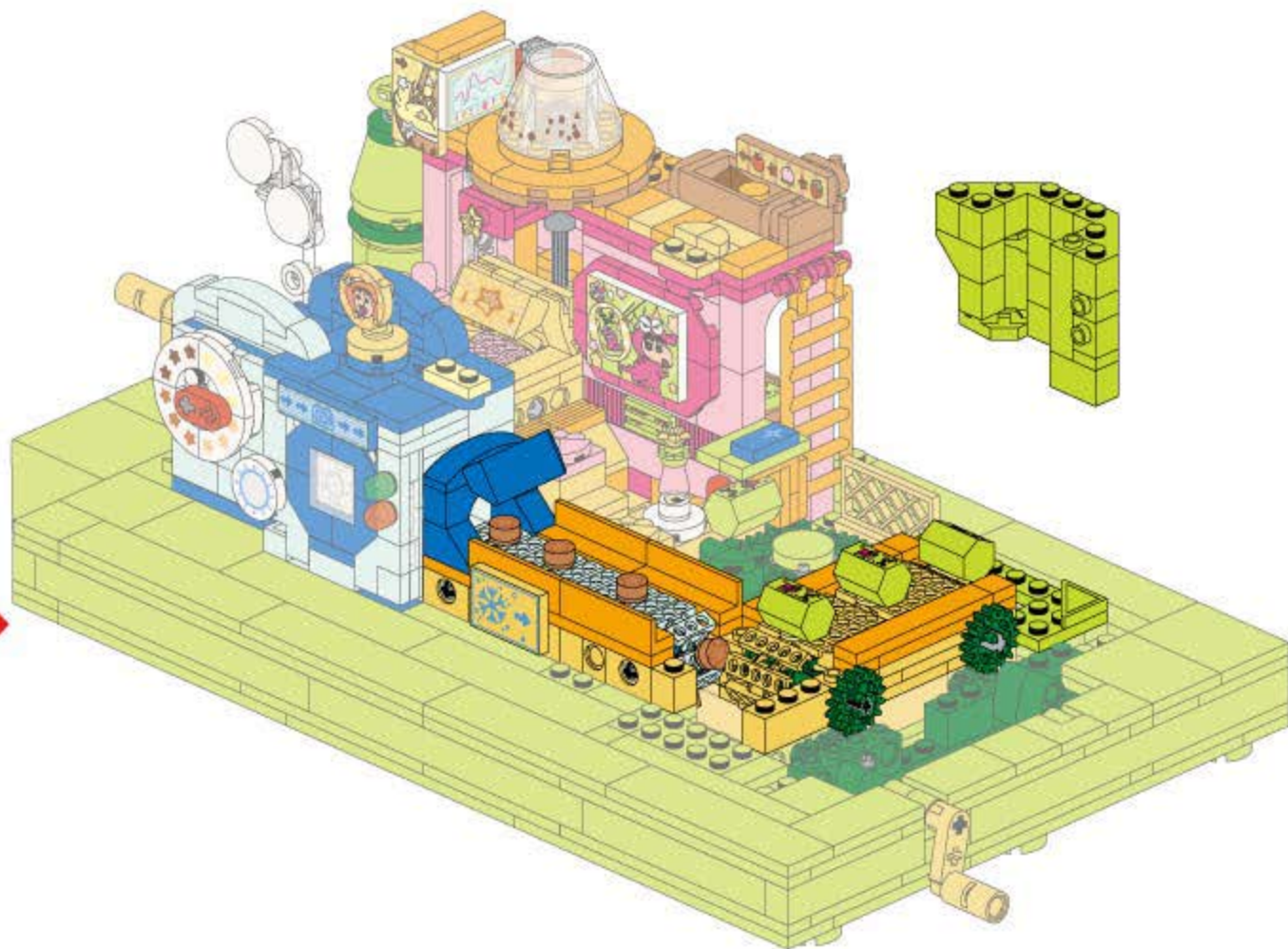

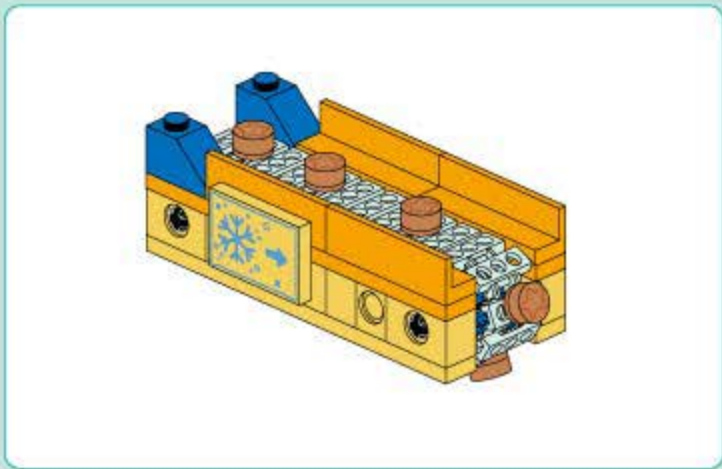

B154

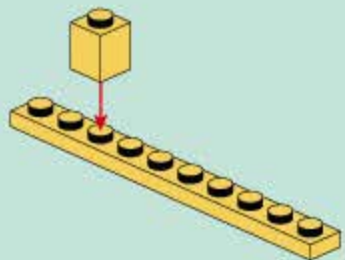
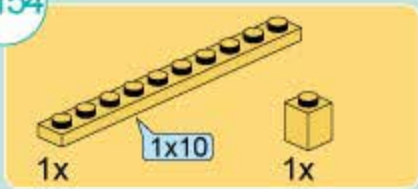

B155

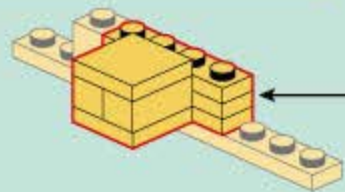
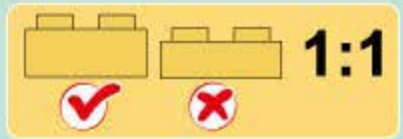
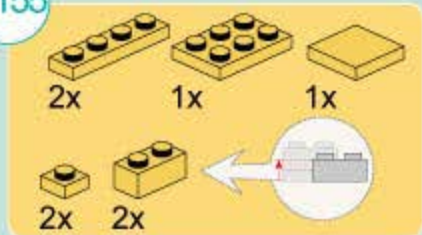

B156

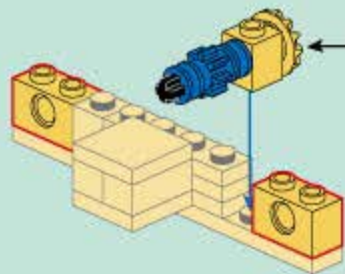
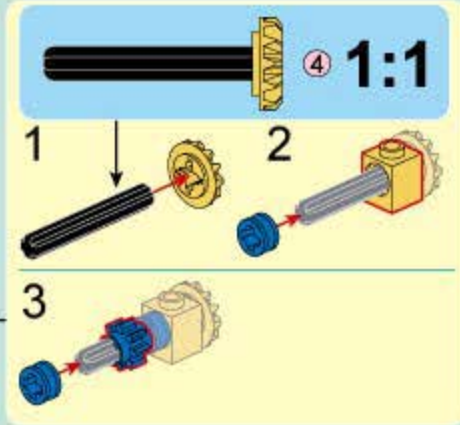
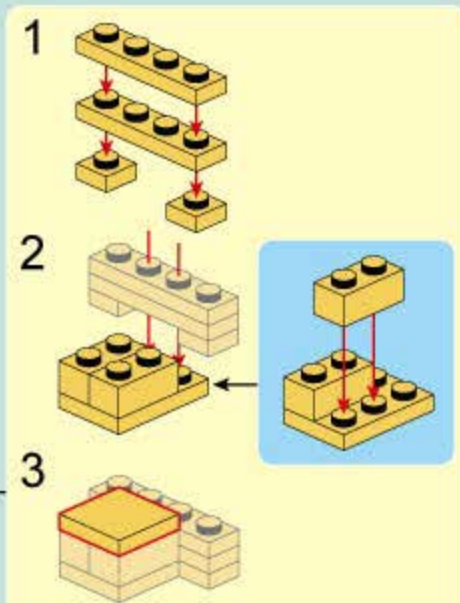
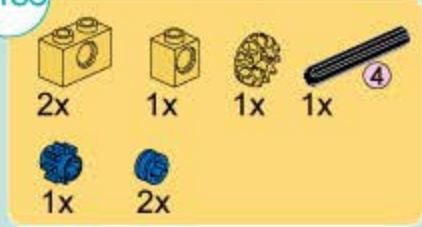

B157

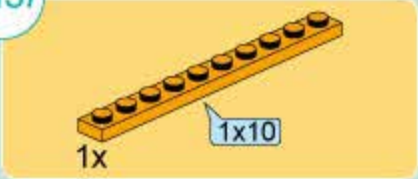

B158

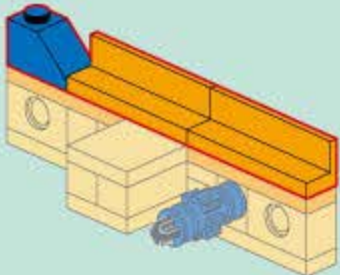

B159

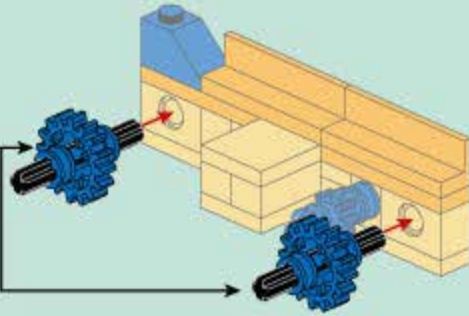
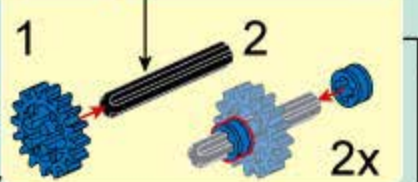
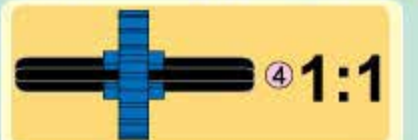
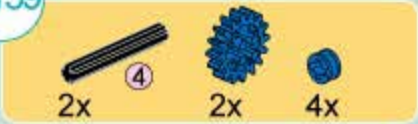

B160

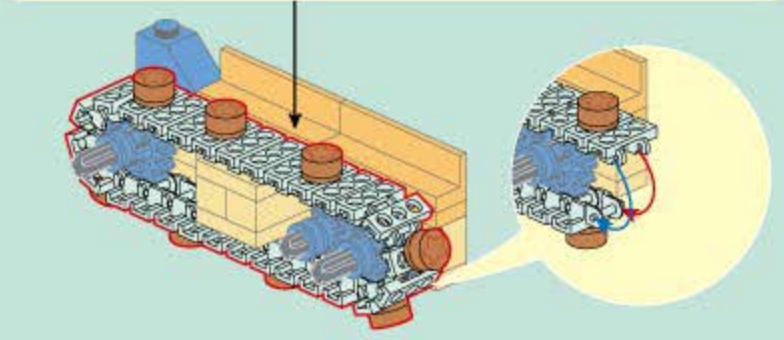
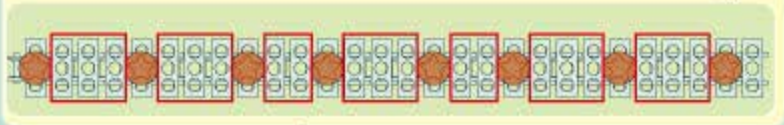
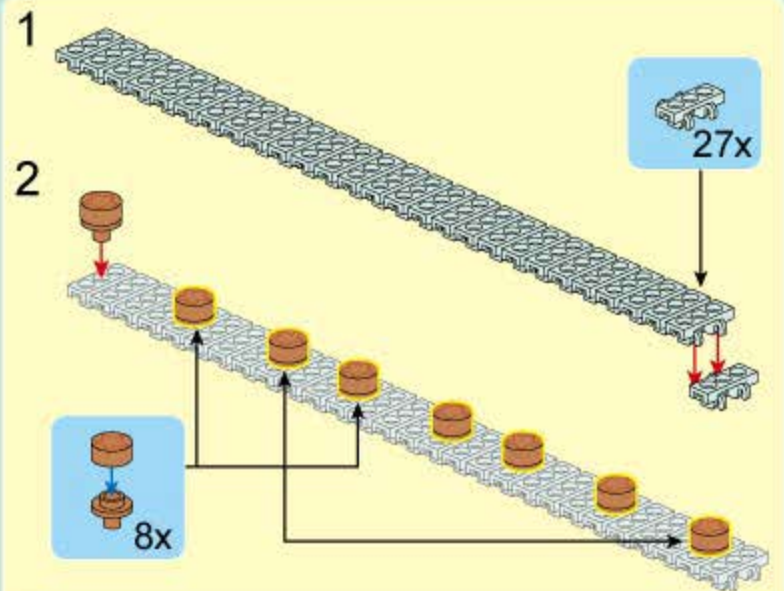

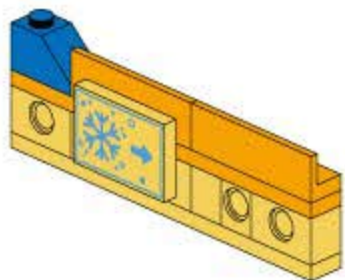

B161

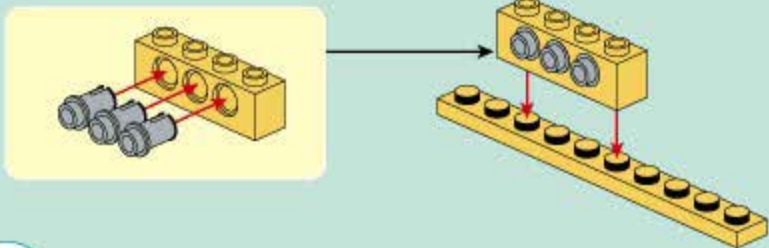
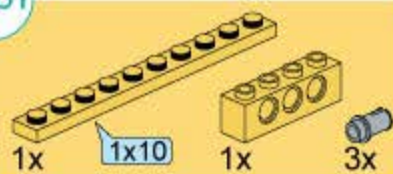

B162

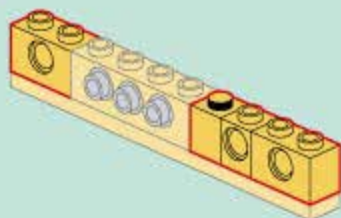
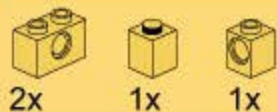

B163

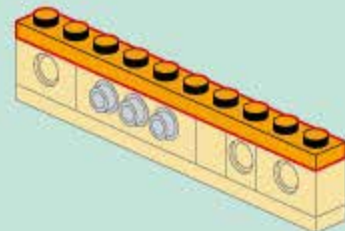
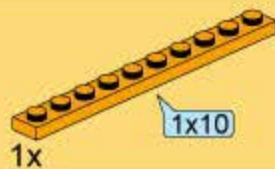

B164

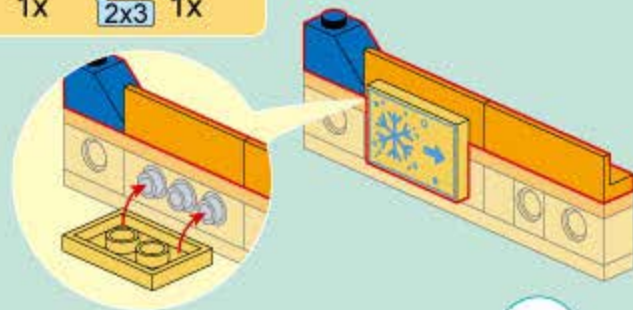

B165

B164

B160

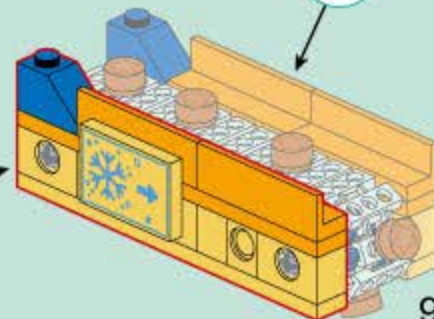

B166

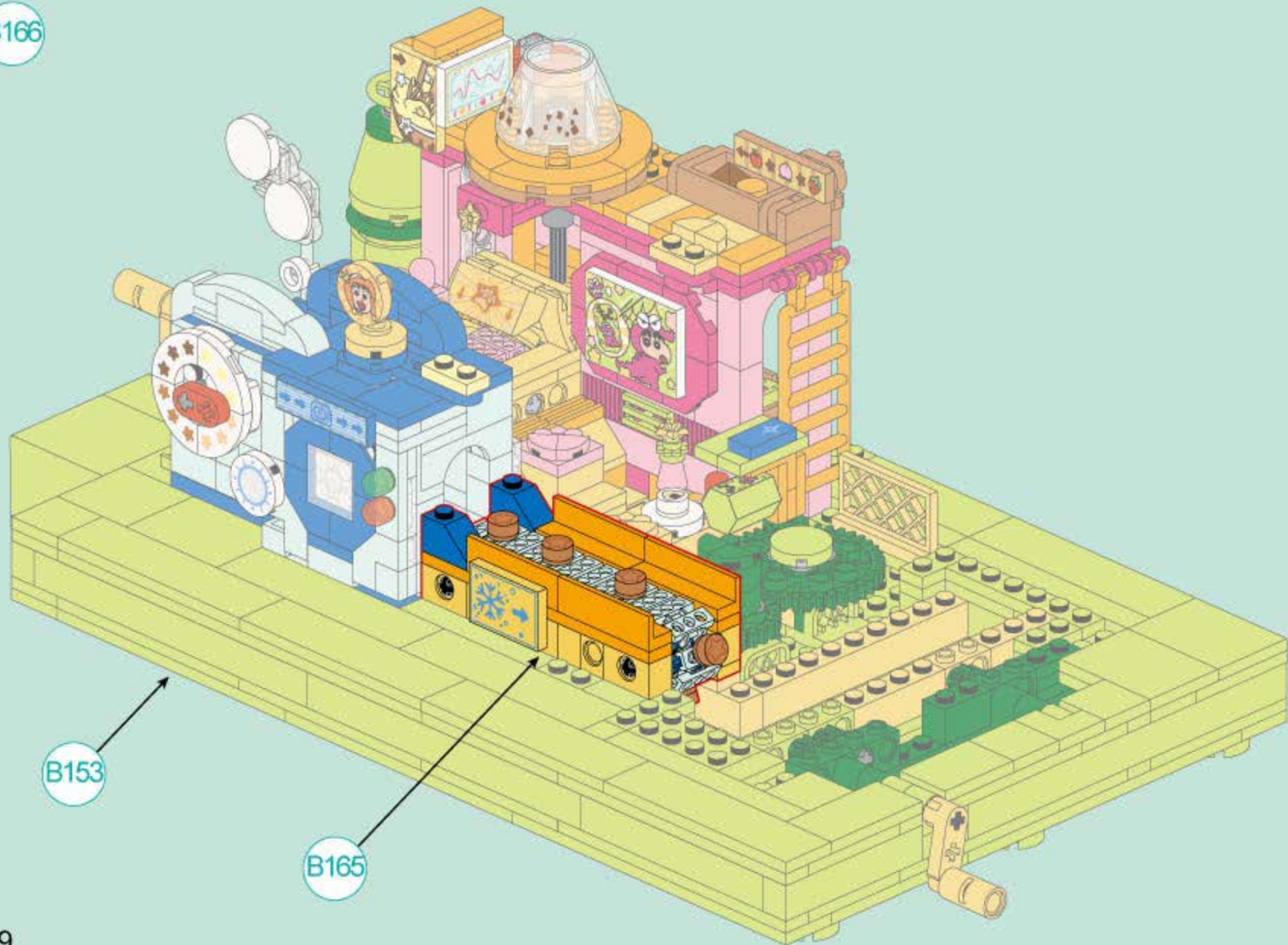

B153

B165

B167

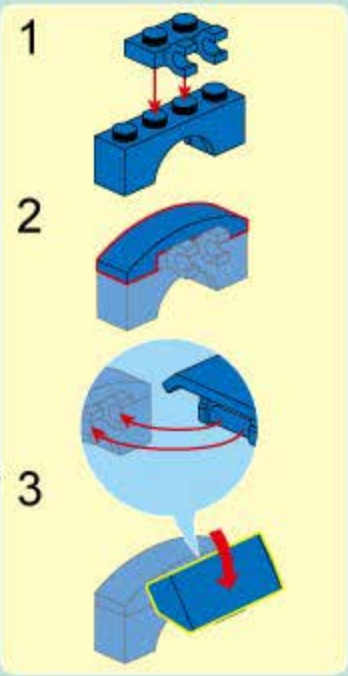
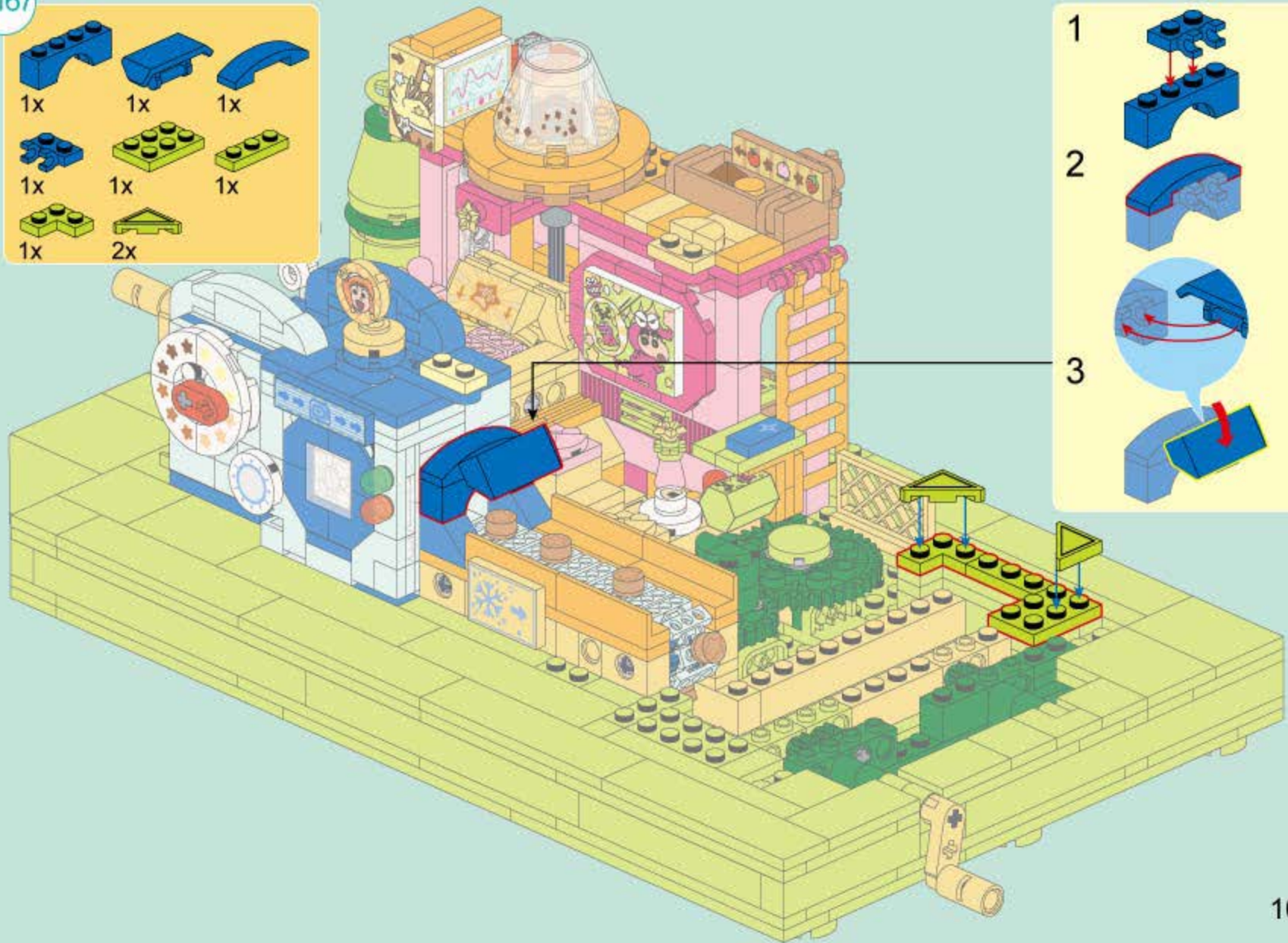
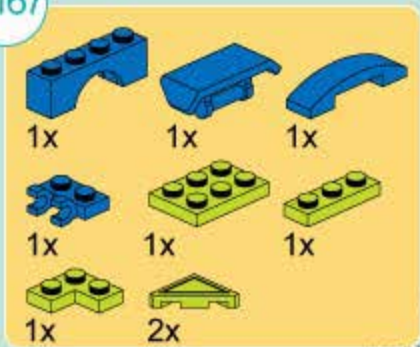

B168

2x 2x 2x

1x 1x 1x



1:1



1

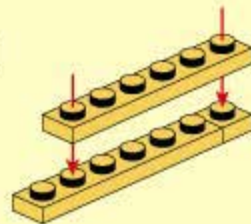

2

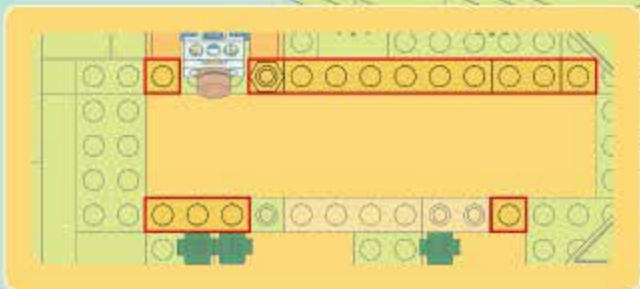
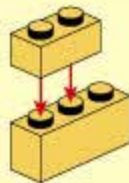
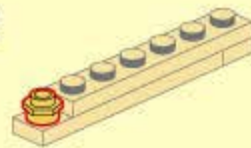

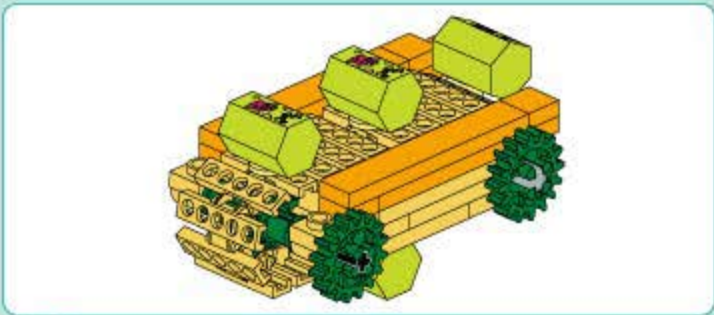

B169

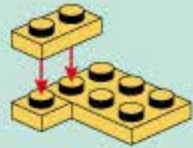
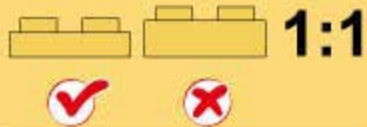
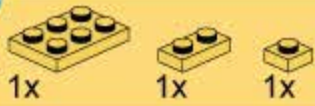

B170

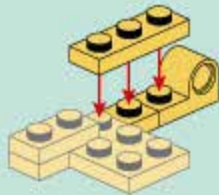

B171

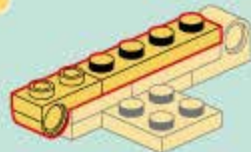
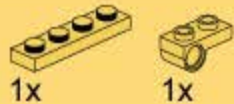

B172

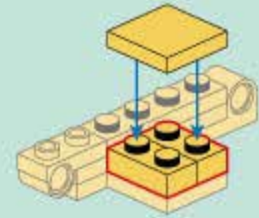

B173

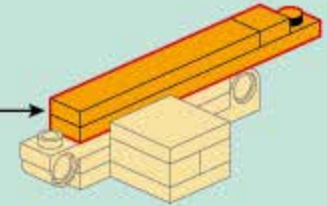
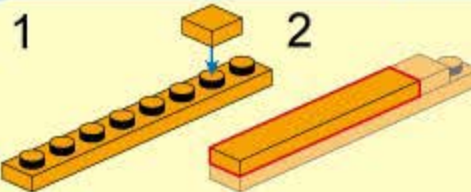
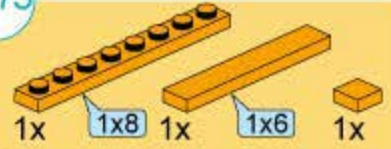

B174

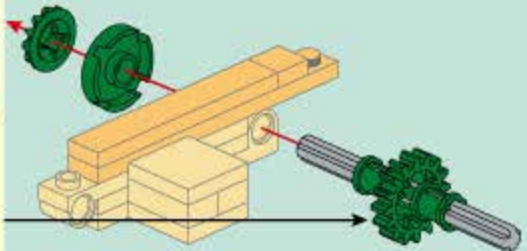
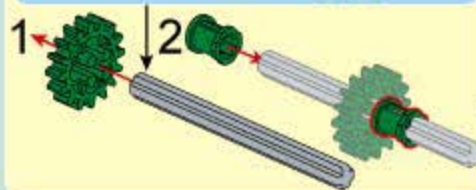
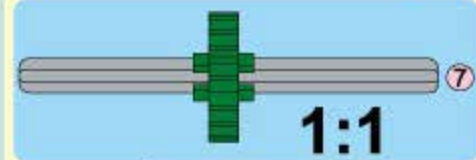
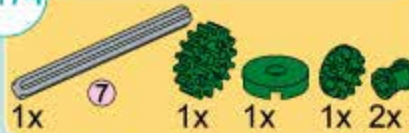

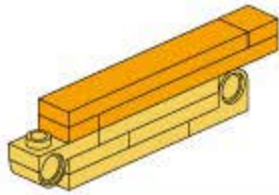

B175

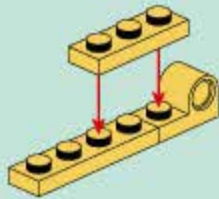
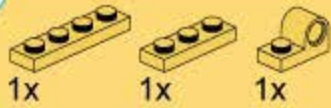

B176

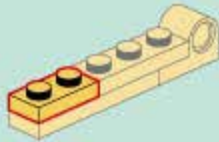

B177

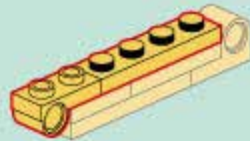

B178

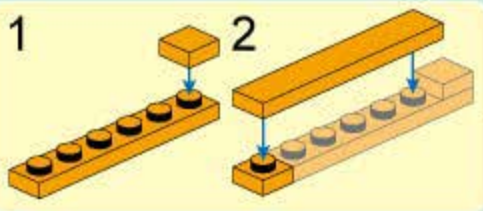
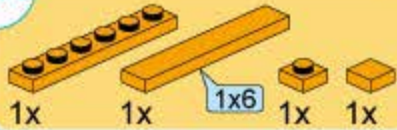

B179

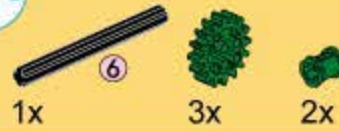

1

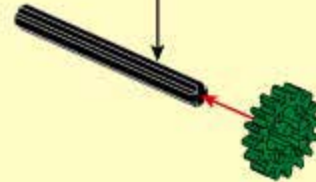

2

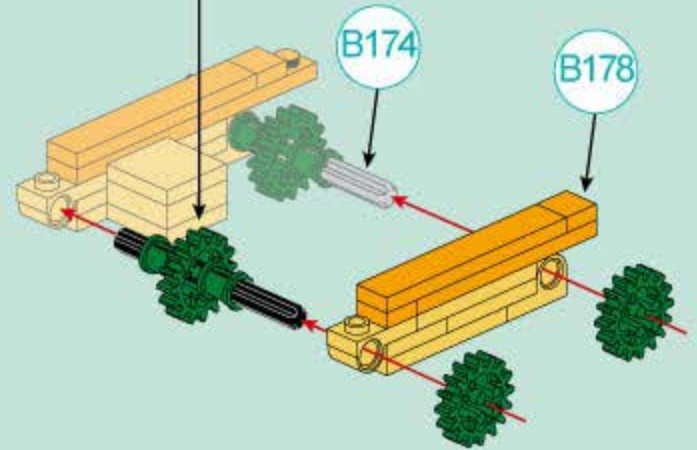
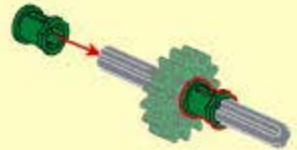

B180



5x



23x



5x

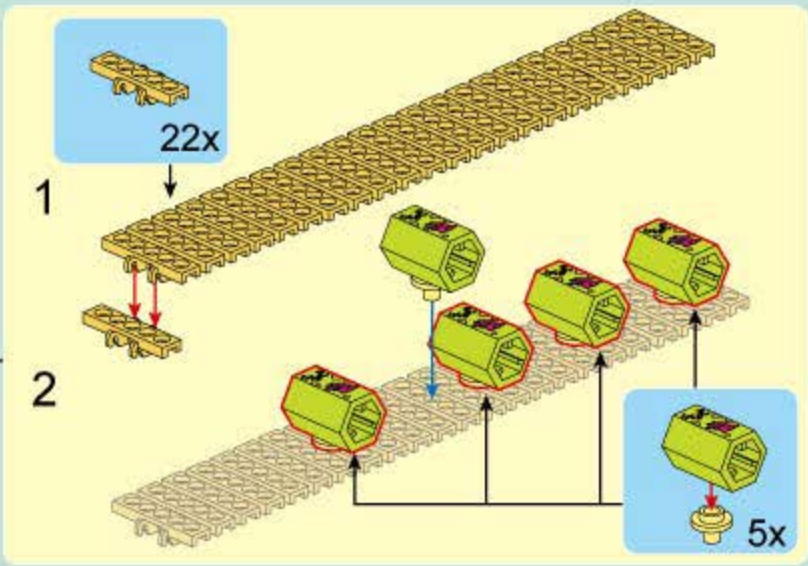
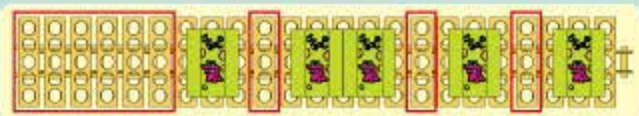

B181

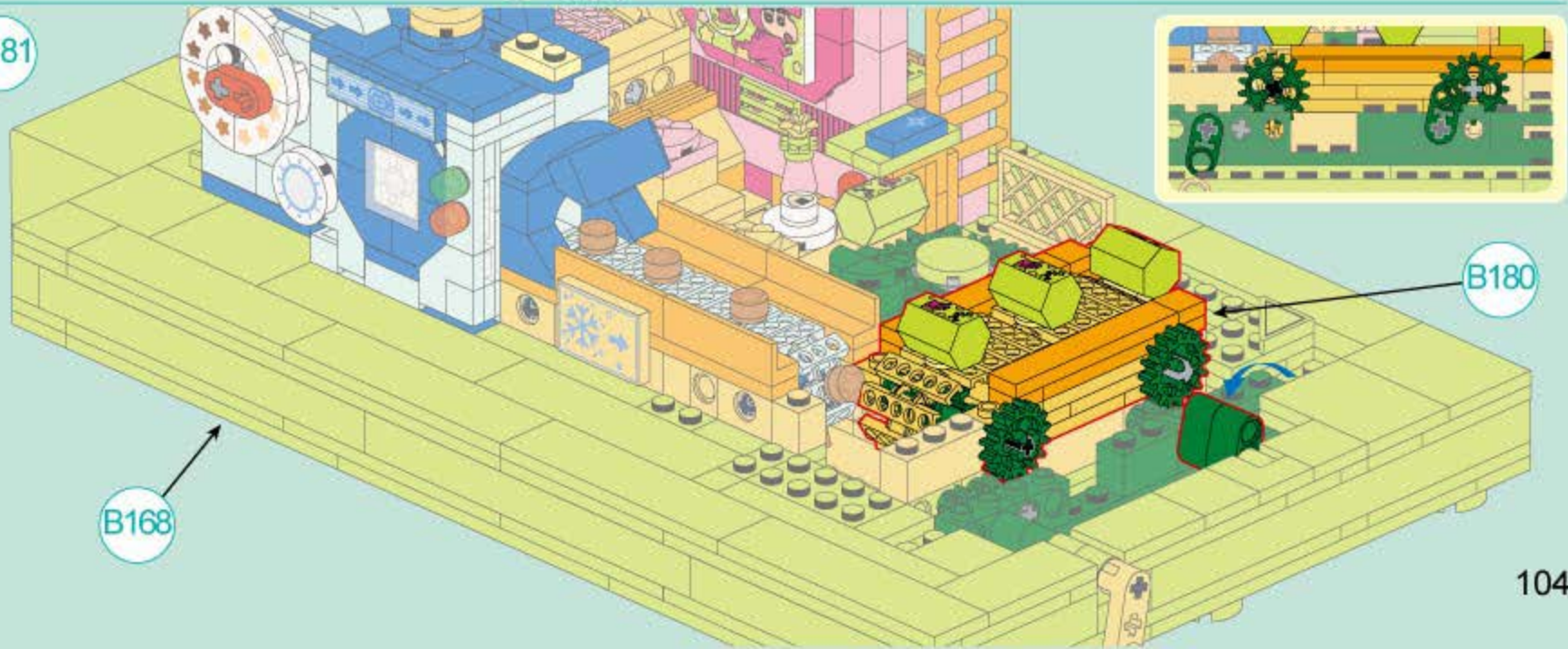

B168

B180

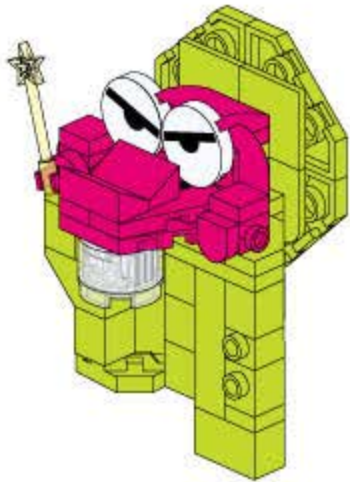

B182



1x

5x

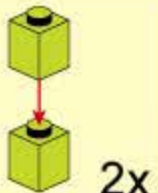

2x

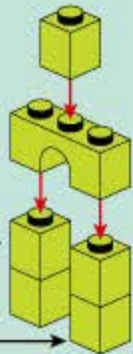

B183

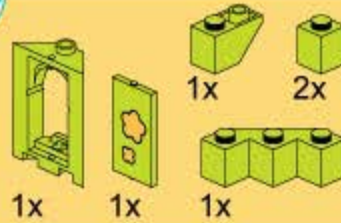

1x

1x

1x

2x

1x

1

2

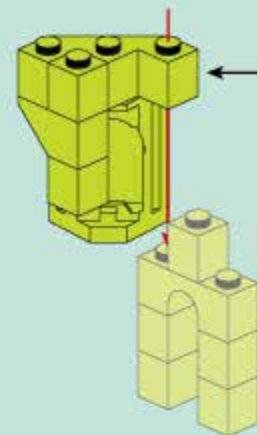
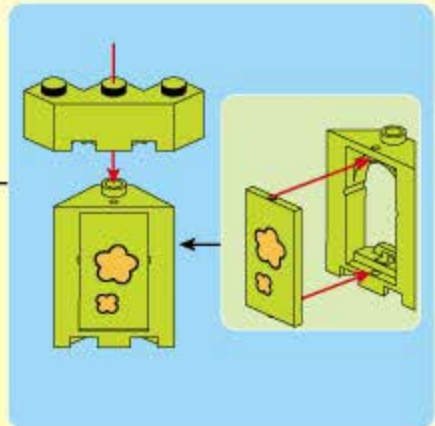
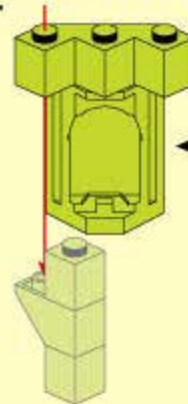

B184

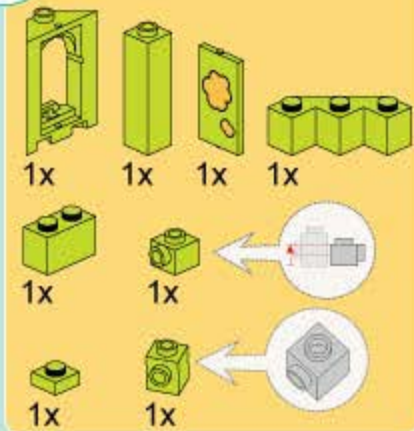

 1:1

1

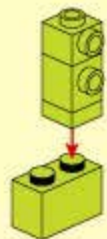

2

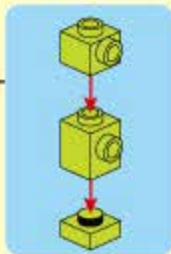

3

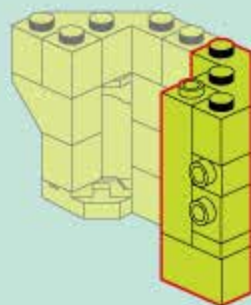
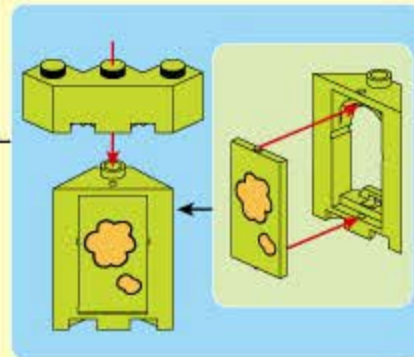
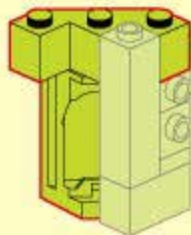

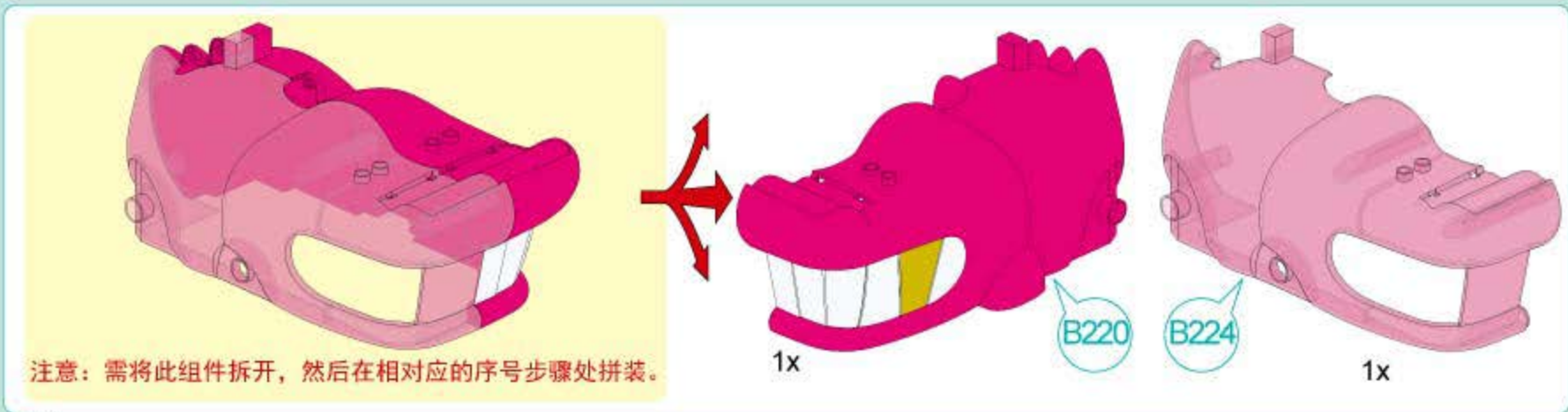
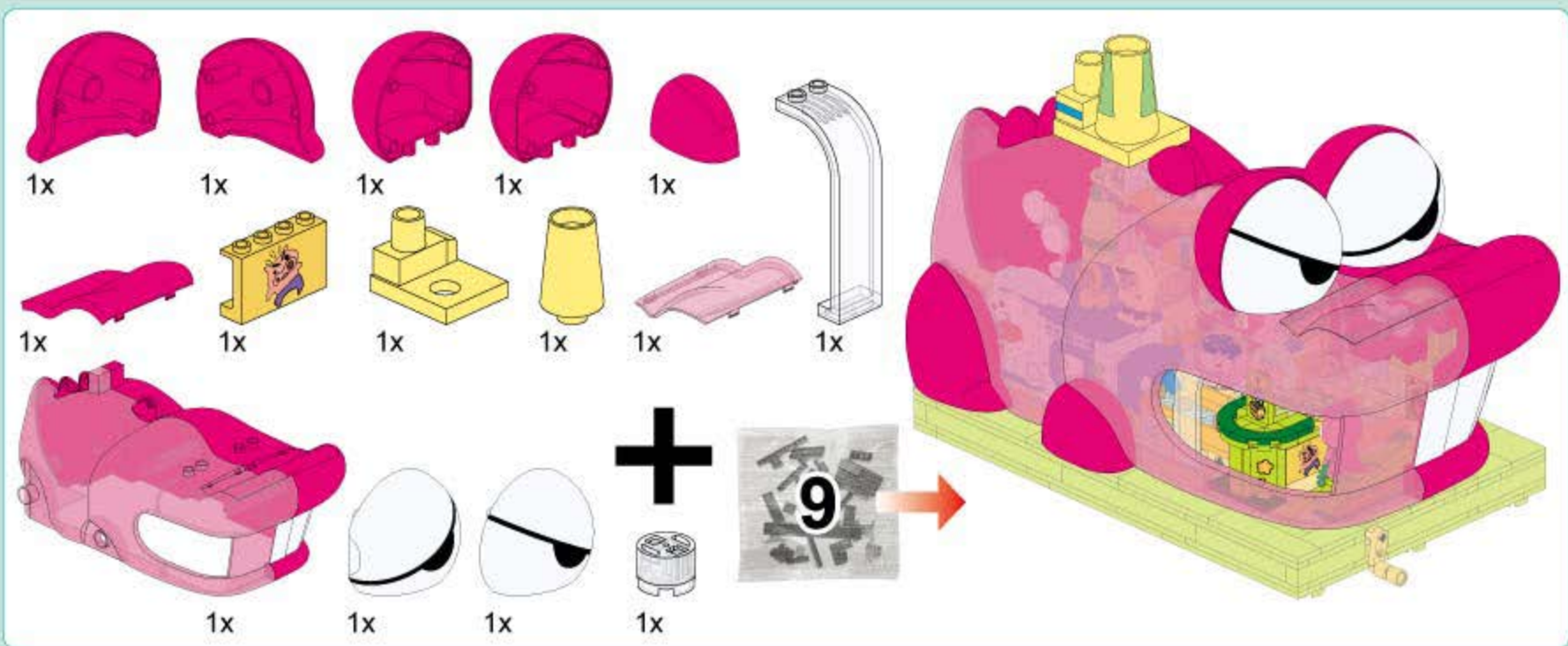

注意：需将此组件拆开，然后在相对应的序号步骤处拼装。

B185

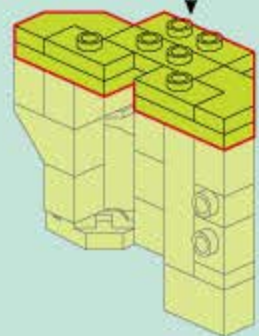
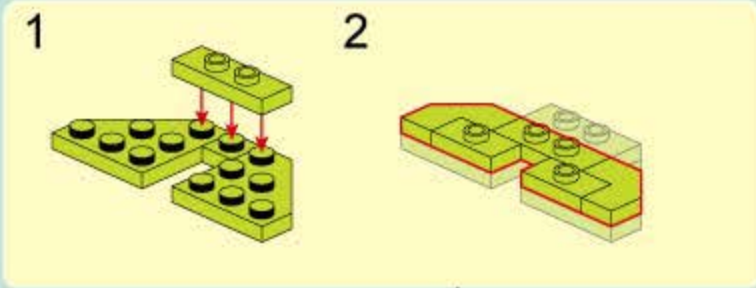
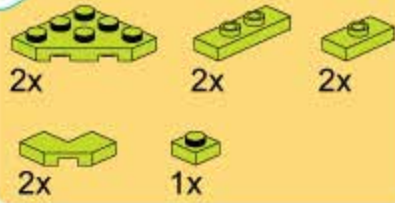

B186

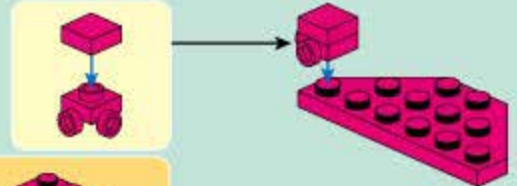
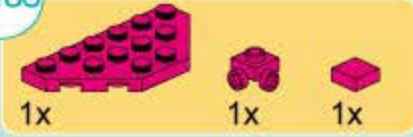

B187

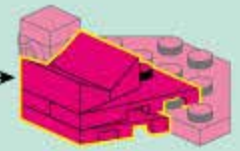
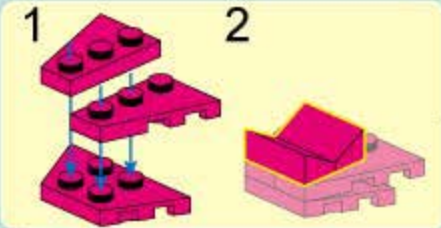
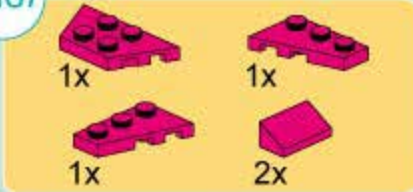

B188

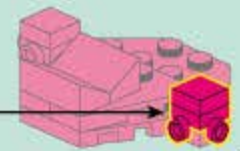

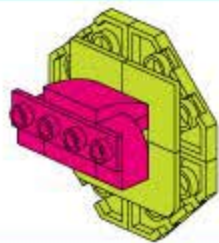

B189

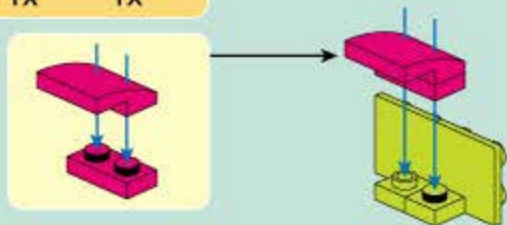
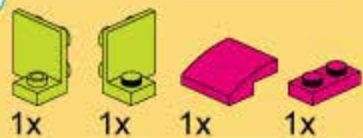

B190

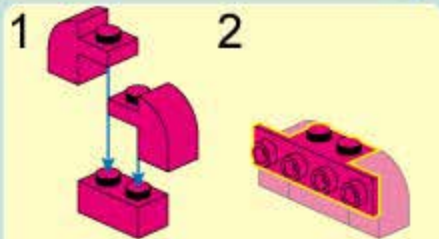

B191



1x



B192

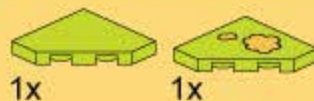

1x

1x

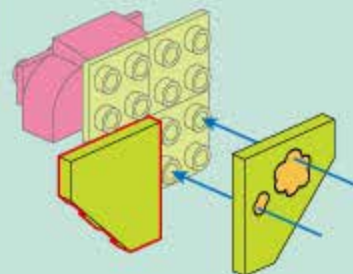

B193



2x



B194

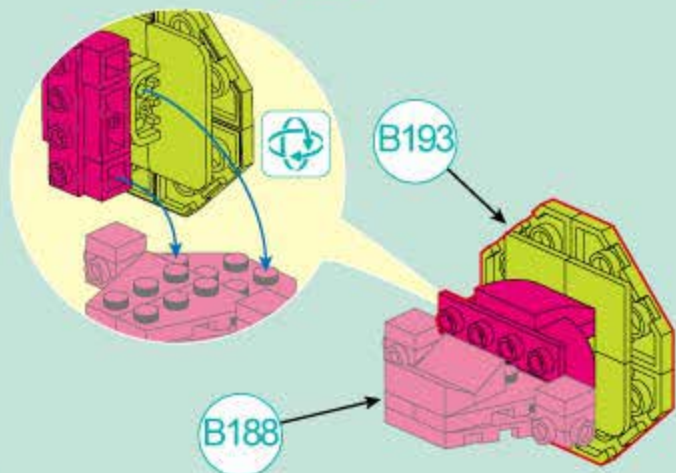

B195

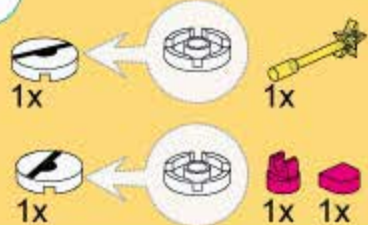

B196



1x



1x



温馨提示：组装完成后，请扭动一下以确保灯光件正常发光。

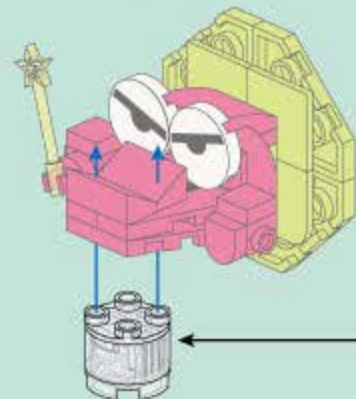

B197

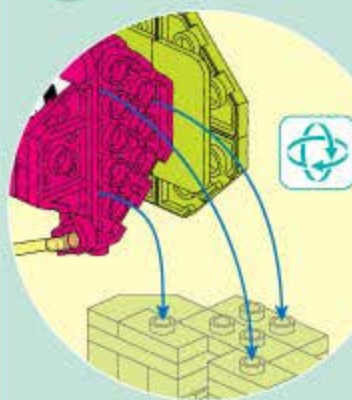

B196

B185

B198

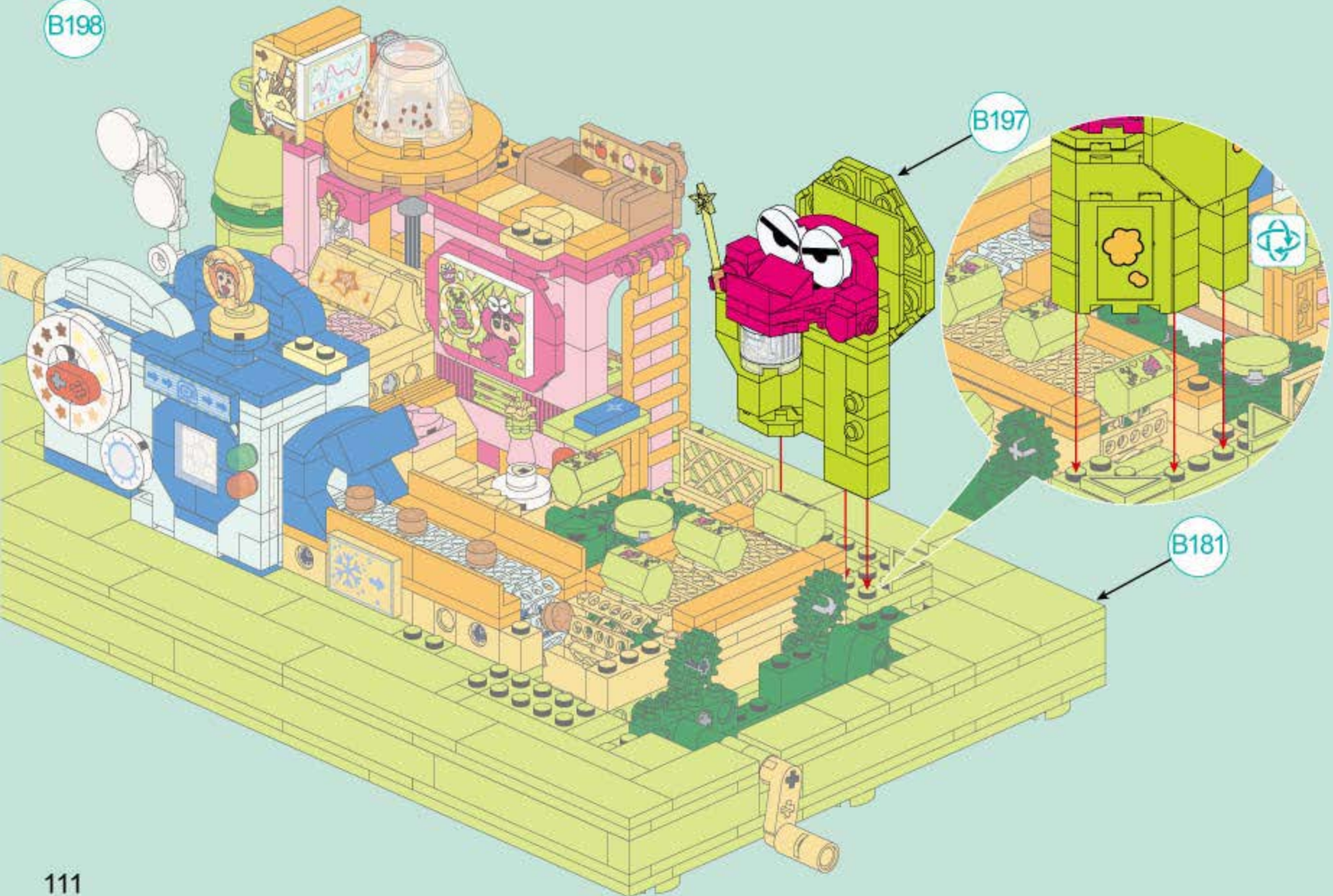

B197

B181

B199

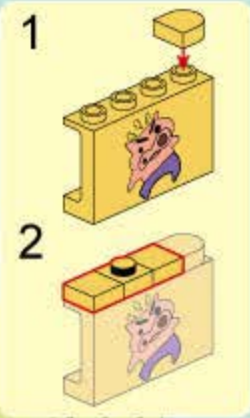
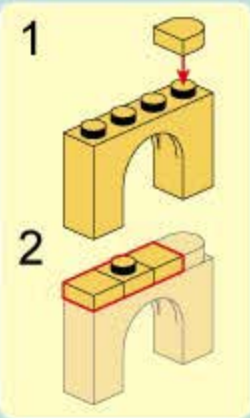
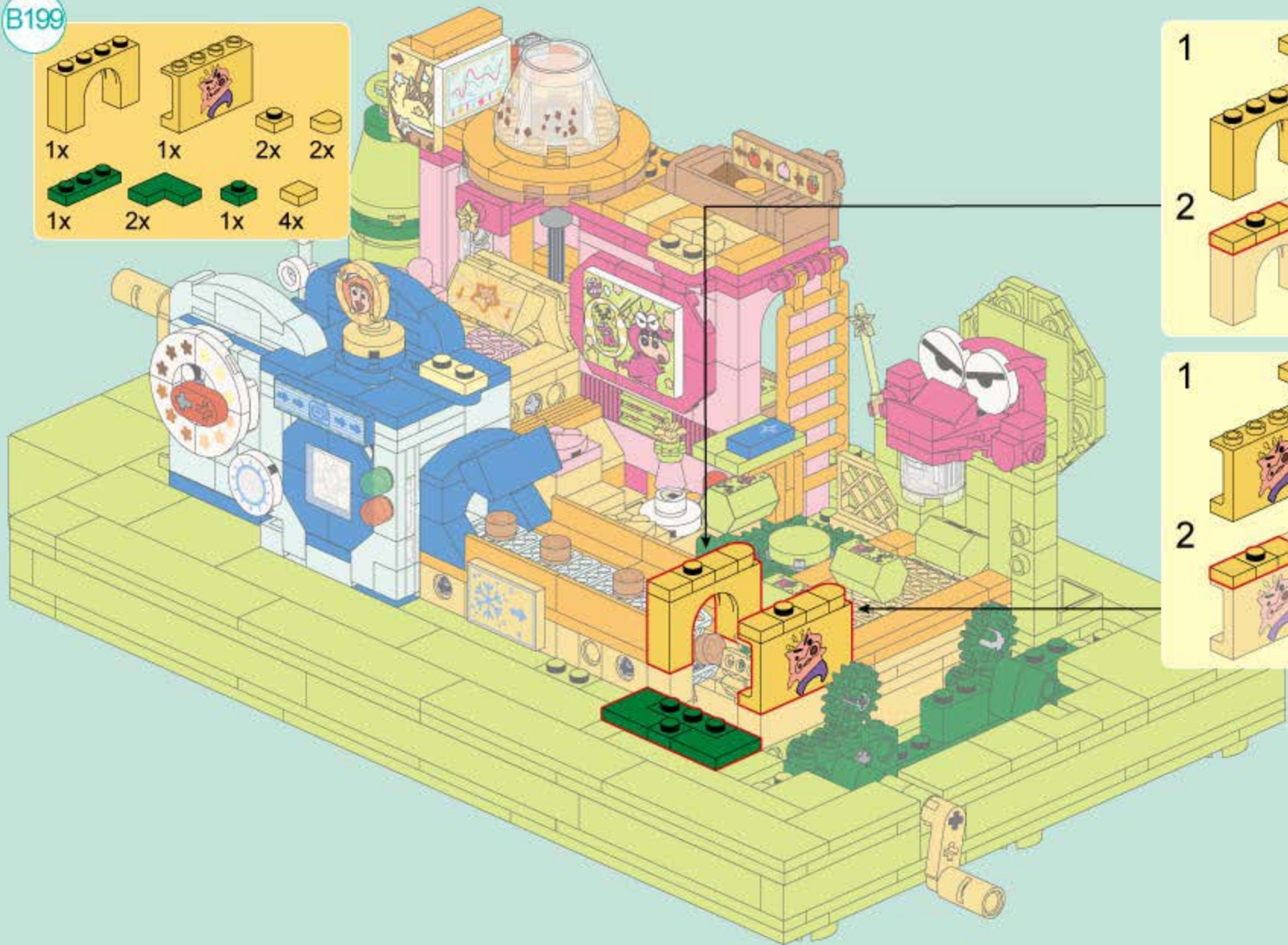
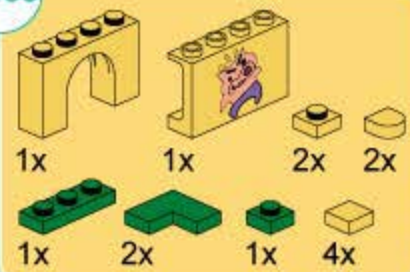

B200

1x (white curved beam)  
1x (blue 1-hole Technic brick)  
1x (blue 2-hole Technic brick)  
1x (green 1-hole Technic brick)  
2x (green 1-hole Technic brick with hole)  
1x (green 1-hole Technic brick with hole and flower)  
1x (green 1-hole Technic brick with hole and flower)

Diagram showing the white curved beam being attached to a blue 2-hole Technic brick. A blue 1-hole Technic brick is shown being inserted into the top hole of the 2-hole brick. Red arrows indicate the direction of assembly.

Diagram showing a green 1-hole Technic brick with a hole being inserted into the top hole of a green 1-hole Technic brick with a hole. Red arrows indicate the direction of assembly.

Diagram showing a green 1-hole Technic brick with a hole and a flower being inserted into the top hole of a green 1-hole Technic brick with a hole. Red arrows indicate the direction of assembly.

A circular inset showing the completed assembly of the green brick structure. A blue circular icon with a refresh symbol is located in the top left corner of the inset.

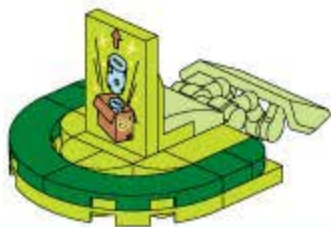

B201

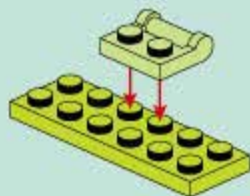
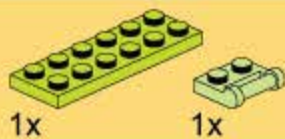

B202

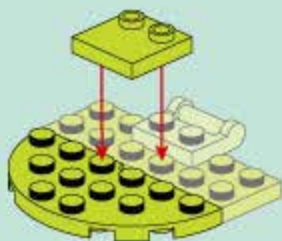

B203

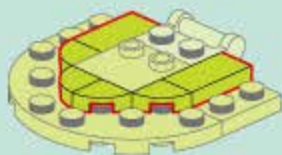

B204

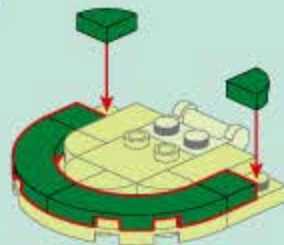

B205

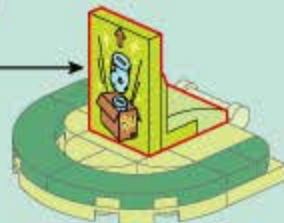
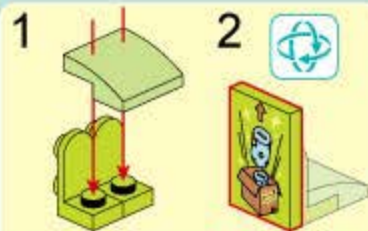

B206

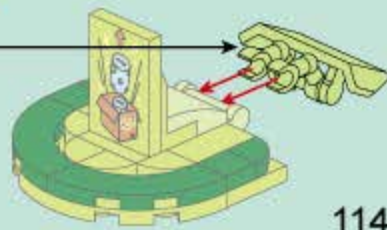

B207

B200

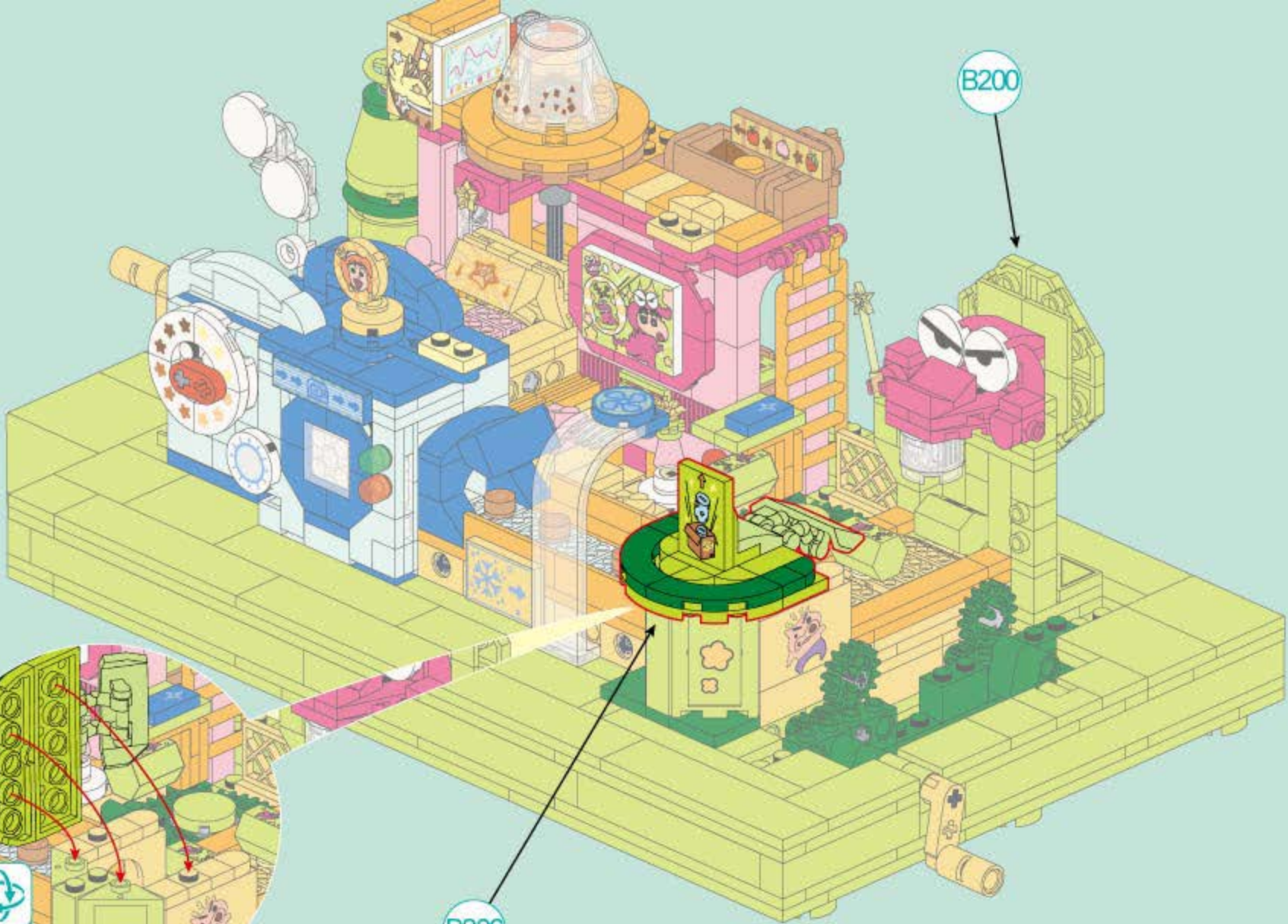

B206

B208

 1x	 1x
 1x	 1x



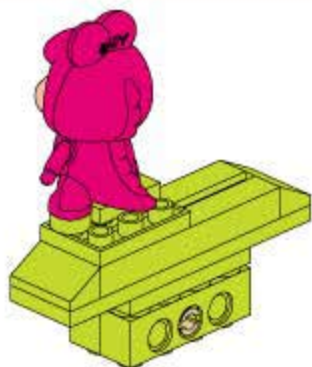

B209



1x



1x

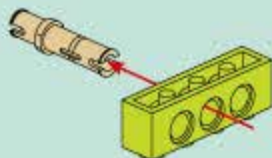

B210



1x



1x

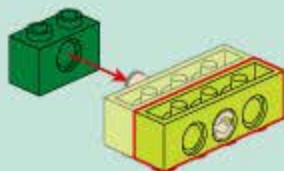

B211



1x



8x

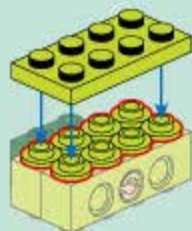

B212



1x

2x8



1x

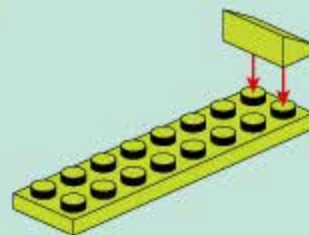

B213

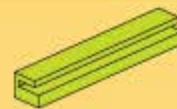

2x

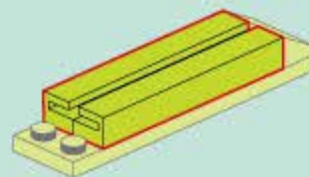

B214

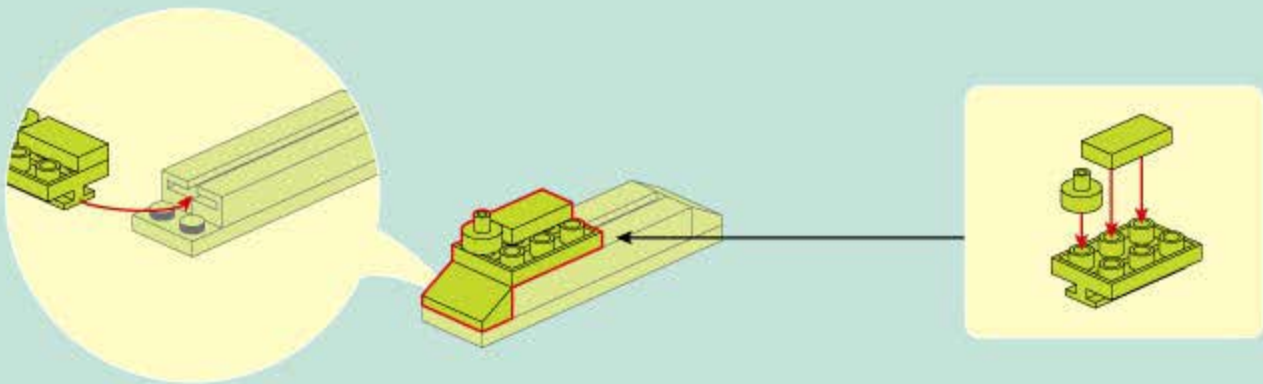
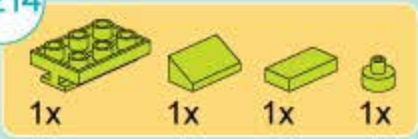

B215

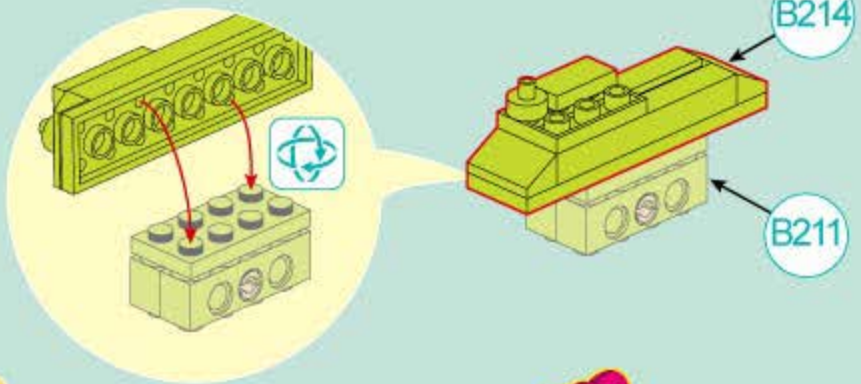

B216

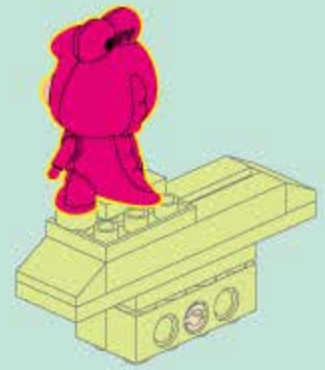

B217

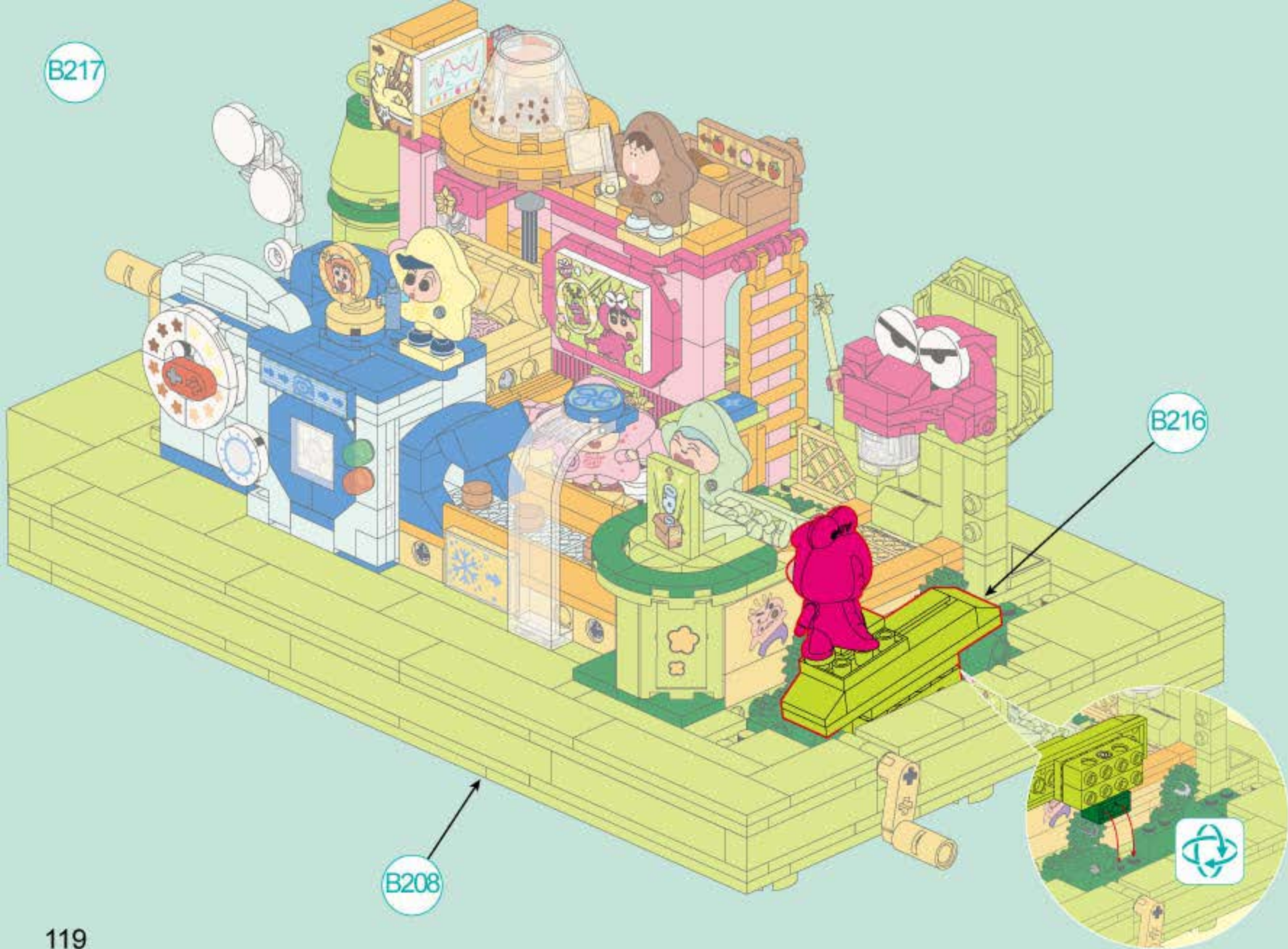

B218

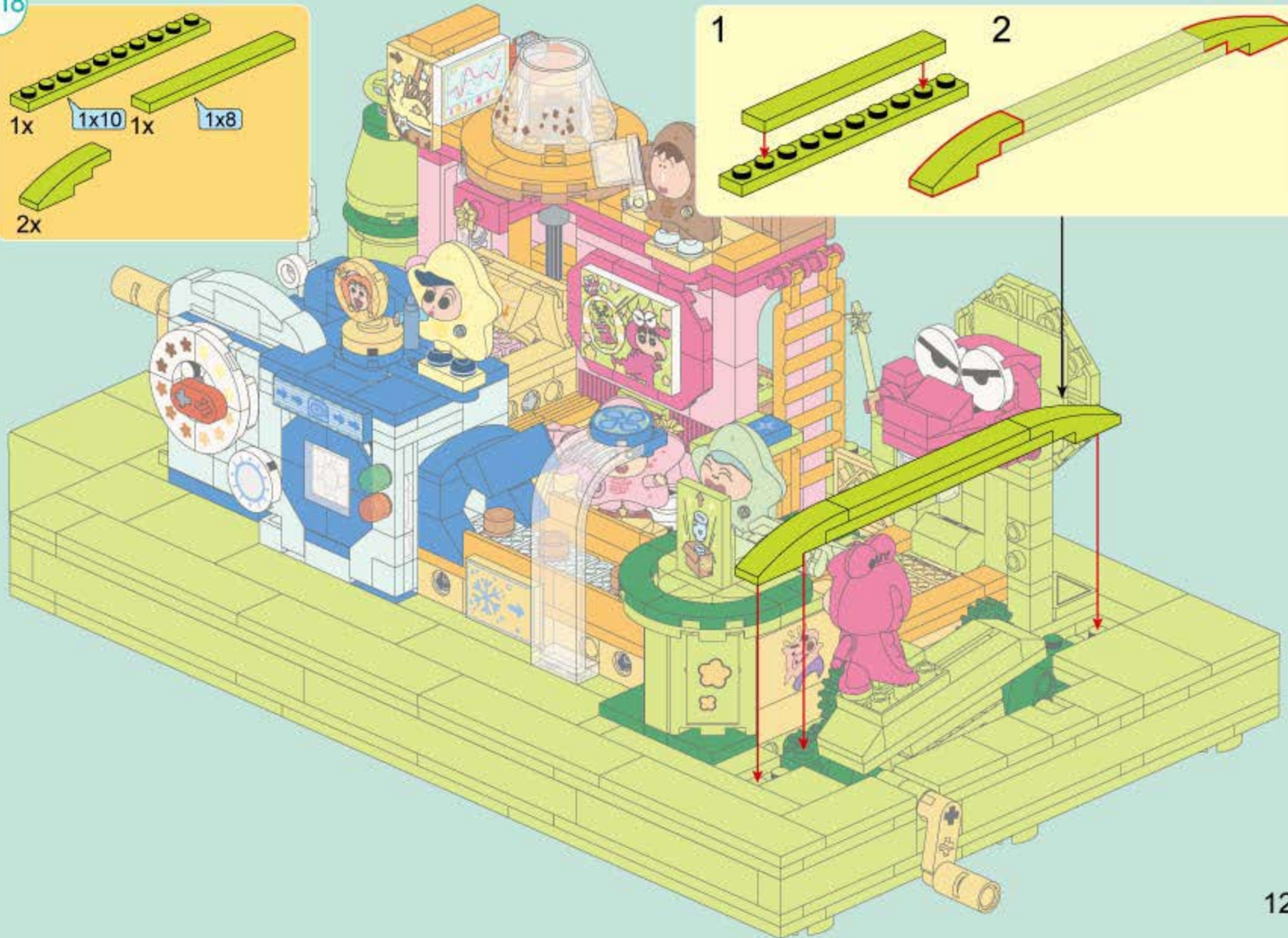
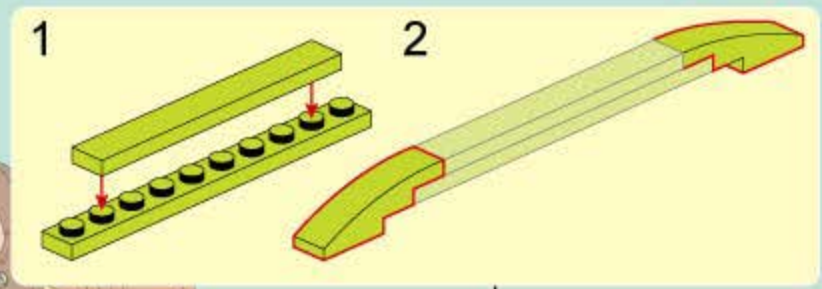
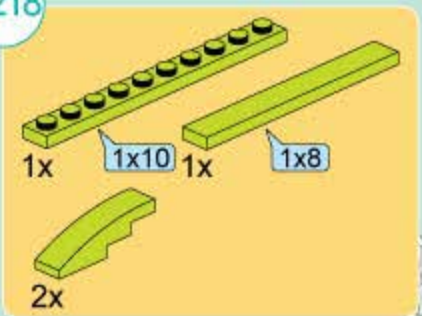

B219

1x  2x3



B220

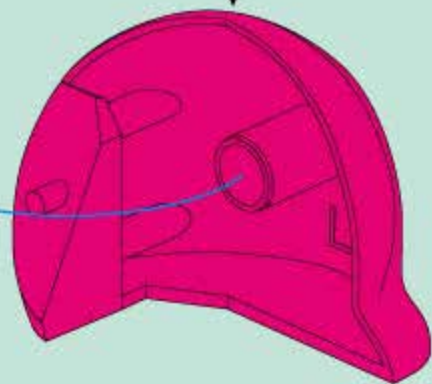
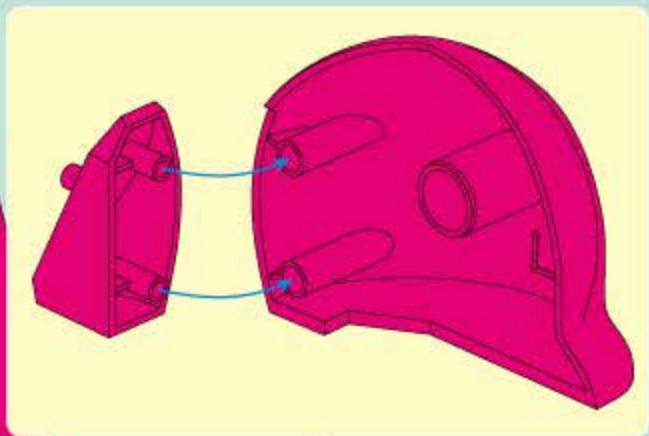
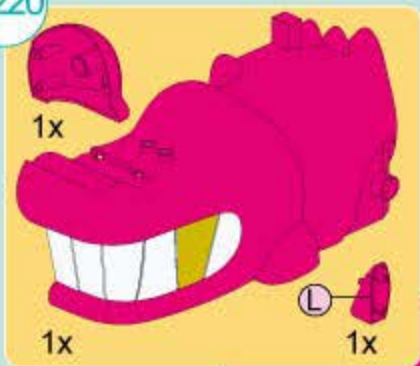

注意：贴贴纸时请选取相对平整的弧面，避免贴纸起严重褶皱。

B221

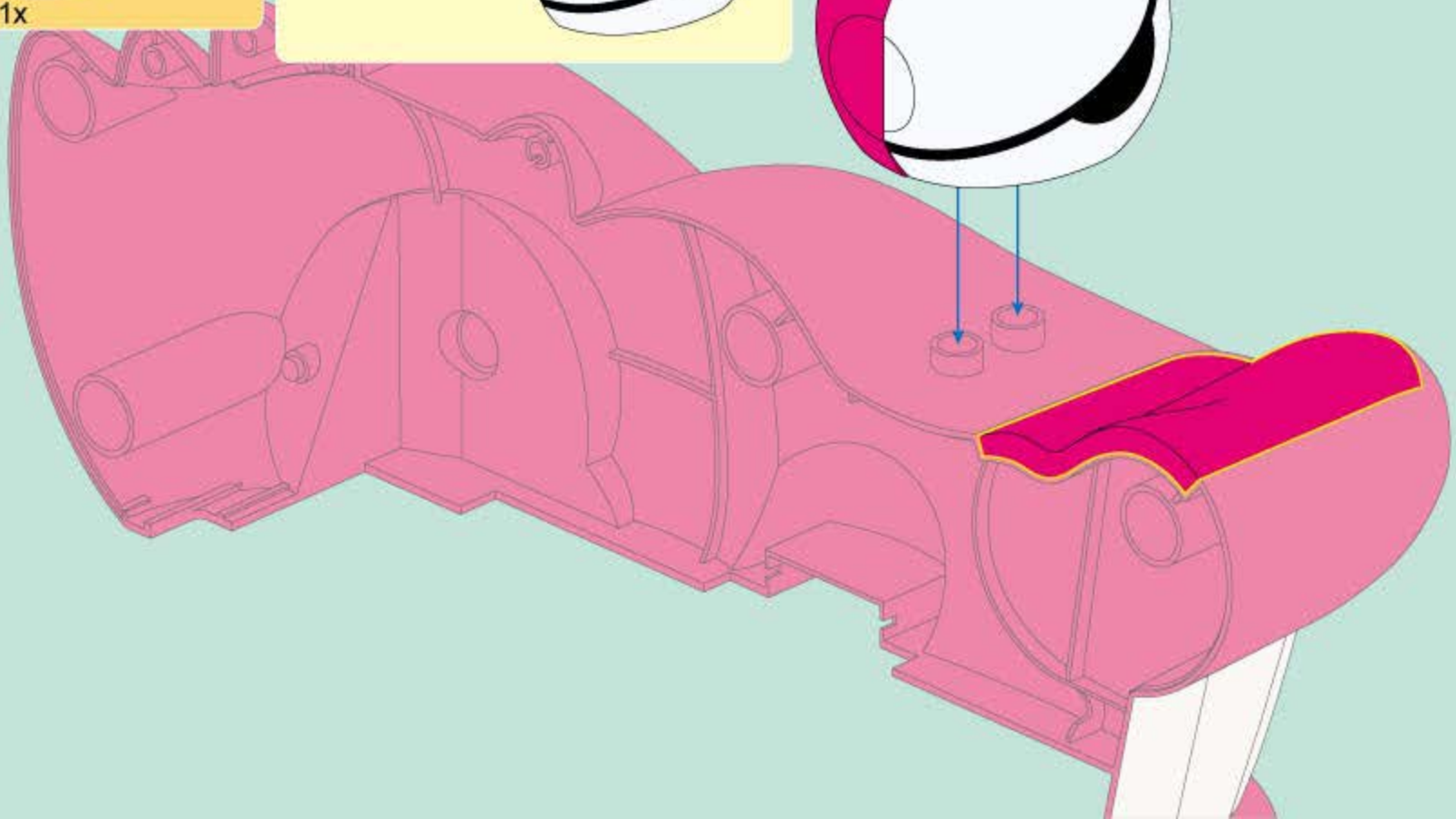
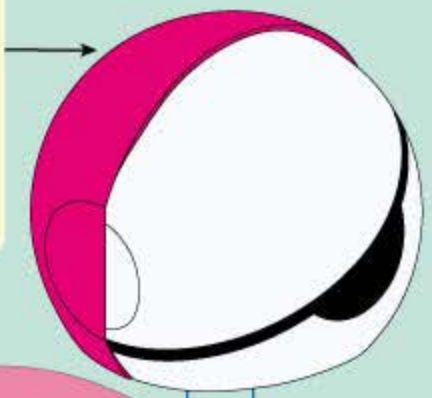
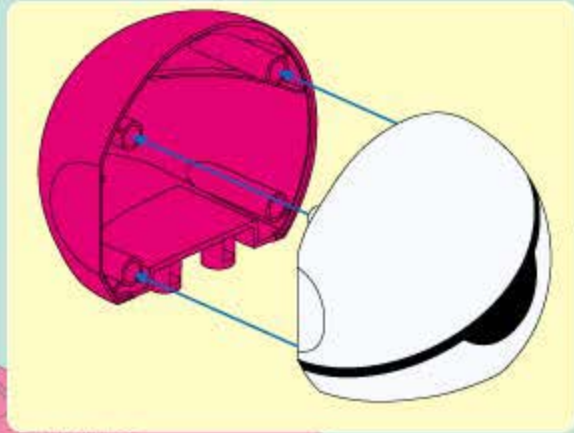
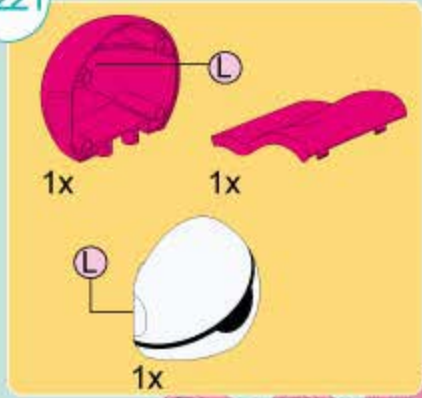

B222

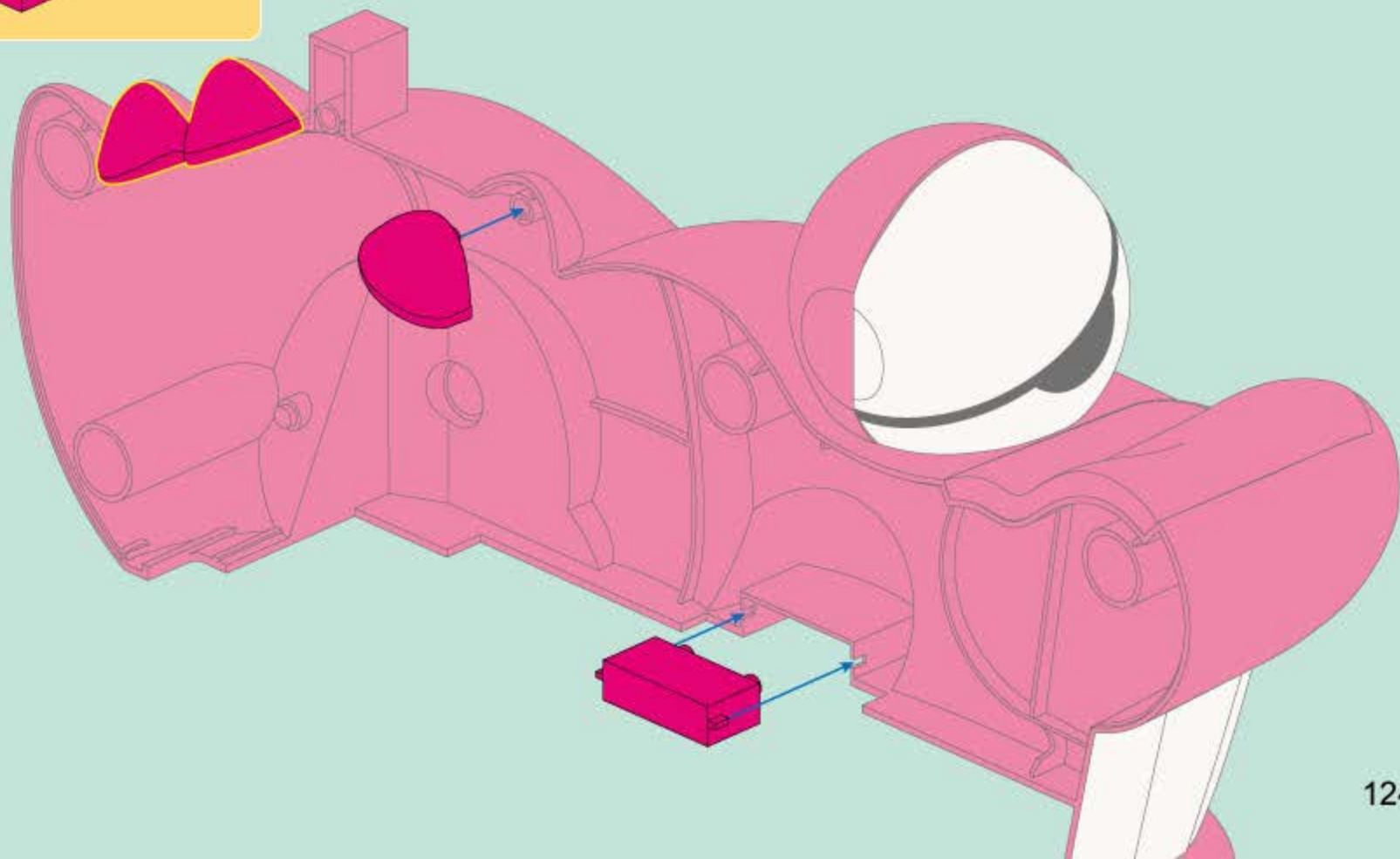
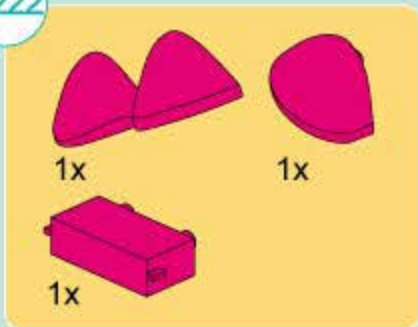

B223



1x

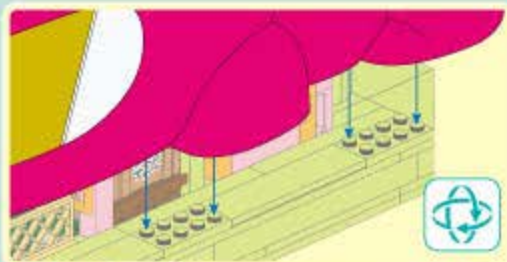

B222

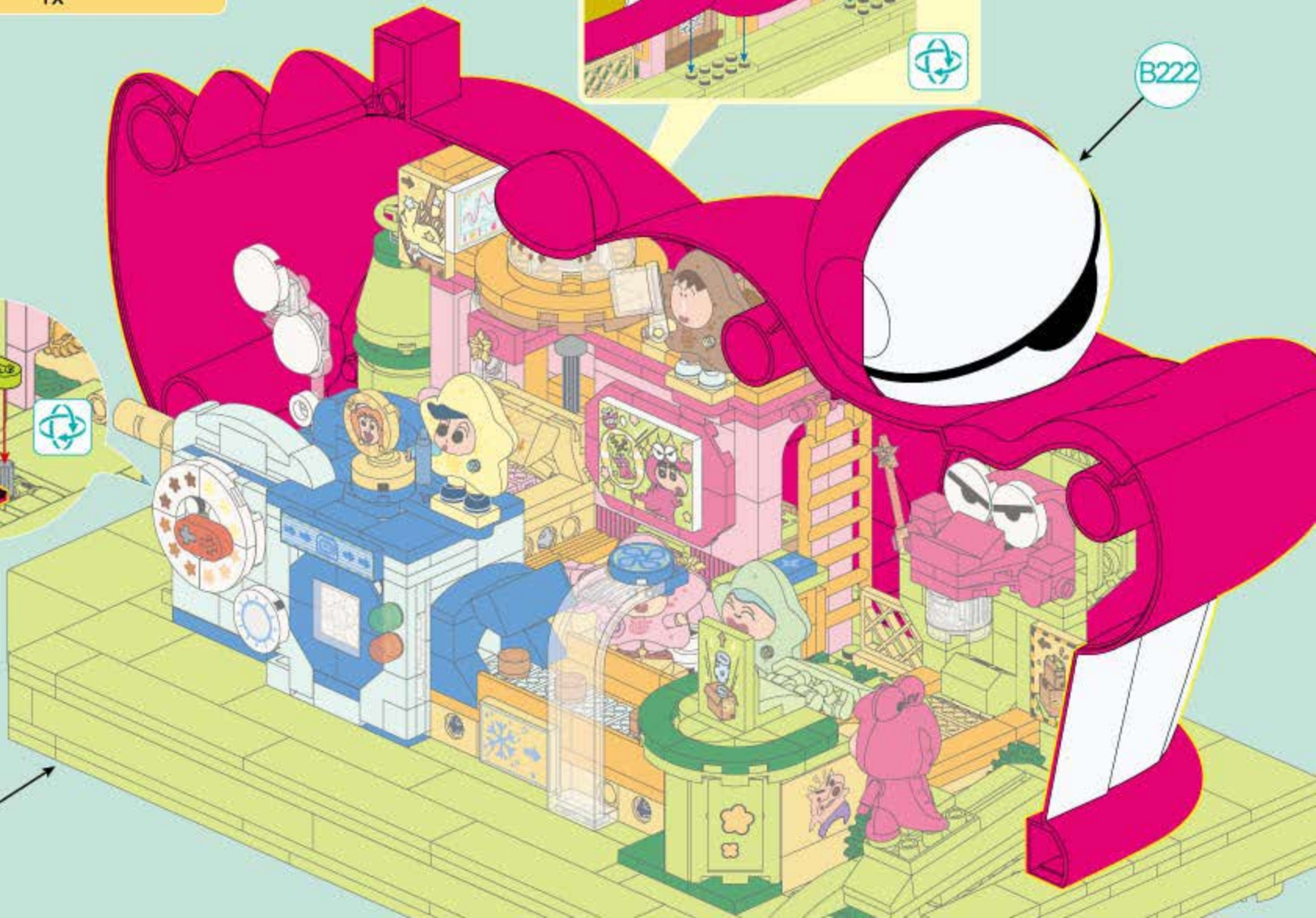
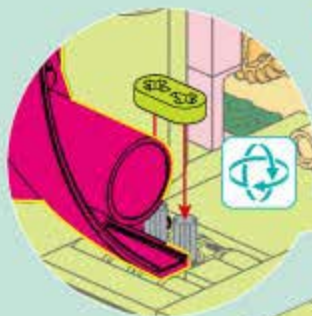

B219

125

B224

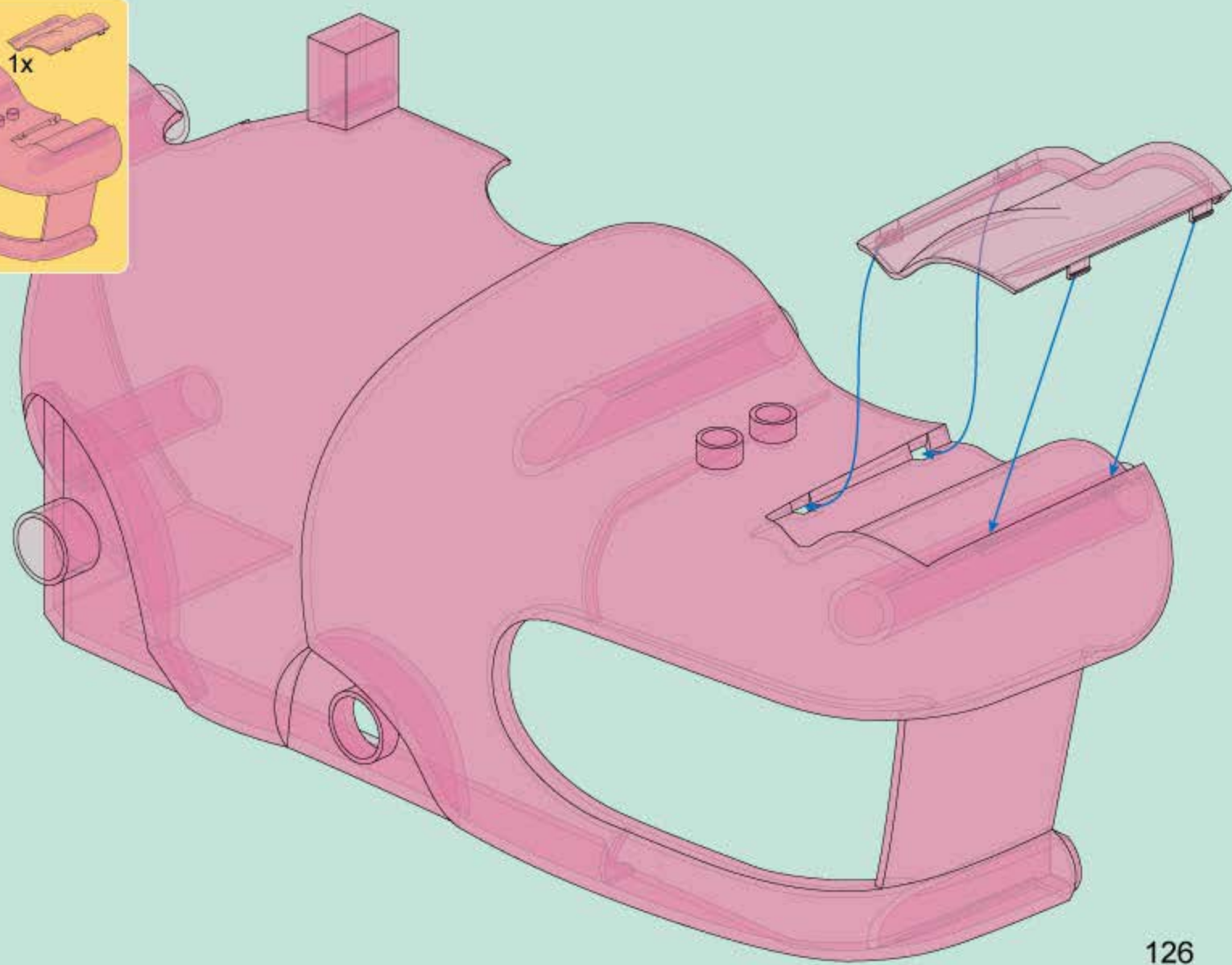
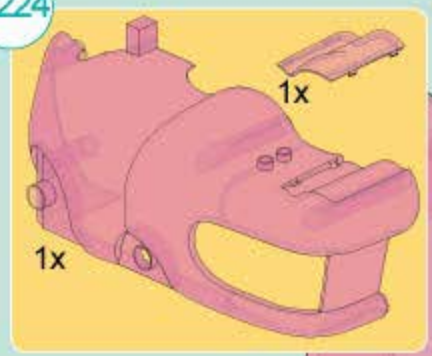

B225

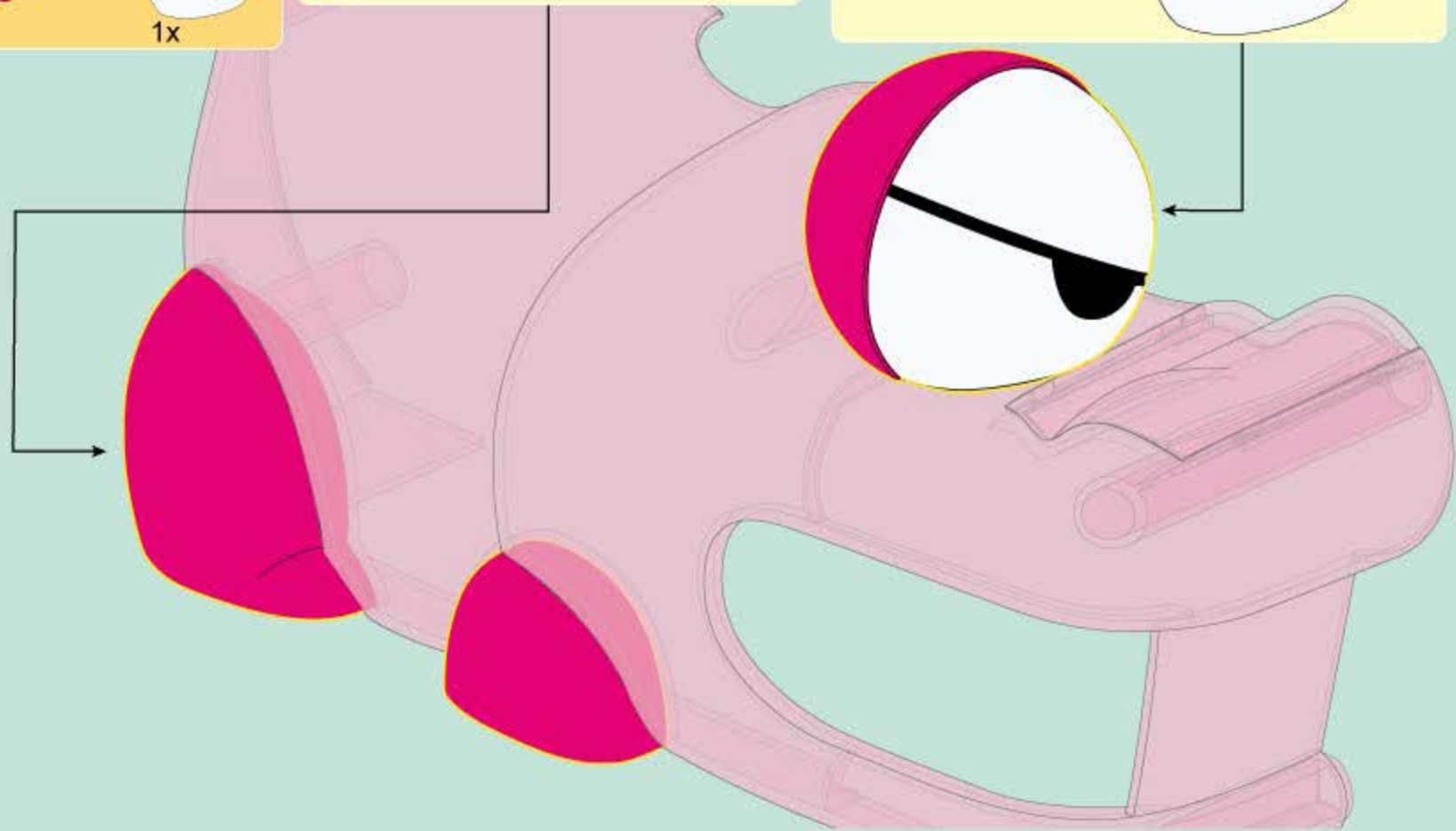
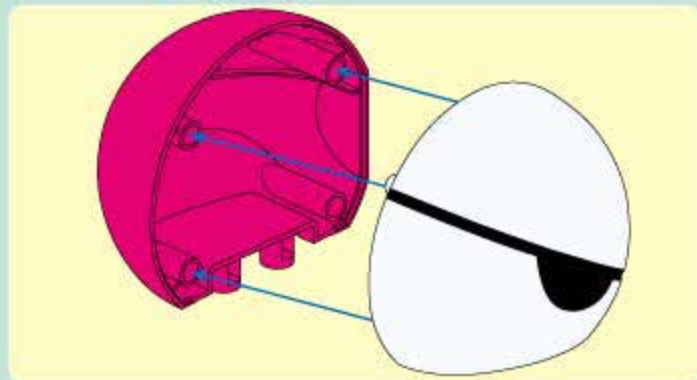
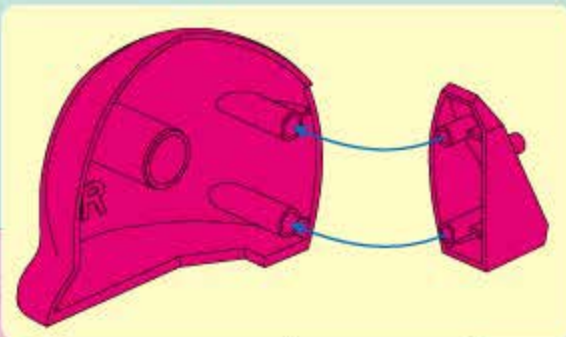
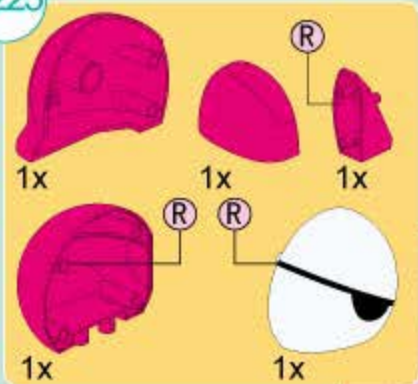

B226

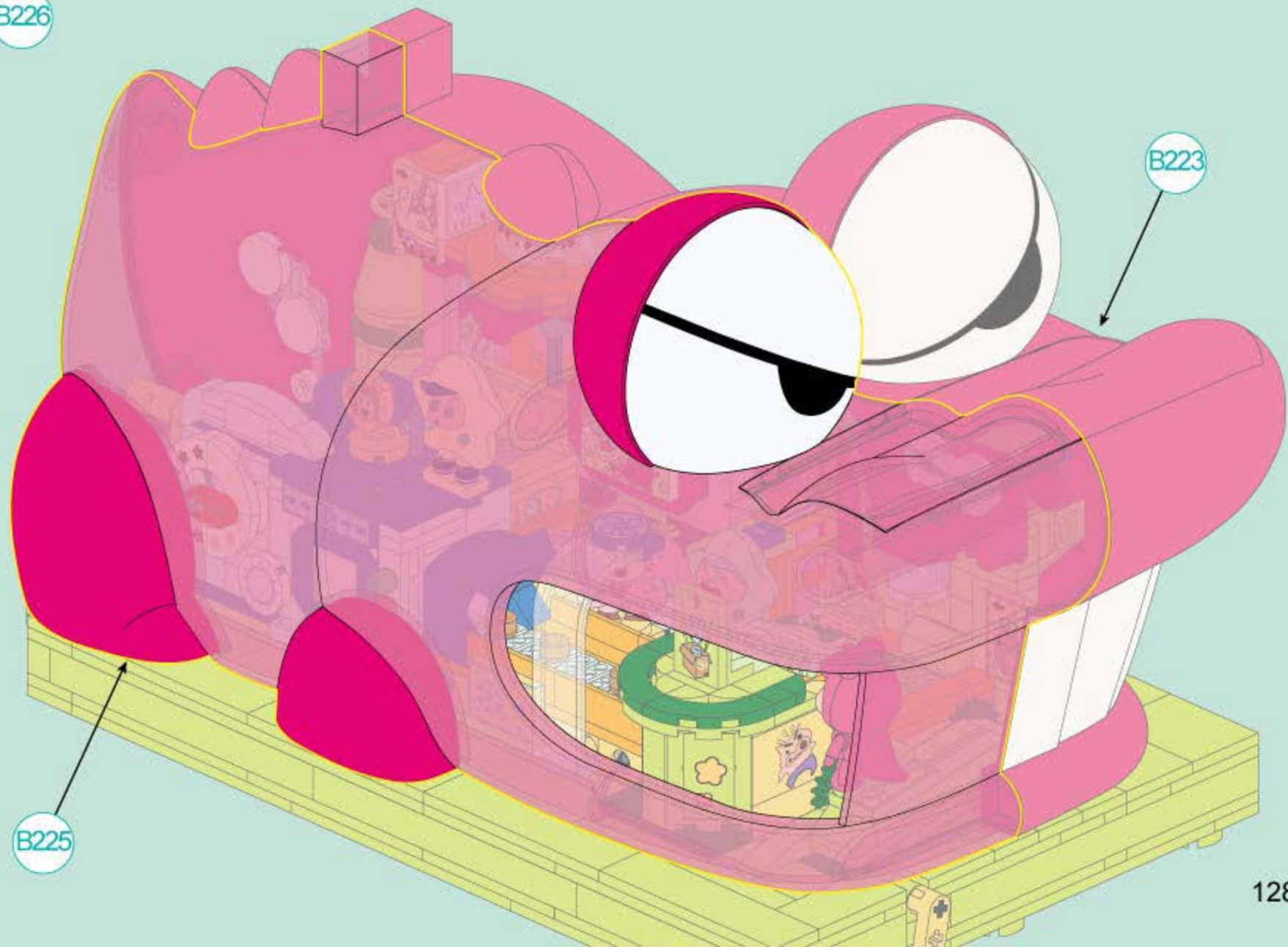

B223

B225

B227

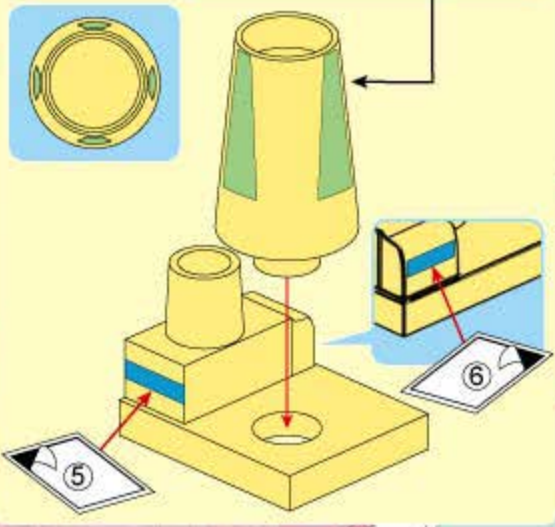
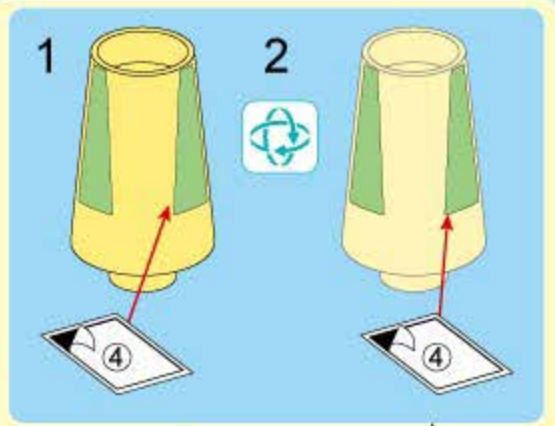
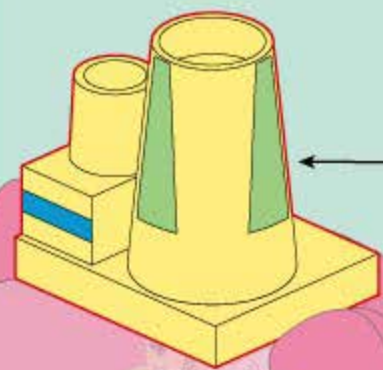
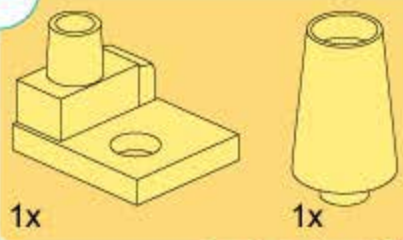

# 玩法1：取下外壳

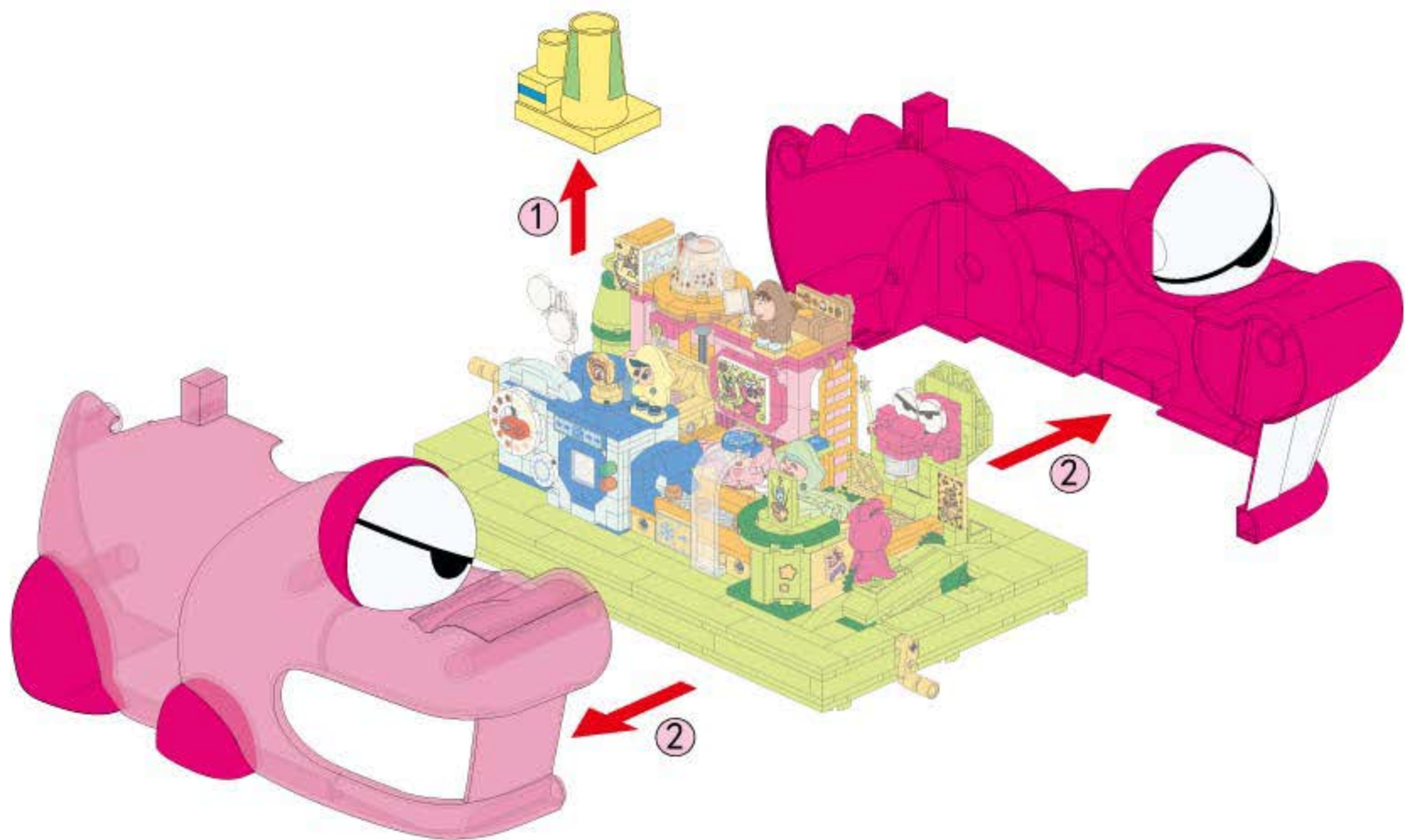



## 玩法3：转动摇柄，启动流水线

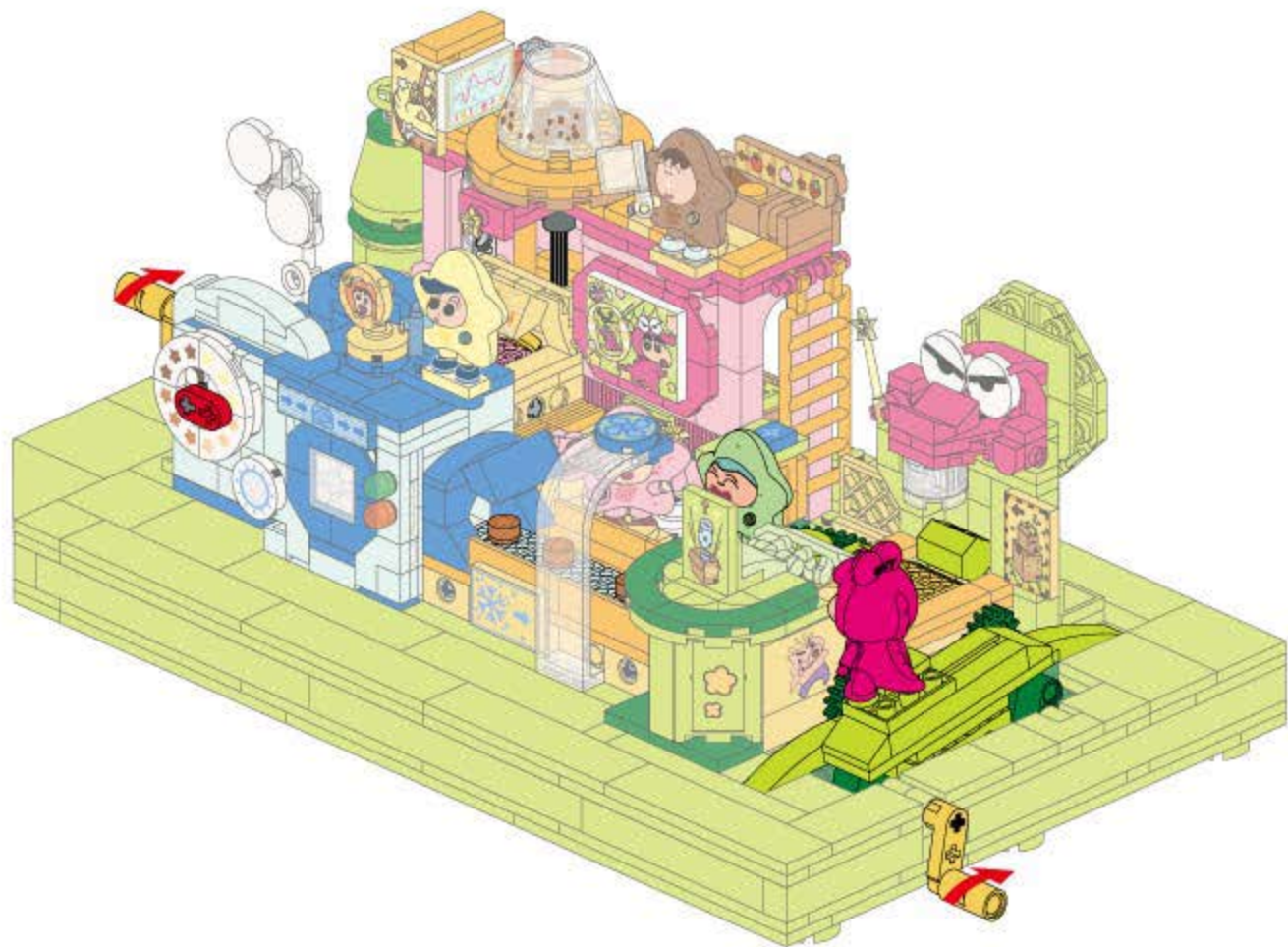



蜡笔小新