

K 奇妙积木 KEEP PLEY

City Corner X 奇幻童话镇  
16159198



独角兽冰淇淋店

K28047



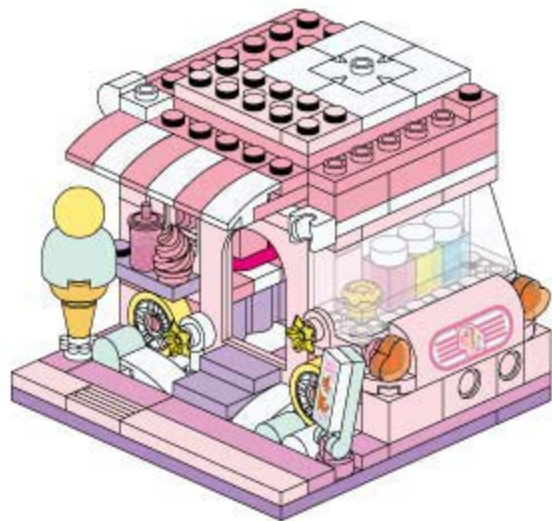
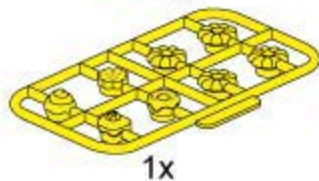
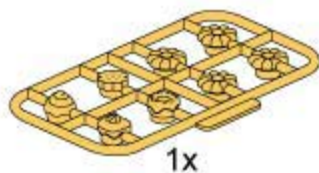

1

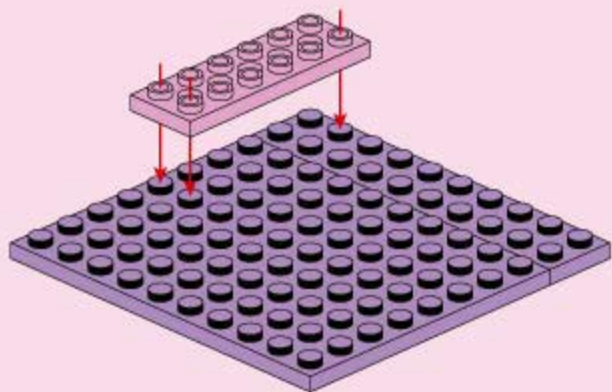
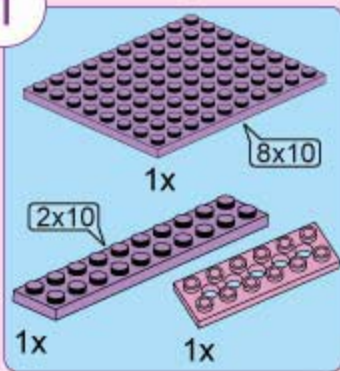

2

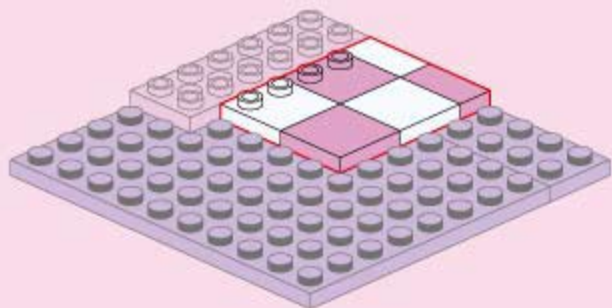
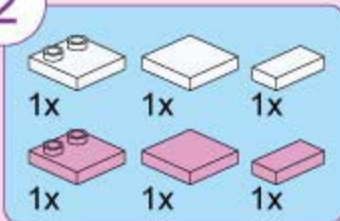

3

3

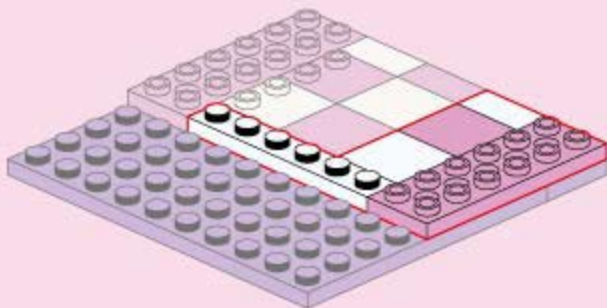
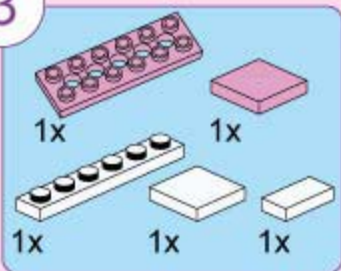

4

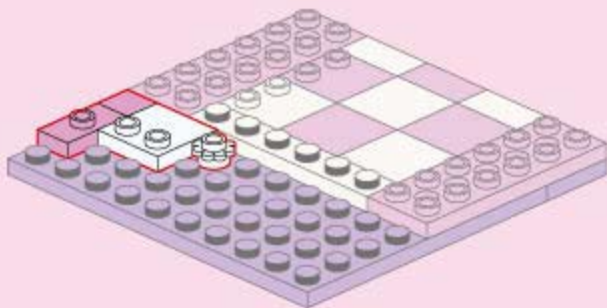

5

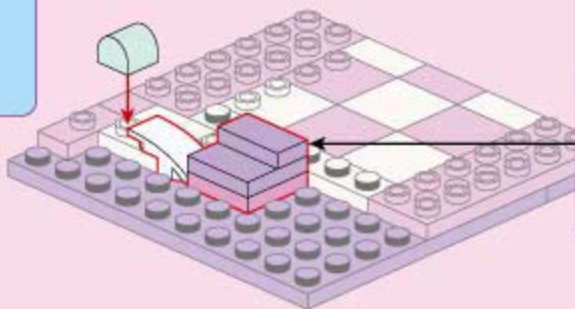
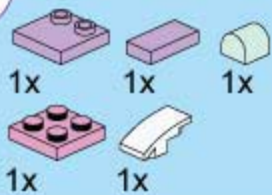

1

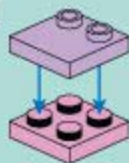

2

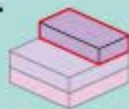

6

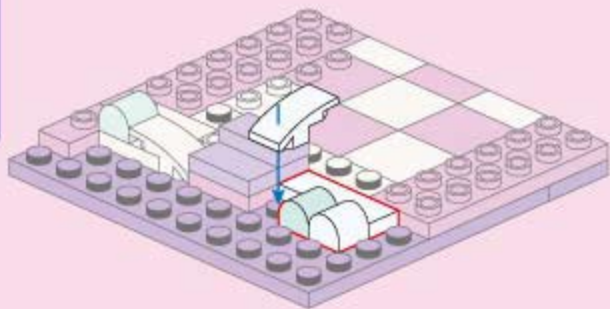
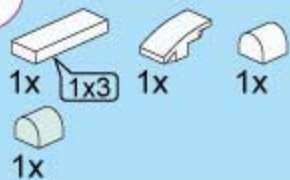

7

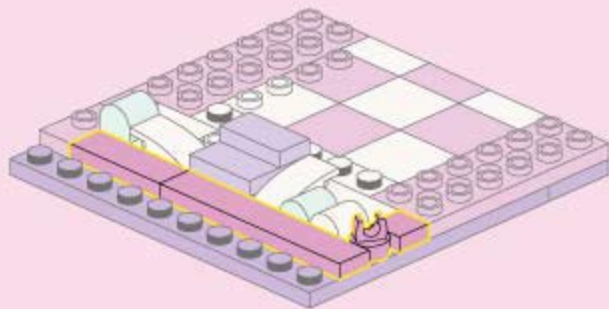
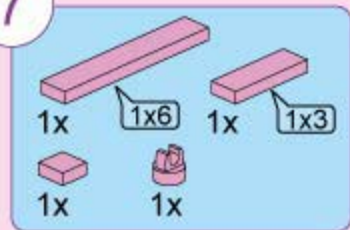

8

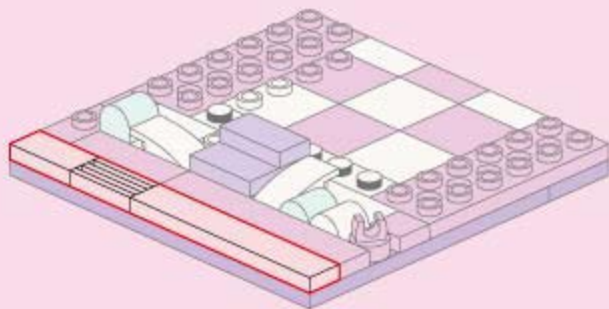
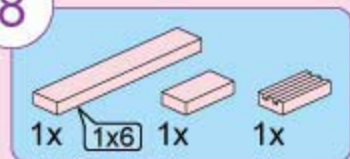

9

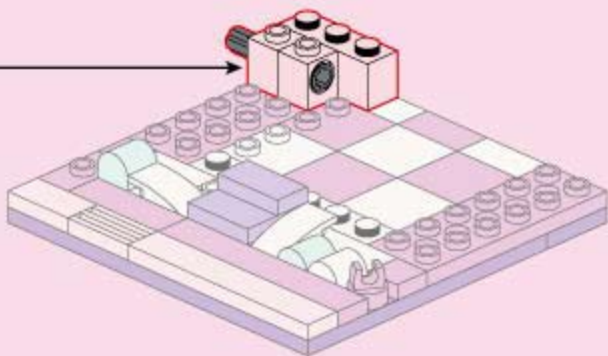
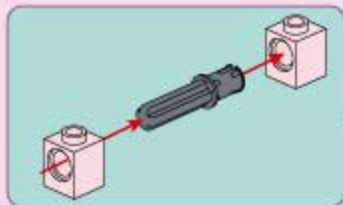
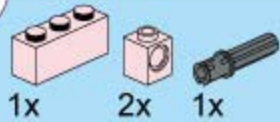

10

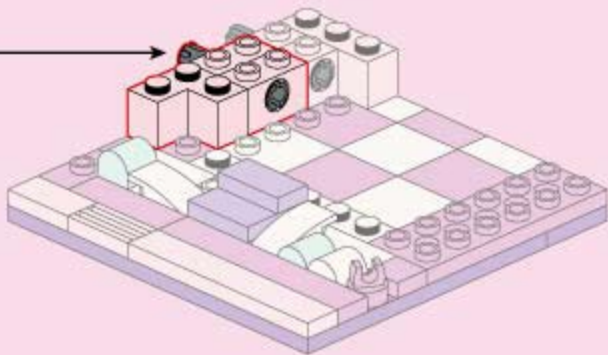
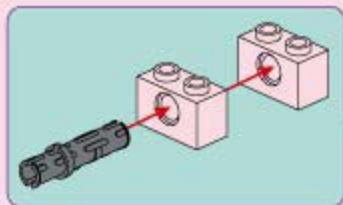
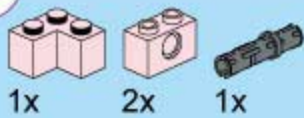

11

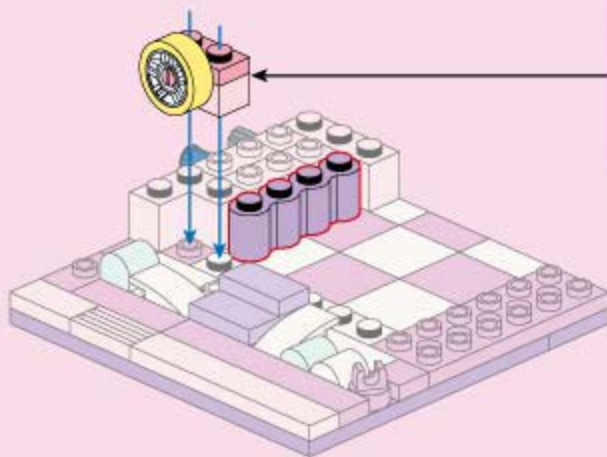
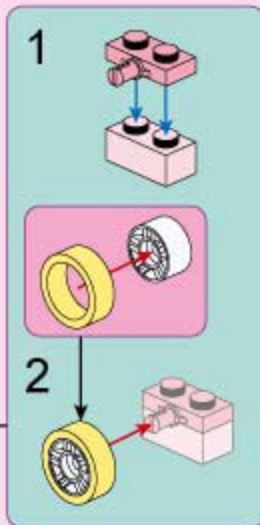
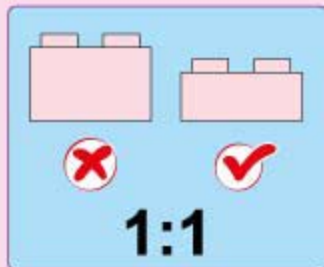
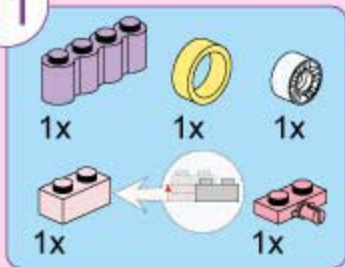

12

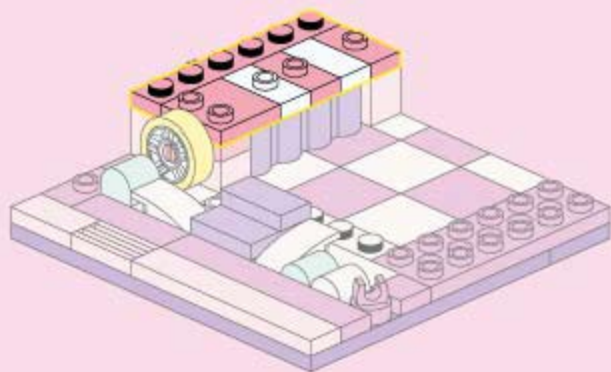
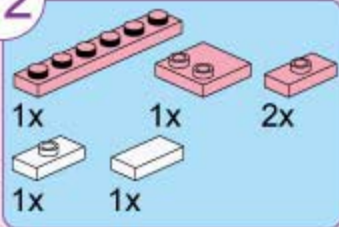

13

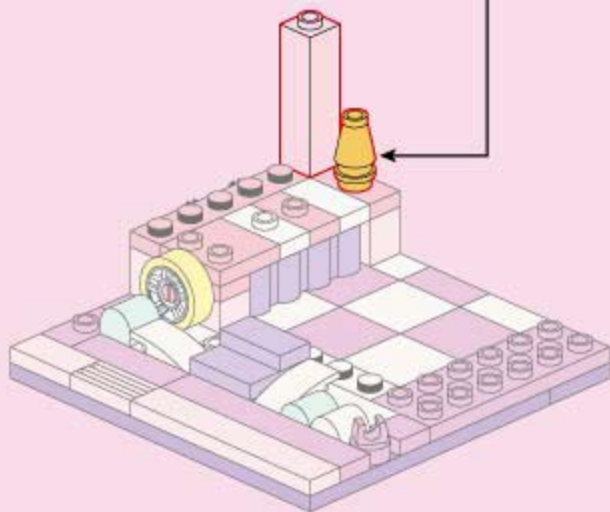
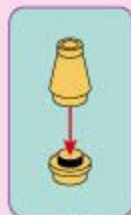
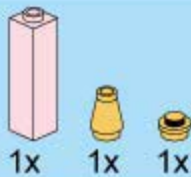

14

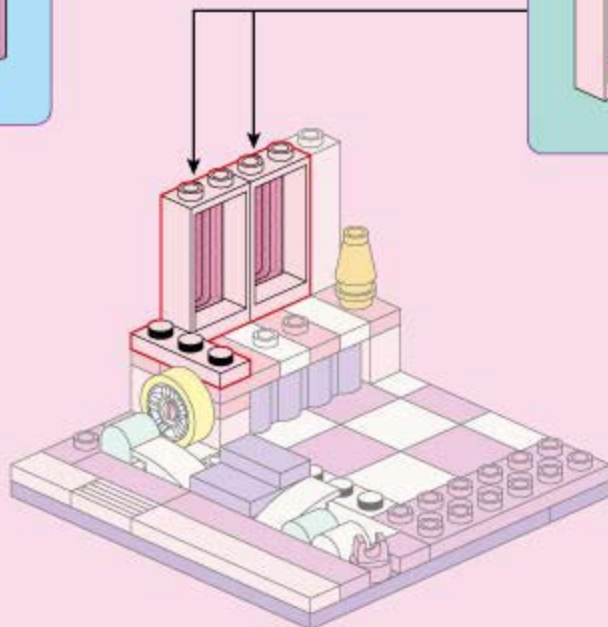
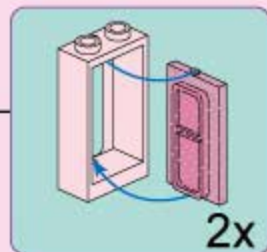
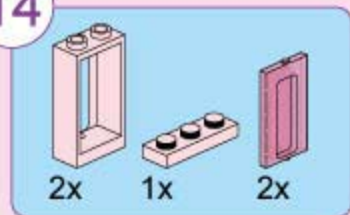

15

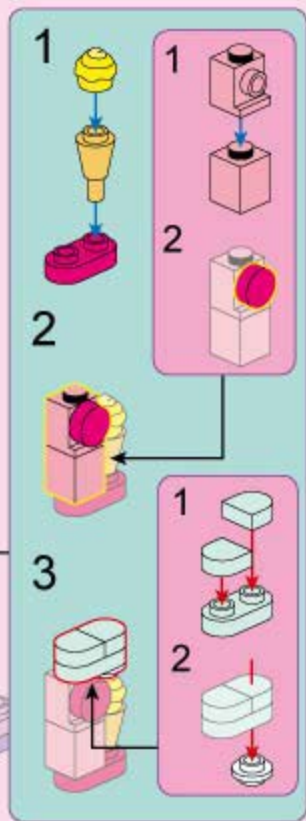
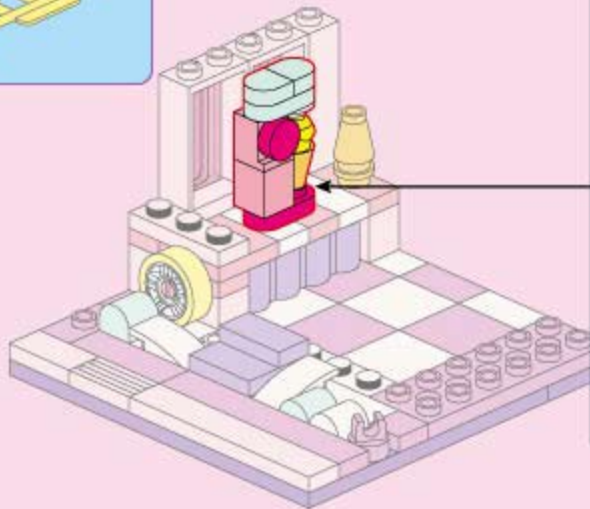

16

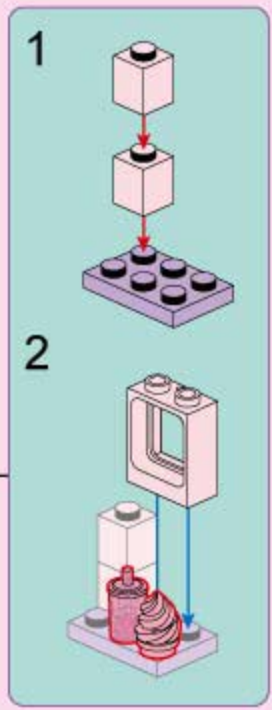
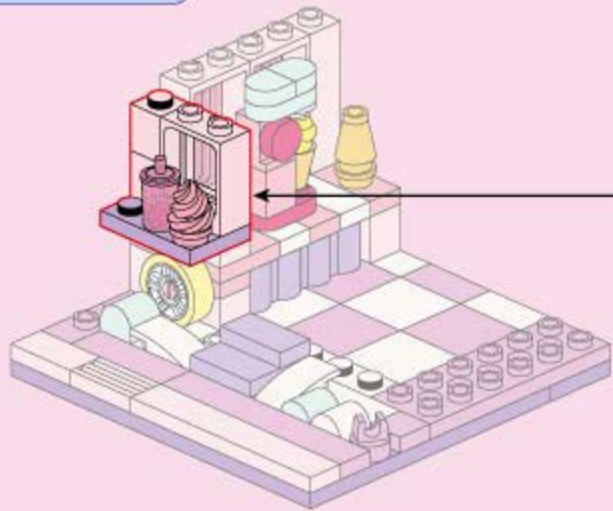
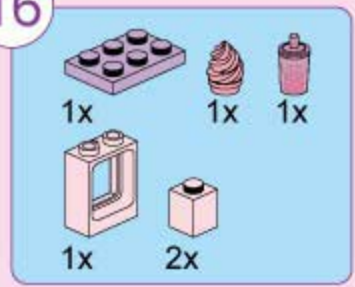

17

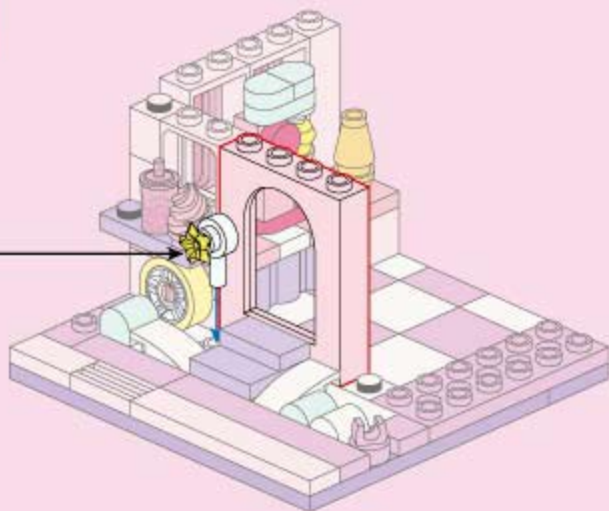
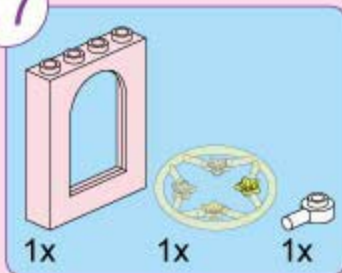

18

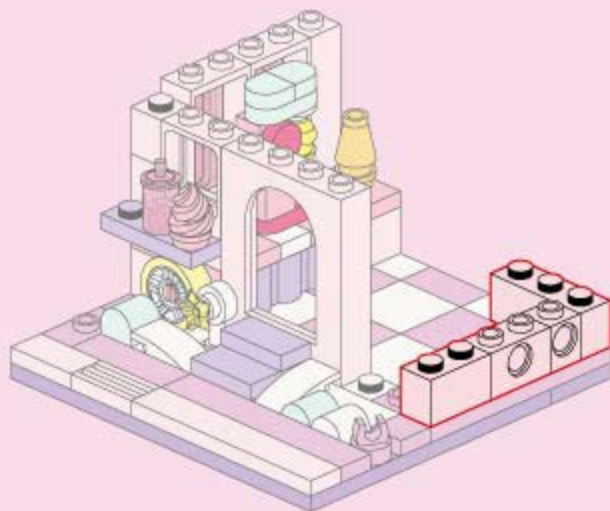
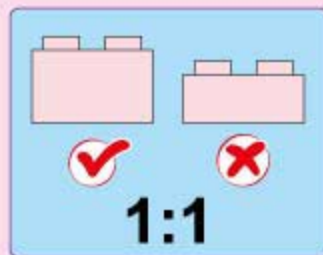
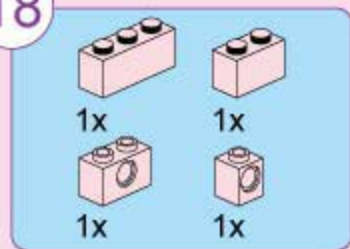

19

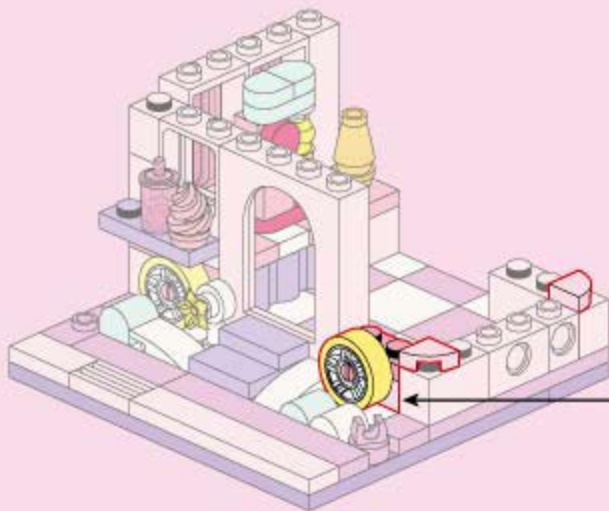
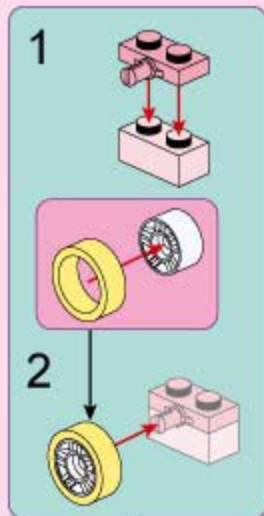
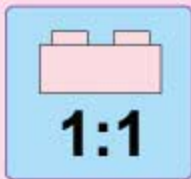
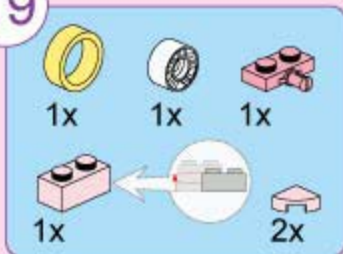



20

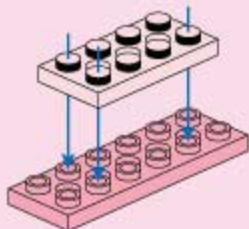
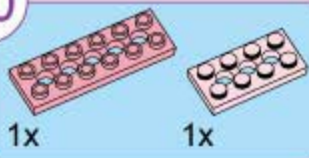

21

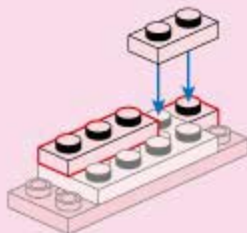
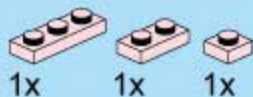

22



23

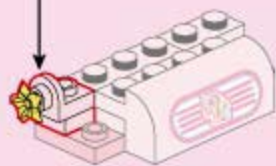
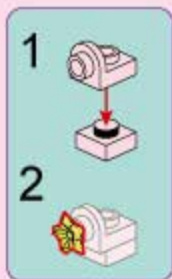

24

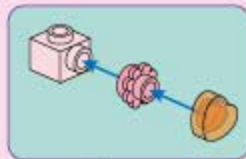
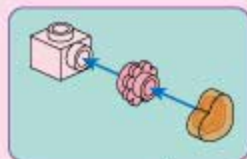
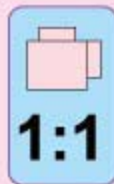
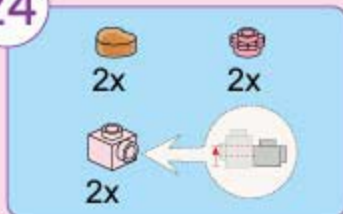

25

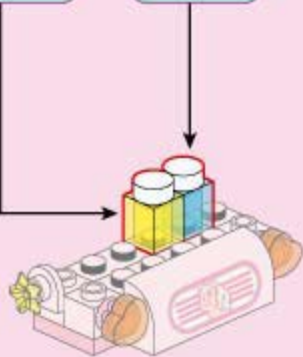
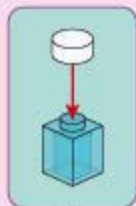
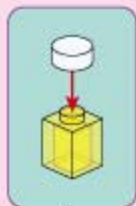

26

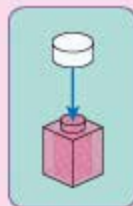
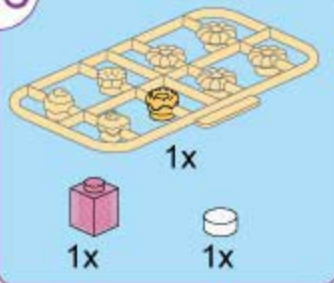

27



1x

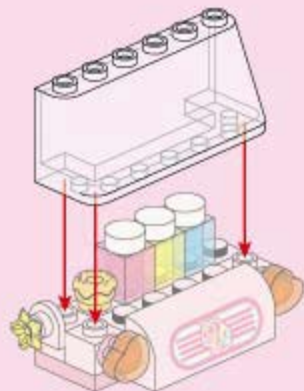

28

19

27



29

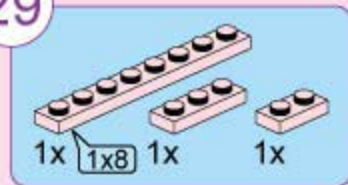

30

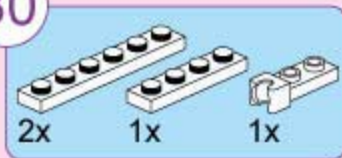

31

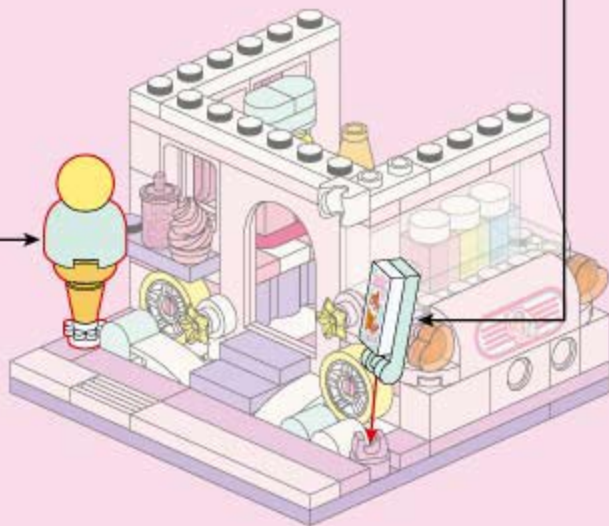
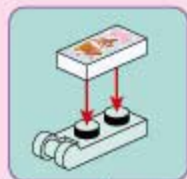
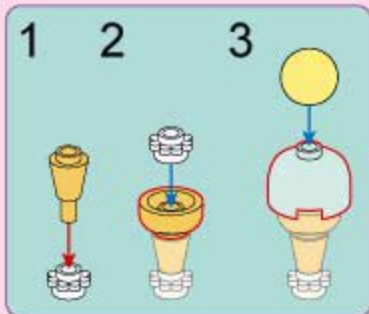



注意：需将此组件拆开，然后在相对应的序号步骤处拼装。  
Caution: This set piece needs to be separated, and assembled at respective sequence number.

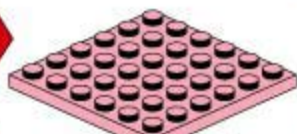

1x (32)

该颗粒用于第3分包  
This brick is for pack 3



2x (80)

该颗粒用于第3分包  
This brick is for pack 3



2x (79/81)

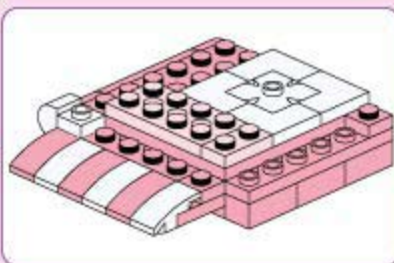

32



1x

6x6



1x

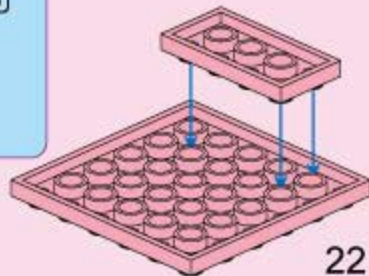

33

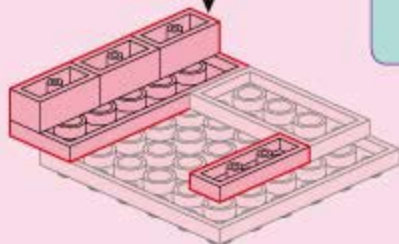
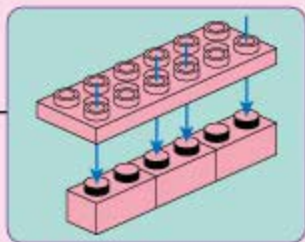
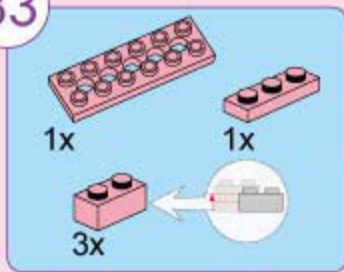

34

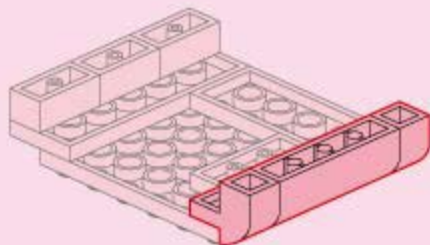
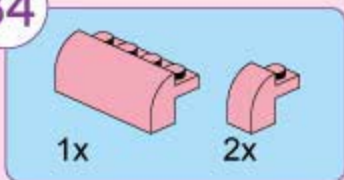

35

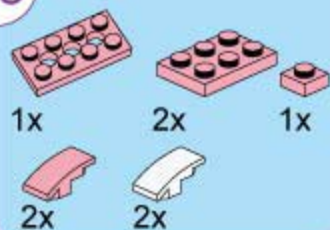

1

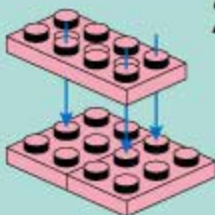

2



36

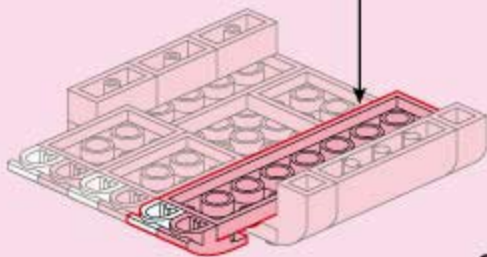
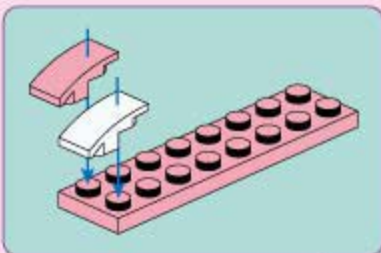
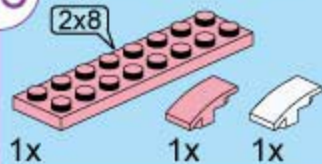

37

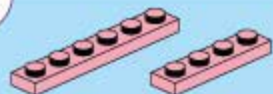

1x

1x

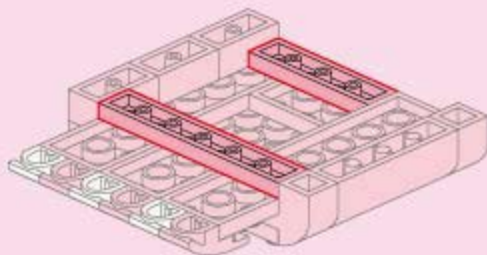

38



1x

4x

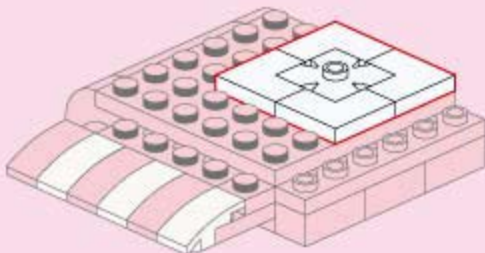

39

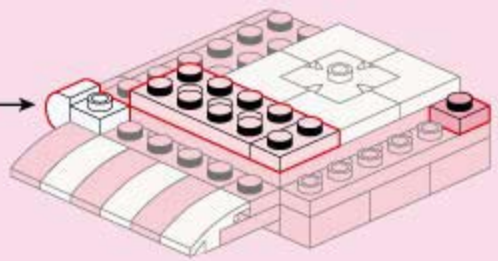
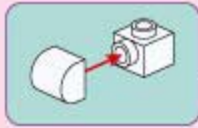
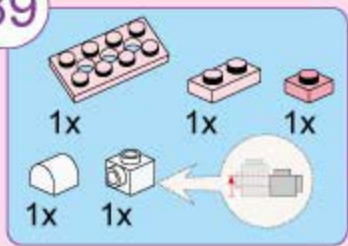

40





+



41



1x

1x



1x



1x



1x



1

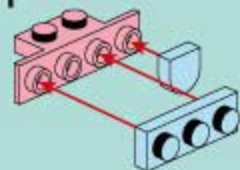

2



42

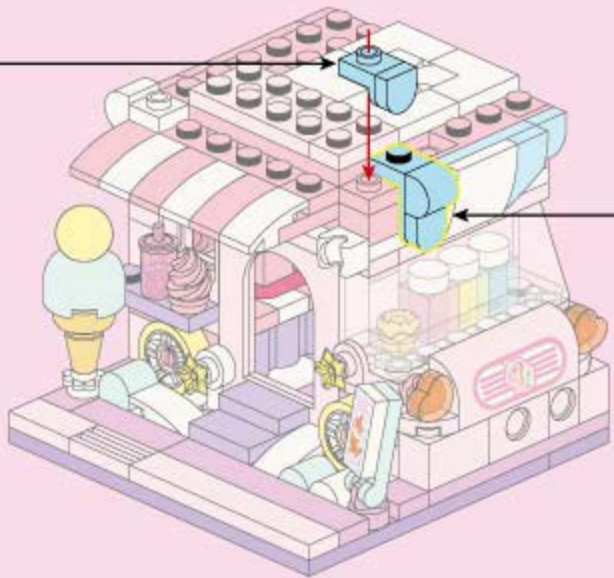
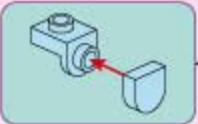
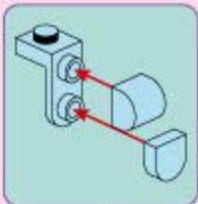
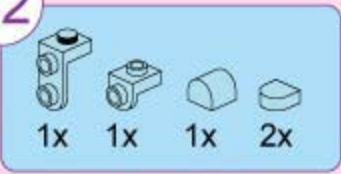

43



1x



1x



1x



1x

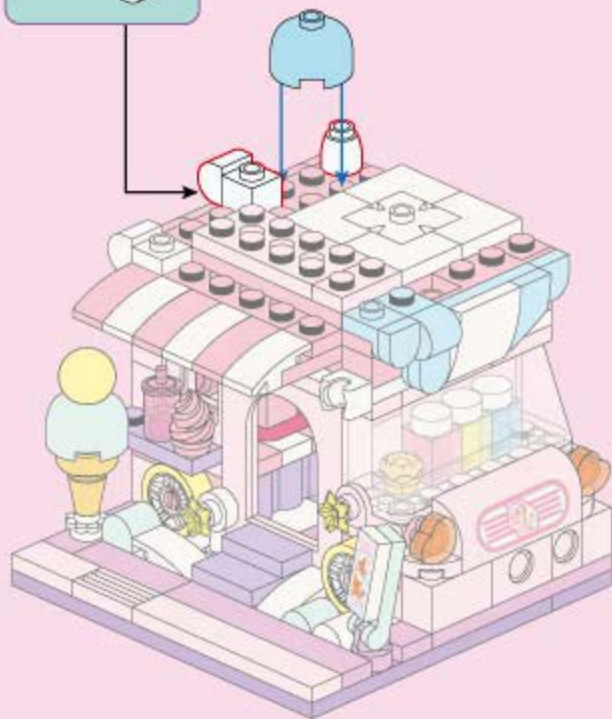
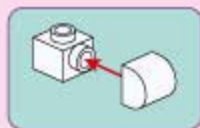
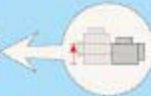

44



1x



1x

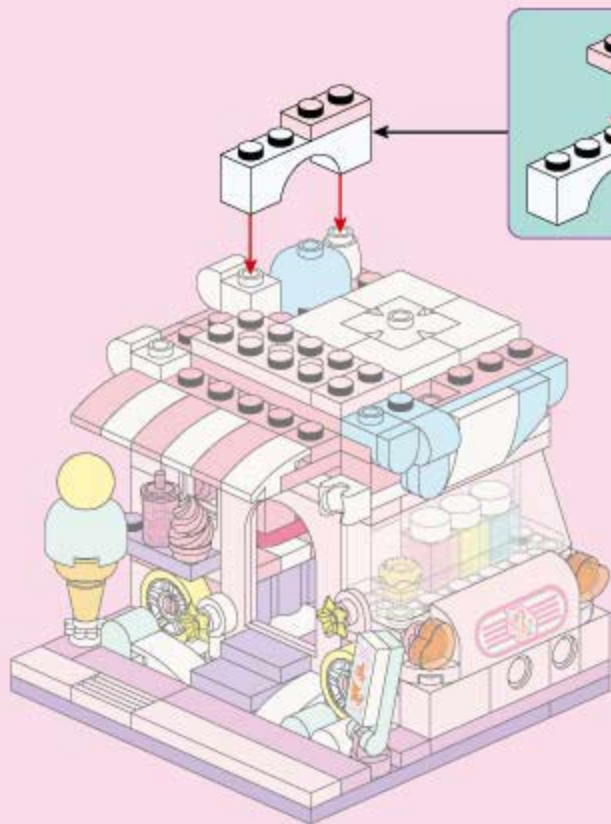

45

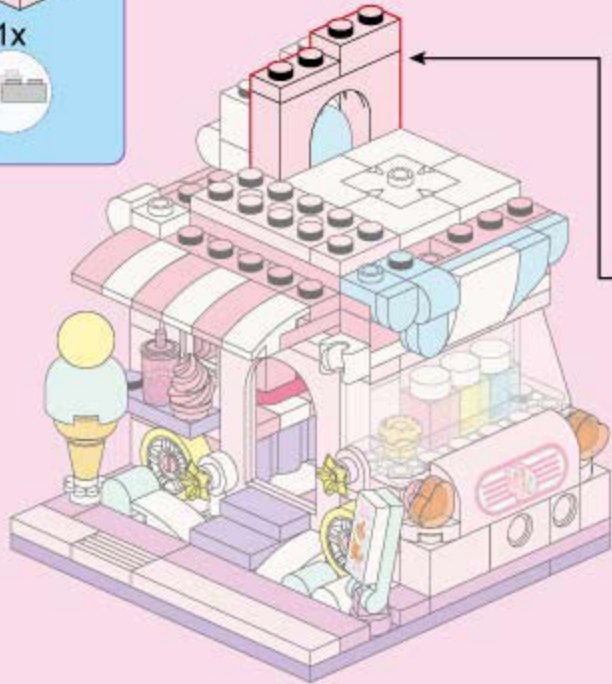
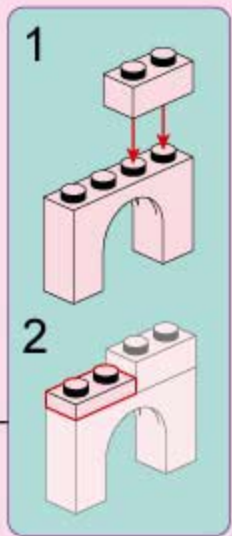
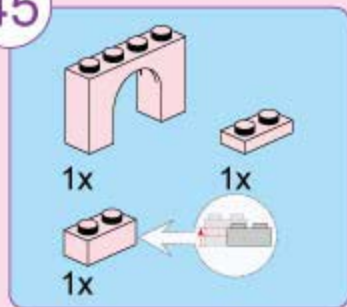

46

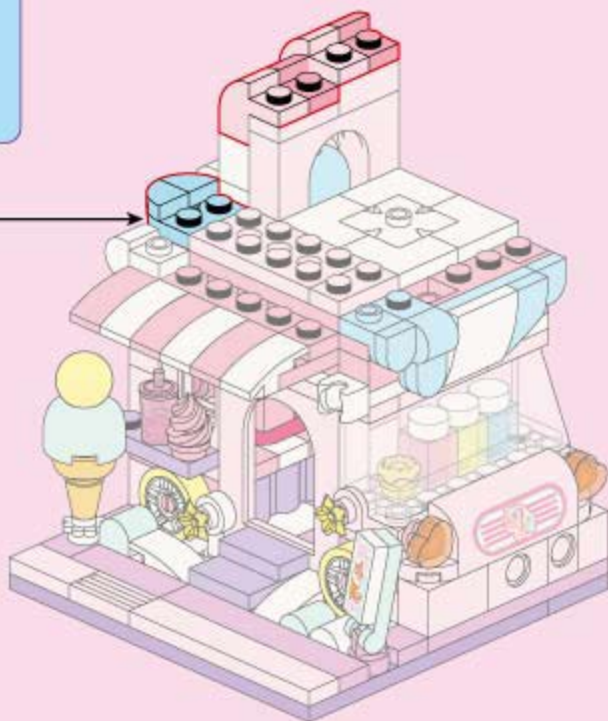
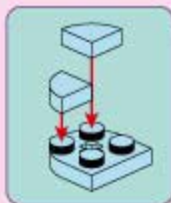
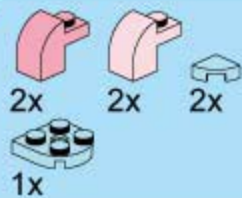

47

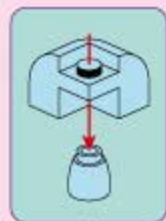
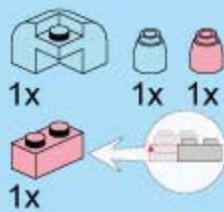

48



1x



1x



1x



1x



1x

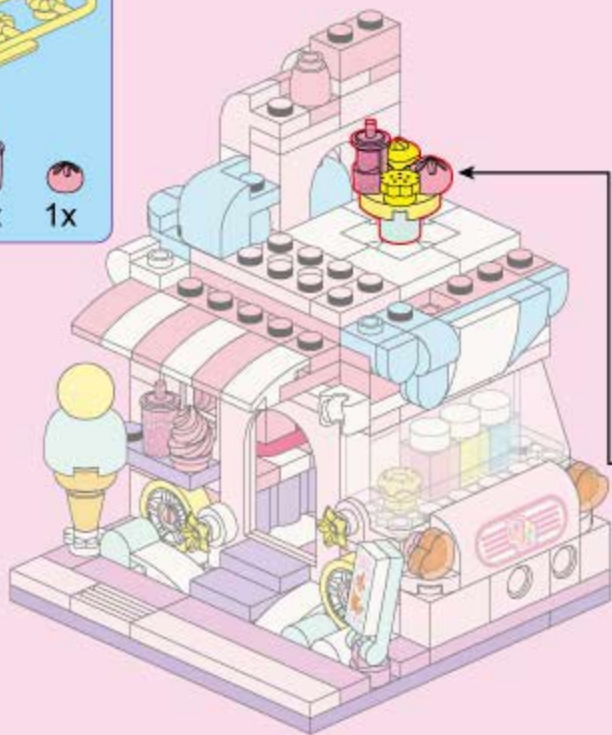

1



2



3



49

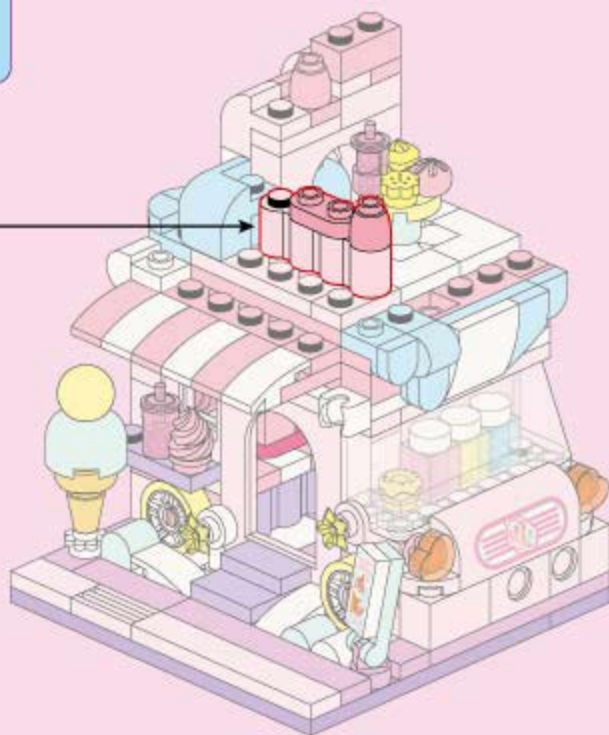
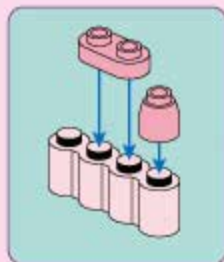
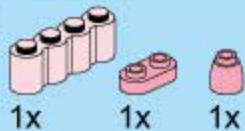

50

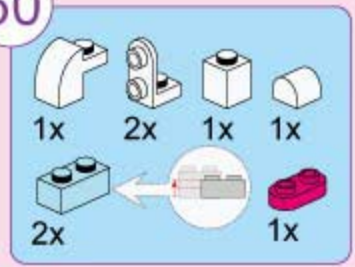

1x 2x 1x 1x  
2x 1x

This block lists the required parts for step 50. It includes: one white curved piece, two white L-shaped pins, one white square piece with a black dot, one white quarter piece, two grey 1x2 Technic bricks with two black pins, and one red 1x2 Technic brick. A circular inset shows a grey 1x2 Technic brick with two black pins being inserted into a hole in a white square piece.



1:1

An icon showing a grey 1x2 Technic brick with two black pins, indicating a 1:1 ratio of the brick to the pins.

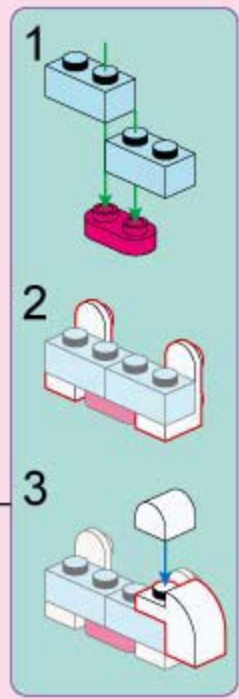
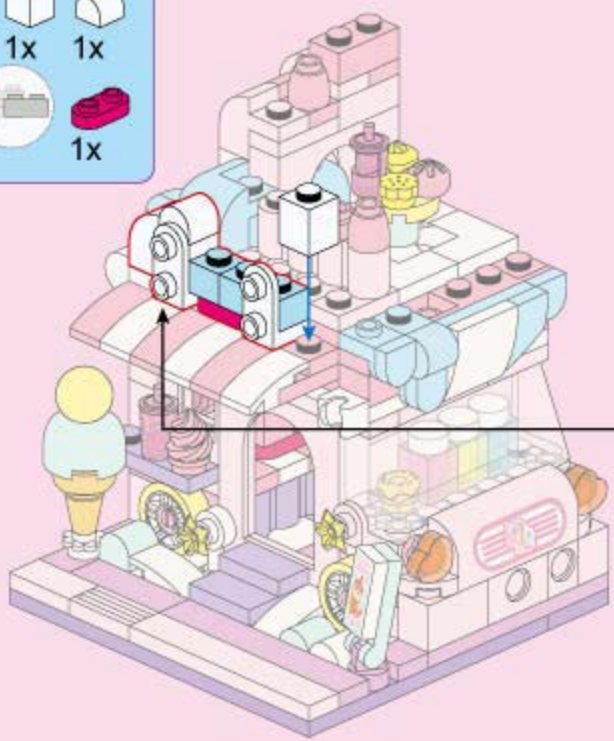

1  
2  
3

This block shows three steps of the assembly process. Step 1 shows a grey 1x2 Technic brick with two black pins being placed on top of a red 1x2 Technic brick. Step 2 shows a white curved piece being placed on top of the grey brick. Step 3 shows a white square piece with a black dot being placed on top of the white curved piece.

51



1x



1x



1x



1x



1x



1



2

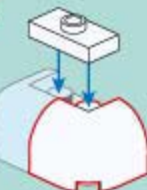

3



52

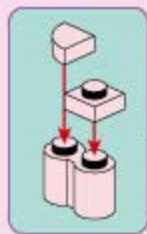
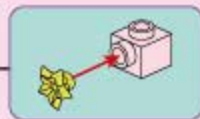
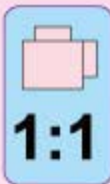
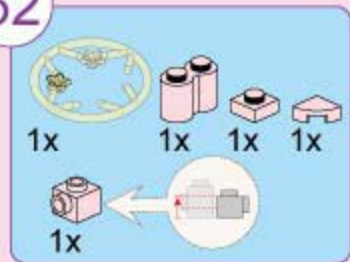

53

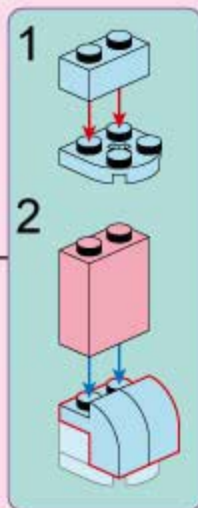
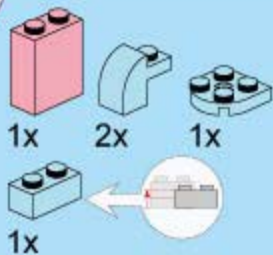



54

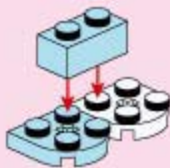
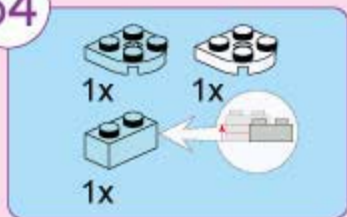

55



56

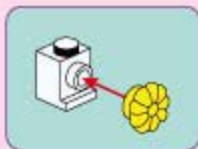

57

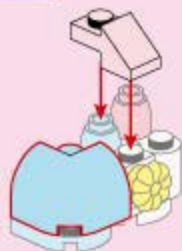
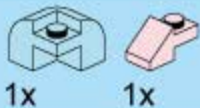

58

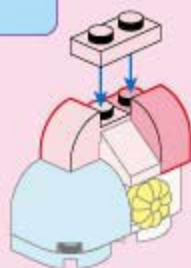
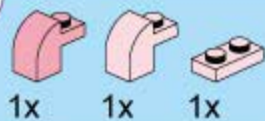

59

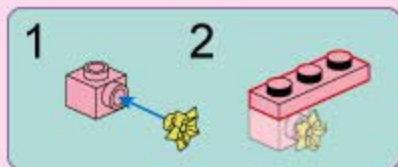
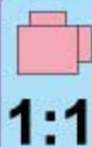
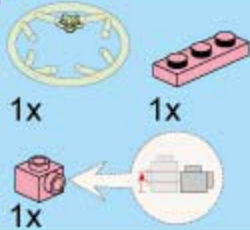

60



61



1x

1x

2x



62

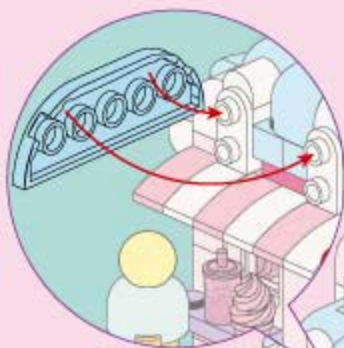
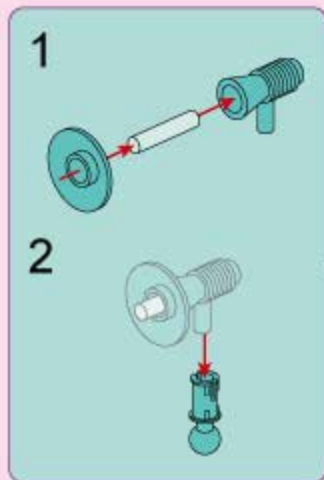



63



4

1x



1x



1x



64

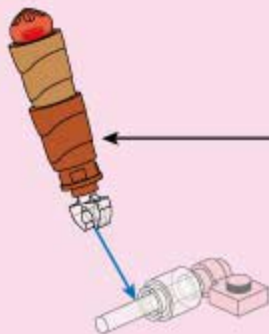
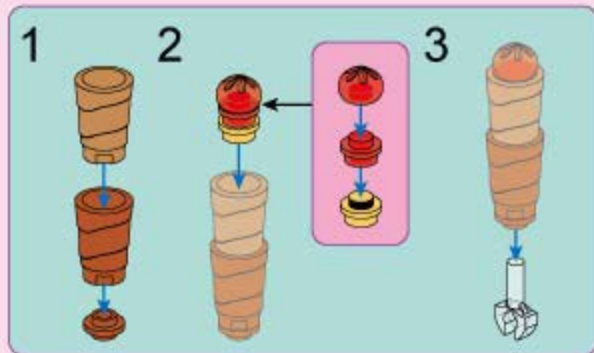

65



1x

66



1x



1x



1x

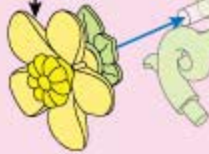
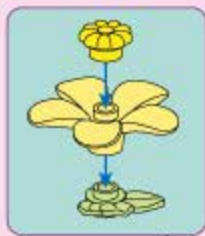

67

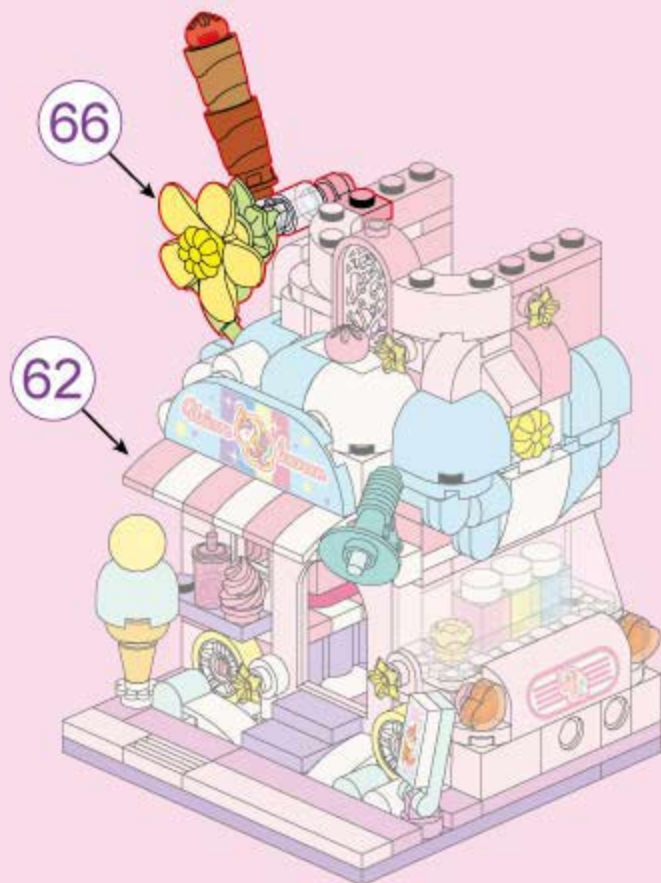

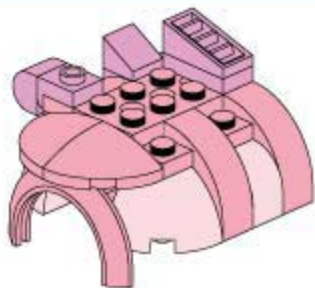

68

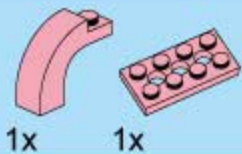

1x

1x



69

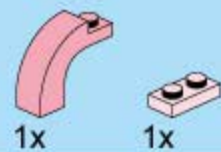

1x

1x

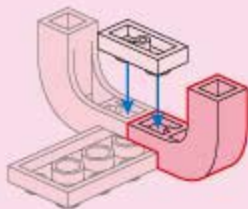

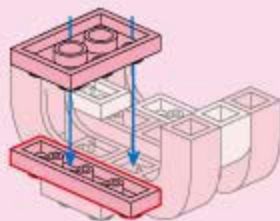
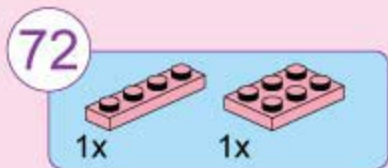
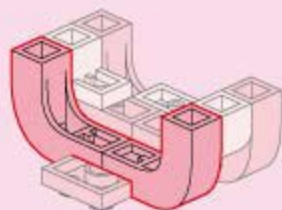
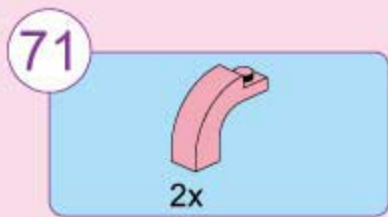
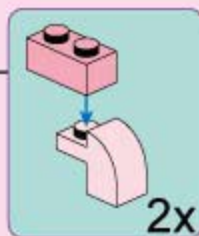
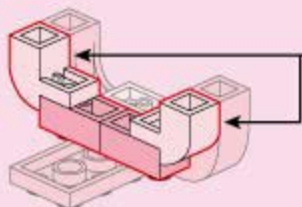
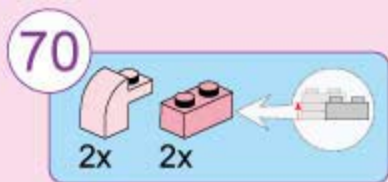

73



1x

1x

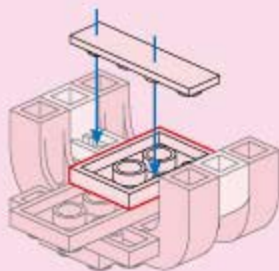

俯视图:

Top view:

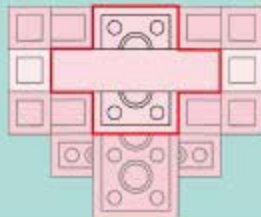

74



2x

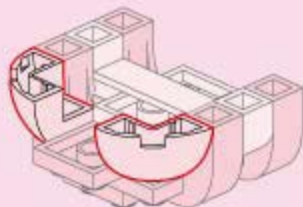

俯视图:

Top view:



75



1x

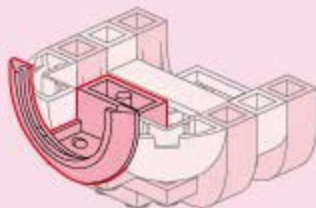

76

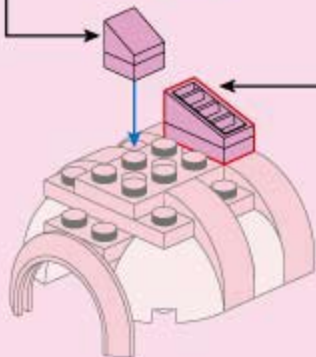
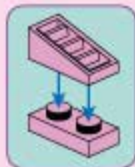
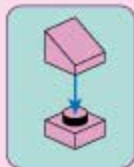

77

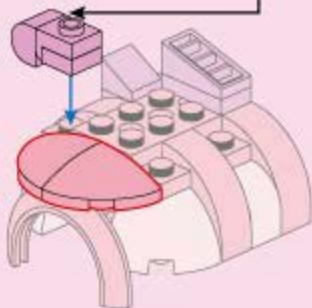
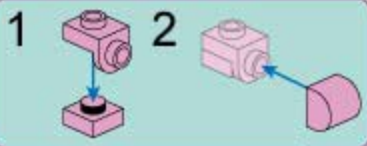
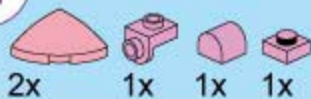

78





79

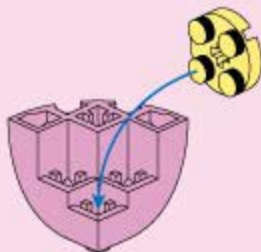

80



81

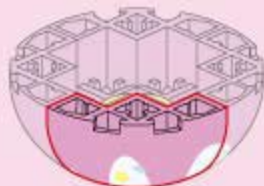

82

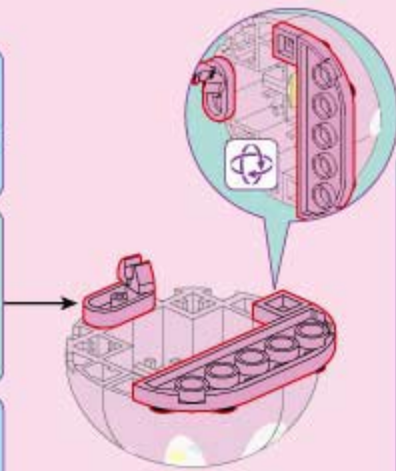
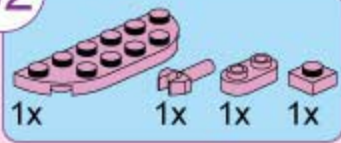

83

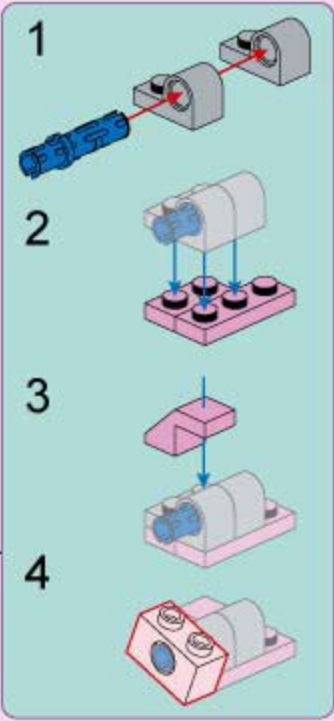
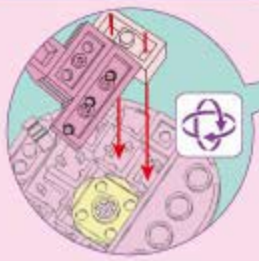
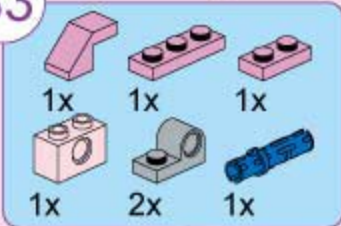

84



85

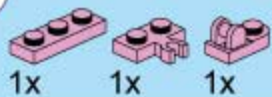

86

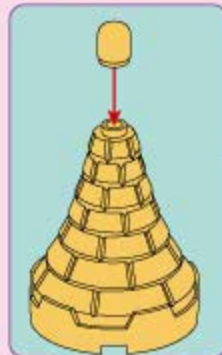
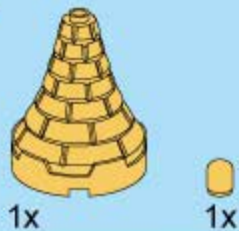

87



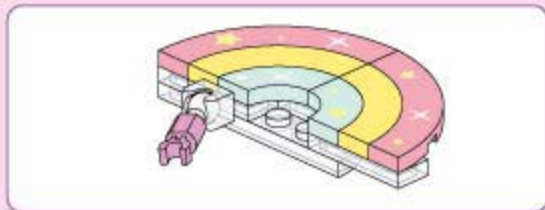

88

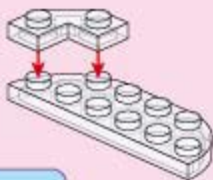
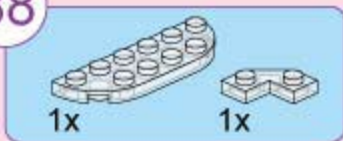

89



90

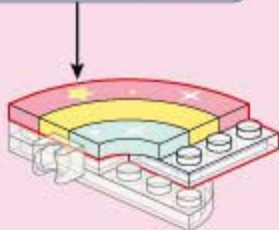
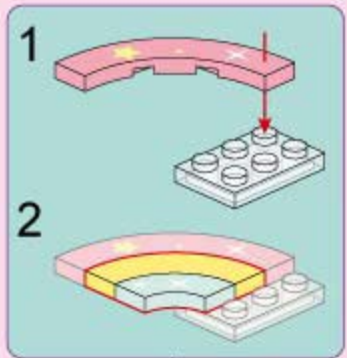
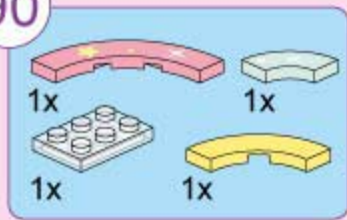

91

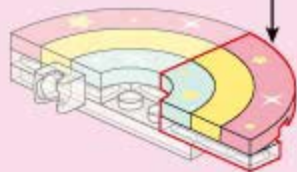
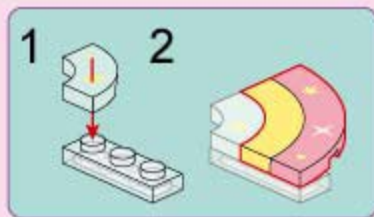
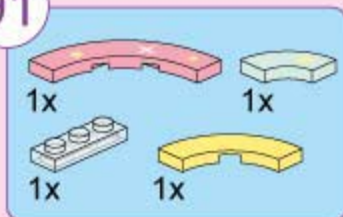

92

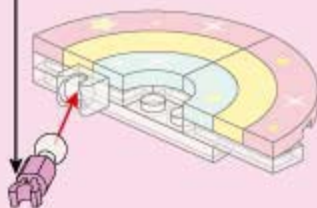

93



City Corner X 奇幻童话镇  
缤纷街景

V1.0