

# 42209 (8in1)

## QMAN USER MANUAL

25

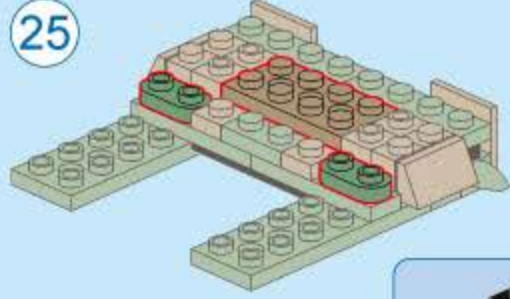

26

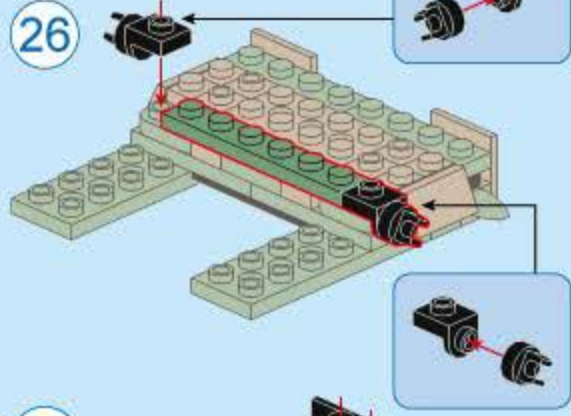

27

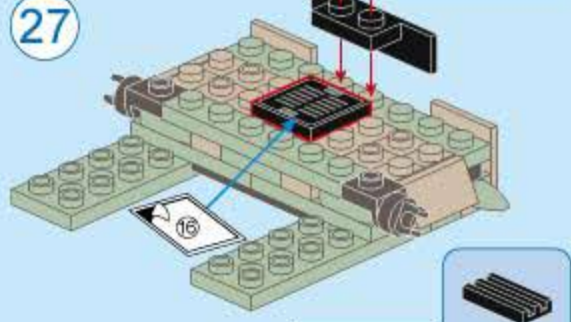

28

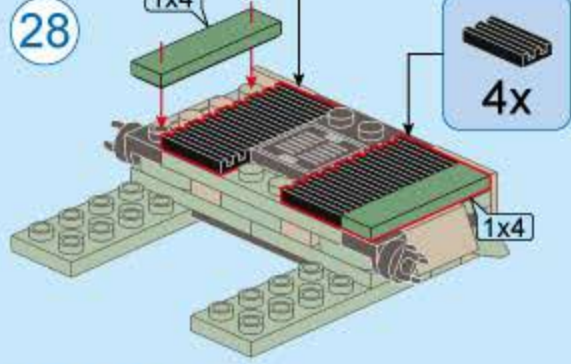

29

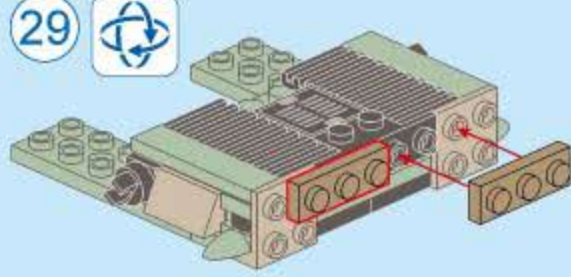

30

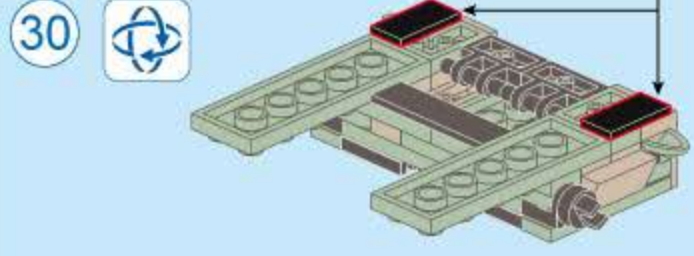

31

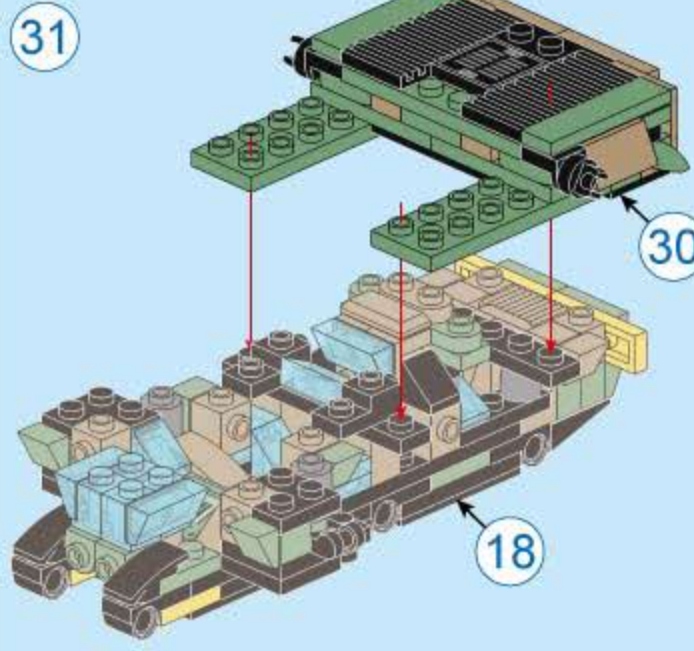

32

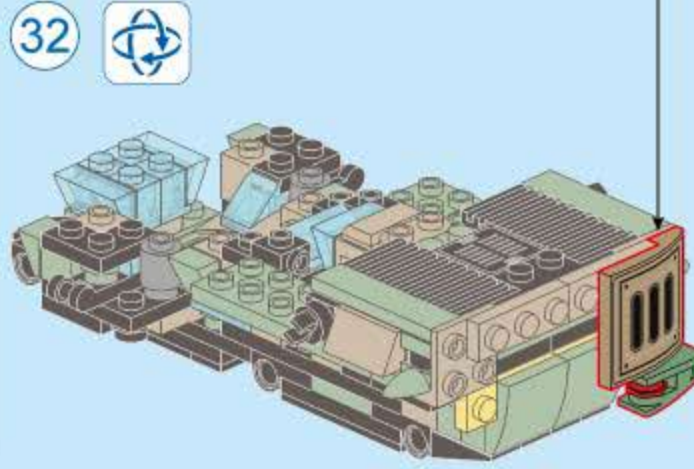

33

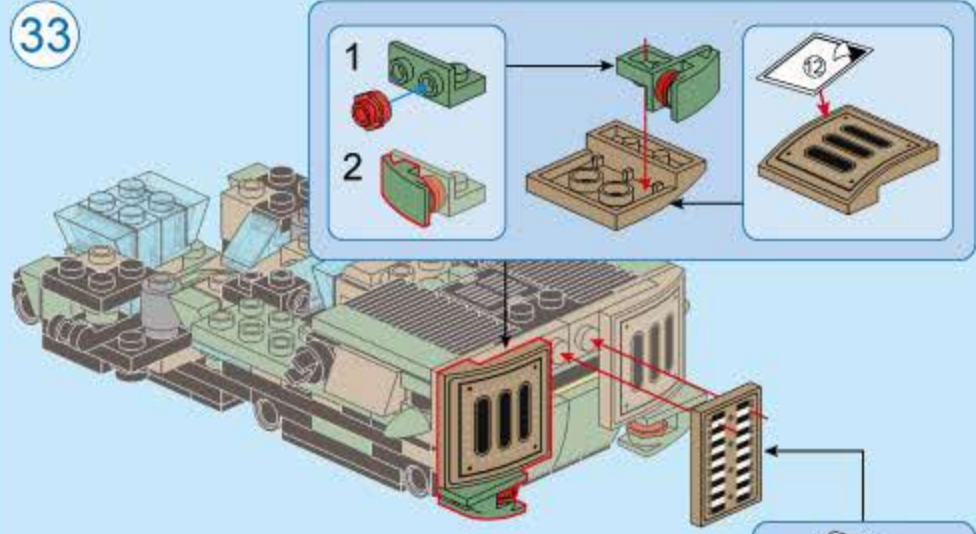

34

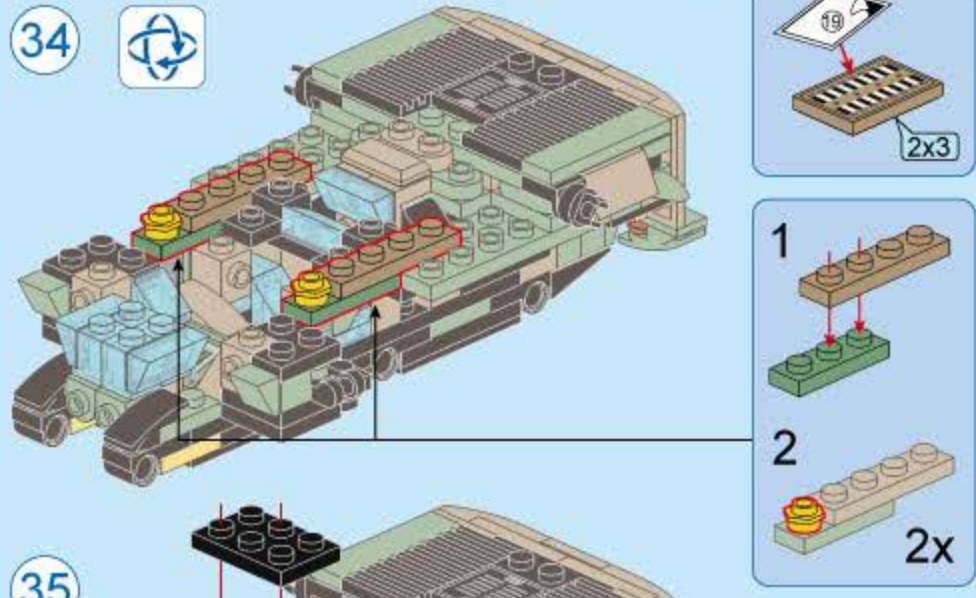

35

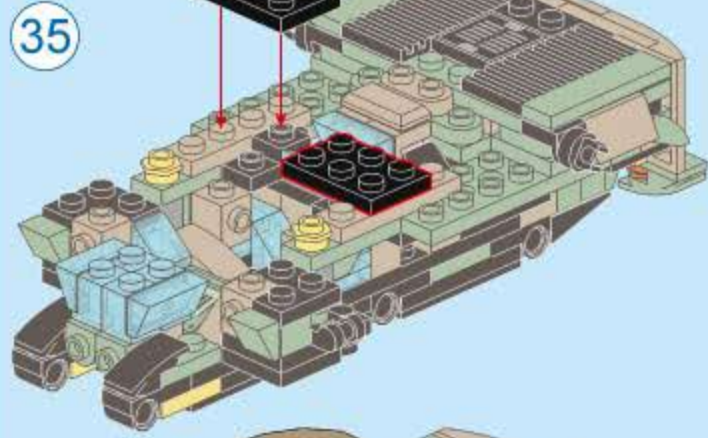

36

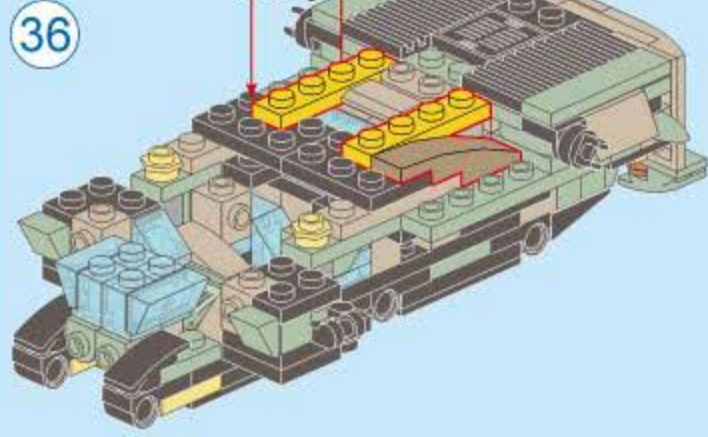

2x

4x

4x

2x3

2x