



# 奇妙积木

KEEP  
PLEY

78032  
赵云  
辉煌纪元

王者荣耀

拼装模型  
超星版



正版授权积木

© 2024 Tencent. All Rights Reserved.  
腾讯公司 版权所有

## 英雄资料

78032

# 赵云

辉煌纪元

78032 HUIYAOJIIIA

未来，交给你了。

### 轮廓升级

精致轮廓设计，结构更紧密



18处可动关节，更多战斗姿势等你解锁



## 拼装模型超星版

78032  
赵云  
辉煌纪元

78034  
马超  
幸存者

78033  
宫本武藏  
未来纪元

78031  
吕布  
末日机甲

### 贴纸使用说明

- 使用贴纸前请确认表面无任何灰尘或油污等物质,以确保最好的粘贴效果。
- 避免过度拉扯或挤压贴纸,以免导致贴纸变形或开裂。
- 较细小的贴纸可以使用镊子、夹子等工具辅助,以获得更好的张贴体验。

### 板件注意事项

- 产品质量经过严格把控,板件图示与实物可能存在细微差异。
- 如个别板件产生流纹、气泡现象,属正常现象。
- 运输过程如有个别板件脱落,属正常现象。



A1板件

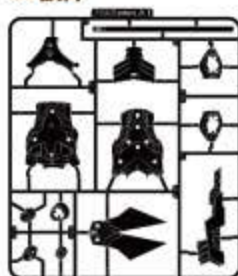

A2板件

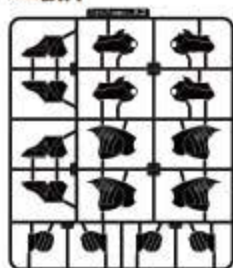

A3板件

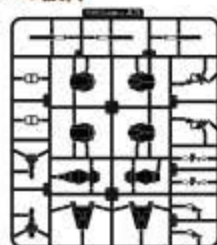

B板件



C板件



D板件

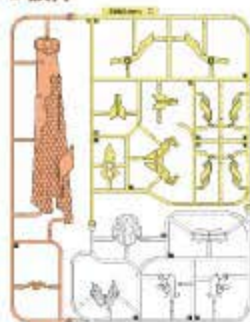

积木零件列表

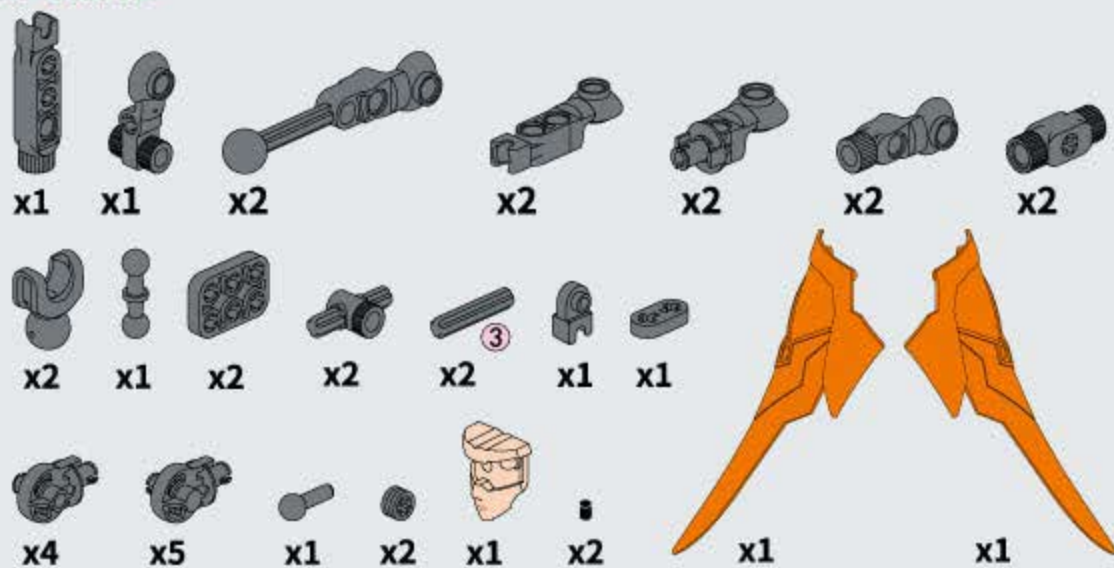

组装此款模型的方法

01 找到零件的编号

02 小心的将零件按压下来

03 将零件组合在一起

完成

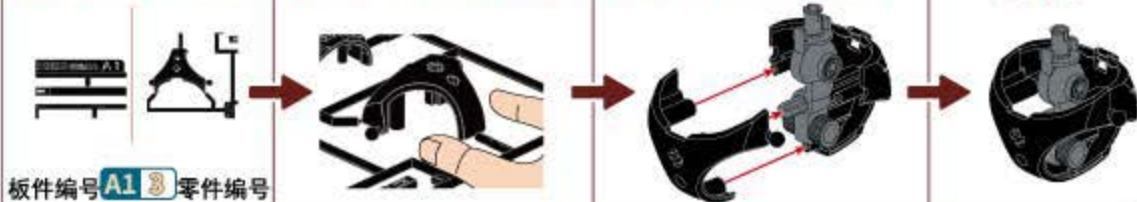

\*本产品采用免剪钳手拆式水口，按压取下零件时小心模型水口尖点

# 1 头部组件

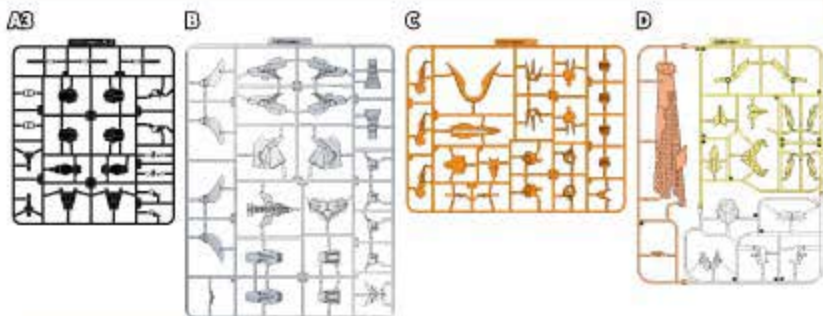

所需板件

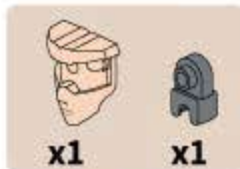

板件编码      零件编码

D1 X

1-1

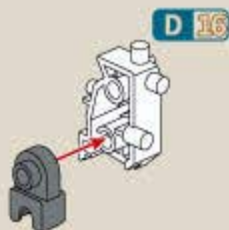

1-2

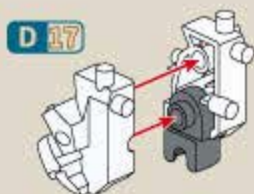

1-3

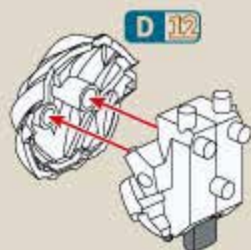

1-4



1-5



1-6

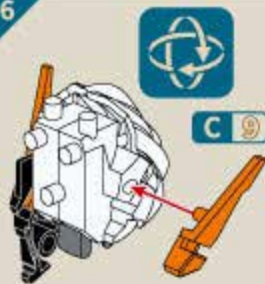

1-7



1-8

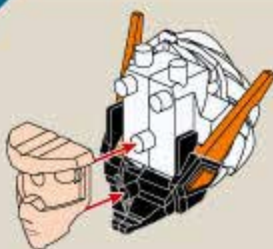

1-9



1-12



1-10

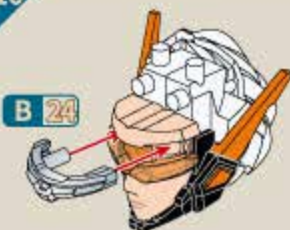

1-11



## 2 上身组件

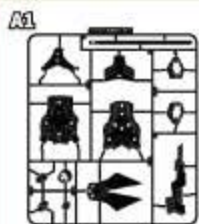

所需板件

板件编码 零件编码

D1 X

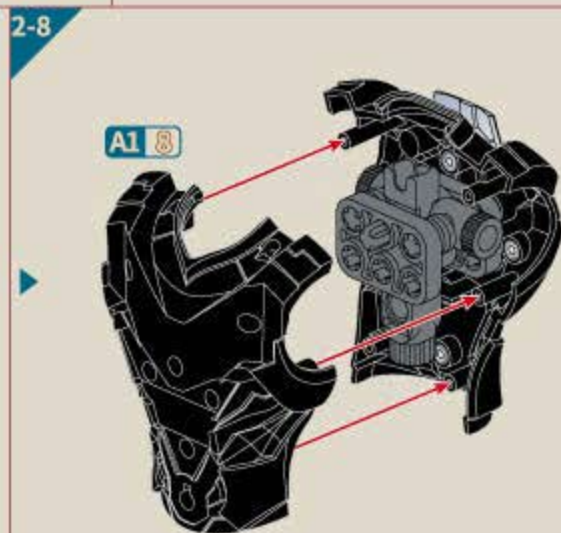
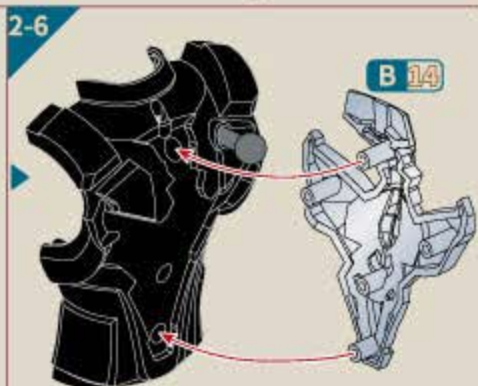
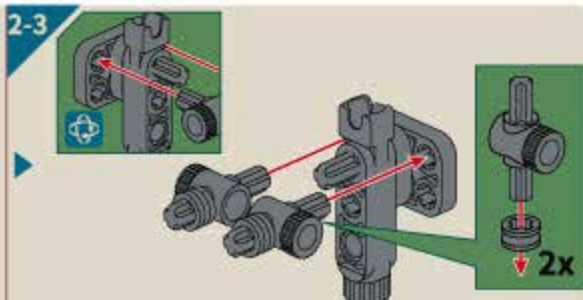
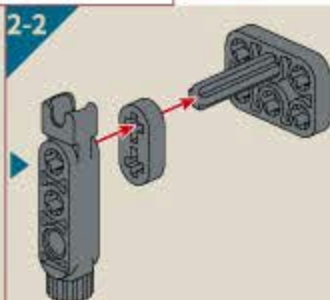
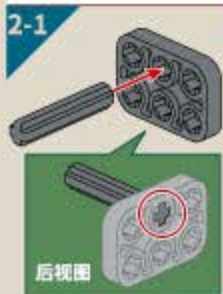
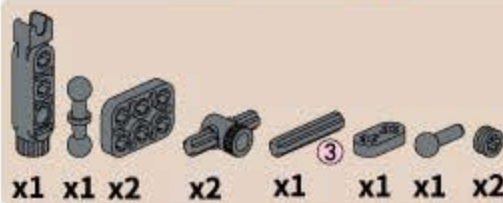

2-9

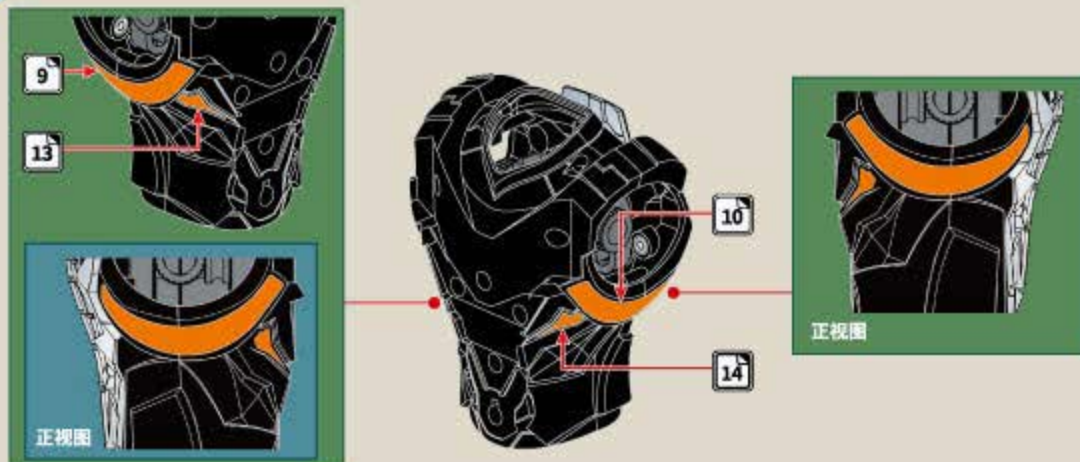

2-10

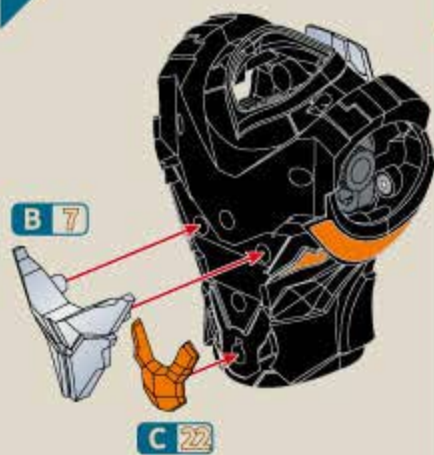

2-11

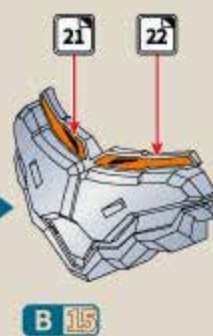

2-12

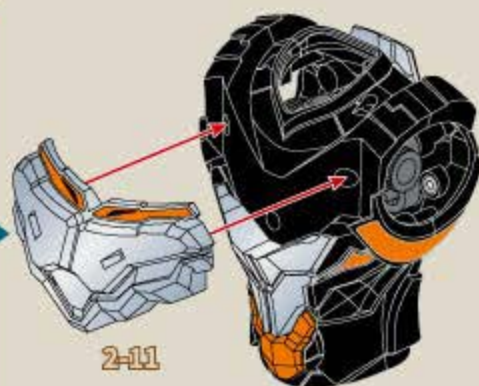

2-13

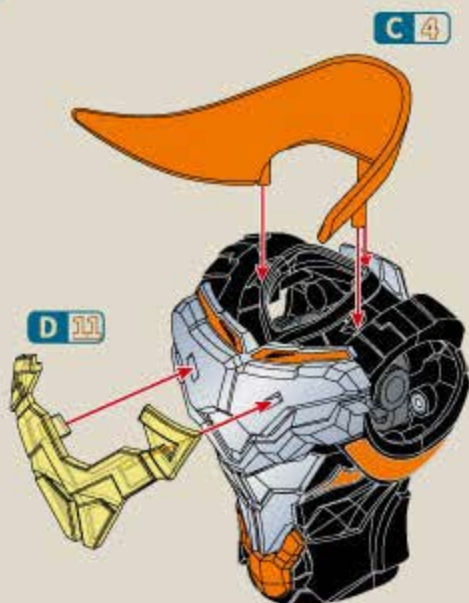

2-14

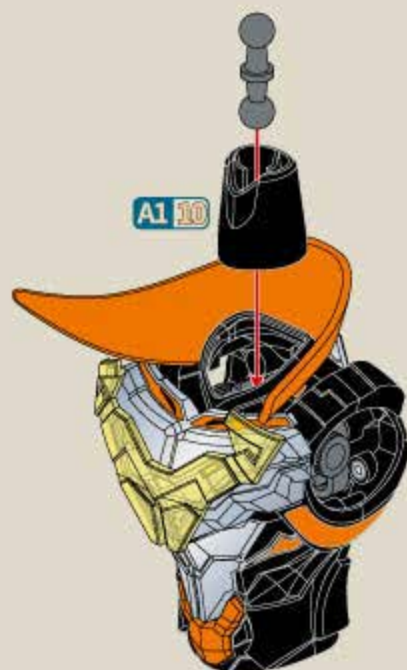

### 3 腰部组件



A1

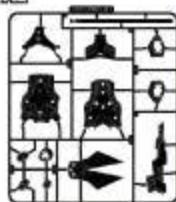

C



板件编码

零件编码

D1 X

所需板件

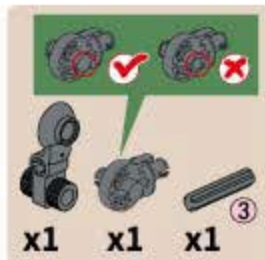

x1

x1

x1

3-1

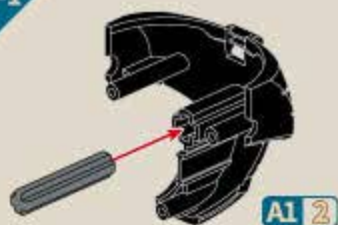

3-2

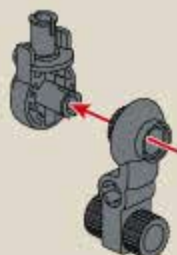

3-3

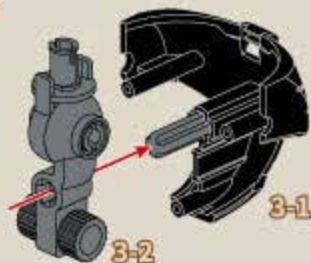

3-4

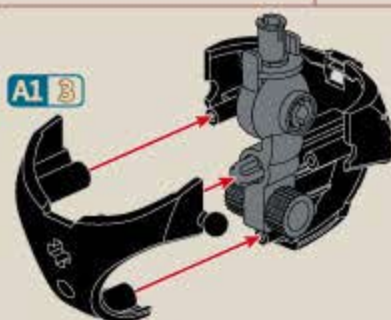

3-5

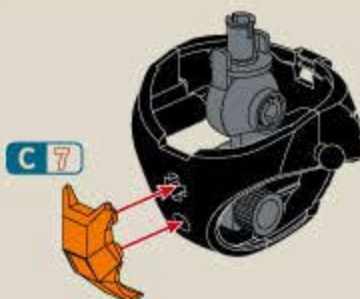

### 4 右手组件



A2

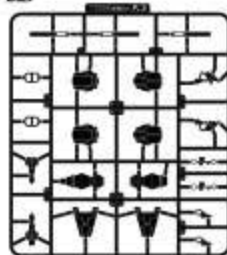

B



C



D

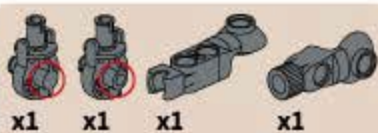

x1

x1

x1

x1

板件编码

零件编码

D1 X

所需板件

4-1

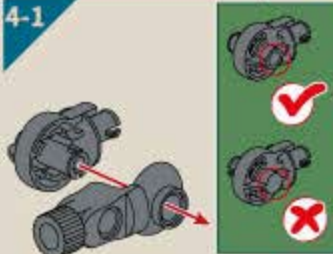

4-2

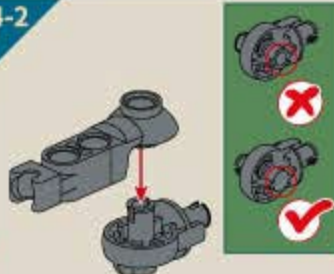

4-3

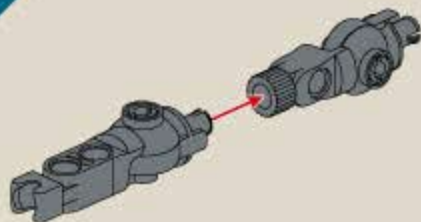

4-4

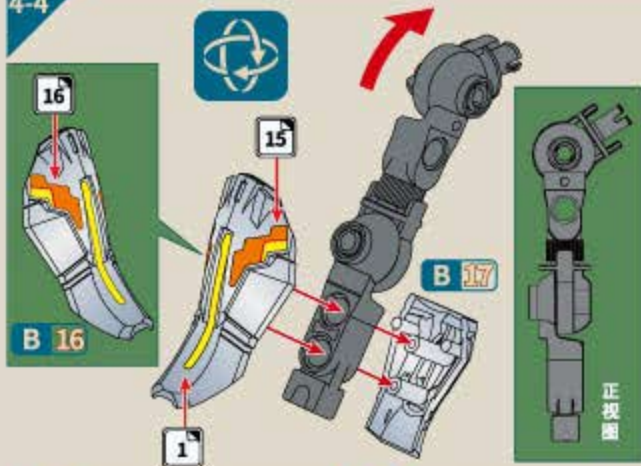

4-5

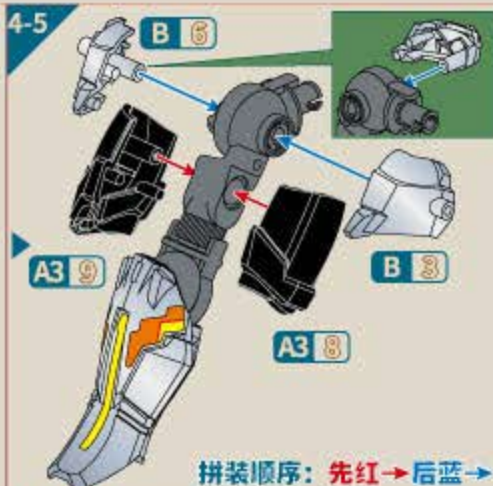

4-6

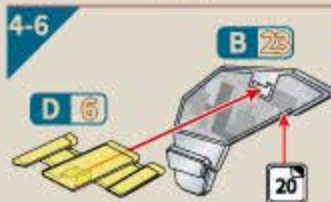

4-8

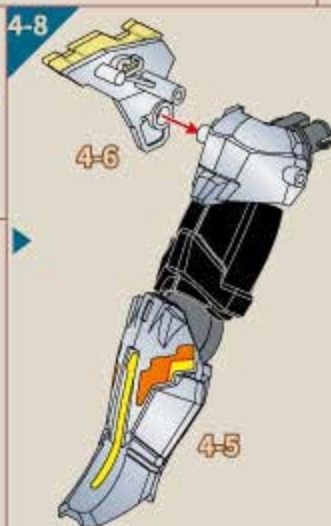

4-9

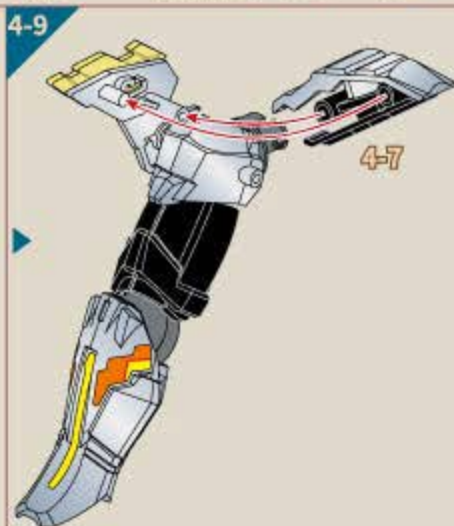

4-7

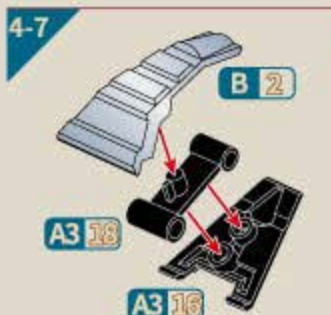

4-10

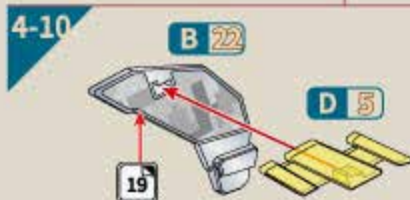

4-12



4-14

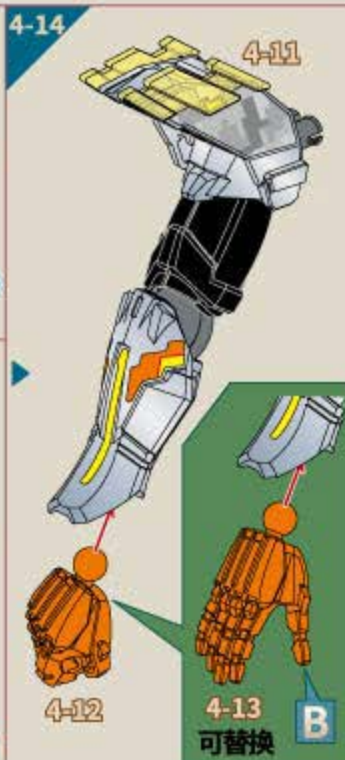

4-11

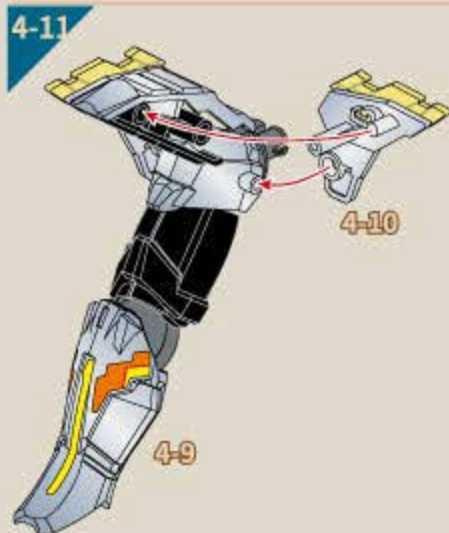

4-13

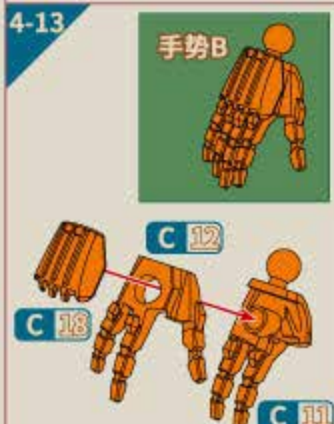

# 5 左手组件

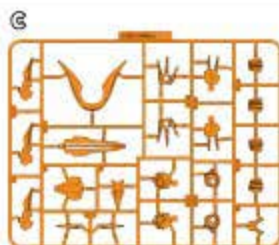
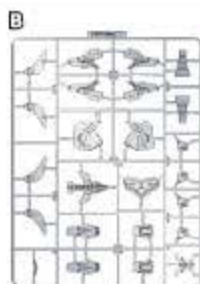
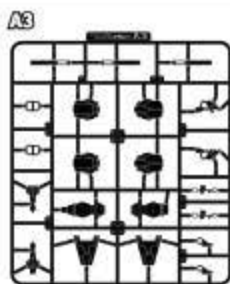

所需板件

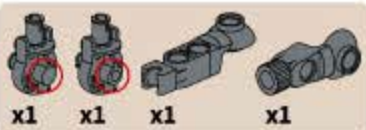

板件编码: D1  
零件编码: X

5-1

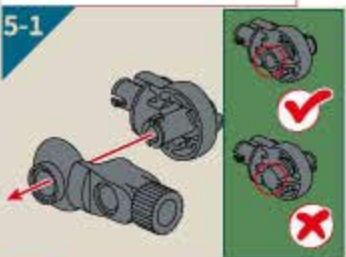

5-2

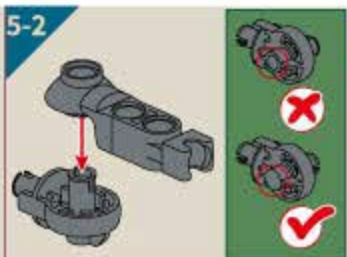

5-3

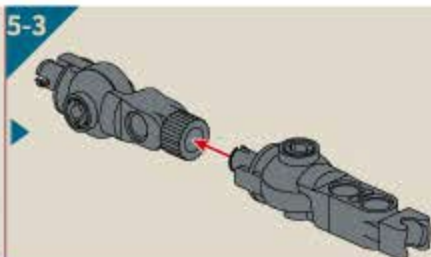

5-4

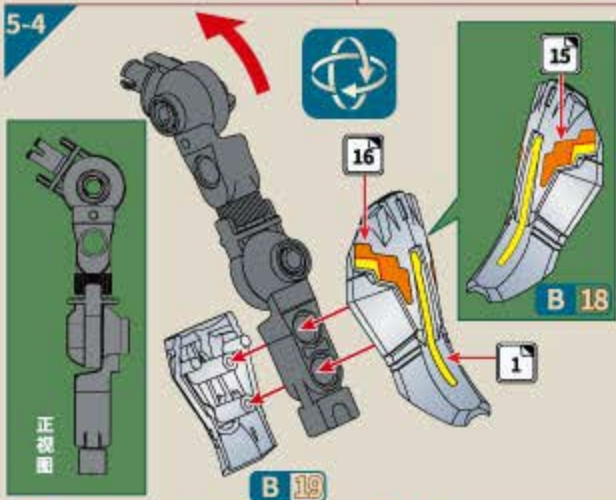

5-5

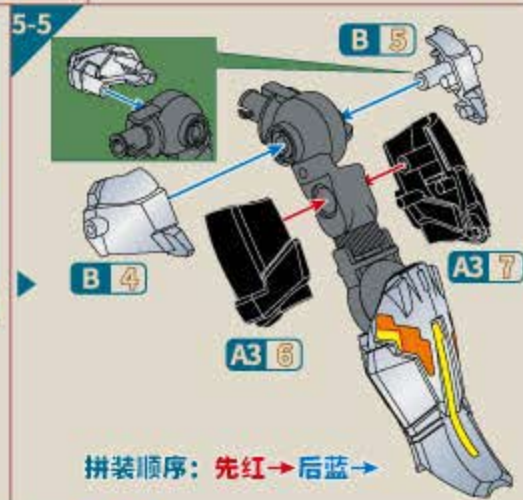

拼装顺序: 先红→后蓝→

5-6

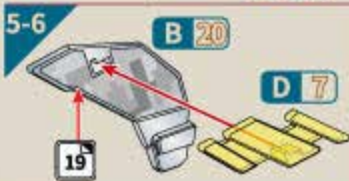

5-8

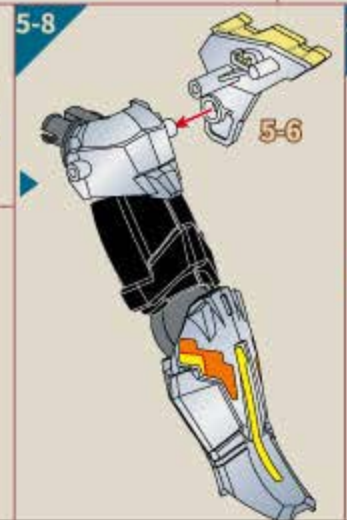

5-9

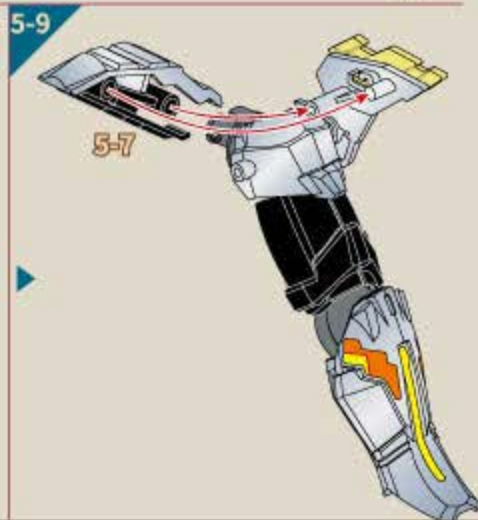

5-7

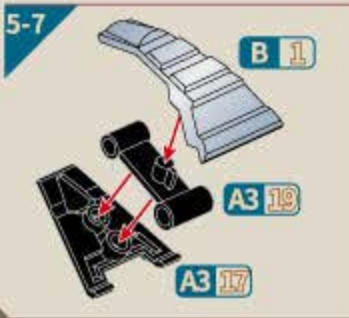

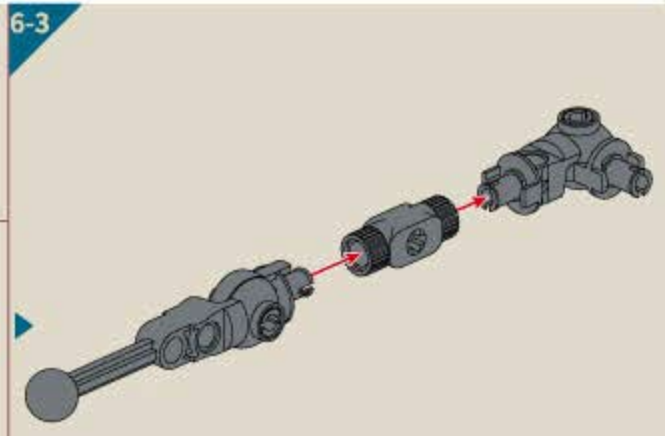
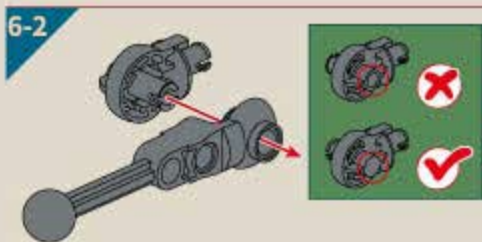
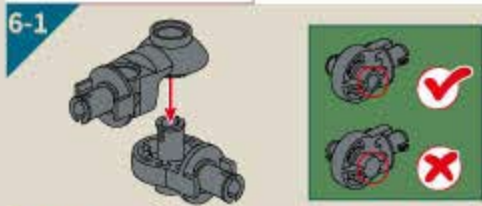
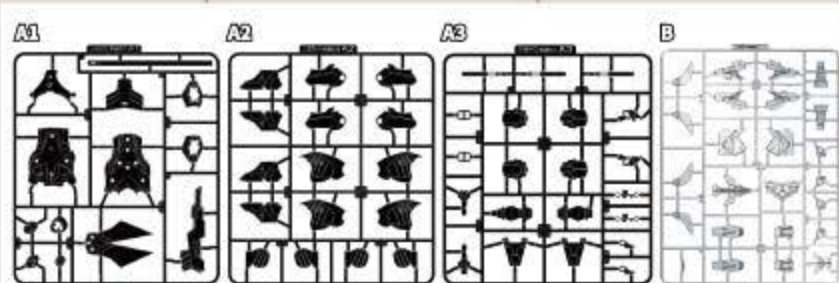
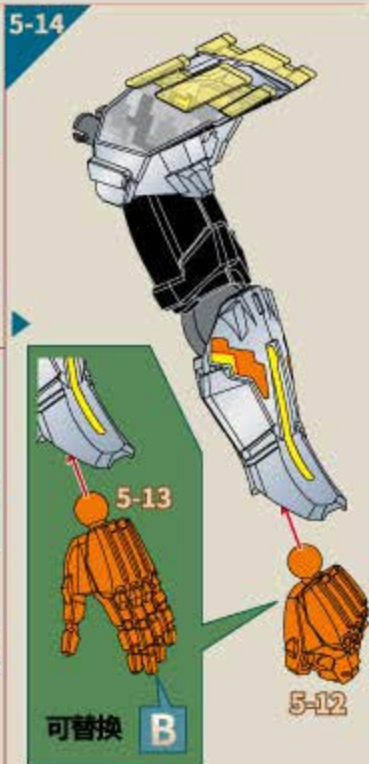
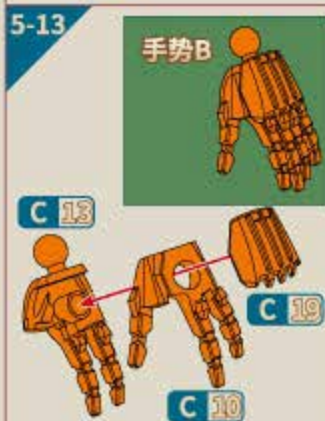
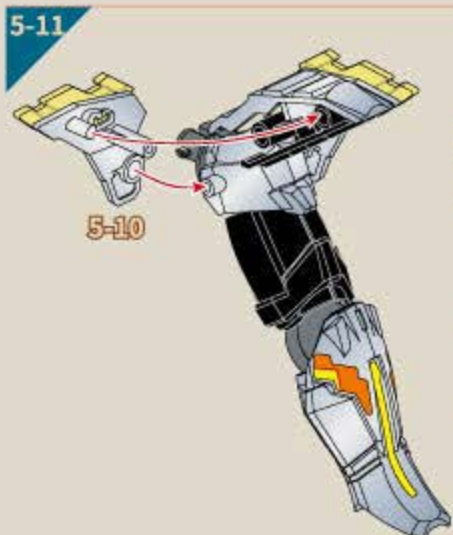
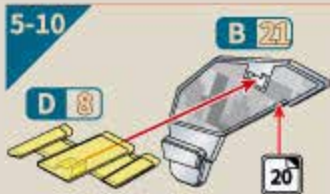

6-4

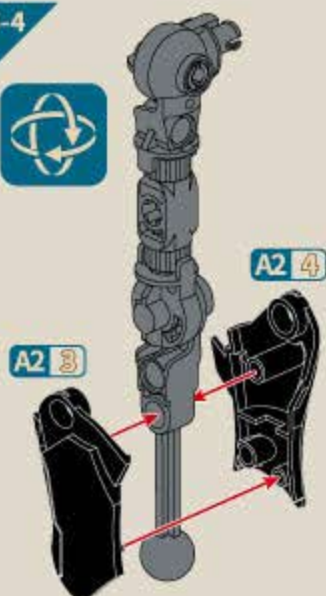

6-5

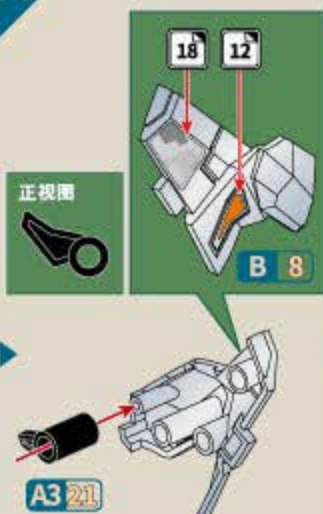

6-6

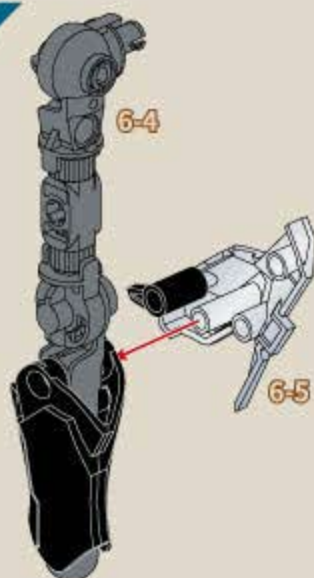

6-7

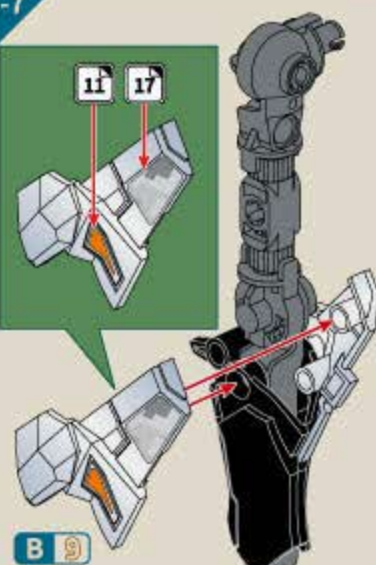
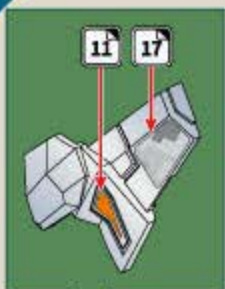

6-8

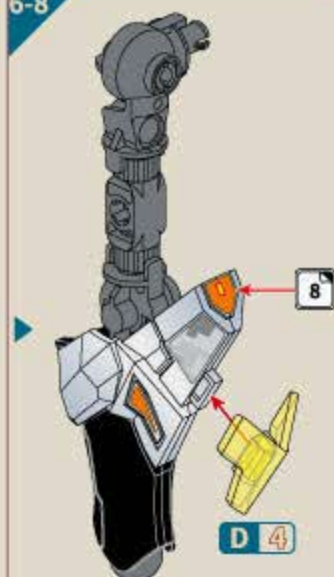

6-9

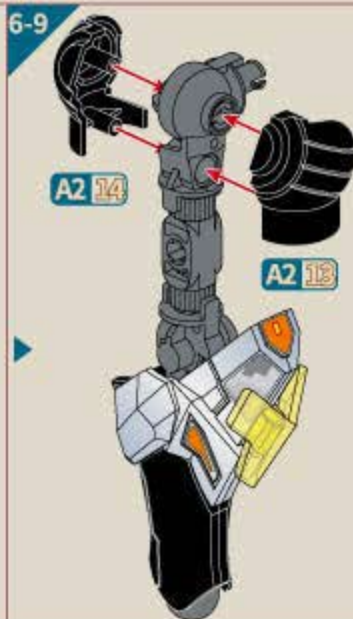

6-10

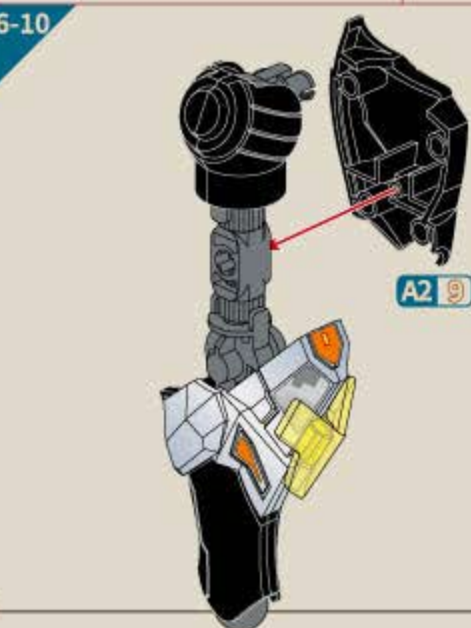

6-11

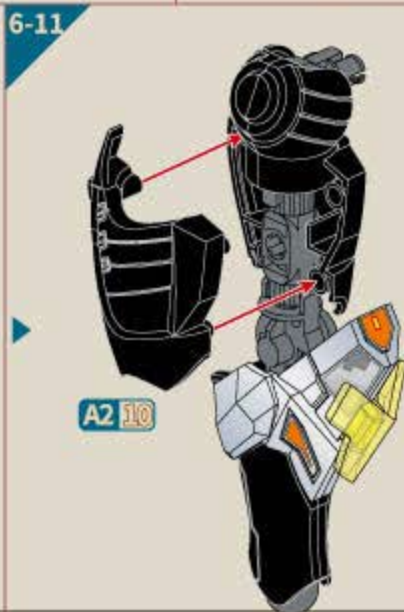

6-12

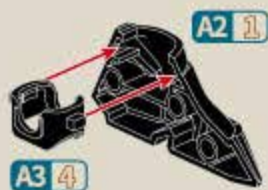

6-14

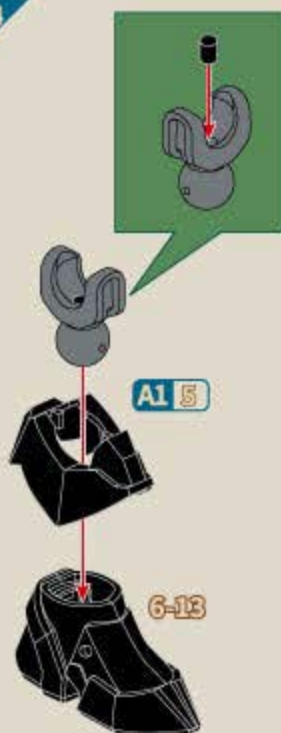

6-15



6-13

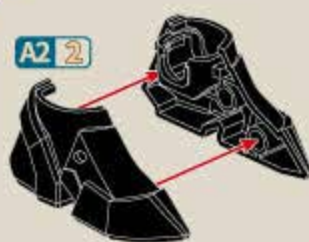

## 7 左脚组件

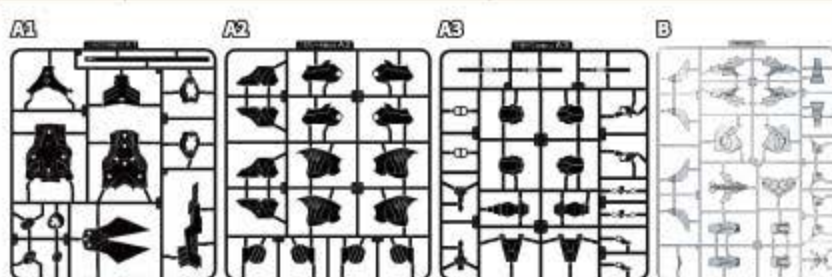

所需板件



板件编码 零件编码

D1 X

x1

x1

x1

x1

x1

x1

x1

7-1

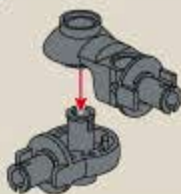

7-3

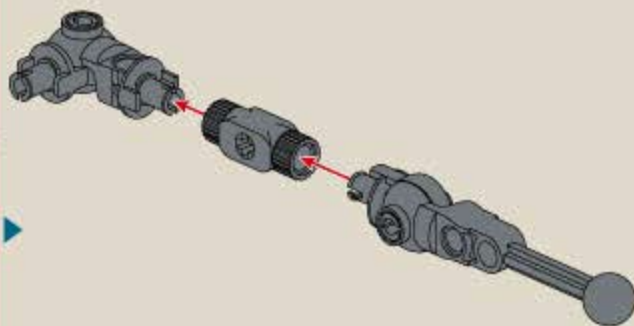

7-2

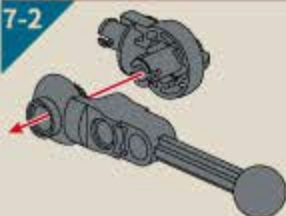

7-4

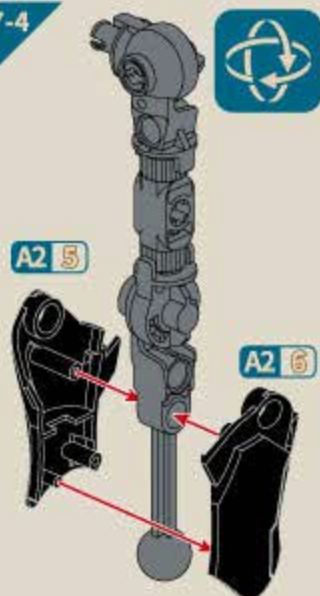

7-5

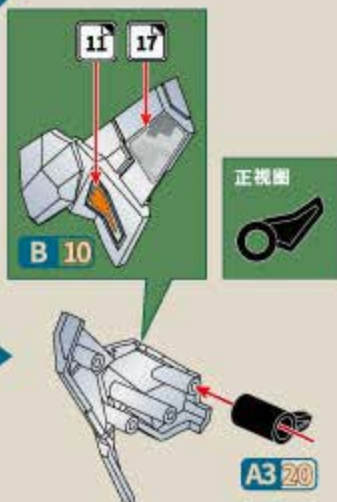

7-6

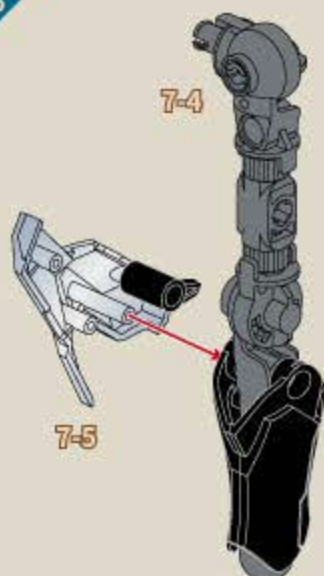

7-7

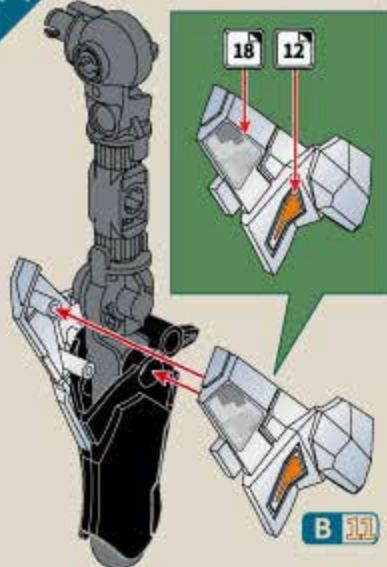

7-8

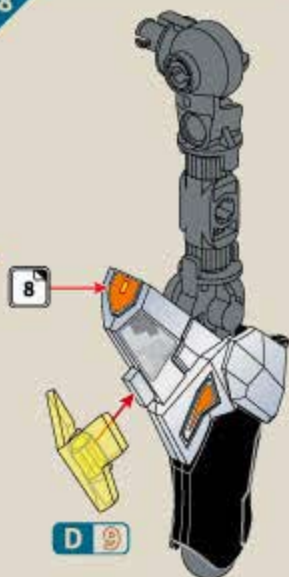

7-9

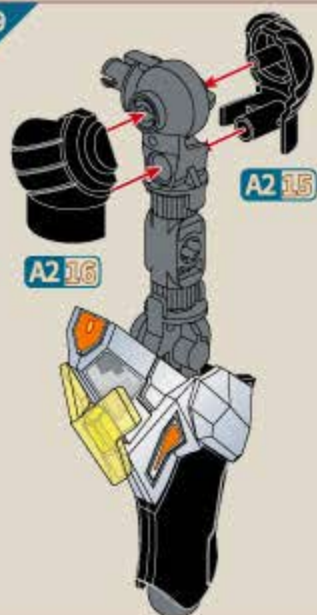

7-10

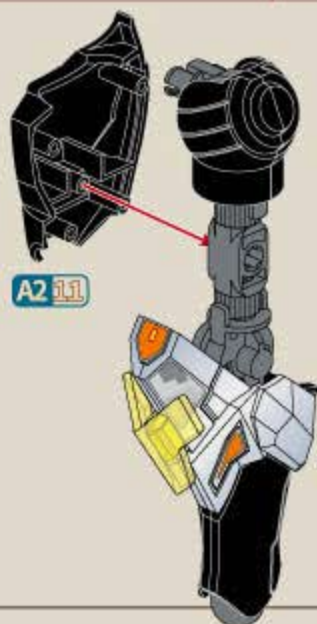

7-11

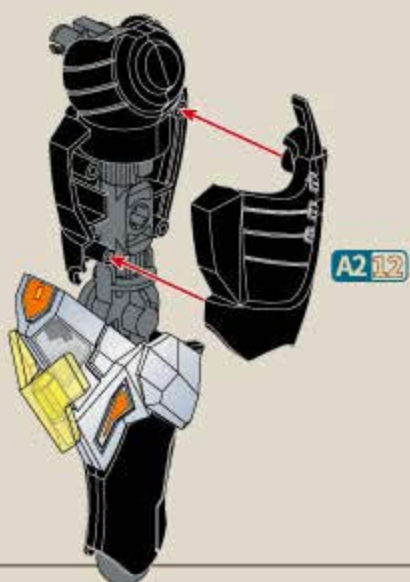

7-12



7-14

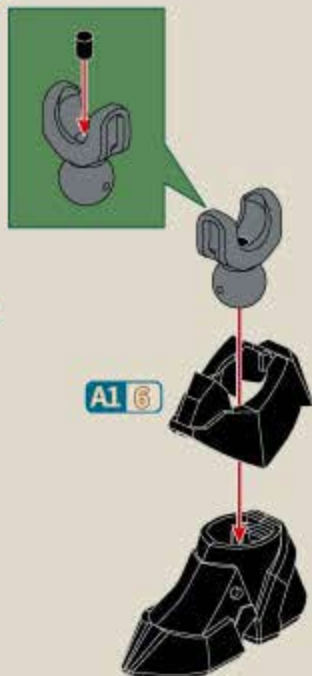

7-15



7-13

8  
右裙甲组件

B



D

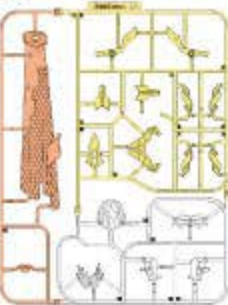

所需板件



板件编码

零件编码

D1 X

8-1

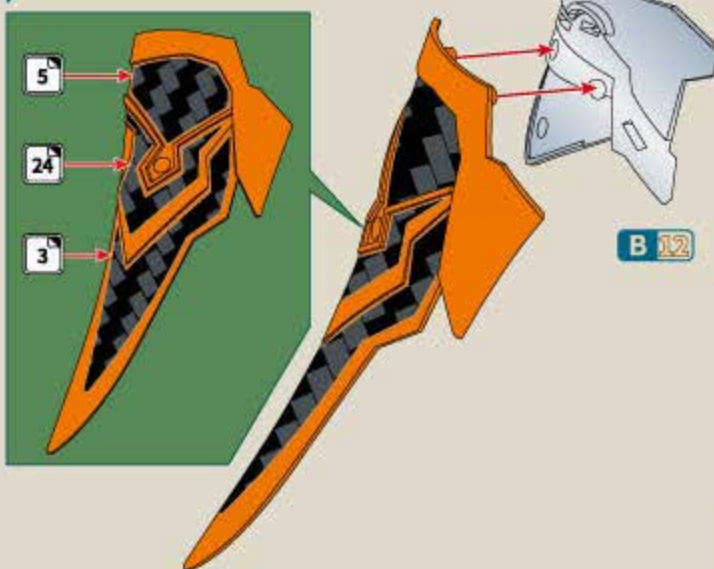

8-2



9 左裙甲组件

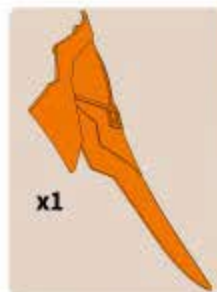
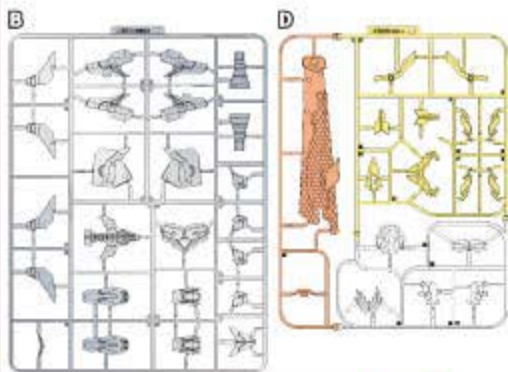

所需板件

板件编码 零件编码  
D1 X

9-1

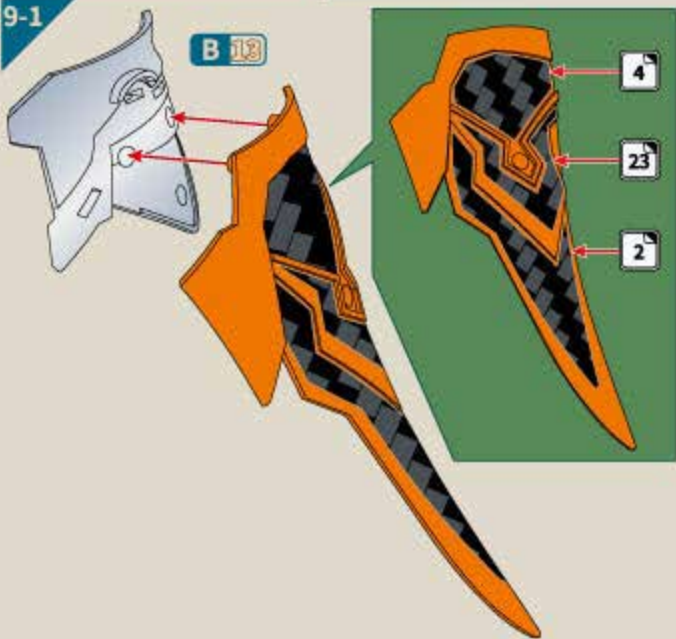

9-2



10 后裙甲组件

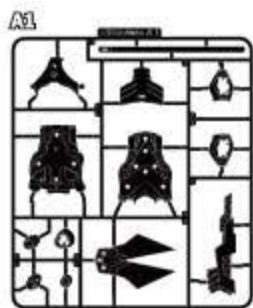

所需板件

板件编码 零件编码  
D1 X

10-1

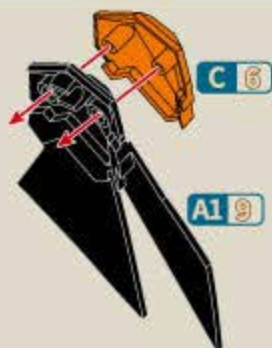

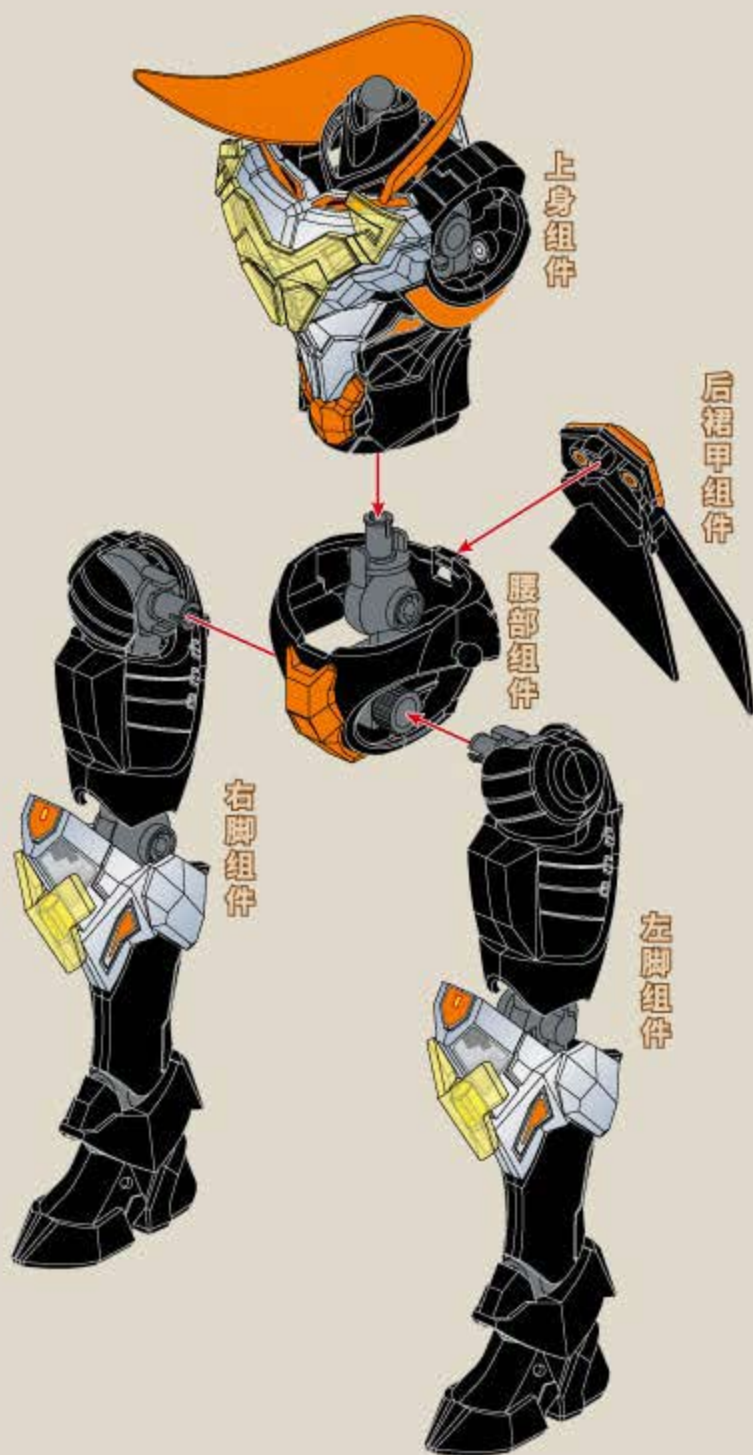

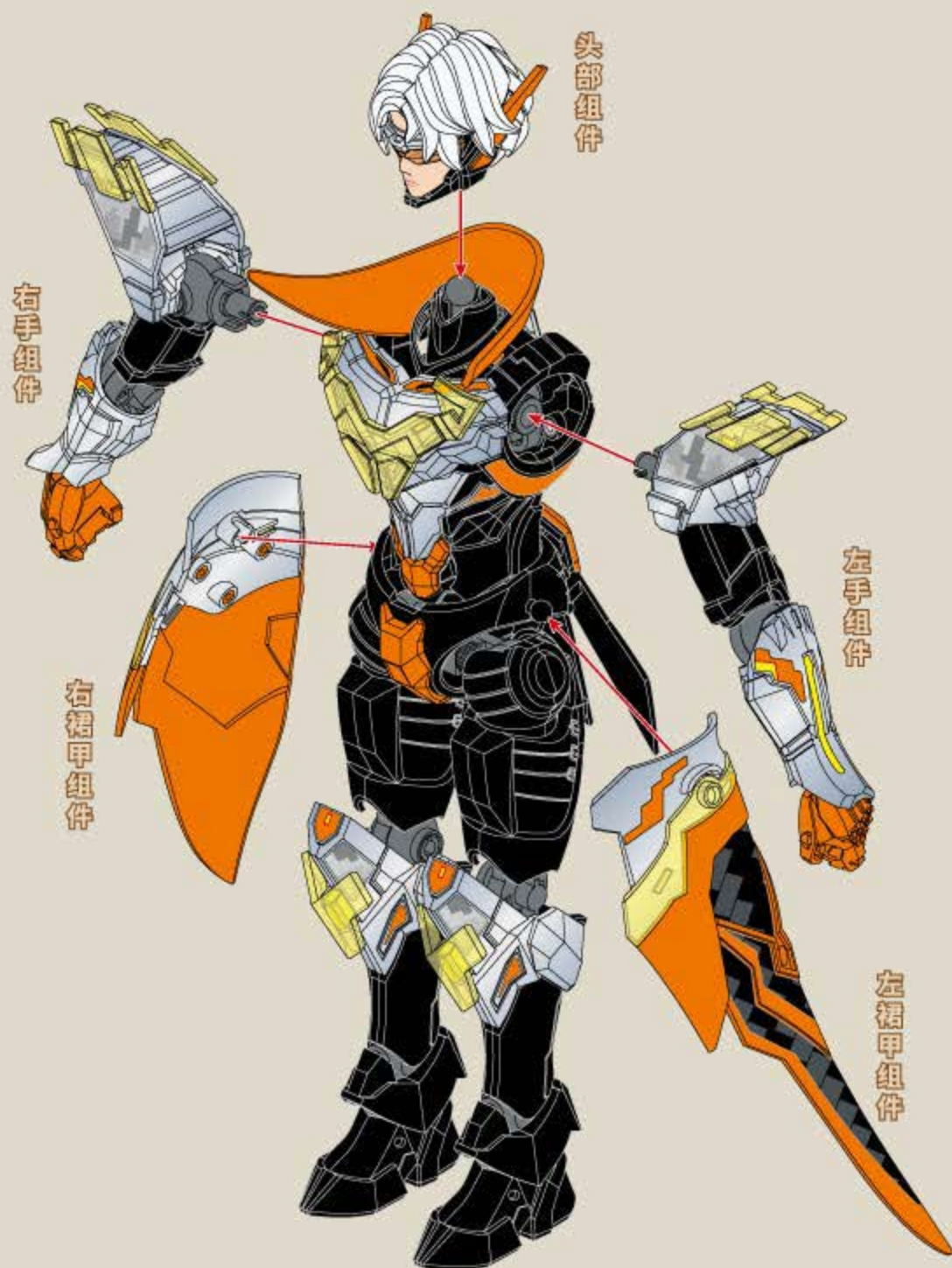

# 11 披风组件

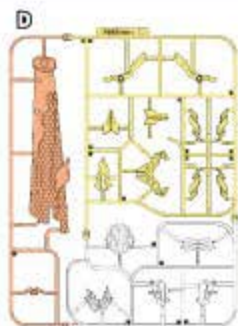
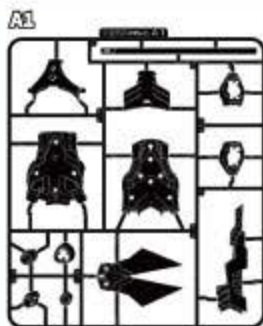

# 所需板件

板件编码      零件编码  
D1 X

## 11-1



## 11-2

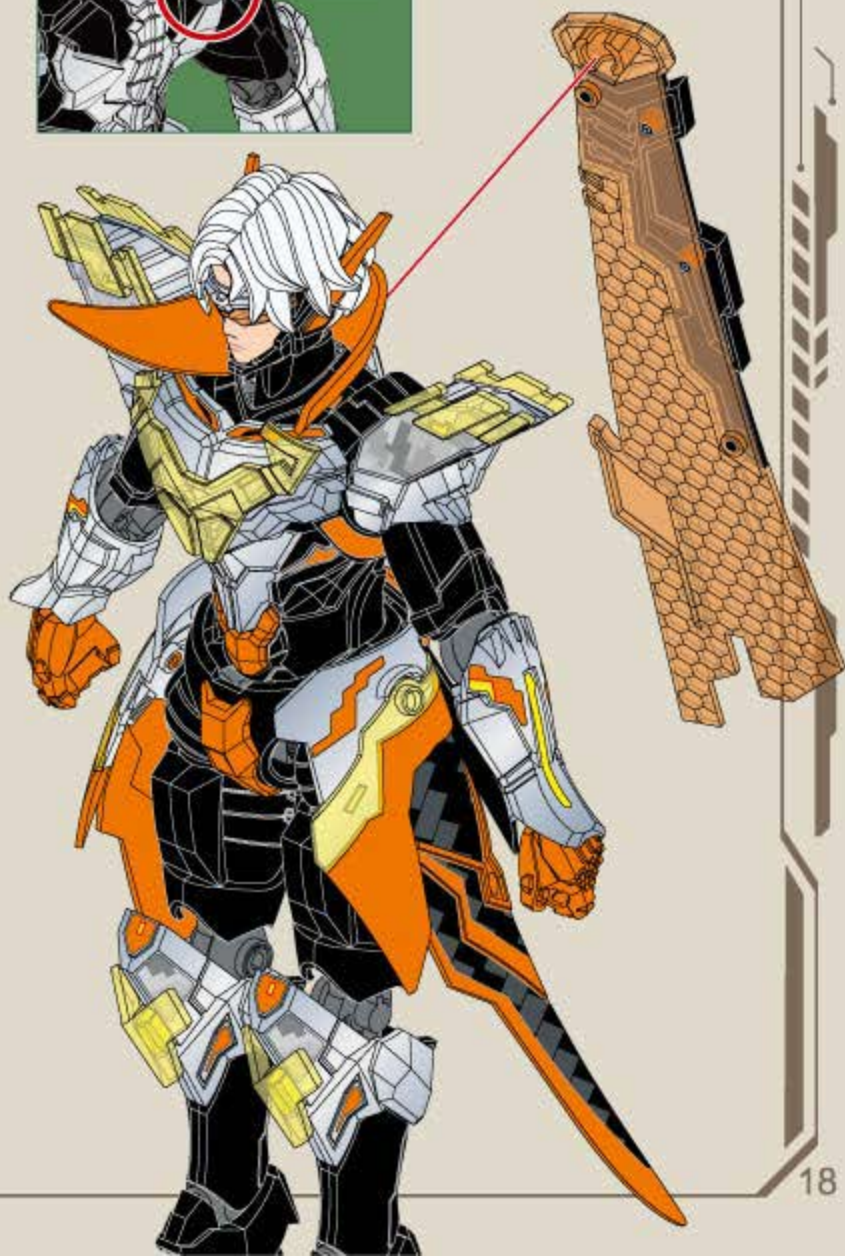
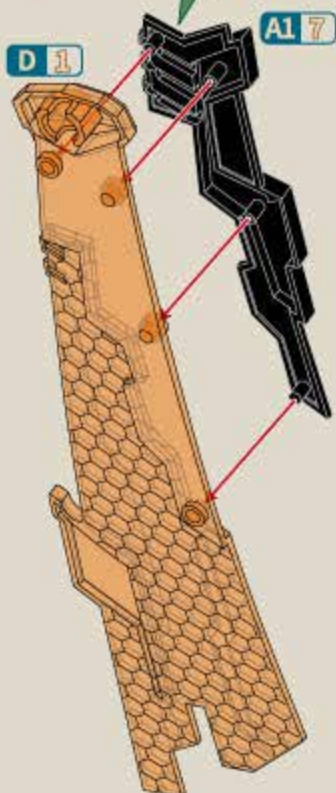

# 12 武器组件

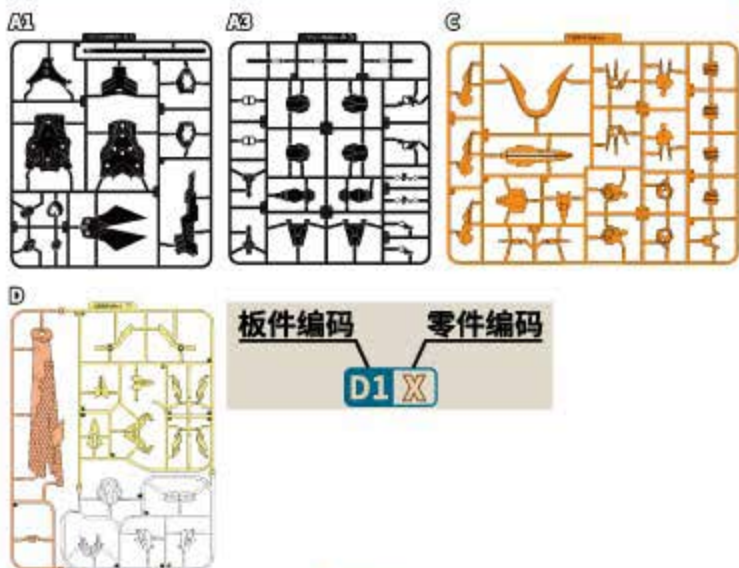

所需板件

## 12-1



## 12-2



## 12-3



12-4



12-5



12-6





