



奇妙积木

KEEP
PLEY

K21402
花鼓抛月牙

敦煌博物馆



正版授权

图片仅供参考，请以实物为准。



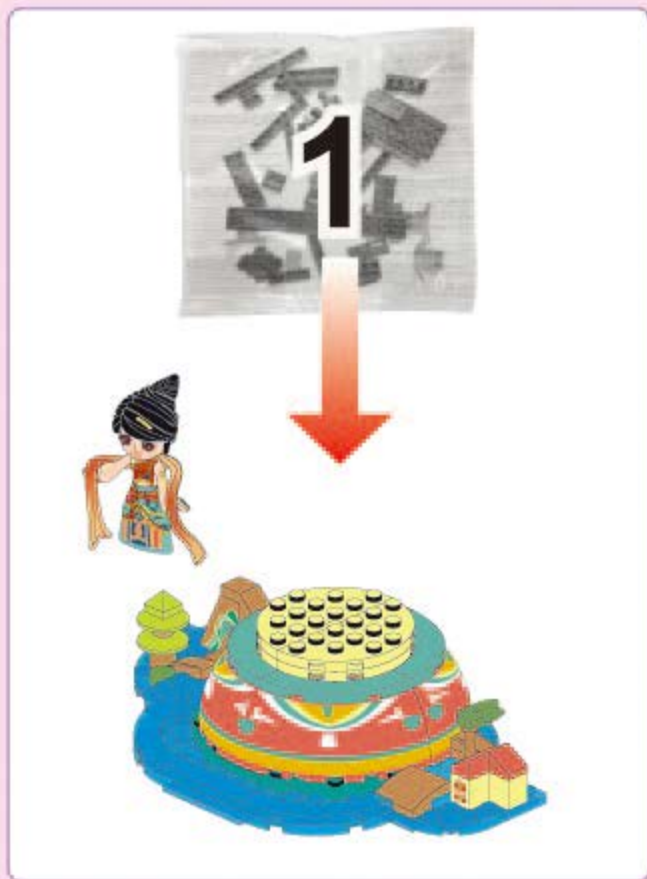

拆件器使用方法，仅为示例

Usage of Brick Separator, Just for the sample

1

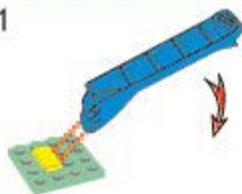

3



2



4



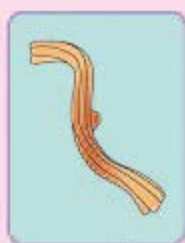
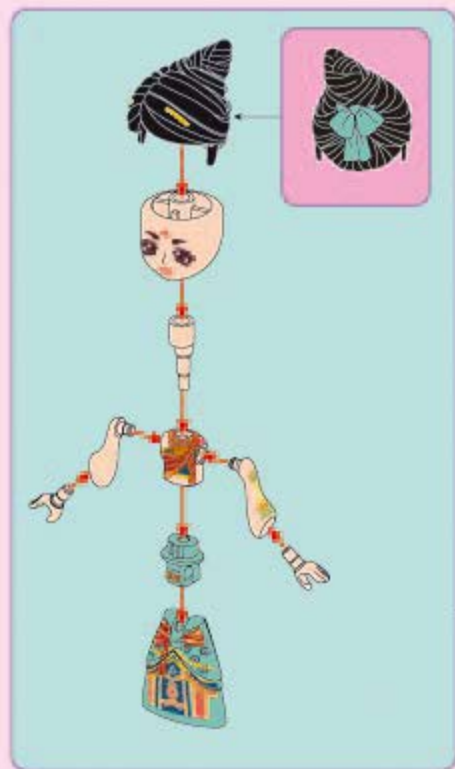

1

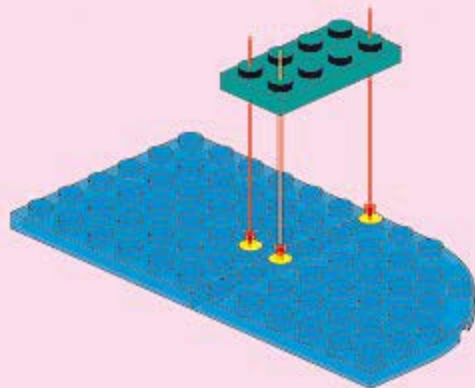
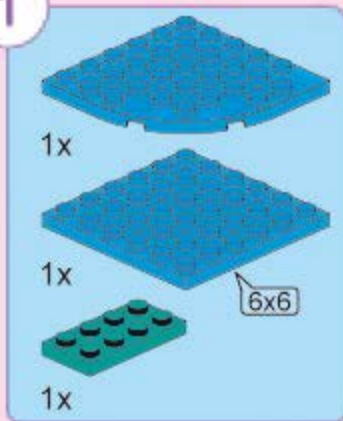

2

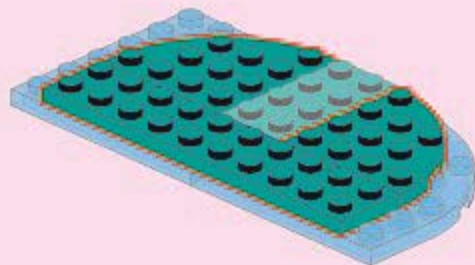
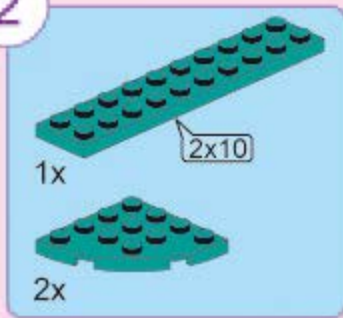

3

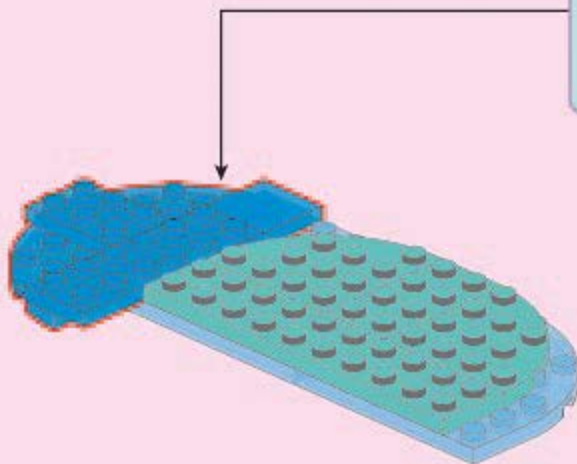
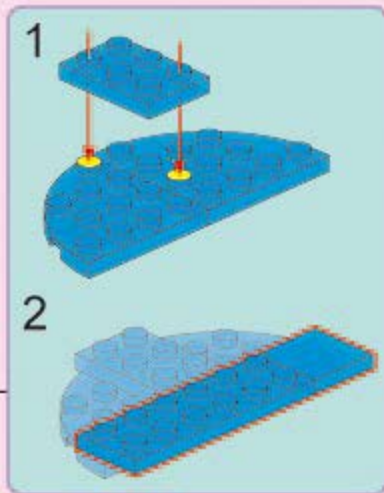
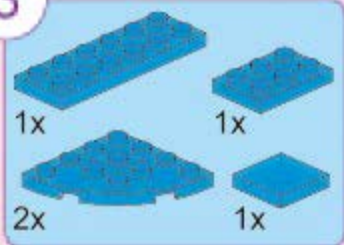

4

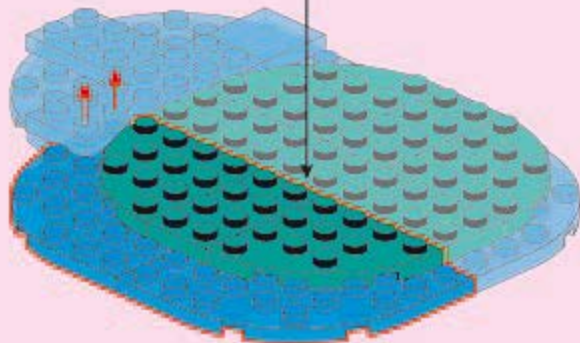
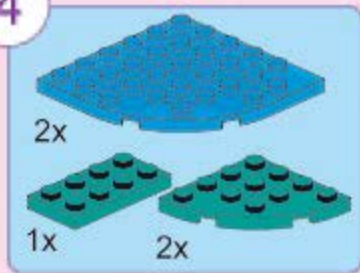

1

2

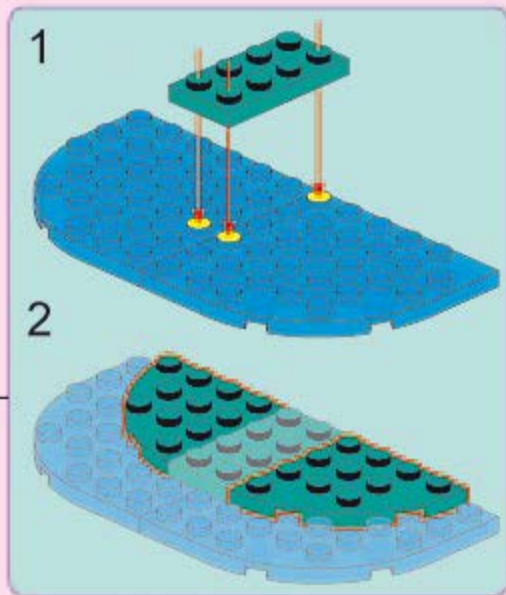

5

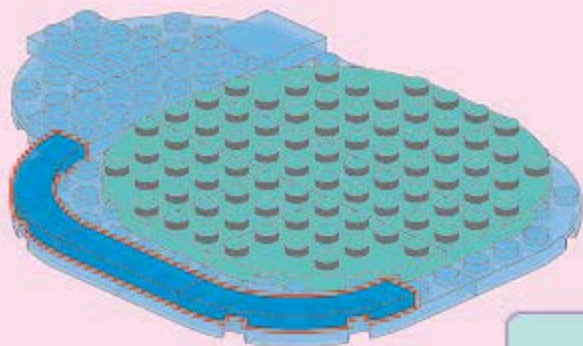

6

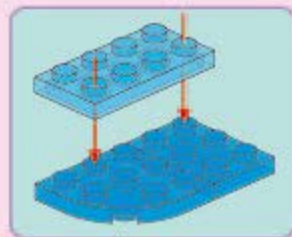
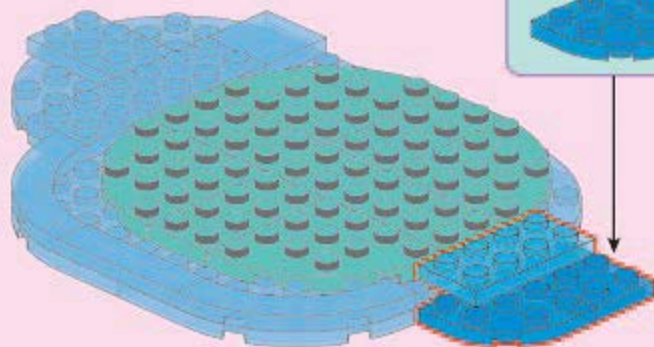
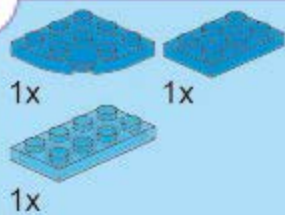

7

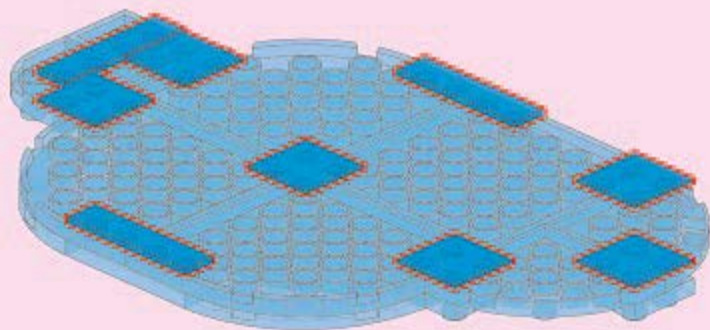
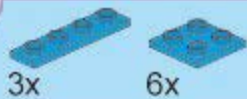

8

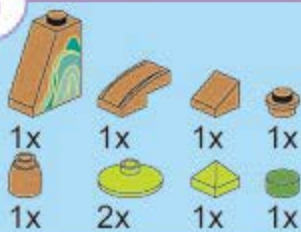

1

2

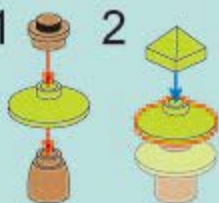

9

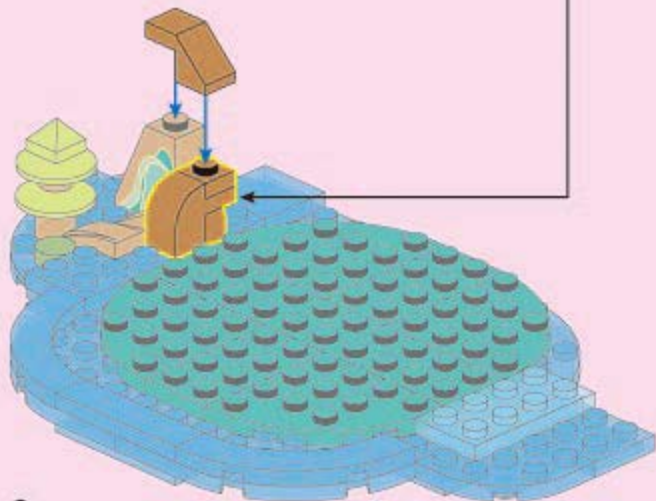
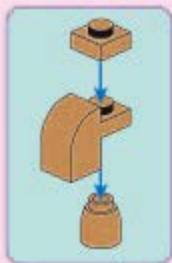

10

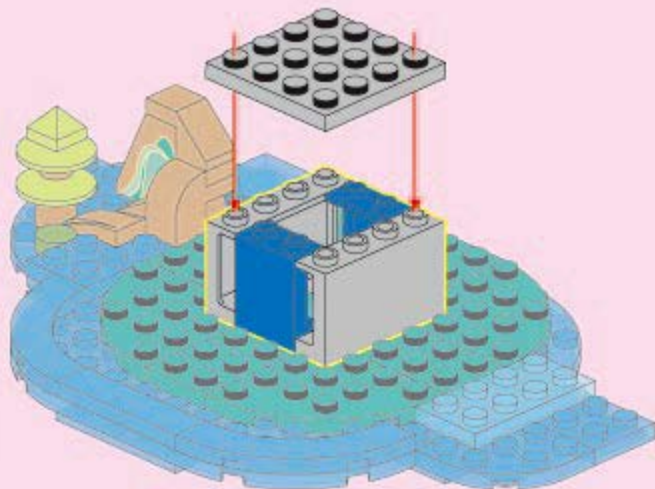
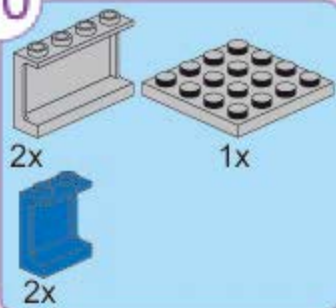

11



12

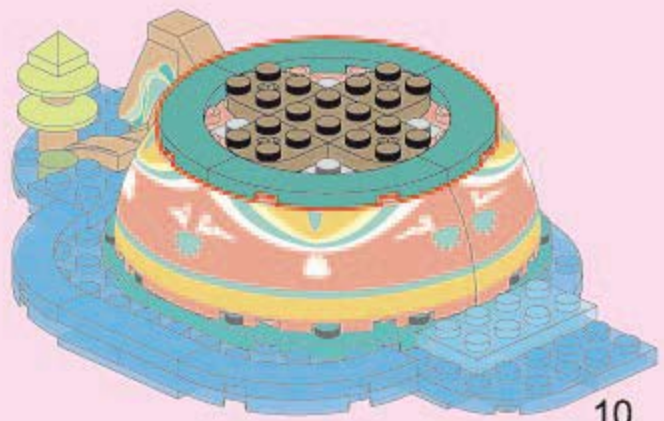
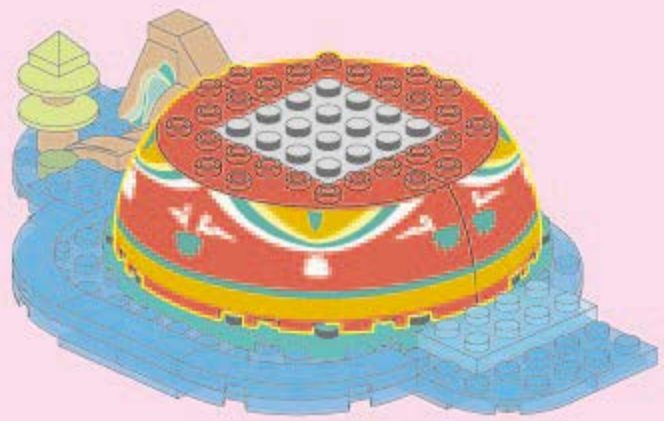
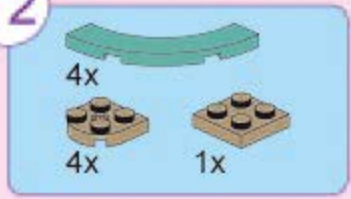

13



4x

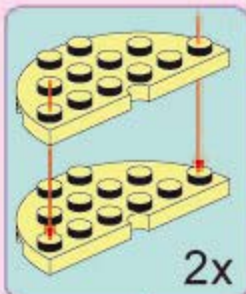

2x

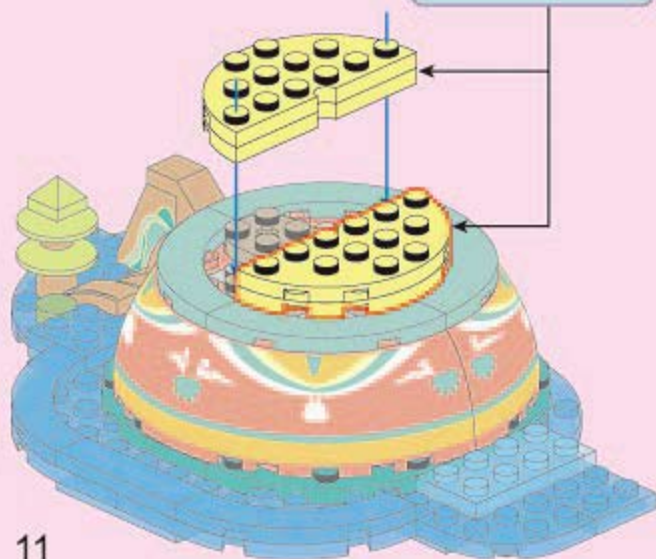

14



1x

1x

1x



15

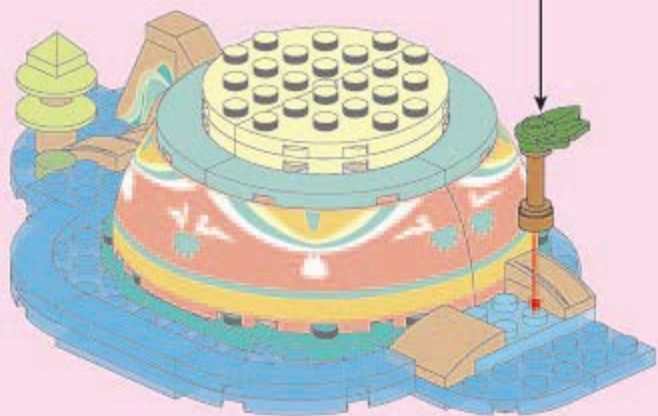
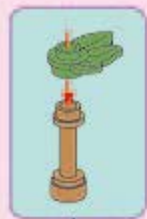
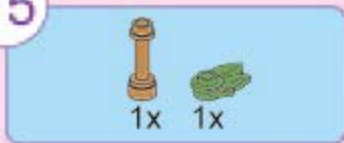

16

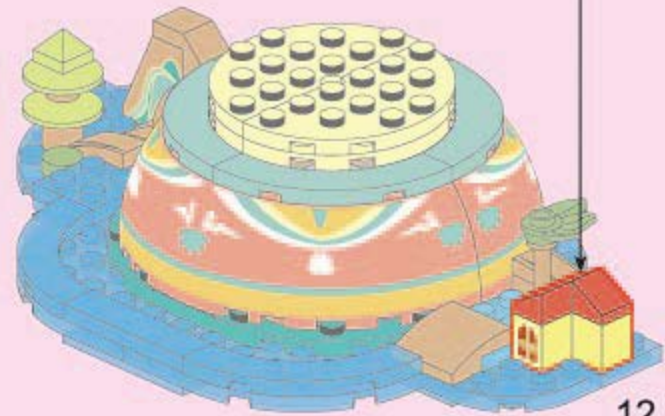
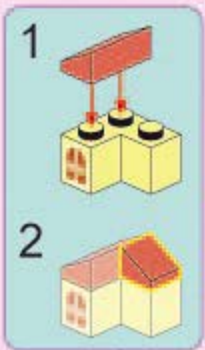
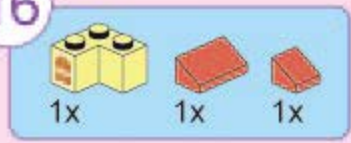

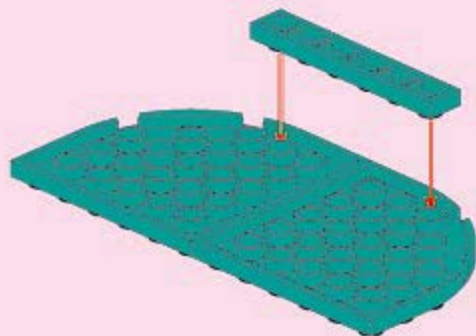
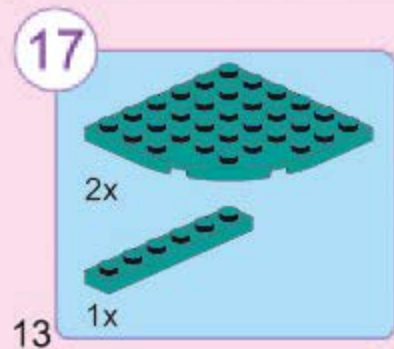
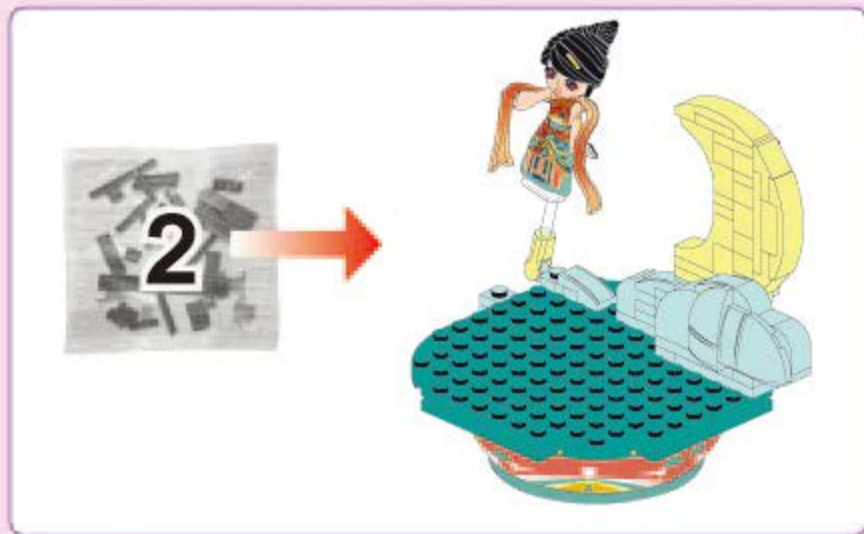

18

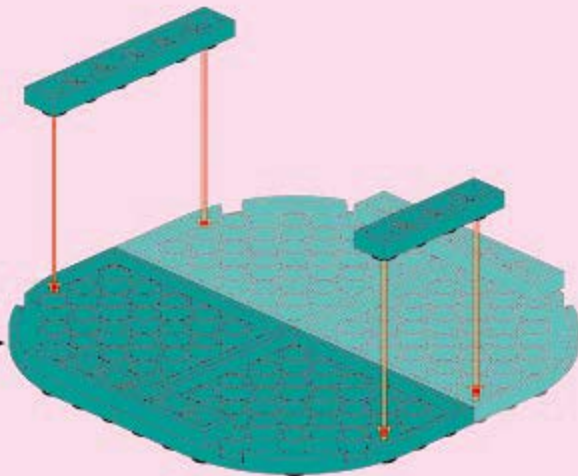
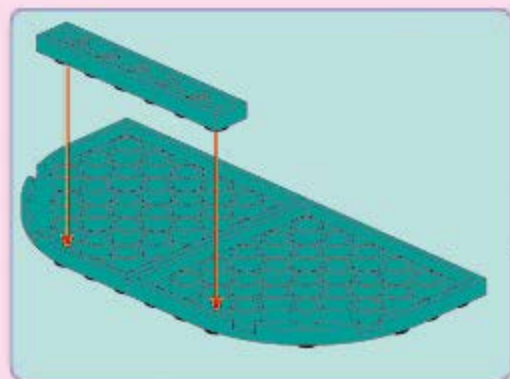
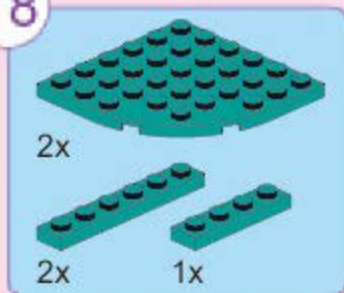

19

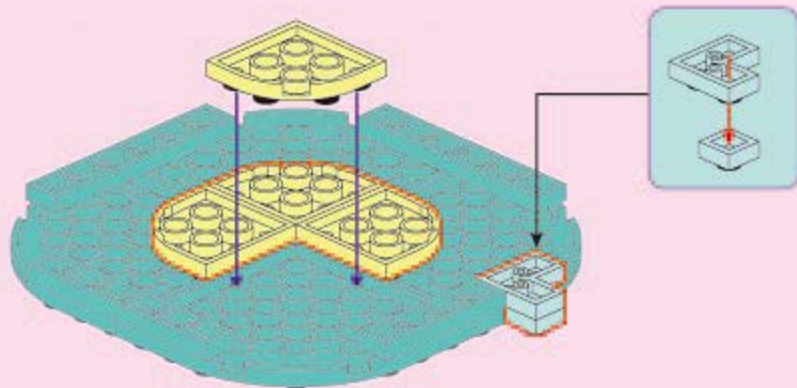

20

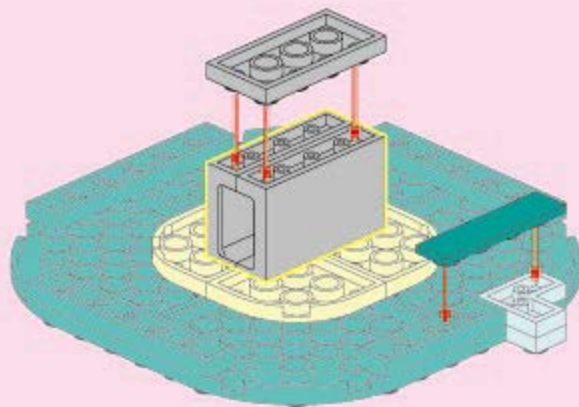
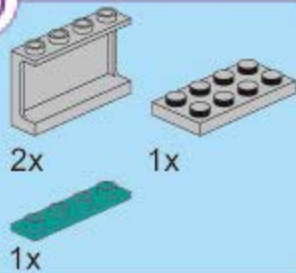

21



2x



2x

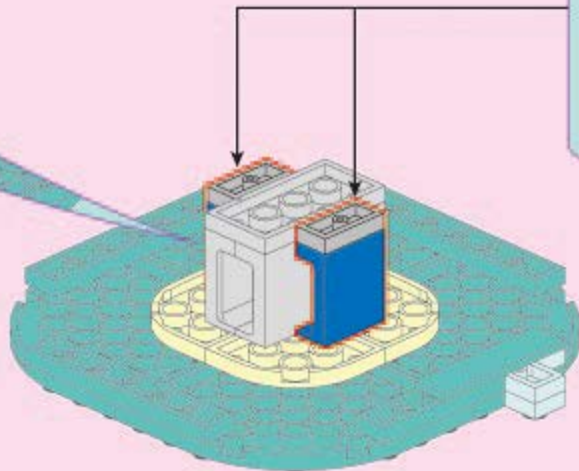
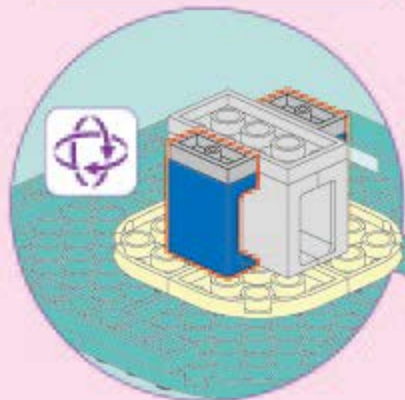

2x

22

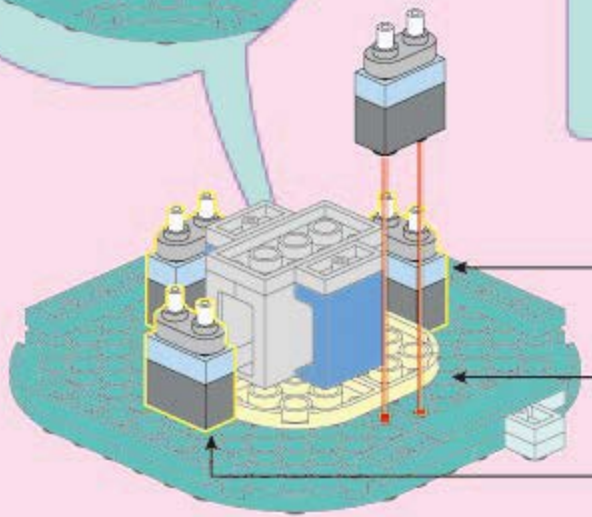
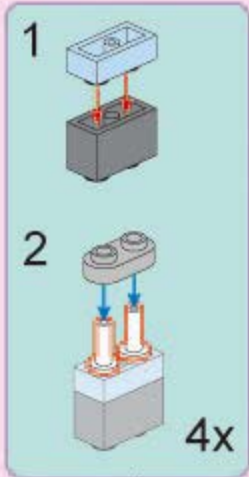
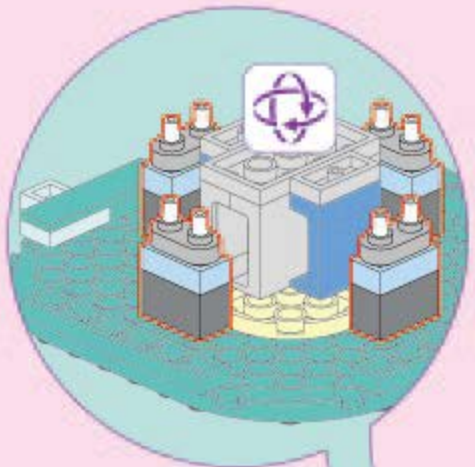
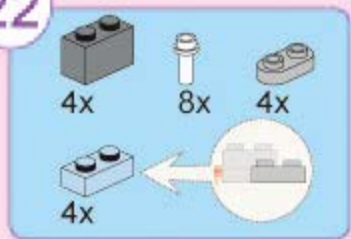

23

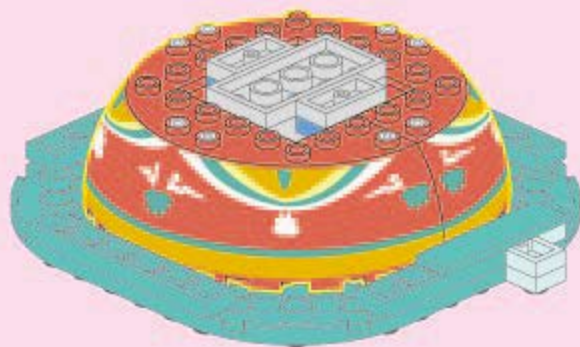

24

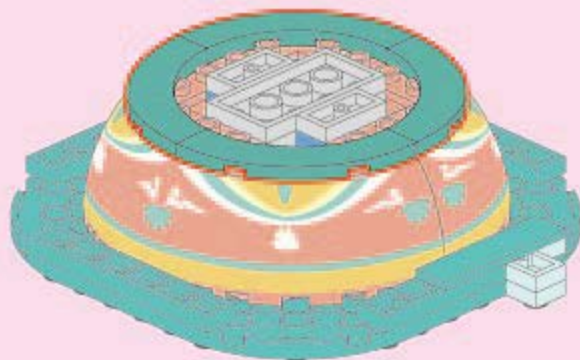
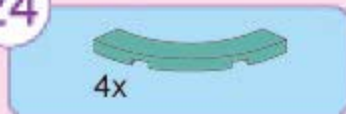

25

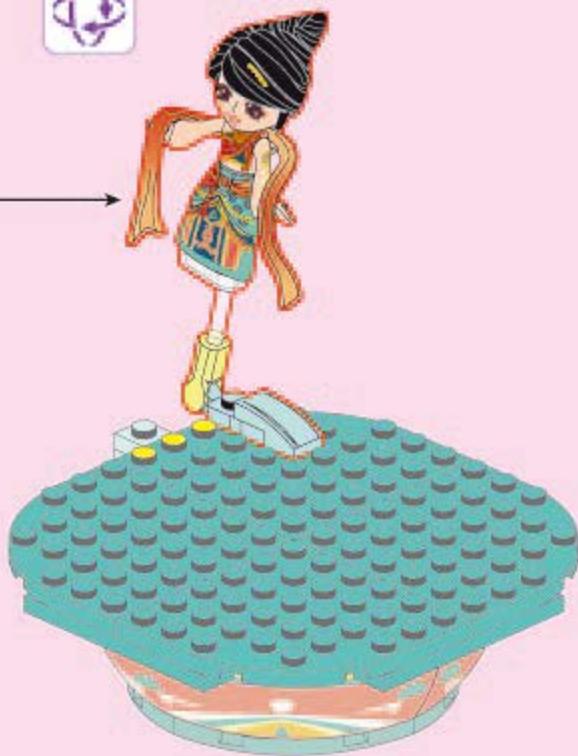
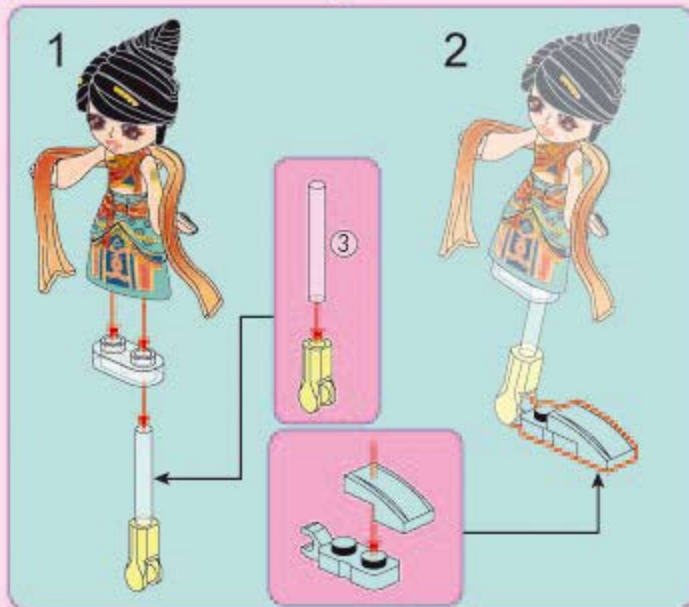
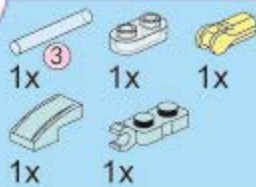

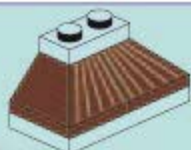

注意，需将走道拆掉并，然后在该位置
的序号读错零件。

Caution: This set piece needs to be separated and
assembled at separate sequential number.



1x

26



1x

27



1x

49

该积木用于第3分包
This brick is for pack 3



1x

49

该积木用于第3分包
This brick is for pack 3

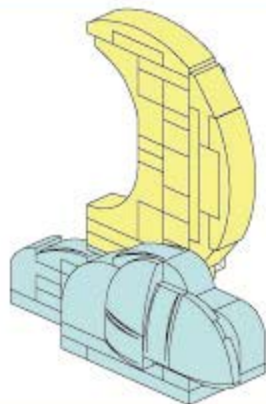

26



1x



1x



1x

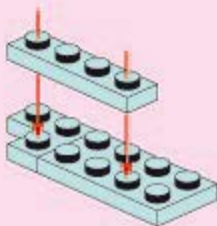

27

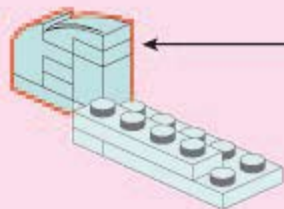
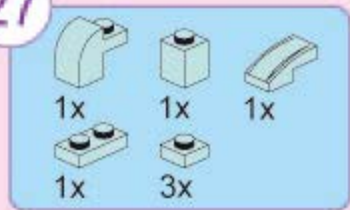

28

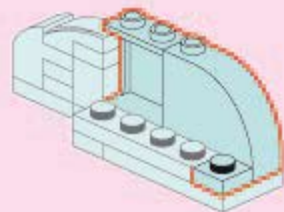
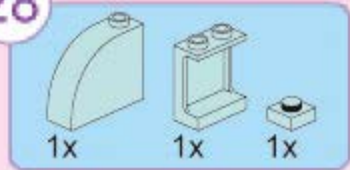

29

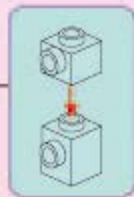
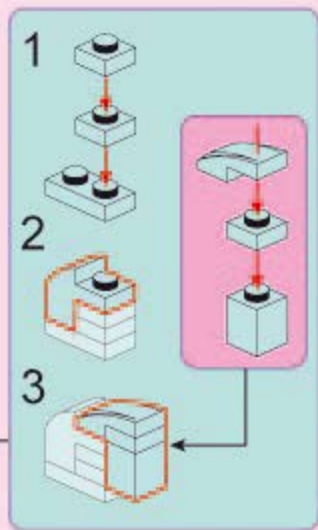
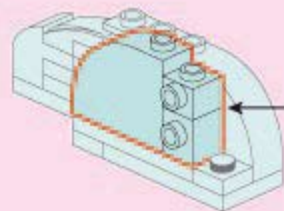
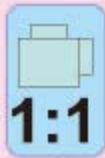
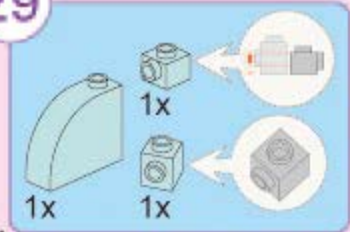

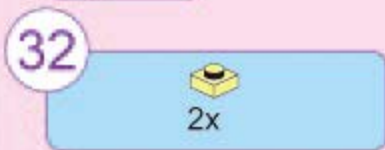
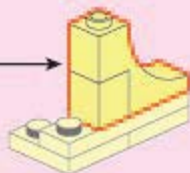
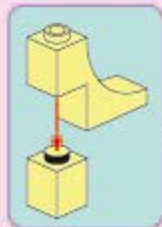
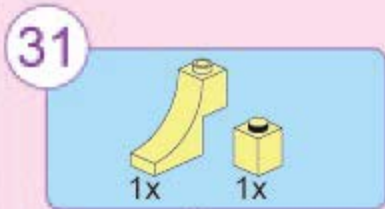
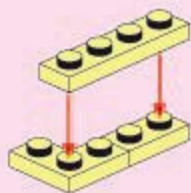
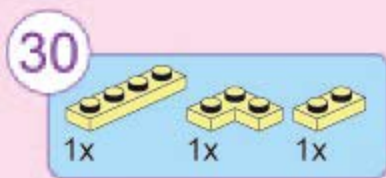
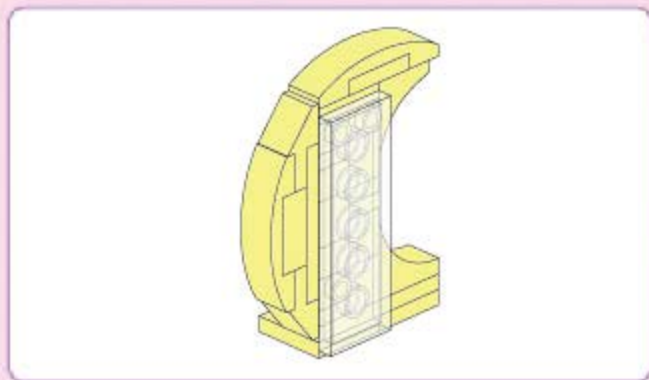

33

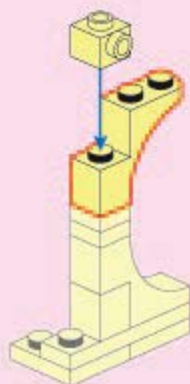
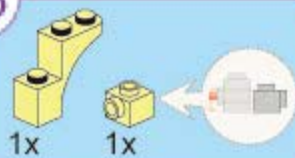

34

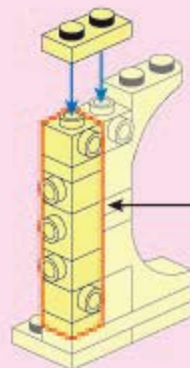
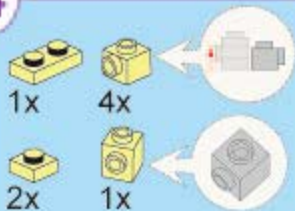

1



2



3



35

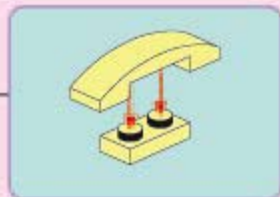
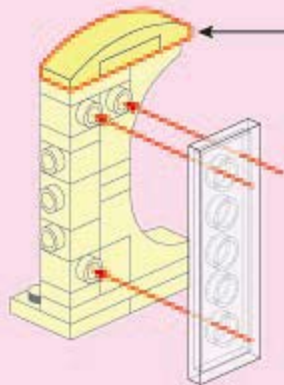
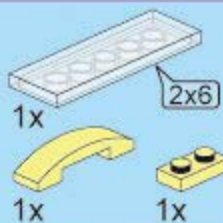

36

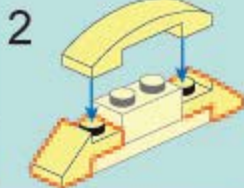
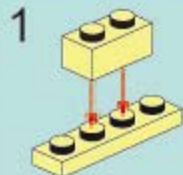
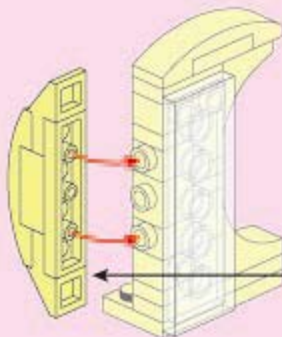
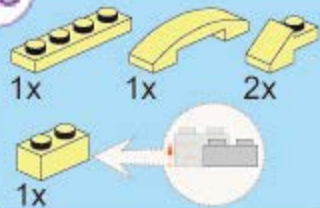

37

29

36

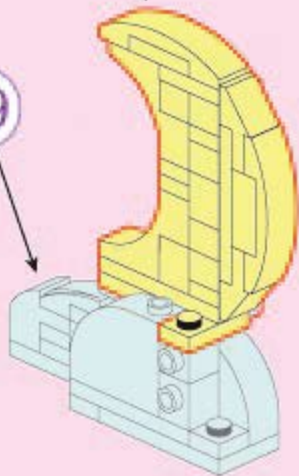

38

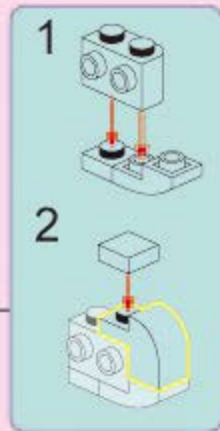
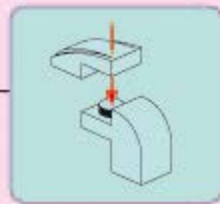
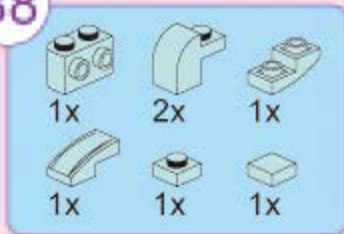

39



2x



2x

40



2x



2x

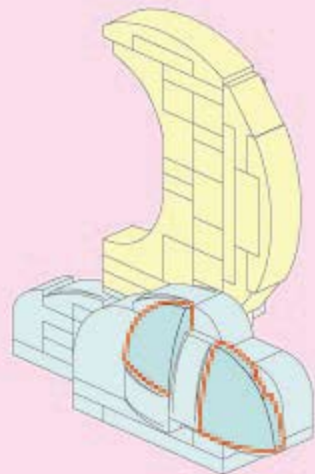
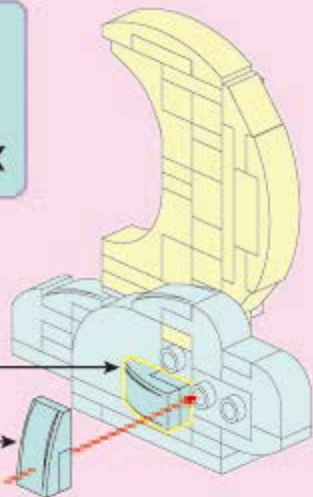

41

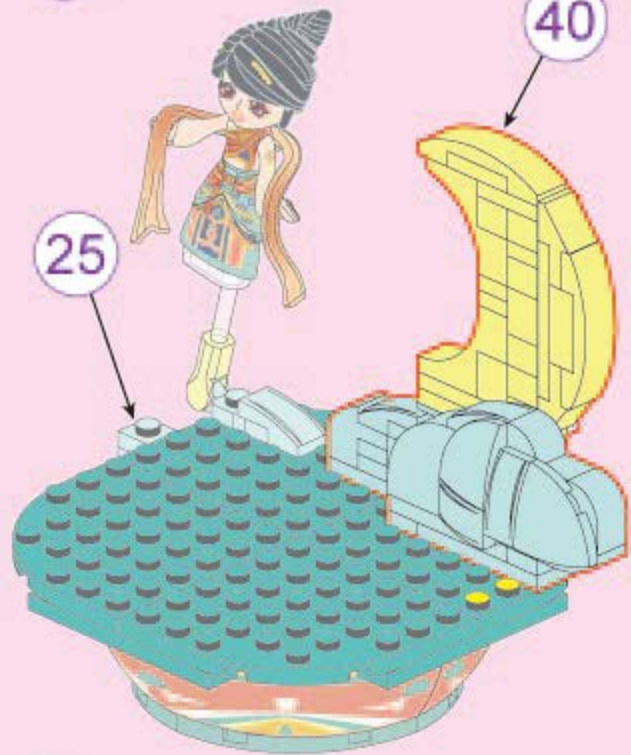

27



42

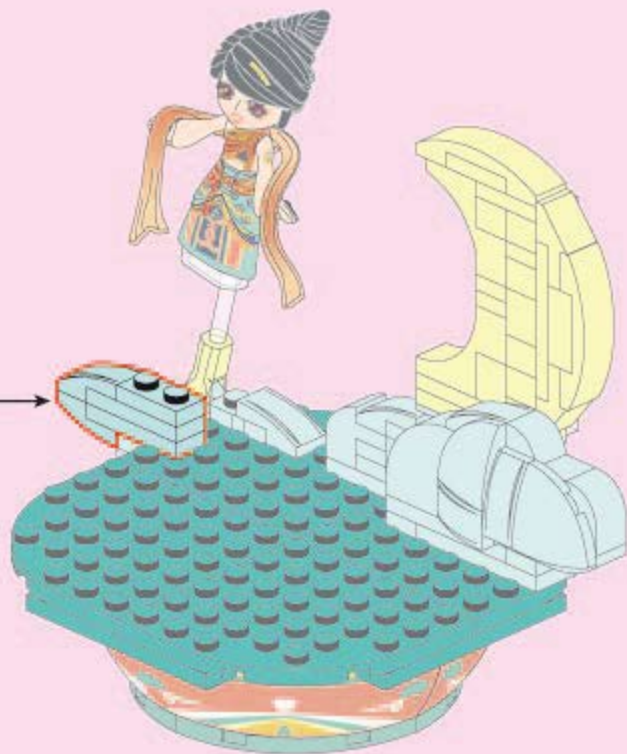
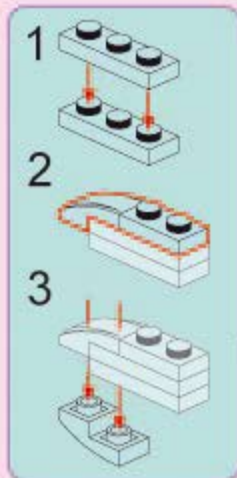
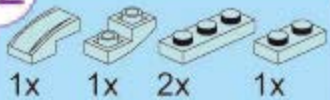

43

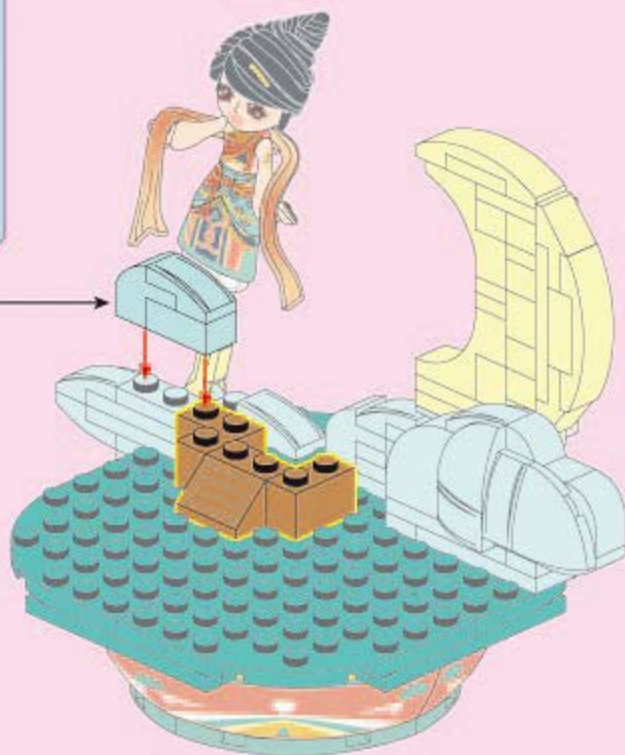
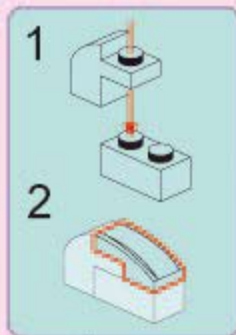
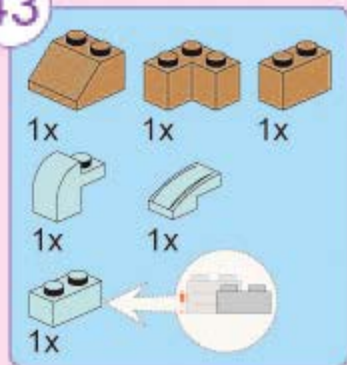

44

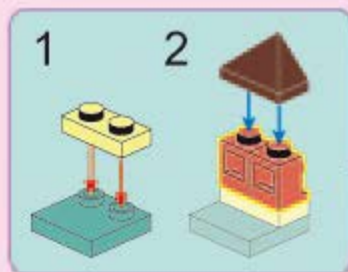
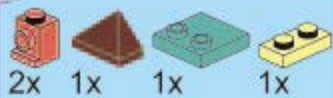

45



1x



4x



1x

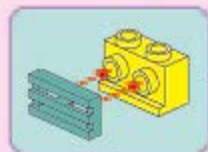



46



2x

1x



47



1x



48

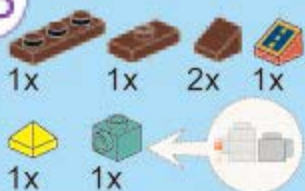

1x

1x

2x

1x

1x

1x



1:1



1

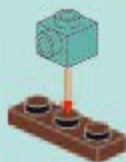

2



3

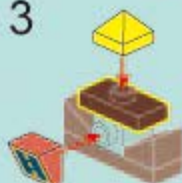

49



1x



1x

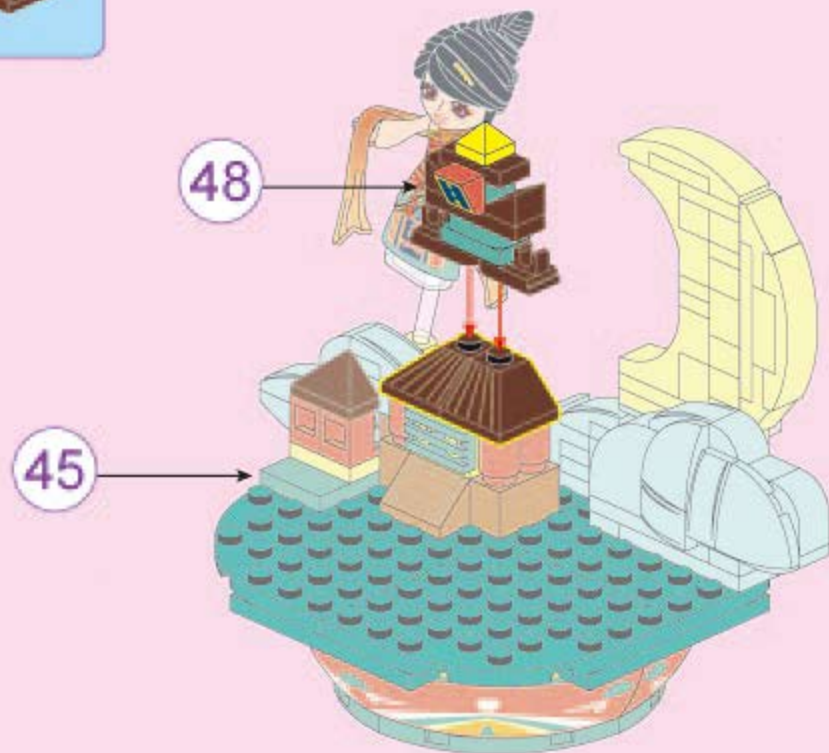

48

45

50



1x



1x



1x



1x

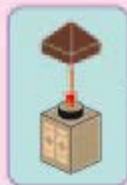

51

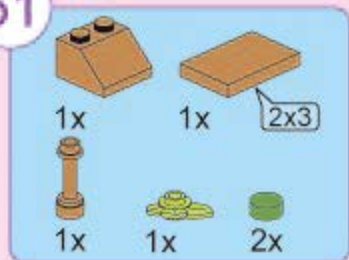

52

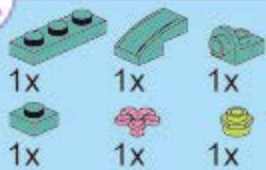

1

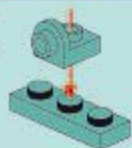

2

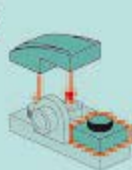

3

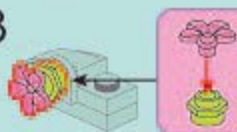

53



1x



1x



54



1x



1x

4



1x



1x



1x



3x



1x

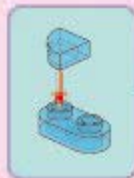

1



2



4

55

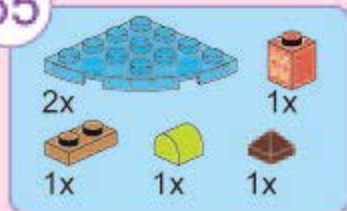

1



2



56



1x

1x



1x

1x

1x



57

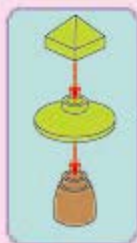
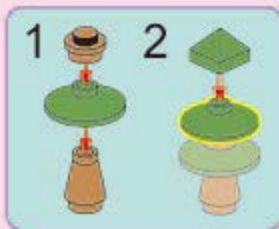
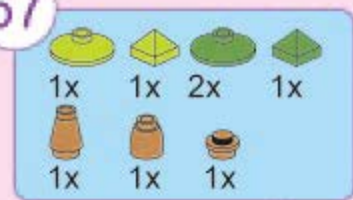

58

57

16

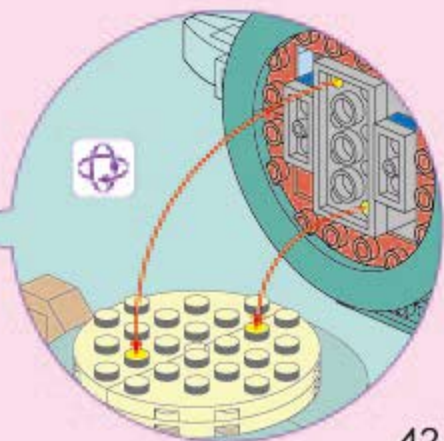



K 奇妙积木 **KEEP
PLAY**