

K

奇妙积木

KEEP PLAY

K20234

POKÉMON

宝可梦



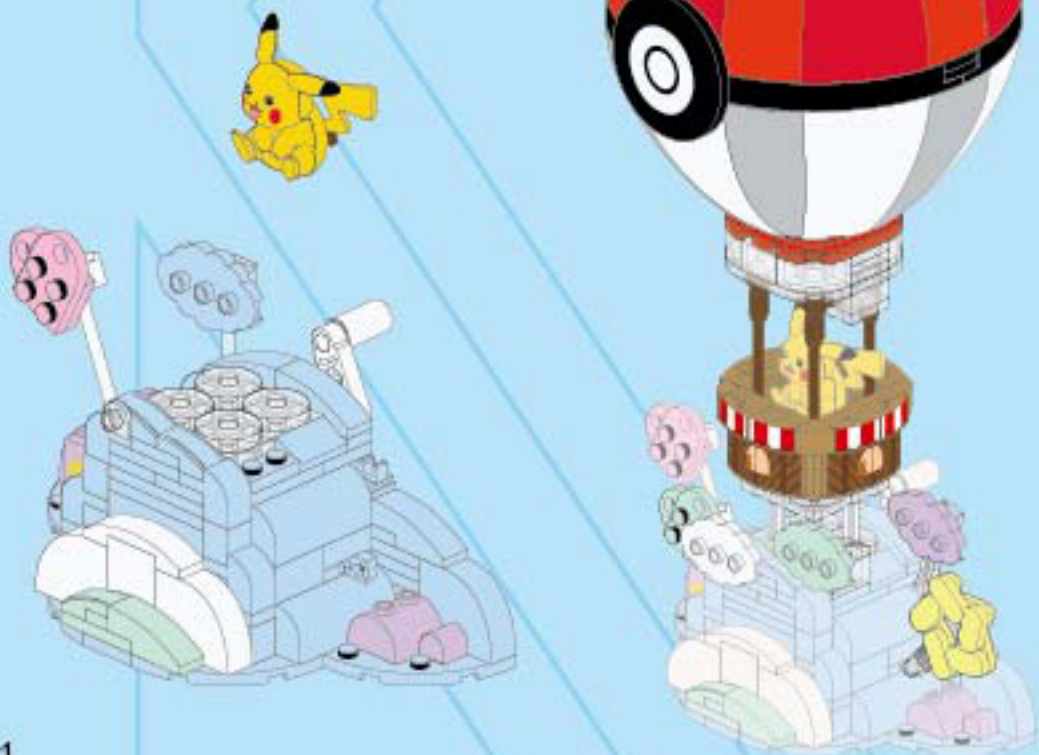

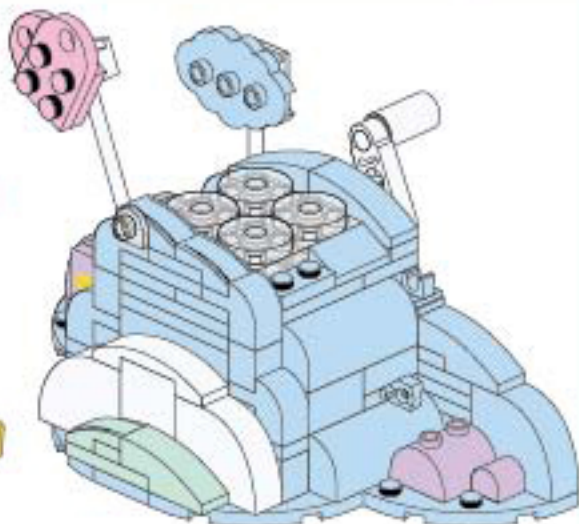

拆件器使用方法，仅为示例

Usage of Brick Separator, just for the sample

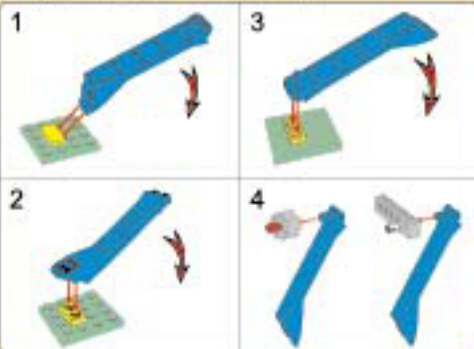

1



2



1

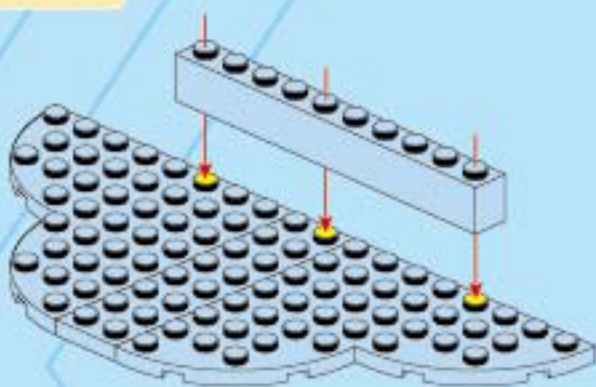
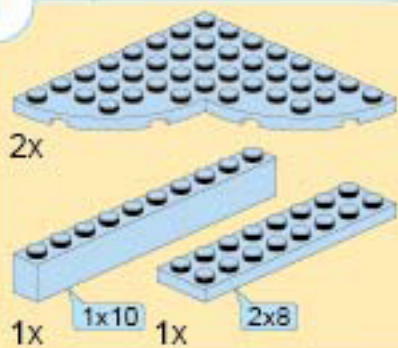

2

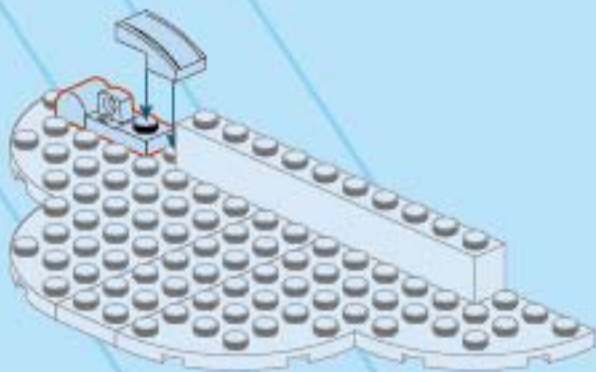

3



2x



2x



2x

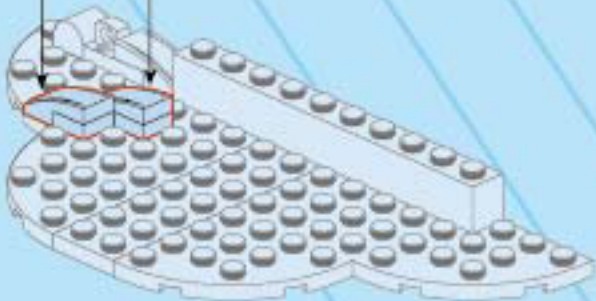

4



1x

1x8



1x



1x

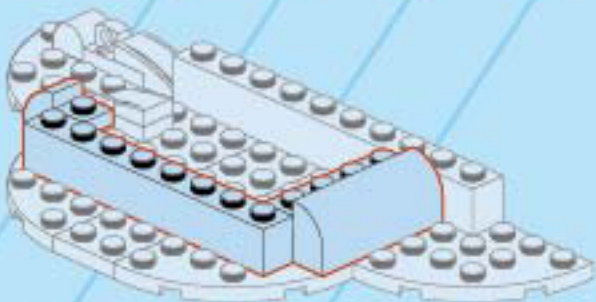

5

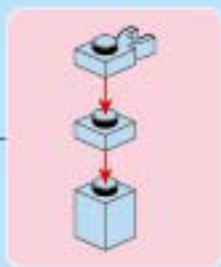
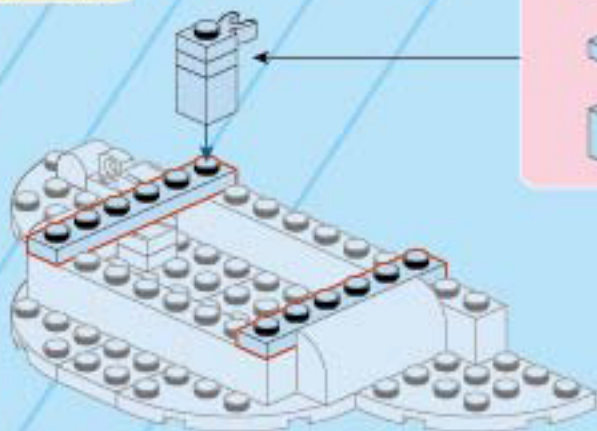
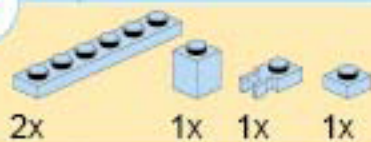

6

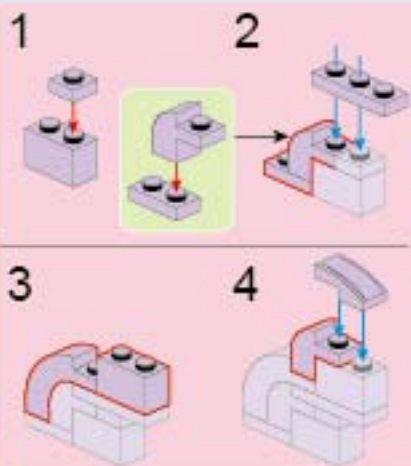
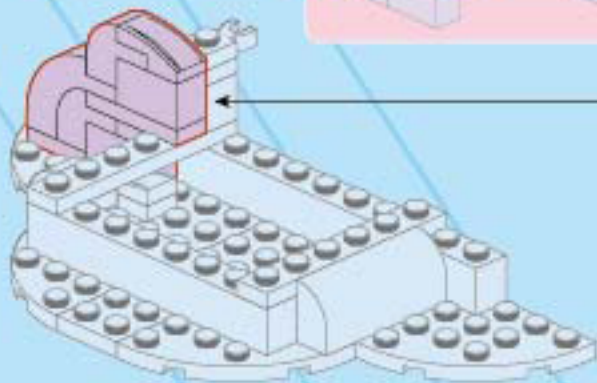
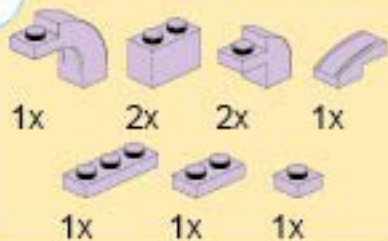

7



1x



1x

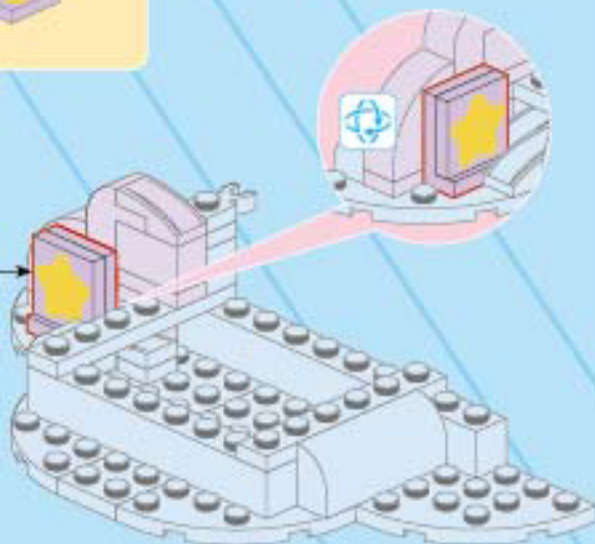
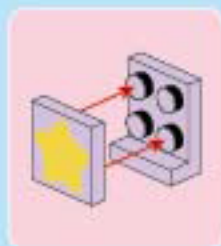

8



1x



2x



1x

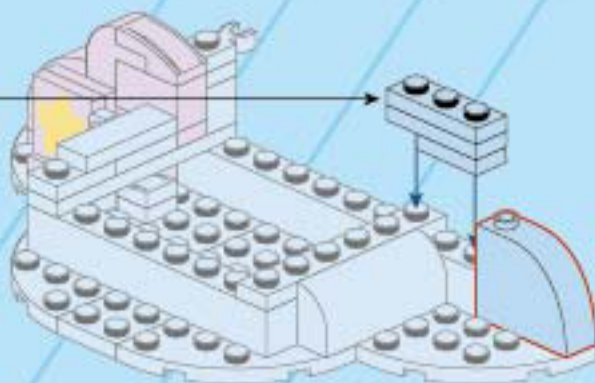
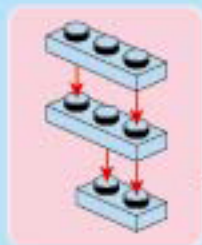

9

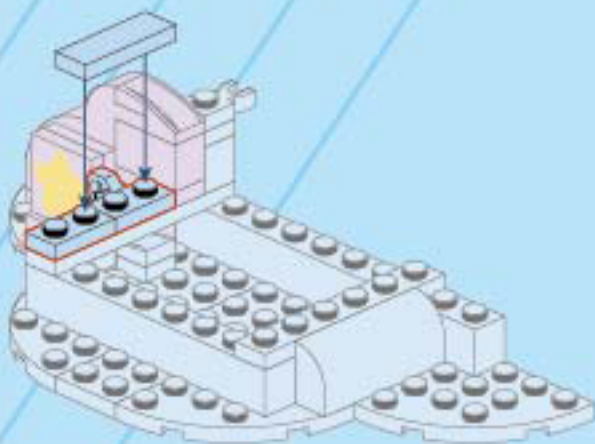

10

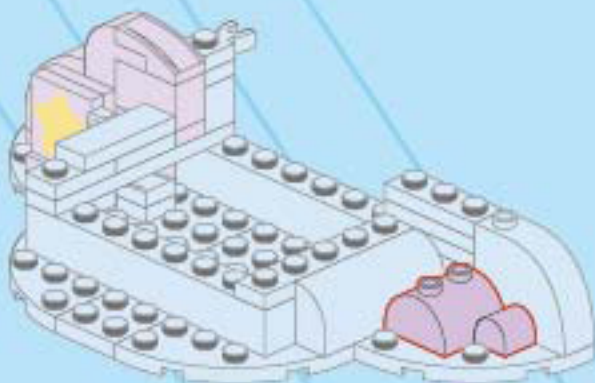
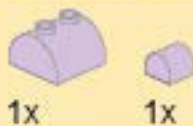

11

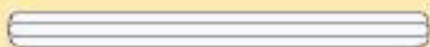
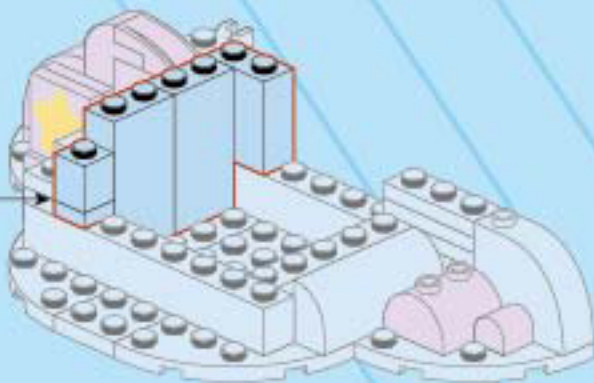
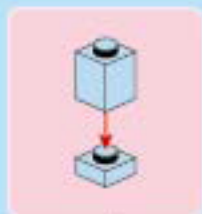
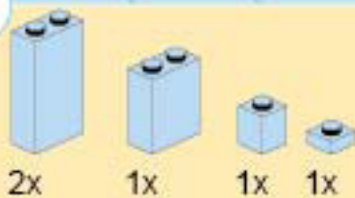

7 1:1

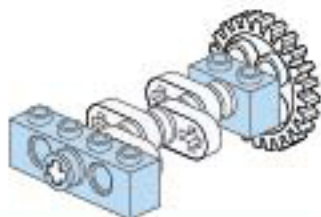

13

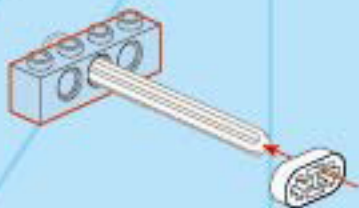

12



14



1x



2x

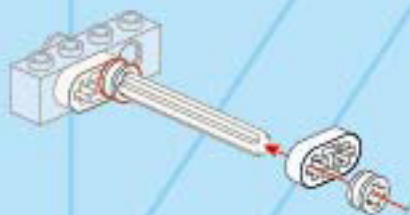

16



1x



1x



15



1x



1x



17



1x



1x

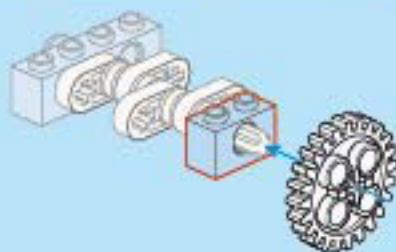

18

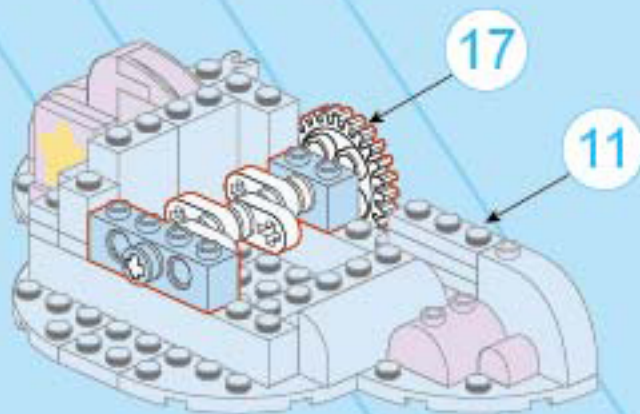

19

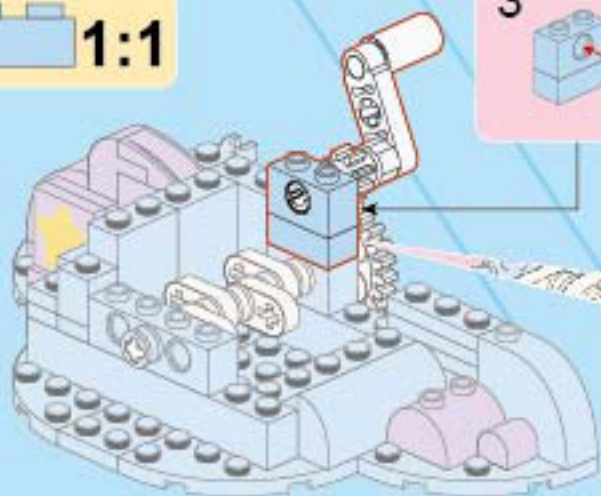
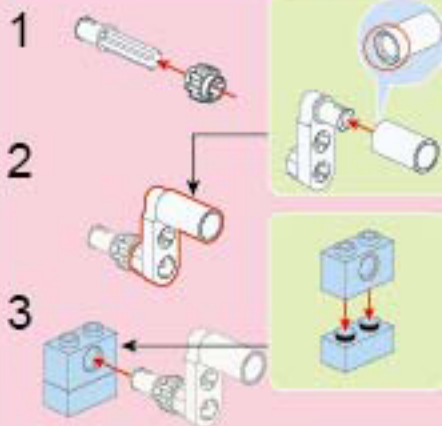

20

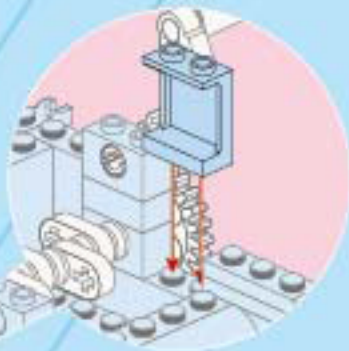
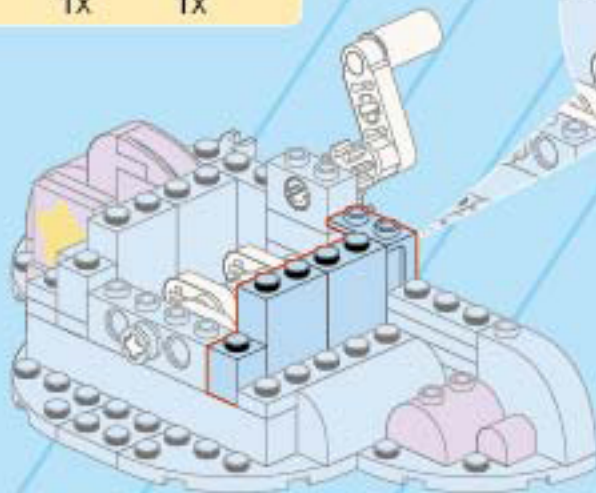
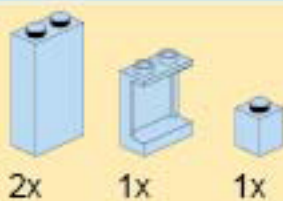

21



1x



1x



1x

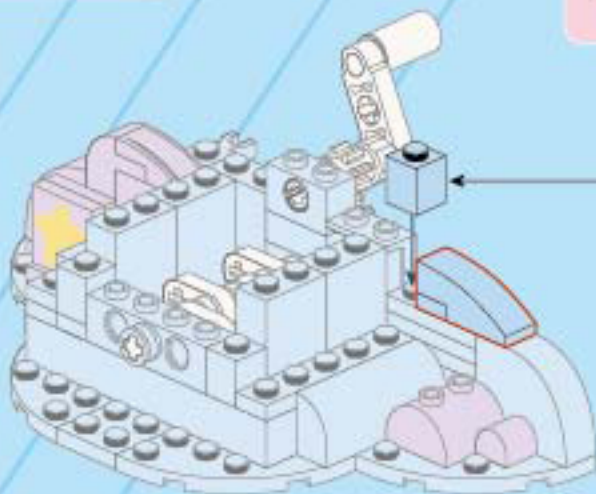
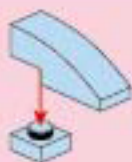

22



1x



1x



1x

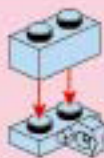

1:1

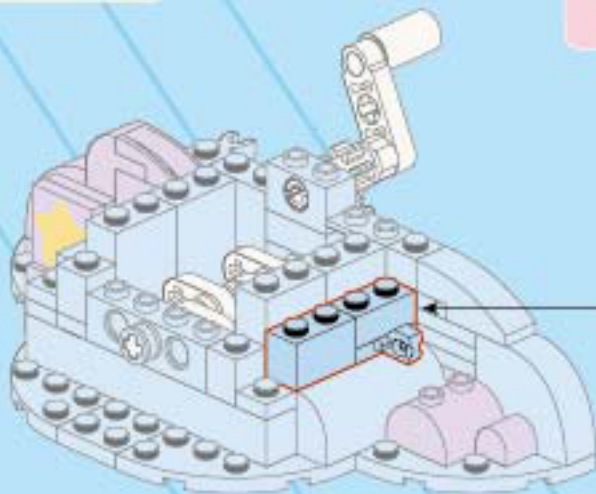

23

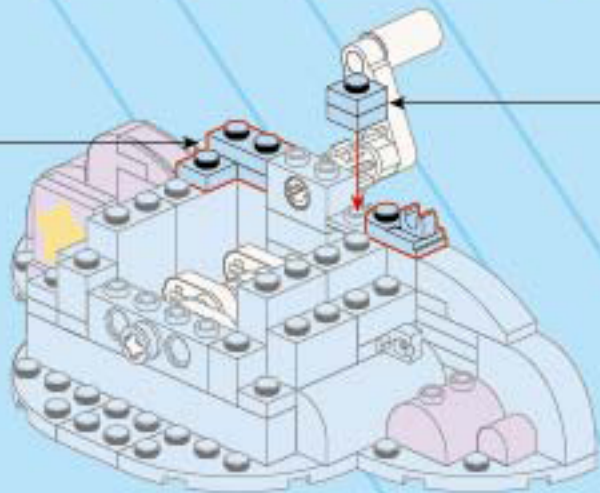
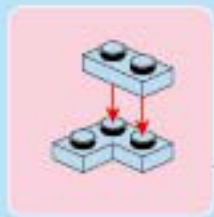
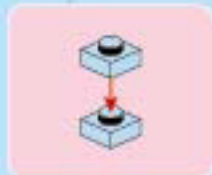

24

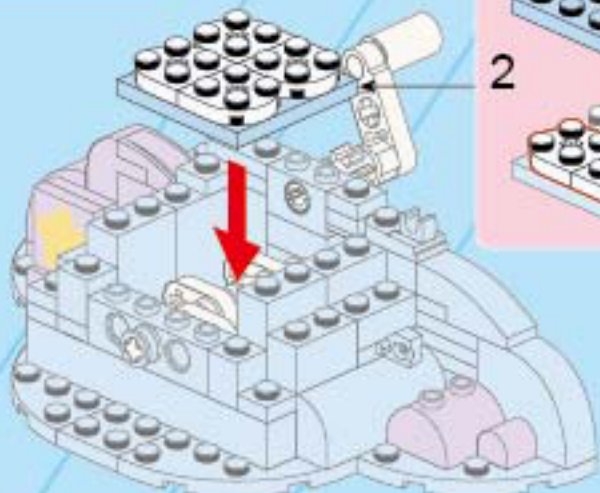
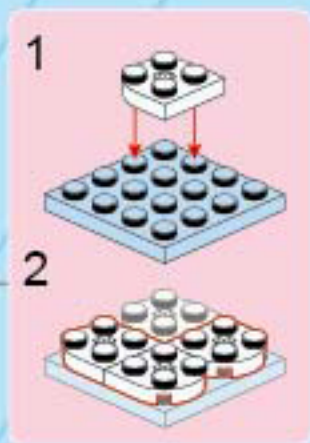
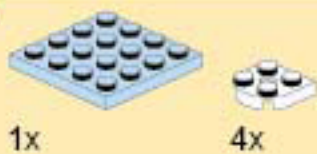

25

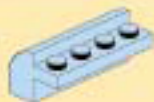

1x



1x

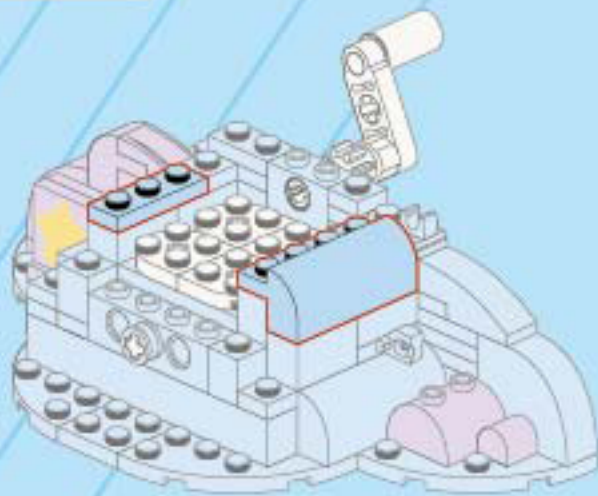

26



2x



2x

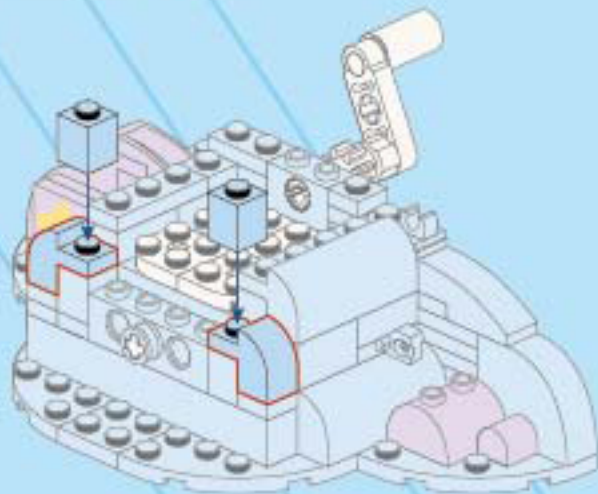

27



1x



2x

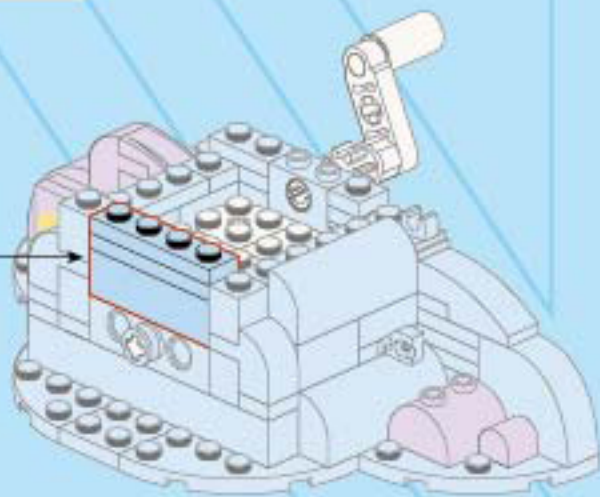
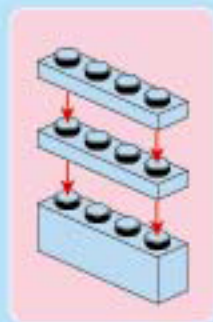

28



1x



1x



2x



1x

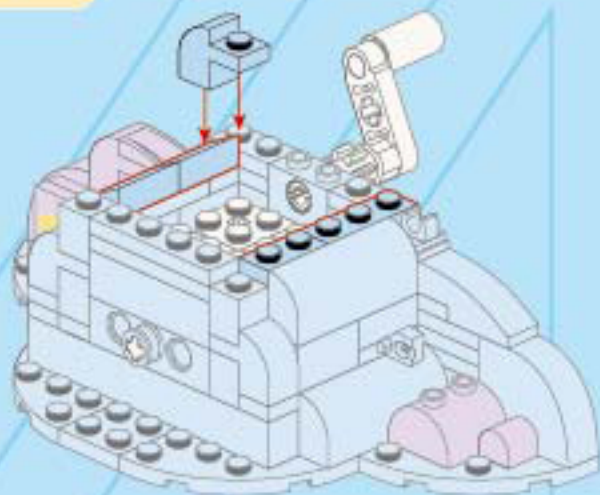

29

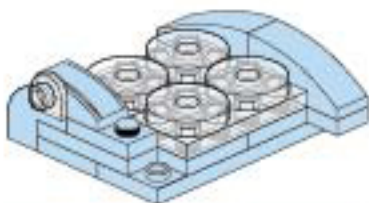
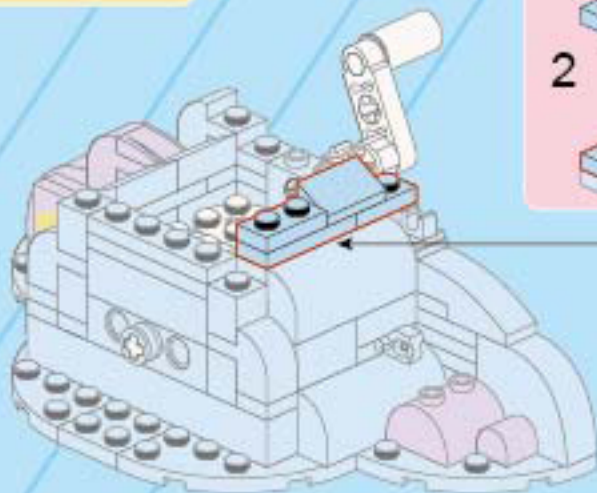
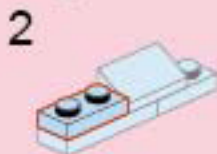
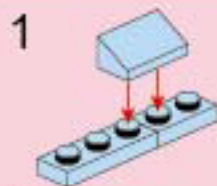

31



30

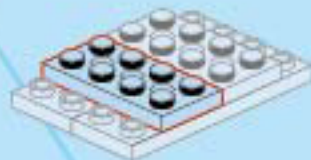
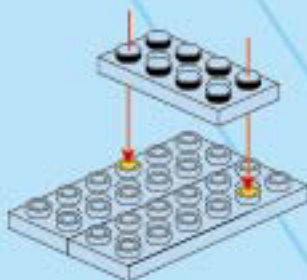

32



2x



4x

1

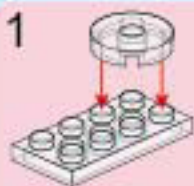

2

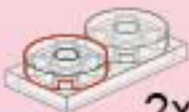

2x

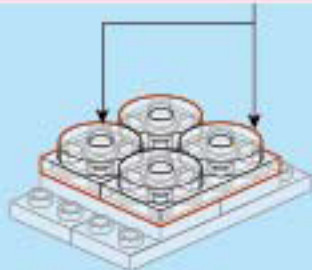

33



1x



2x



1x

1

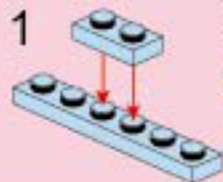

2

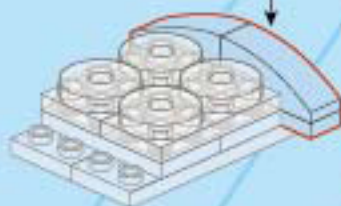
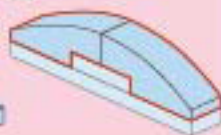

34



1x



1x

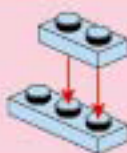

35



1x



1x



1x



36

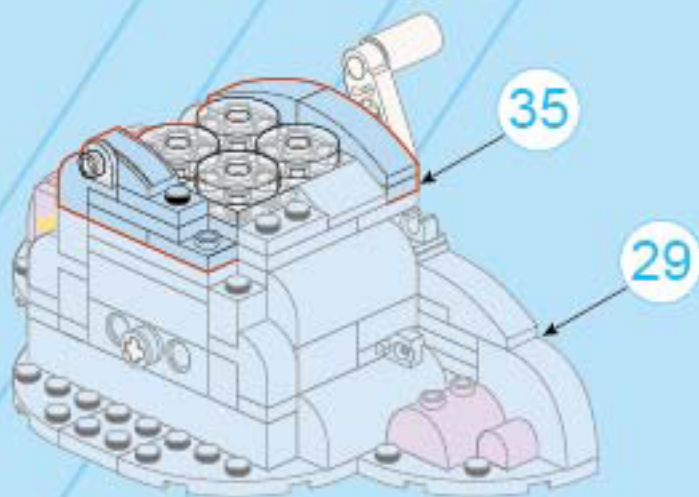

37

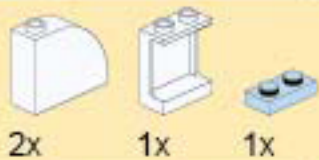

2x

1x

1x

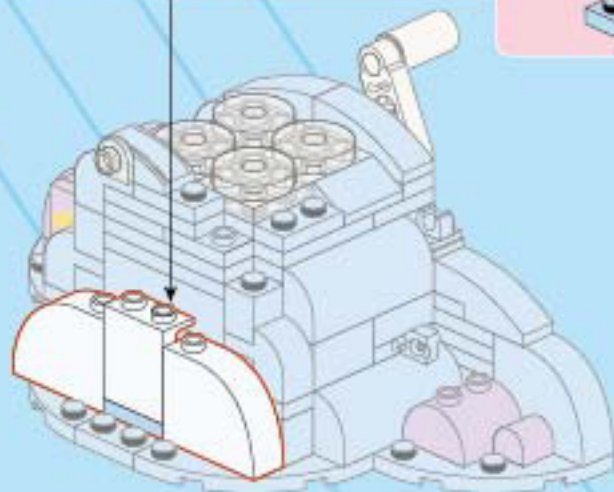
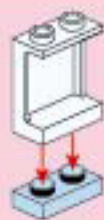

38

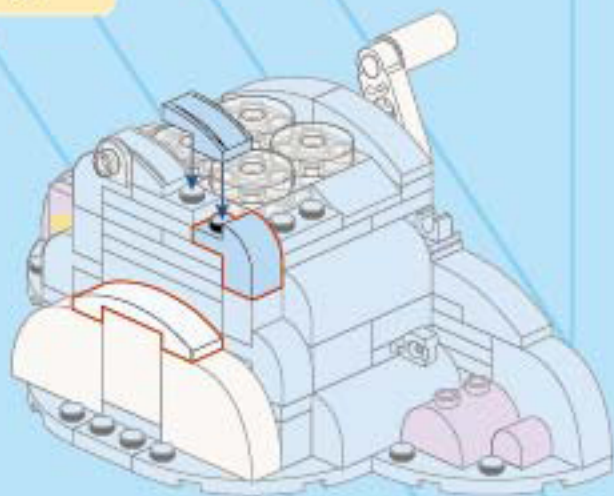
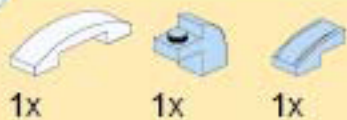

39

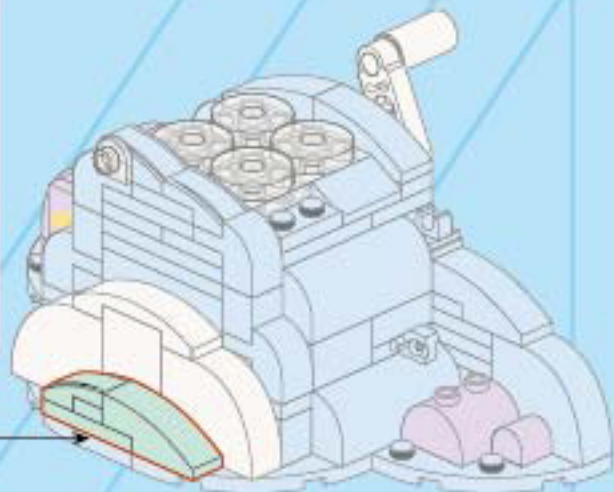
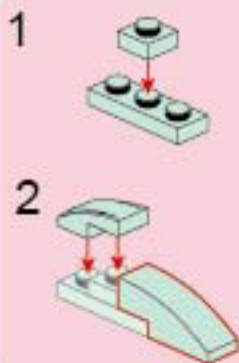
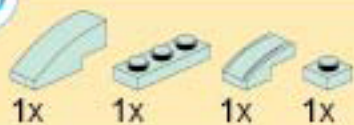

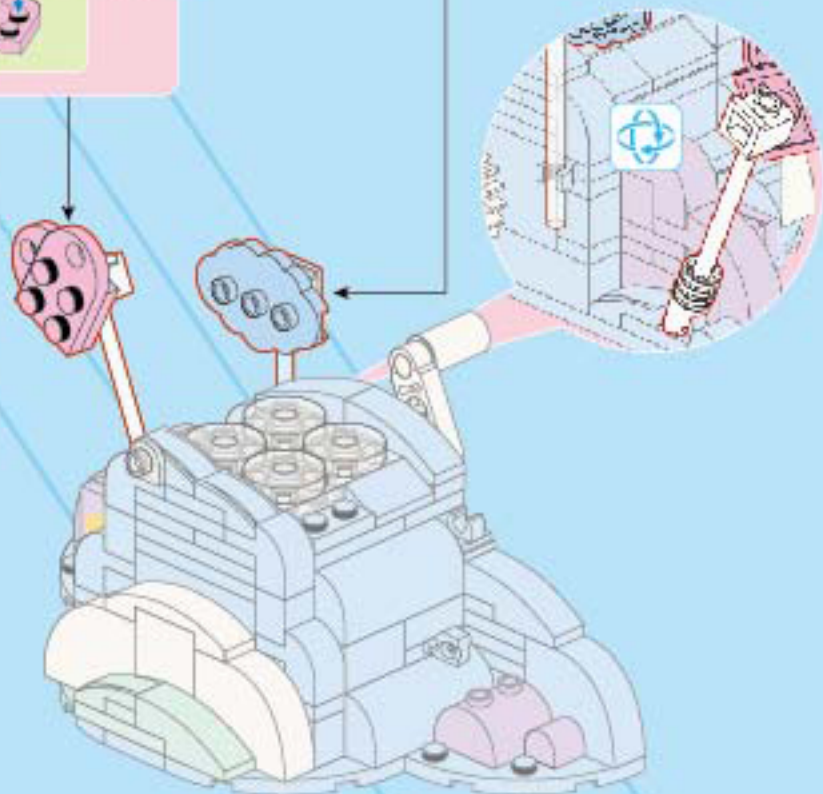
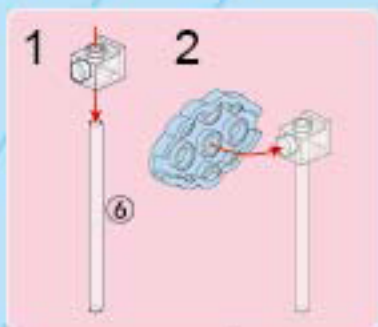
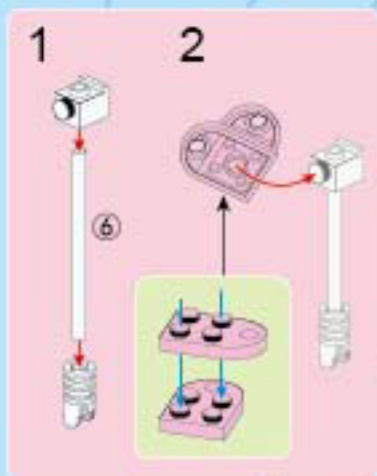
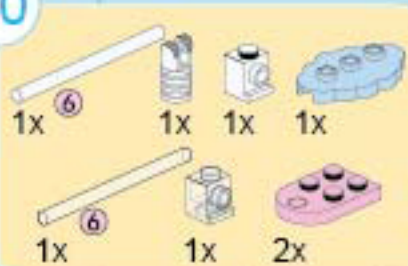



1x



1x



41

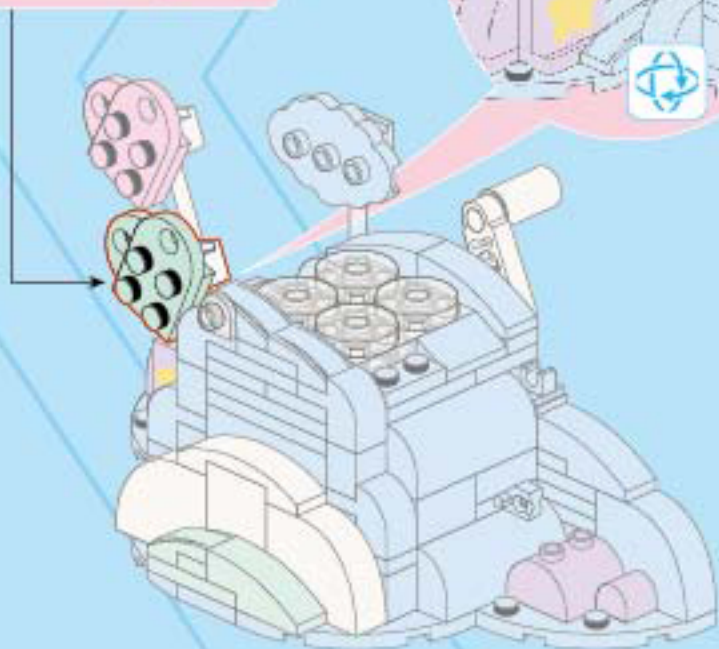
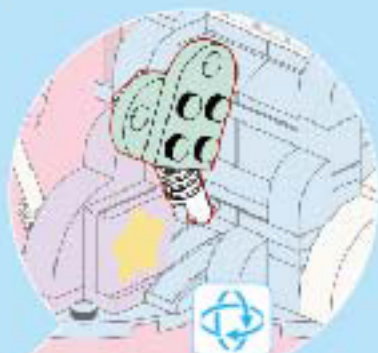
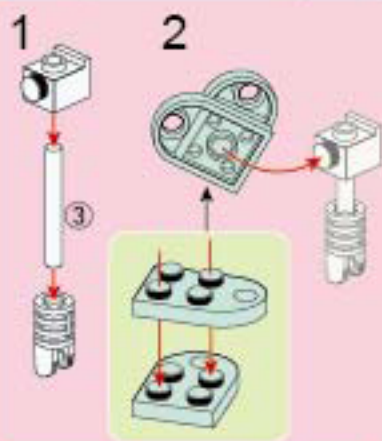

42

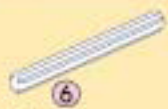

4x



1:1

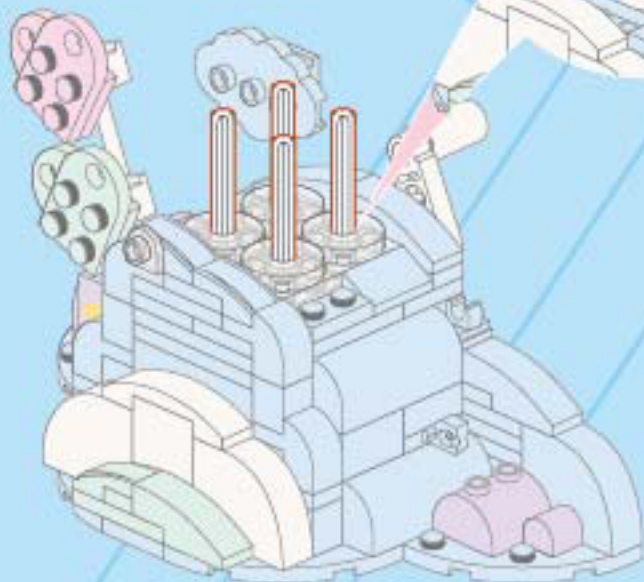
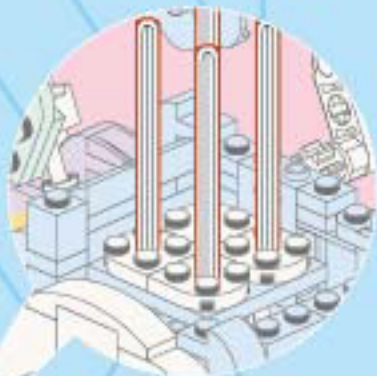



43



1x

2x

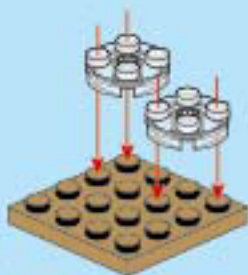

44



2x

2x

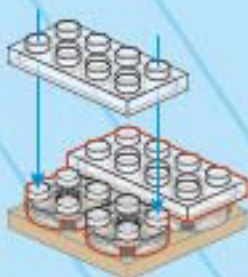

45

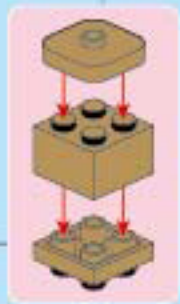
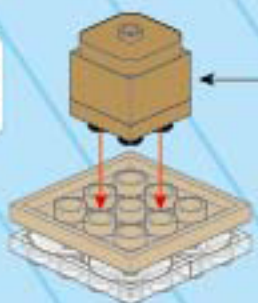

46

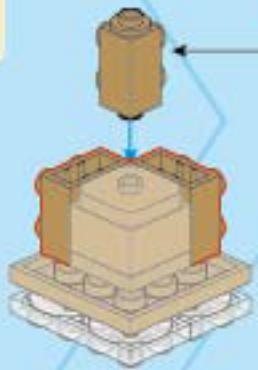
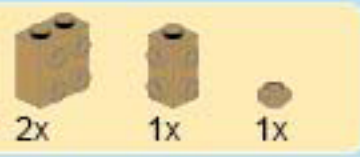

47

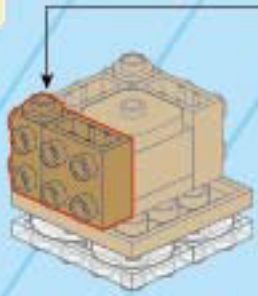
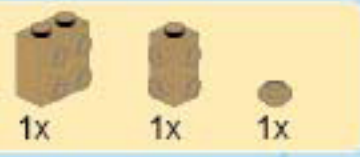

48



1x



2x



2x



2x



49



2x



2x



4x



2x



2x



4x

1

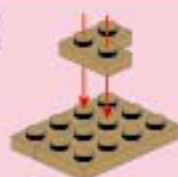

2

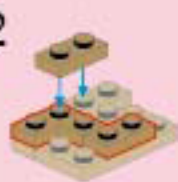

3



2x

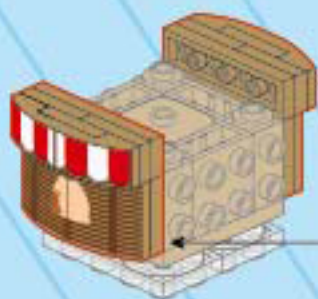

50

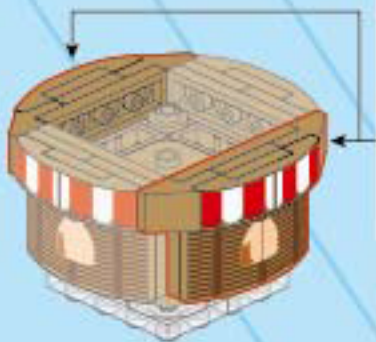
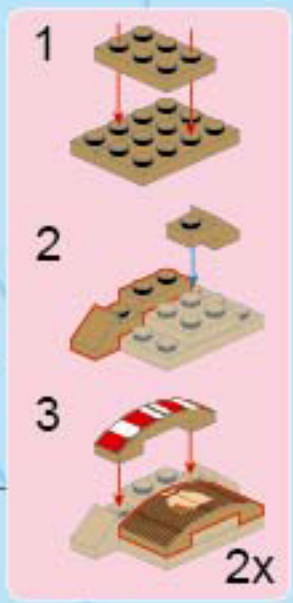
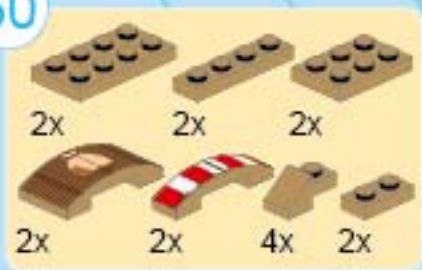

51

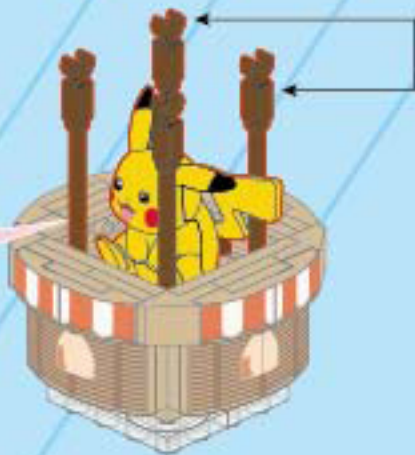
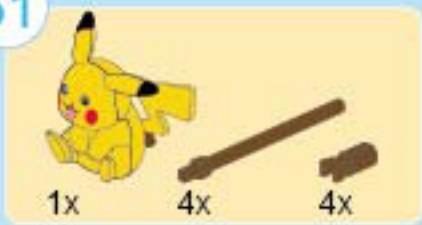

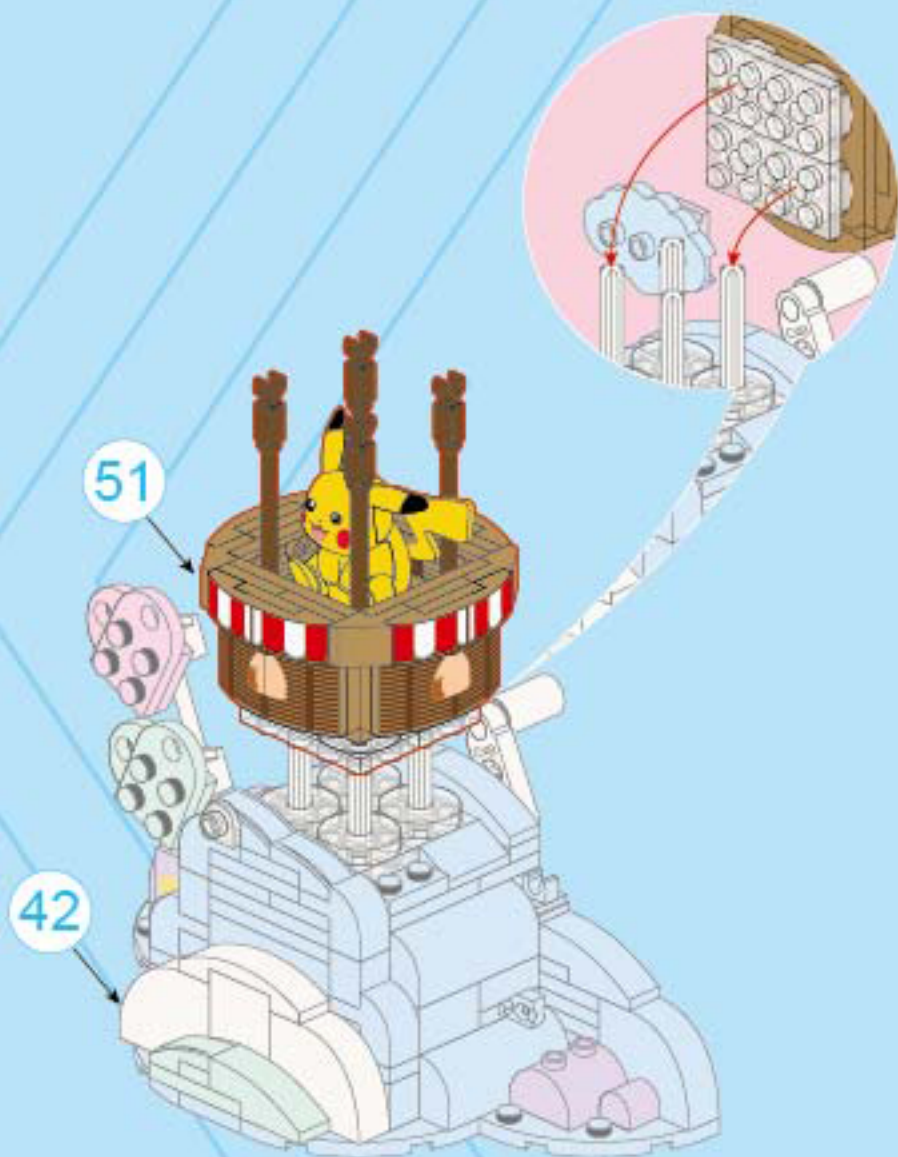



53



1x

2x

2x

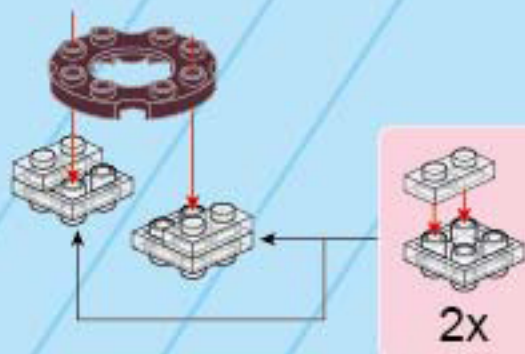

2x

54



2x



55

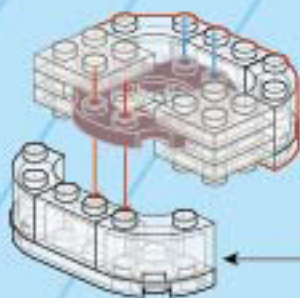
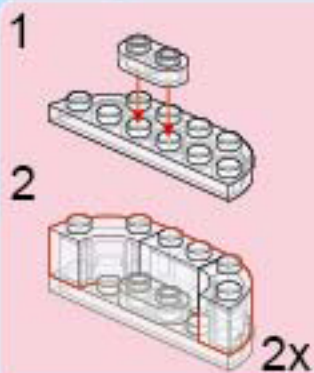
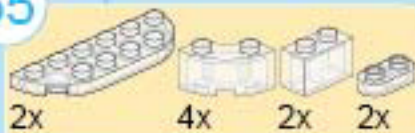

56

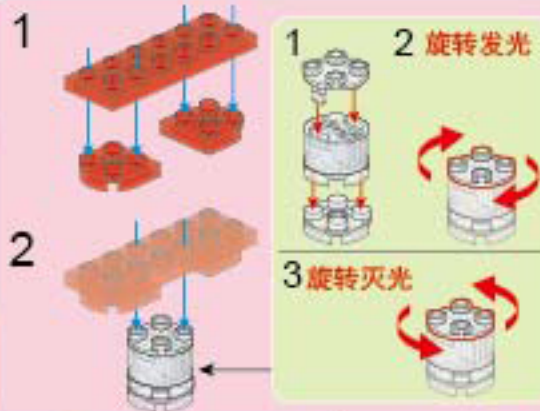
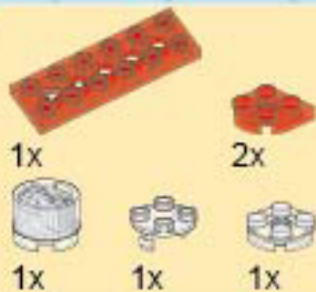

57



4x

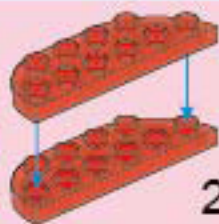

2x

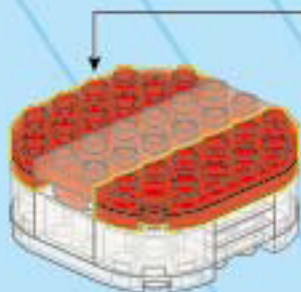

58



2x

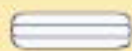

2

1:1



59

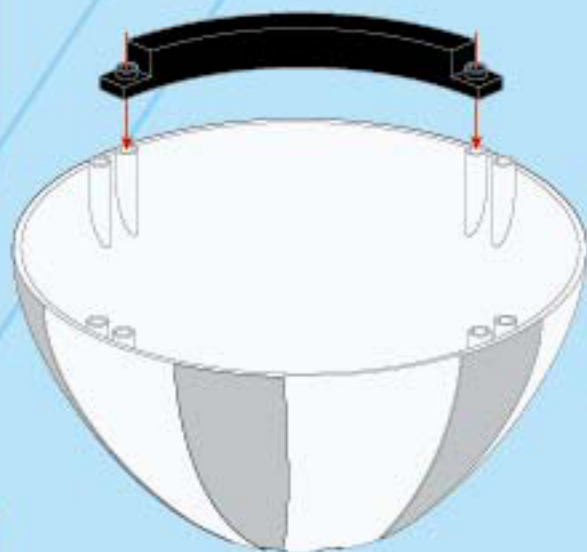

60

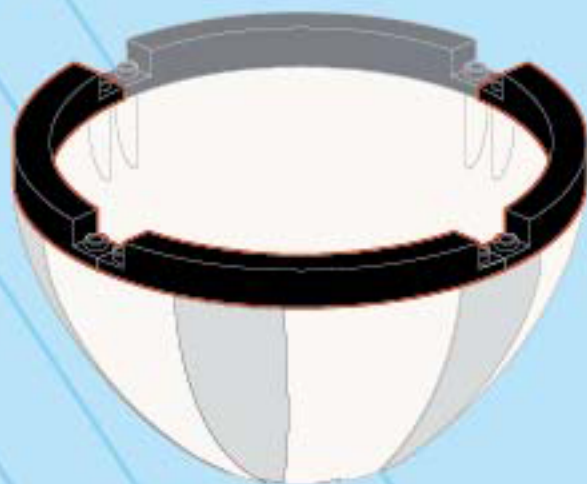

61

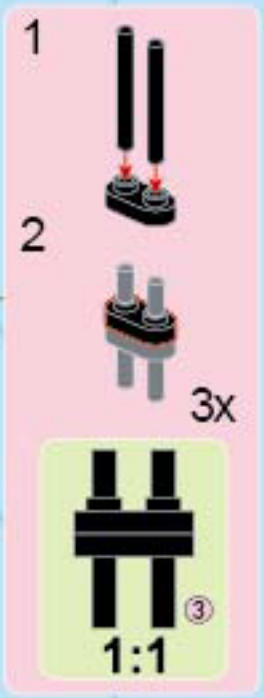
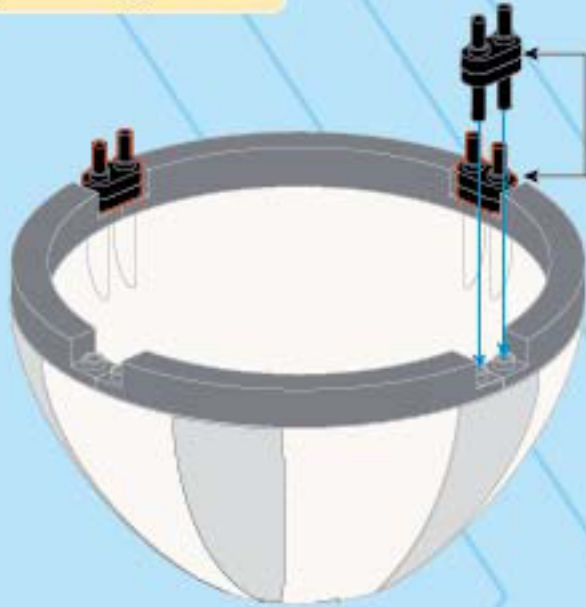

62

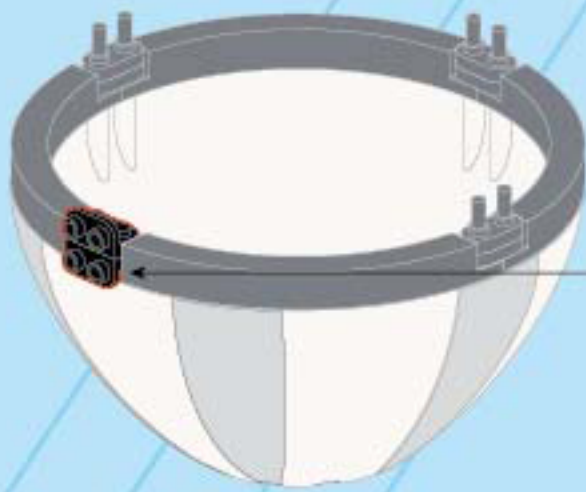

63

注意拼装方向

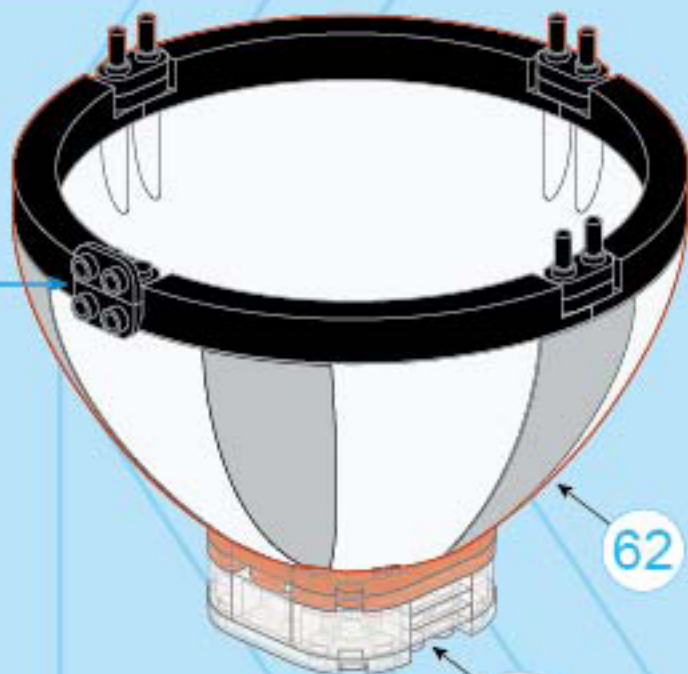
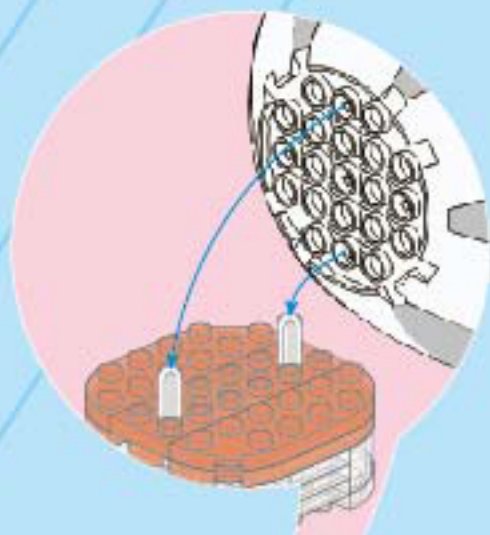
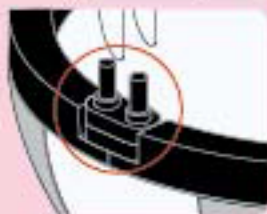

62

58

64

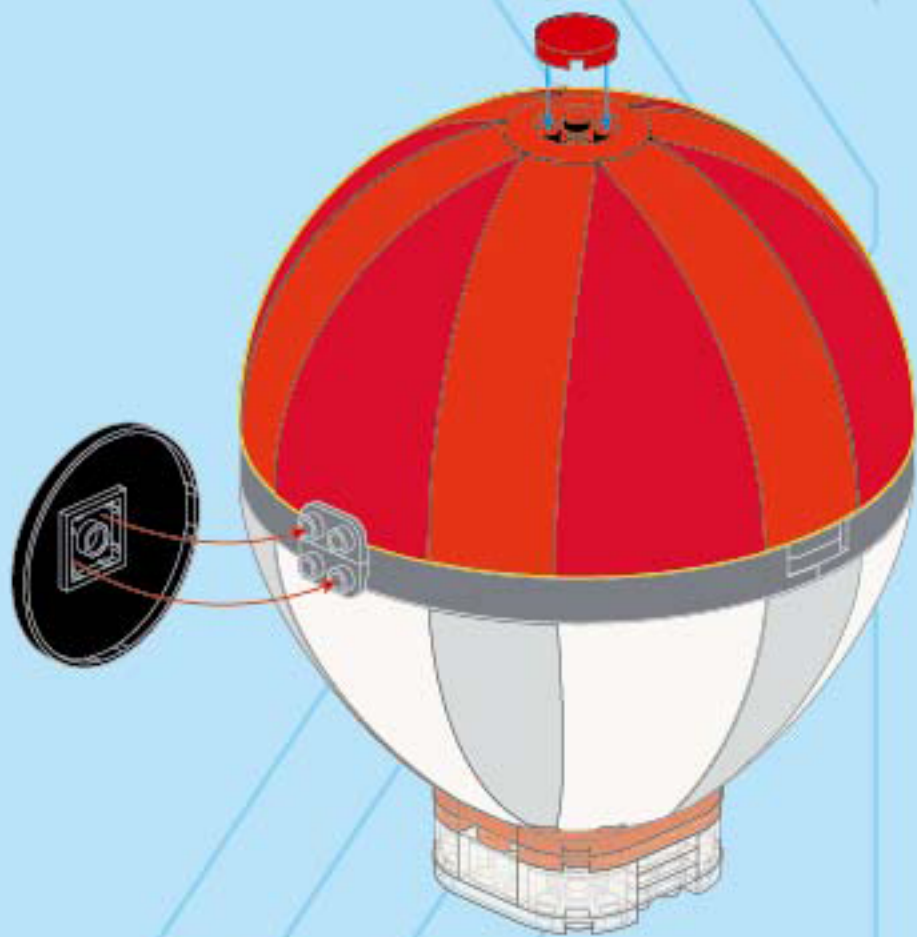

65



1x



1x

②

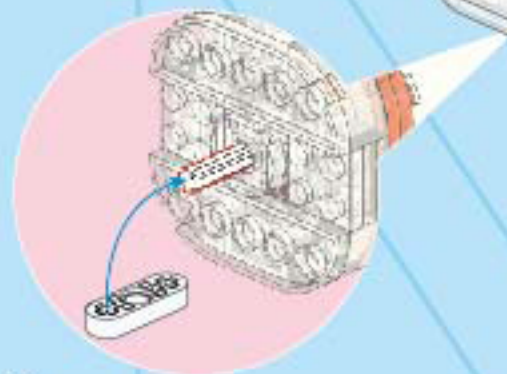

②

1:1

66

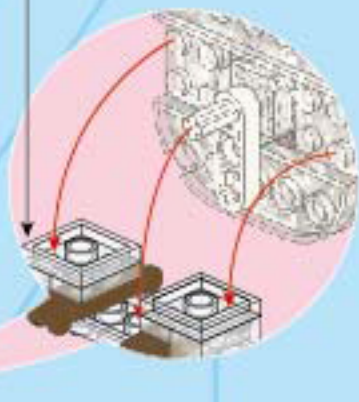
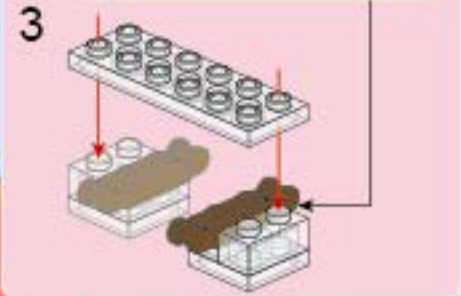
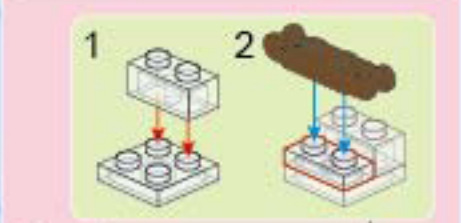
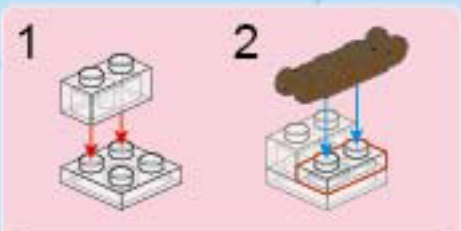
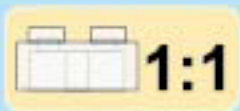
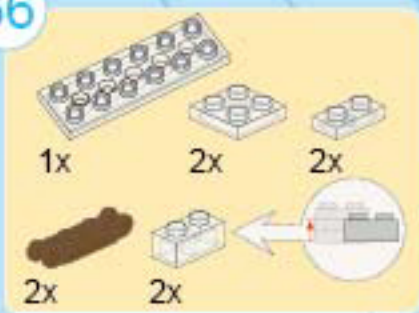

67

66

52

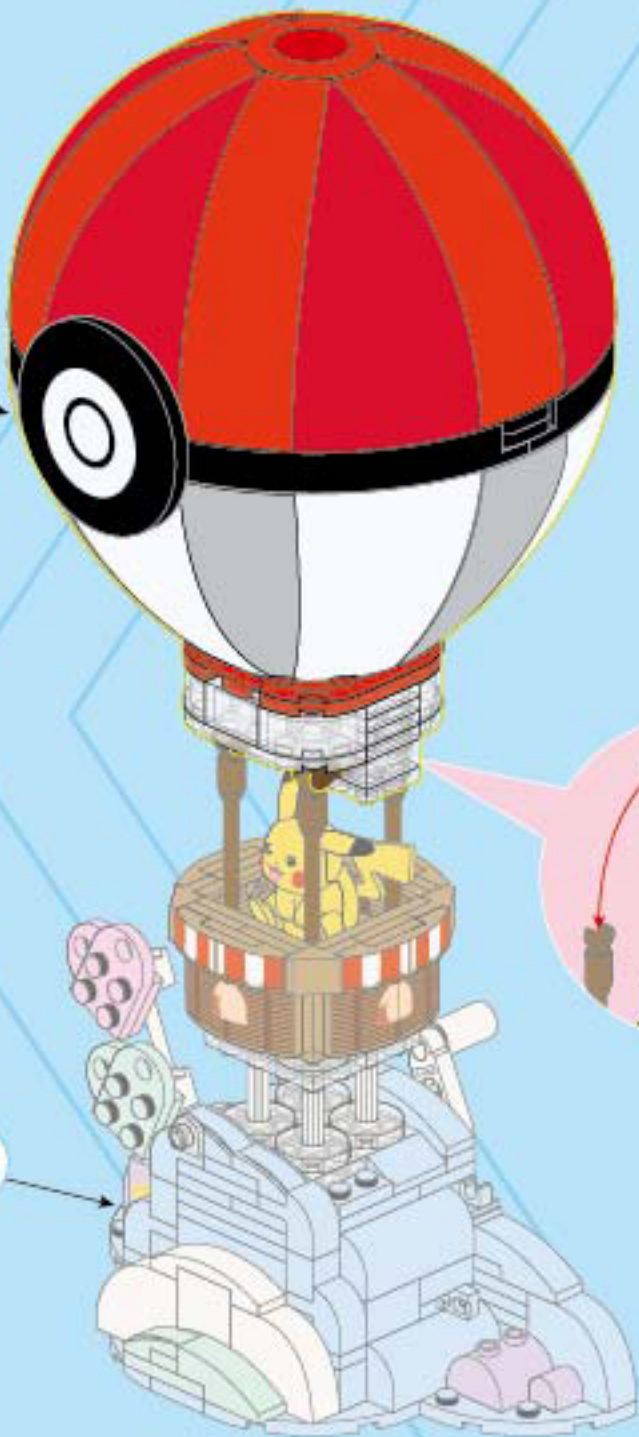

68

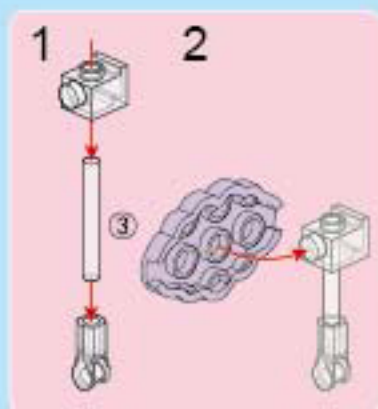
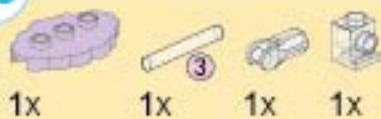

69



1x



1x



1x



1x



1x



1



2



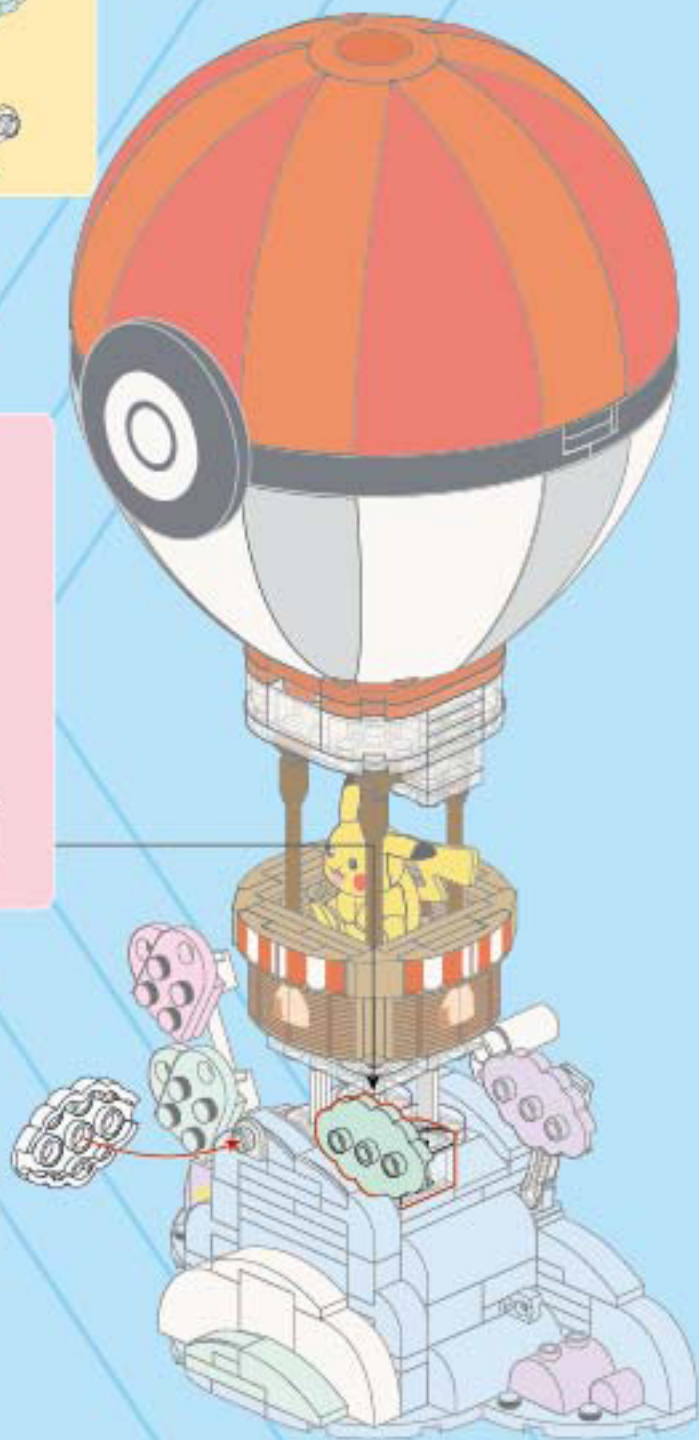

3

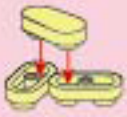

- 1x 
- 1x 
- 1x 
- 5x 
- 5x 

1 

2 

3 

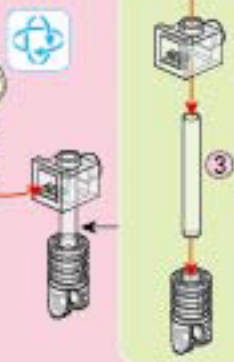
4 



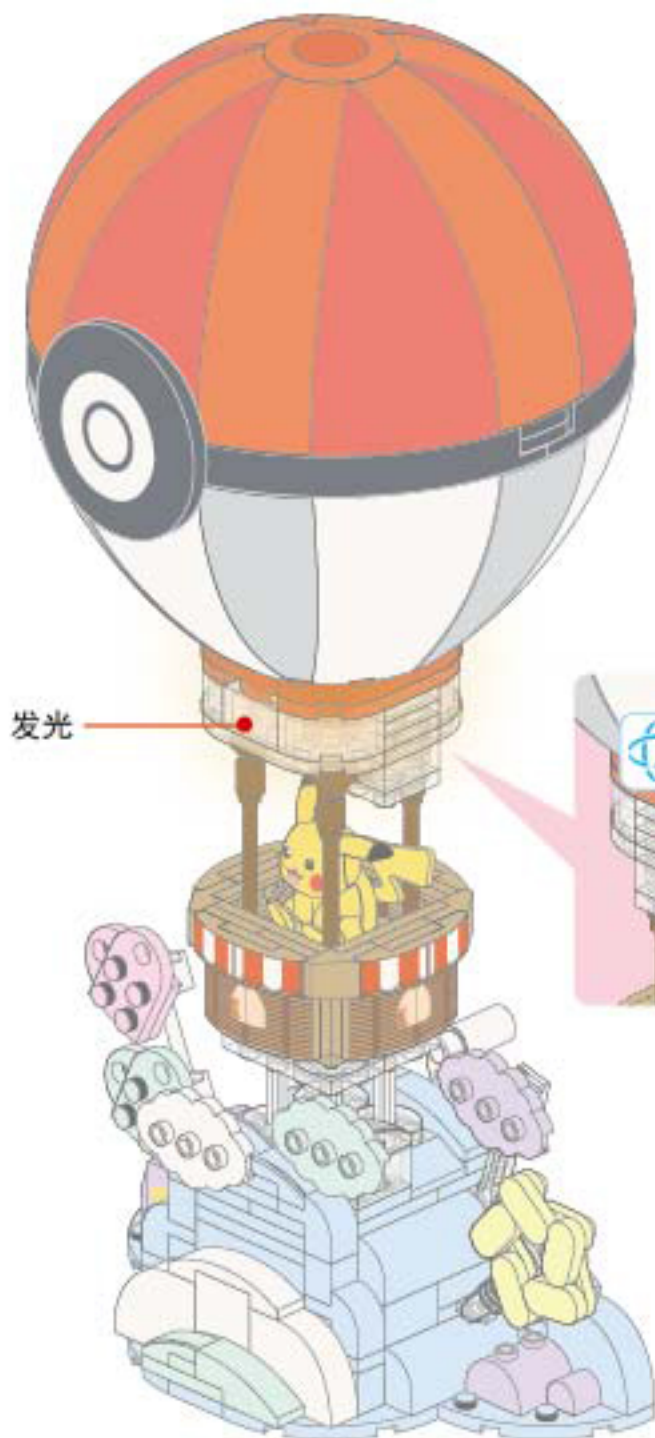

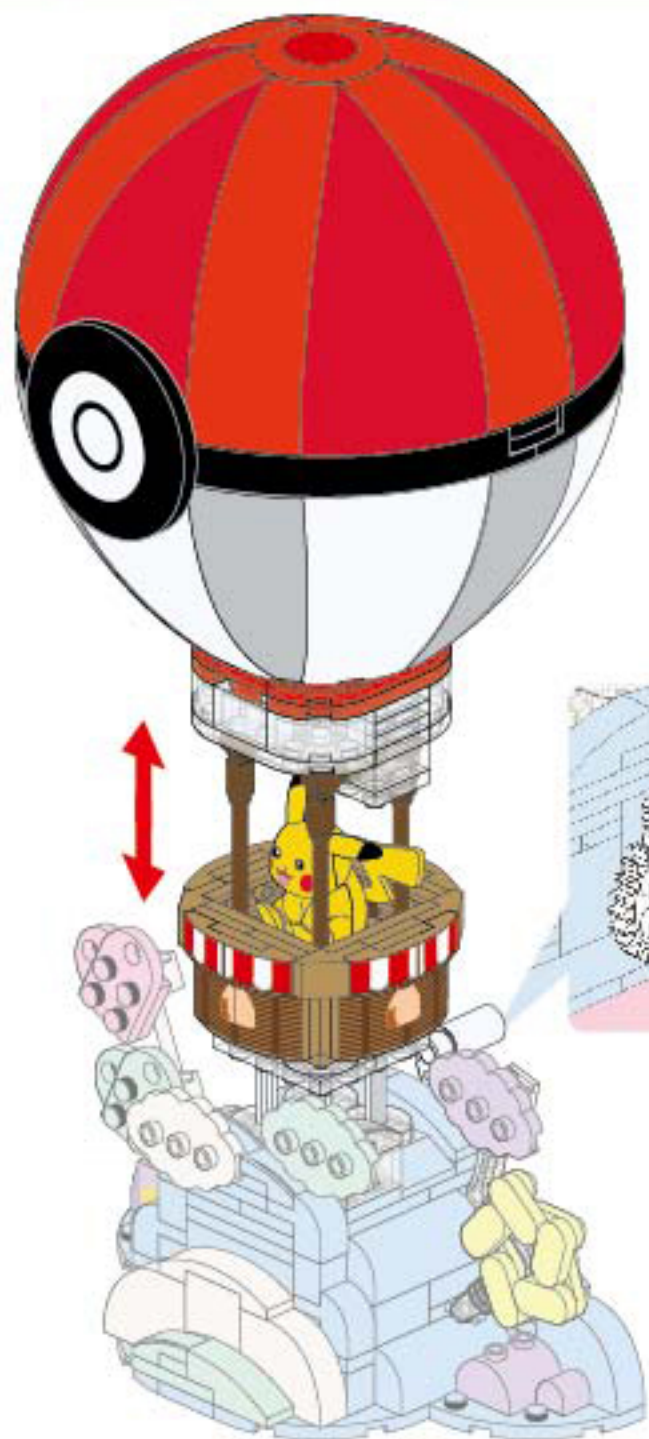

POKÉMON
宝可梦

