

keeperplay

王者荣耀



K21103

图片仅供参考，请以实物为准。

貂蝉
仲夏夜之梦

©2023 Tencent. All Rights Reserved.

腾讯公司 版权所有



拆件器使用方法，仅为示例

Usage of Brick Separator, Just for the sample

1



3



2



4

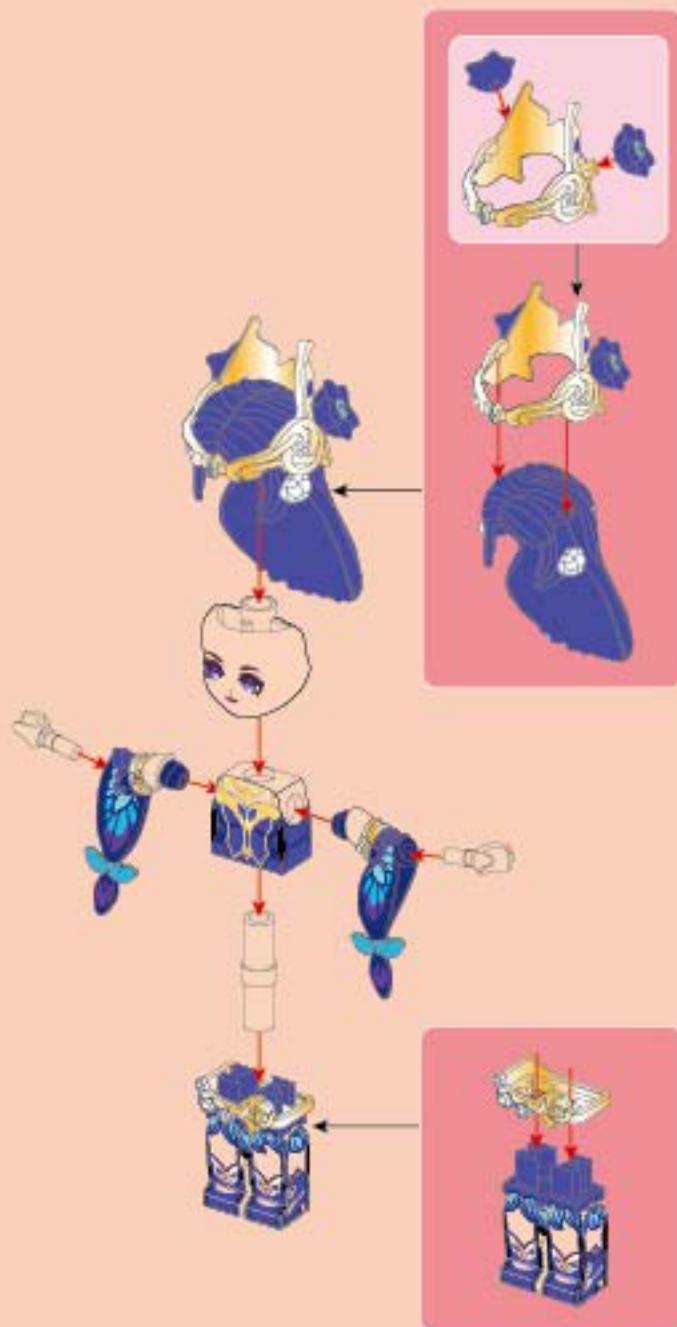

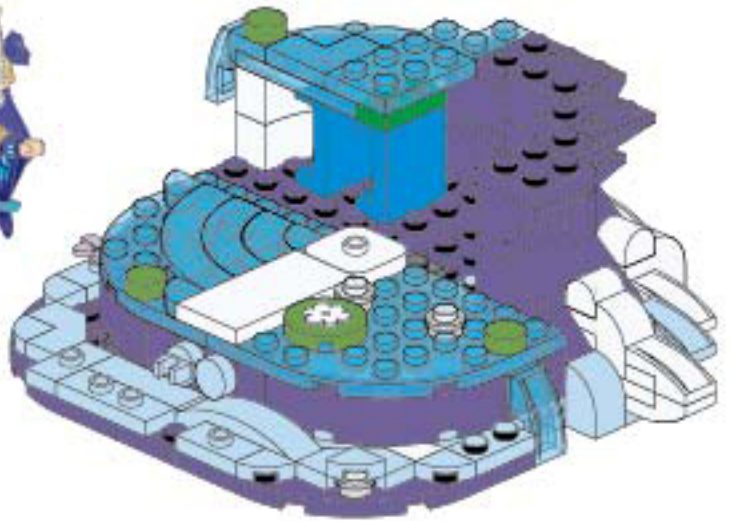

1

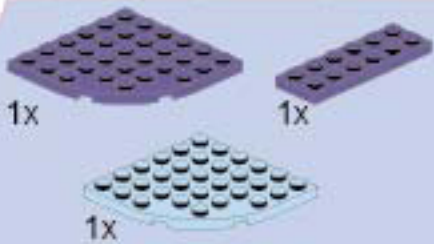

2

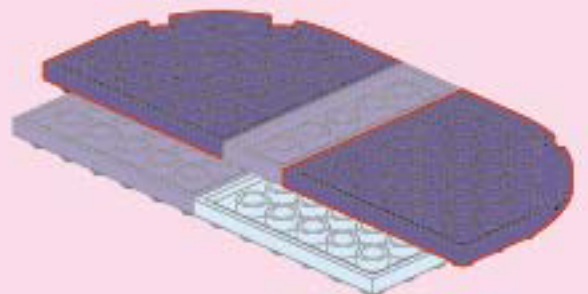
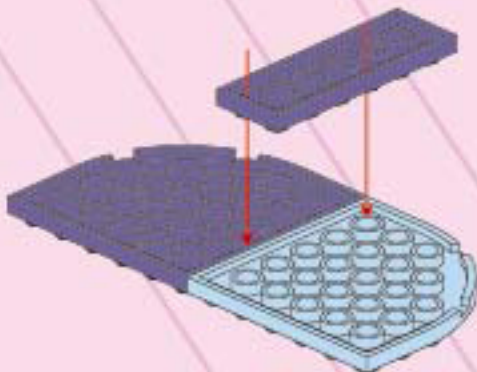

3

3

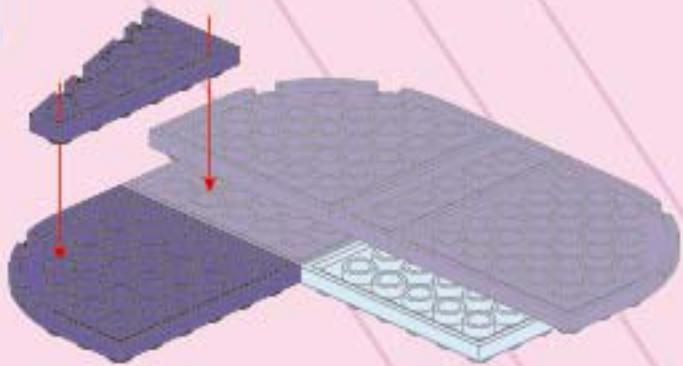
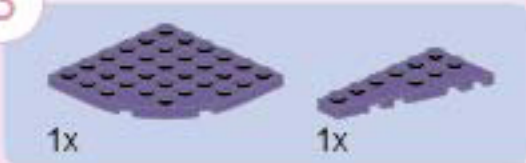

4

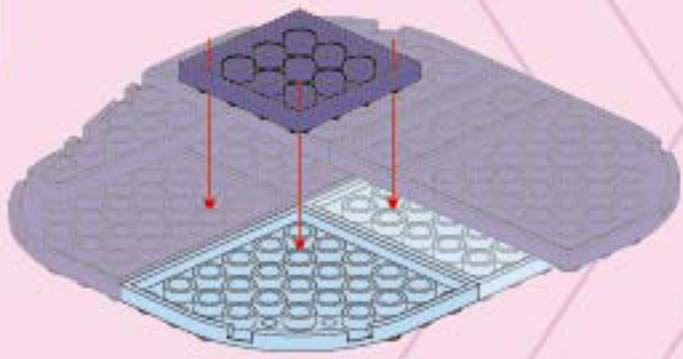

5

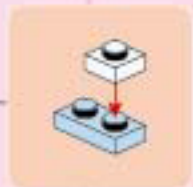
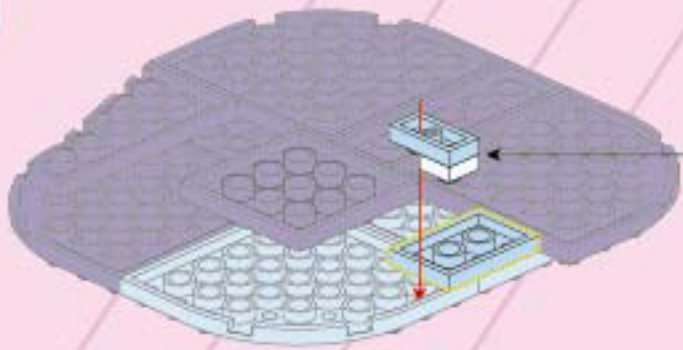

6

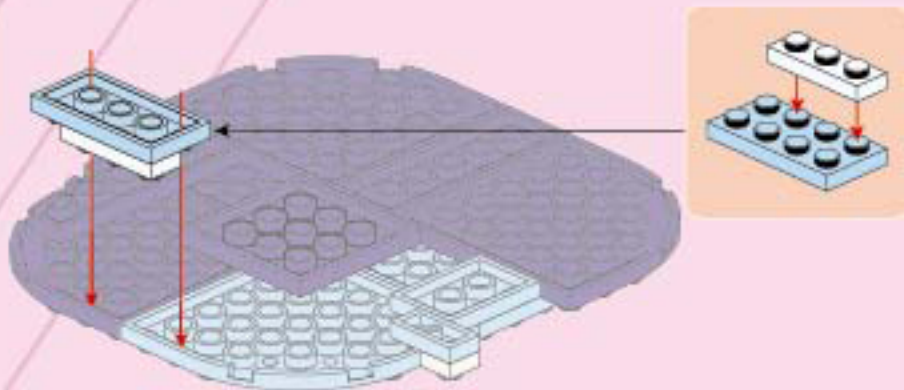

7

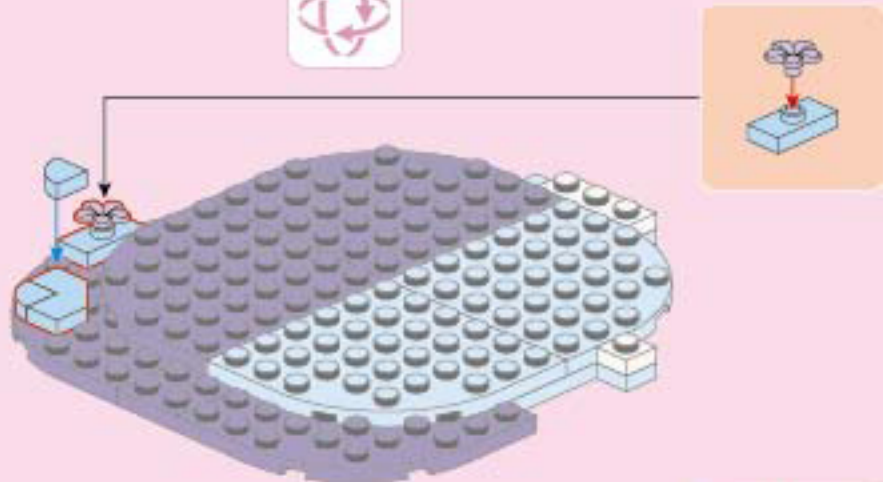

8

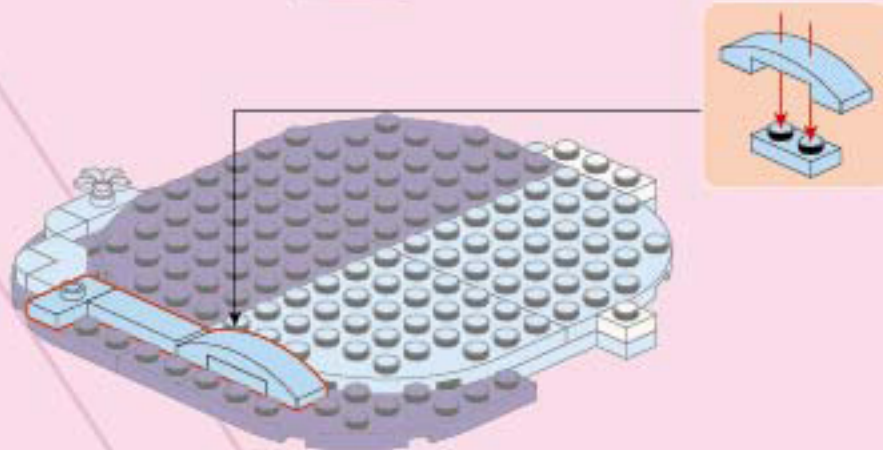
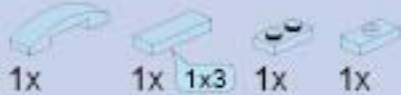

9



1x



1x



1x



1x

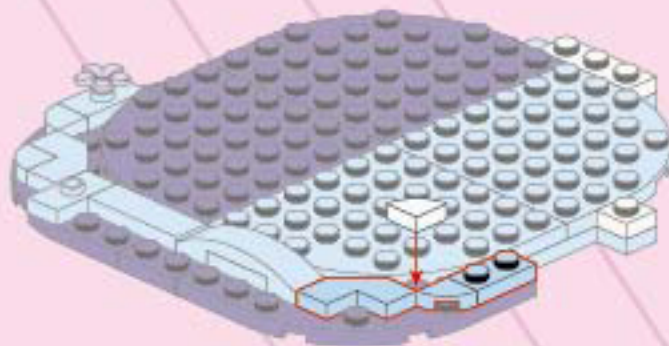

10



1x



1x



2x



1x

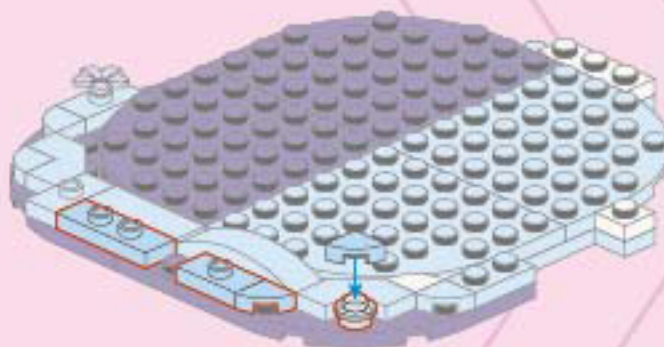

11



1x



1x



2x



1x

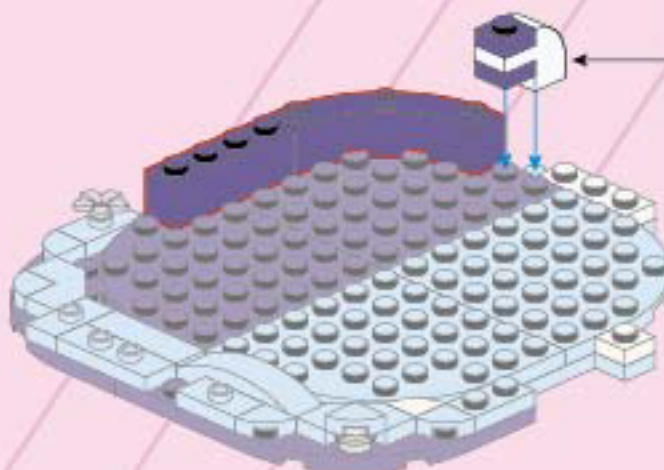

12

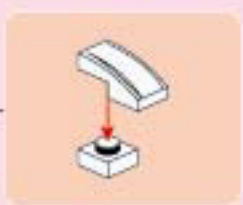
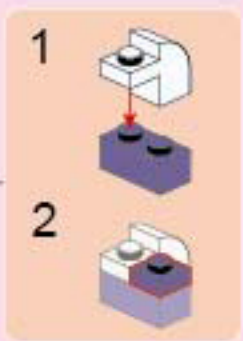
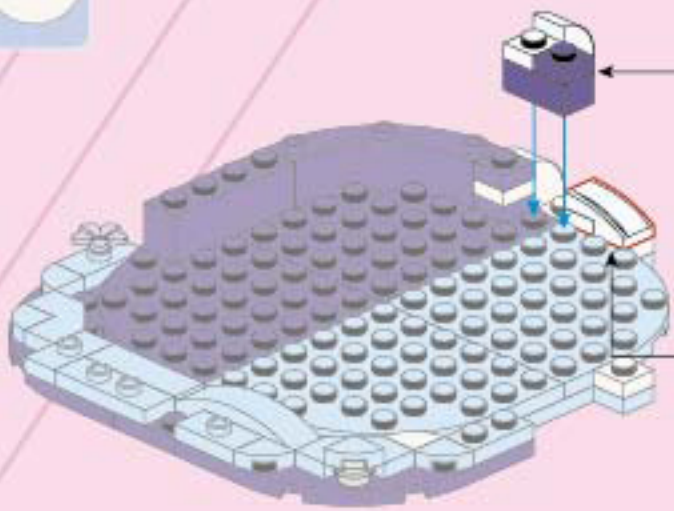

13

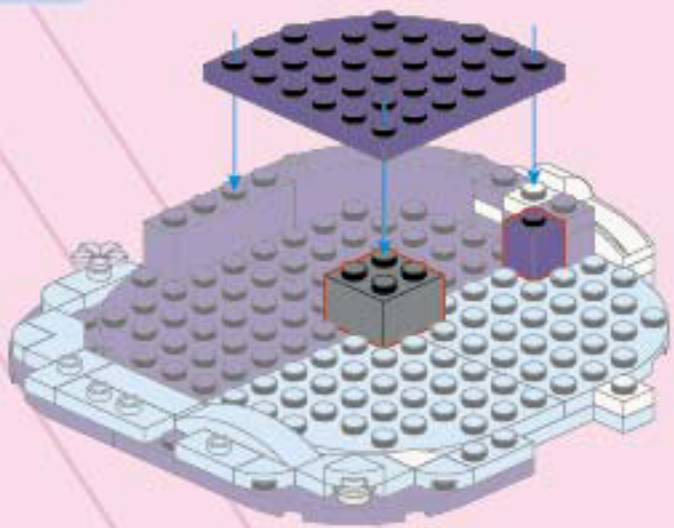
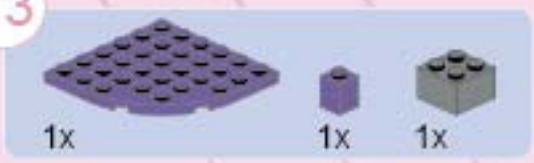

14

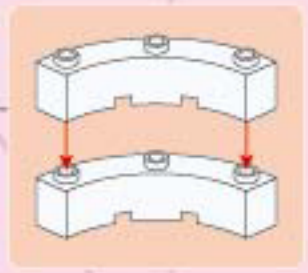
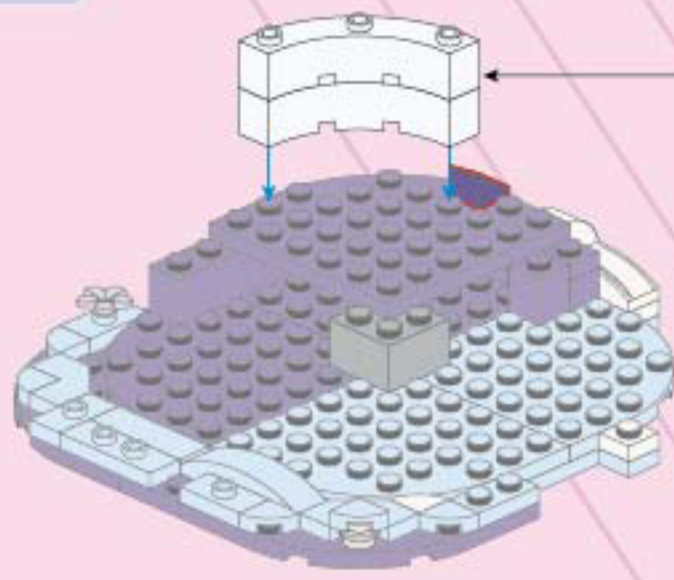

15

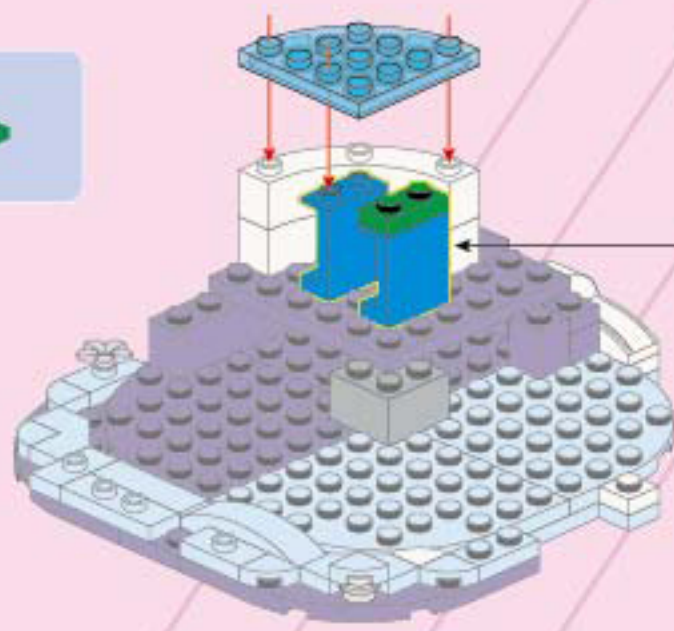

16

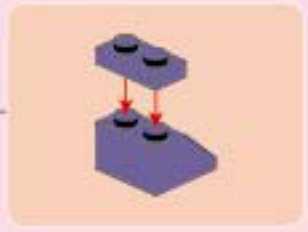
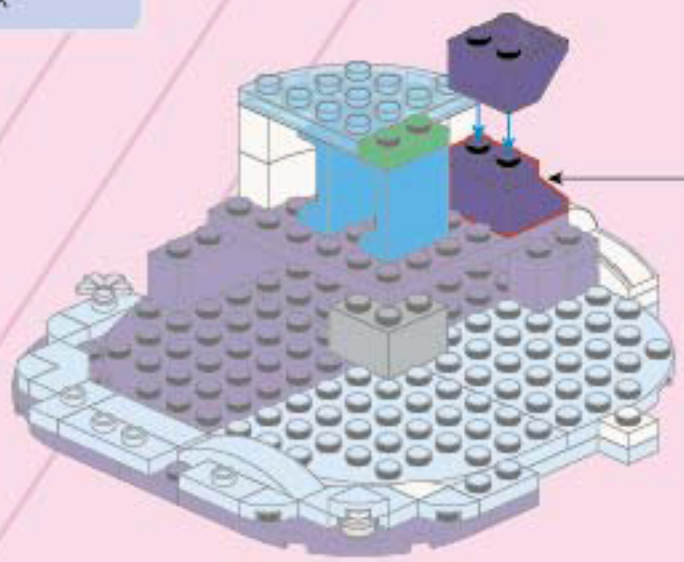

17

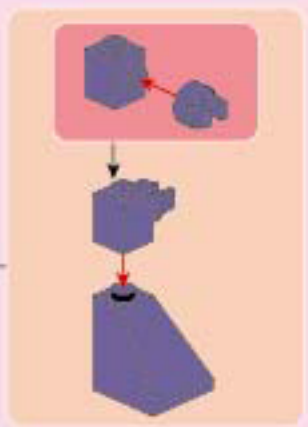
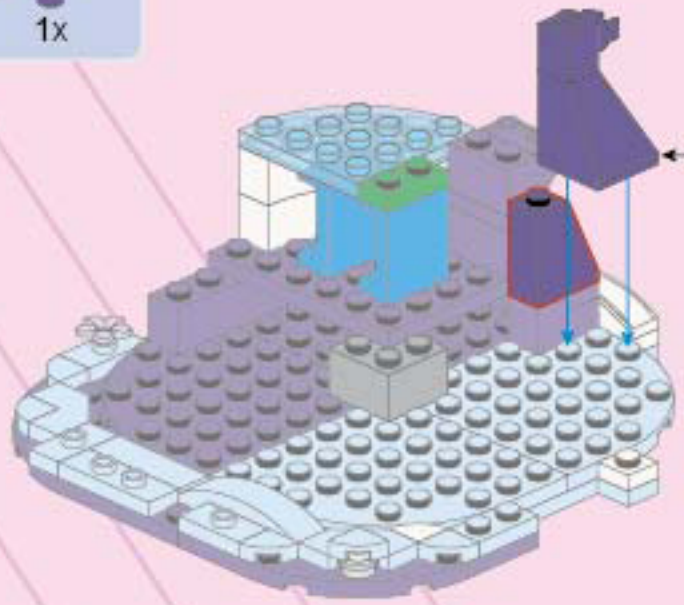
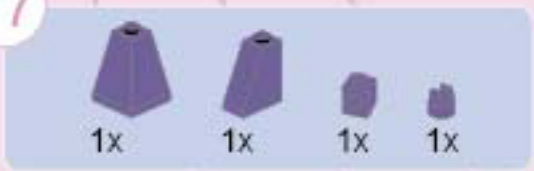

18

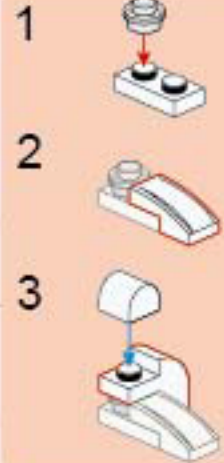
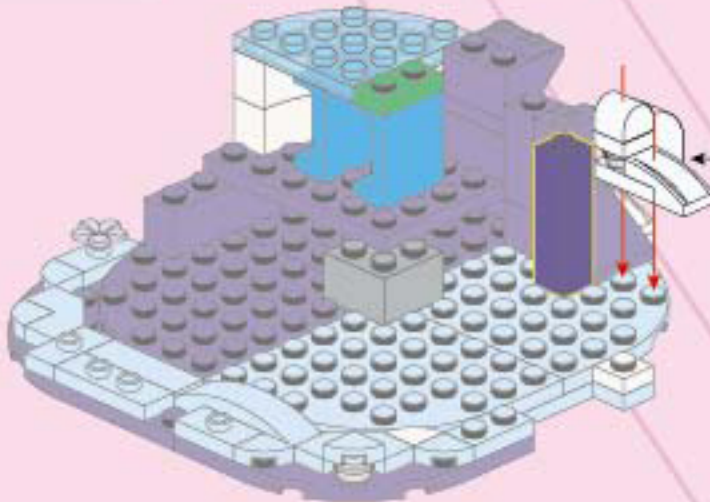

19

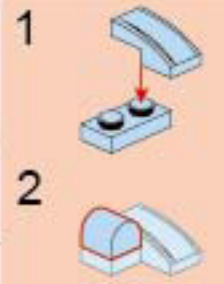
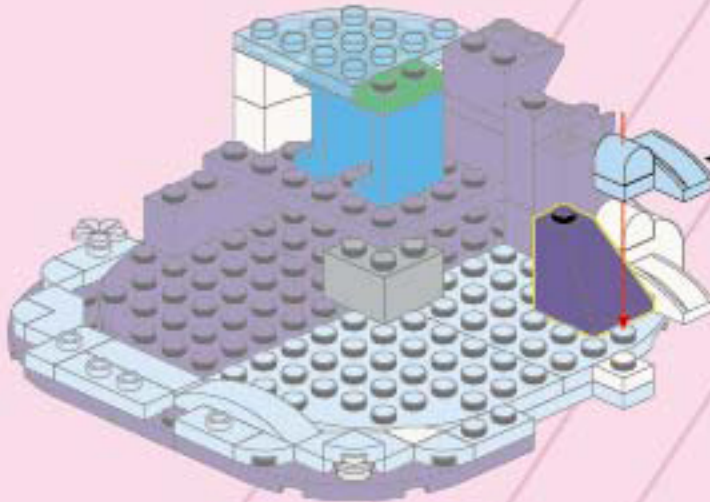

20

- 1x
- 1x
- 1x
- 1x
- 1x
- 1x
- 3x

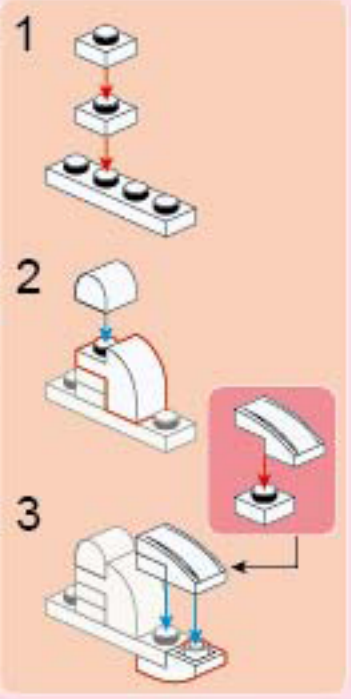
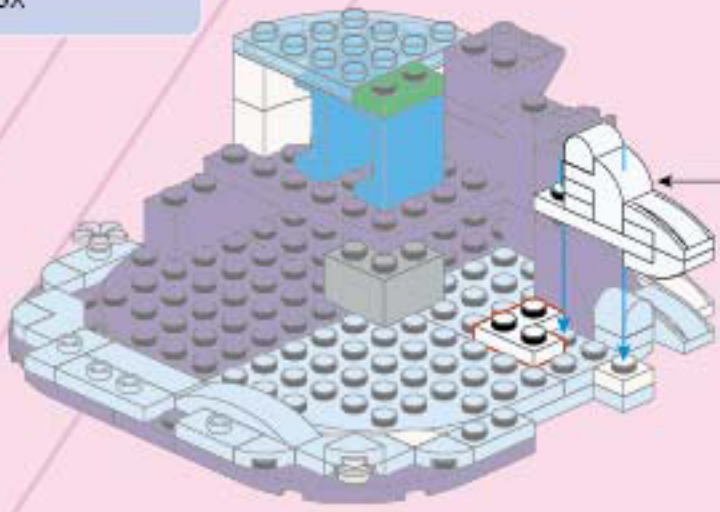

21

- 1x
- 1x
- 1x

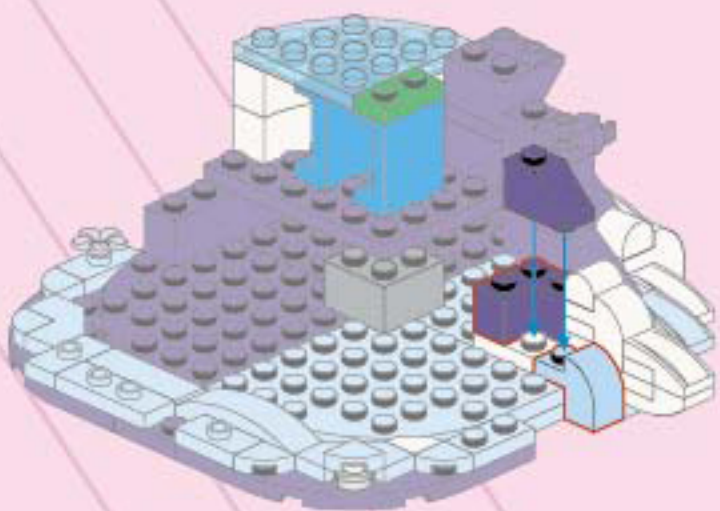

22



1x



1x



1x



2x



1x

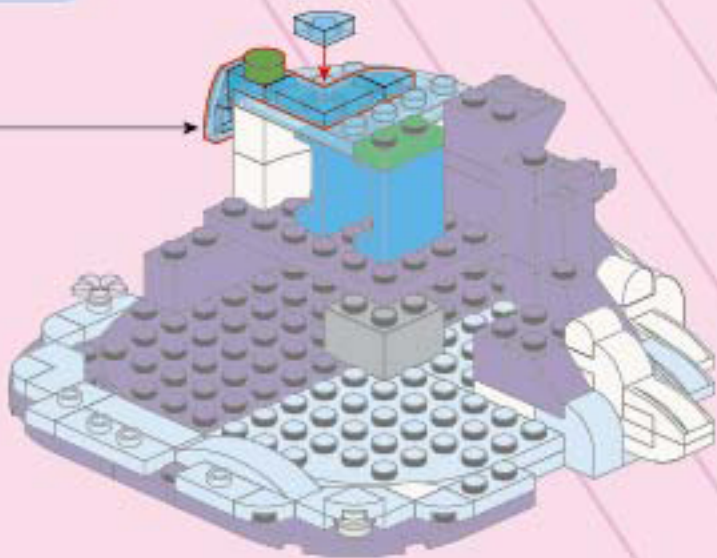
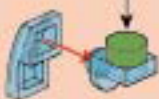

23



1x



1x



1x



1x



1x

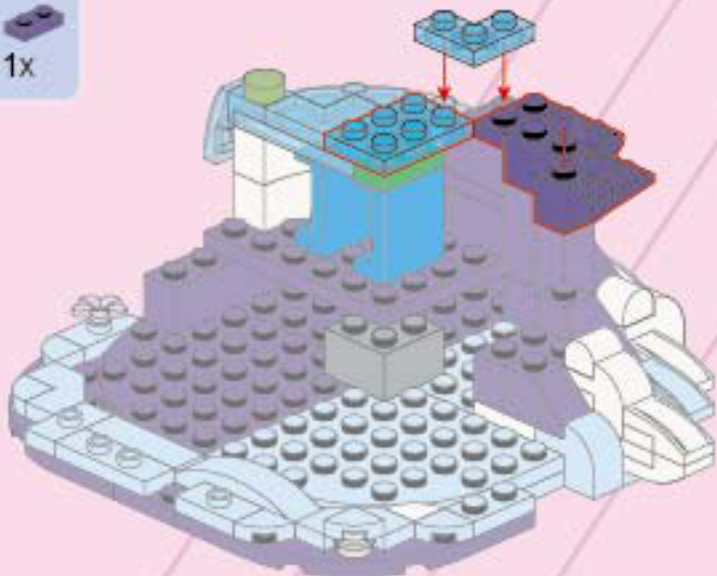

24

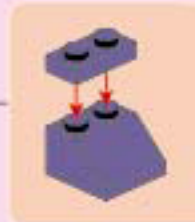
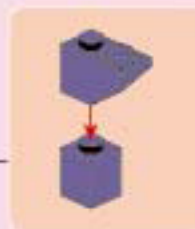
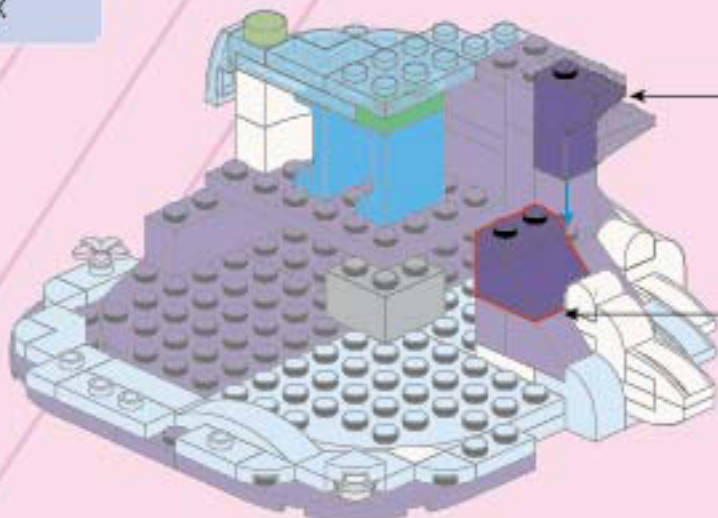

25

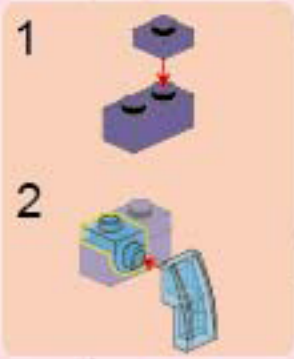
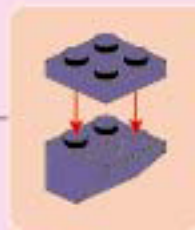
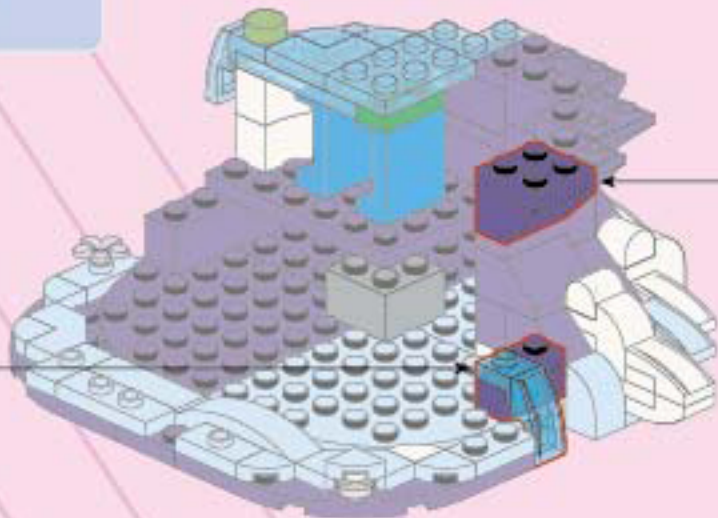
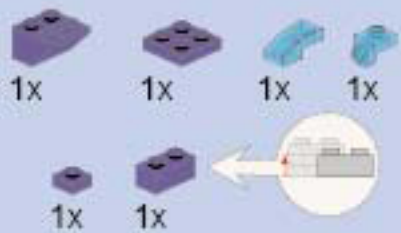

26

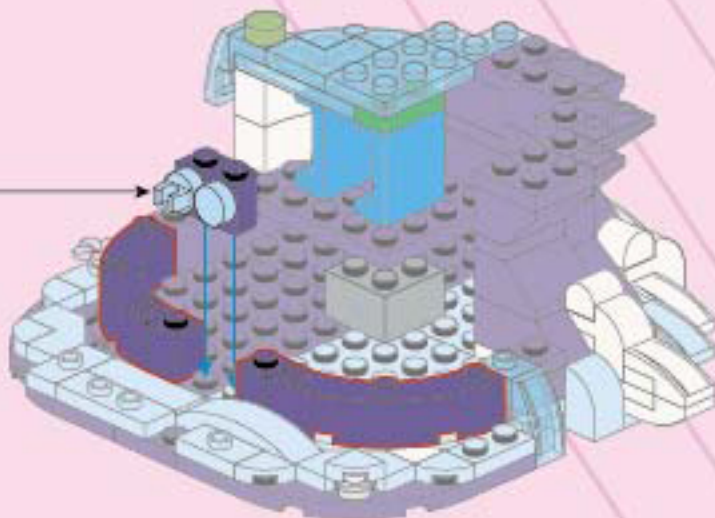
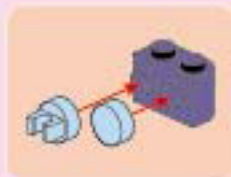
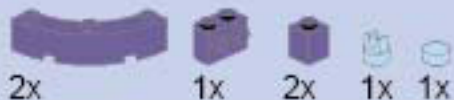

27



2x

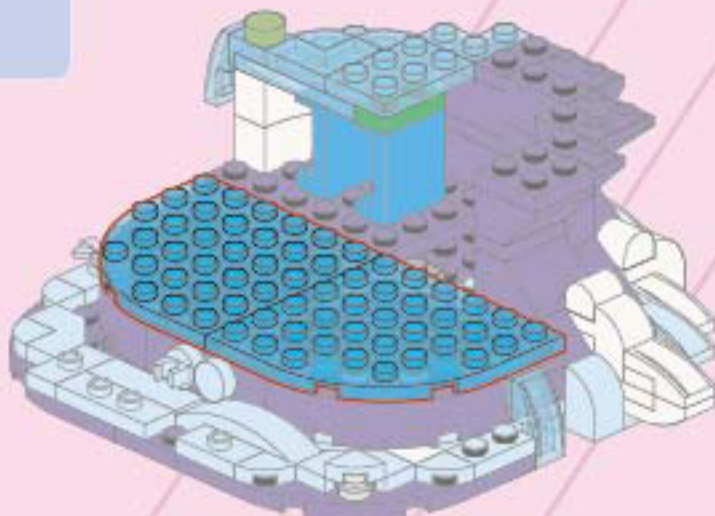

28

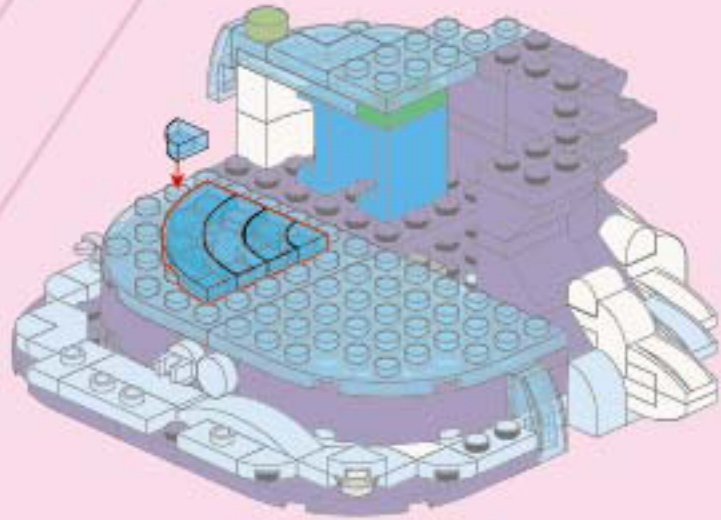
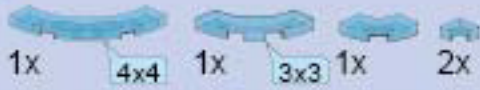

29

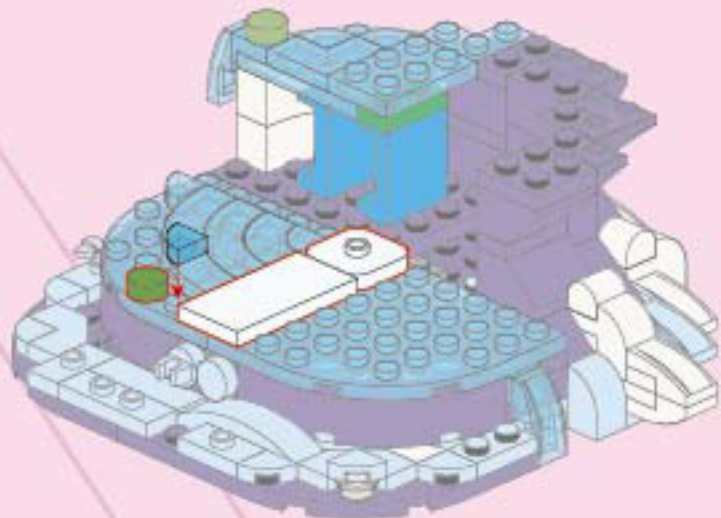

30



1x



1x



1x



2x

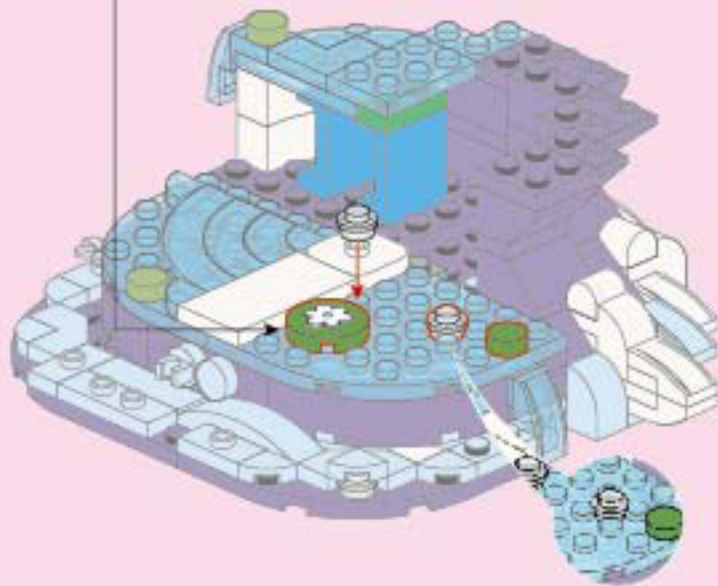

1x

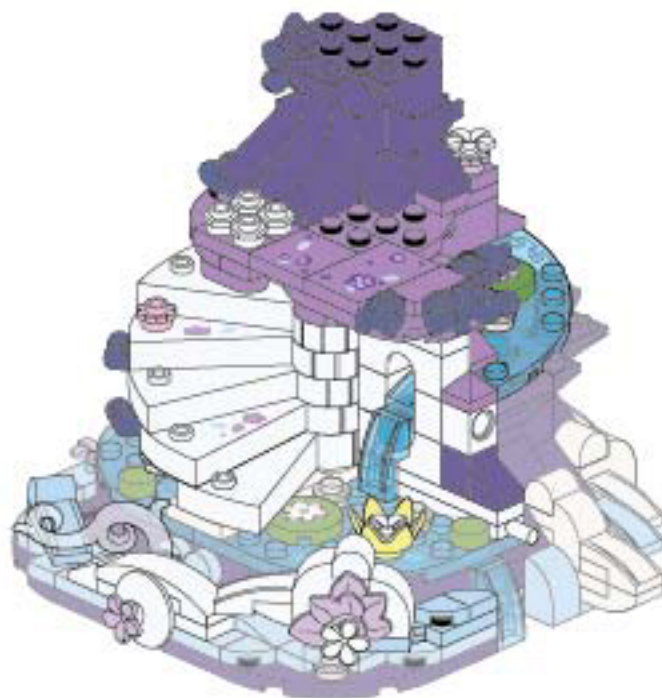

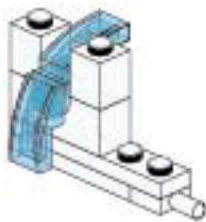

31

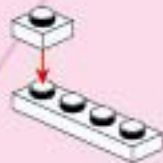

32

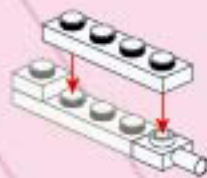

33

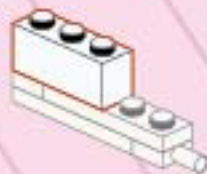

34

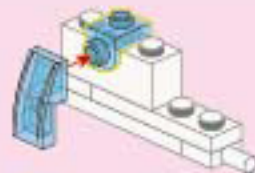

35



36

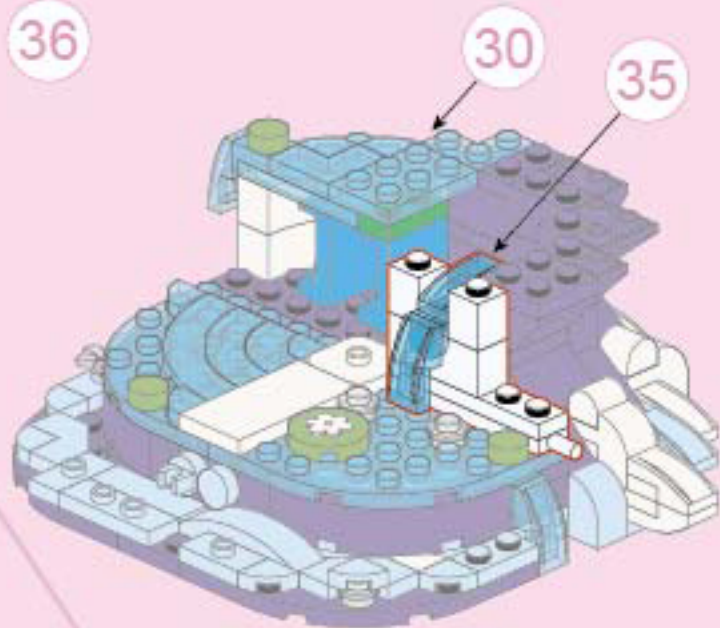

37

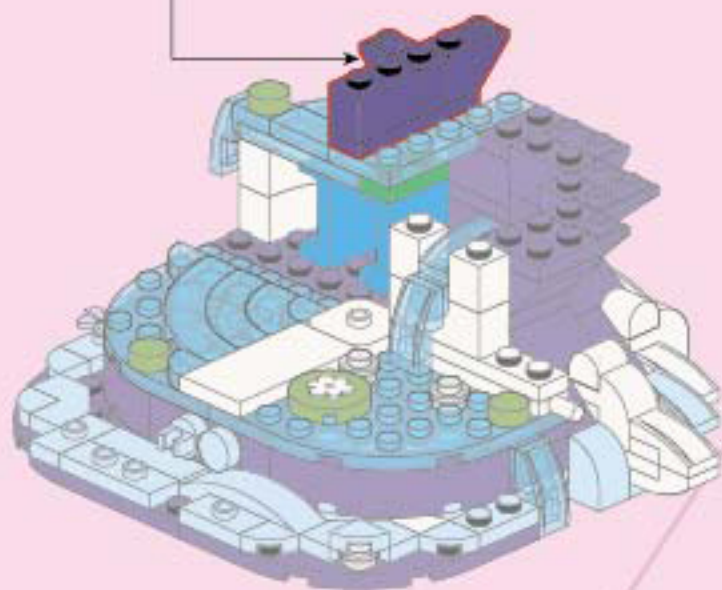
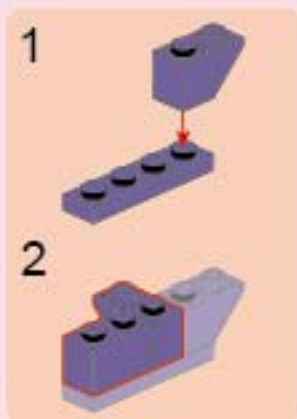
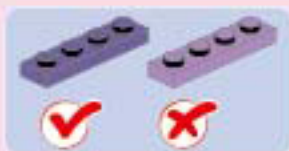
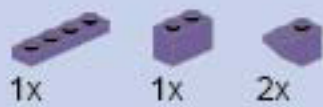

38

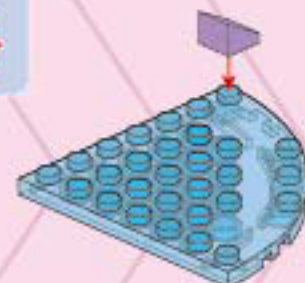
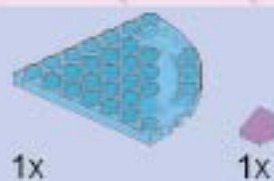

39

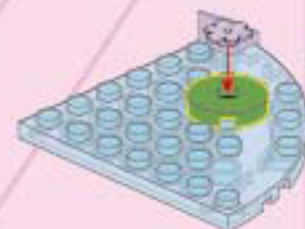

40

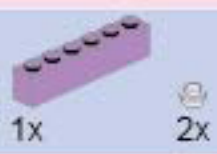

41

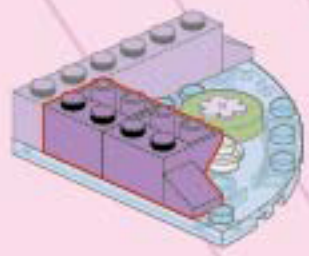
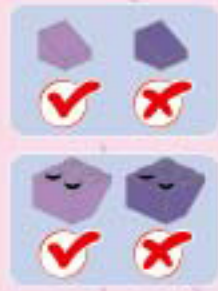

42

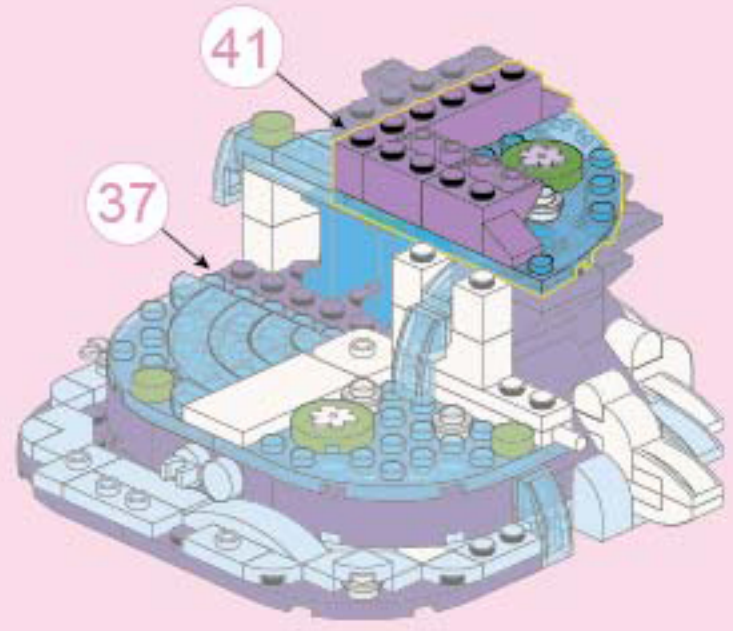

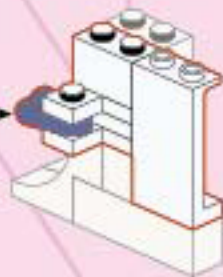
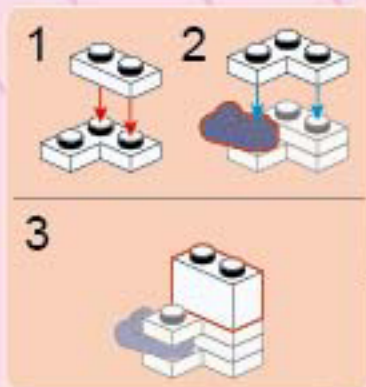
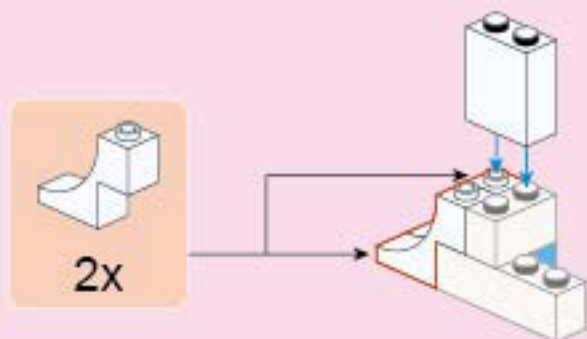
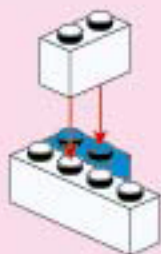
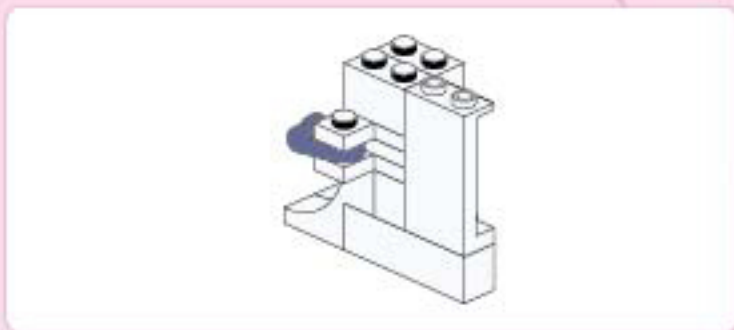

47



1x



1x

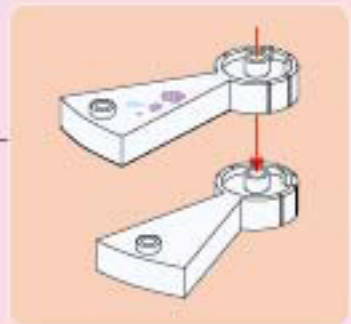
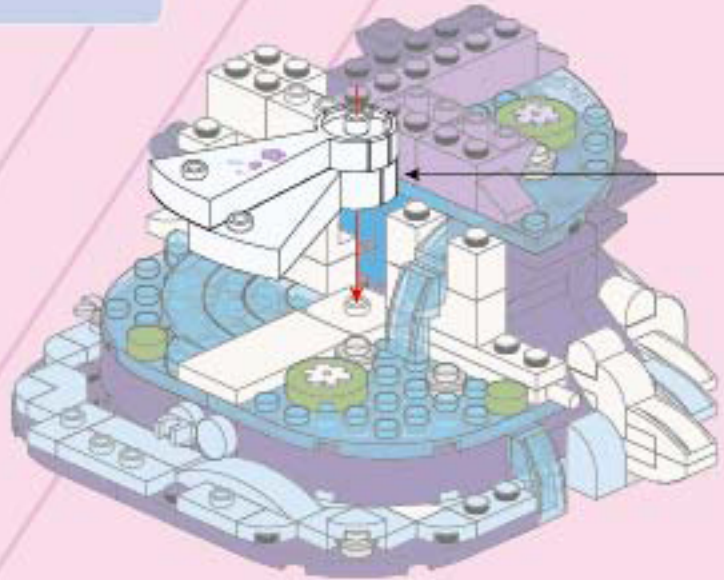

48



1x



1x



1x

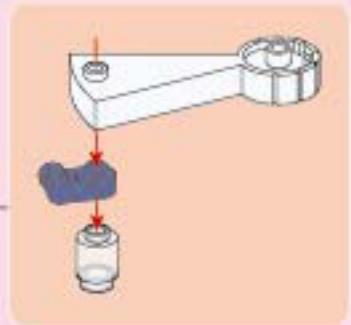
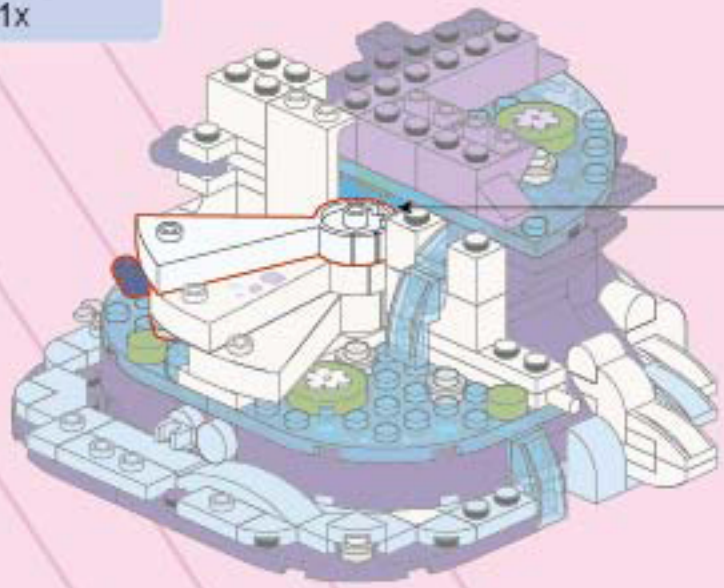

49



1x



1x



1x



1x

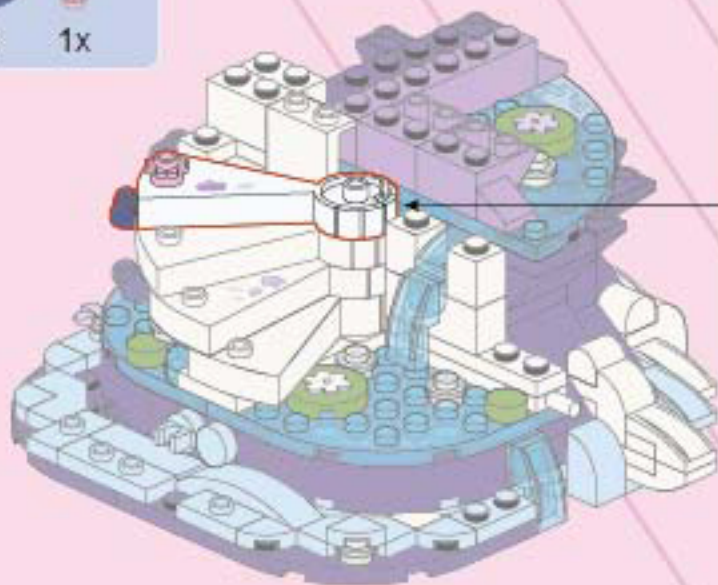

1



2

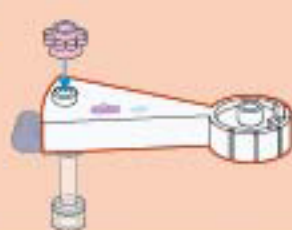

50



1x

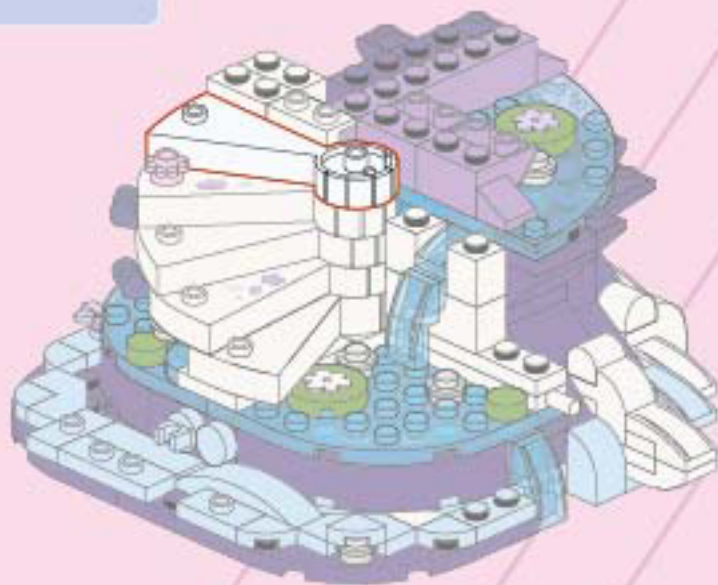



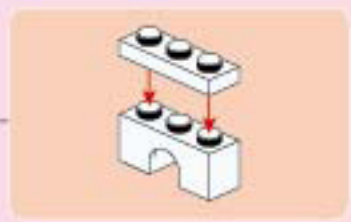
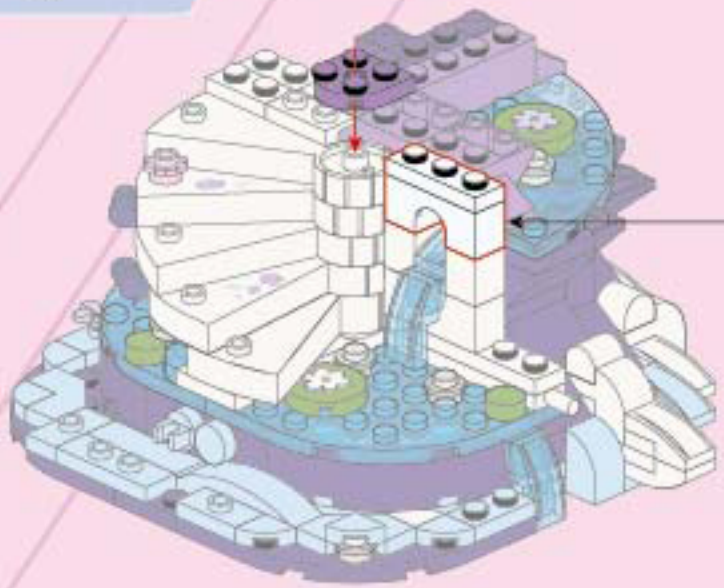

51

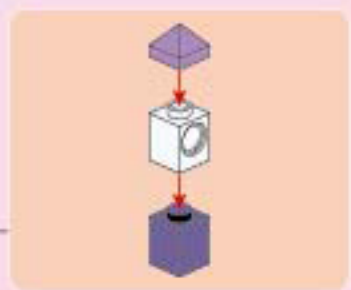
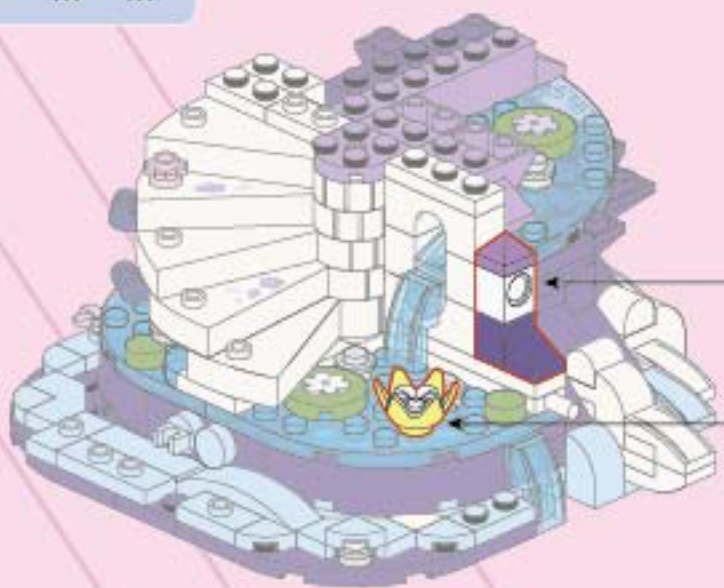

52



53

- 
1x
- 
1x
- 
1x
- 
1x

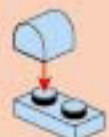
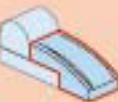
- 1 
- 2 

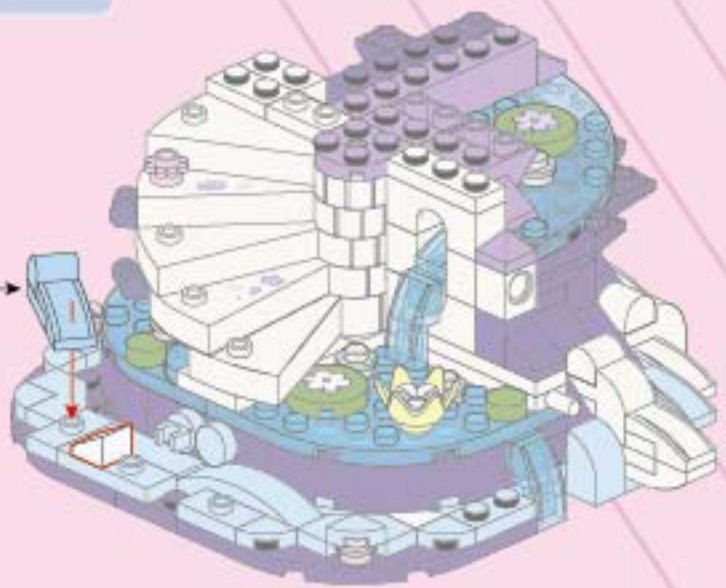

54

- 
1x
- 
1x
- 
1x
- 
2x

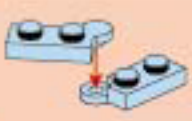
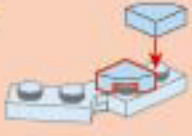
- 1 
- 2 

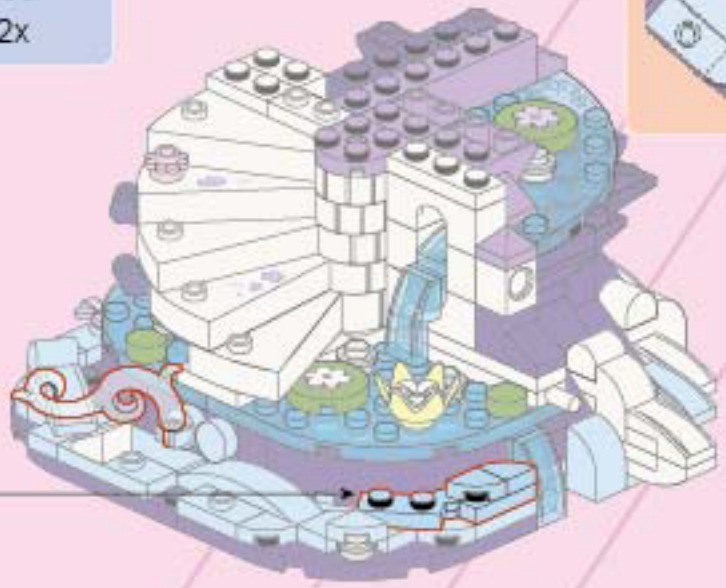





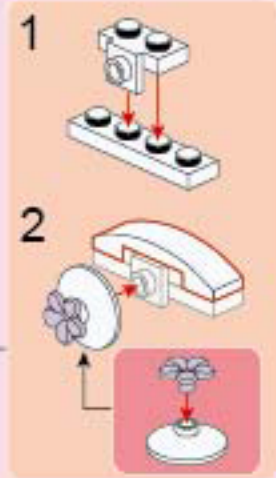
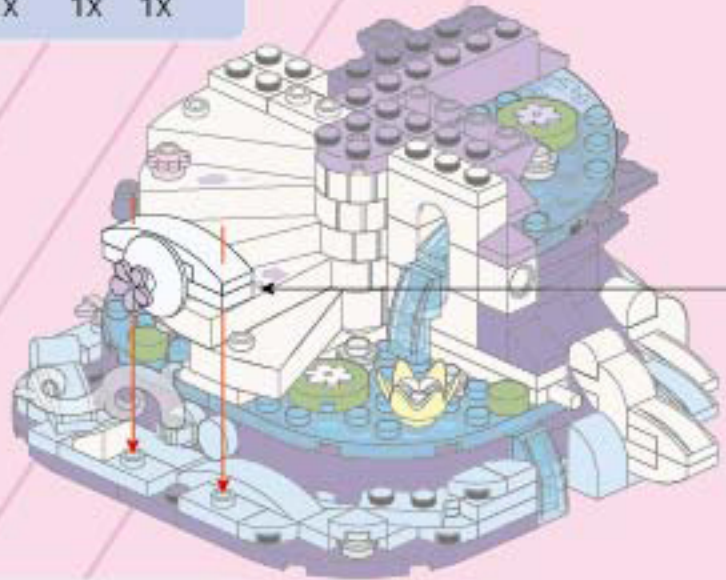

55

-  1x
-  1x
-  1x
-  1x
-  1x

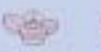

56

-  2x
-  1x
-  1x
-  1x
-  1x
-  2x
-  1x
-  1x

 1:1

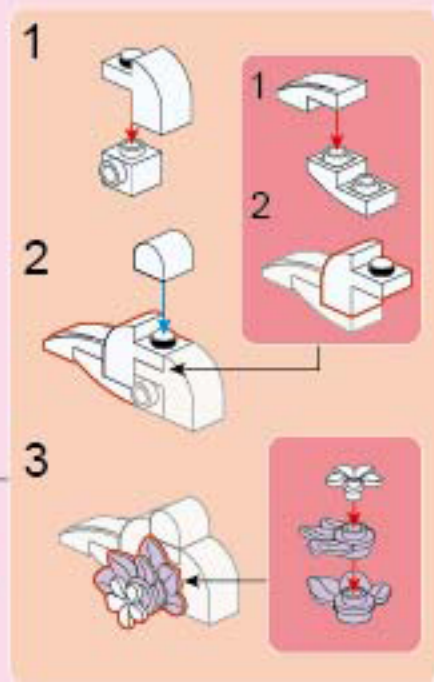
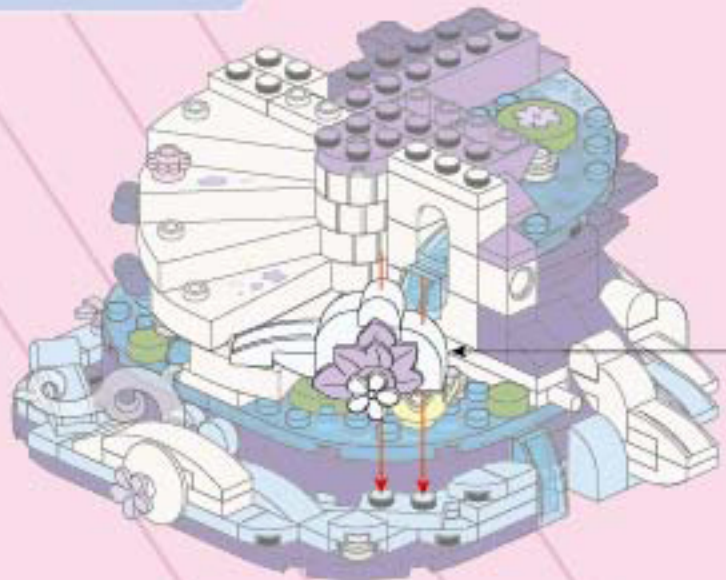

57

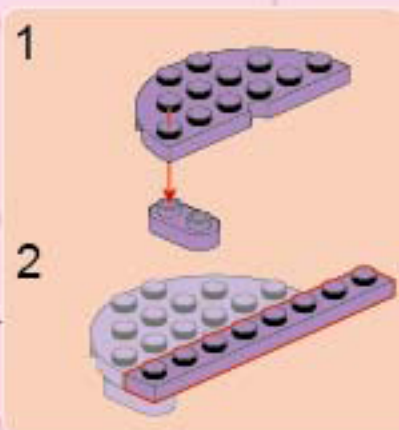
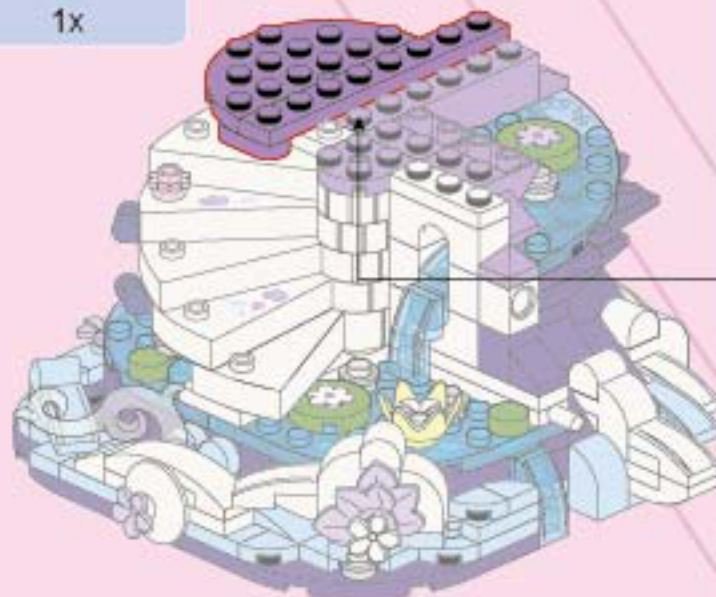
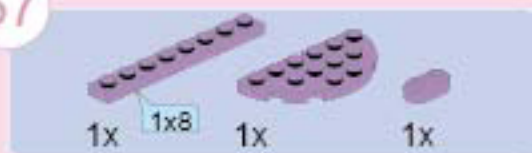

58

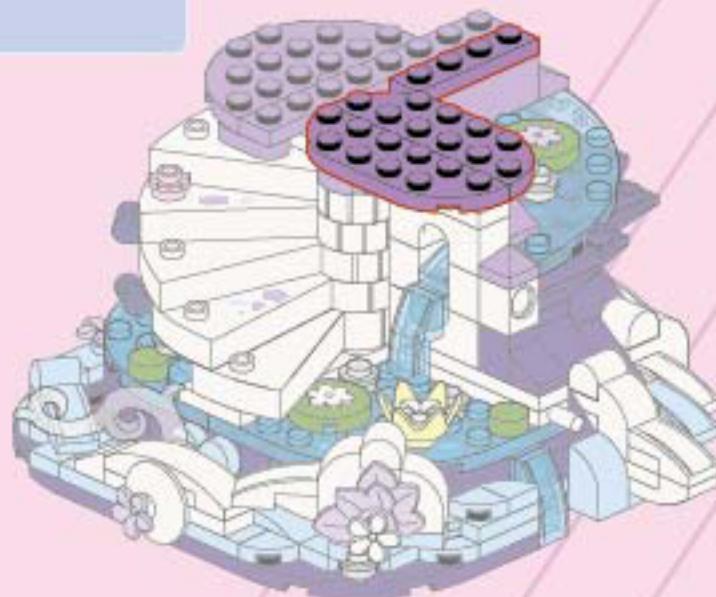

59

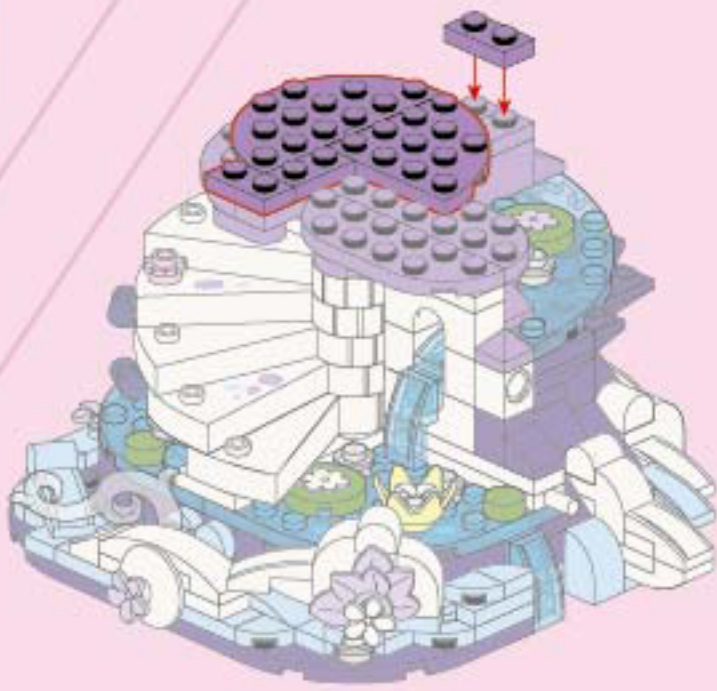

60

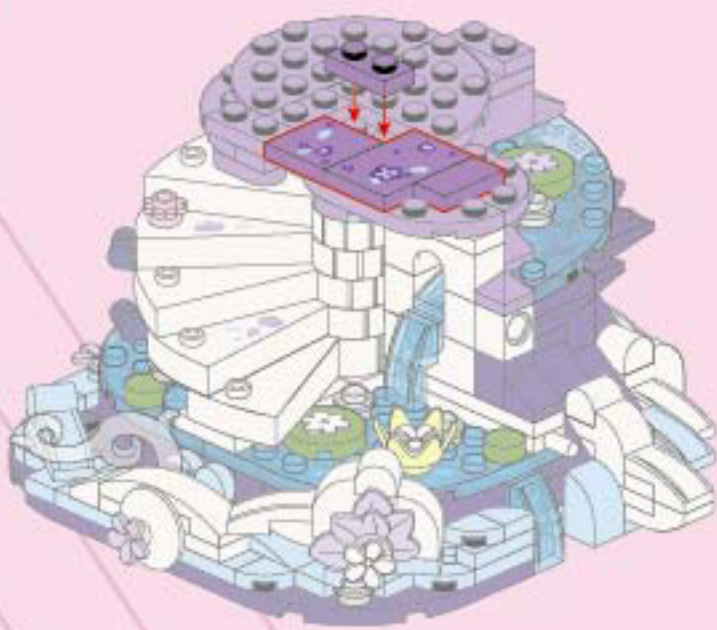
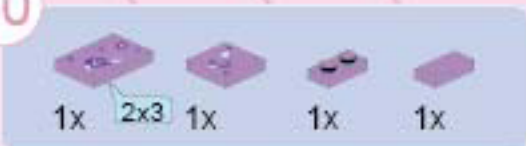

61



1x



3x

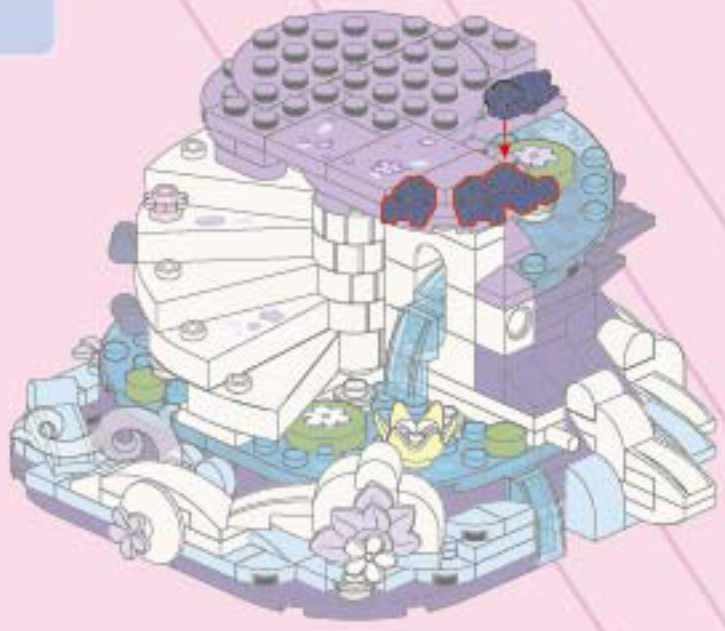

62



1x



1x



1x



2x

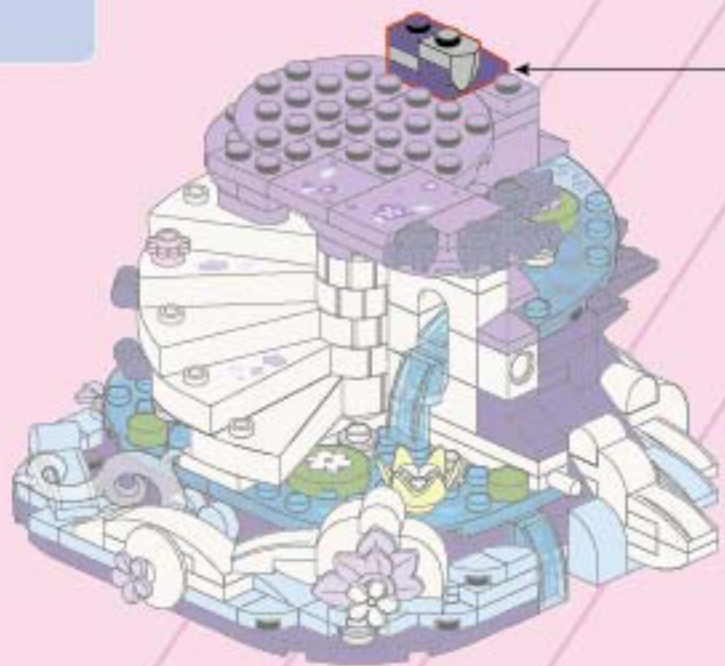

- 1
- 2
- 3

63

1x 1x 1x 1x

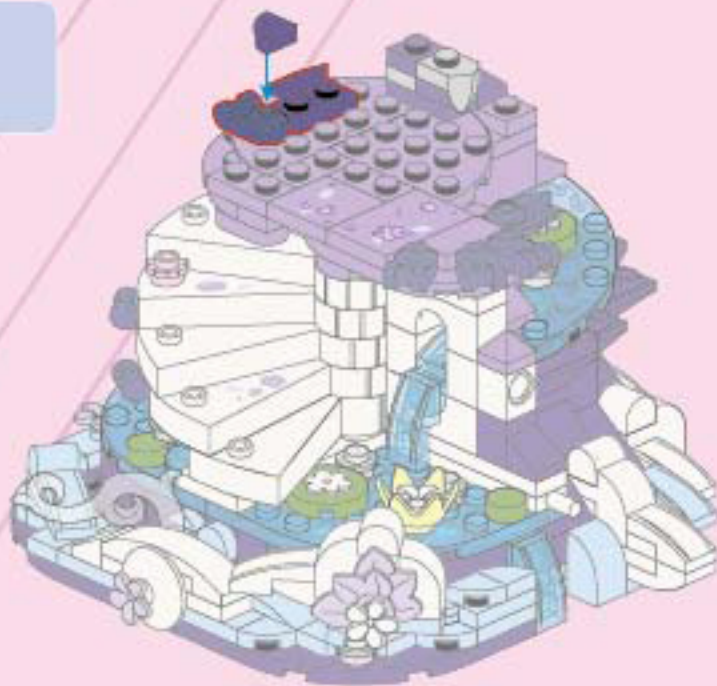

64

1x 1x 4x

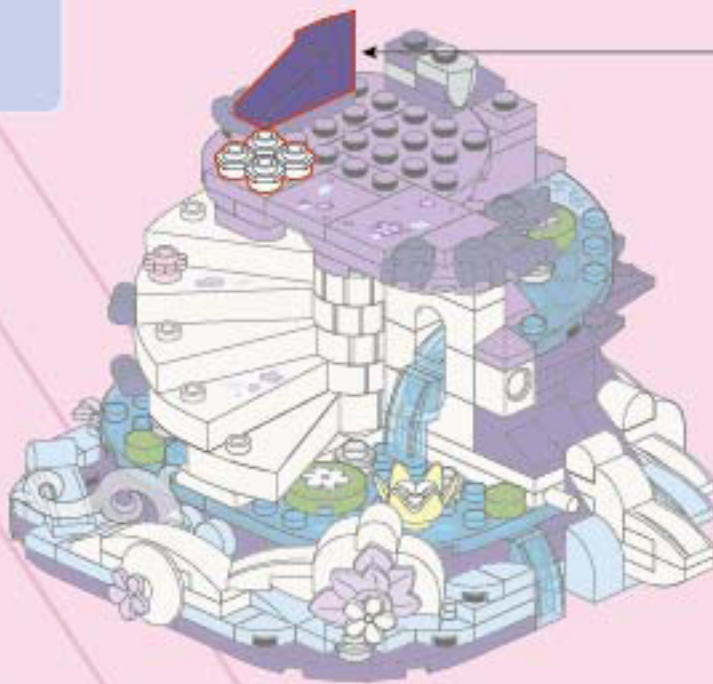
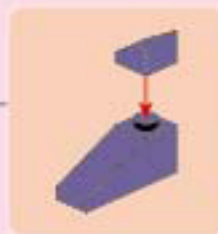

65



1x



1x



1x



2x



1x

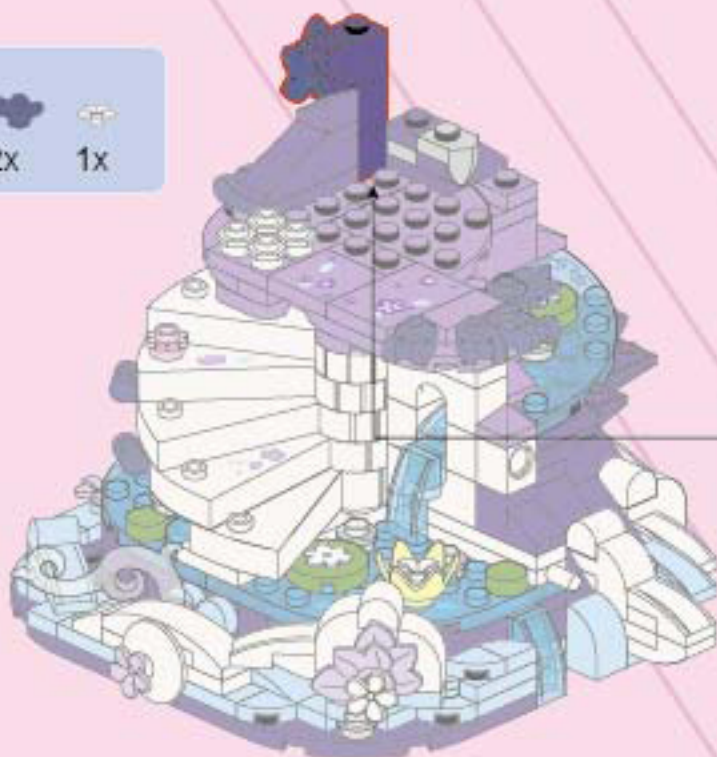

1

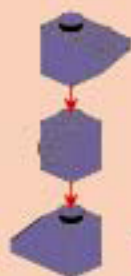

2

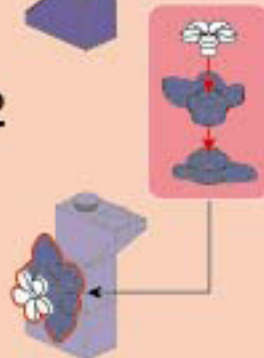

66



1x



1x



1x

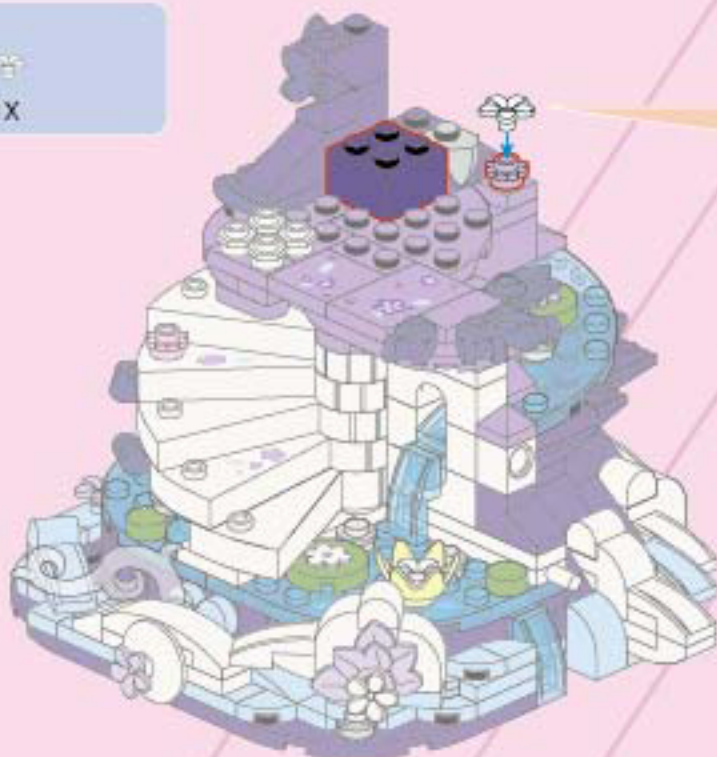

拼装角度：



67

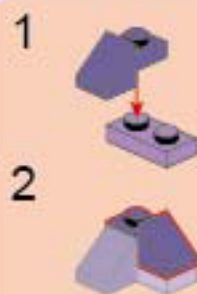
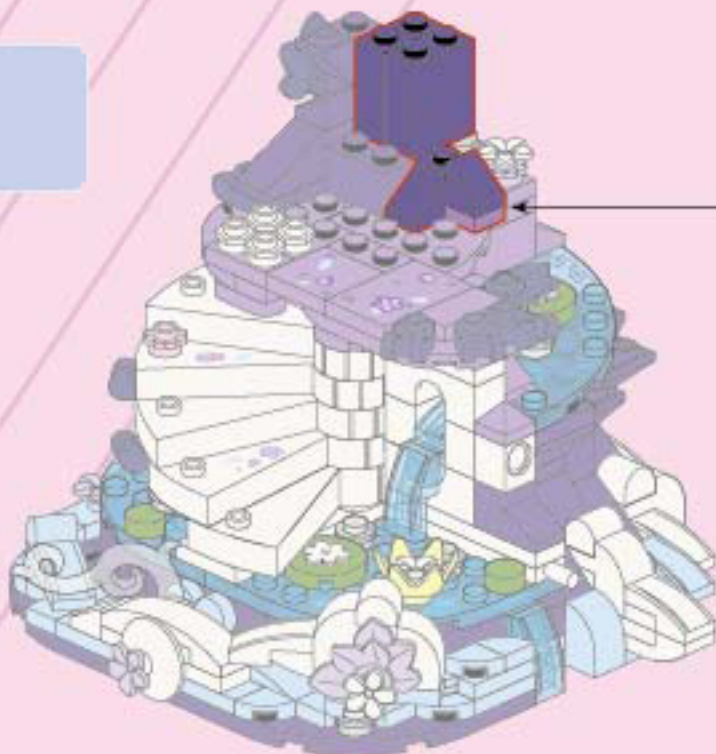

68

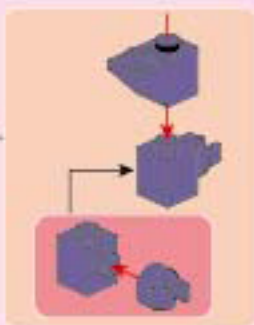
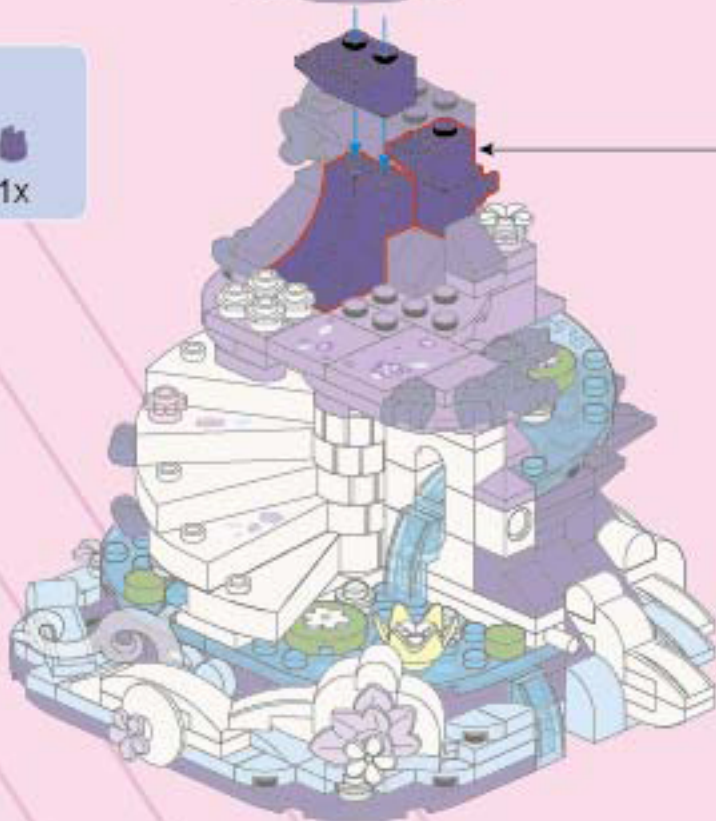
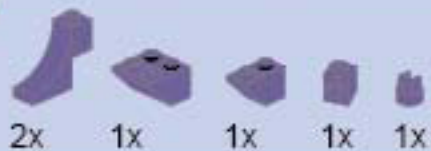





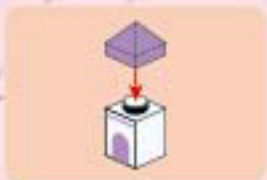
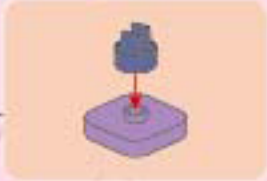
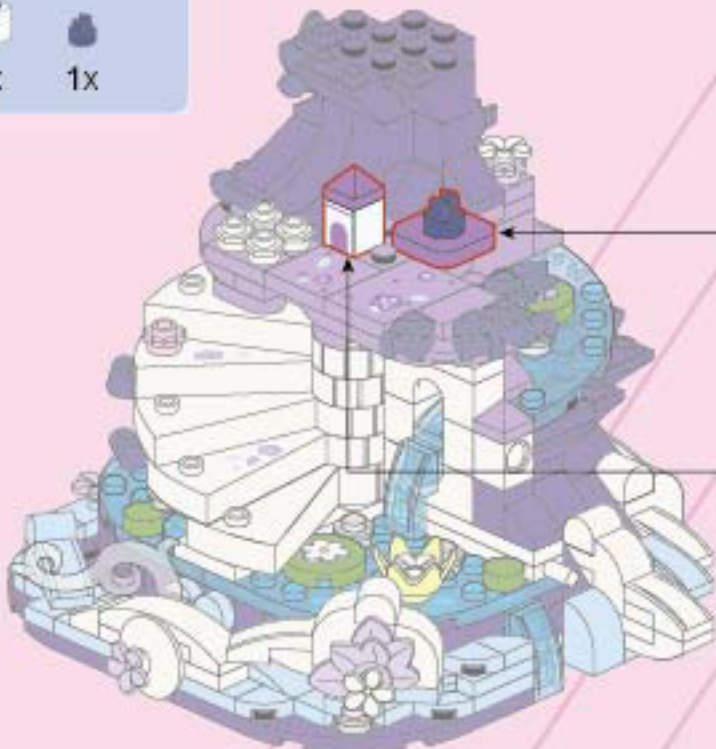
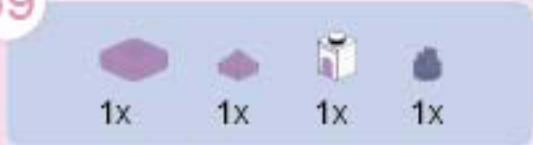

69



70



- 
2x
- 
1x
- 
1x
- 
1x
- 
1x

- 1 

↓
- 2 

↓

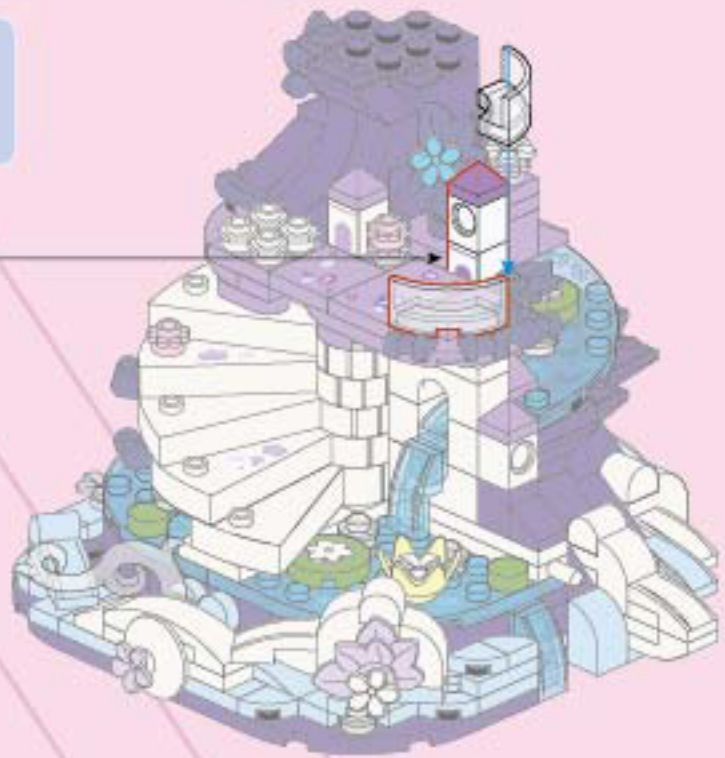

71

- 
2x
- 
1x
- 
1x
- 
1x

- 
↓
- 
↓
- 
↓





72



1x



1x

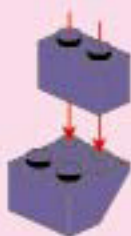

73



1x

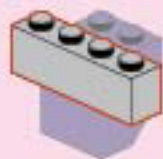

74



2x

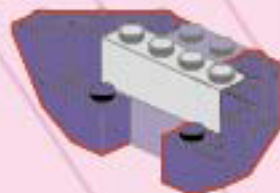

75



1x



1x

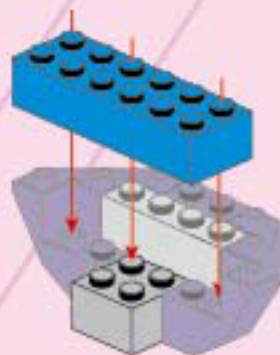

76



1x



1x

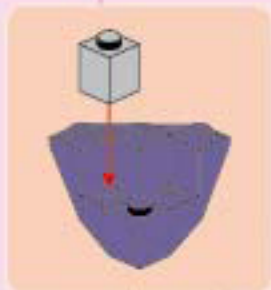

77



1x



1x

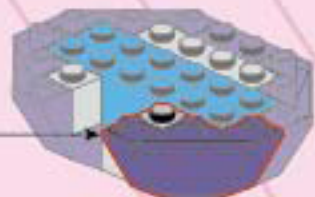
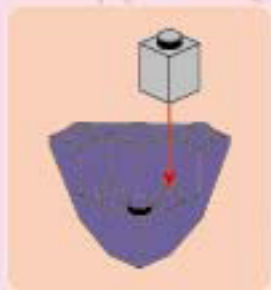

78



1x



1x

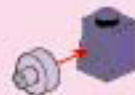

79



1x



1x

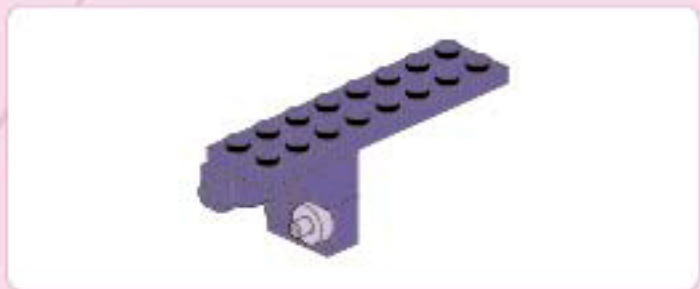
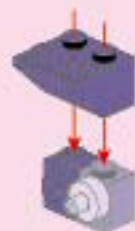

80

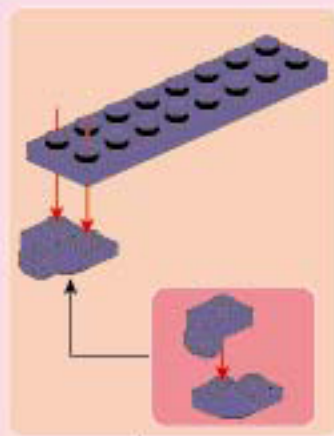
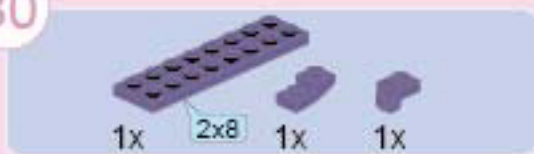

81

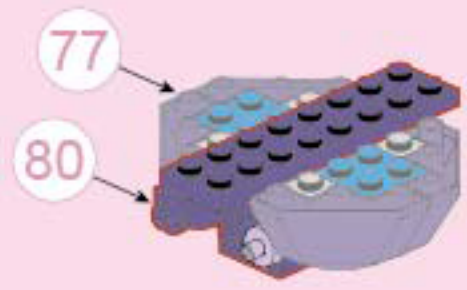

82

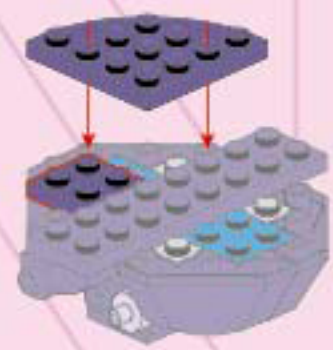

83

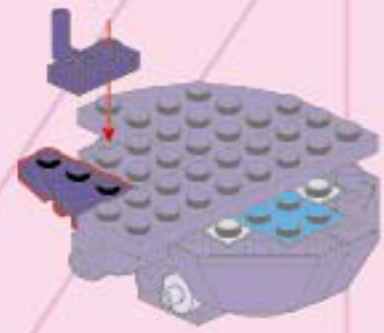

84



1x



1x

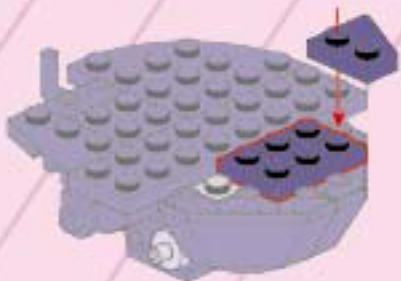

86



1x

2x4



1x

1x3



1x

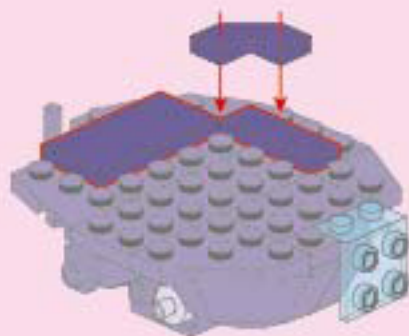

85



1x



1x



1x



87



1x



2x



1x

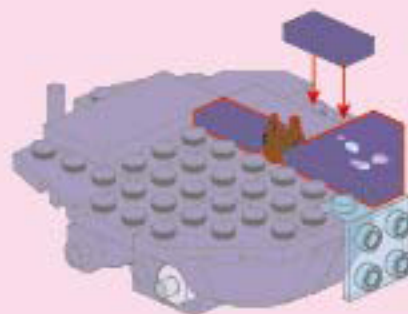

88



89

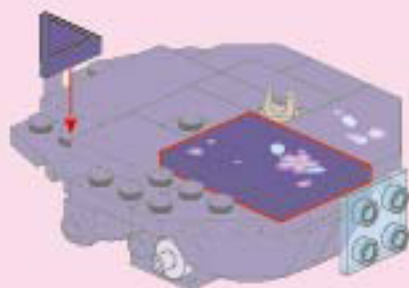

90



91





92



93

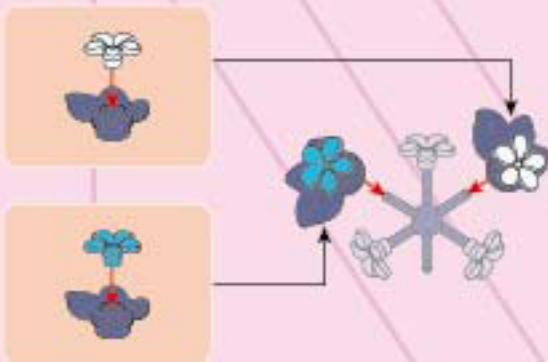

94

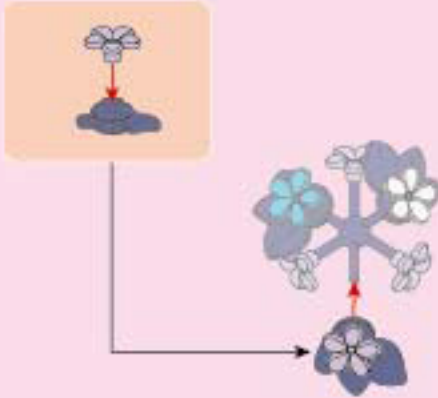
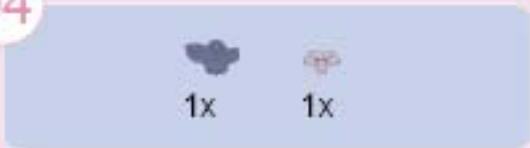

95



96



1x

95

91

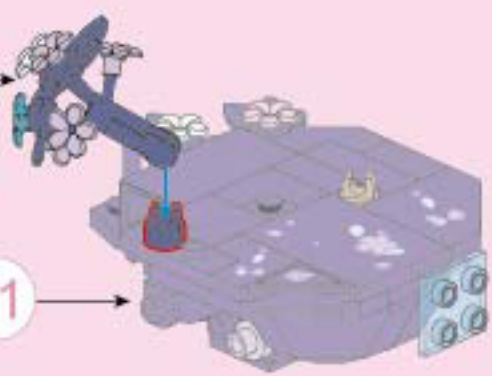

97



1x



1x



98



1x



1x



1x

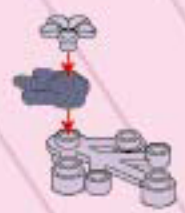

99



1x



1x



100



2x



1x



101

97

100

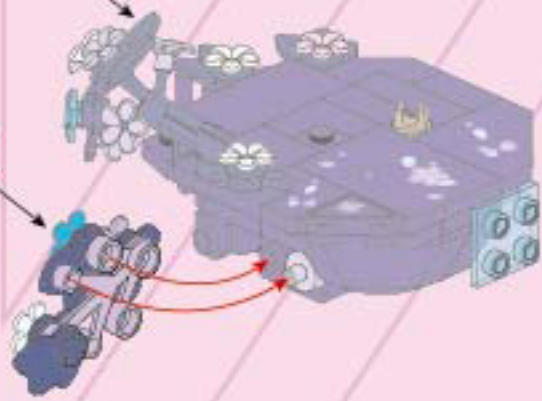

102



103

102

71

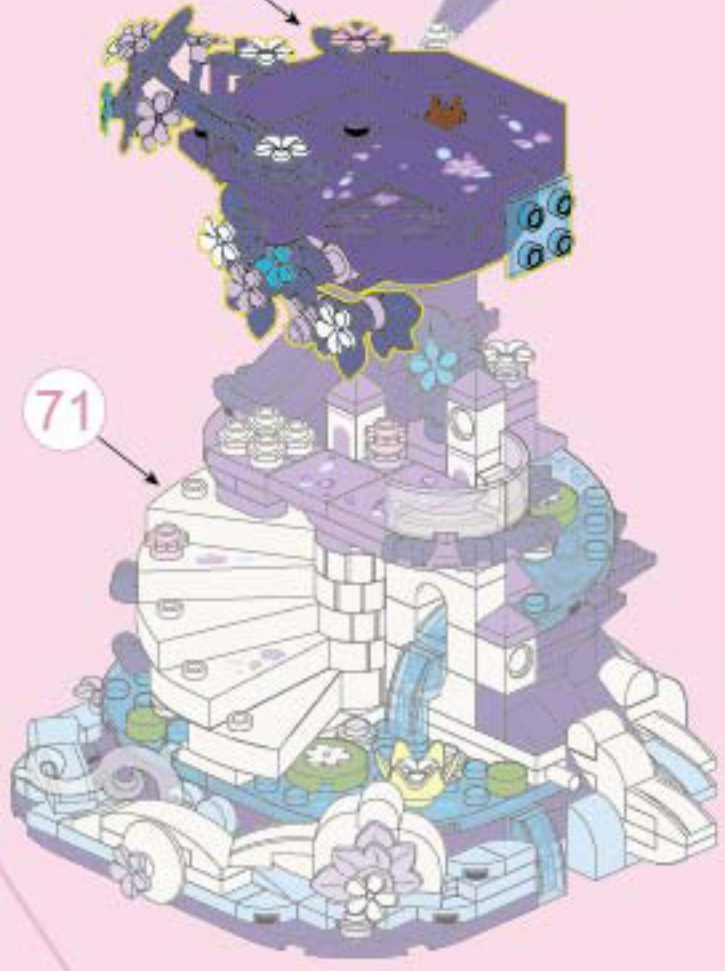
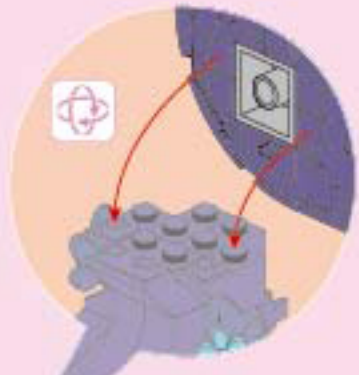

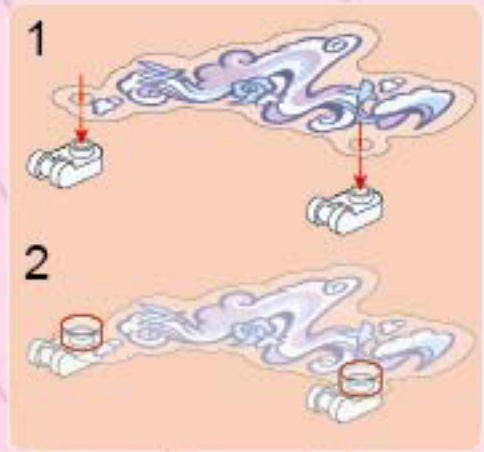

- 1x
- 1x
- 1x
- 1x
- 1x
- 1x

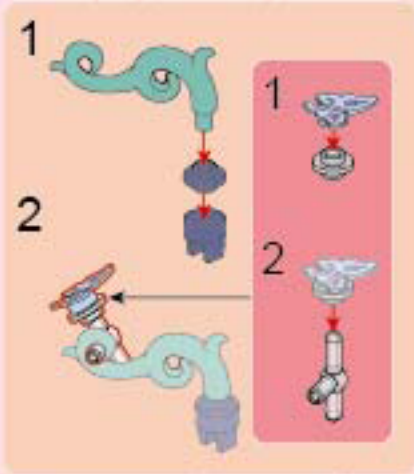



1x



4x



1x

1

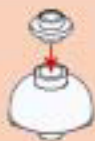

2

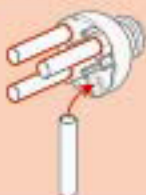



107



1x

1x



108



1x

1x



109



1x

1x

1x



110

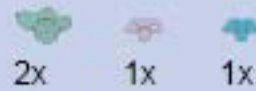

2x

1x

1x

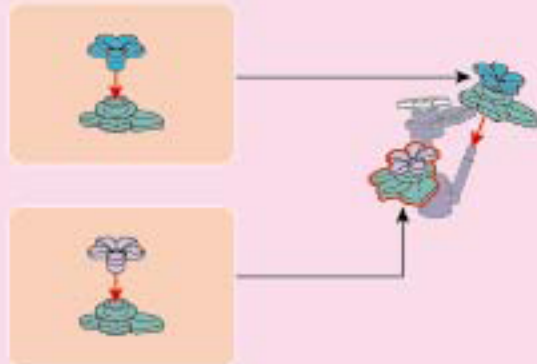

111

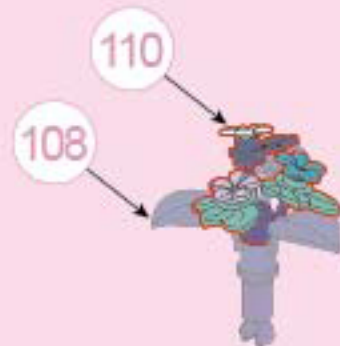



113

				
1x	1x	1x	1x	2x
				
1x	1x	1x	1x	
				
	1x	1x		

- 1 
- 2 
- 3 
- 4 

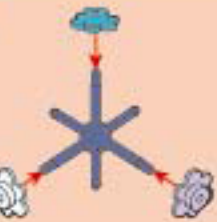
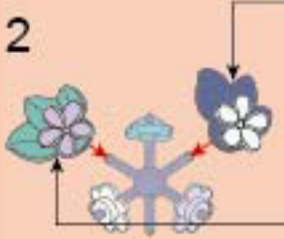
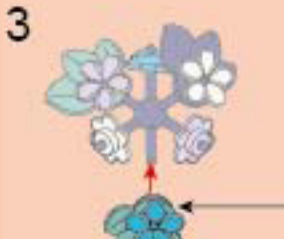
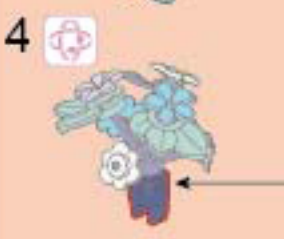



1x



1x



1x

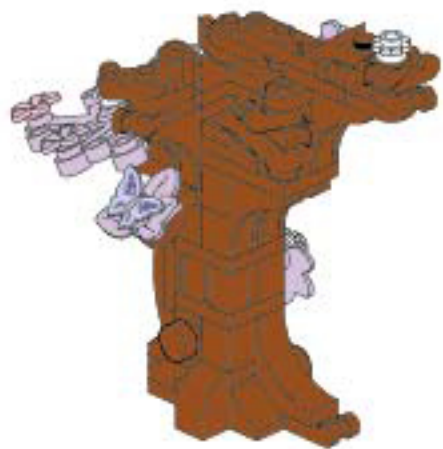

+



114

				
1x	1x	1x	1x	2x
				
1x	1x	1x	1x	
				
	1x	1x		

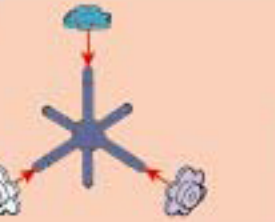
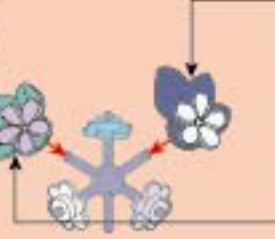
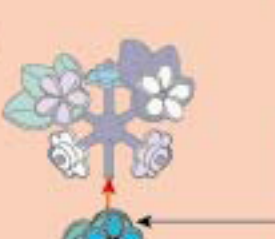





- 1 
- 2 
- 3 
- 4 

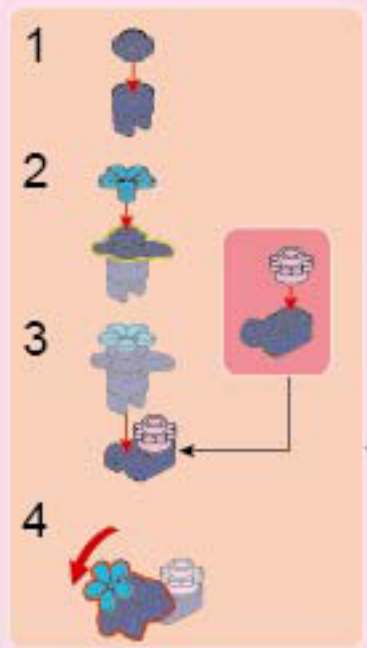

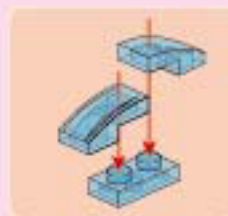
- 1x
- 1x
- 1x
- 1x
- 1x
- 1x





-  2x
-  3x
-  3x
-  1x
-  2x

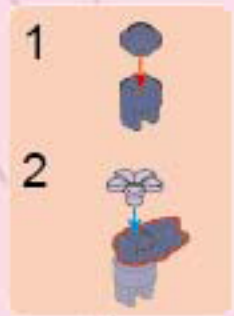
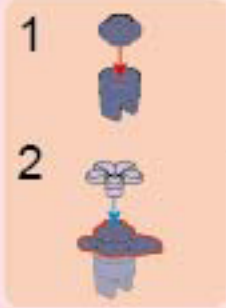
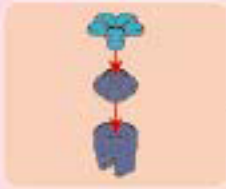



1x



1x



1x



1x



1x



1



2





119



120



121



122



123

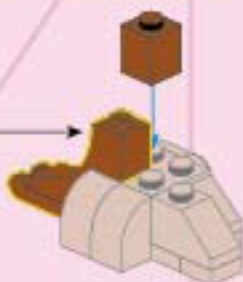

124



1:1



125



1:1



126



127

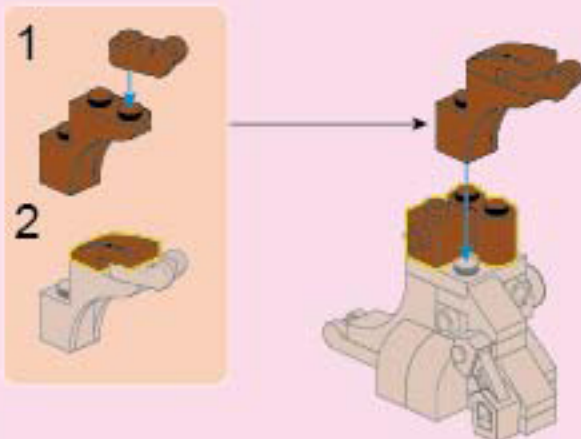



128

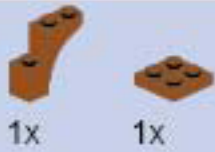

1x

1x



129



1x

1x

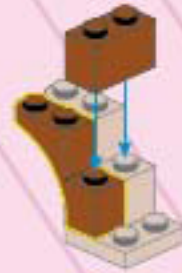

130



1x

1x

1x

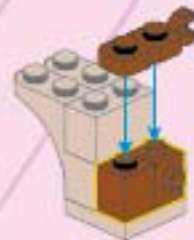

131



1x



1x



1x

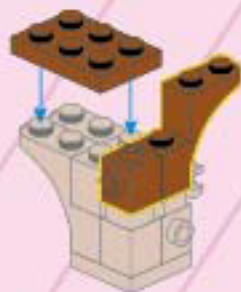

132



1x



1x



1x



133



1x



1x



1x

②



②

1:1

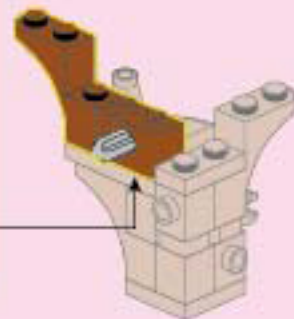

134



1x



1x

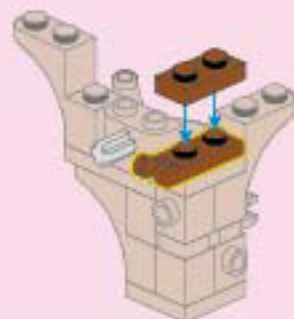

135

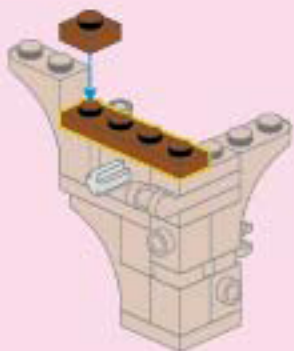

136

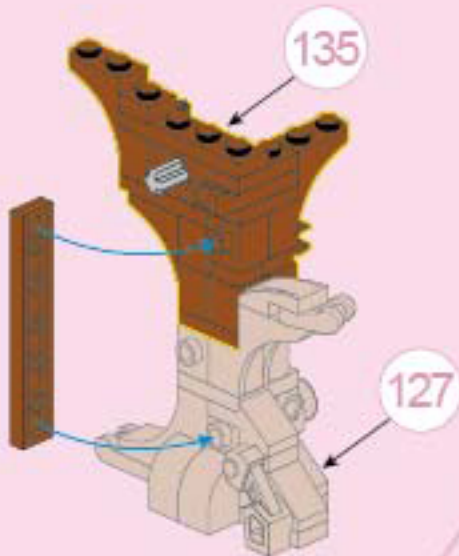
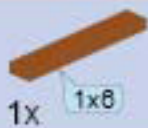

137

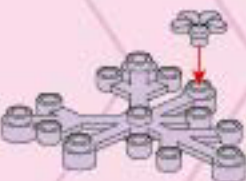

138

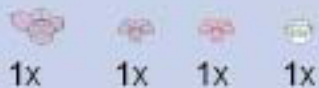

139



1x

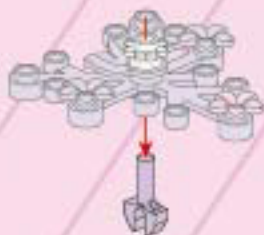

140

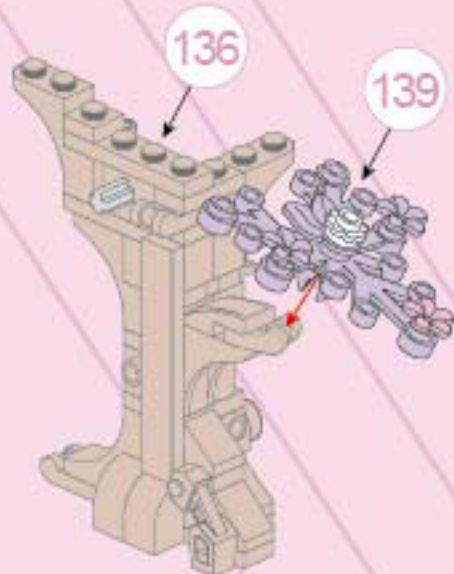

141



1x



2x



1x



1x



1x



1x

1

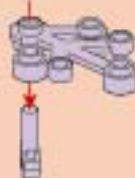

2

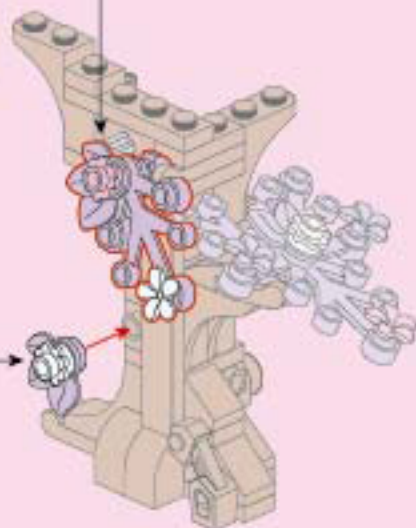

142



1x

1x

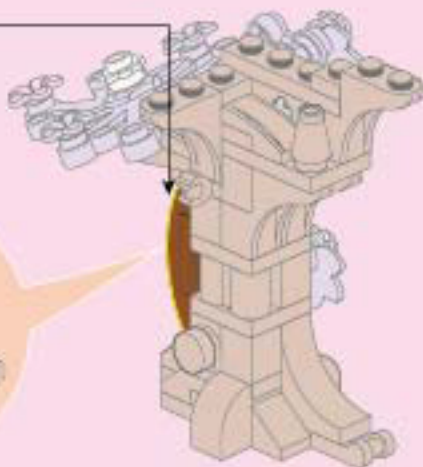

143

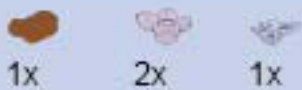

1x

2x

1x



1

2

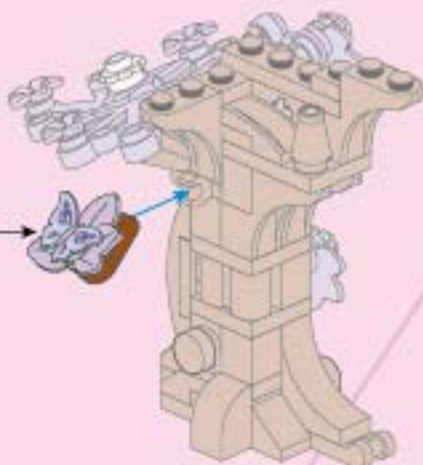

144



1x

1x

1x

1x

1x

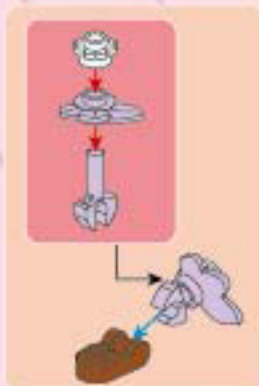

145



2x



2x

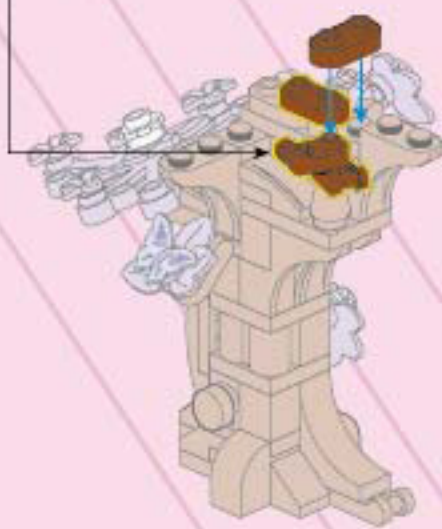

146



1x



1x



1x



1x



147



148



149



150



151

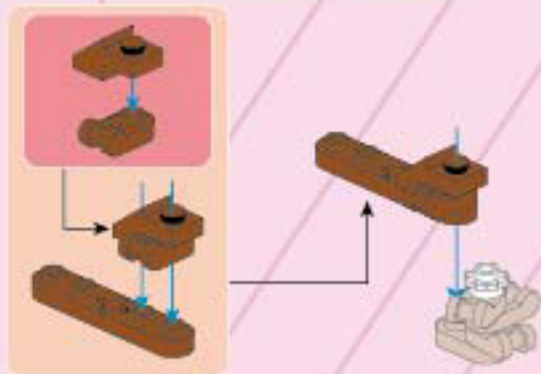

152

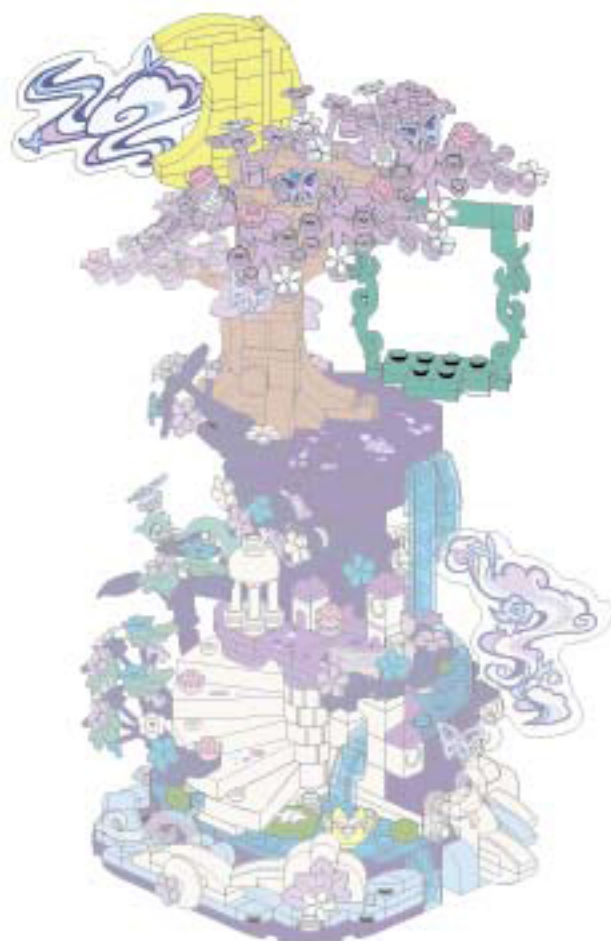
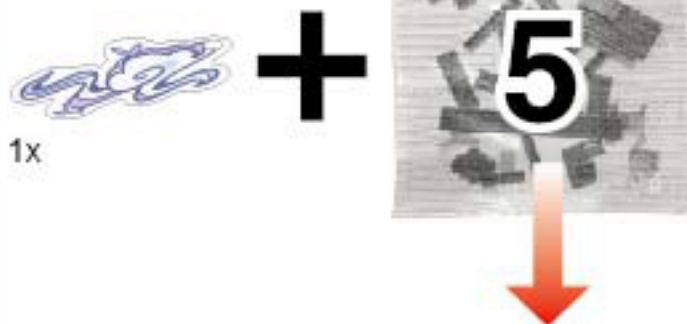
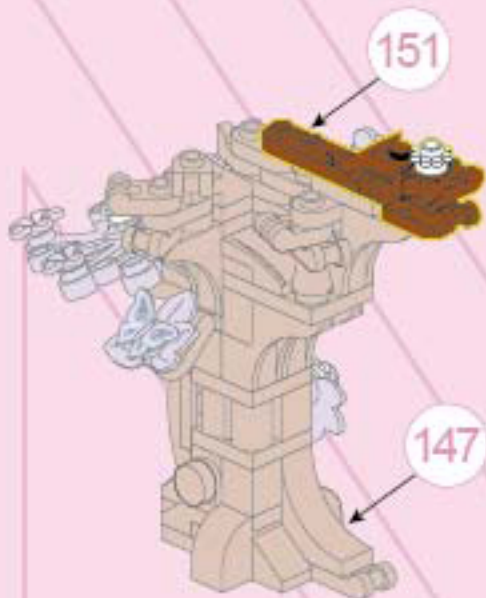



153

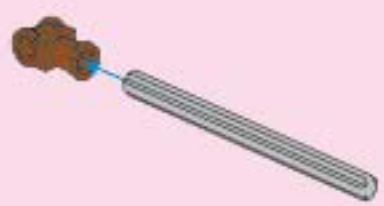

154

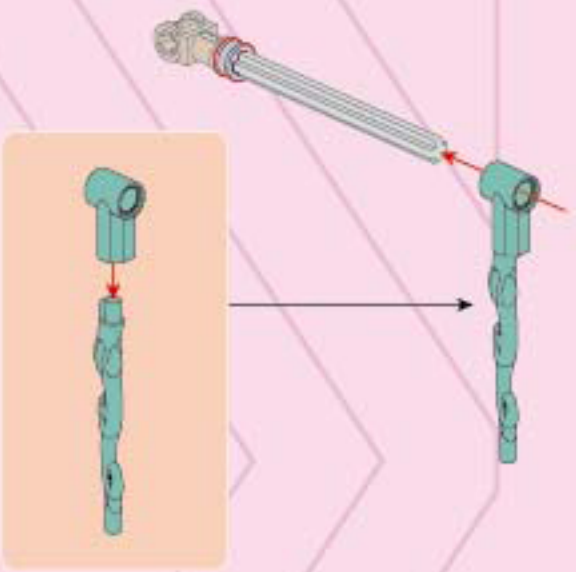

155

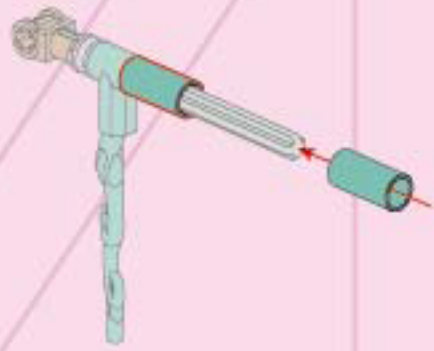

156

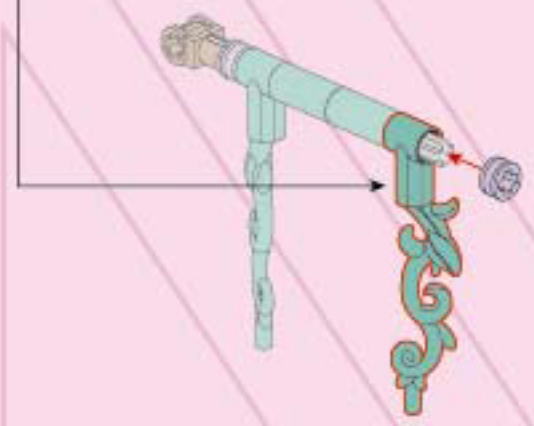
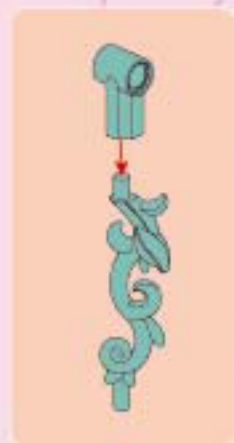

157

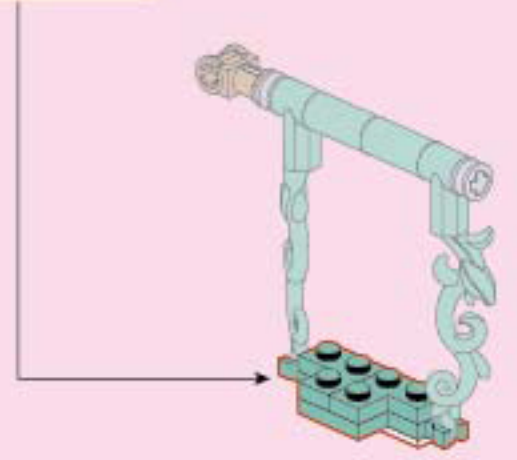
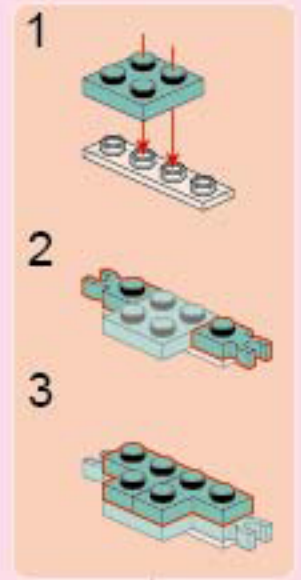

158

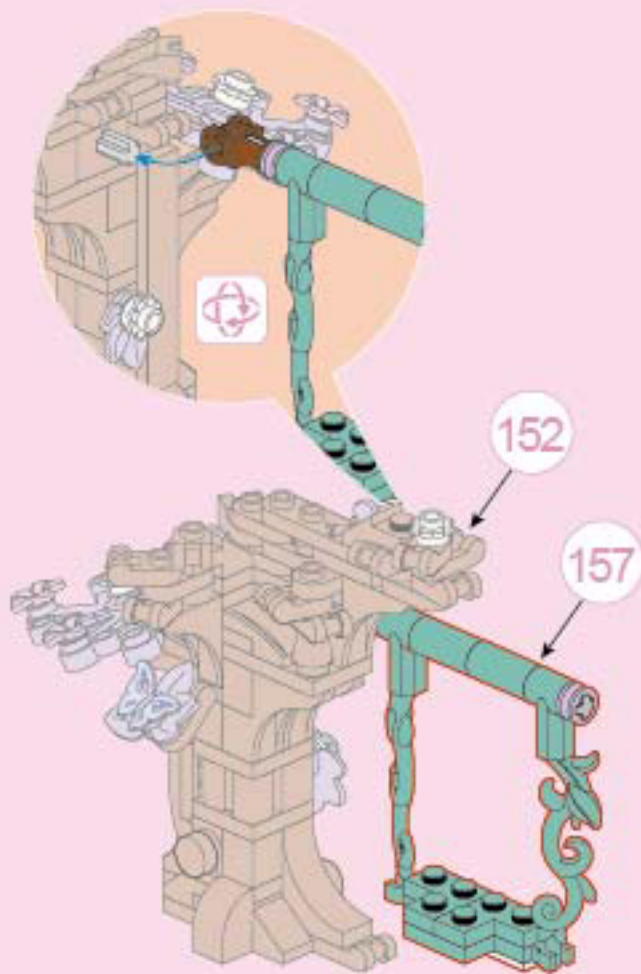

159



1x



1x



160



1x



1x



161



1x

1x

2x

**1:1**

1



2



162



1x

1x

1x

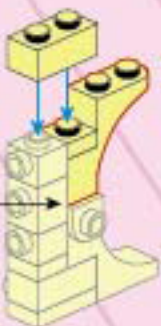
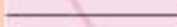
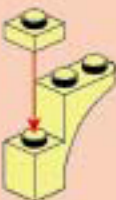
**1:1**

163



1x

2x

2x

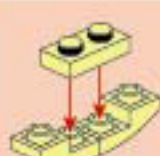

164



1x

1x

2x

1x

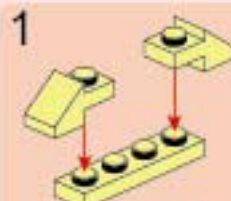
**1:1**

2

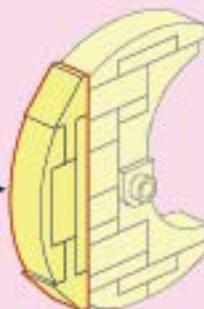

165



1x



1x



166



165

158

167

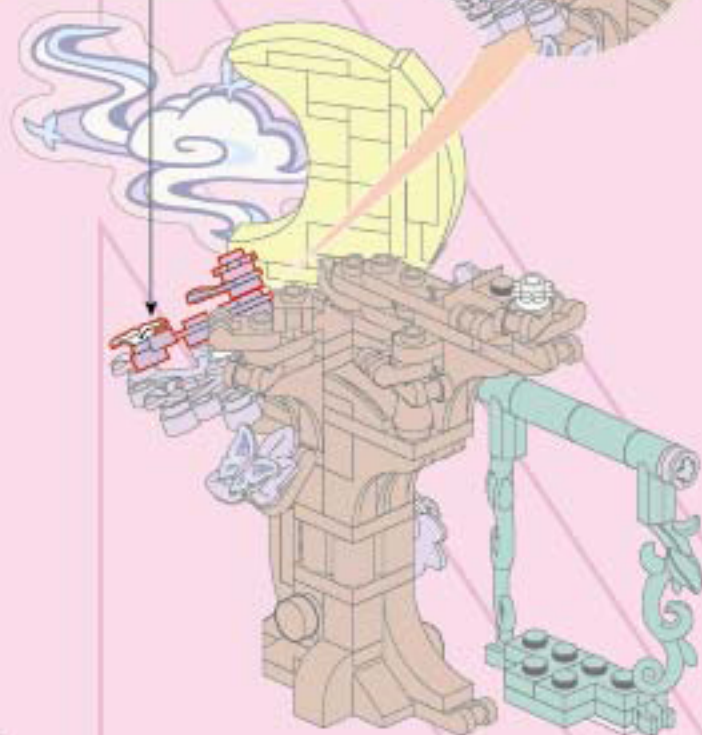
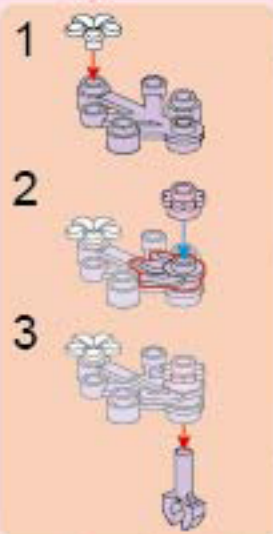

168

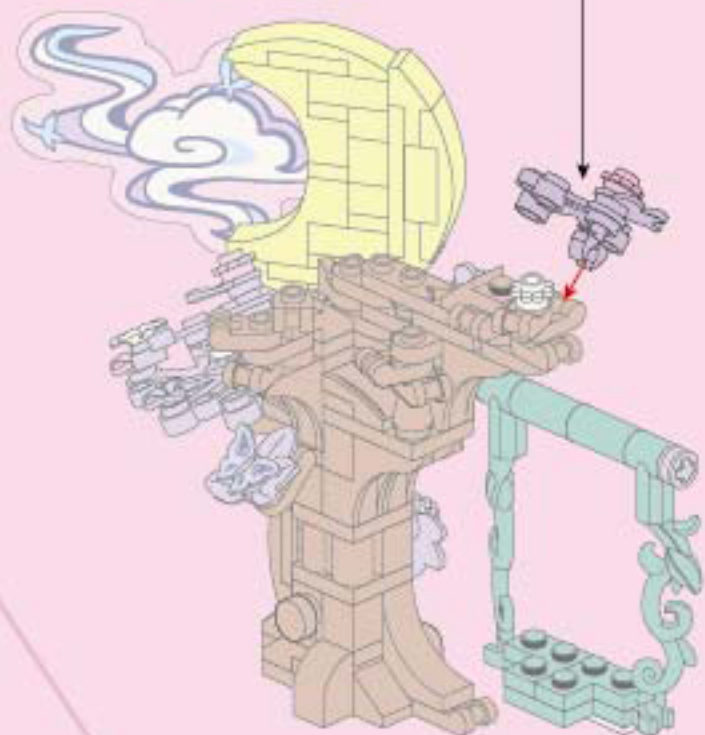
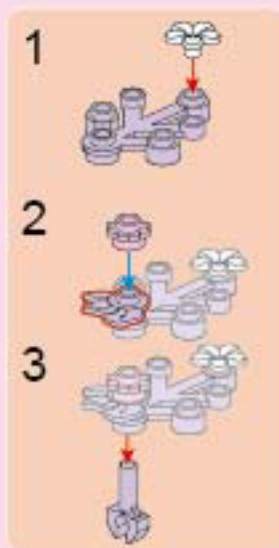
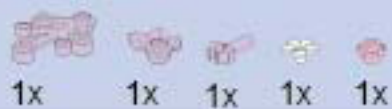

169



3x



3x



6x



3x

1



2



3x



170



1x







1x

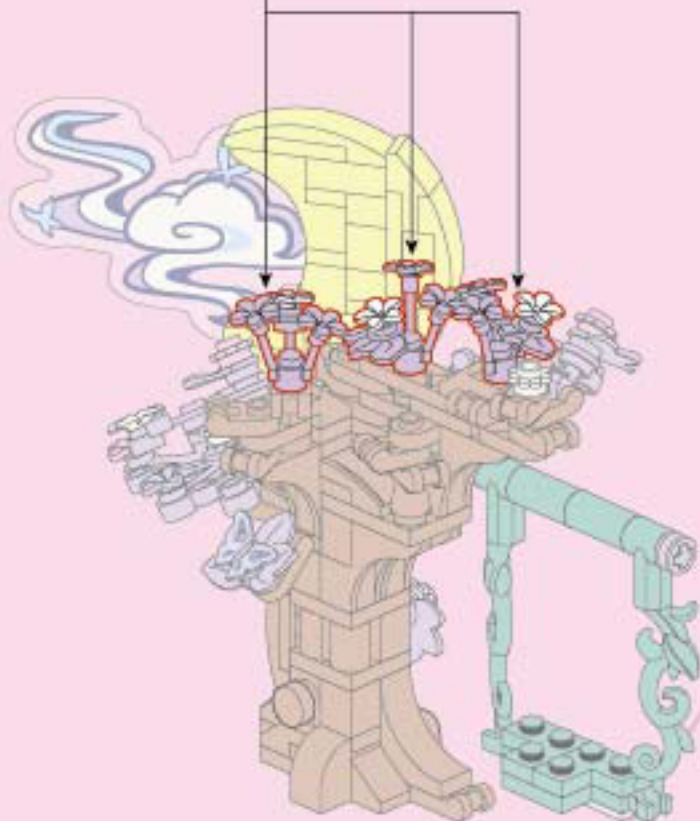



1x

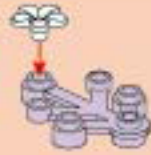
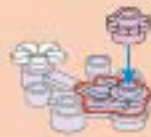

171

- 
2x
- 
2x
- 
2x
- 
2x
- 
2x

- 1 
- 2 
- 3 

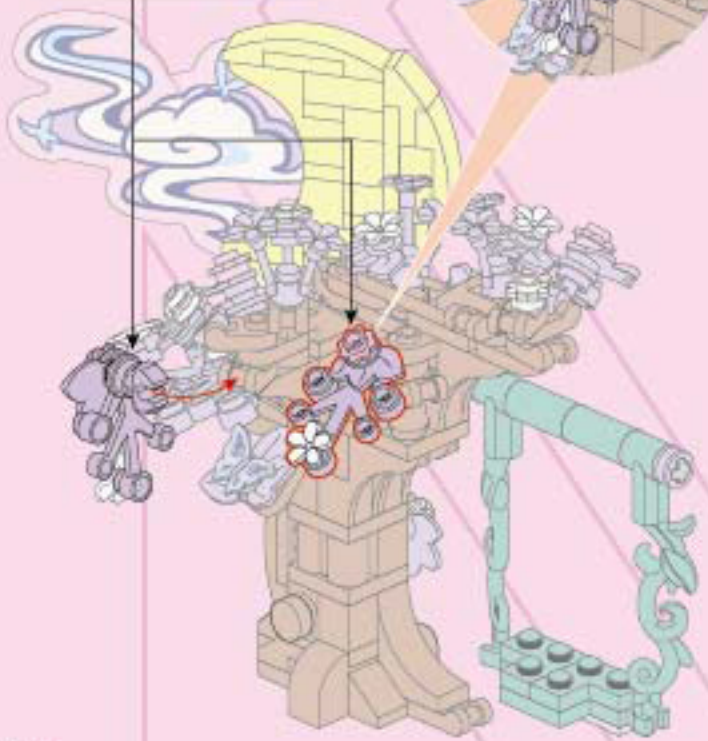

172

- 
1x
- 
1x
- 
1x
- 
1x
- 
1x

- 1 
- 2 
- 3 

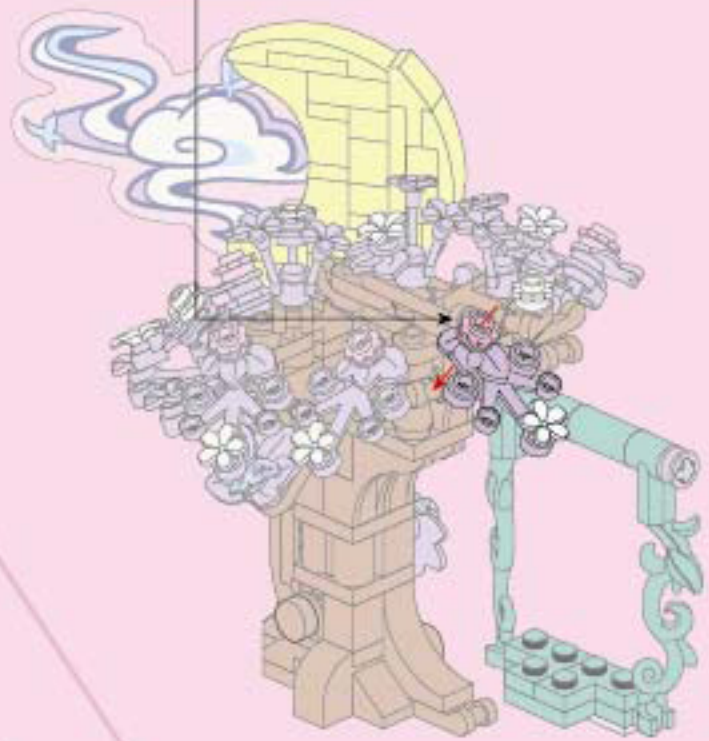

173



1x



1x



1x

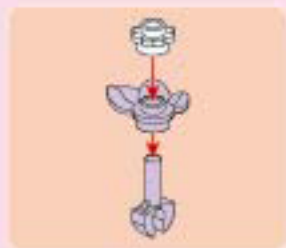

174



1x



1x



1x



1x



1x

1



2



3

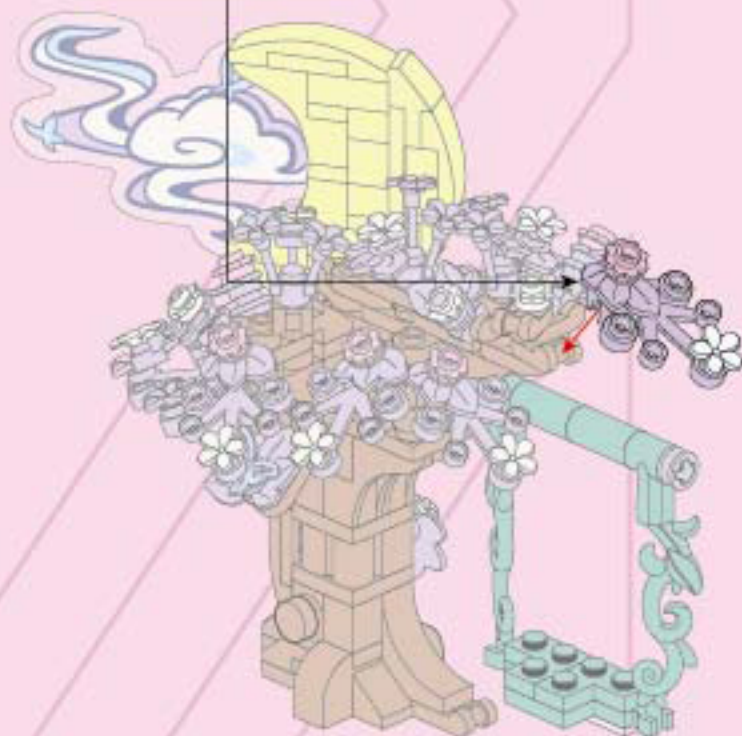
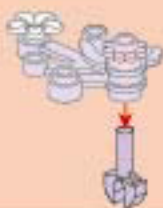

175

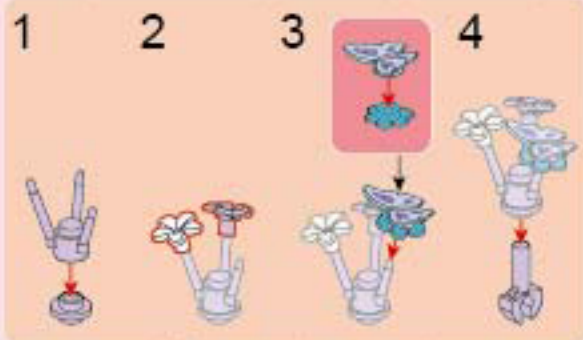
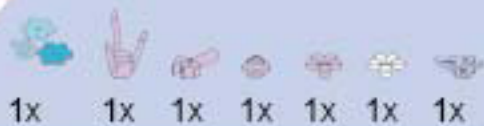

176

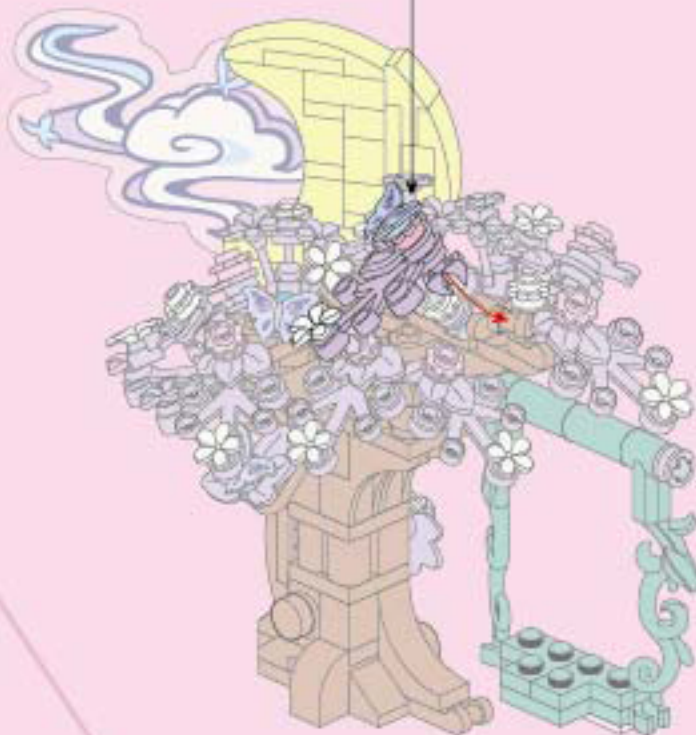
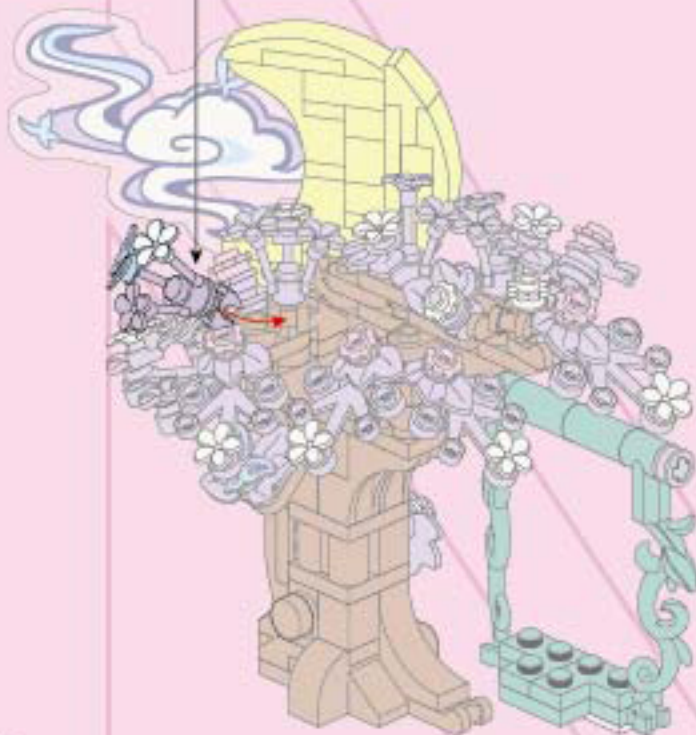
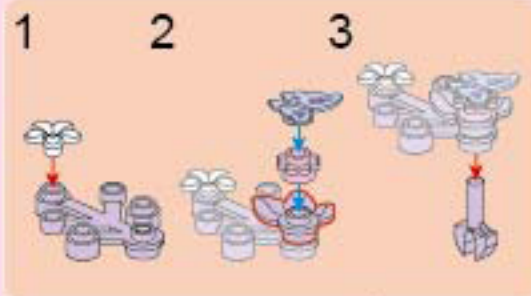

177

176

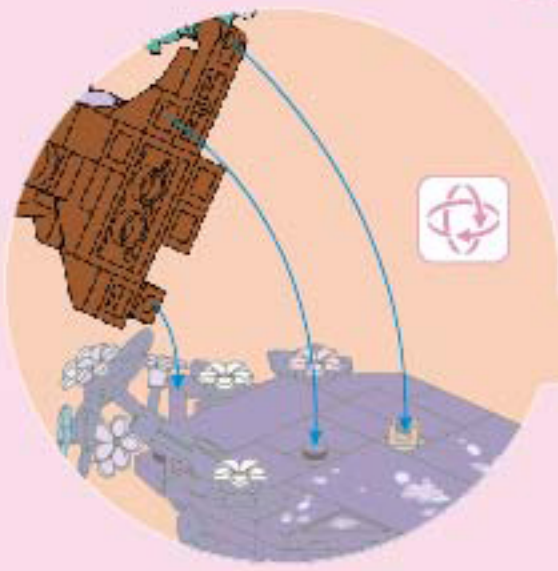

118



