

Disney  
**ZOOtopia**  
迪士尼疯狂动物城



160Q123S008

露露精品店  
Fashions by Fru Fru

图片仅供参考, 请以实物为准。

Reference only, please refer to the actual product.

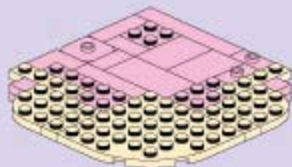

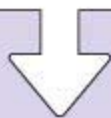
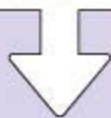

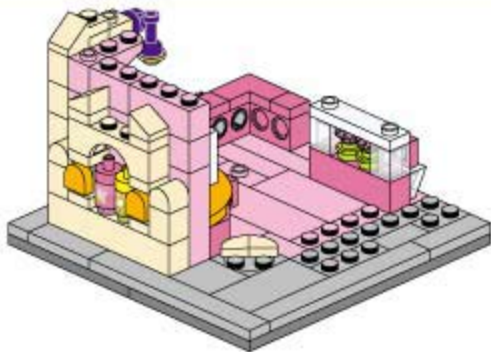

积木拆件器使用方法, 仅供参考。  
Brick separator instruction, for reference only.

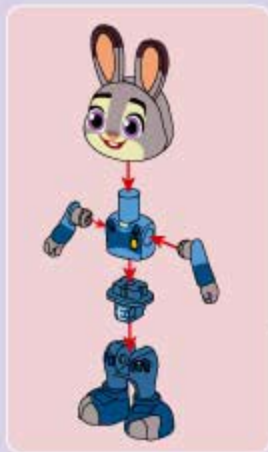

1

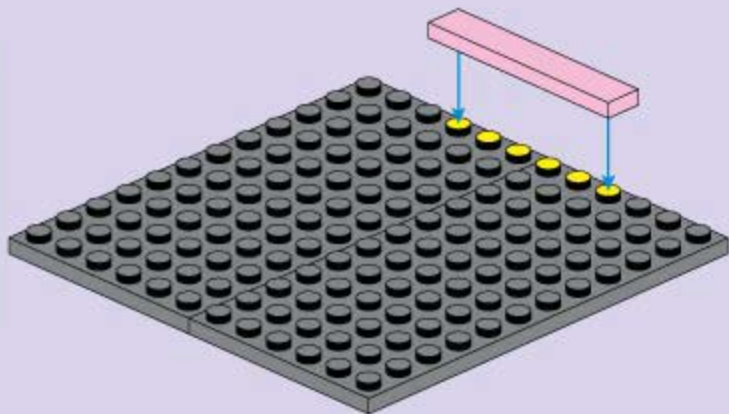
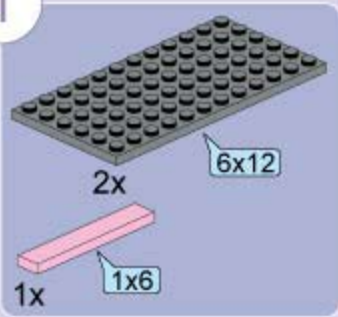

2

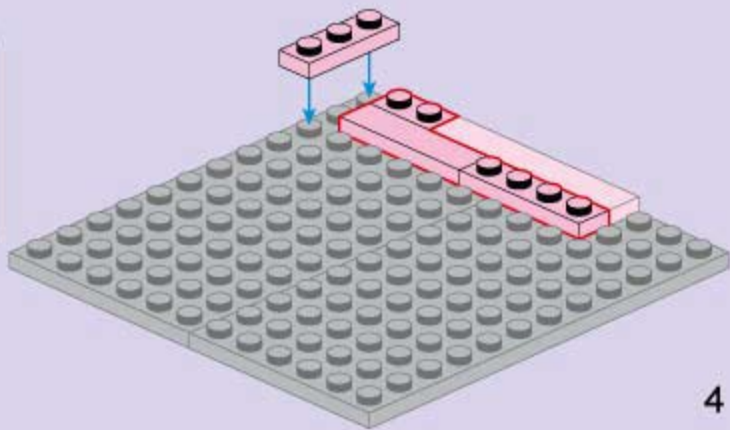
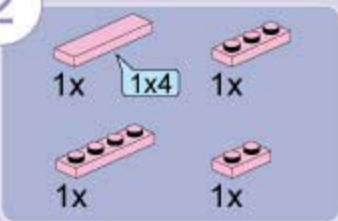

3

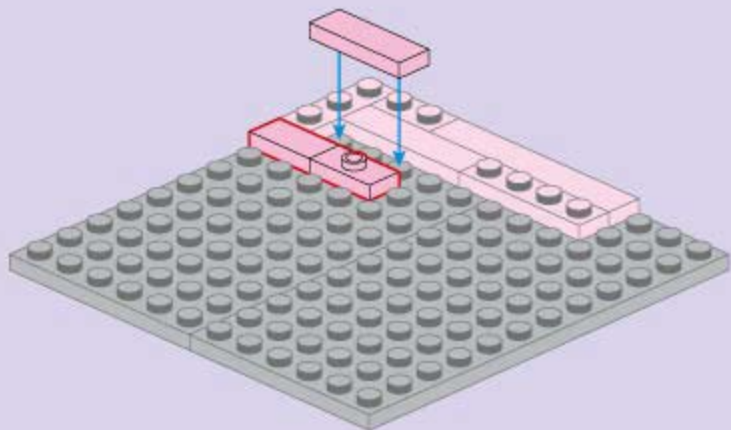

4

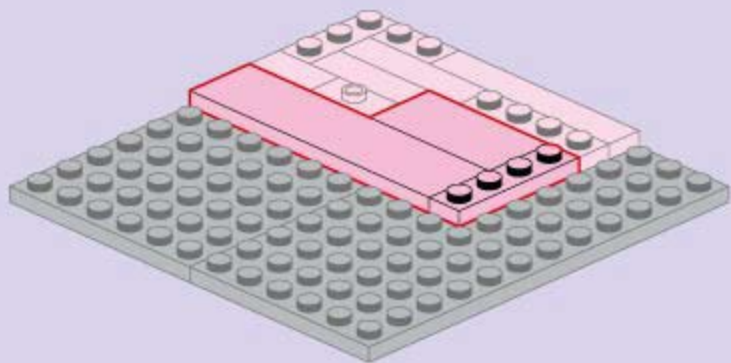
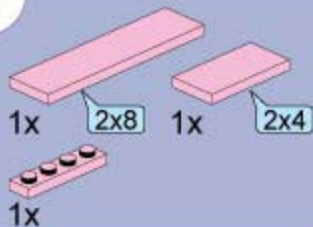

5

5

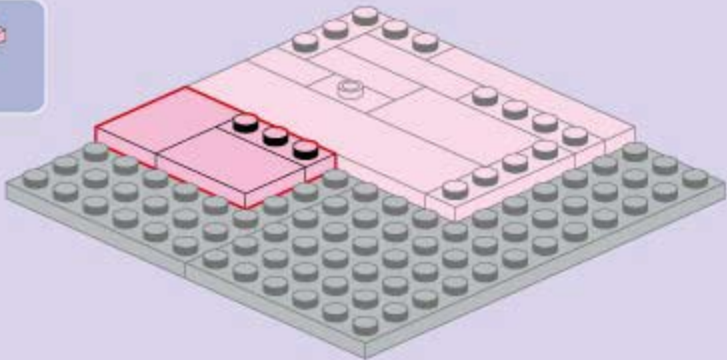

6

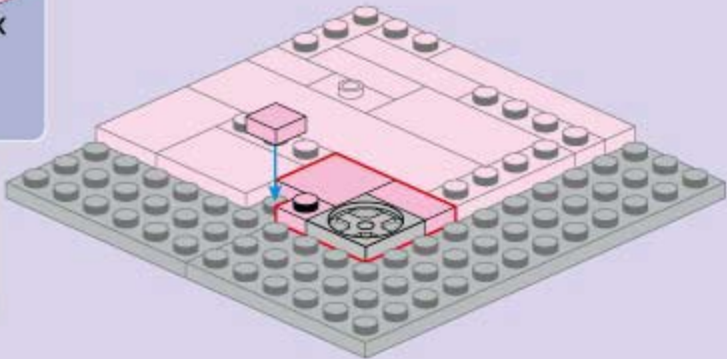
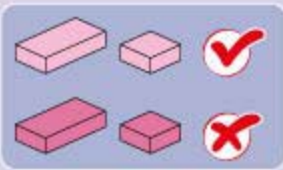
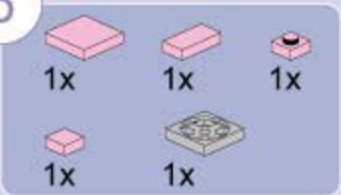

7

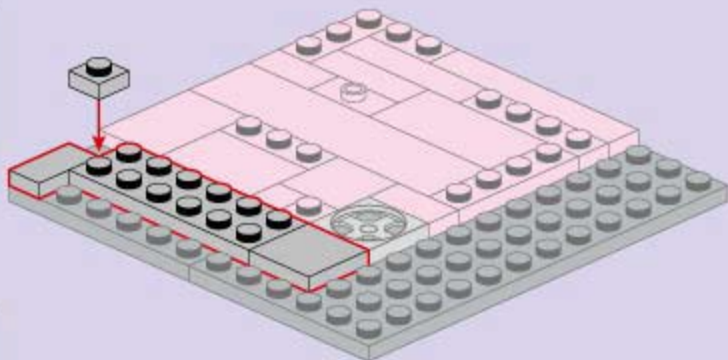
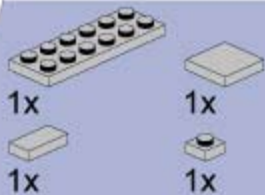

8

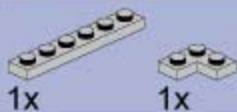

注意：需将此组件拆开，然后在相对应的序号步骤处拼装。

Caution: This set piece needs to be separated, and assembled at respective sequence number.



这块用于第8步  
This task is for pack 8

这块用于第117步  
This task is for pack 117

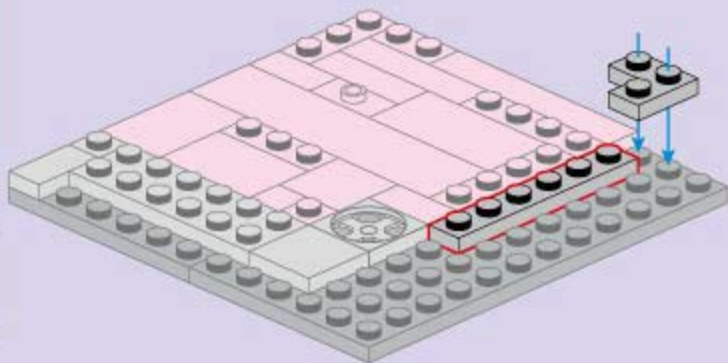
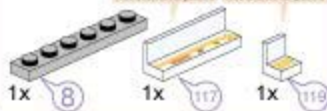

7



9

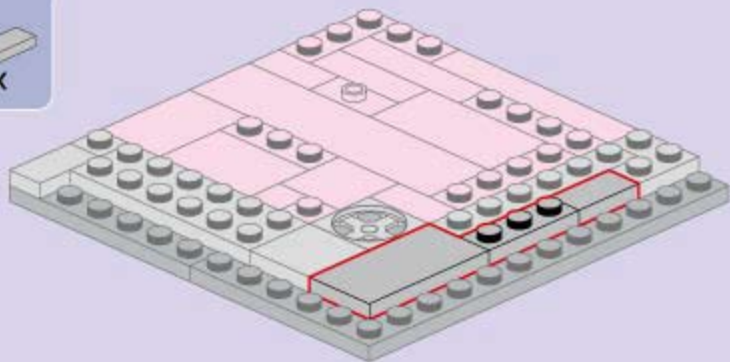
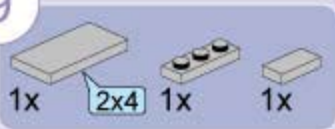

10

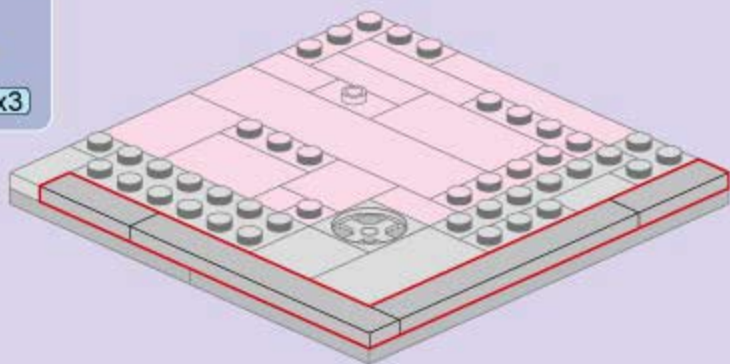
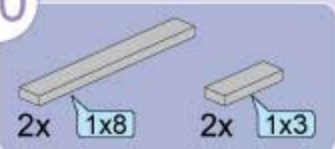

11



2x



1x



2x

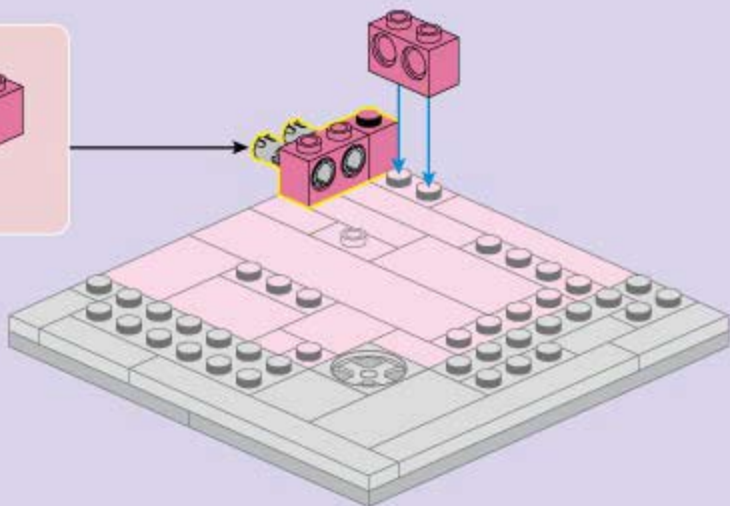
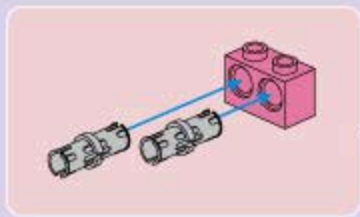

12



1x



2x

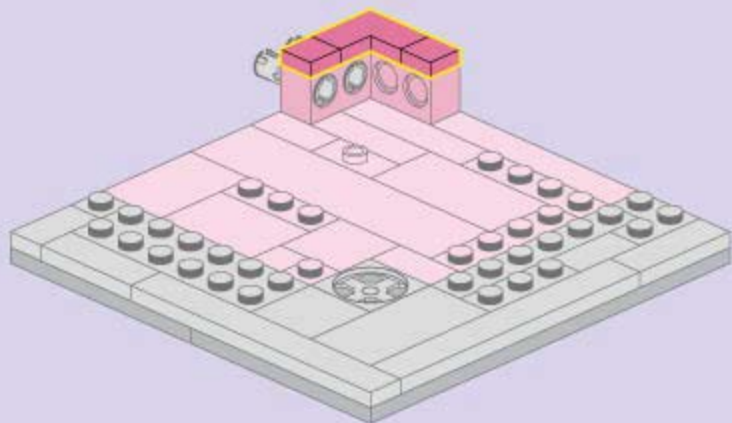



13

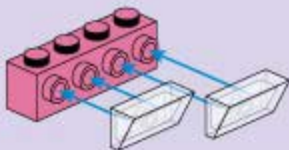

14

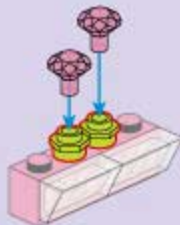

15

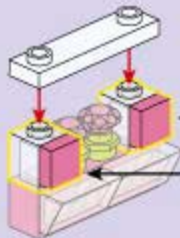
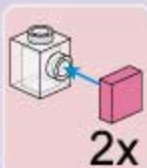

16

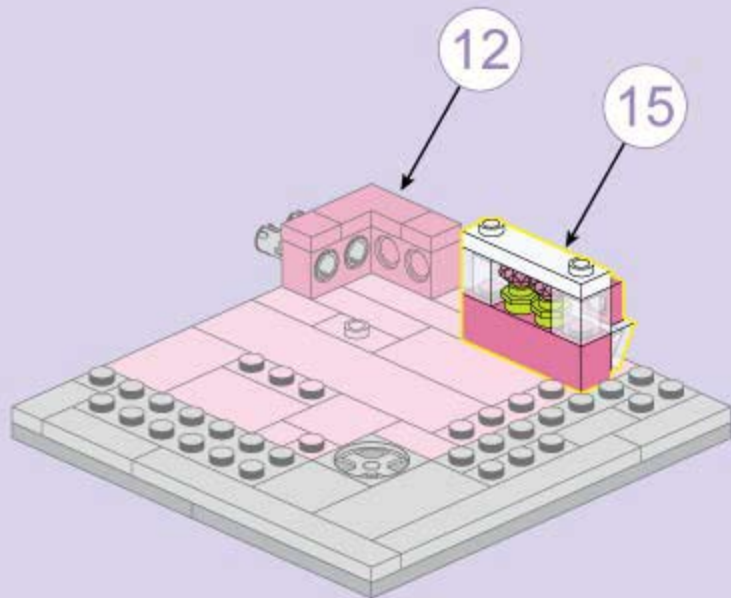



17



1x



1x



1x

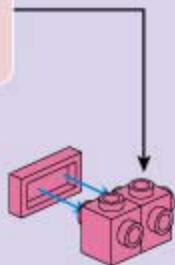

13

18



1x



1x



1x

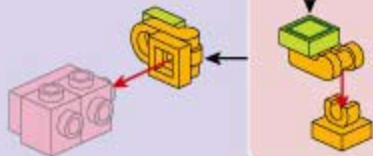

19



1x

1x3





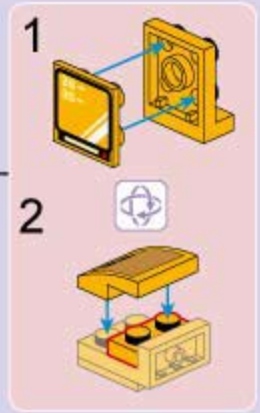
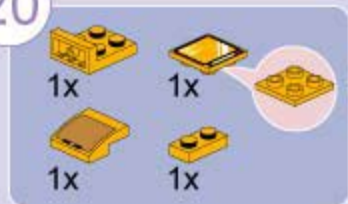

20

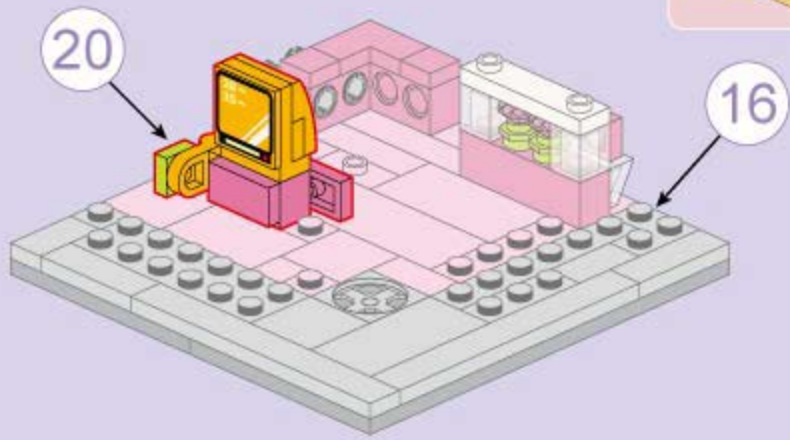

21



22

	
1x	1x
	
1x	2x

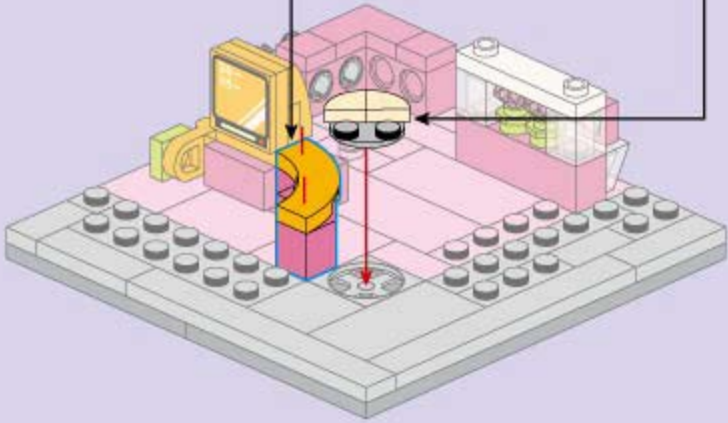
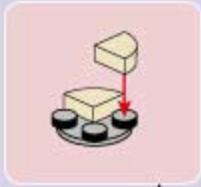
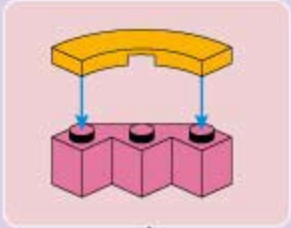



23



3x



1x

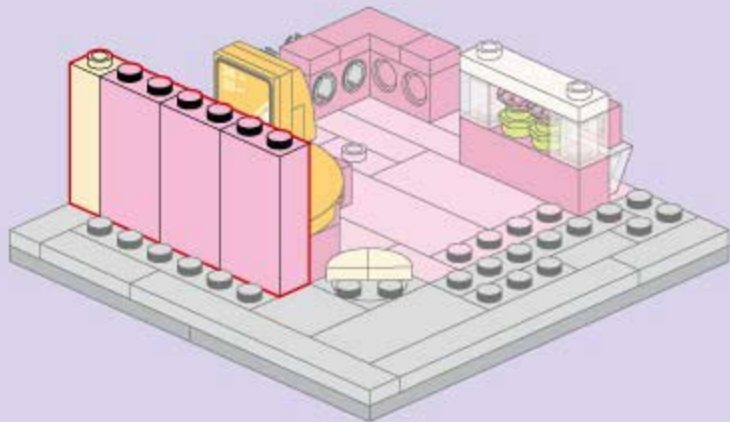



24

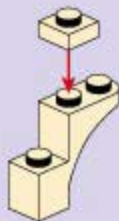
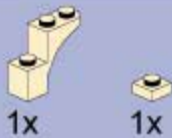

25



26

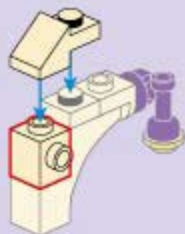

27



1x



1x

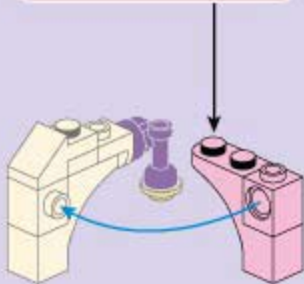
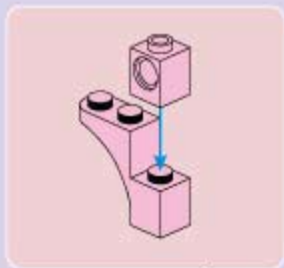

28

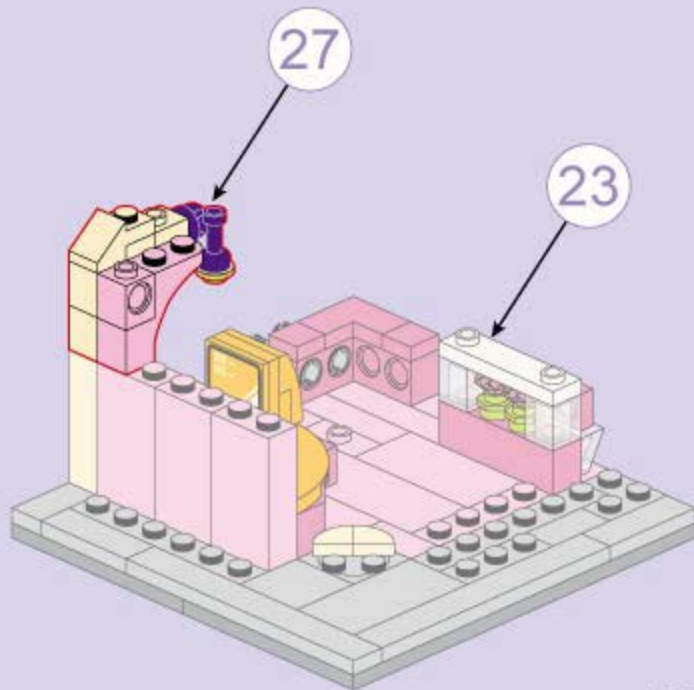



29

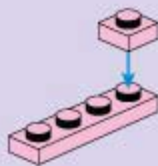

19

30

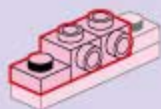

31



32

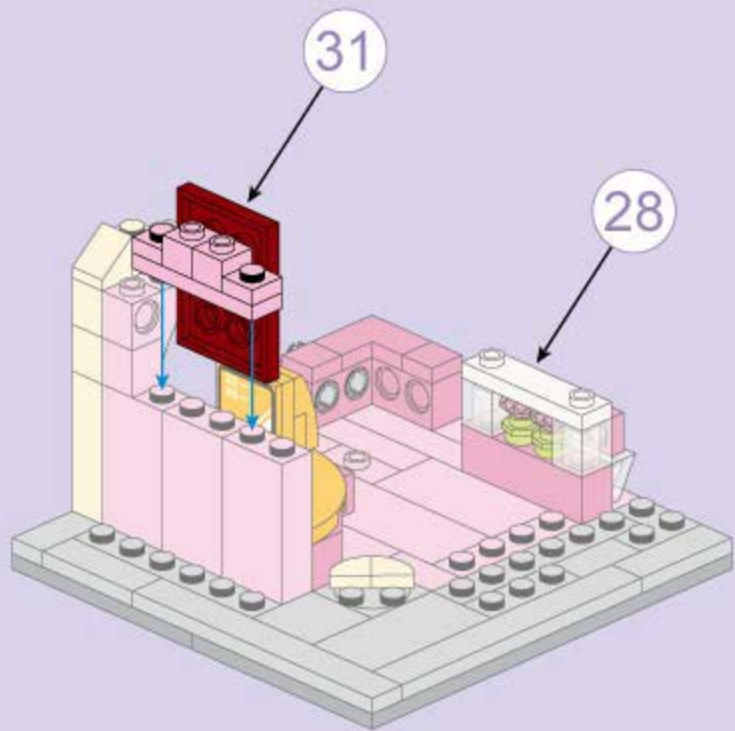

33



1x



1x

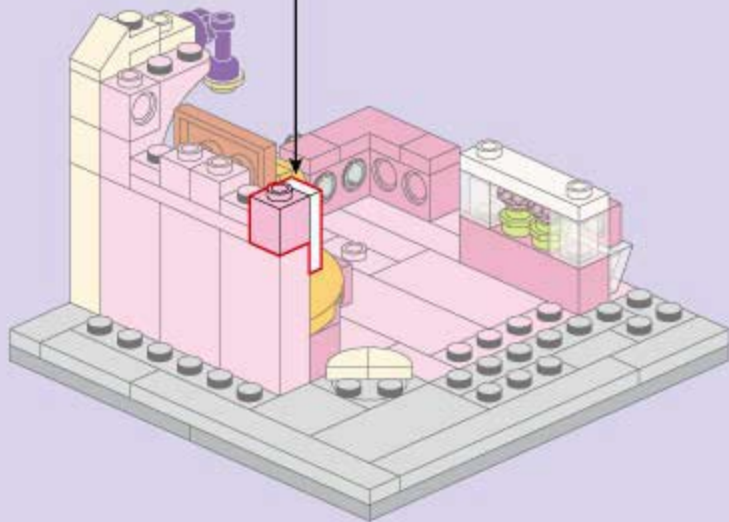

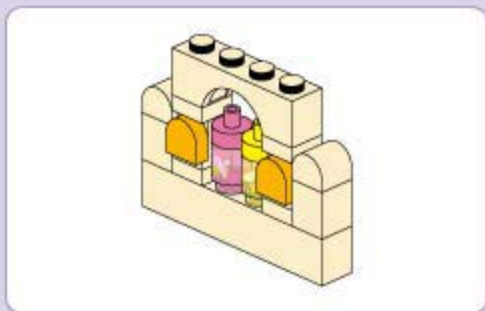

34

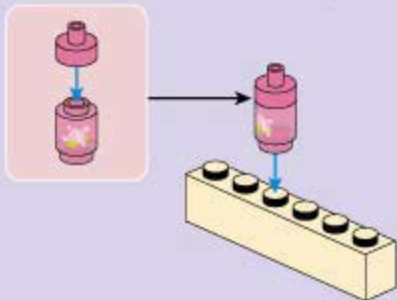
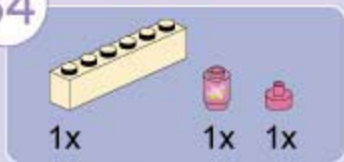

35

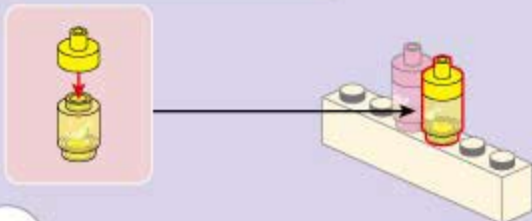

36

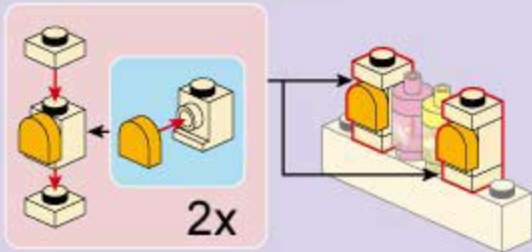

37

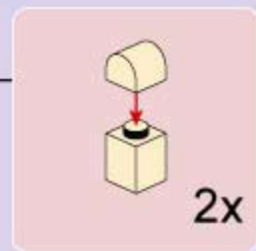
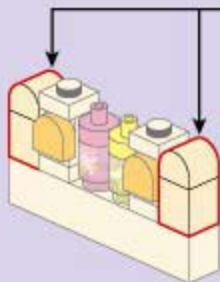

38

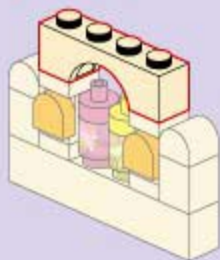
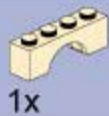



39

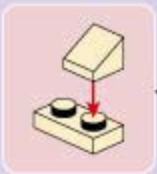
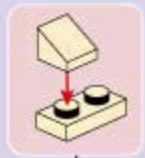

38

33

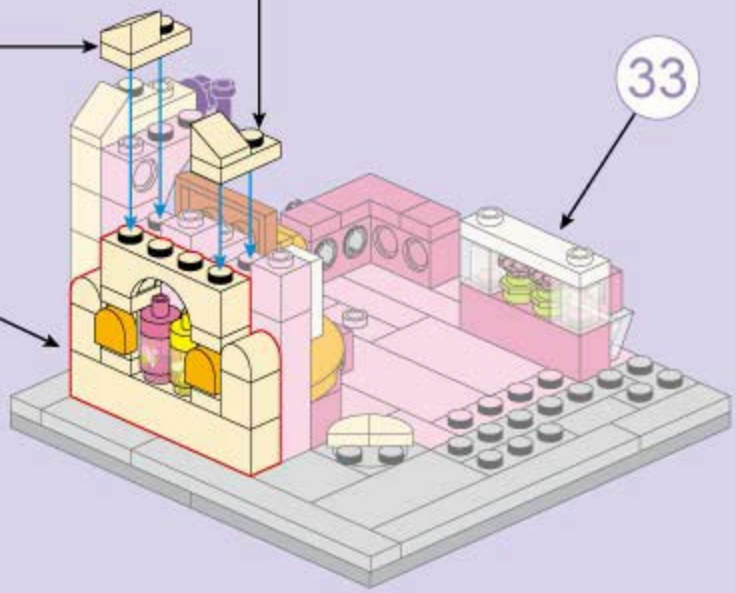

40



1x



1x

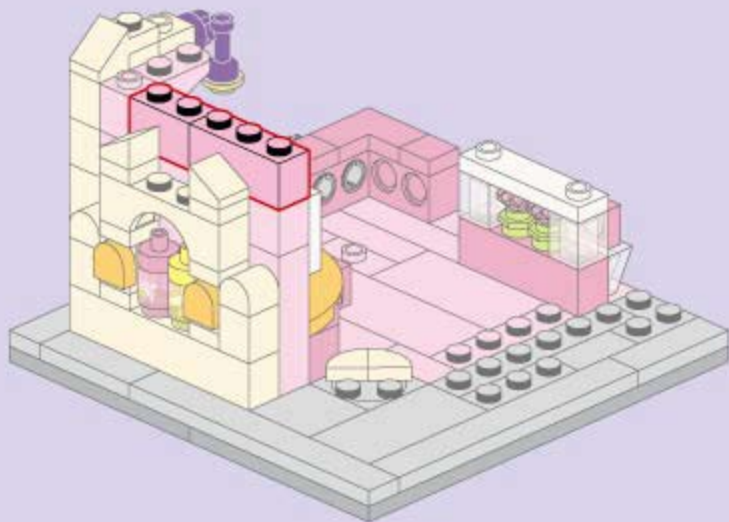

25

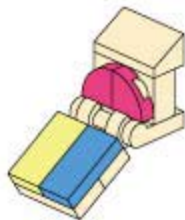
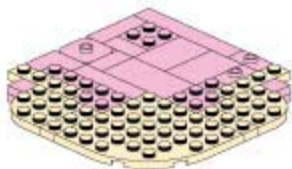

41



1x



1x



2x

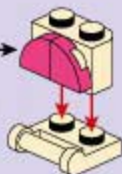
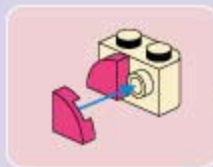

42



1x



43



1x



1x



1x



1x

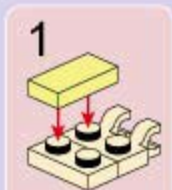

1

2

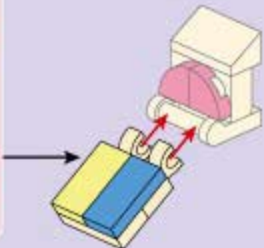
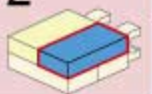

44

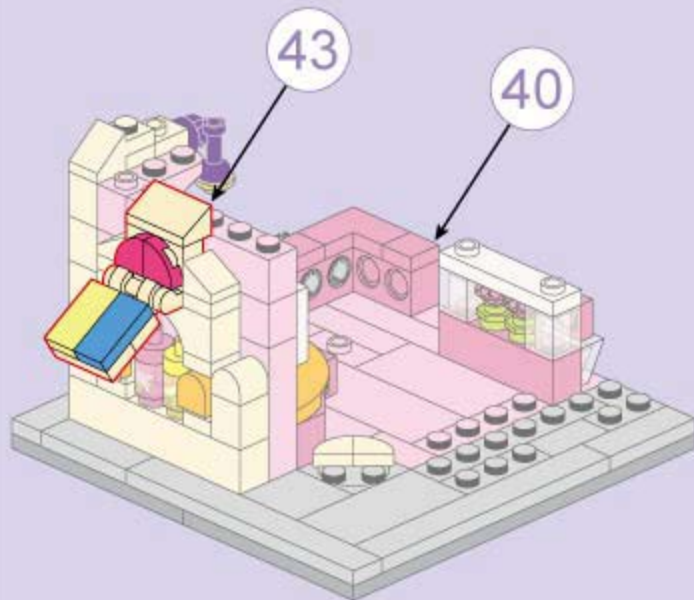



45

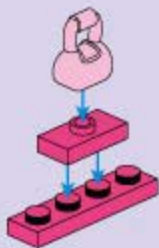
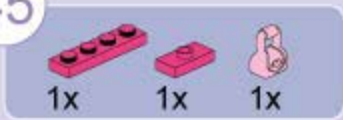

46

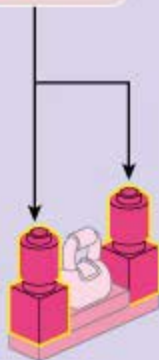
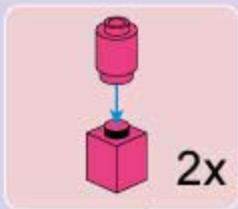
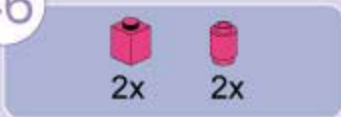

47



1x



1x



48



2x



2x



1x

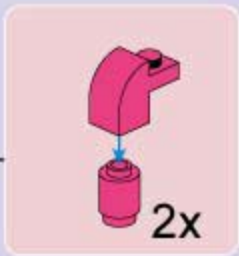

49

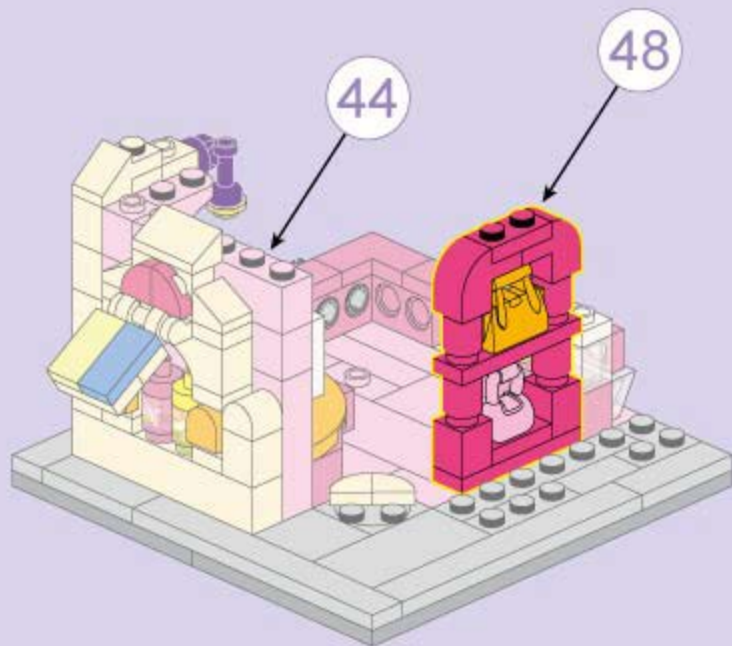

50

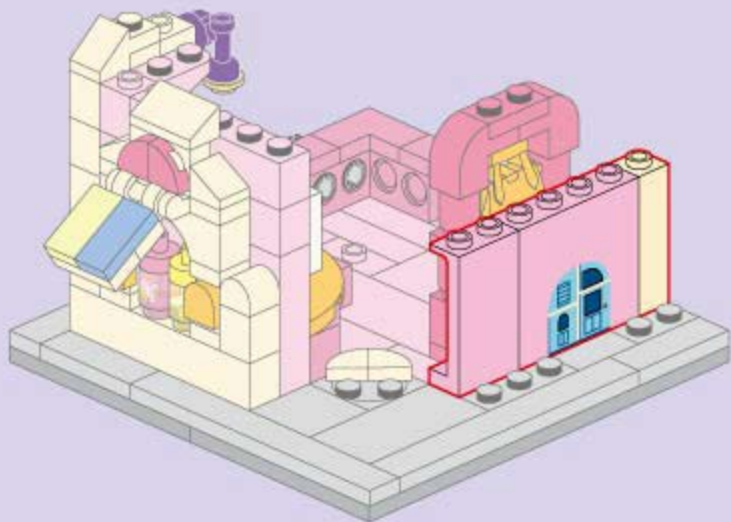
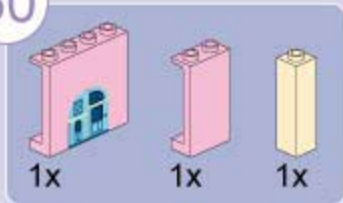





51

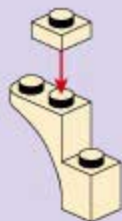
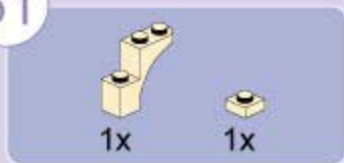

52

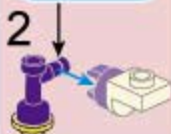
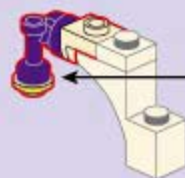
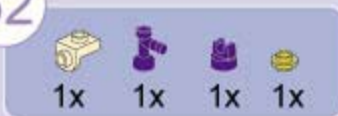

53



54

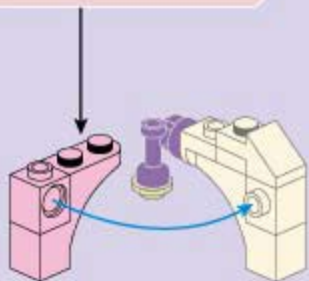
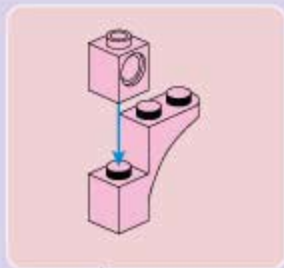
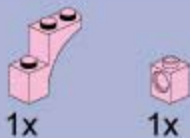

55

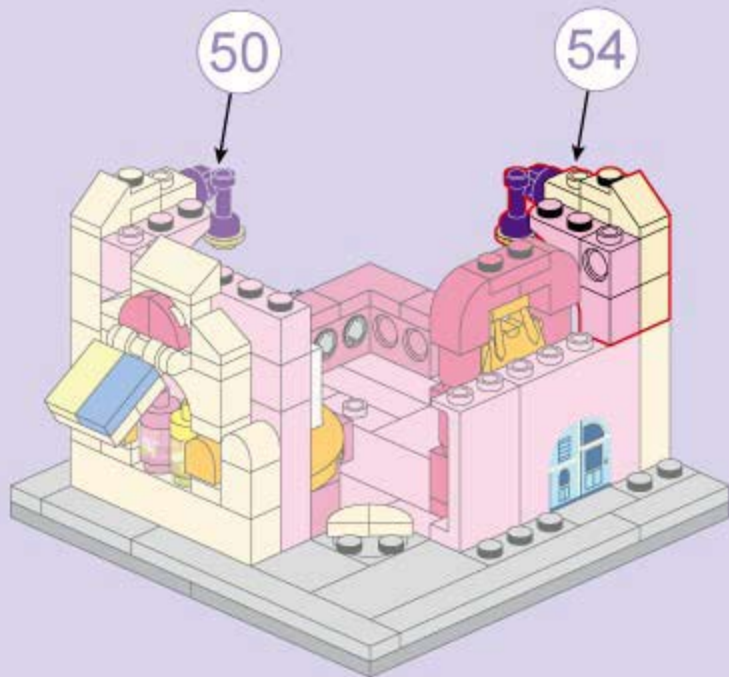

56



1x



1x



57



1x



1x



3x



2x



3x

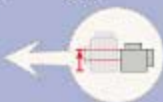

1:1

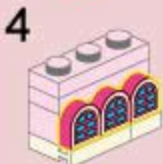
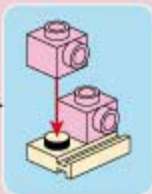
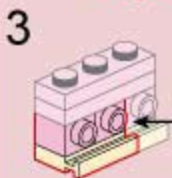
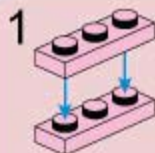

58

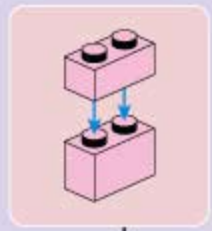
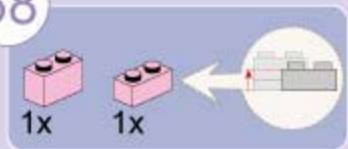



59

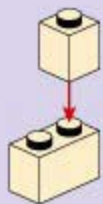

60

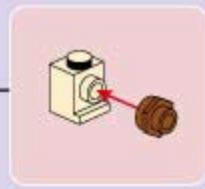

61

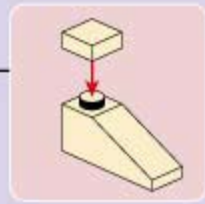
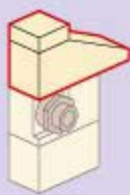
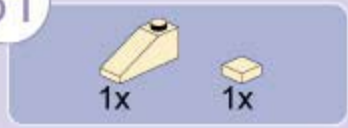

62



1x

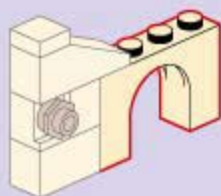

63



1x

1x4

2x

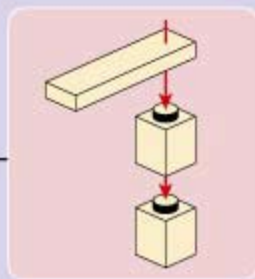
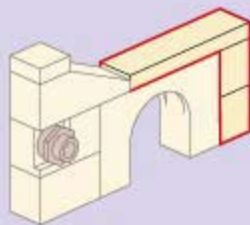

64



1x

1x



65

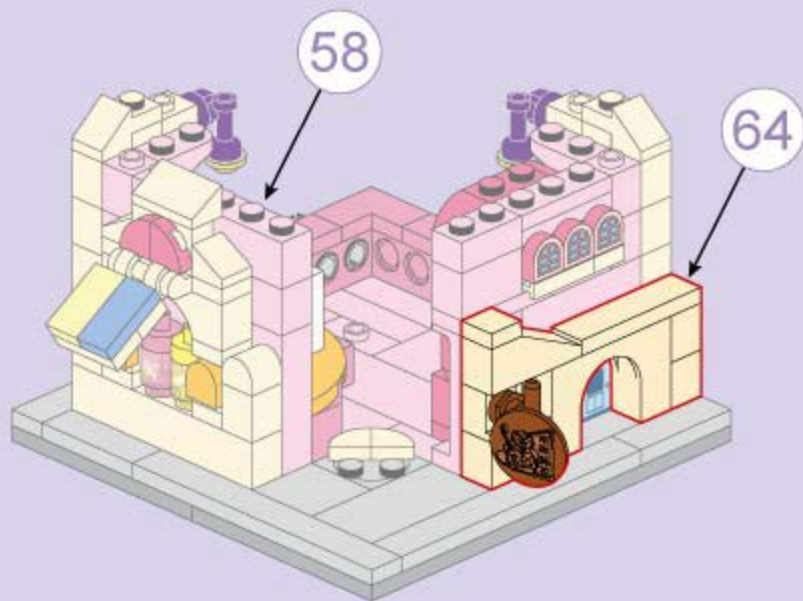



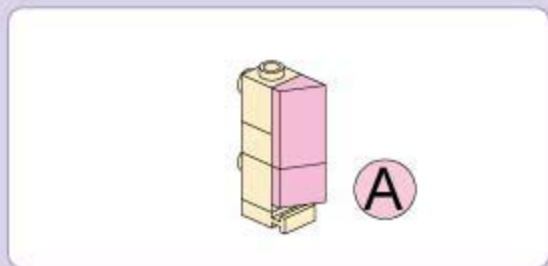

66

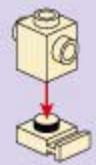

67

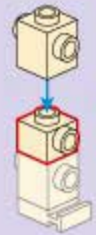
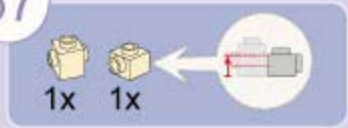

68

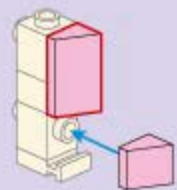

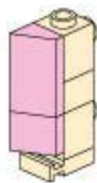

B

69

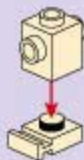

41

70

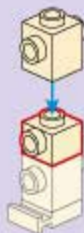

71

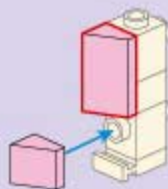



72

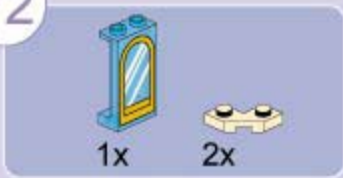

73

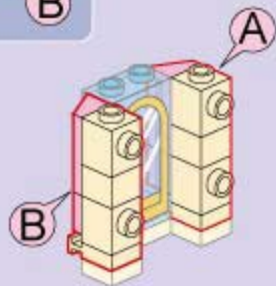
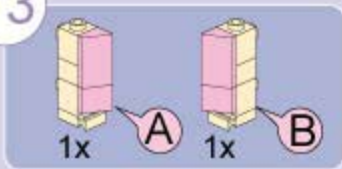

74



75

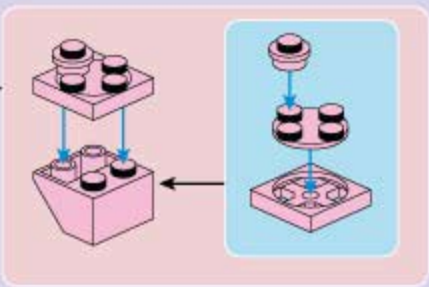
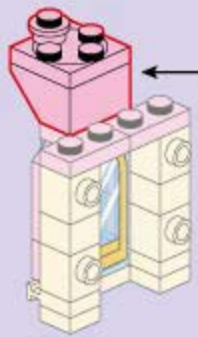
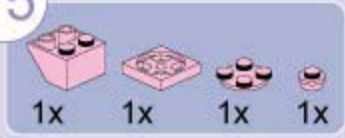

76

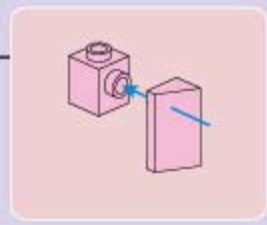
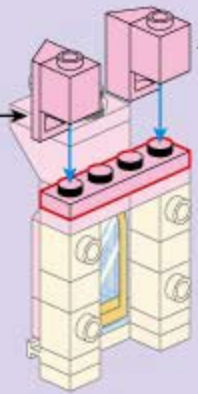
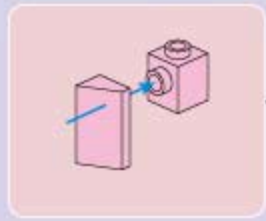

77



1x



1x

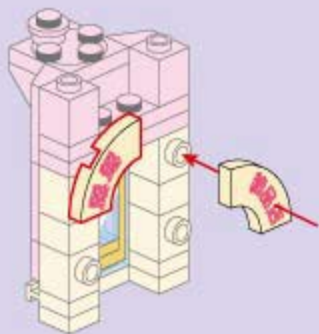

78



2x



2x



79

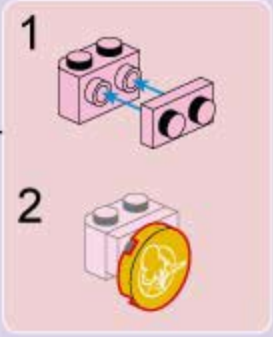

80



81





注意：需将此组件拆开，然后在相对应的序号步骤处拼装。

Caution: This set piece needs to be separated, and assembled at respective sequence number.



1x 82

该积木用于第4分包  
This brick is for pack 4



1x 160

该积木用于第4分包  
This brick is for pack 4



1x 161



注意：需将此组件拆开，然后在相对应的序号步骤处拼装。

Caution: This set piece needs to be separated, and assembled at respective sequence number.



1x 82

该积木用于第4分包  
This brick is for pack 4



1x 164

该积木用于第4分包  
This brick is for pack 4



1x 165



注意：需将此组件拆开，然后在相对应的序号步骤处拼装。

Caution: This set piece needs to be separated, and assembled at respective sequence number.



1x 82

该积木用于第4分包  
This brick is for pack 4



1x 163

该积木用于第4分包  
This brick is for pack 4



1x 162

该积木用于第4分包  
This brick is for pack 4



1x 163



注意：需将此组件拆开，然后在相对应的序号步骤处拼装。

Caution: This set piece needs to be separated, and assembled at respective sequence number.



1x 82

该积木用于第4分包  
This brick is for pack 4



1x 159

该积木用于第4分包  
This brick is for pack 4



1x 158

该积木用于第4分包  
This brick is for pack 4



1x 159



82

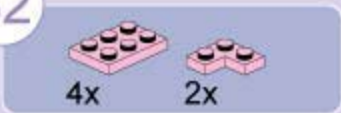

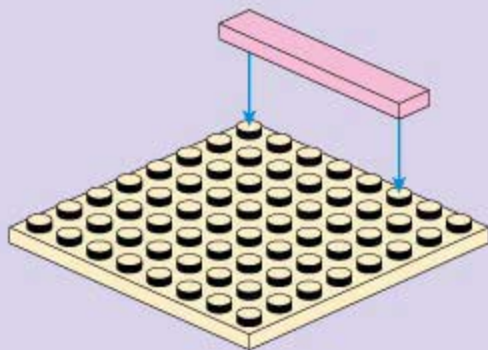
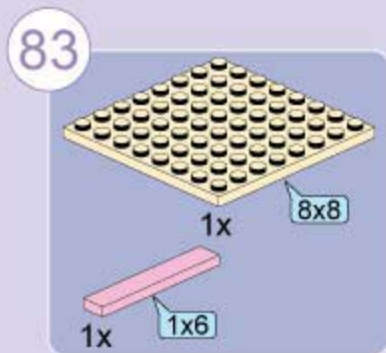
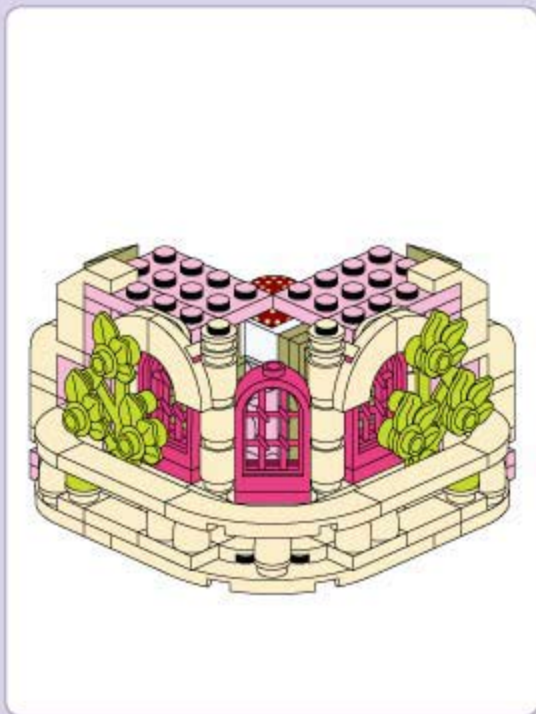

84

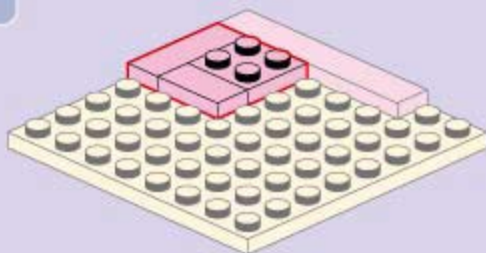
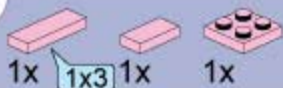

85

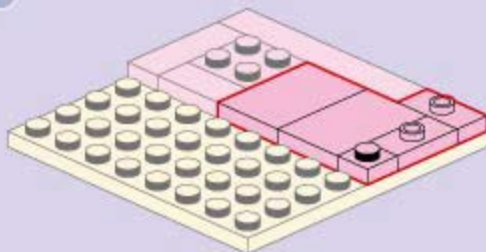

86

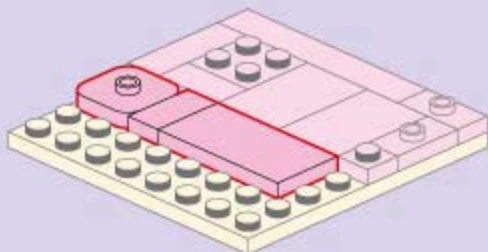
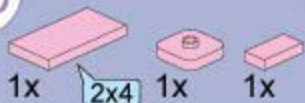

87

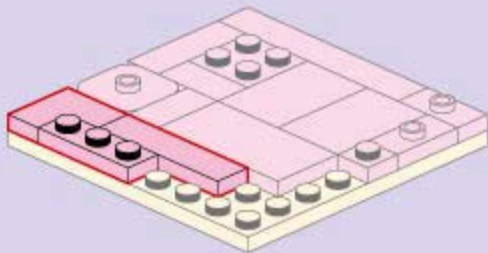

88

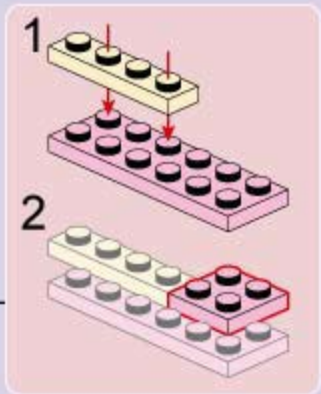
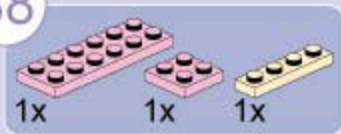

89

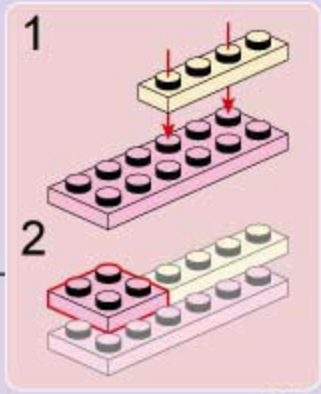
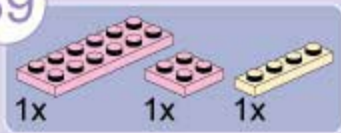

90

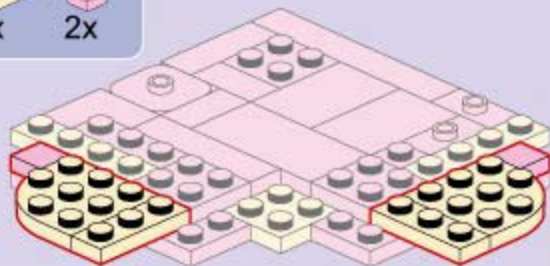

91

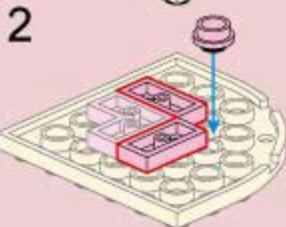
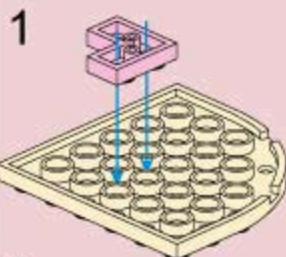
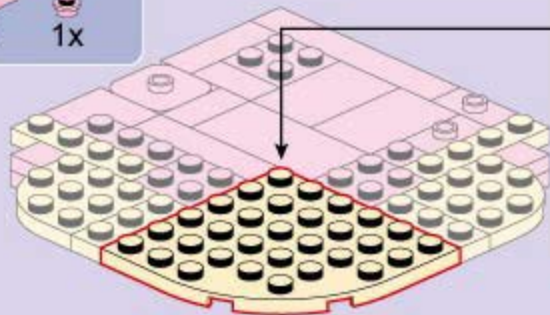

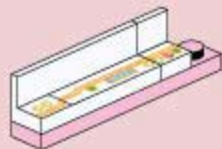

注意：需将此组件拆开，然后在相对应的序号步骤处拼装。

Caution: This set piece needs to be separated, and assembled at respective sequence number.

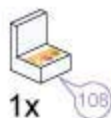
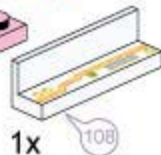
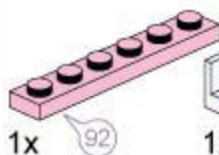

92

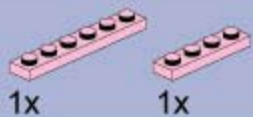

辅助件  
Assistant brick

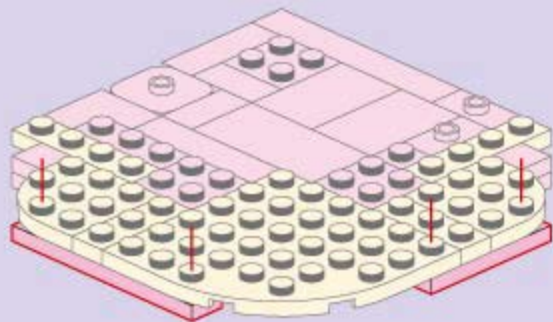
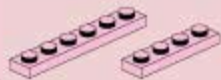

55



93

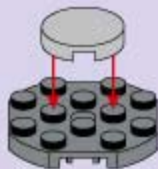



94



2x



4x

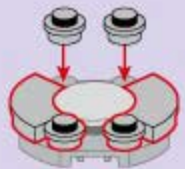

95



1x



2x

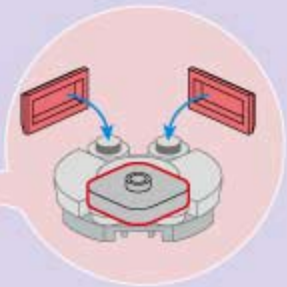

96



1x



1x



97

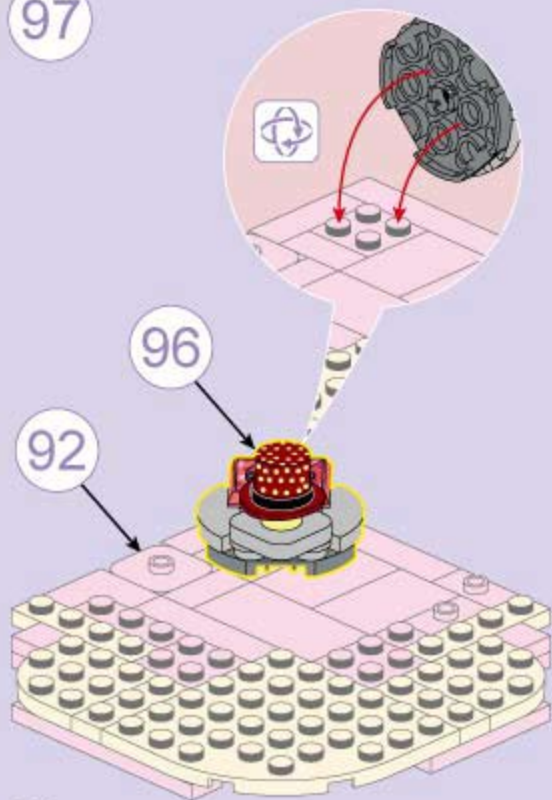

98

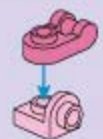

99

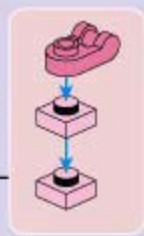
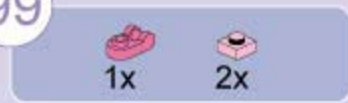

100

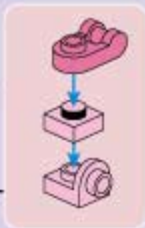

101



102

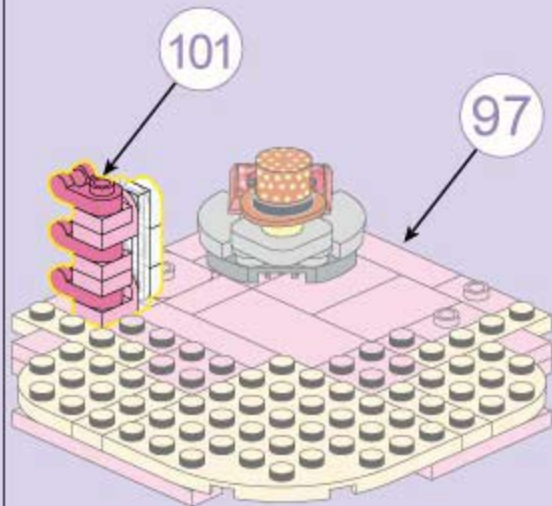



103



1x



1x



1x

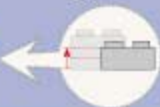

1:1

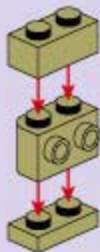

104



1x

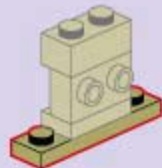

105



1x



106

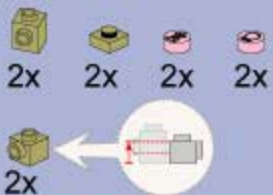

107

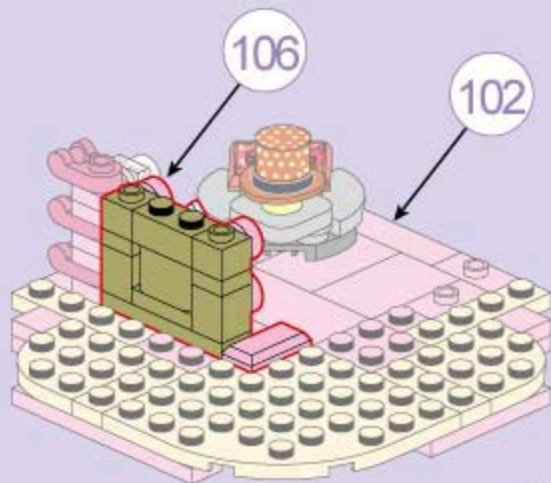
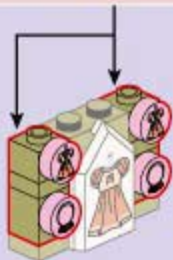
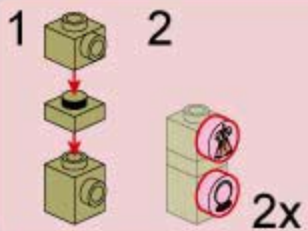

108

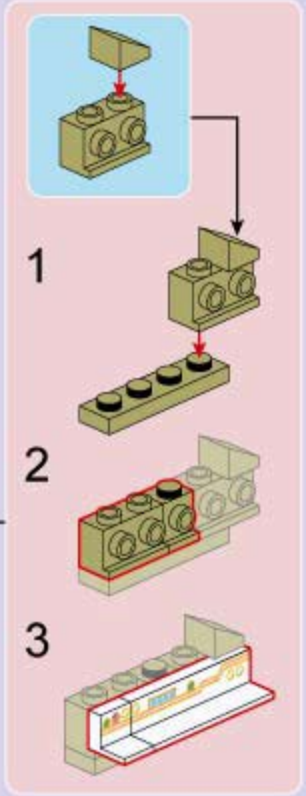
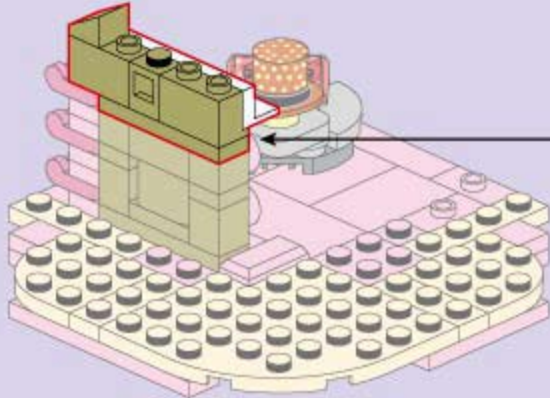
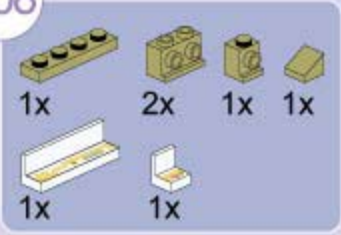

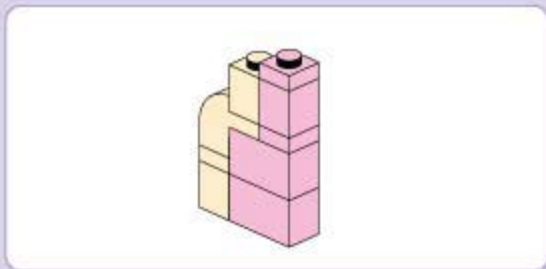

109

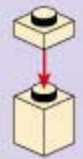

110



111

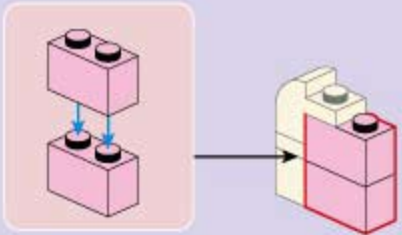

112

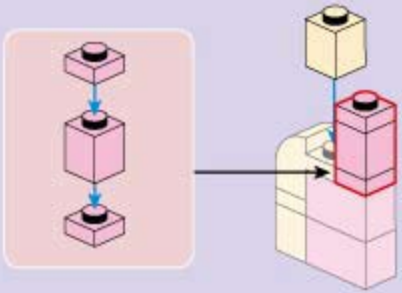

113

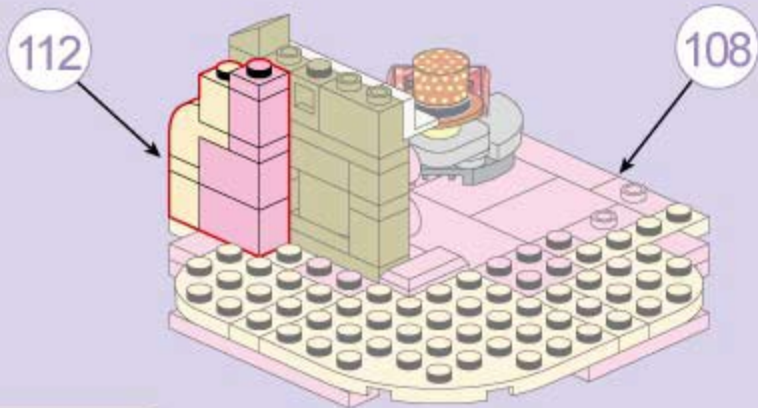

114

1x 1x 1x

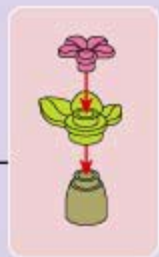



115



2x



1x



1x

1

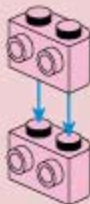

2



116

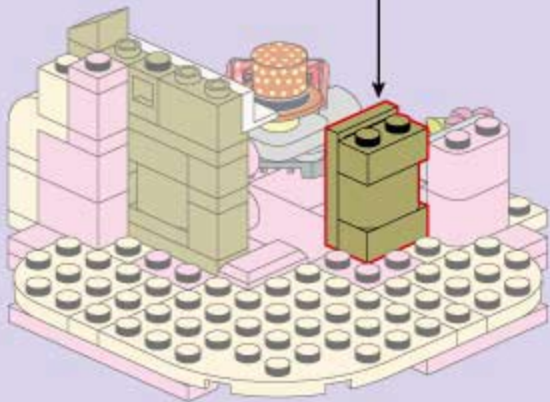
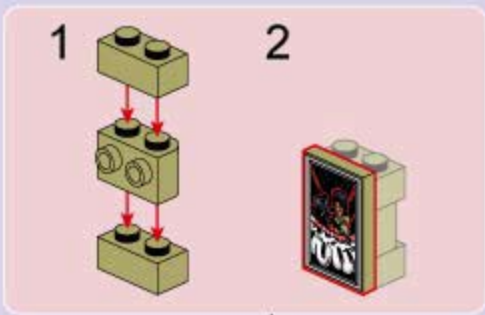
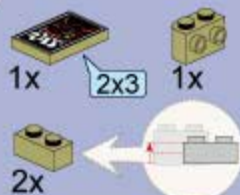

117

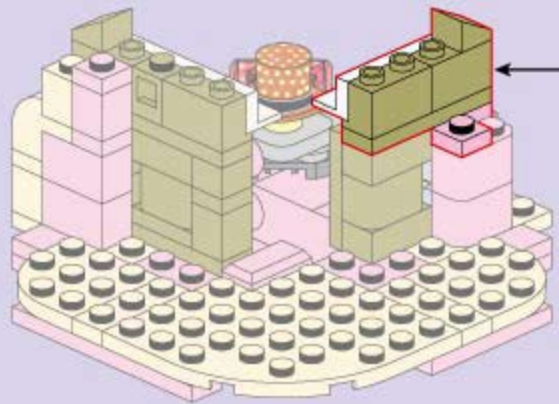
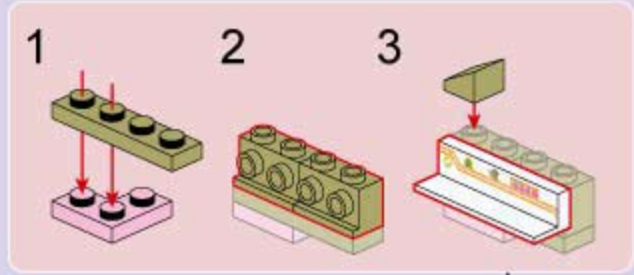
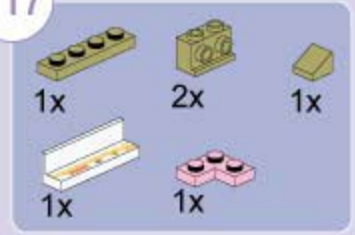

118

- 1x
- 2x
- 1x
- 1x
- 1x

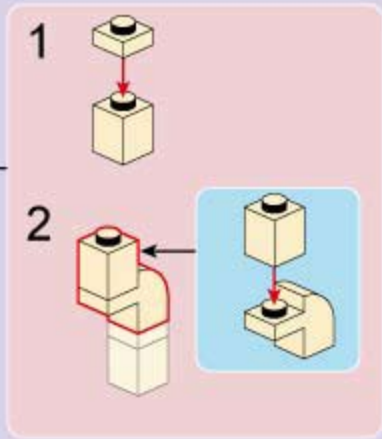
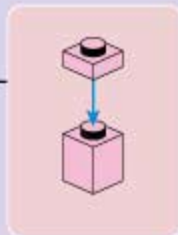
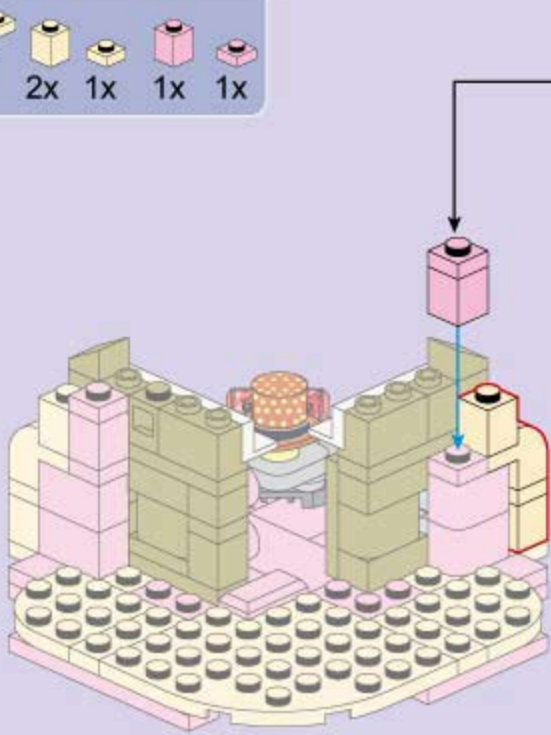

119

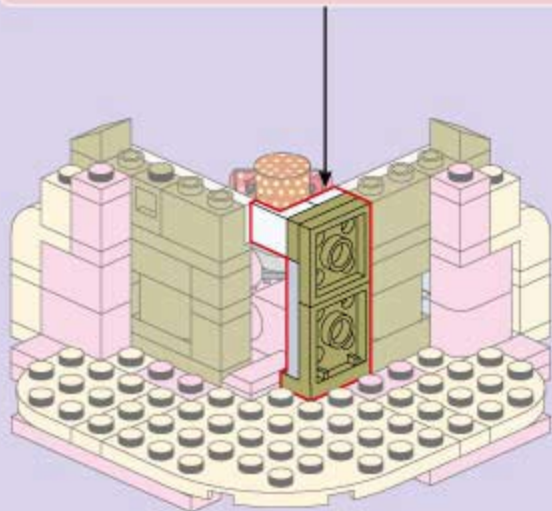
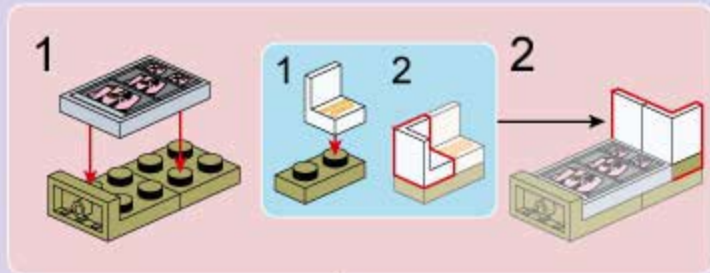

120



6x



2x



2x

1



2



2x

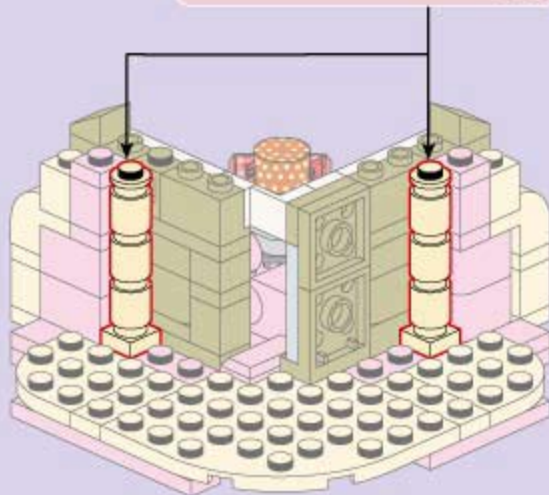

121

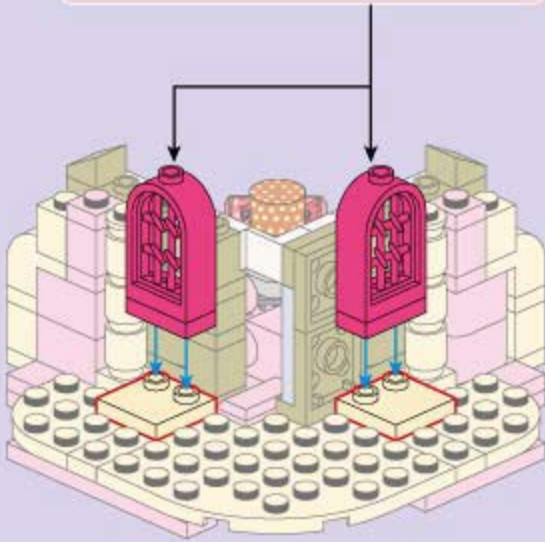
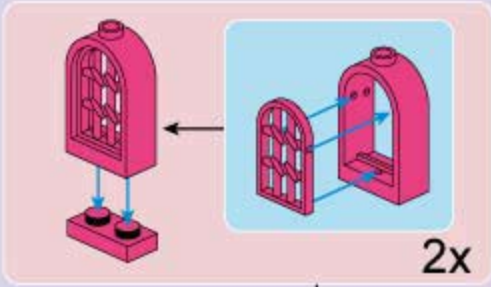
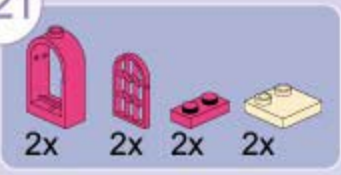

122

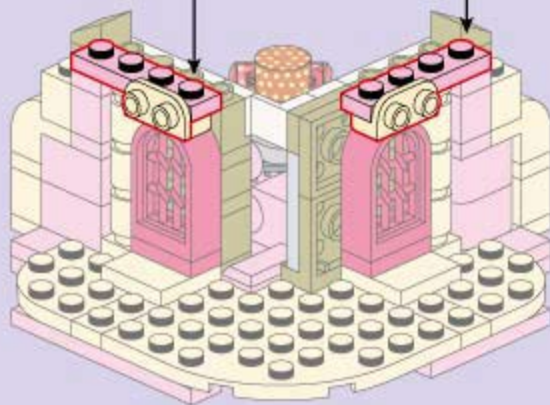
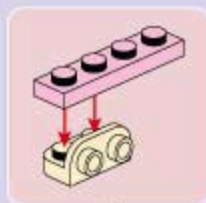
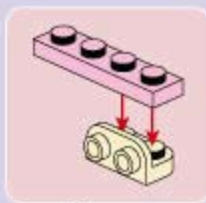



123



2x



2x

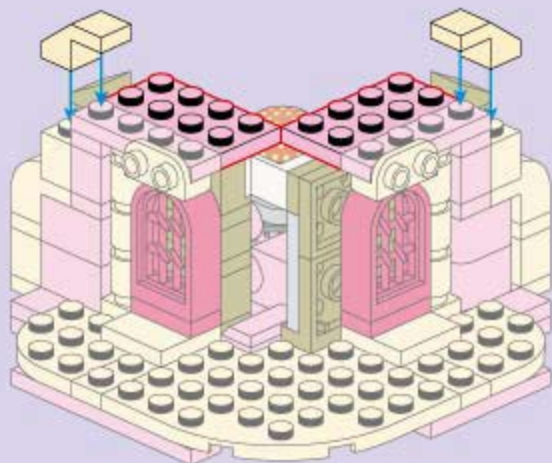

124



6x



2x



4x

1



2

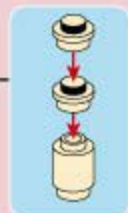

2x

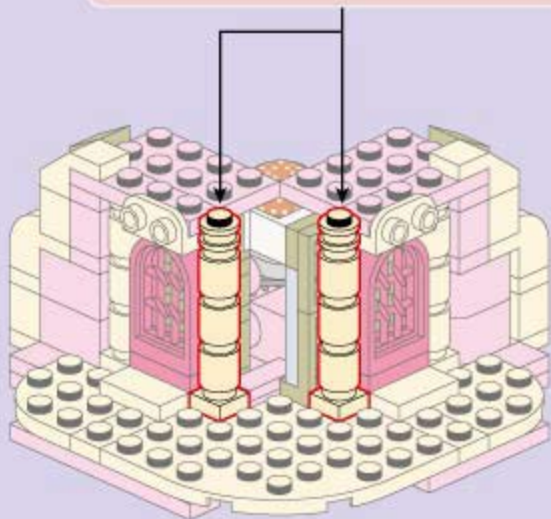



125



4x

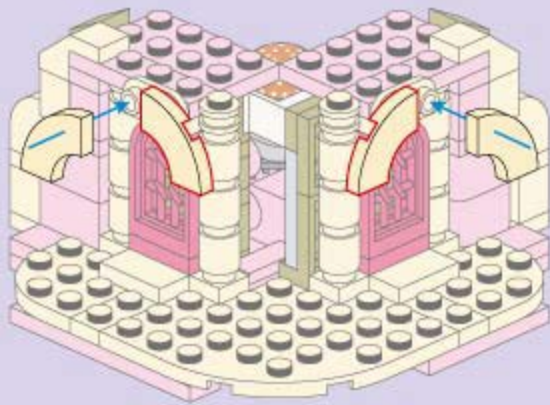

126

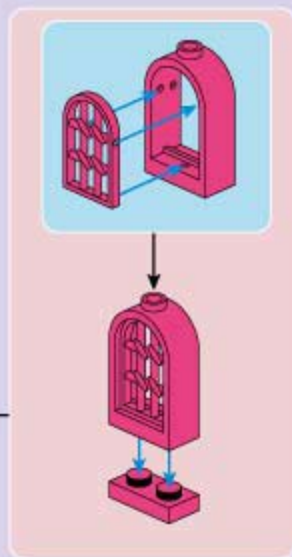
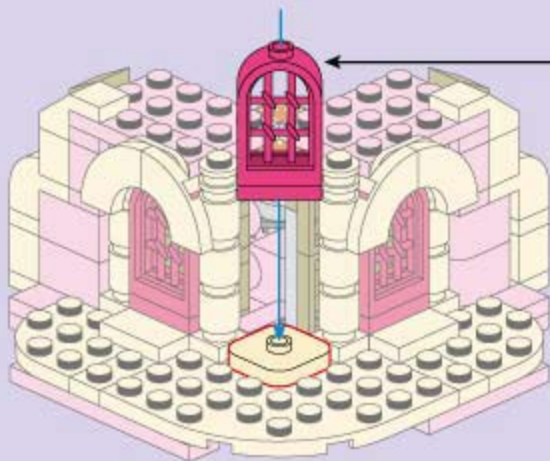

127



2x



2x



2x



2x

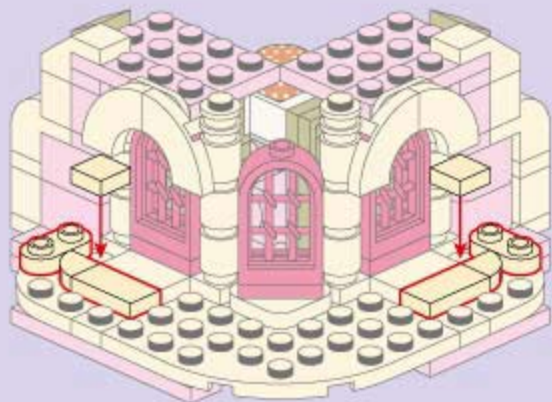

128



2x

2x3



1x



2x

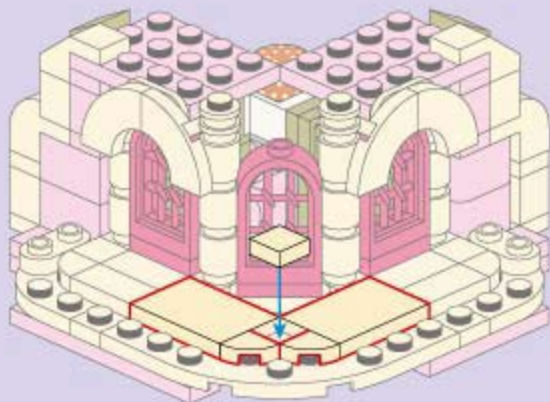

129

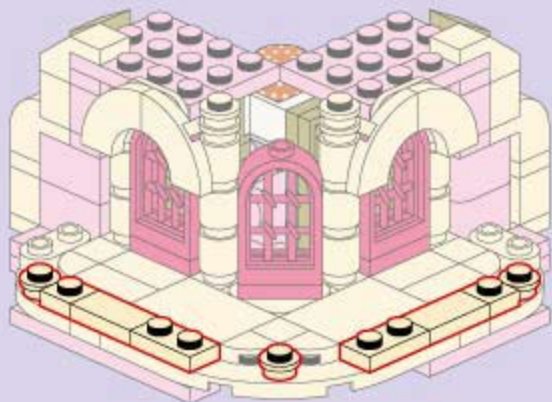

130



11x

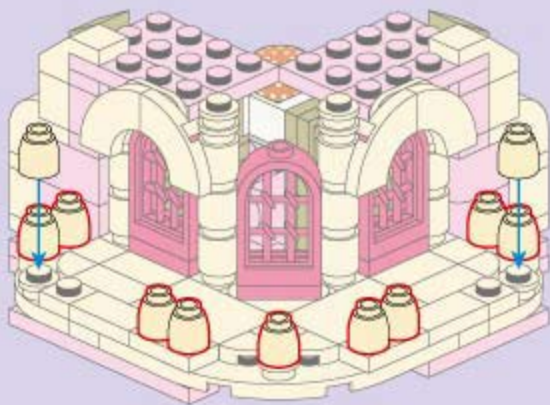

131



2x



2x

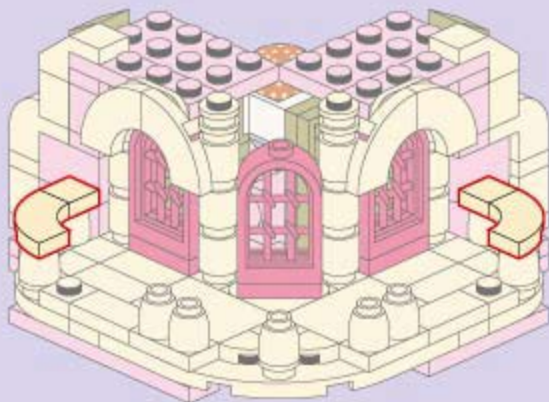



132

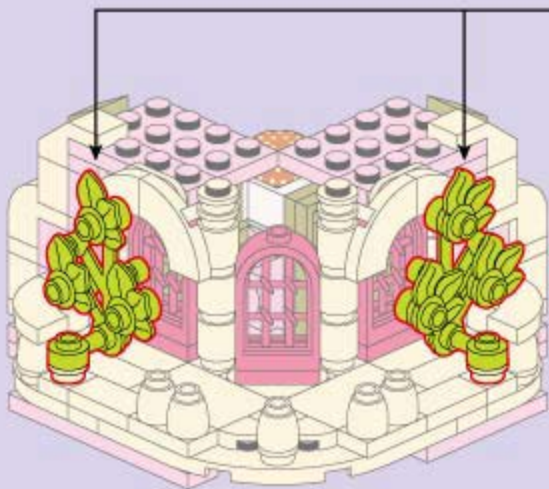

1



2



3

**1:1****2x**

133



1x

2x

1x4



2x



2x

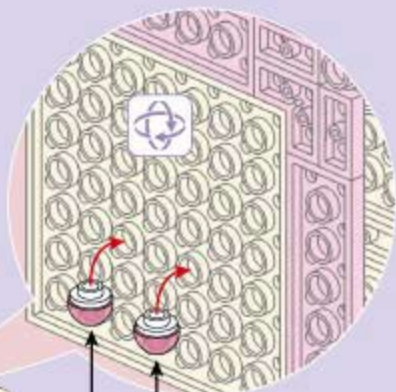
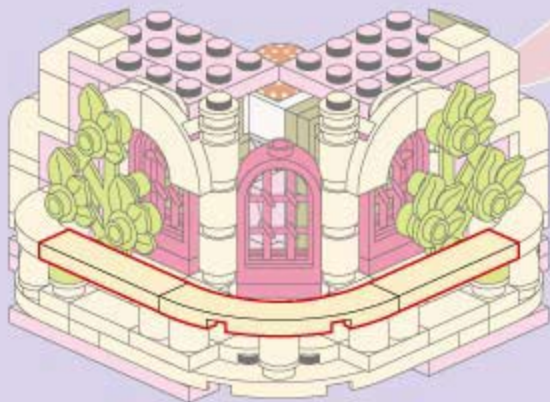

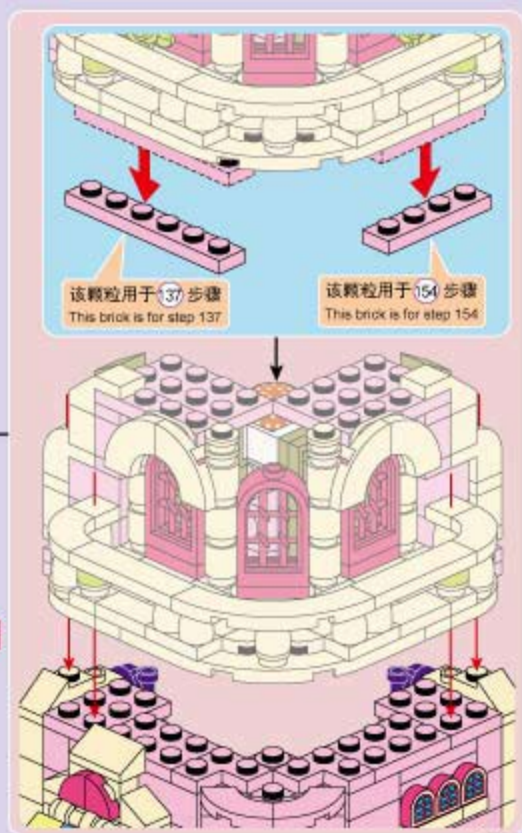

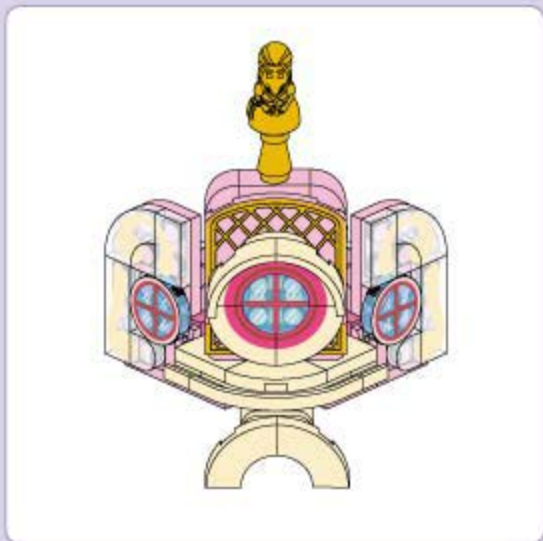

135

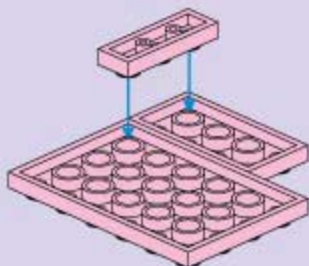
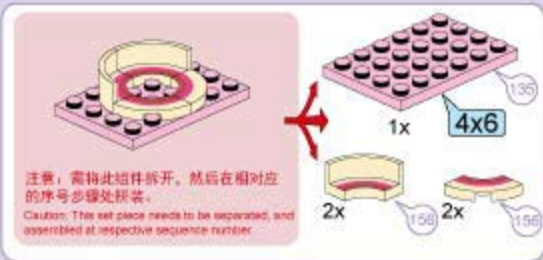
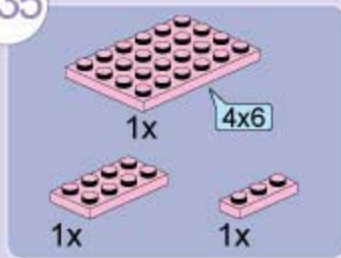

136

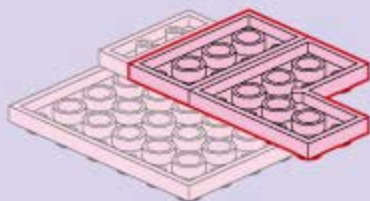
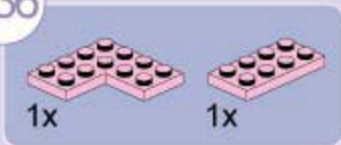

137

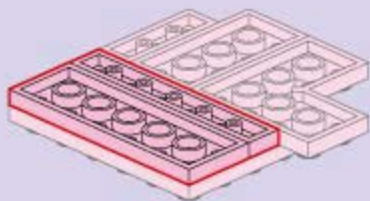
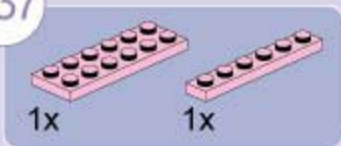

138

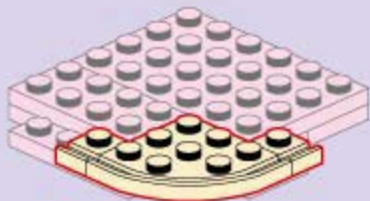

139



2x



3x

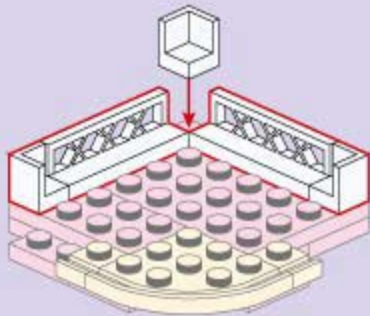

140



1x



2x



1x

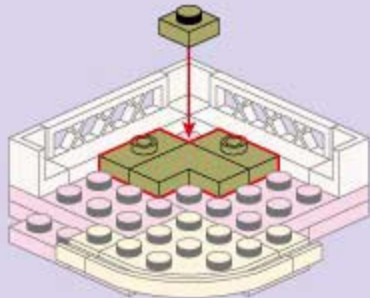

141



1x



2x

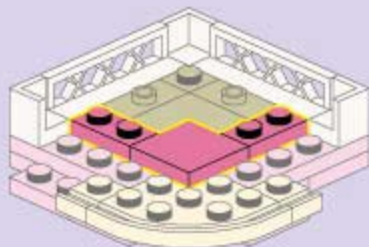

142



2x



1x



1x

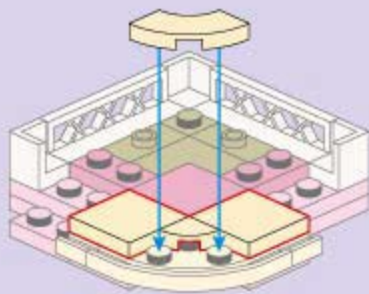

143

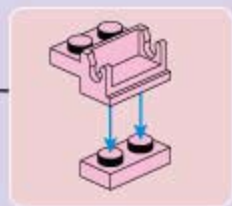
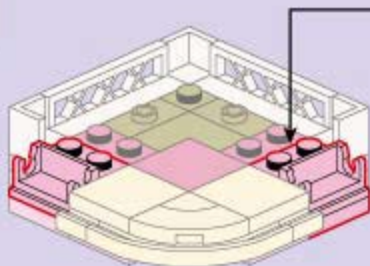

144

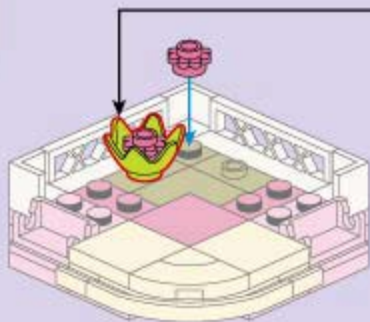



145



3x



1x

2



1x

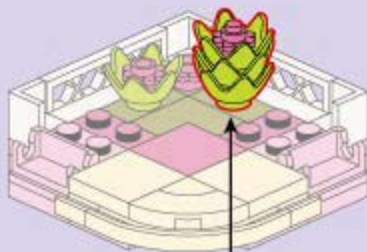

146



2x



2x

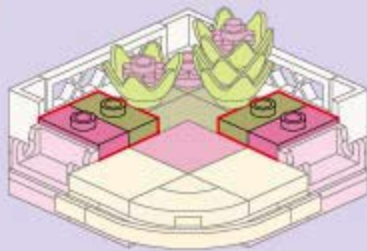

1



2



3



147

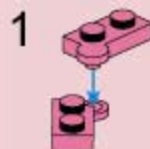
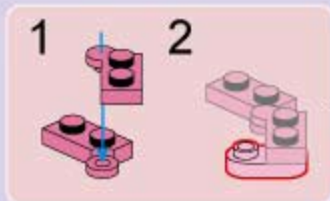

148

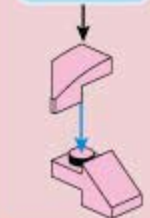
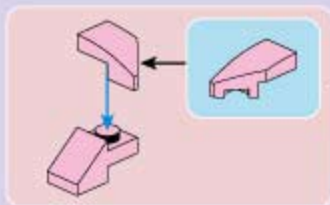



149

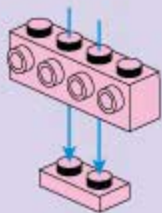
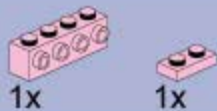

150



151

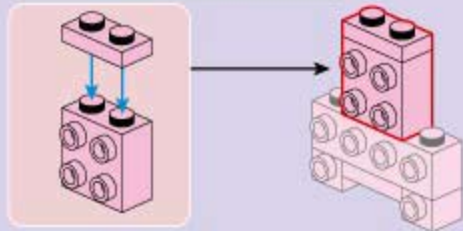
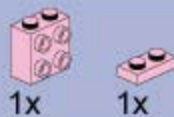

152



2x



2x

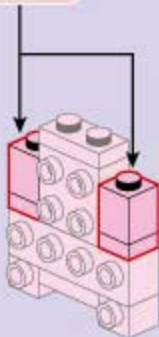
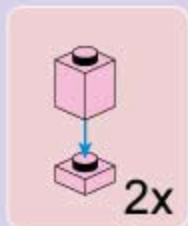

153



2x



1x

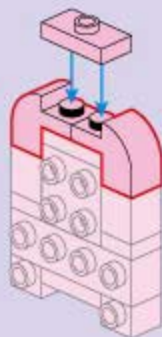

154



1x

1x



1x

1x4

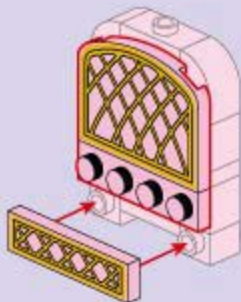

155



1x

1x



1x



1x

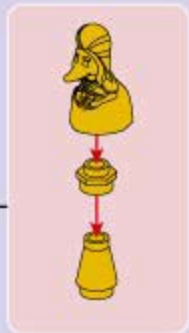
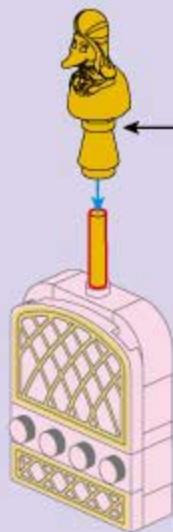

156



1x



2x



2x



1x

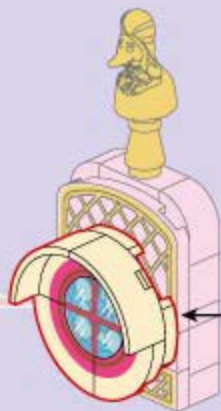
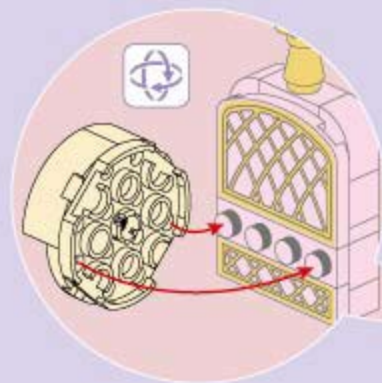

1



2



3

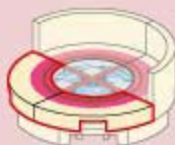

157

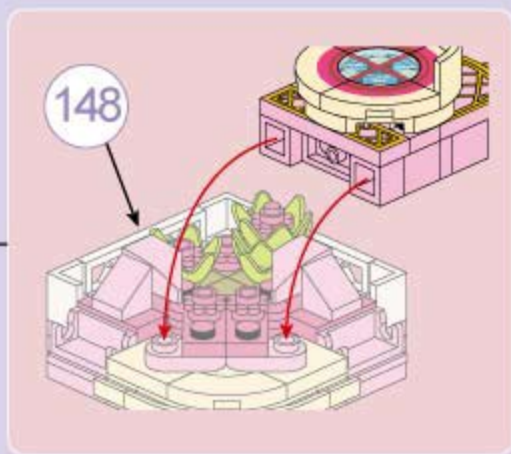
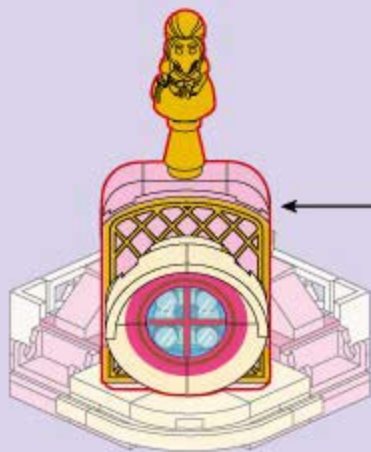

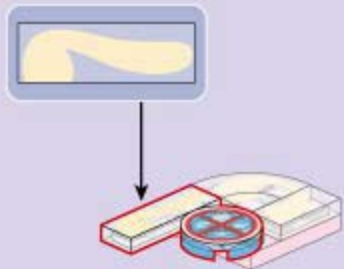
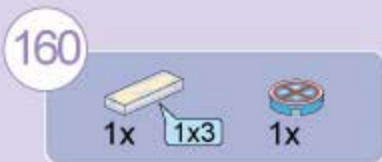
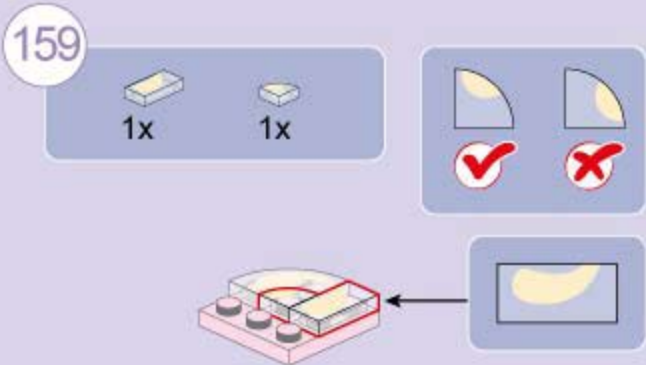
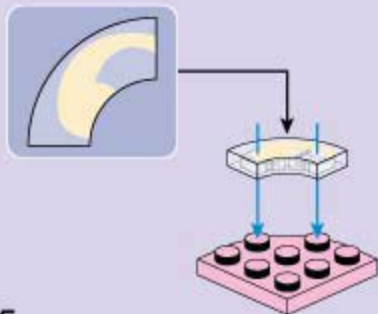
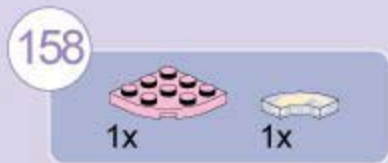
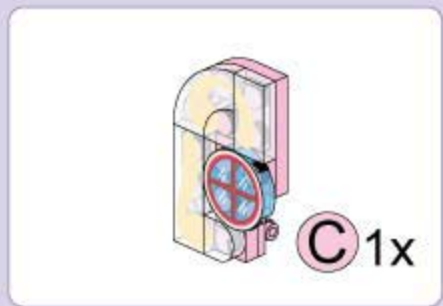



161

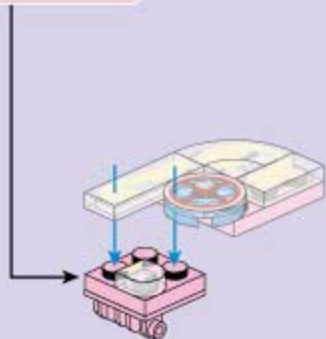
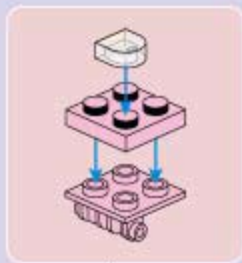

D 1x

162

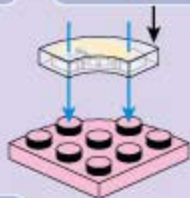

163

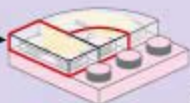

96

164

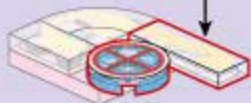

165

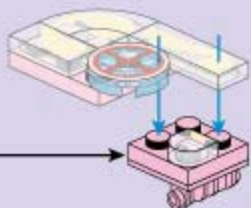

166

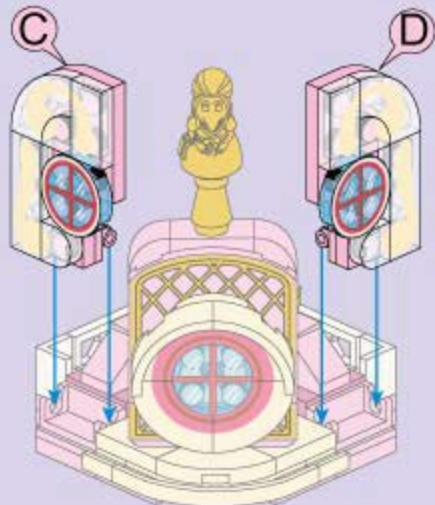
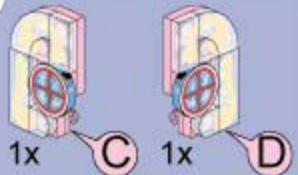

167



1

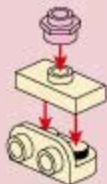

2

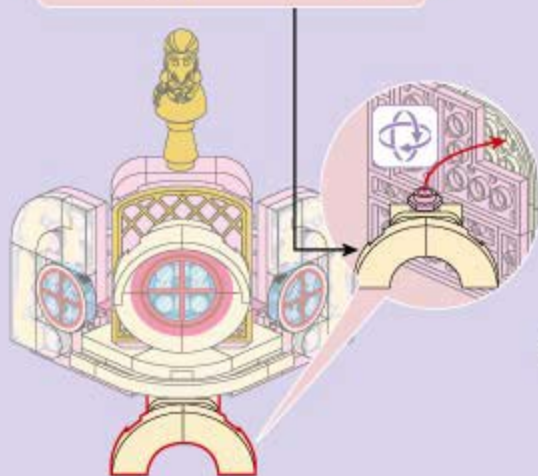

168

167

134



