

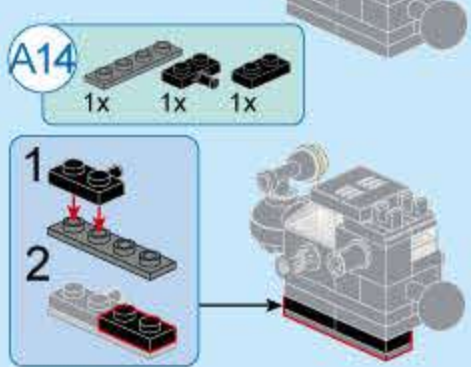

V1.0

41107-1 | PCS:119

SWAT Off-road Vehicle

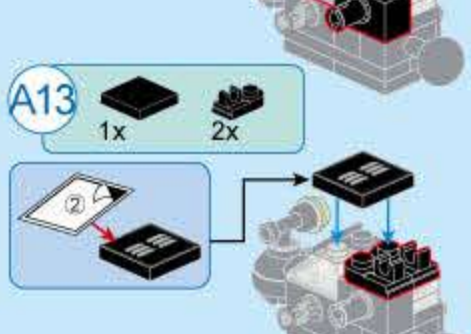
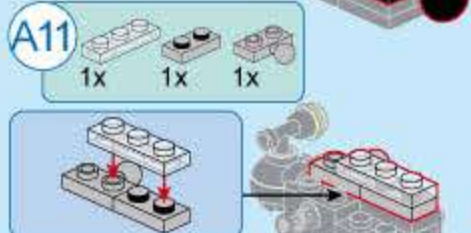
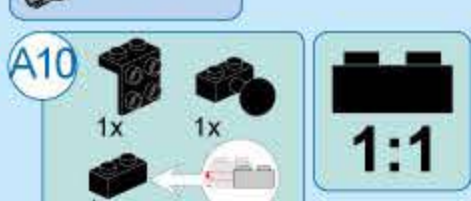
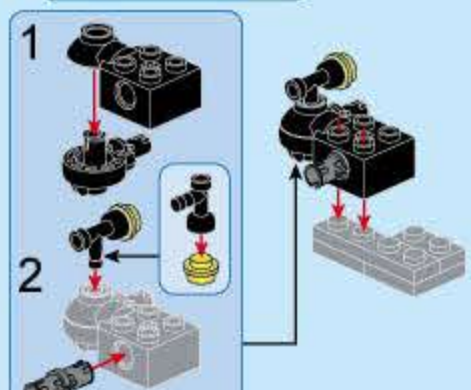
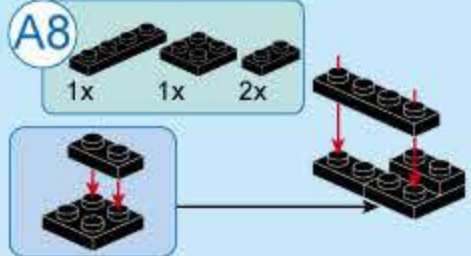
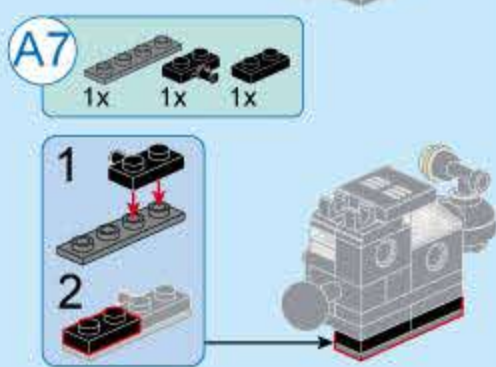
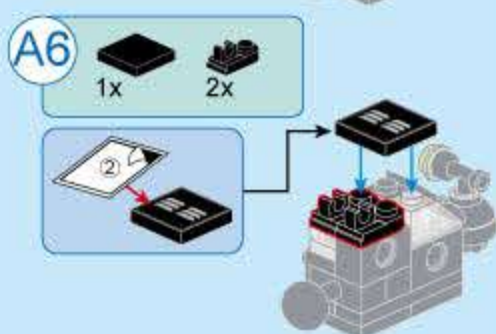
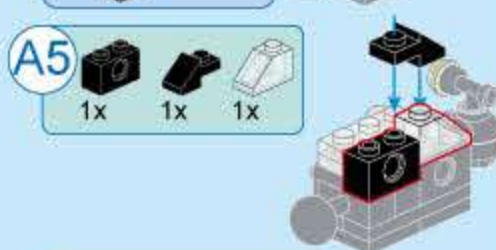
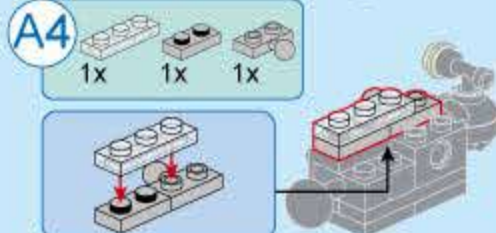
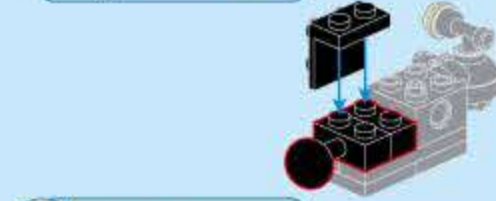
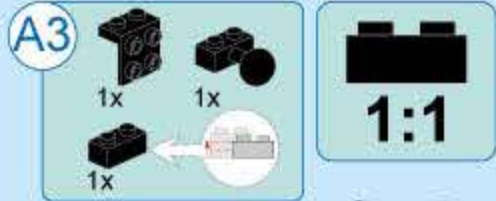
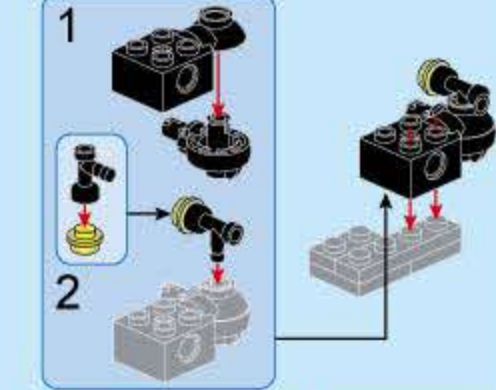
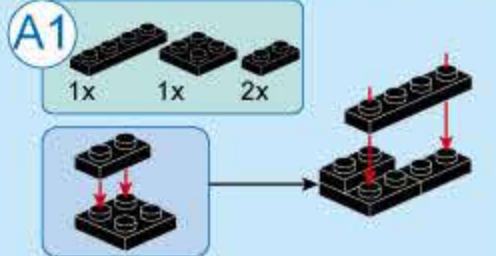

**A15**

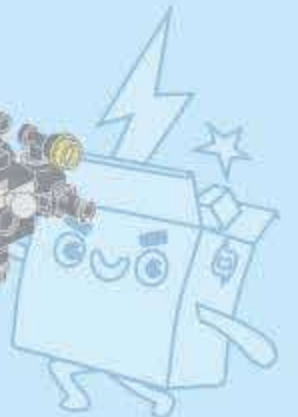
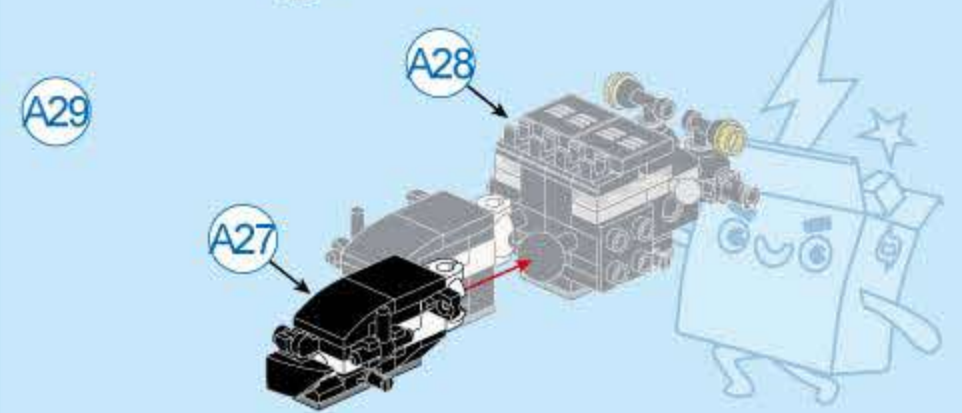
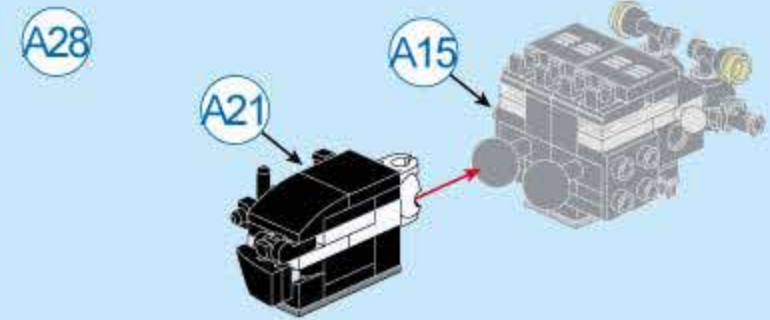
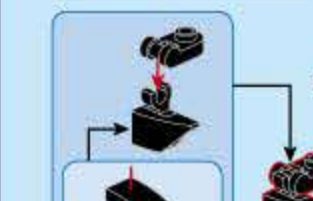
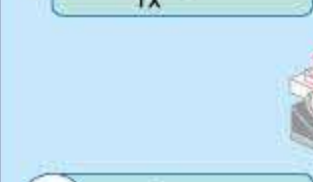
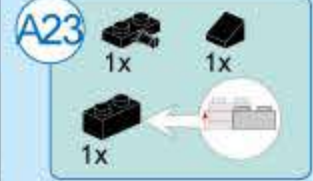
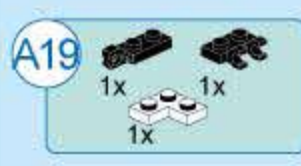
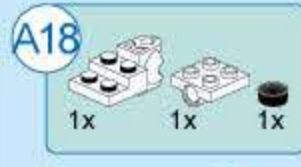
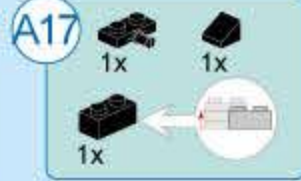
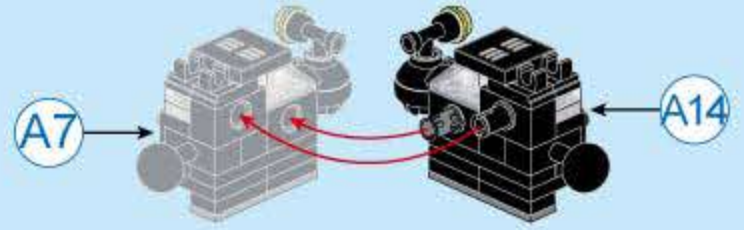

A30  
2x 2x4 2x

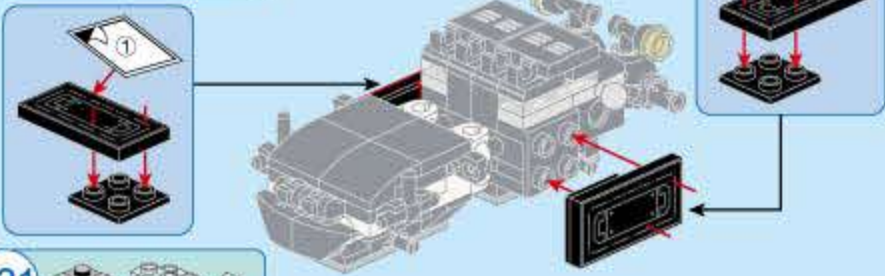

A31  
1x 1x 1x  
1x 1x 2x  
1x 1x 1x

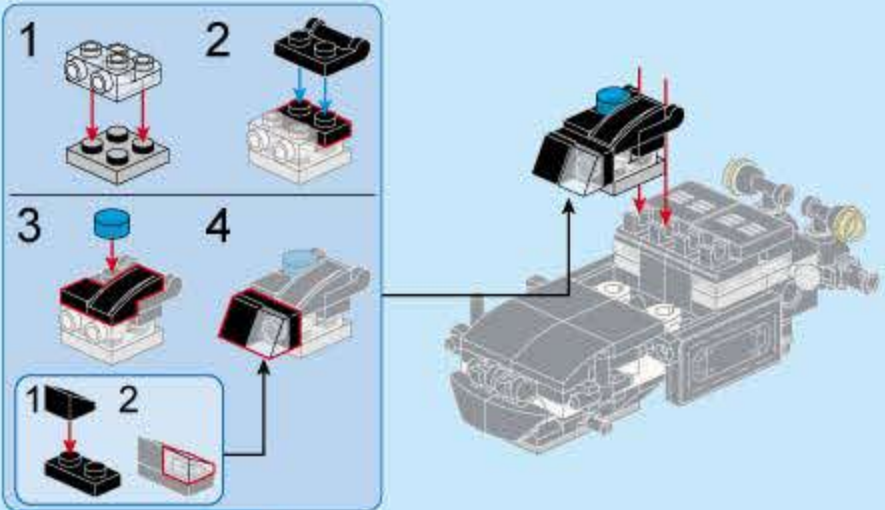

A32  
1x 1x 1x  
1x 1x 2x  
1x 1x 1x

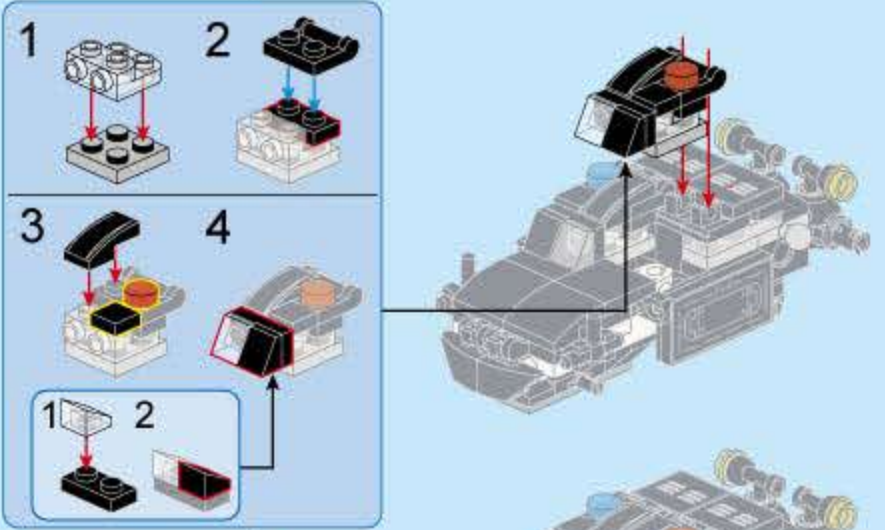

A33  
4x 4x



B1  
1x 1x

C1  
1x 1x

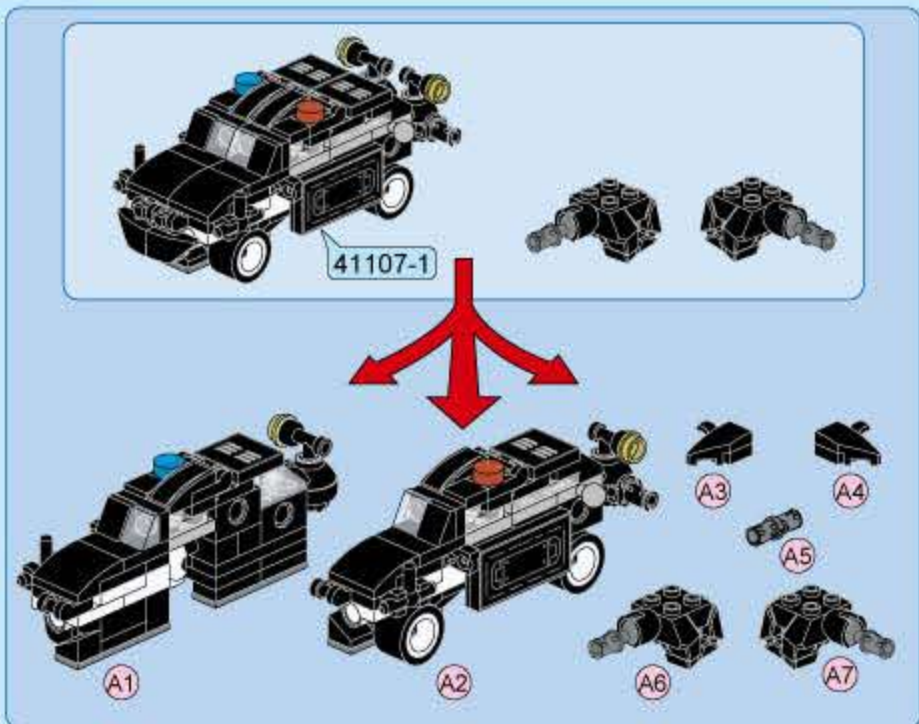
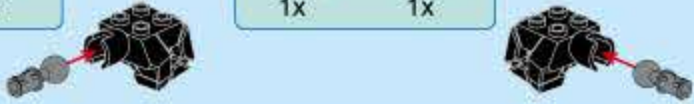

QMAN

TRANSFORMER COLLECTOR



41107 | PCS: 746

SWAT Mecha

1

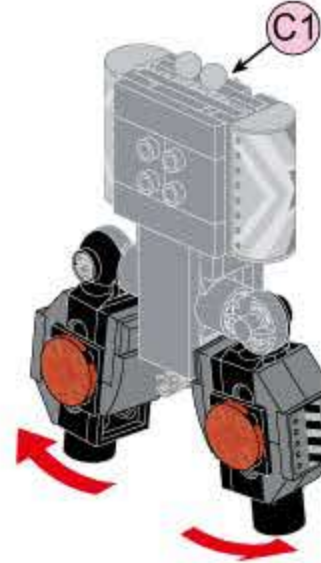

1

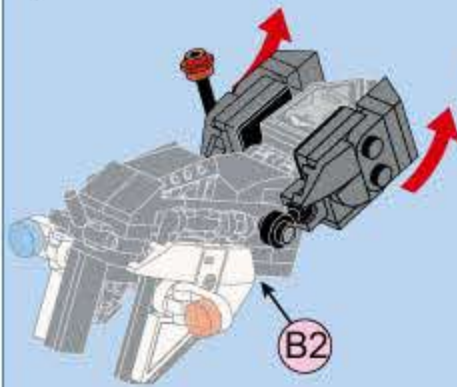

2

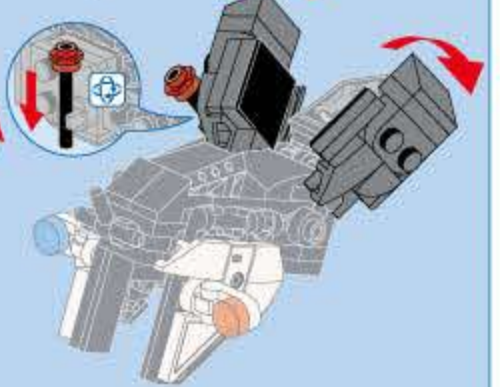

3

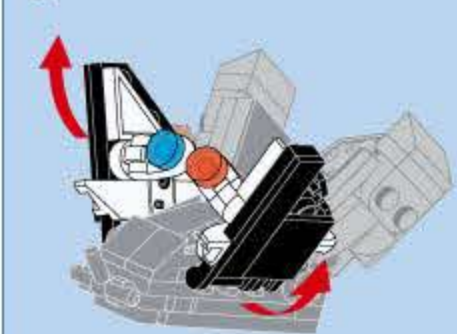

4



2

