

Keepplay

王者荣耀



K21104

图片仅供参考，请以实物为准。

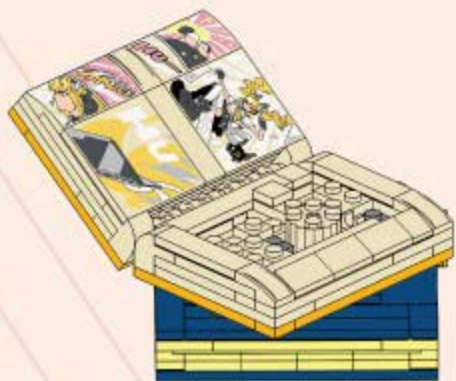
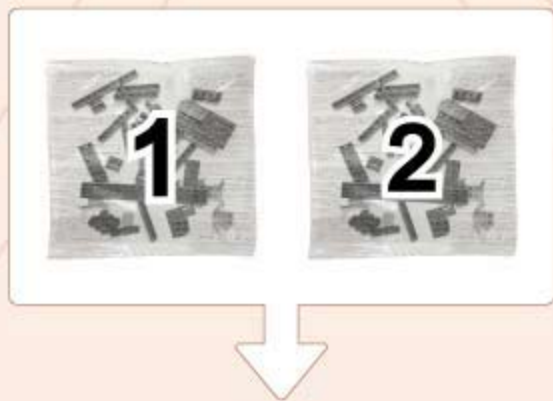



+





拆件器使用方法， 仅为示例

Usage of Brick Separator, Just for the sample

1

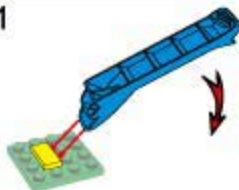

3

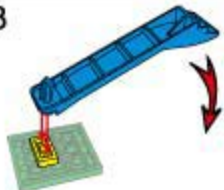

2



4



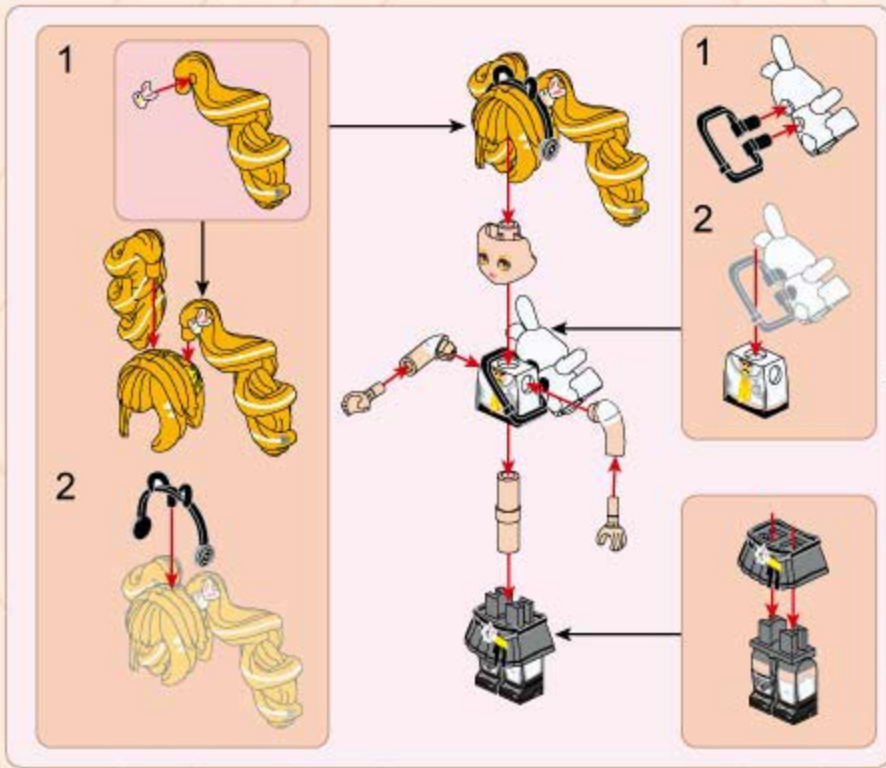

1



1x

8x10



1x

1x10

1x

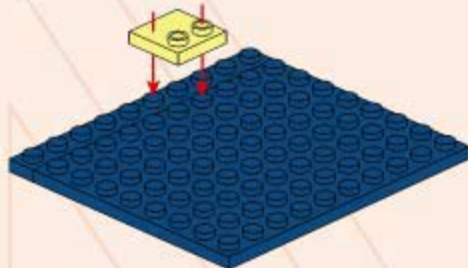

2



3x

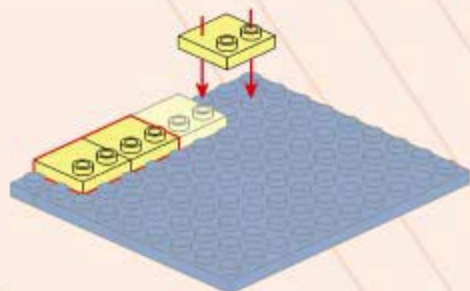

3



2x

1x6



2x



2x

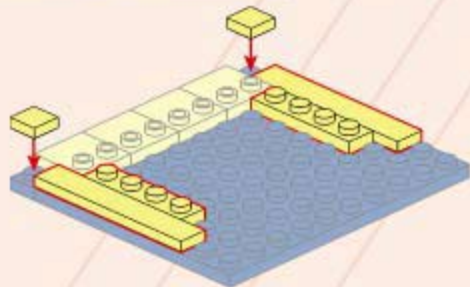

4



2x



2x

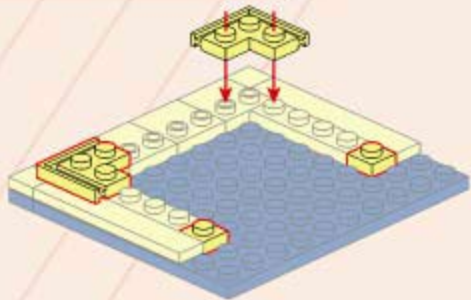

5



3x



2x

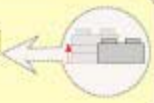

1:1

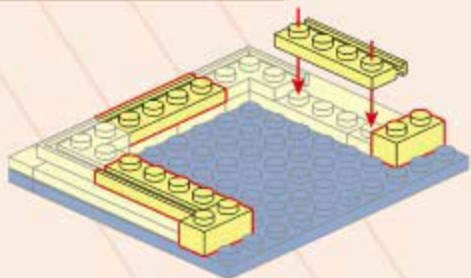

6



1x



3x

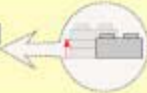

1:1

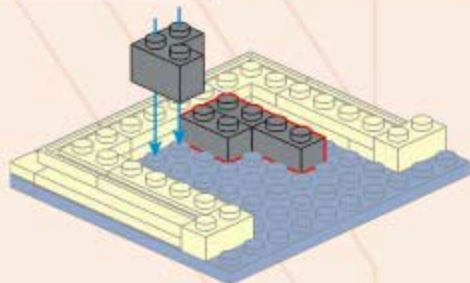

7



1x



3x



1:1



1x

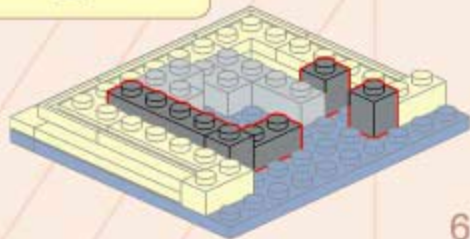

8

2x 6x

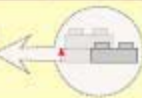

1:1

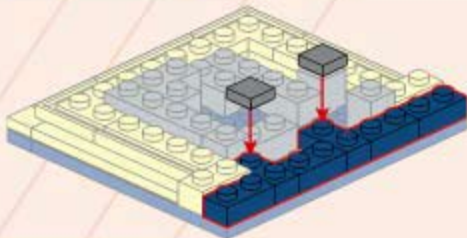

9

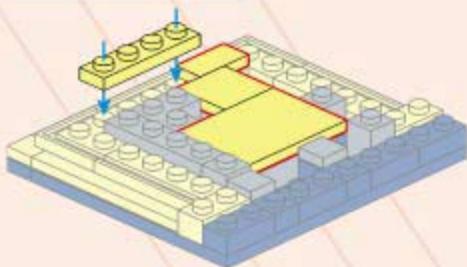
1x 3x4 1x  
1x 1x

10

2x 2x8 4x

2x

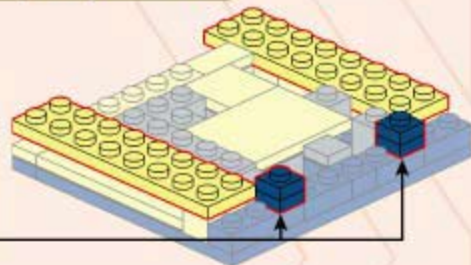

11

8x



1:1

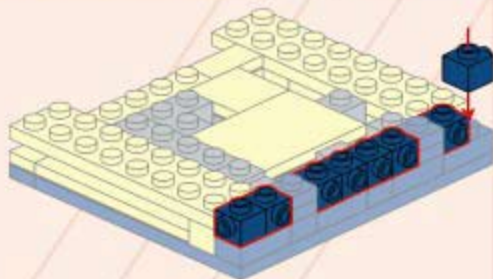



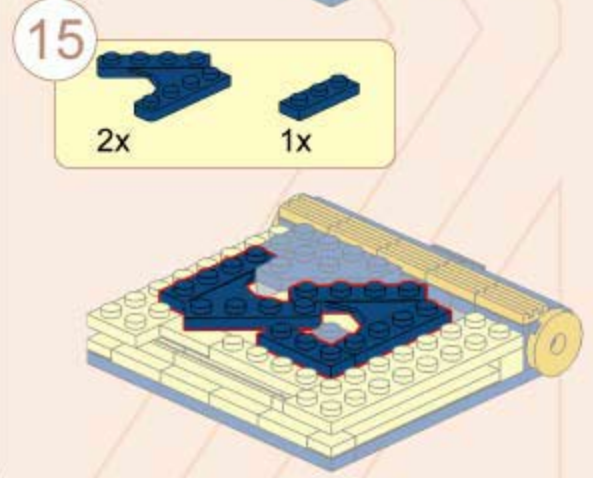
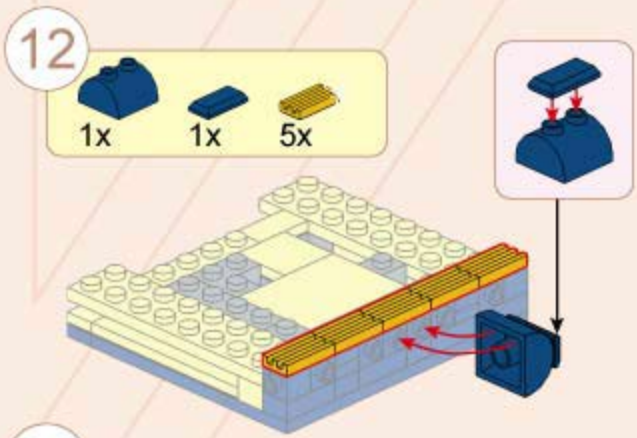

16

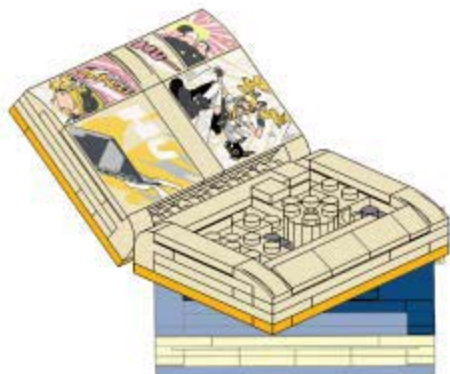
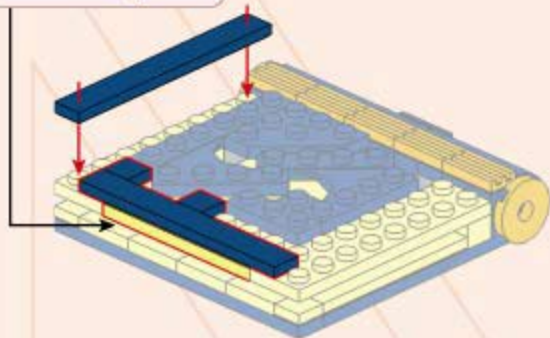
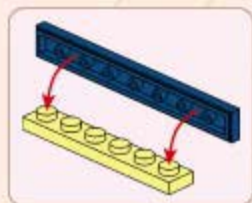
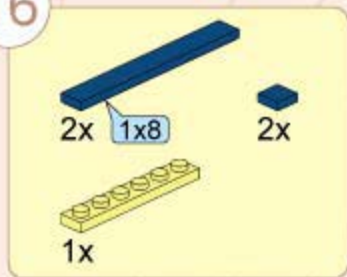

17

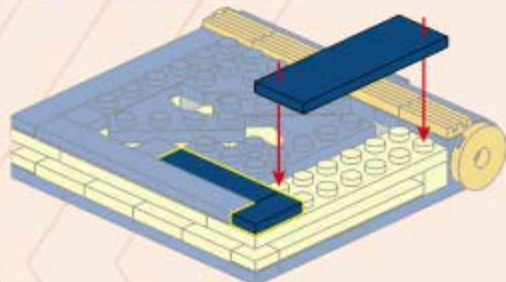
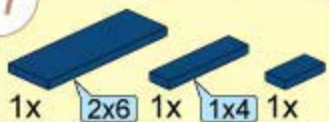

18

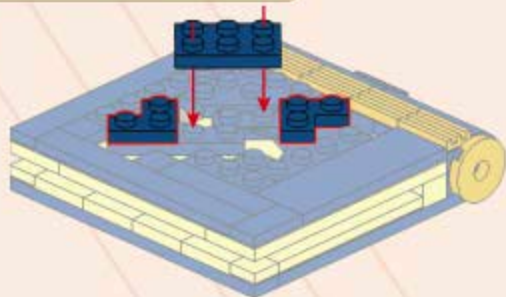

19

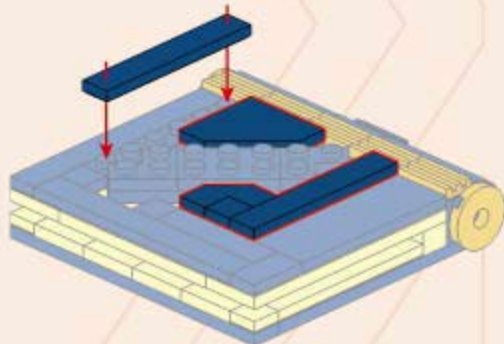
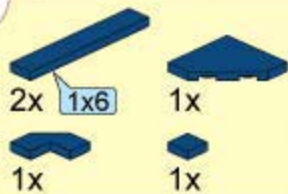



20



1x



1x

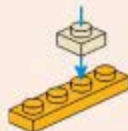

21



1x



1x



1x

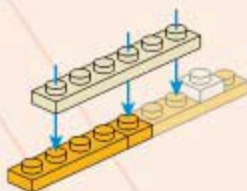

22



1x



1x



1x

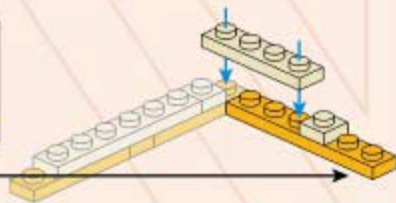
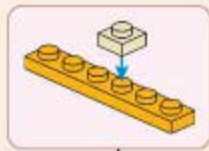

23



1x

6x8



1x



24

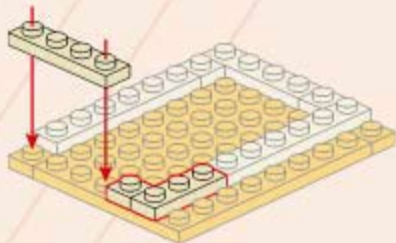
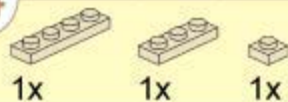

25

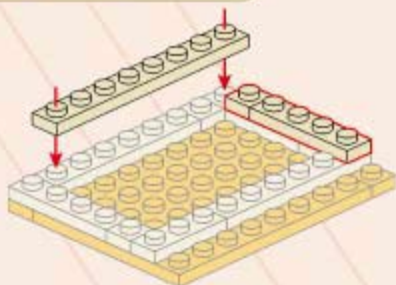
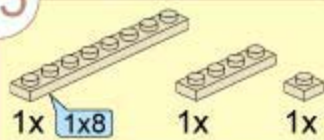

26

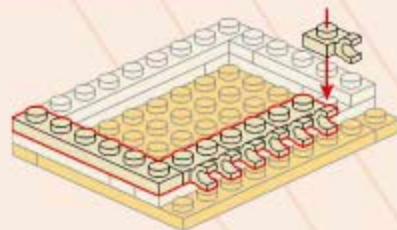
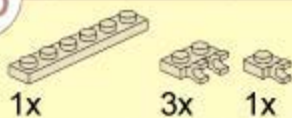

27

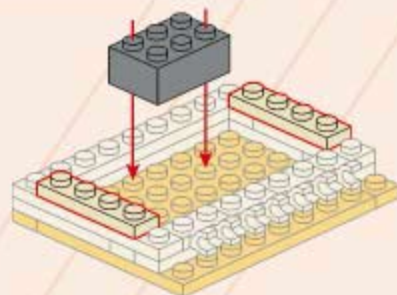
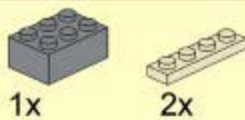

28

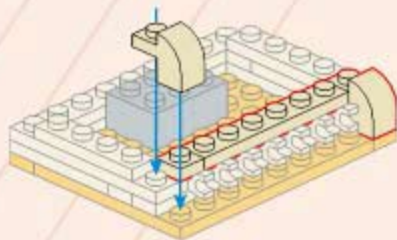
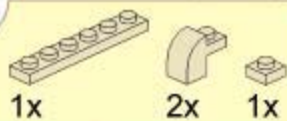

29

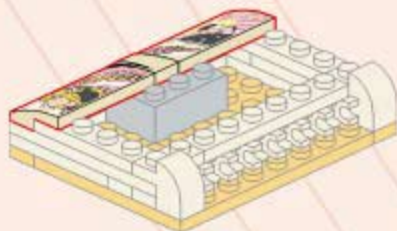
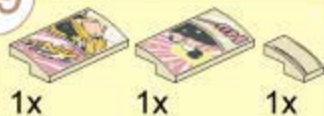

30

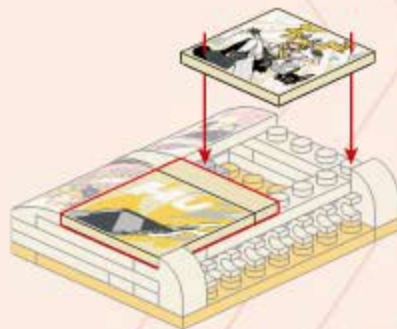
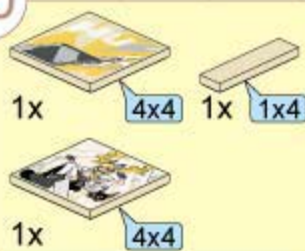

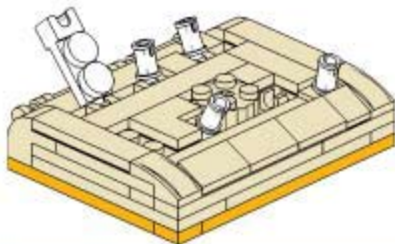

33

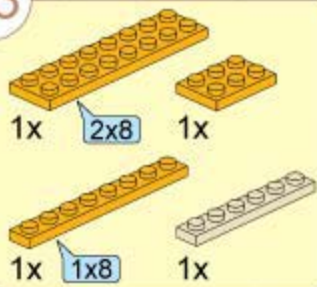

31

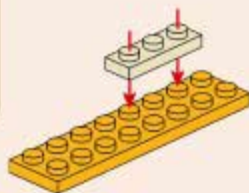
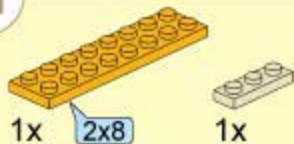

32

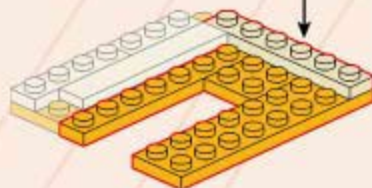
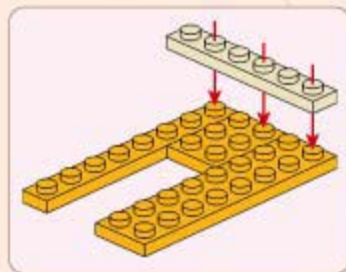
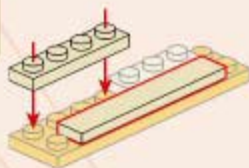
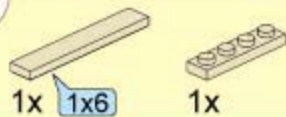

34



1x

2x

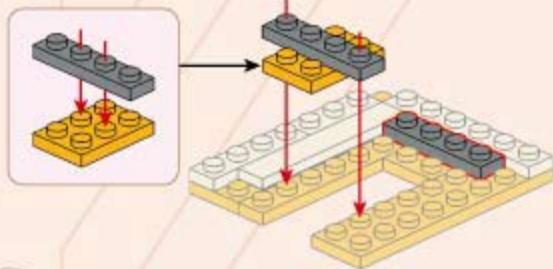

35



1x

1x

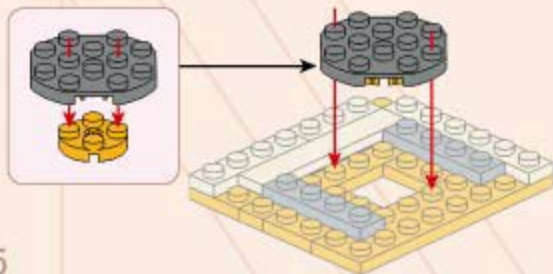

36



1x

1x



1x

1x

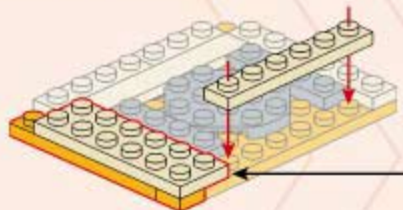
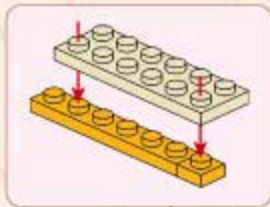

37



2x

2x





38

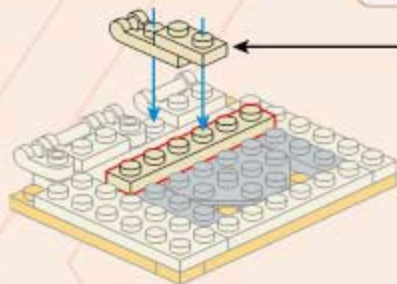
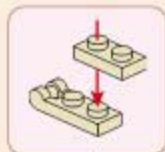
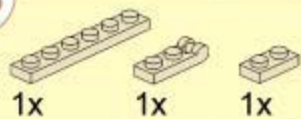

39

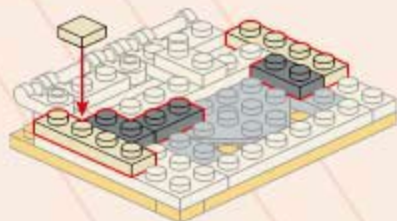
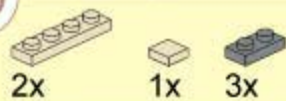

40

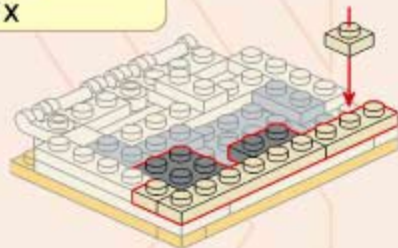
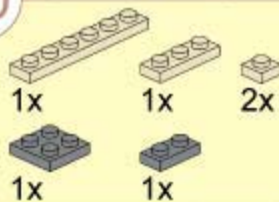

41

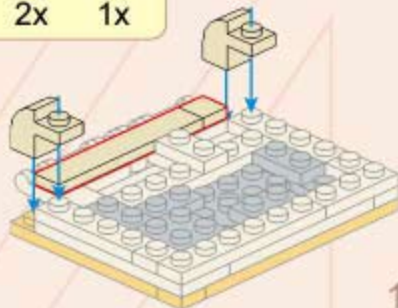
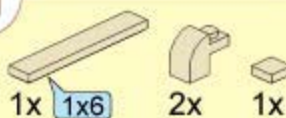

42

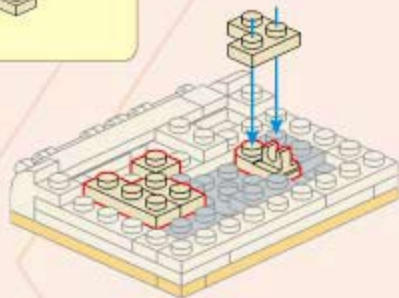
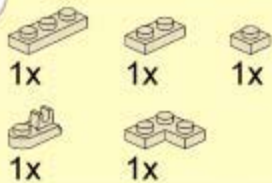

43

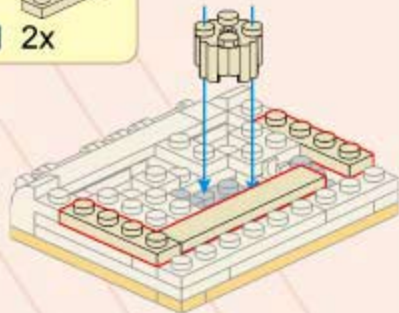
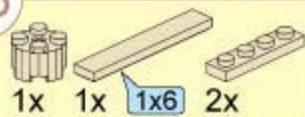

44

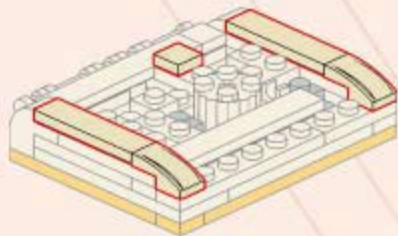
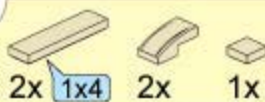

45





+



1x

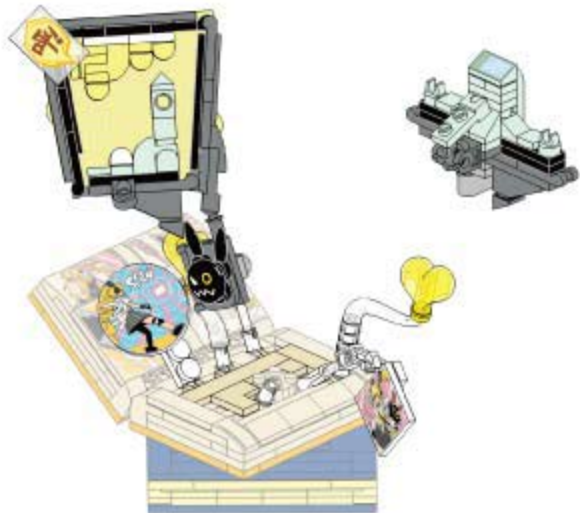

46



4x



4x

1

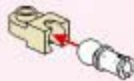

2



4x

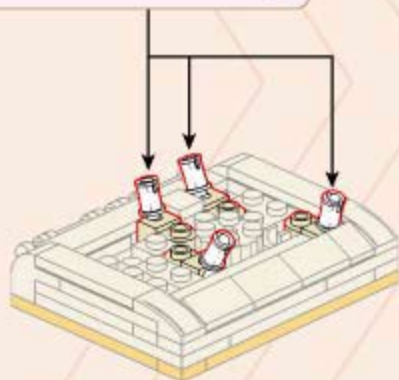

47

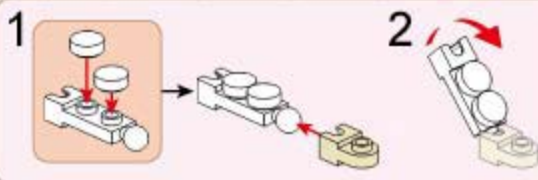
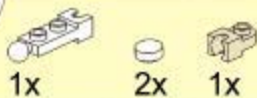

48

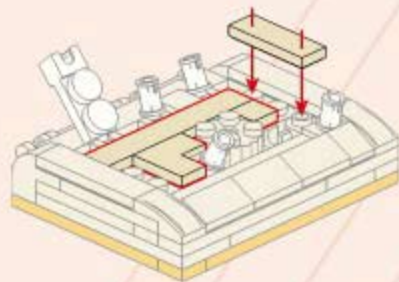
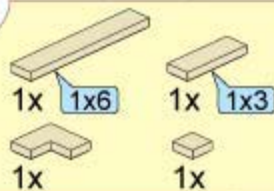

49

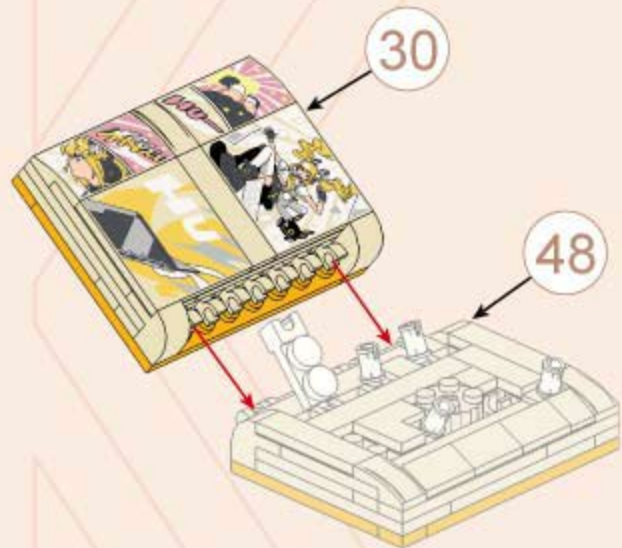

50

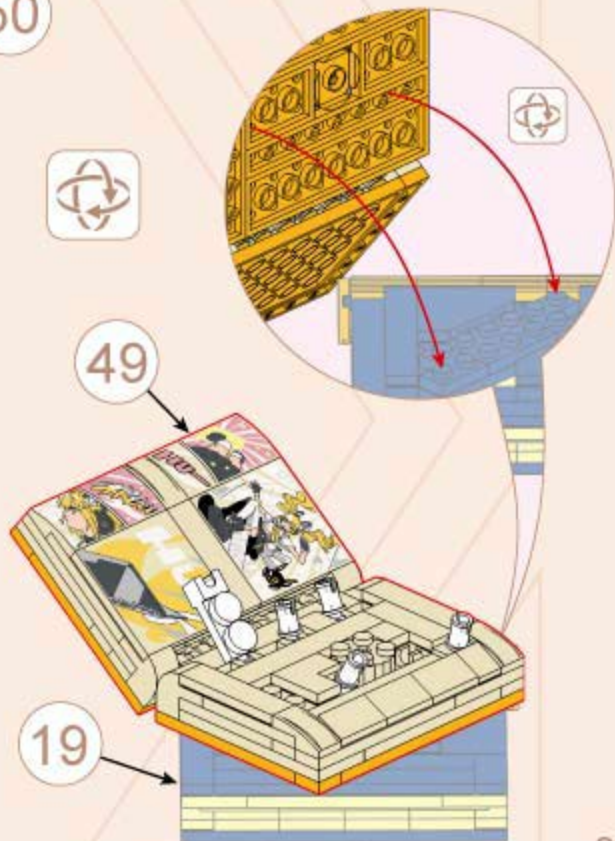

51

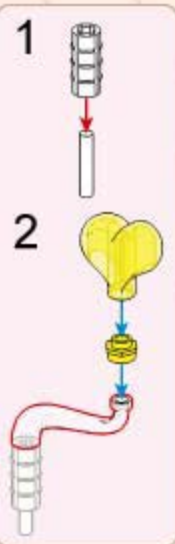
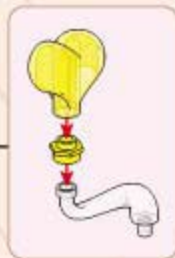
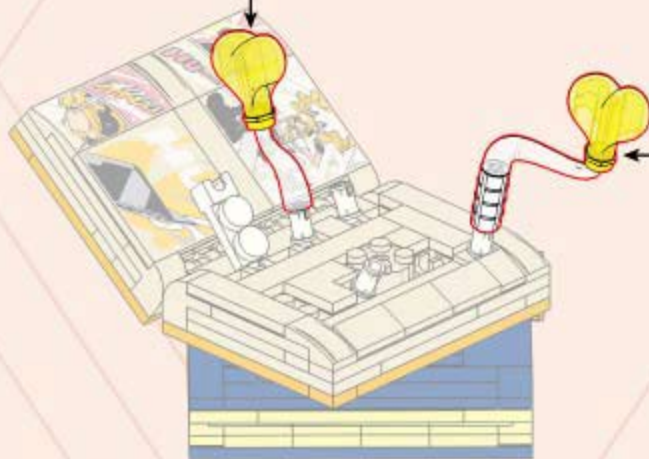

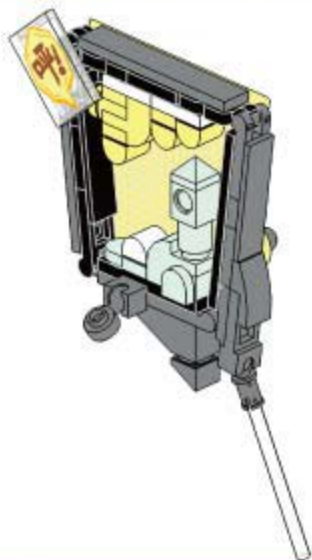

53



1x

1x



54

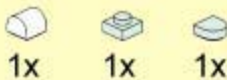

1x

1x

1x



55

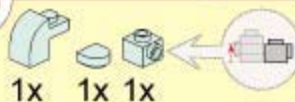

1x

1x

1x



1:1

52



1x

1x

1x

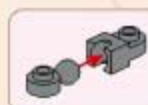

1

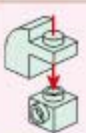

2

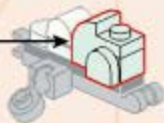

56



1x



1x



1x

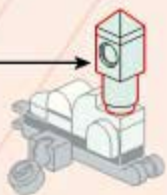
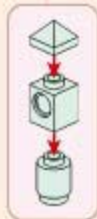

57



1x



1x



1x

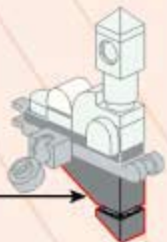
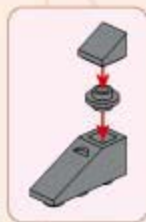

23

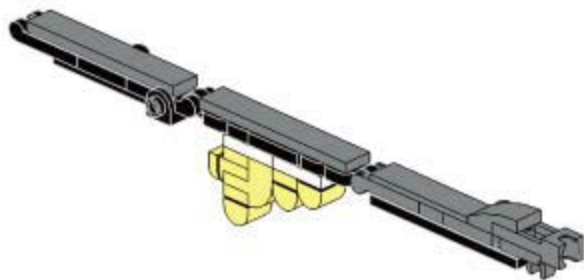

58



1x



1x



59



2x



1x





60

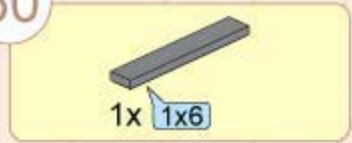

61

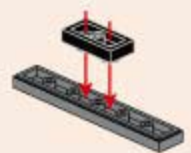
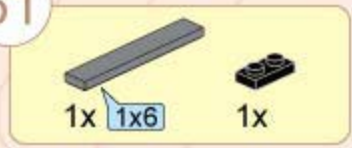

62

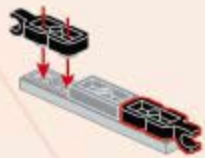

63

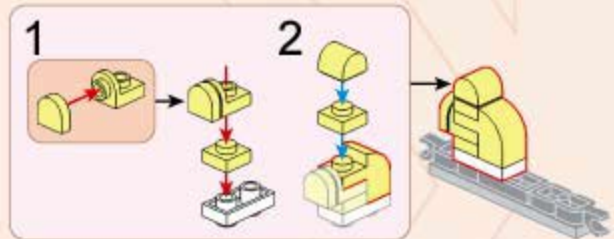
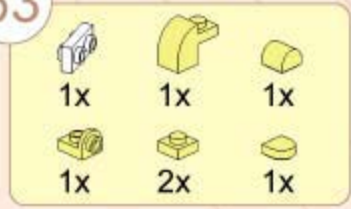

64



65

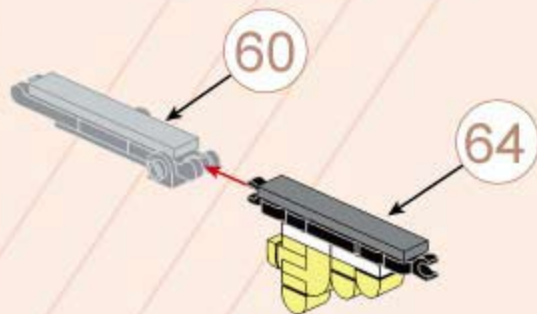

66

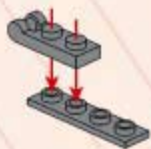

67

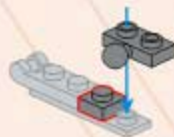

68

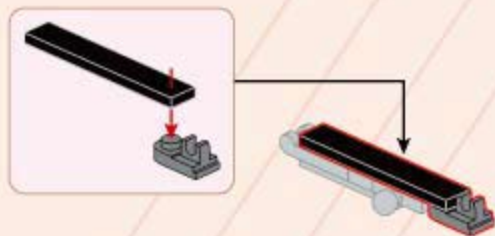

69

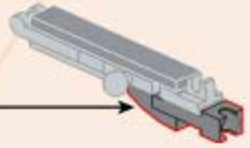
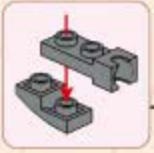
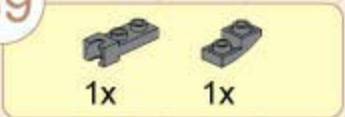

70

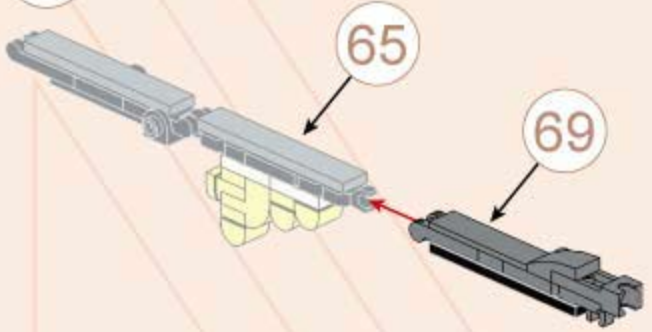

71

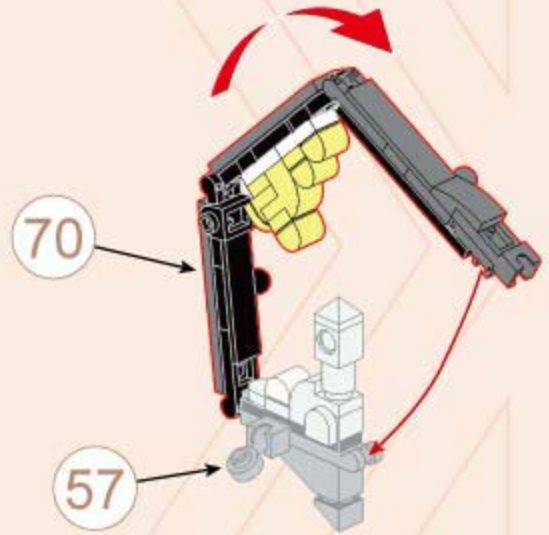

72

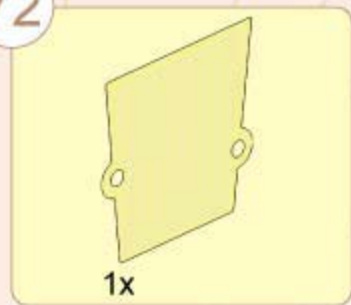

73

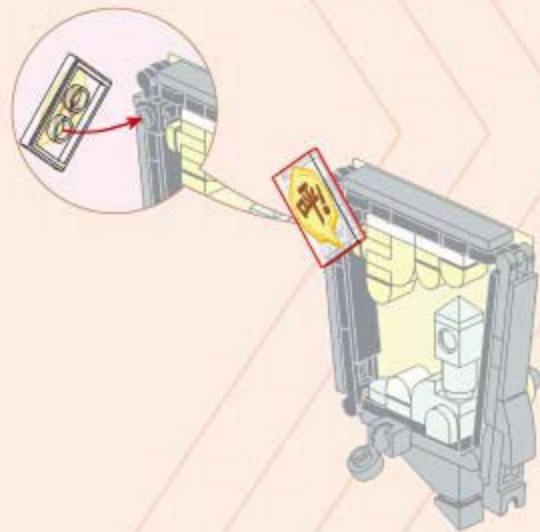
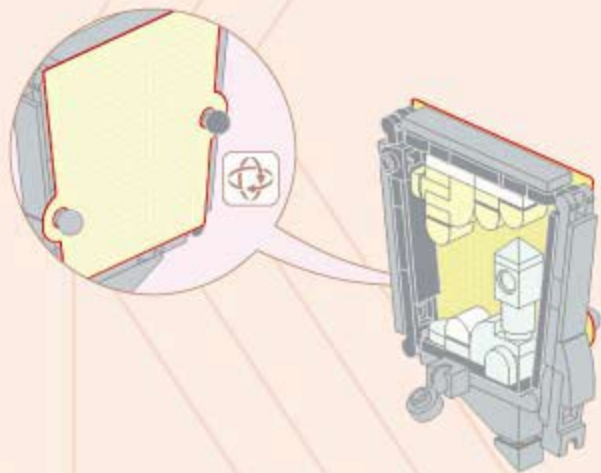

74

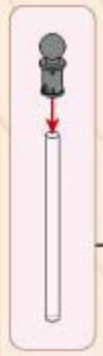
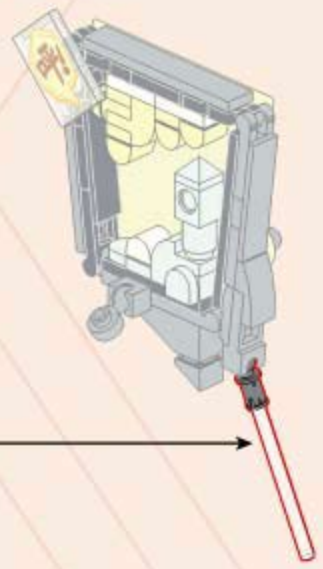
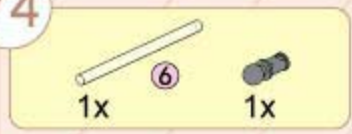

75

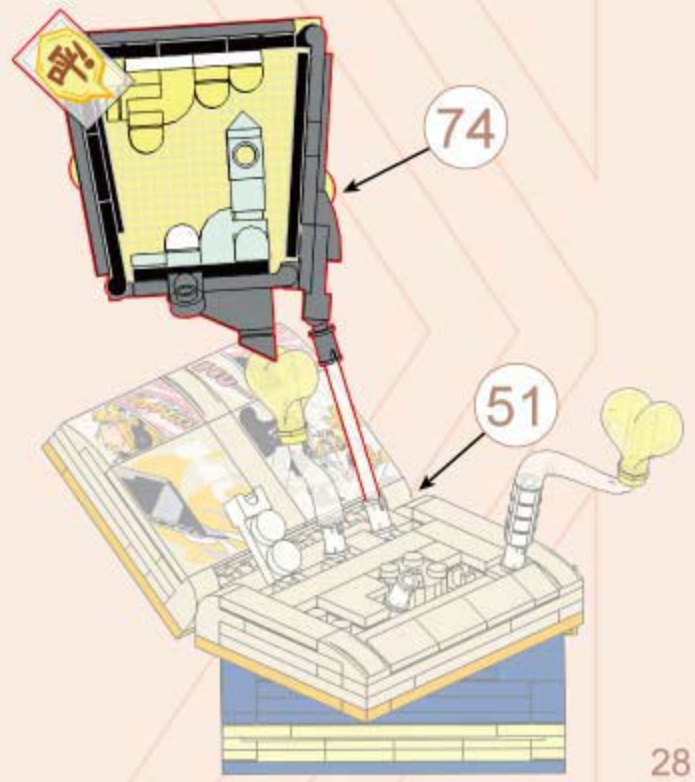



76



77



78



79

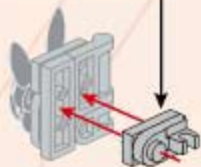
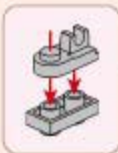

80

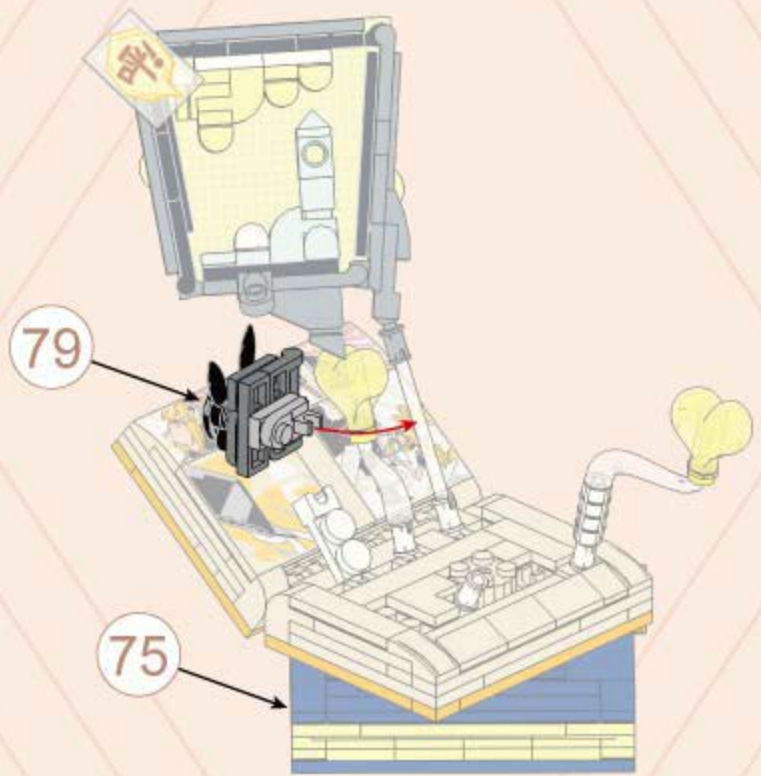

81

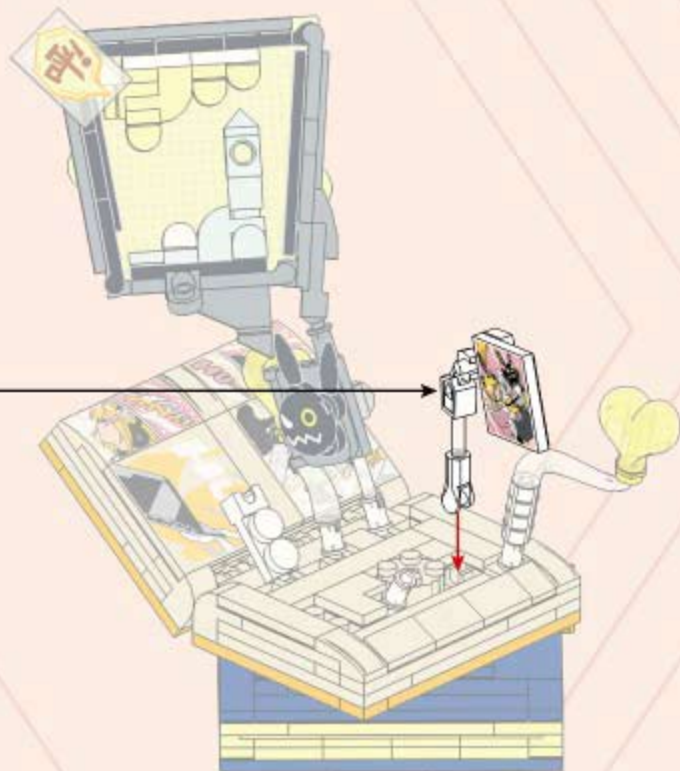
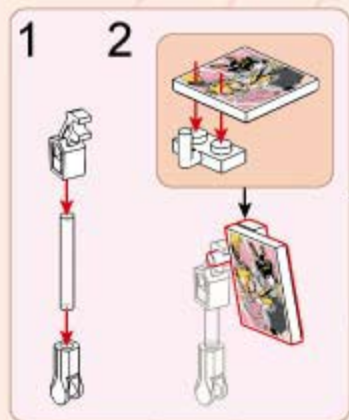



82



1x



1x



1x

1



2

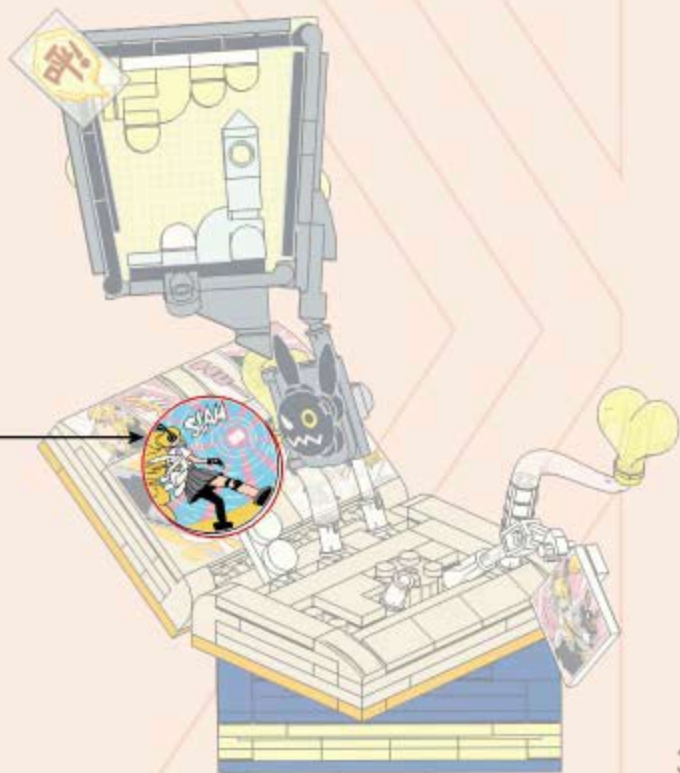
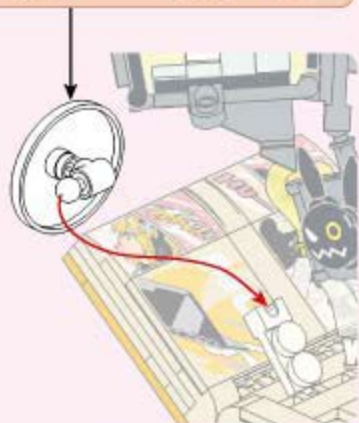

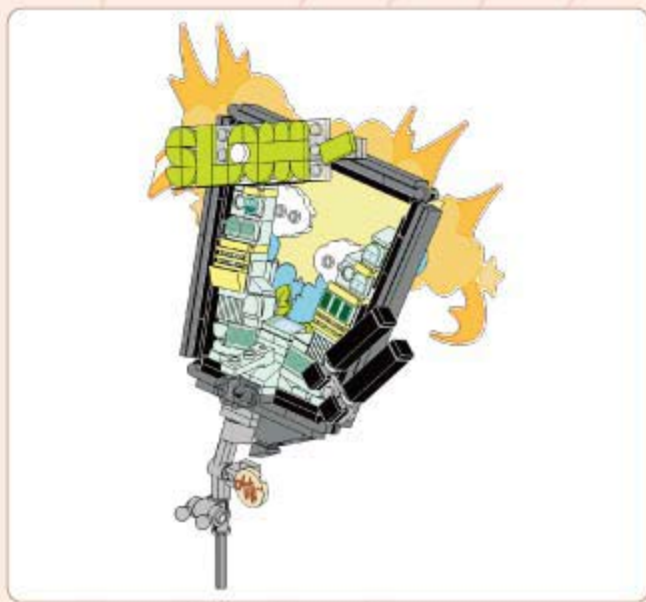

83

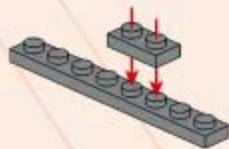

84

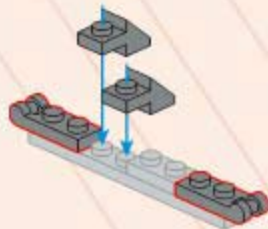

85

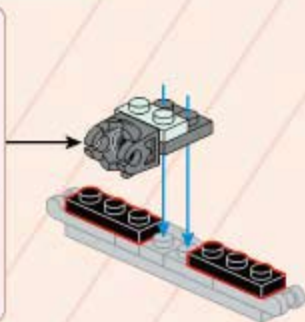
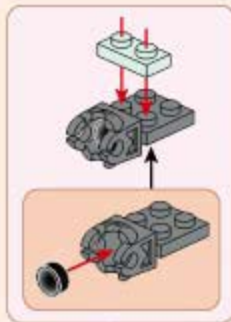
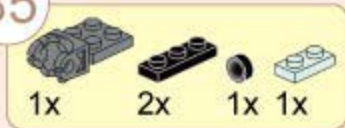

86

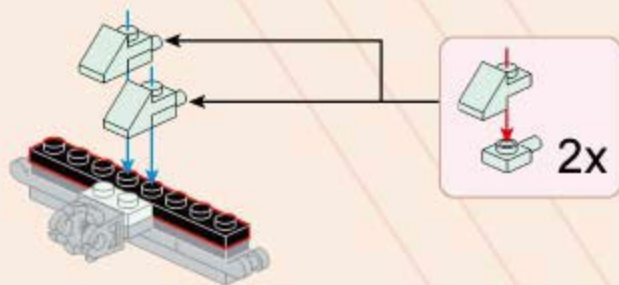
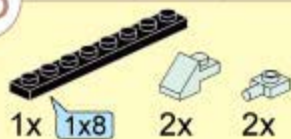

87

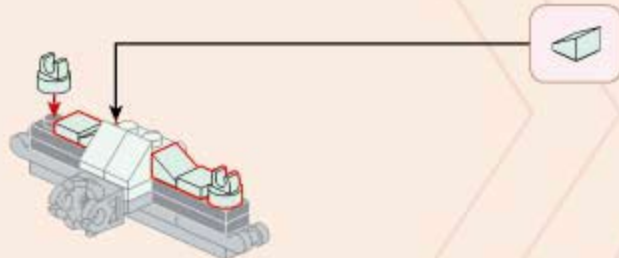

88

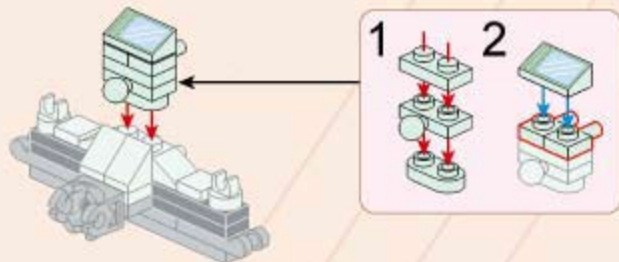
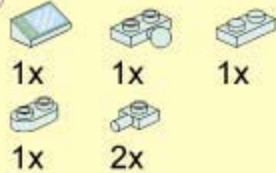

89



1x



2x



90



1x



1x



1x

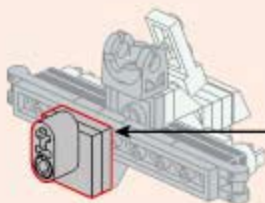

1



2

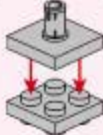

91



1x



1x



1x



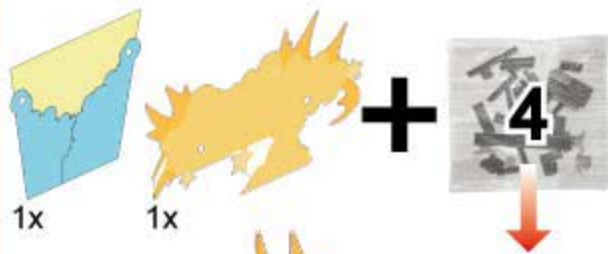

92



93

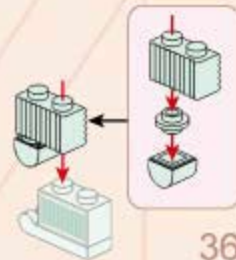
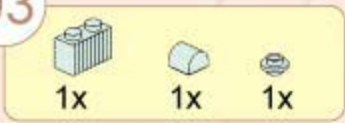

94

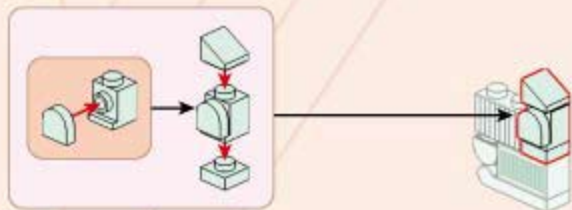

95

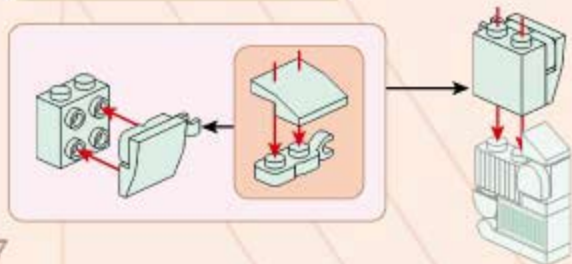
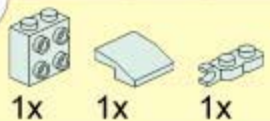

96



97

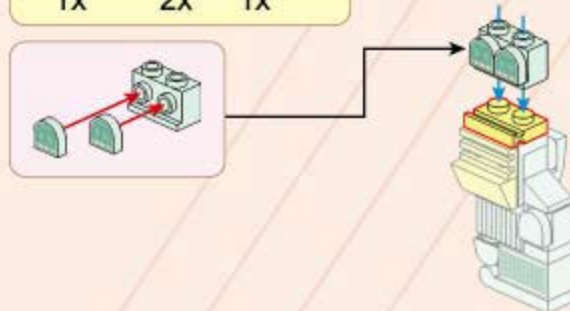

98



1x



1x

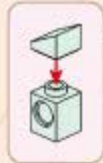

99



2x



1x



2x



1x

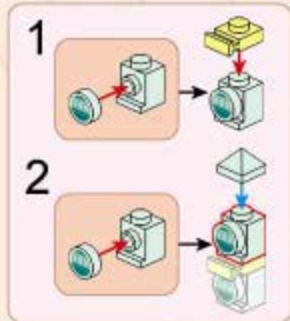

100



1x



1x



1x

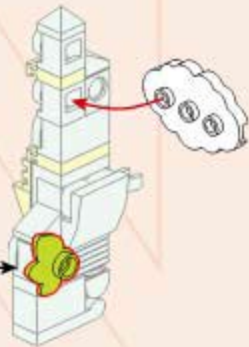
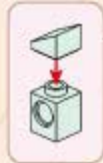

101

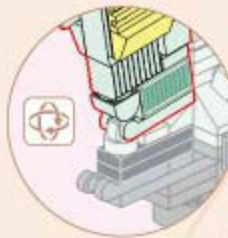

91

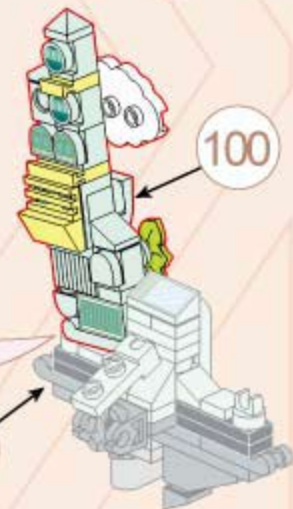



102



103

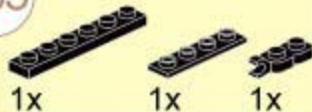

104

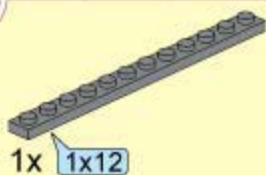

105

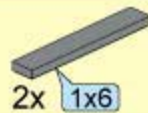

106

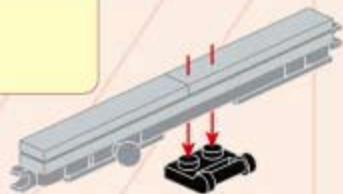



107

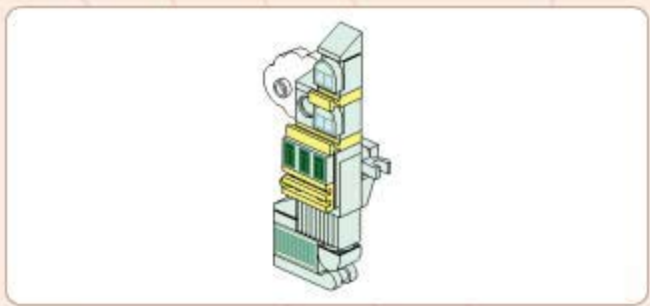
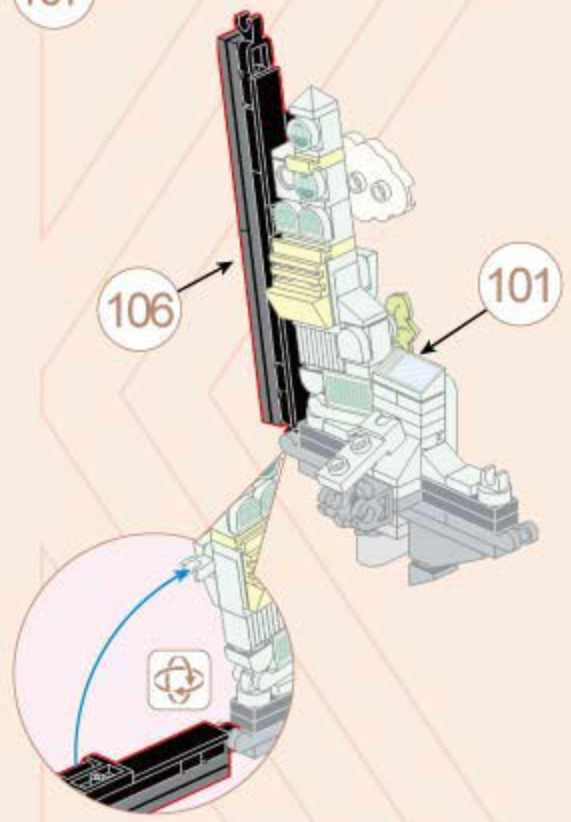

108

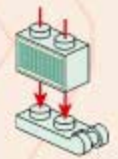
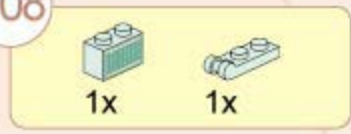

109

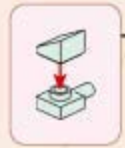
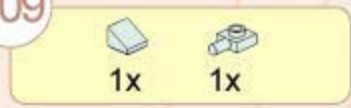

110



1x



1x



1x

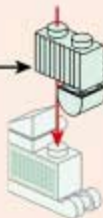
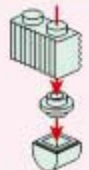

111



1x



1x



1x

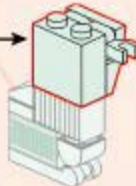

112



1x



1x



1x

1



2

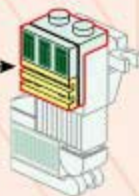

113



1x



1x



1x



114



1

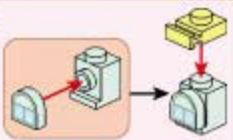

2

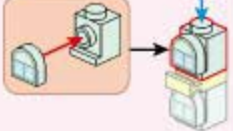

115

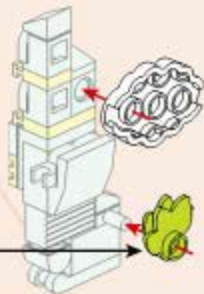

116

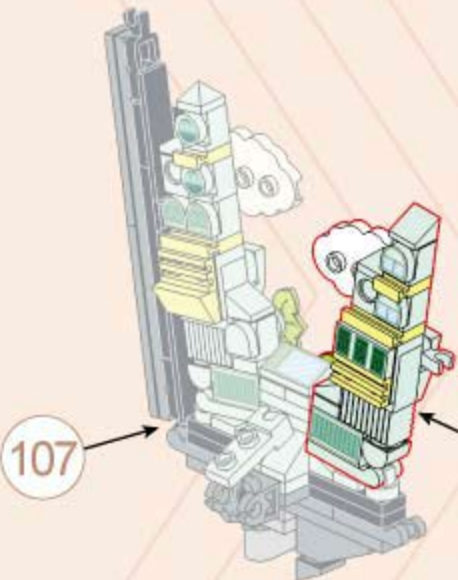



117



1x

1x

1x



118

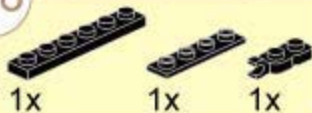

1x

1x

1x

43

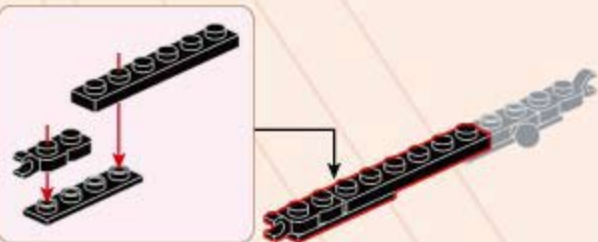

119

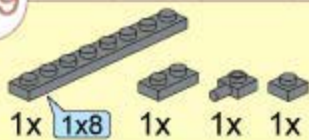

1x

1x8

1x

1x

1x

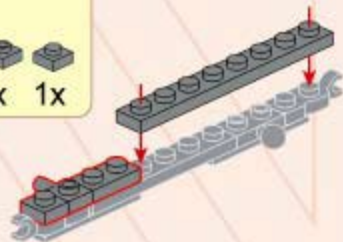

120

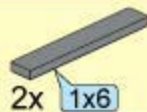

2x

1x6



121



1x

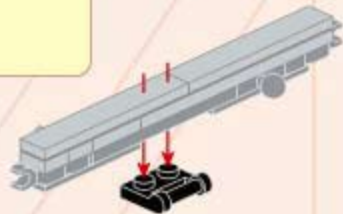

122

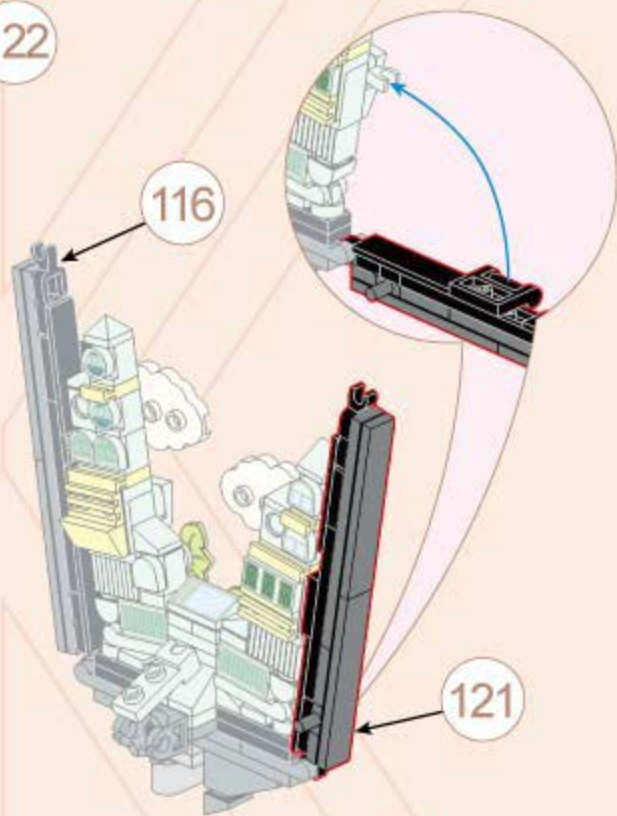

123

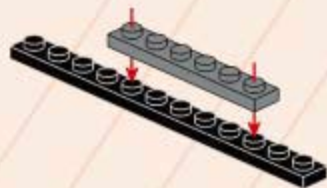
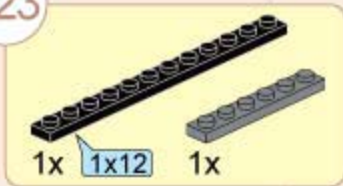

124



2x

1x

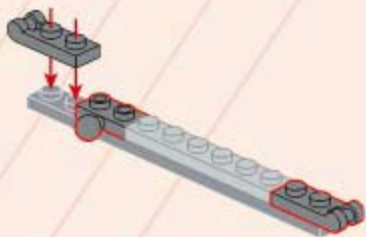

125



1x

1x8

1x

1x4

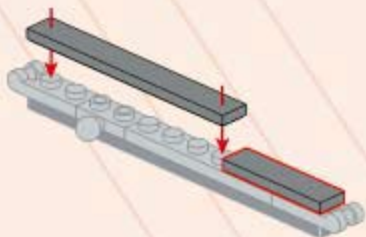

126

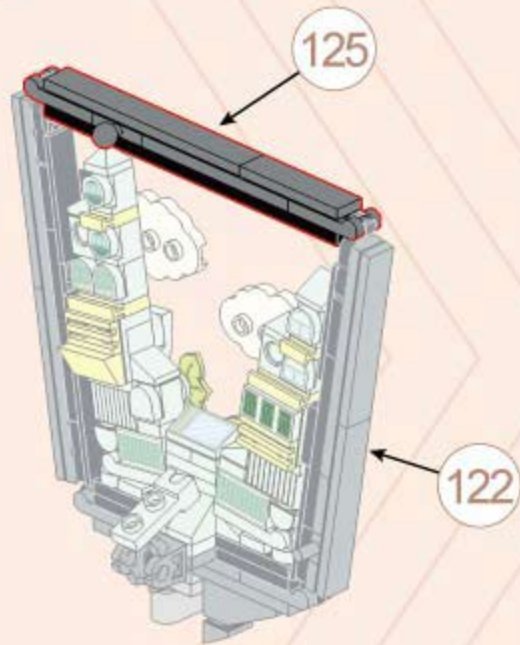

127

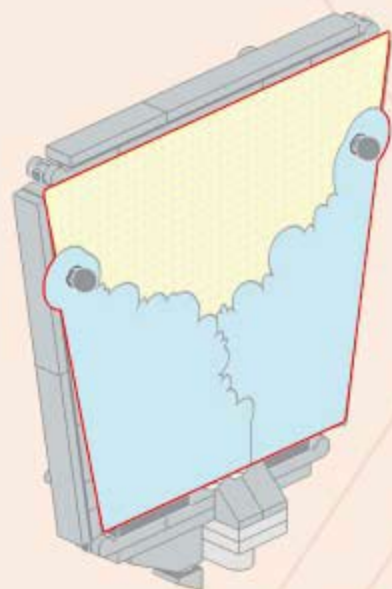

128



1x





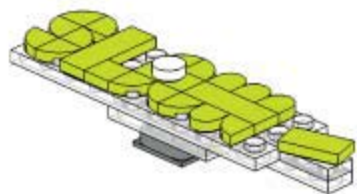

129

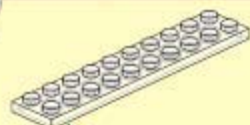

1x 2x10



1x



1x

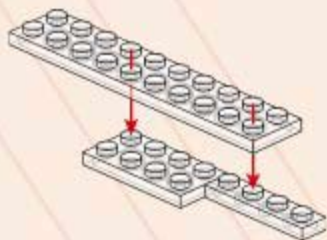

130



1x 1x10



3x

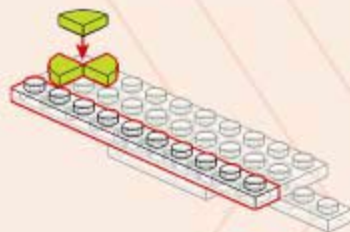

131



1x





1x



3x



132

- 1x 
- 4x 
- 1x 

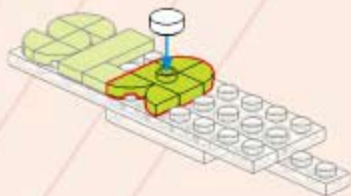



133

- 1x  1x3
- 4x 



134

- 1x 
- 1x 
- 2x 



135

- 1x 
- 1x 
- 1x 

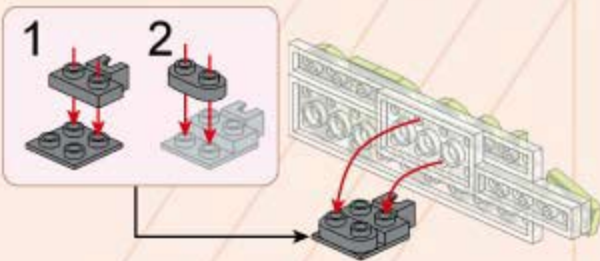

136

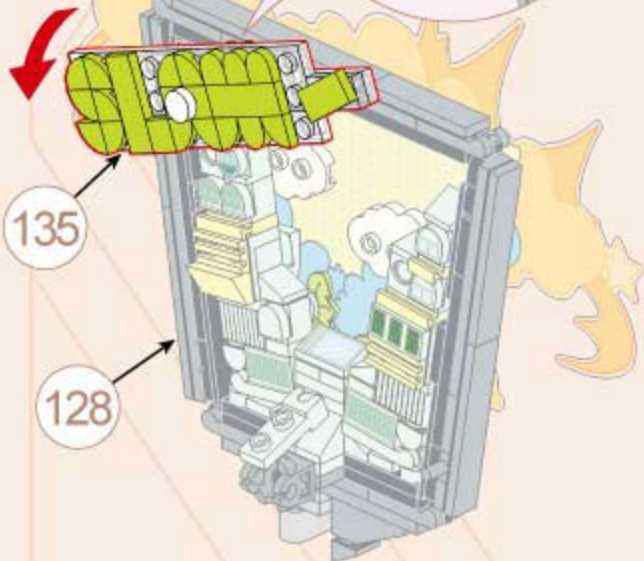

135

128

137



1x



1x

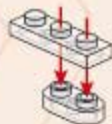

138



2x



2x



2x



139

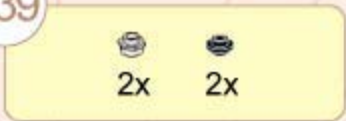

140

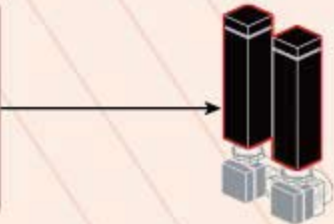
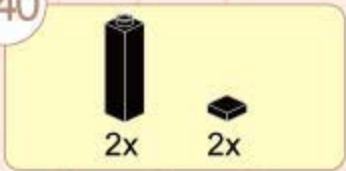

141

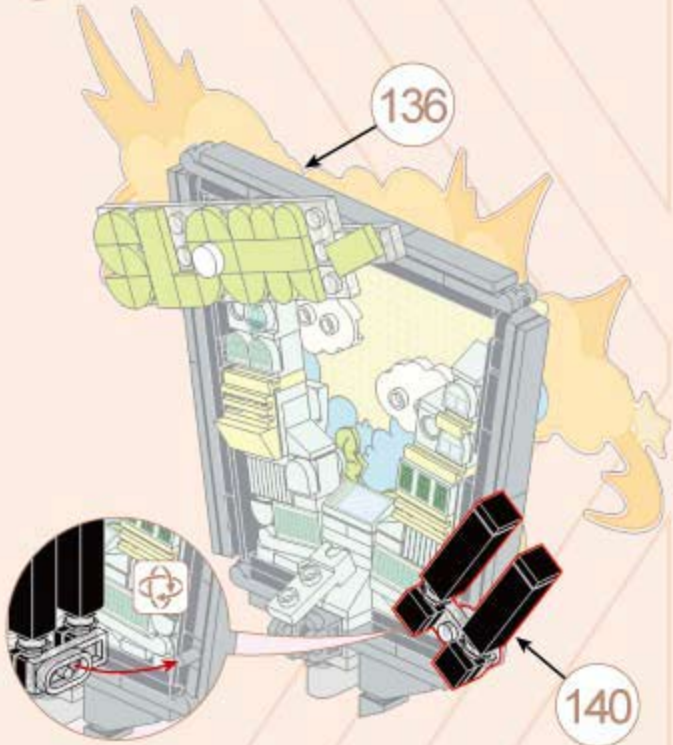

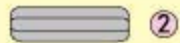

1:1

142



157°



2



1x



143

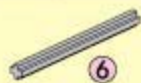

1x



144



1x



1x



145

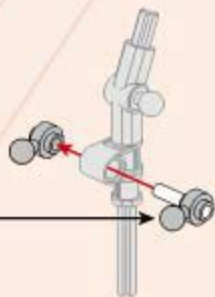

146

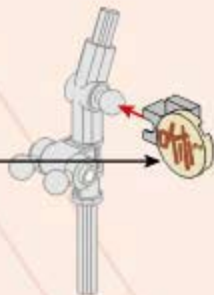

147



141

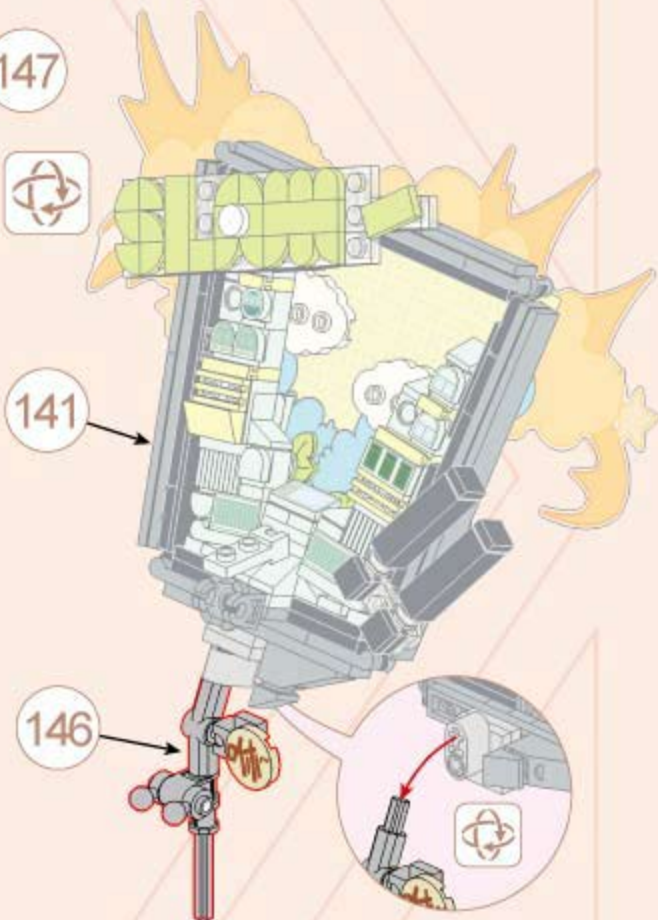

146

148

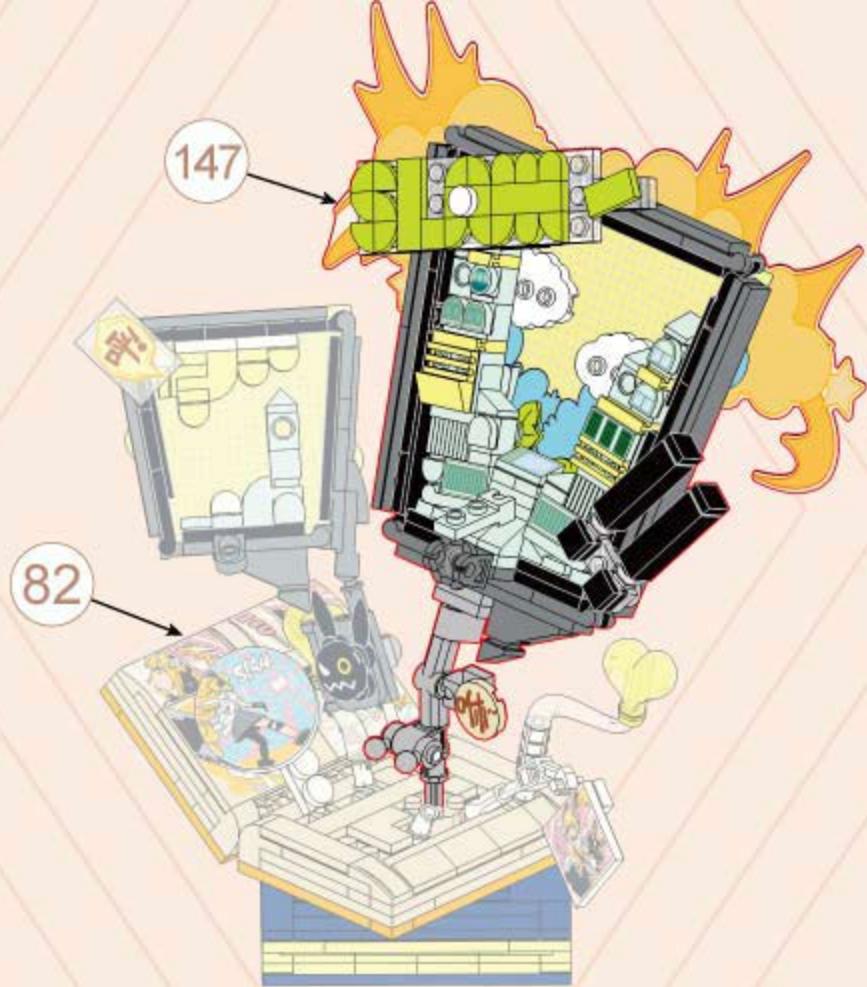



149



1x



1x





150



1x

1x

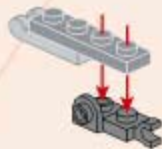

151



1x

1x

1x

1x

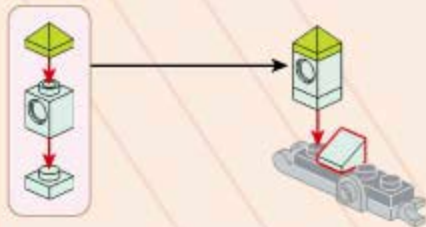

152



1x

1x

2x

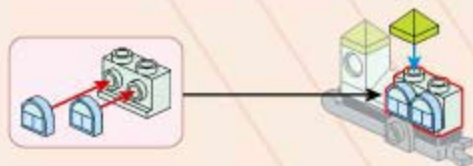

153



1x

1x

1x

1x

1x

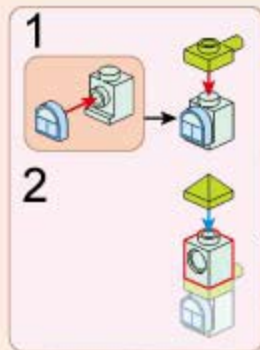

154



1x



1x



1x

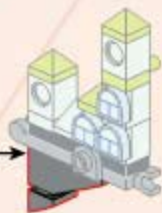
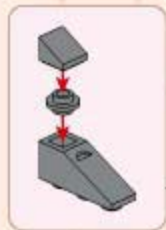

155



1x

2x4



156



1x



4x

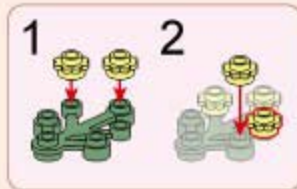



157



1x

1x

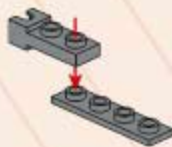

158



1x

1x

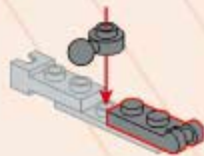

159



1x

1x4

1x

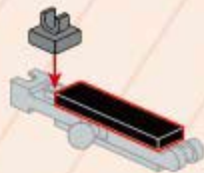

160

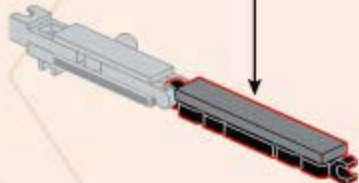
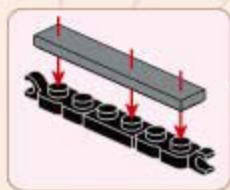

161



162



163

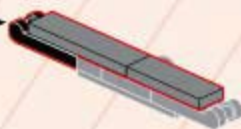
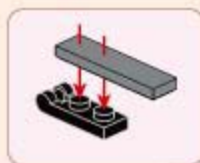
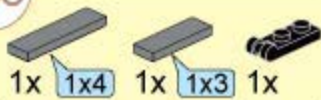

164

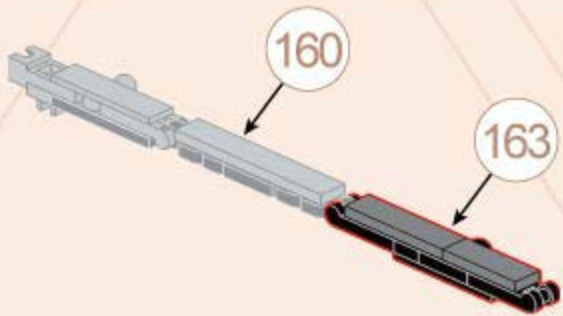

165



166



1x

4



1x

167



1x

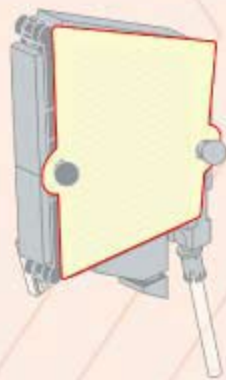
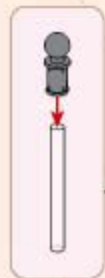

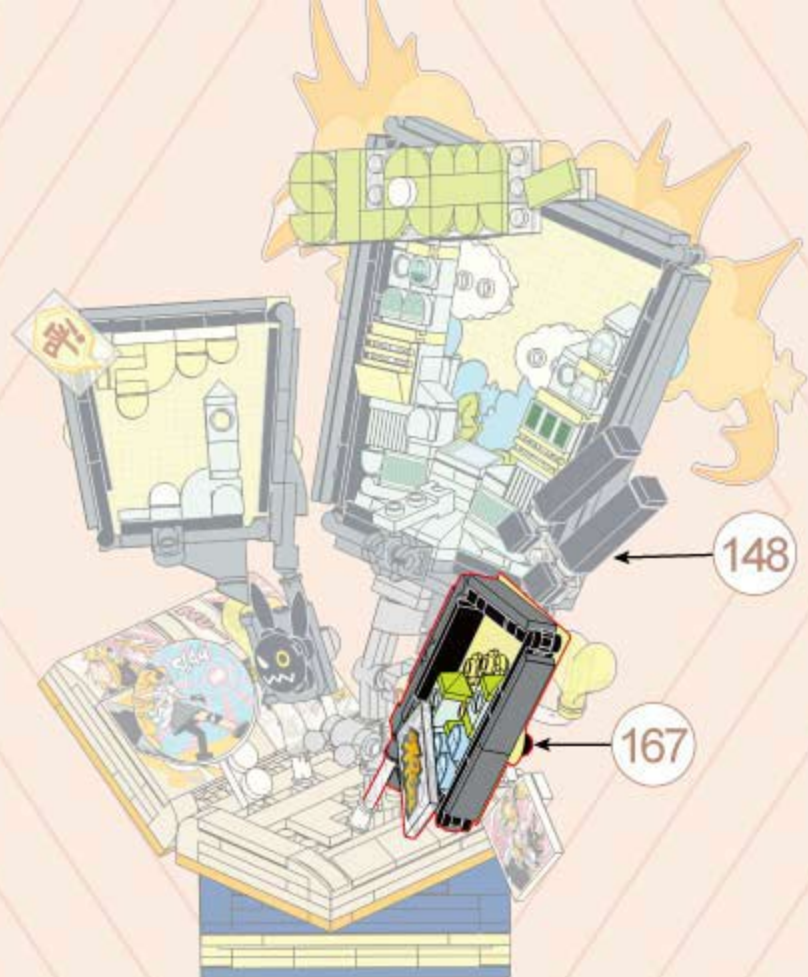

148

167

169



1x





170



1x



1x

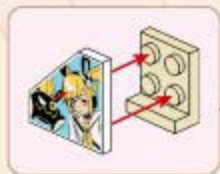



171



4x



1x



2x

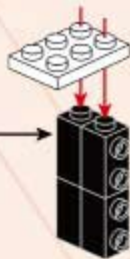

172



2x



1x



1:1



173



2x



1x



1:1



174

173

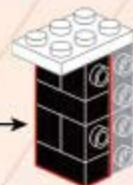

171



175



1x

1x



2x



1x

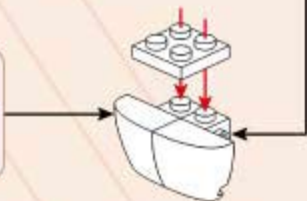
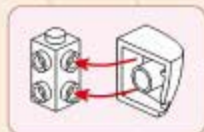
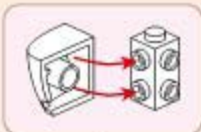

176



1x



1x



1x



1x

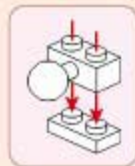

177

176

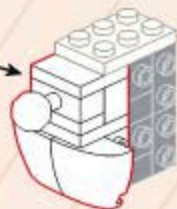

174



178

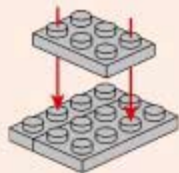
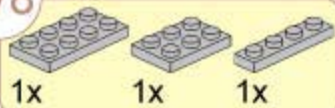

179



180

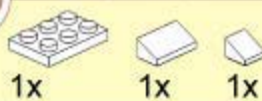

181

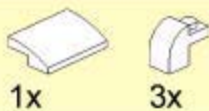

182



181

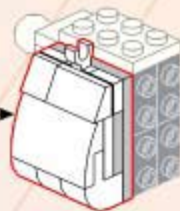

177

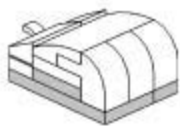

183

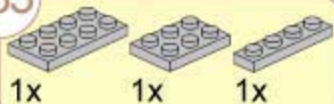

184

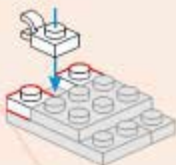

185

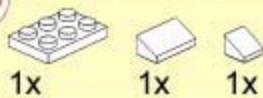

186

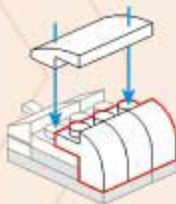

187



182



186

188



1x



2x



1x



189



1x



1x



1x



1x



2x



1x

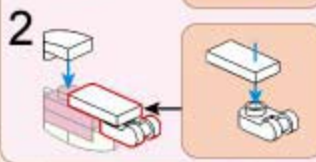
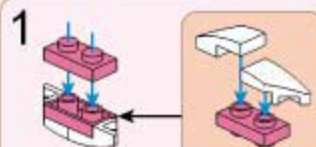

190



1x



1x



1x



2x



1x



1x

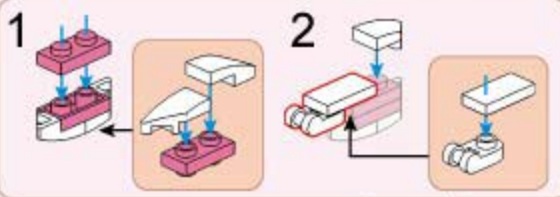

191

170

190

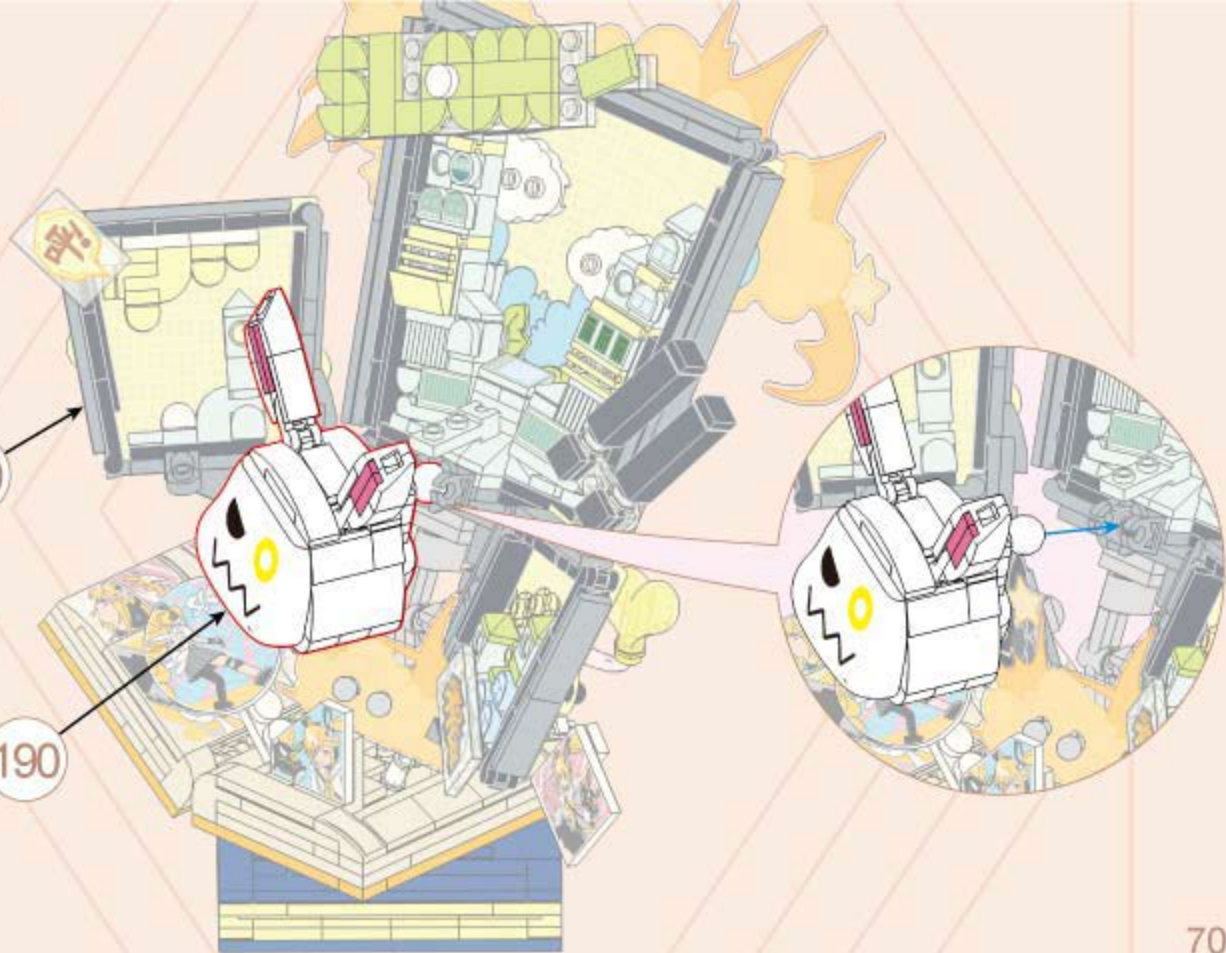



©2023 Tencent. All Rights Reserved.

腾讯公司 版权所有

V1.0