

QMAN LIGHTEN THE DREAM

UNLIMITED IDEAS

DILEMMA WEAPON



FORM NUMBER 2



FORM NUMBER 3



4802 | Ages:6+ | PCS:232

Pictures are for your reference only. The delivered goods shall prevail.

1

MAIN FORM



3IN1
Transforms



1

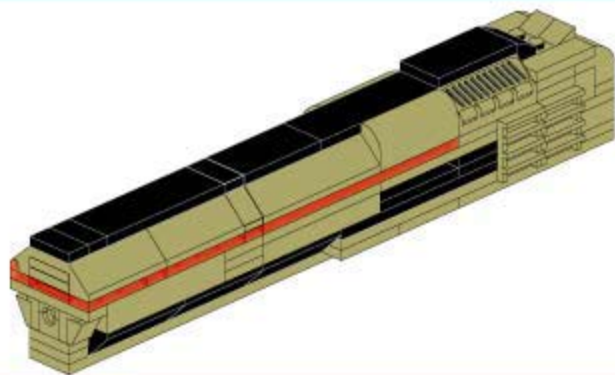

A1

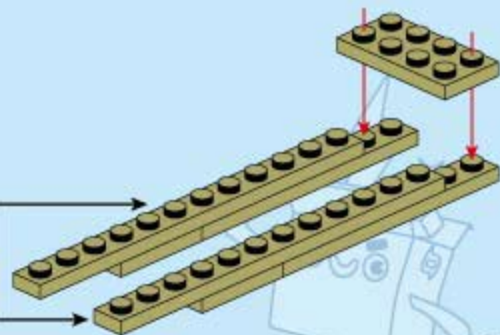
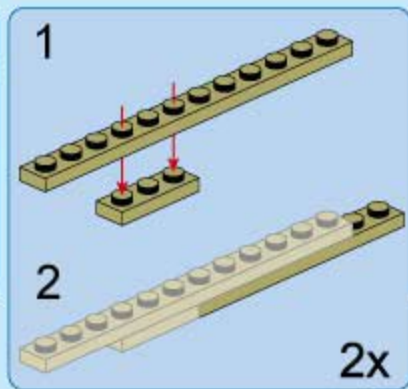
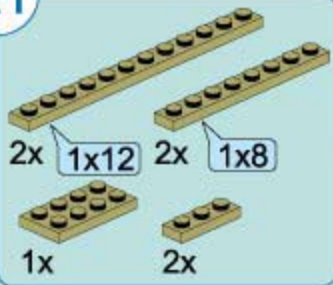

2

A2



2x

A3

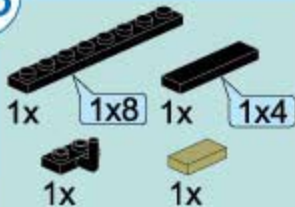

A4

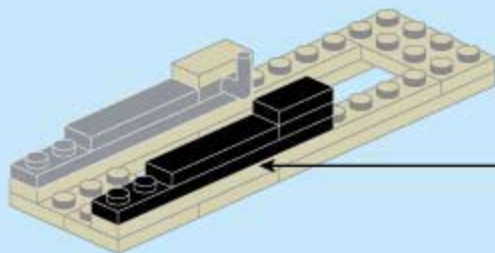
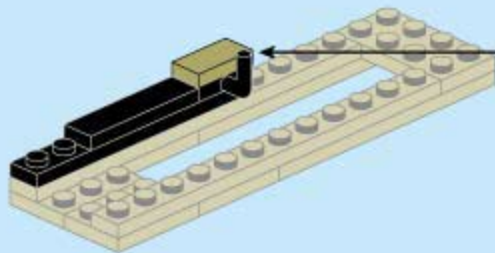
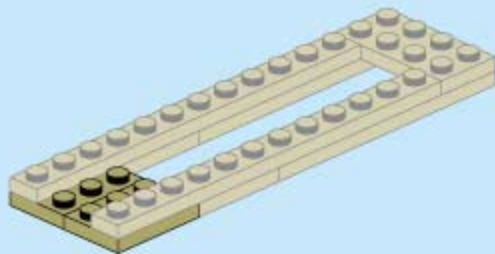
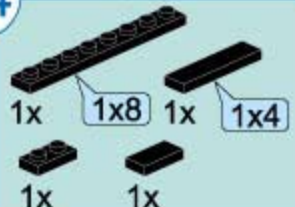

1

2

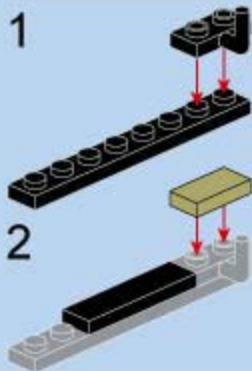

1

2

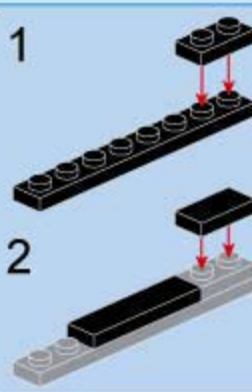

A5

1x 2x10
1x 2x8
1x [yellow 2-hole Technic brick with axle hole]
2x [black 2-hole Technic Technaxel]
1x [yellow 1-hole Technic Technaxel]
4x [yellow 1-hole Technic Technaxel]
3x [yellow 1-hole Technic Technaxel]

1

2

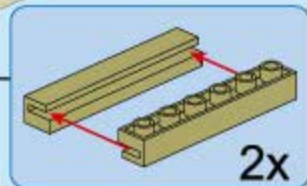
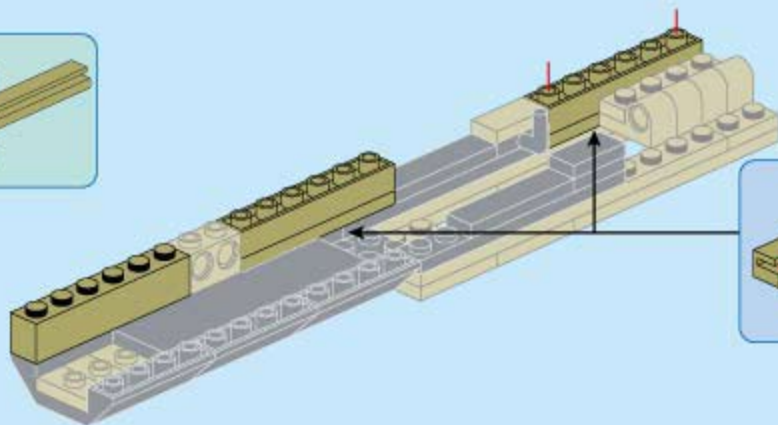
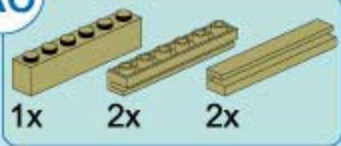
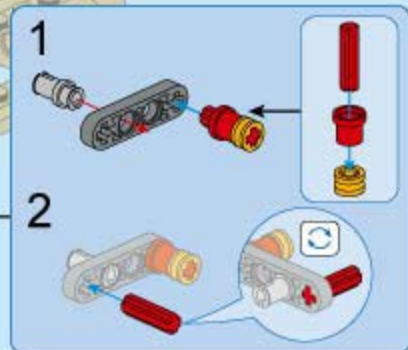
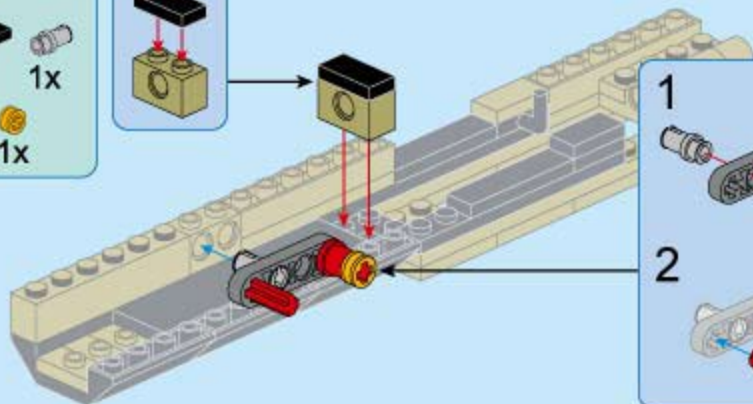
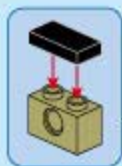

A6**A7**

A8

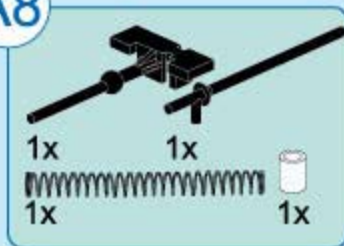

○注意拼搭顺序

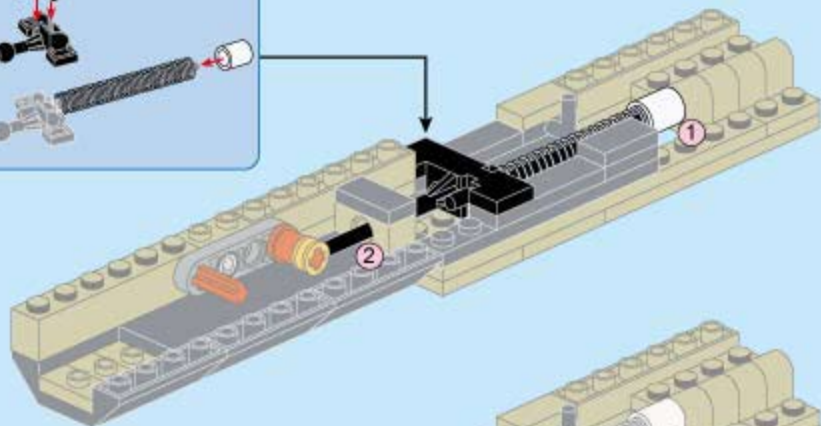

A9

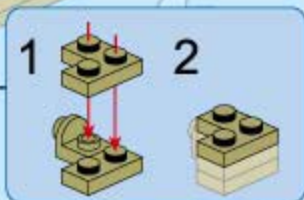
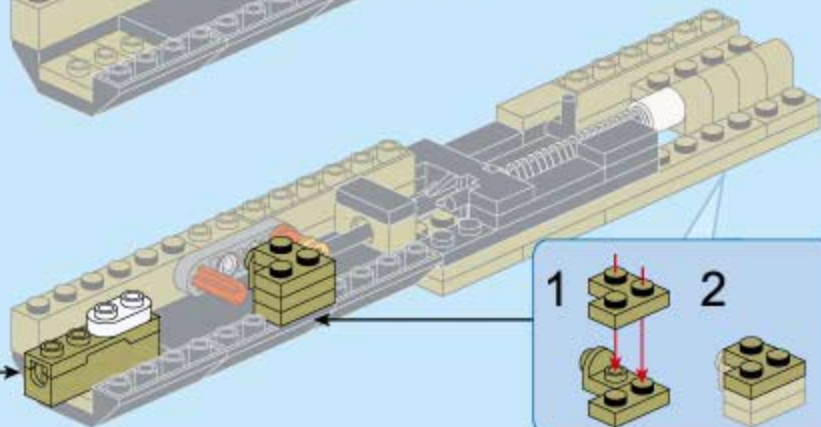
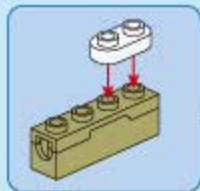
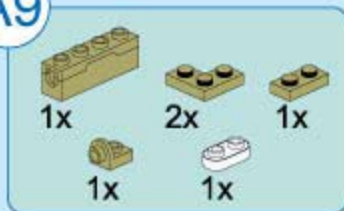

A10

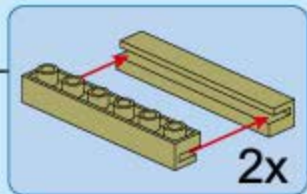
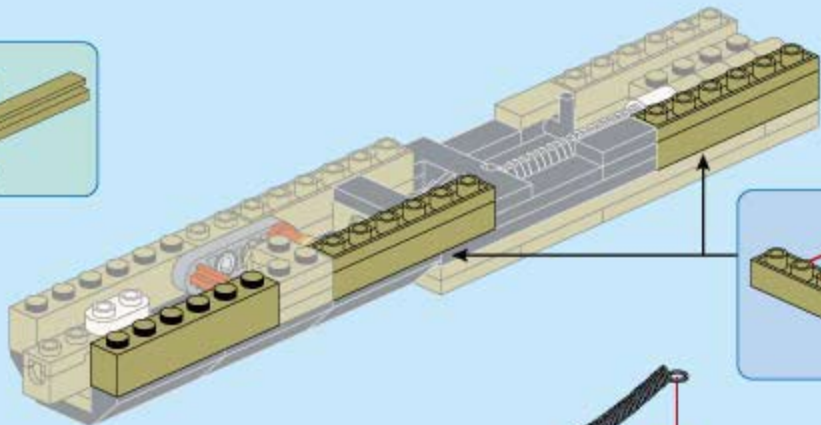
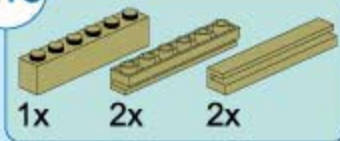

A11

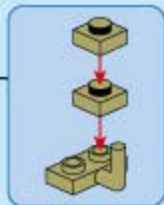
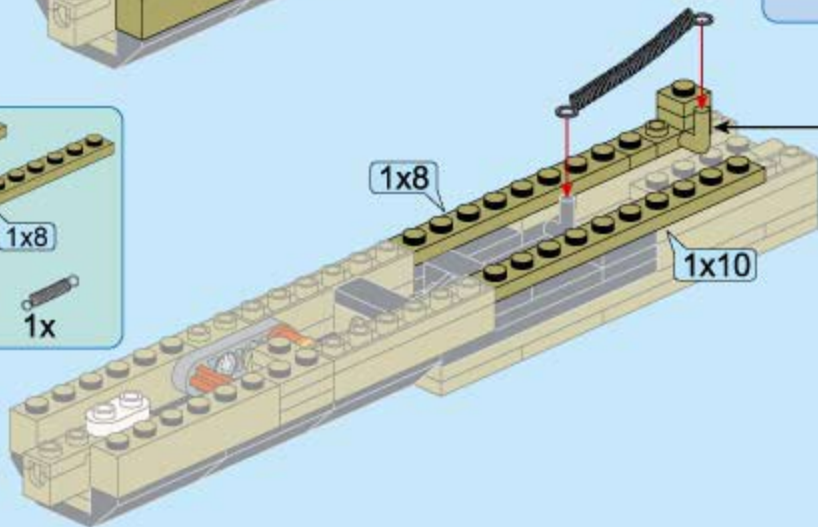
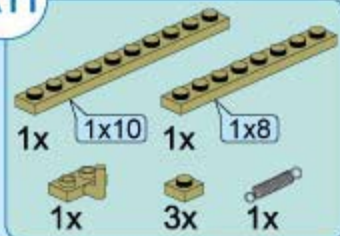

A12

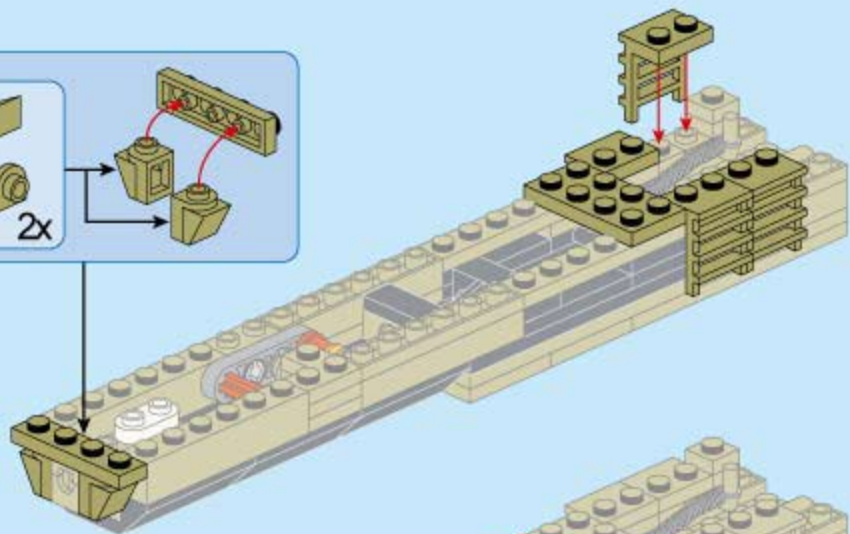
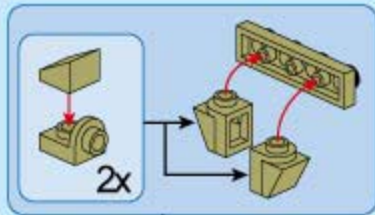
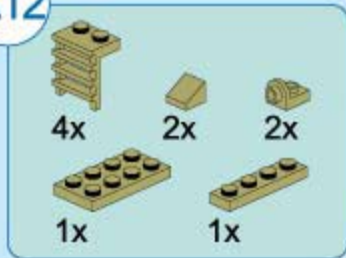

A13

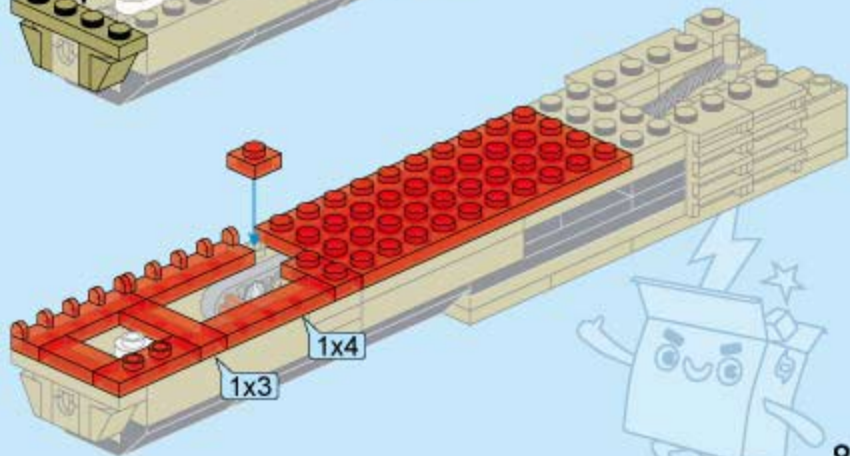
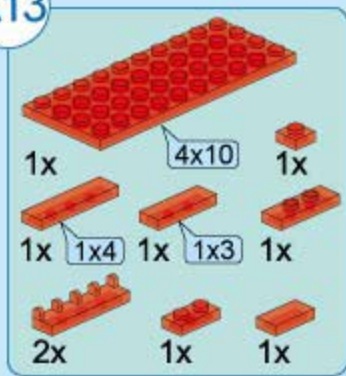

A14

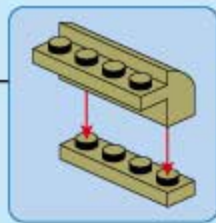
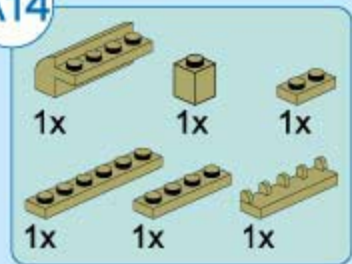

A15

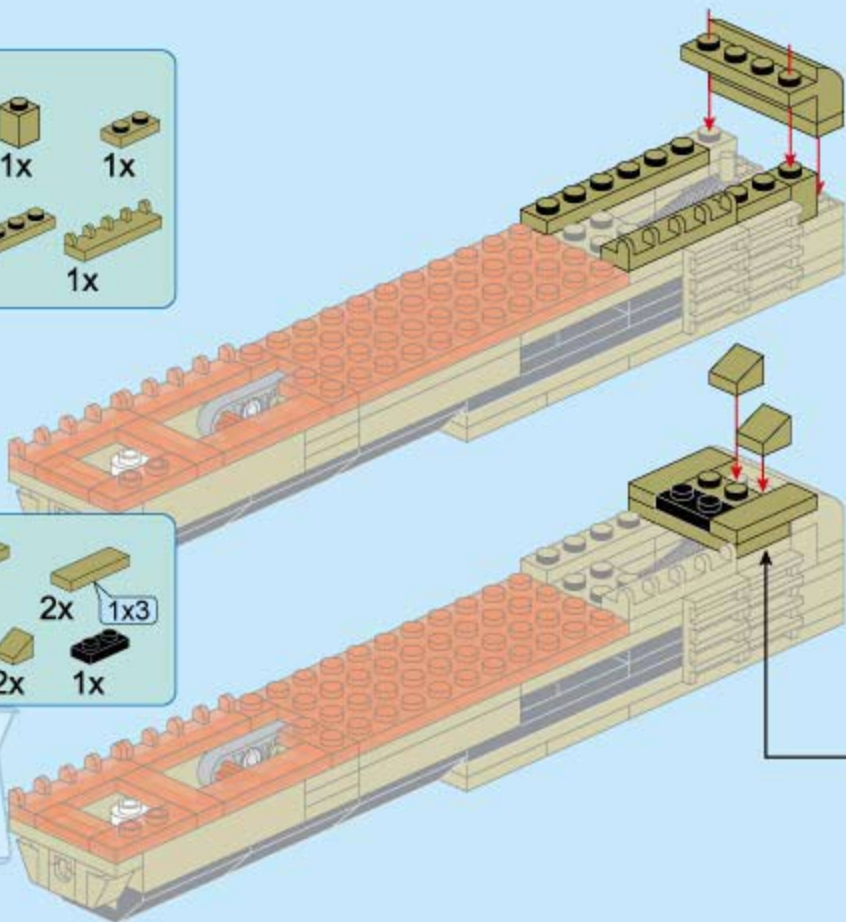
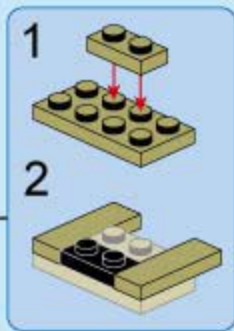
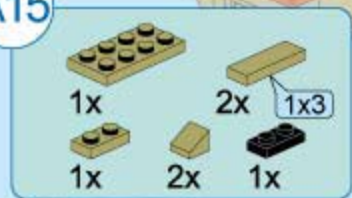

A16

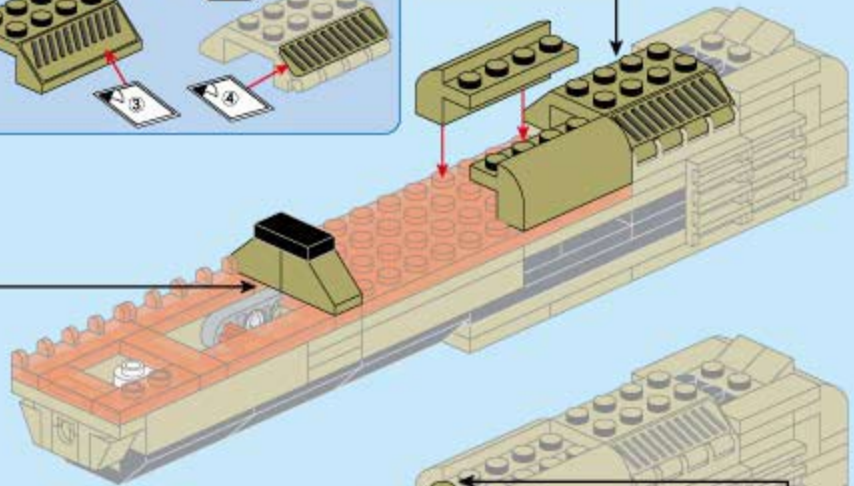
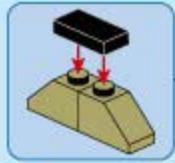
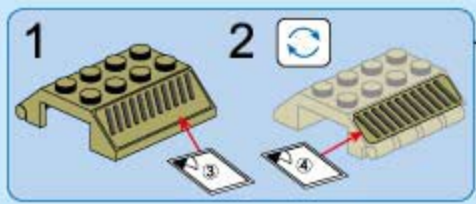
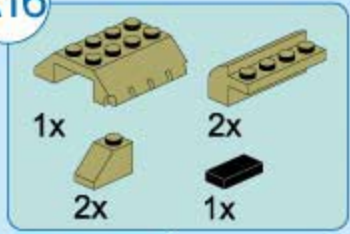

A17

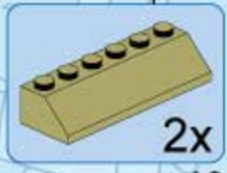
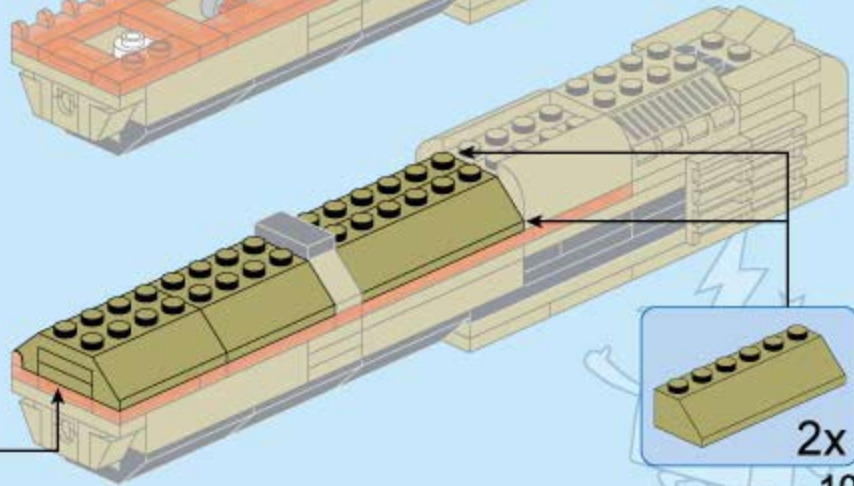
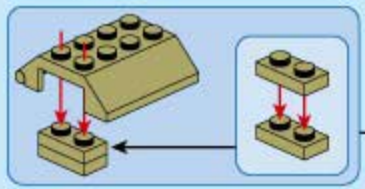
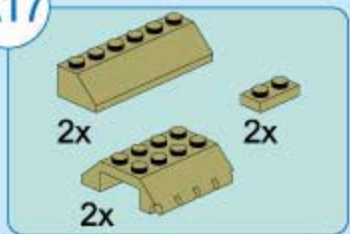

A18

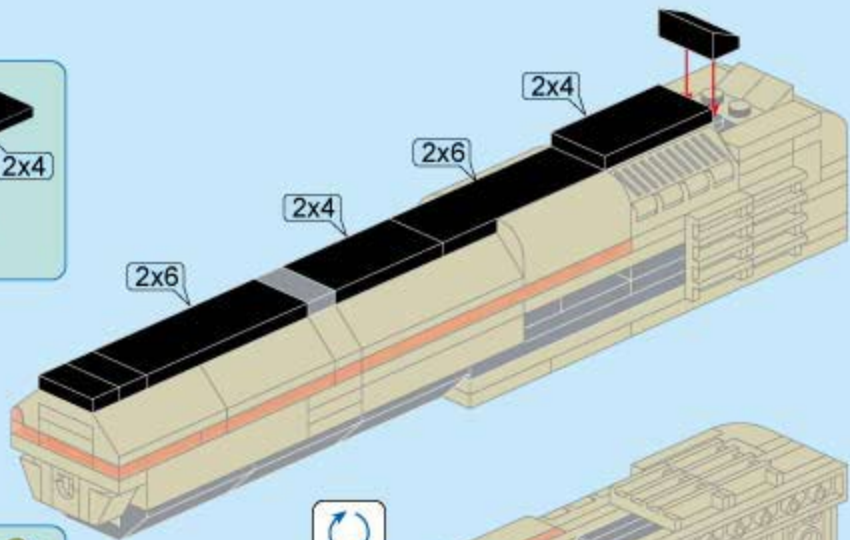
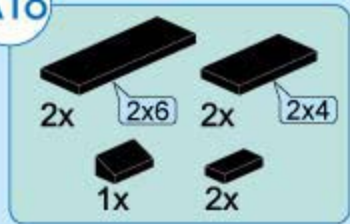

A19

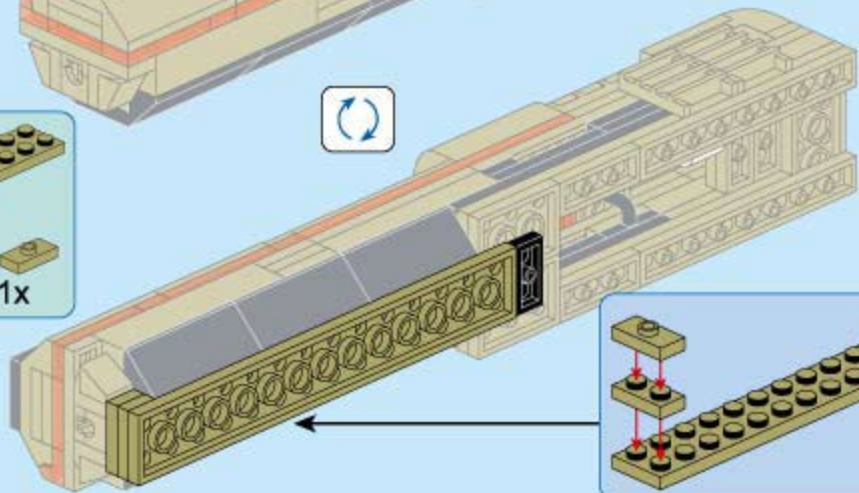
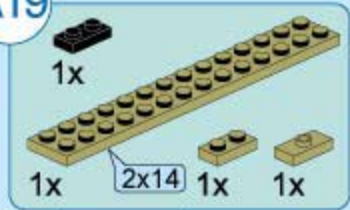

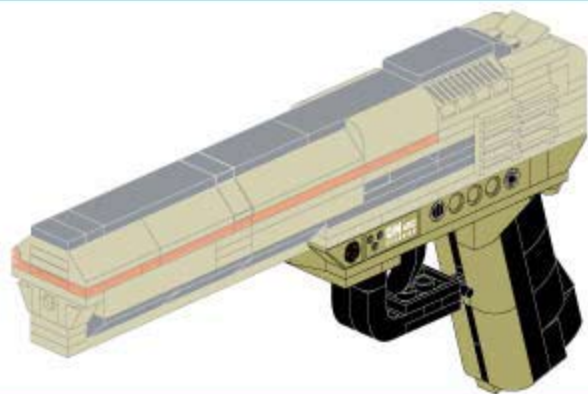

A20

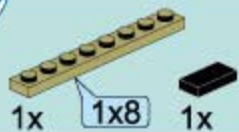

1x

1x8

1x

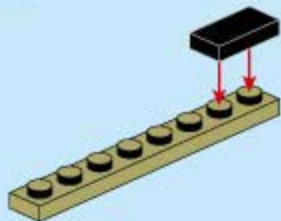

A21



3x

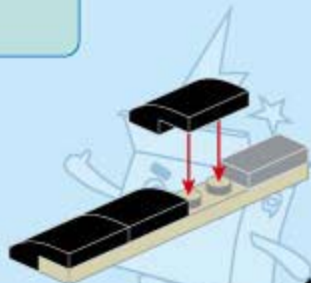

A22

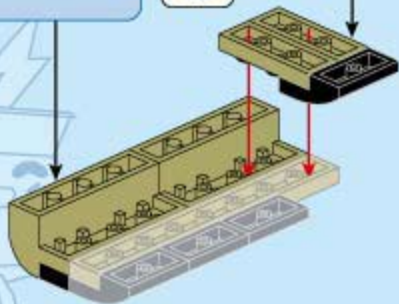
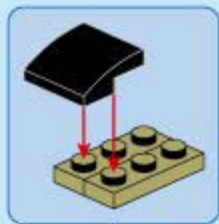
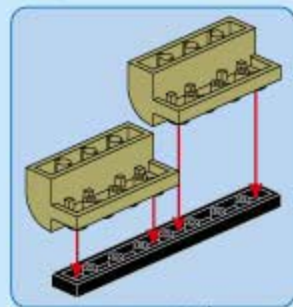
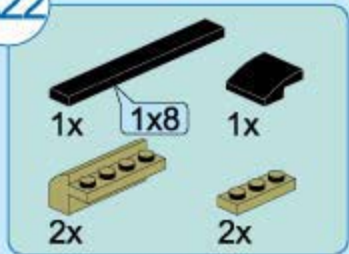

A23

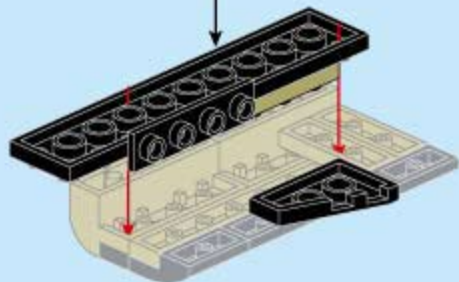
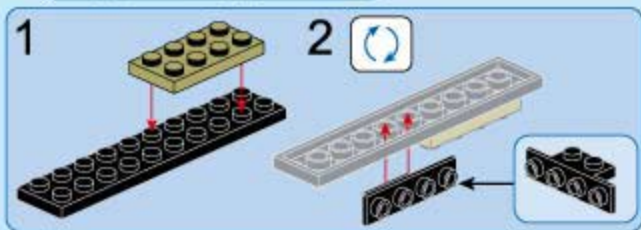
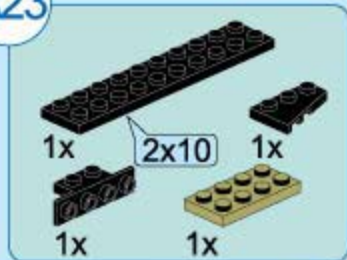

A24

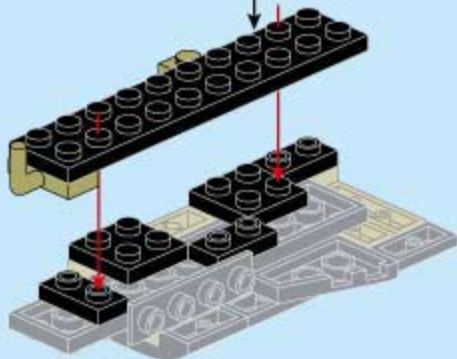
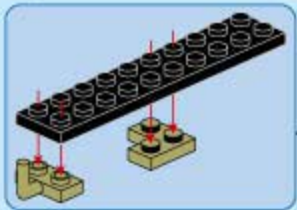
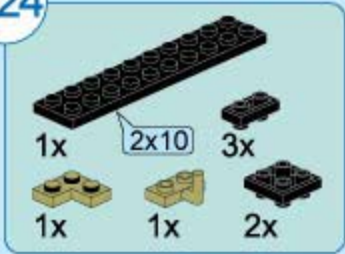

A25

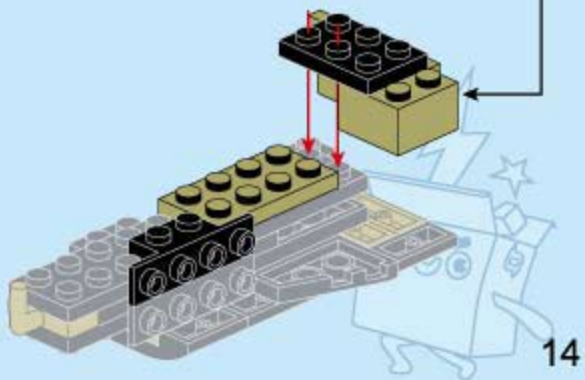
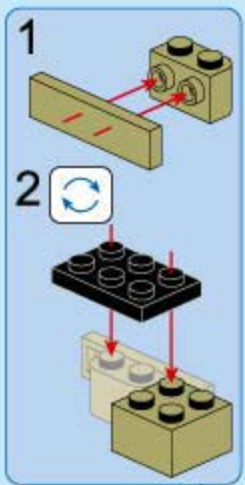
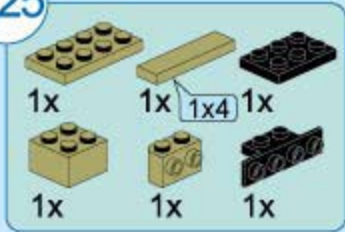

A26

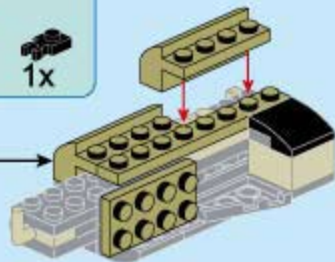
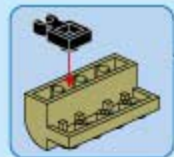
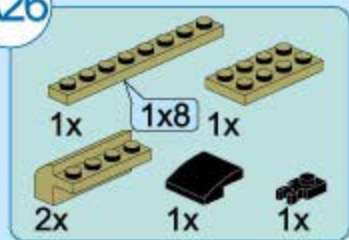

A27

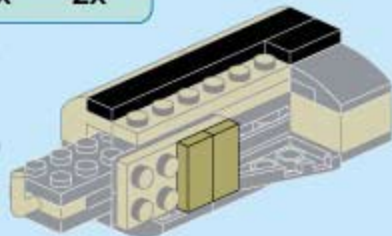
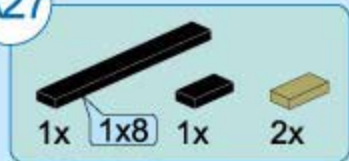

15

A28

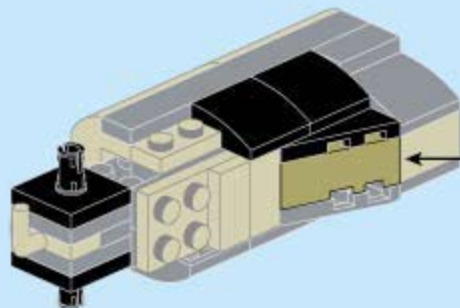
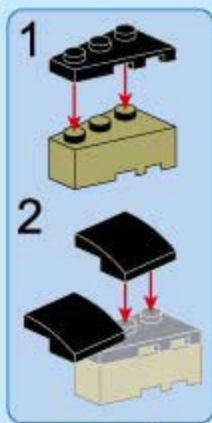
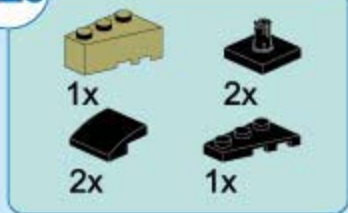

A29

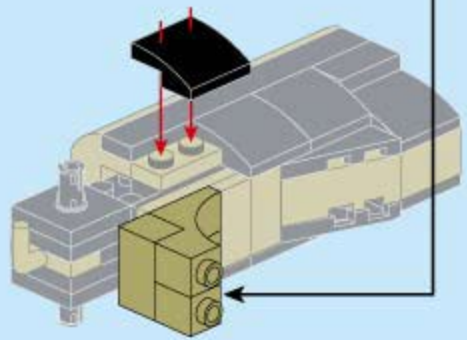
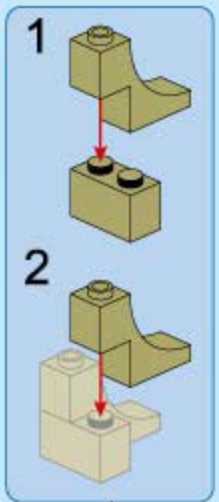
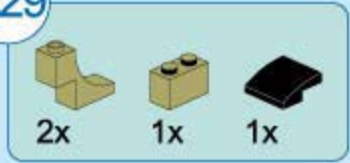

A30

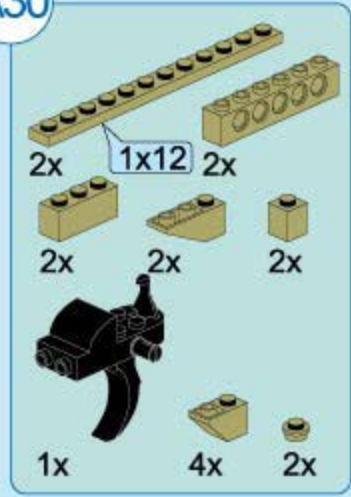

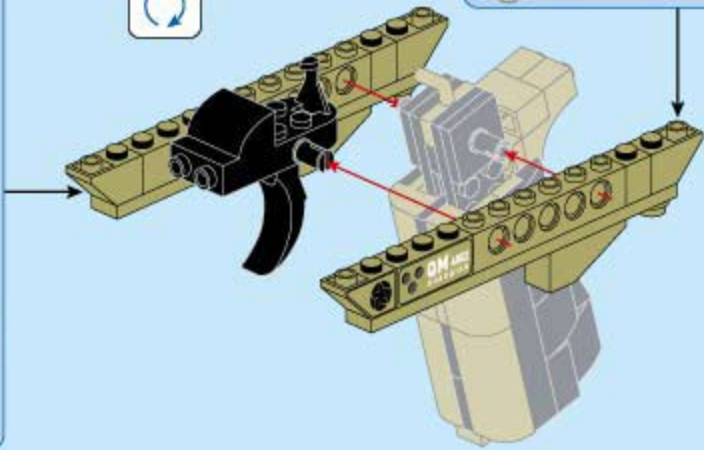
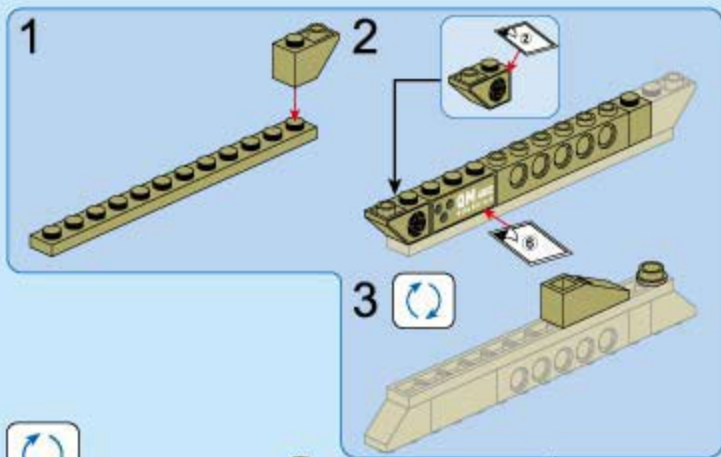
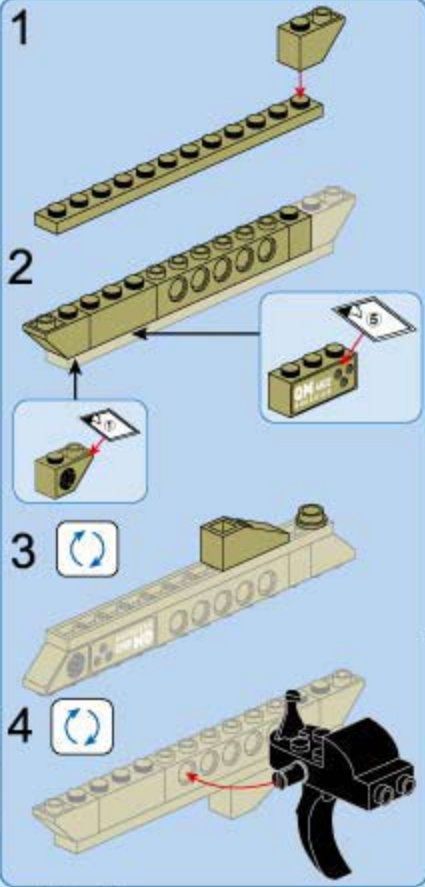

A31

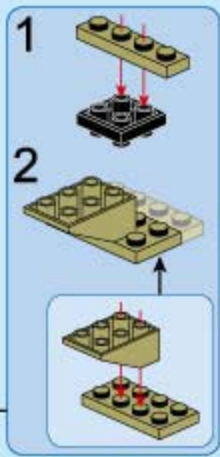
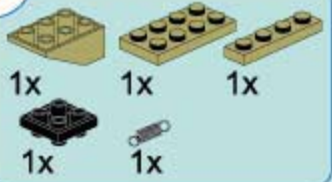

A32

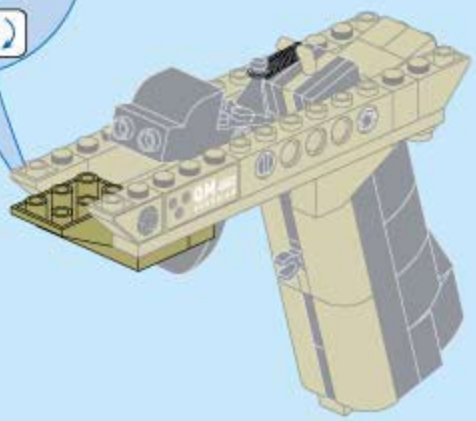
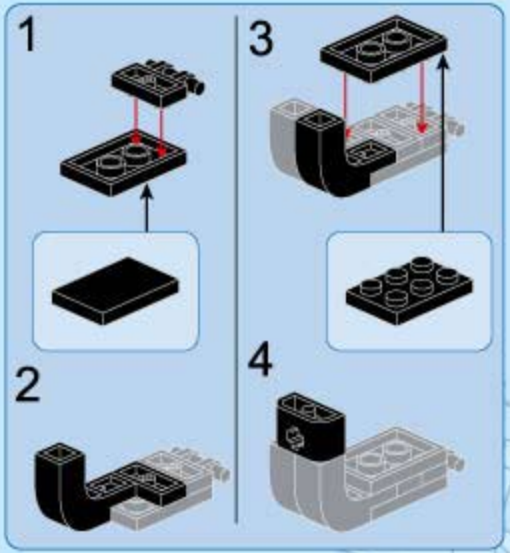
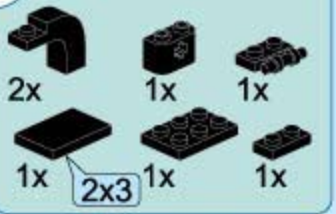

A33

A31

A32

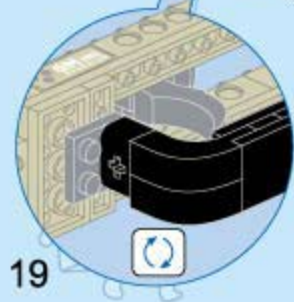

A34

A19

A33

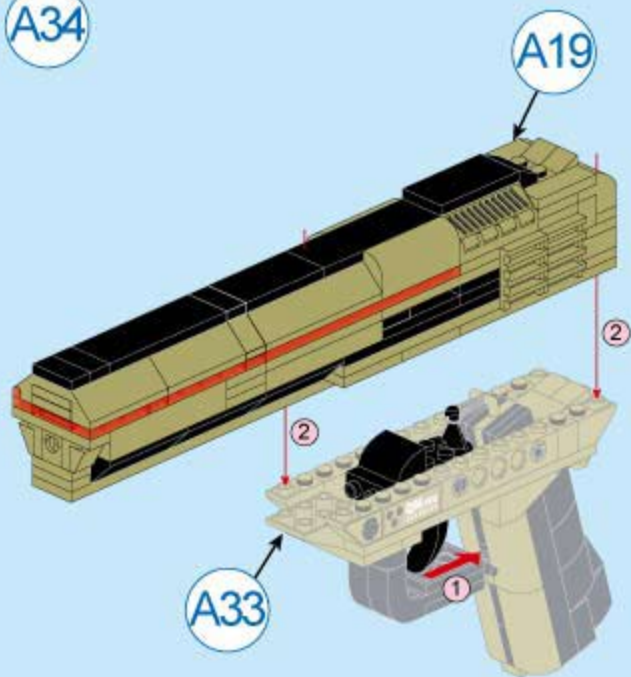

○ 注意拼搭顺序

1

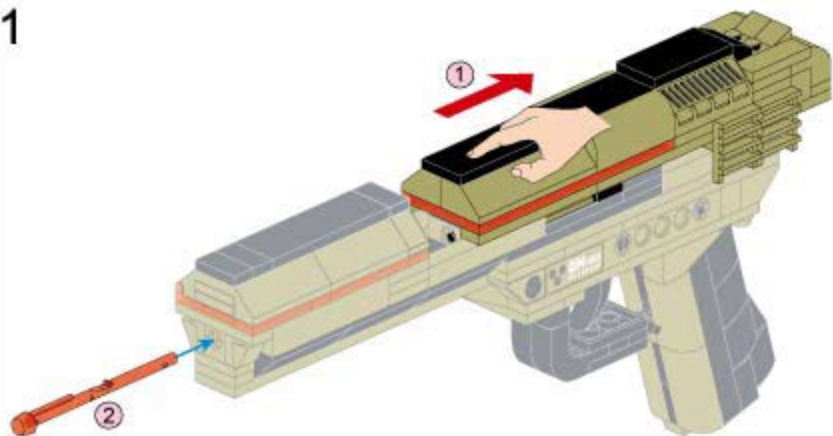

2

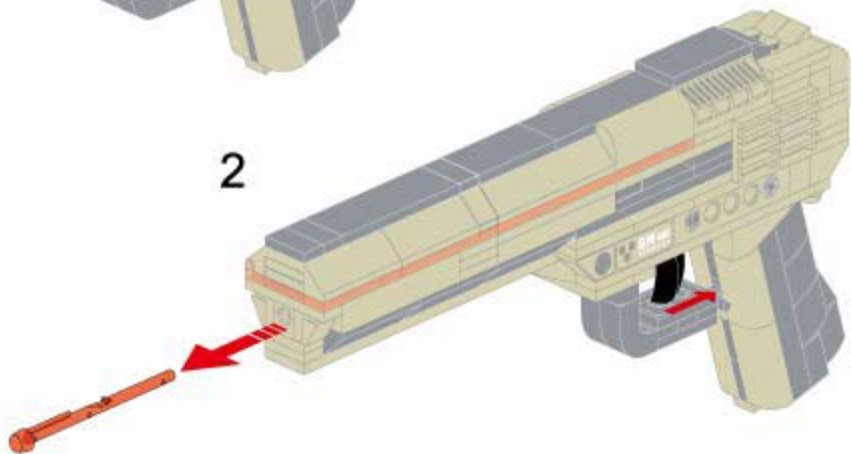

2

SECOND FORM

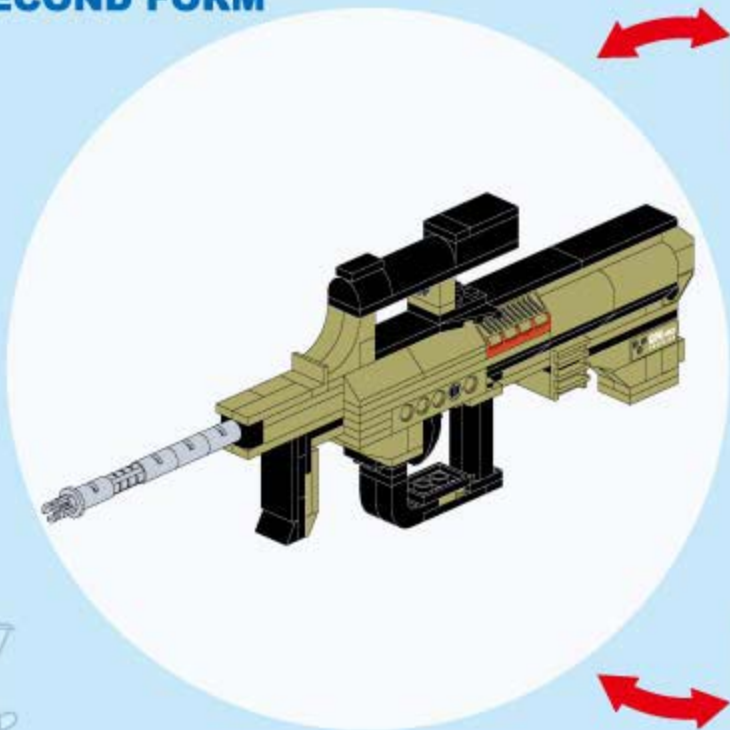

3 in 1
Transforms





B1

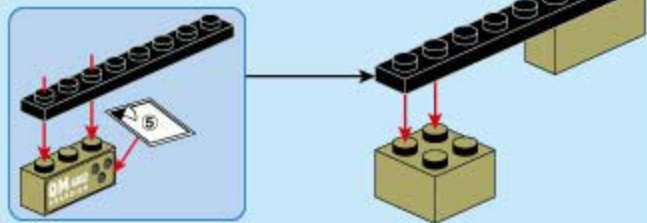
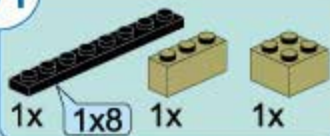

B2

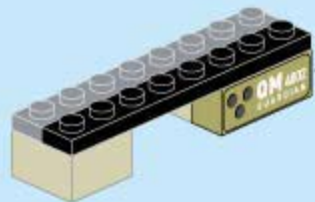
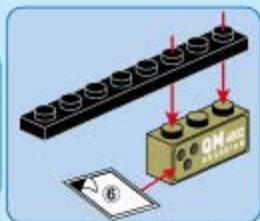
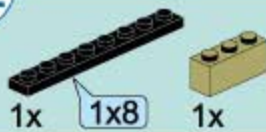

B3

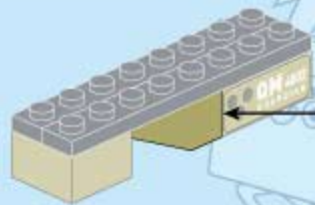

B4

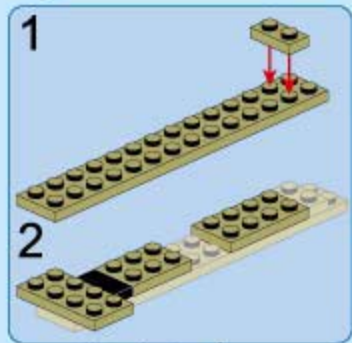
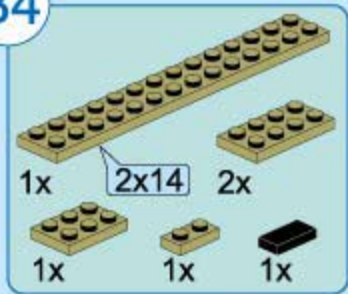

23

B5

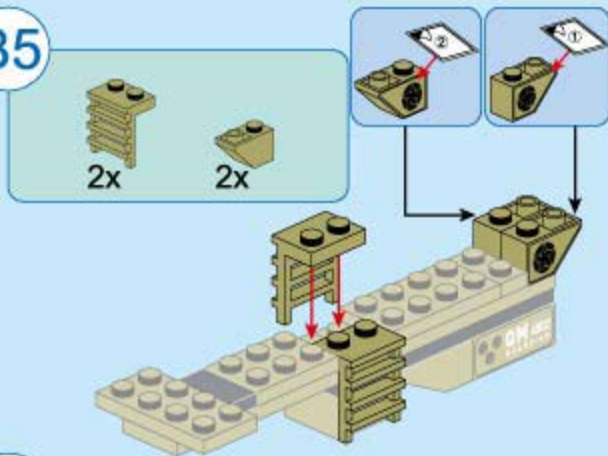

B6

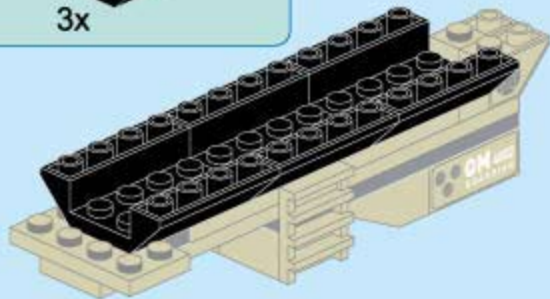

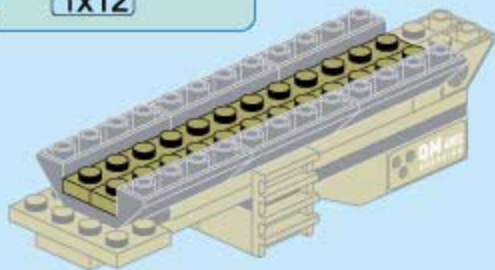
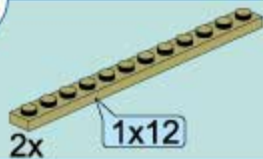
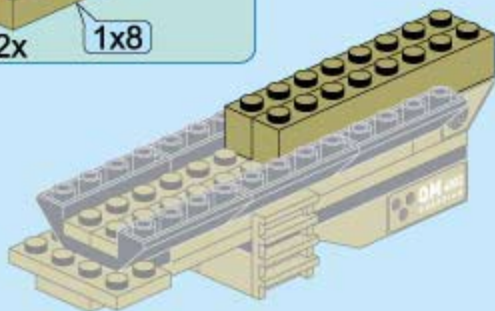
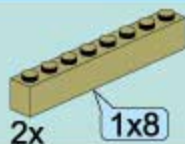
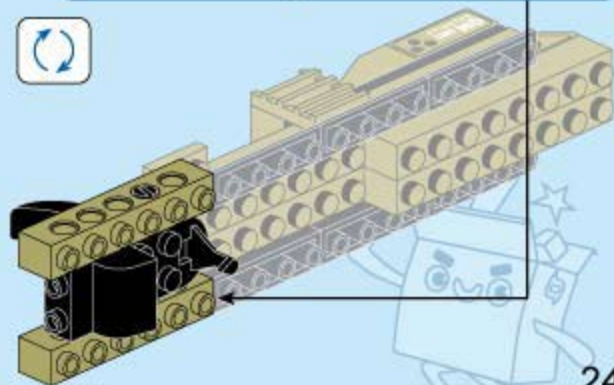
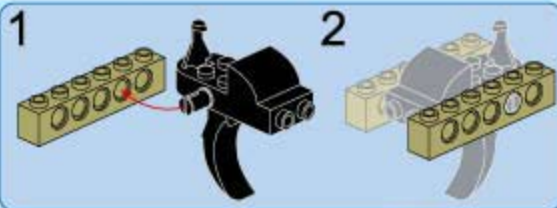
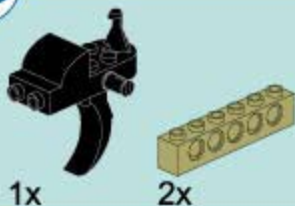
B7**B8****B9**

B10

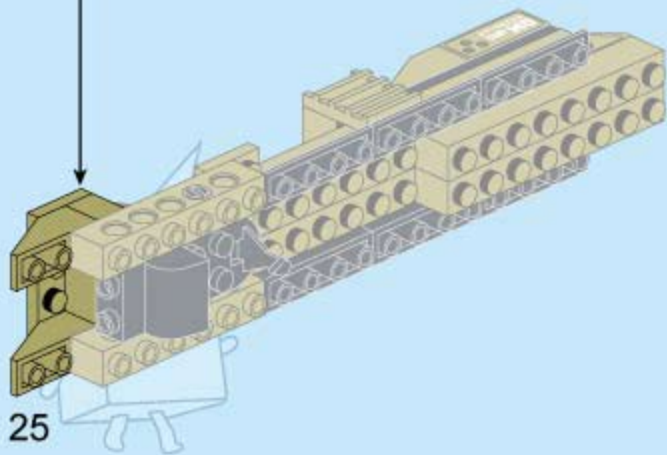
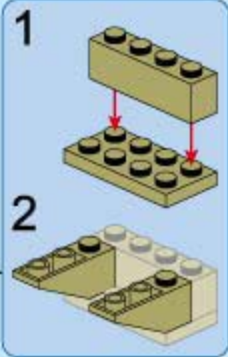
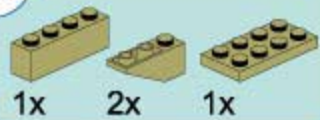

B11

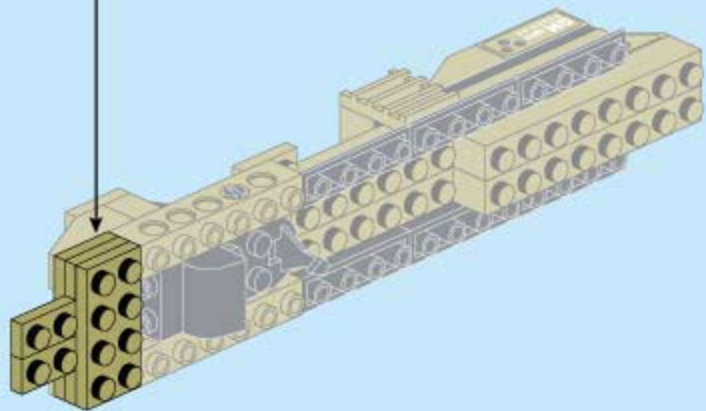
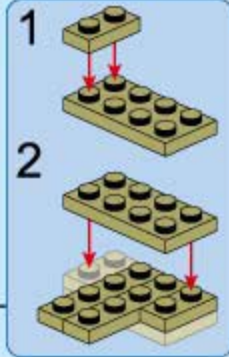
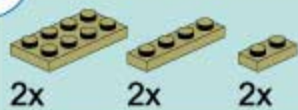

B12

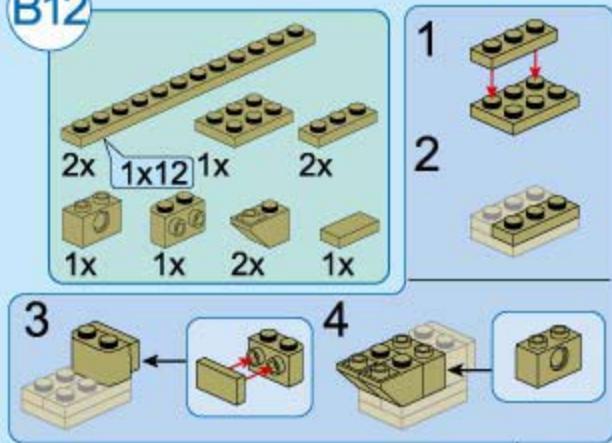

B13

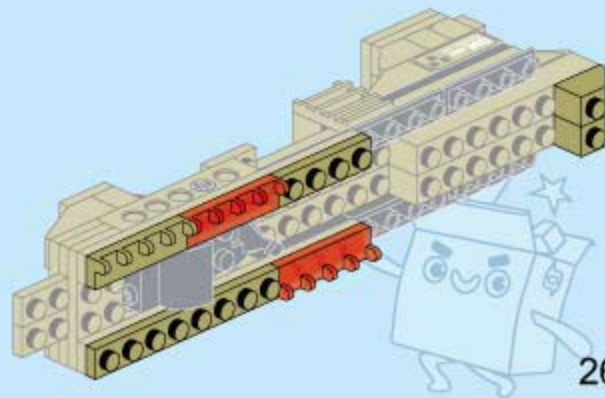
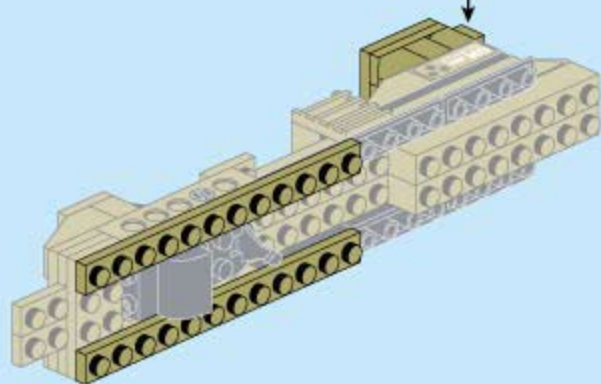
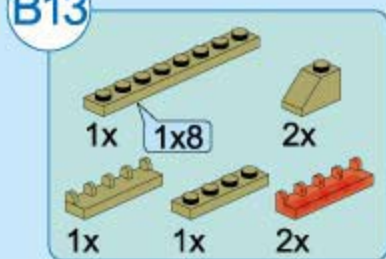

B14

- 1x [Black L-shaped Technic brick]
- 4x [Yellow Technic brick with 4 holes]
- 2x [Yellow Technic brick with 3 holes]
- 1x [Black Technic brick with 4 holes]
- 2x4 [Black Technic brick with 4 holes]
- 2x [Yellow Technic brick with 2 holes]
- 1x3 [Yellow Technic brick with 3 holes]
- 2x [Yellow Technic brick with 1 hole]
- 2x [Black Technic brick with 2 holes]
- 1x [Black Technic brick with 2 holes]
- 1x [Yellow Technic brick with 2 holes]
- 1x [Black Technic brick with 2 holes]
- 1x [Red Technic brick with 2 holes]
- 1x [Red Technic brick with 2 holes]

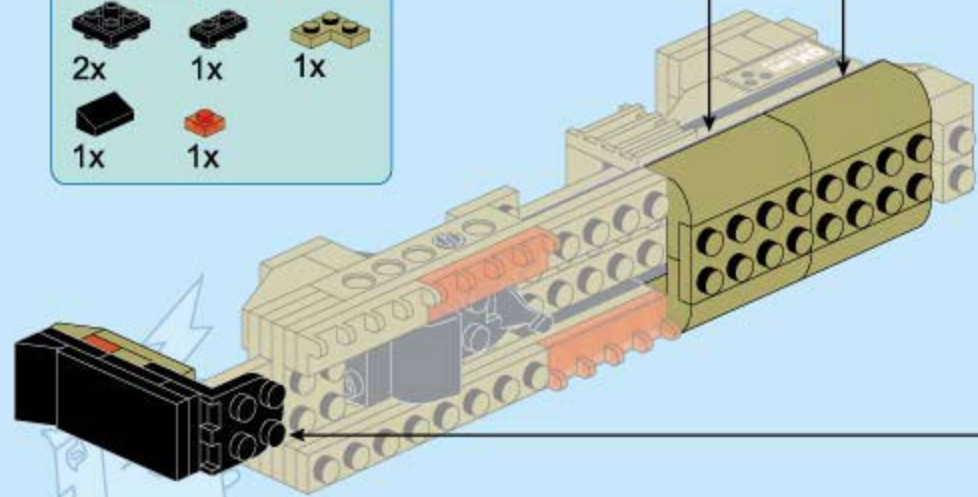
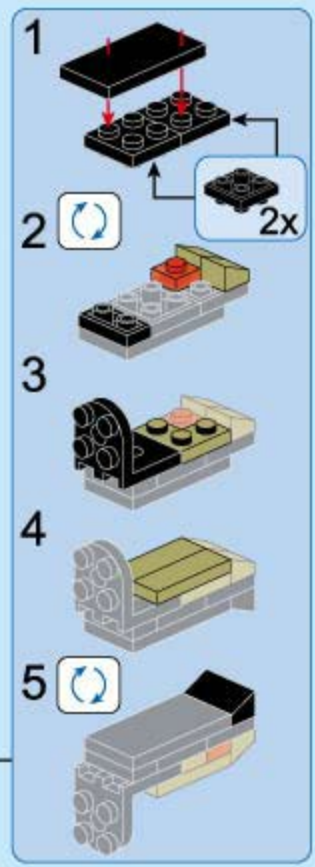
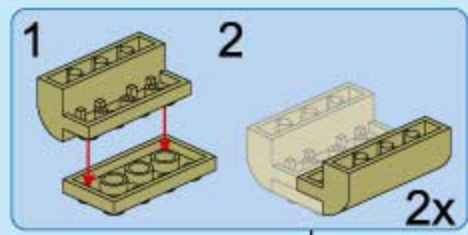

B15

- 4x 1x8
- 1x [1x8 with hole]
- 2x [1x8 with hole]
- 2x [1x8 with hole]
- 1x [1x8 with hole]
- 1x [1x8 with hole]
- 1x [1x8 with hole]
- 1x [1x8 with hole]
- 1x [1x8 with hole]

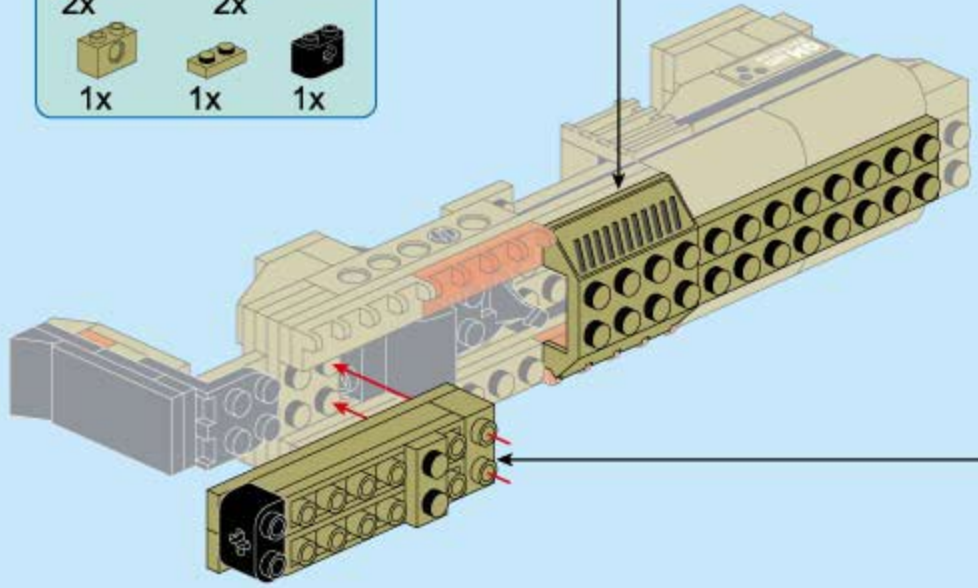
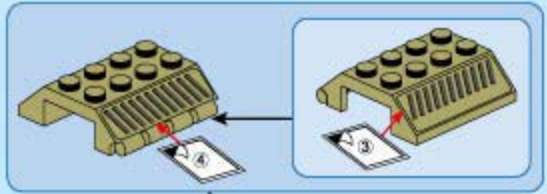

- 1 [1x8 with hole]
- 2 [1x8 with hole]
- 3 [1x8 with hole]

B16

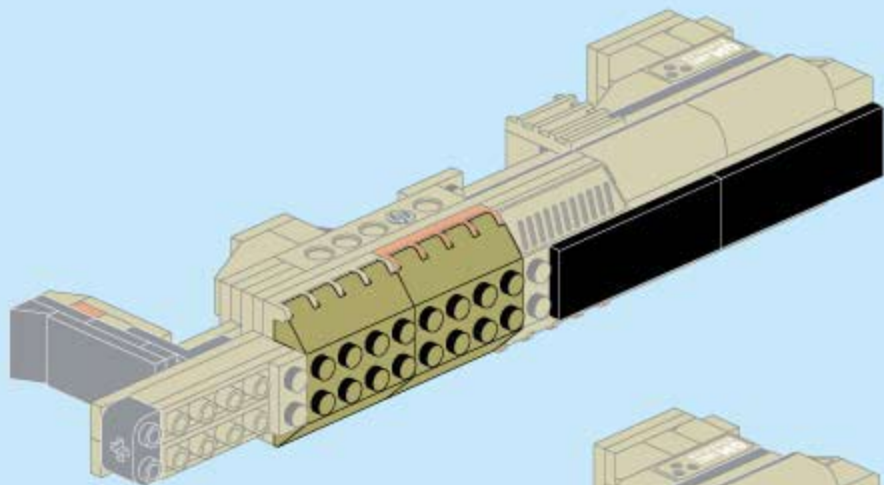
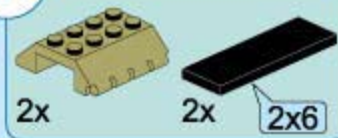

B17

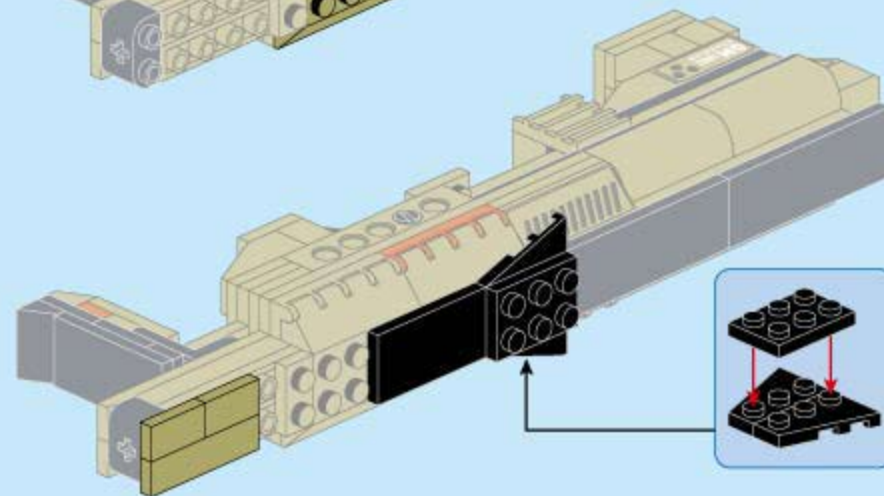
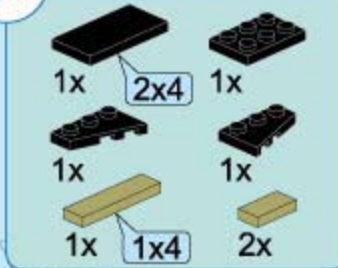

B18

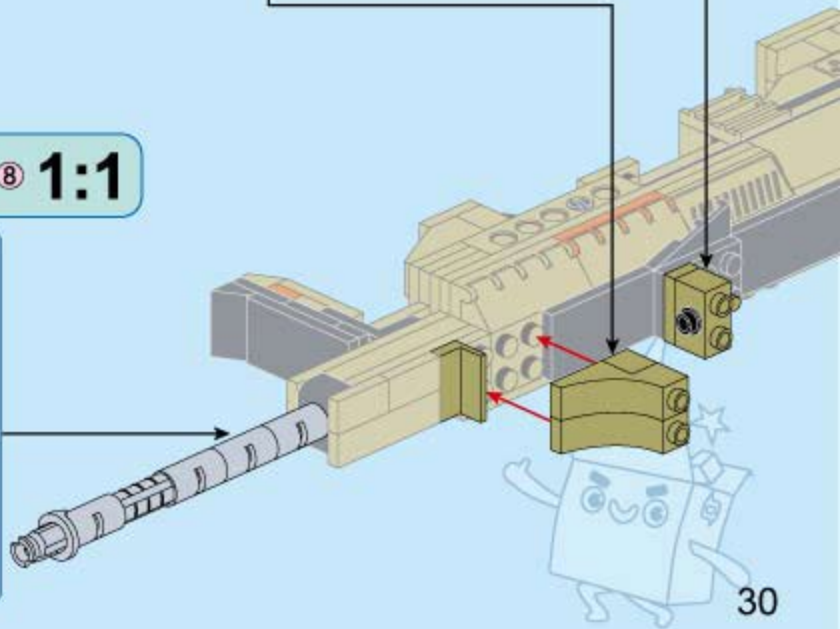
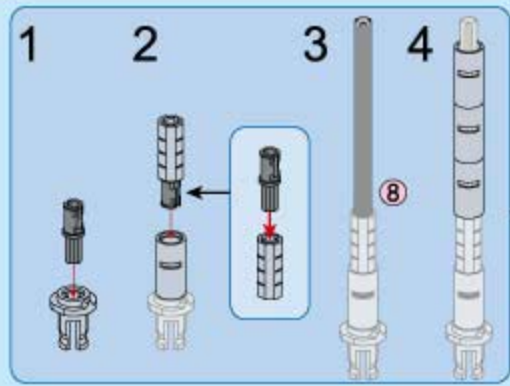
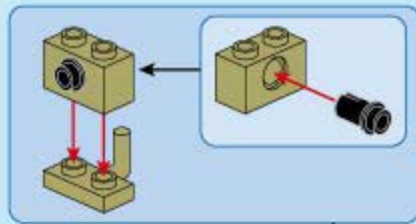
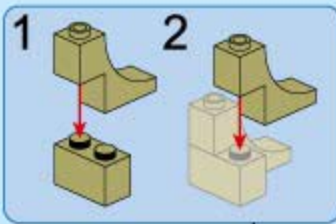

B19

- 1x 2x10
- 2x 1x2
- 1x 1x3
- 1x 1x2
- 1x 1x2
- 1x 2x3

- 1
- 2
- 3

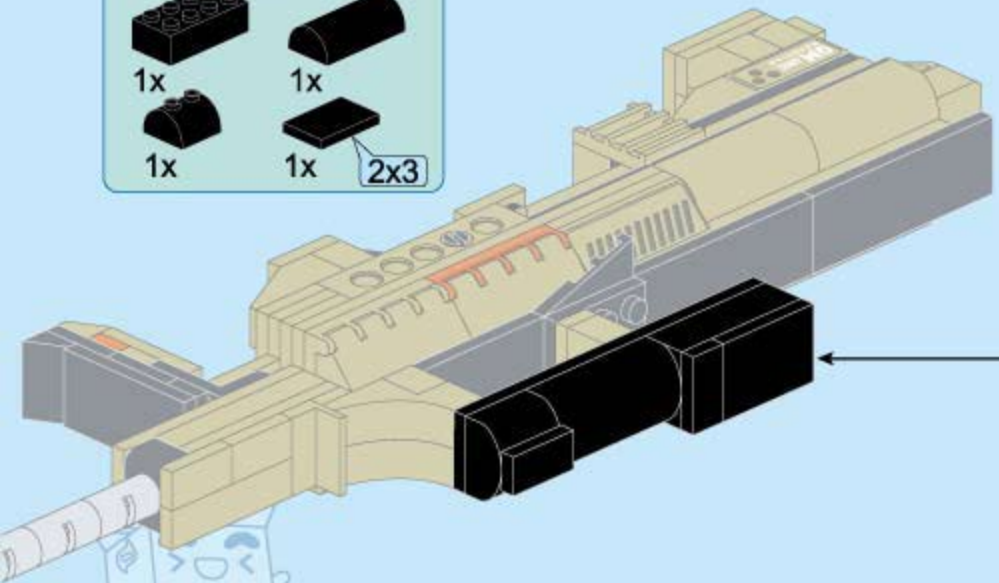

B20

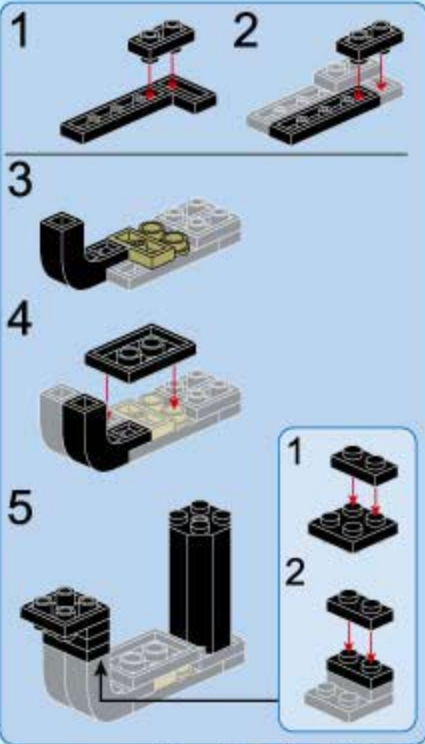
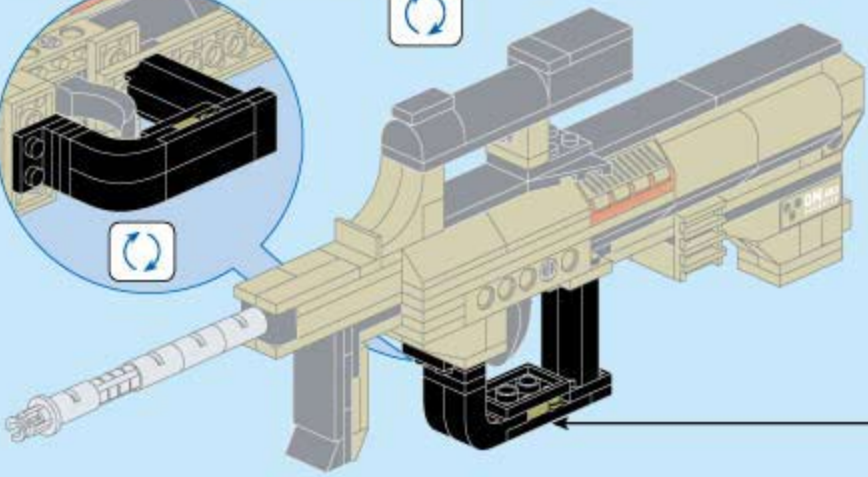
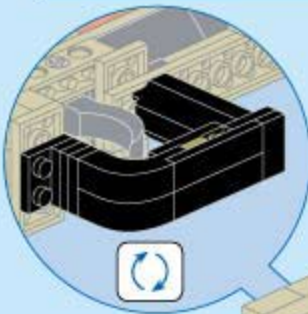
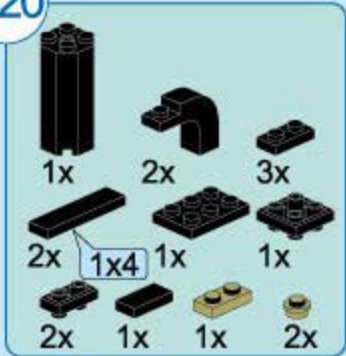

3

THIRD FORM



3 in 1
Transforms





C1



1x



1x



C2



1x



1x



1x

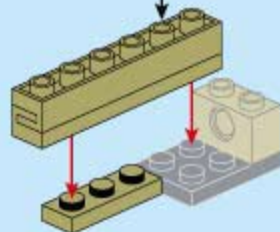
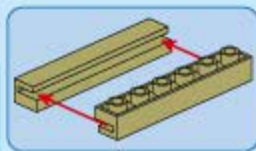

C3



1x



1x



1x

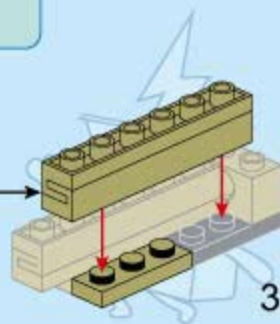
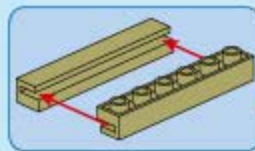

C4



2x

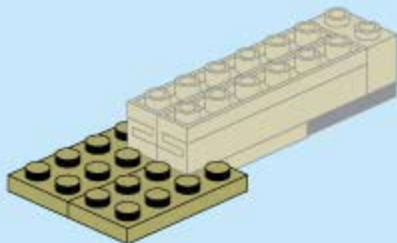

C5



1x



2x

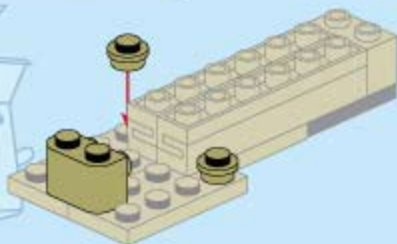

C6

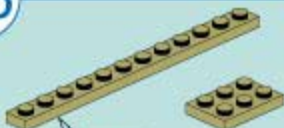

2x

1x12

1x

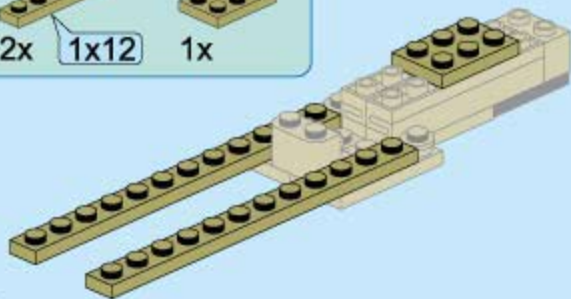

C7



2x

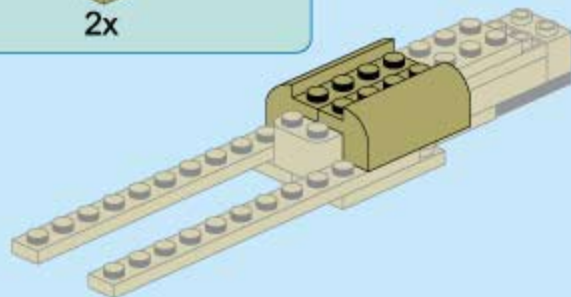

C8



1x



1x



2x

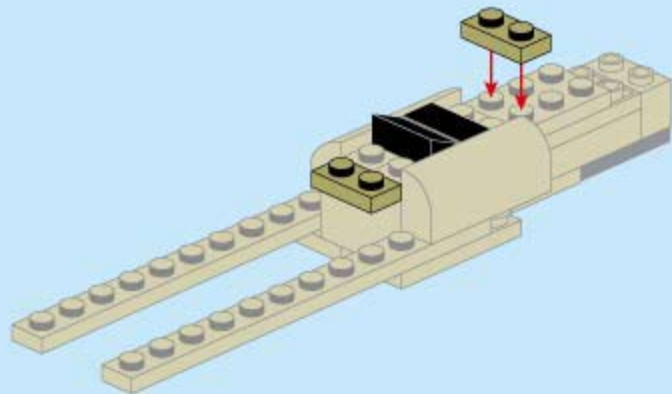

C9



1x



2x



2x

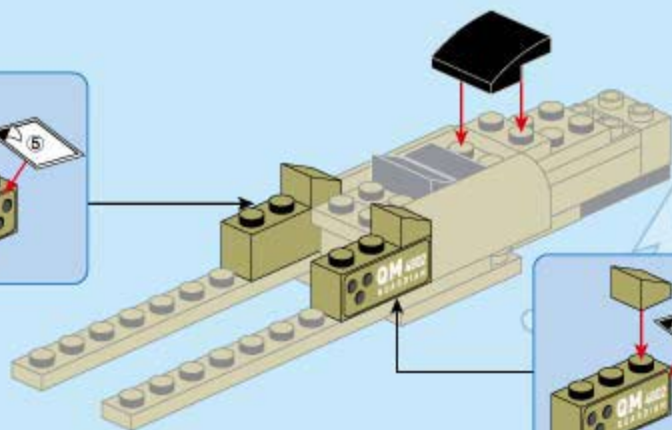
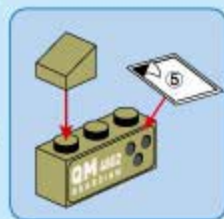

C10

- 4x 1x8
- 1x 1x4
- 2x 1x2
- 1x 1x2
- 2x 1x2
- 1x 1x2
- 2x 1x2

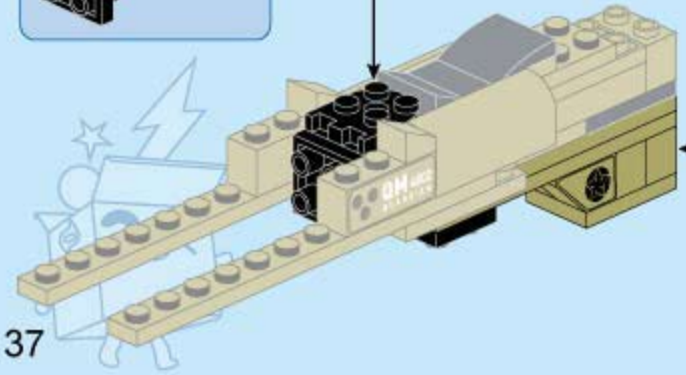
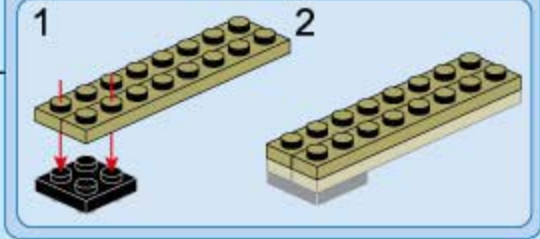
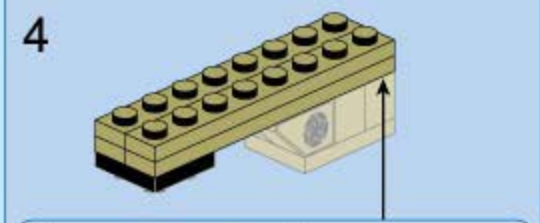
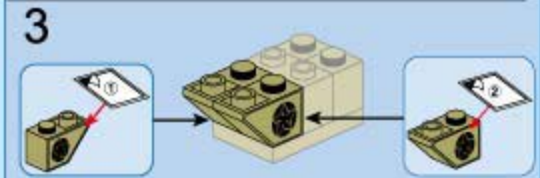
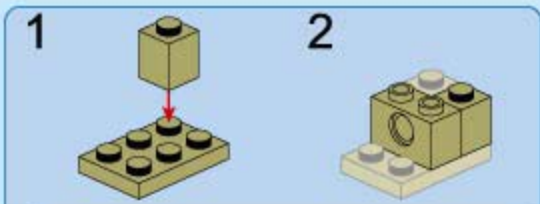
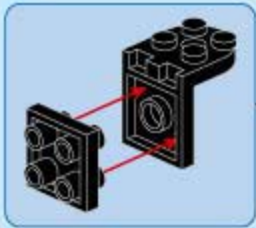

C11

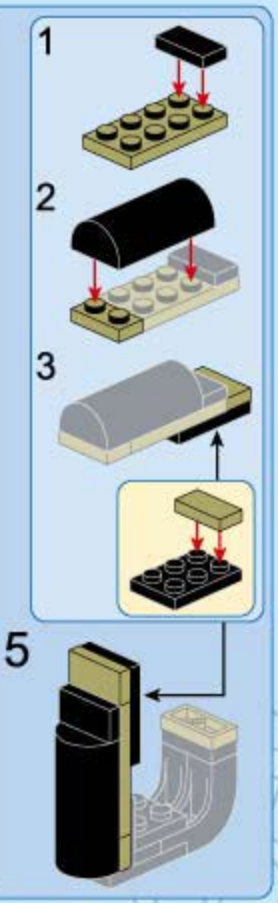
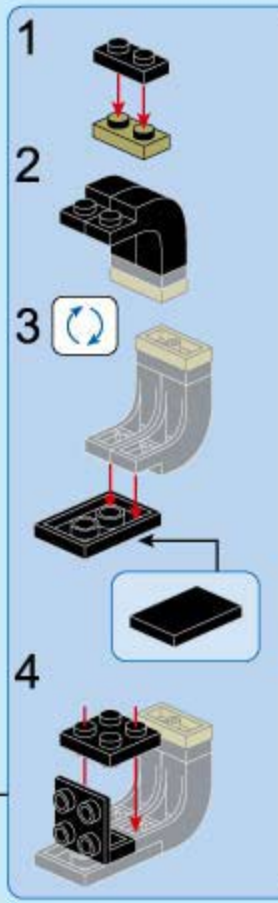
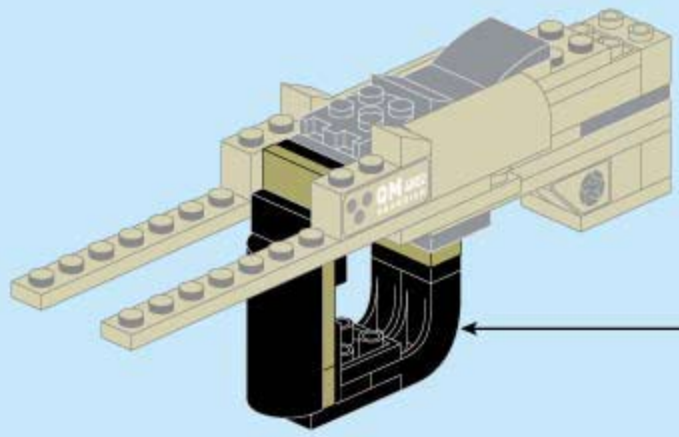
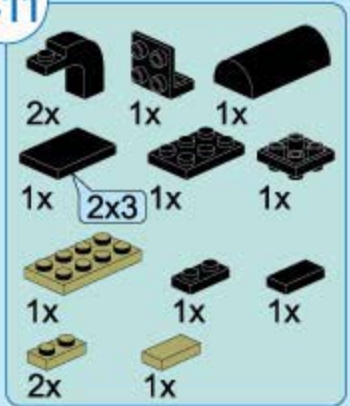

C12

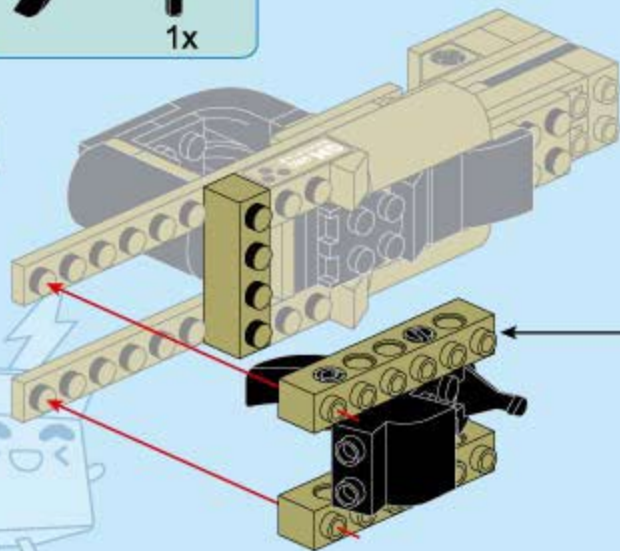
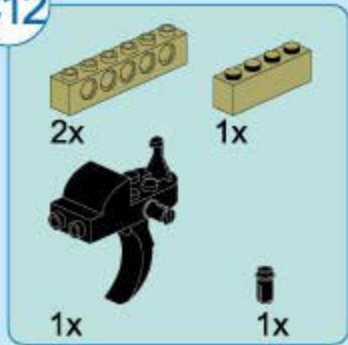

1

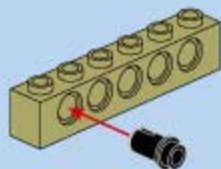

2



3

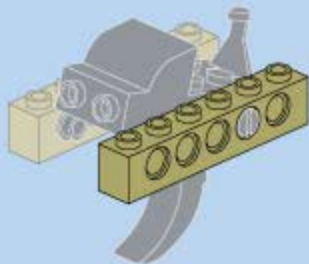

C13

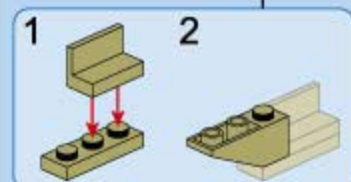
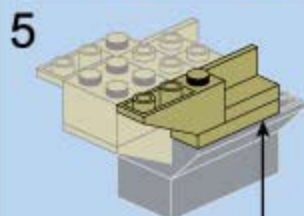
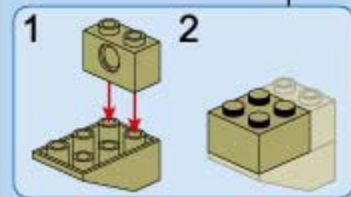
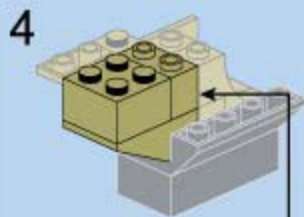
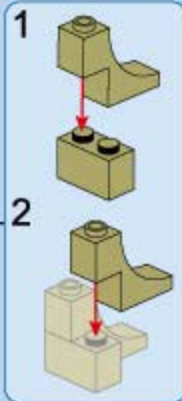
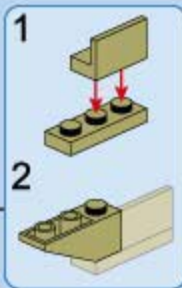
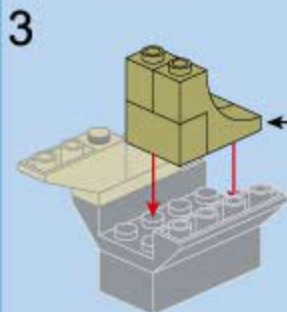
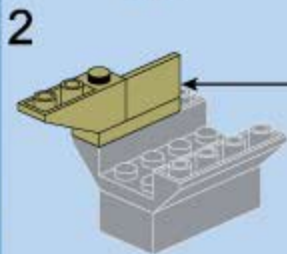
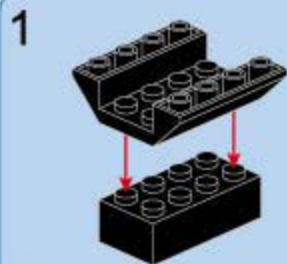
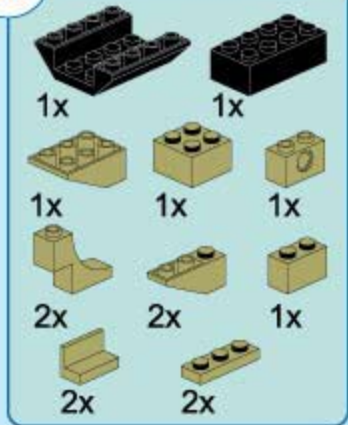

C14

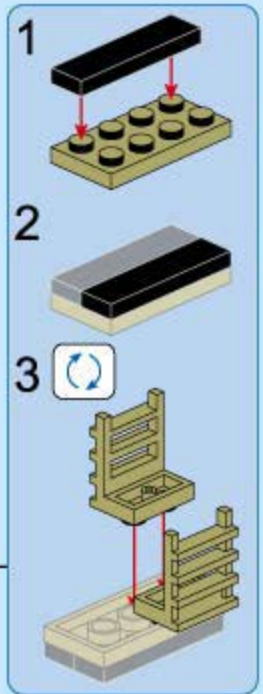
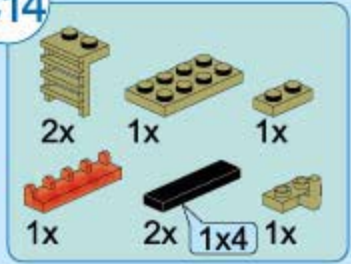

C13

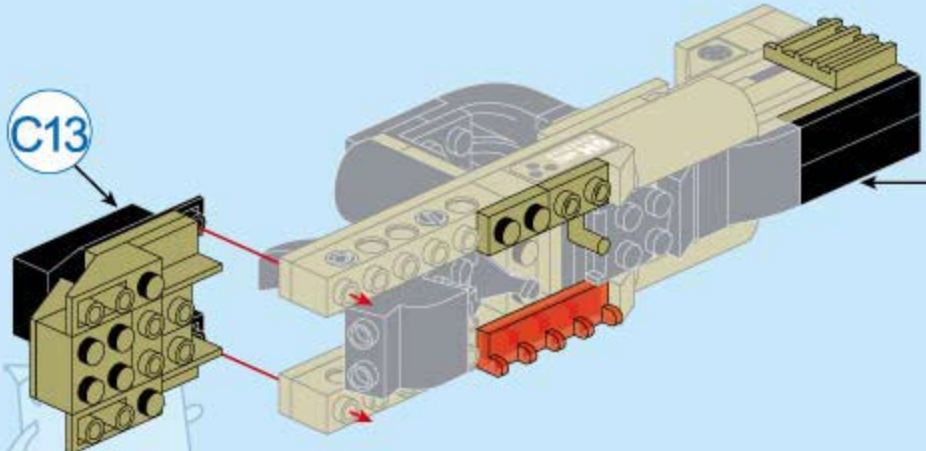

C15

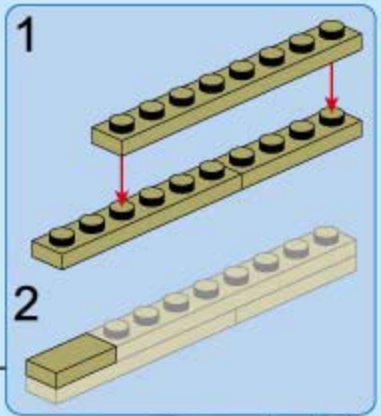
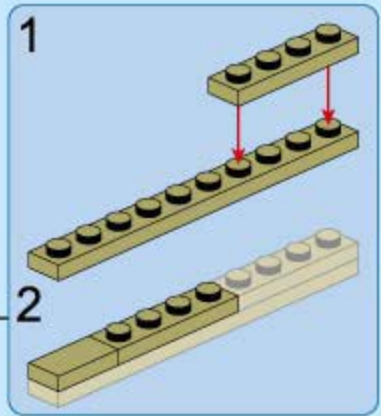
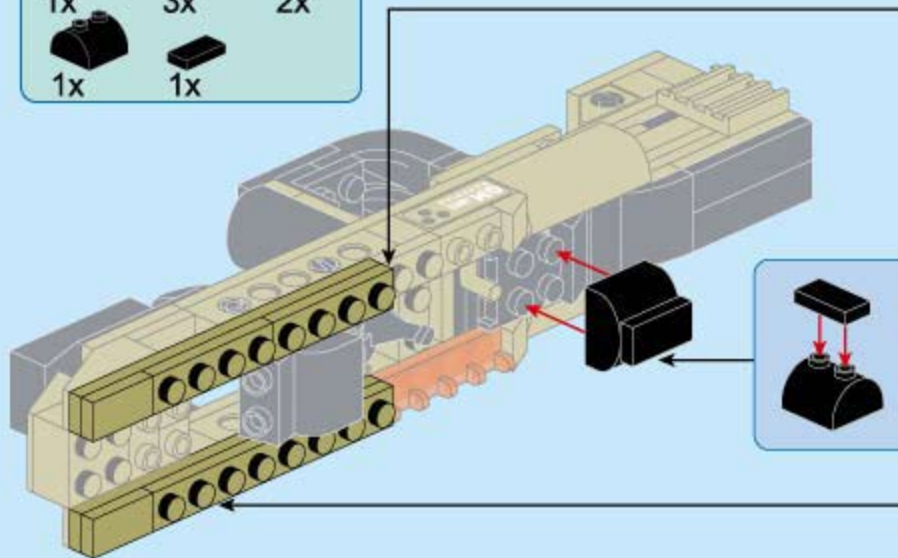
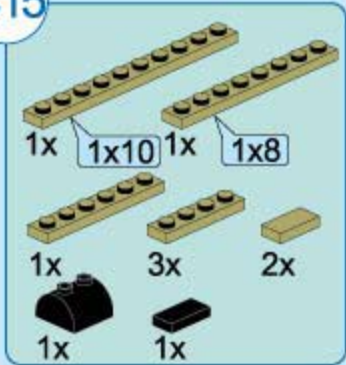

C16

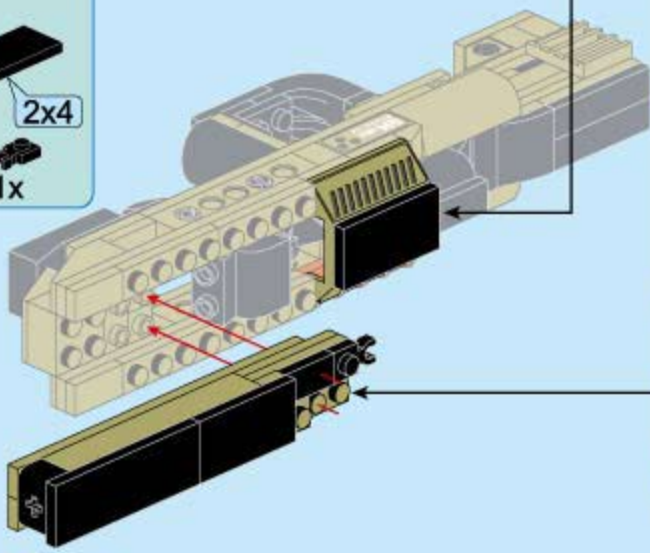
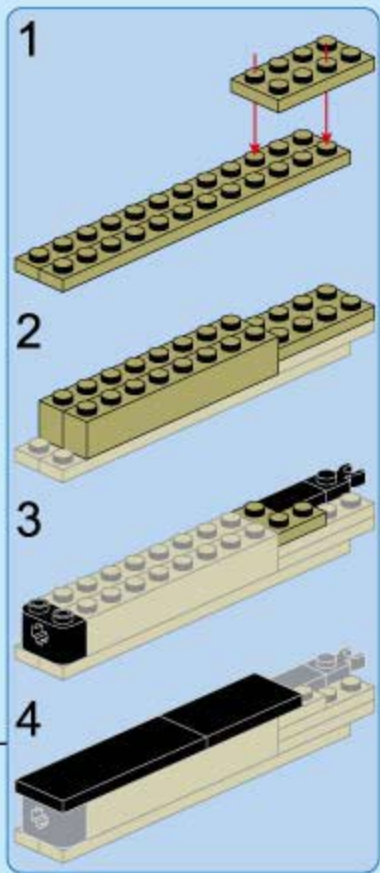
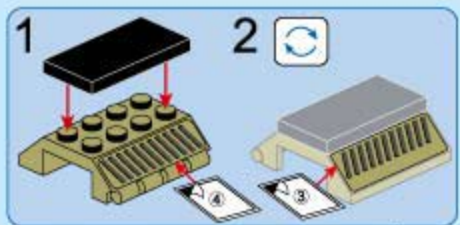
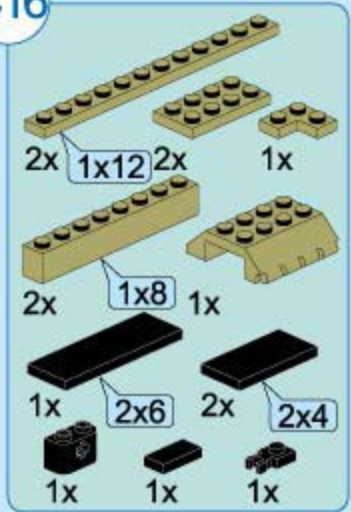

C17

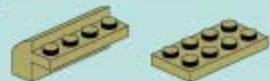

4x

1x



1x

1x

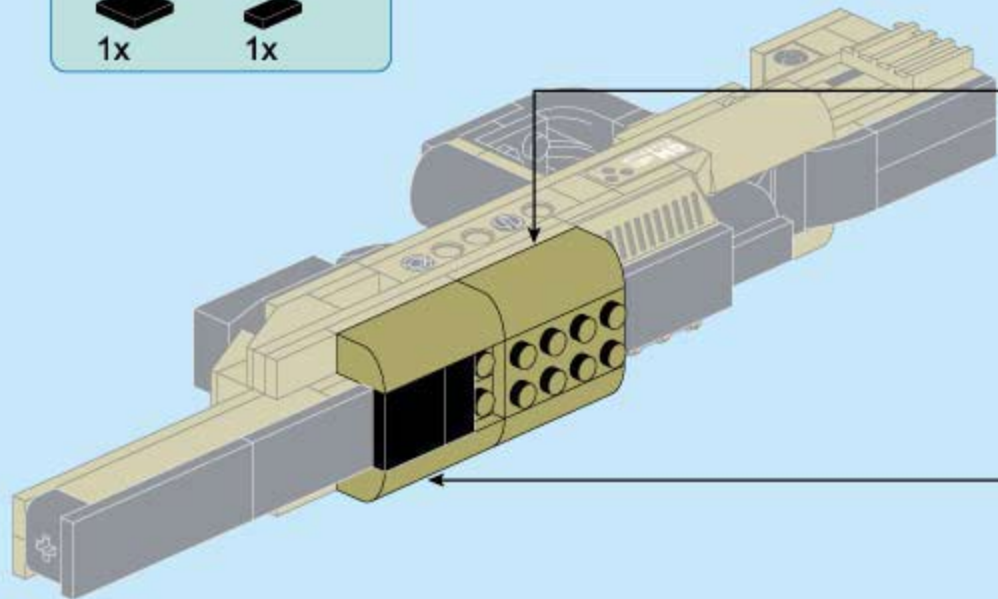

1

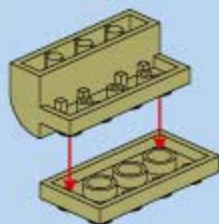

2



1

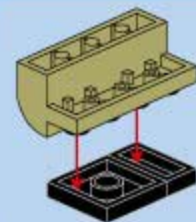

2

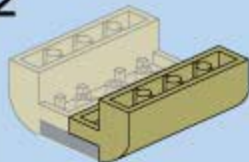

C18

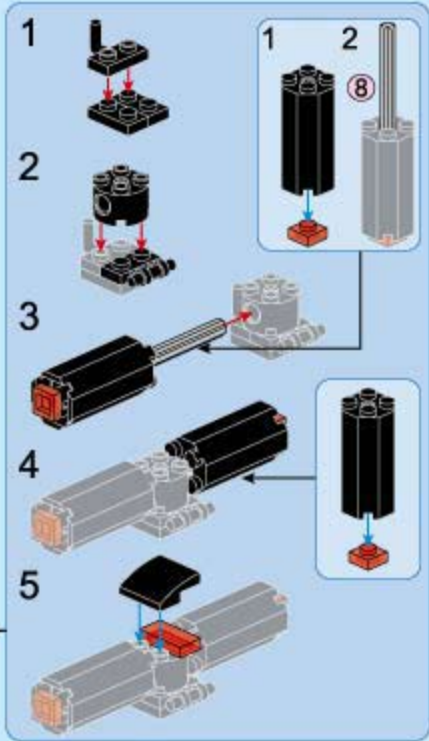
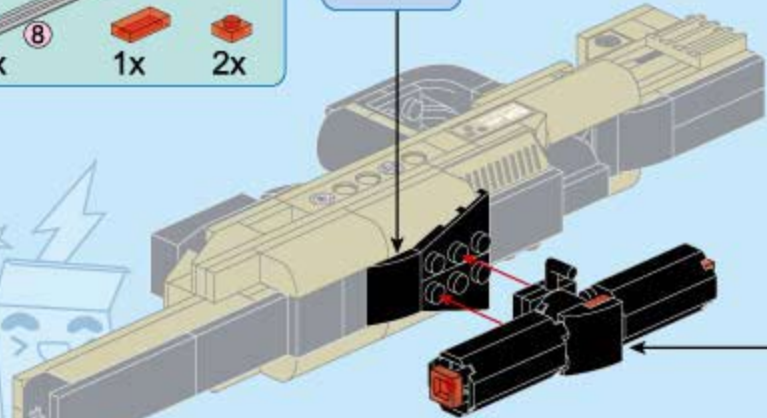
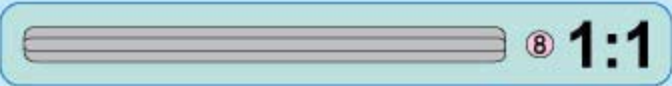
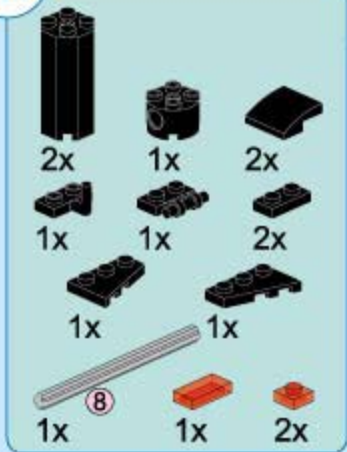

C19



1x



1x



4x

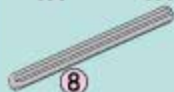

1x



2x



8

1:1

1

2

3

4

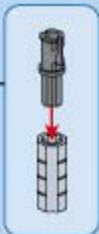

8

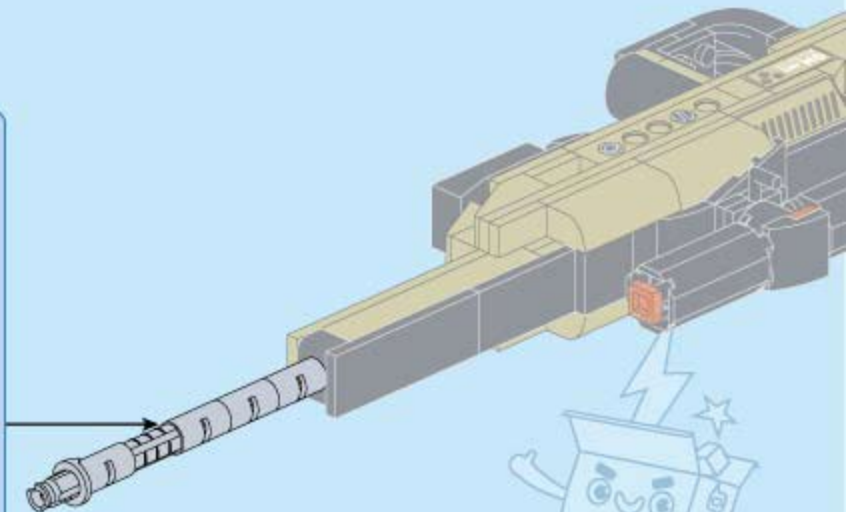

QMAN LIGHTEN
THE DREAM

**UNLIMITED
IDEAS**



4801 GIRL'S ROOM



4802 DILEMMA WEAPON



4803 MACHINERY TECHNOLOGY



4805 ENGINEERING MACHINERY



4804 VACATION TOUR

V2.0