

QMAN

LIGHTEN
THE
DREAM

TRANS-
COLLECTOR



41311 | Ages: 6+ | PCS: 988

SPECIAL ASSAULT TYRANNOSAURUS BATTLE VEHICLE

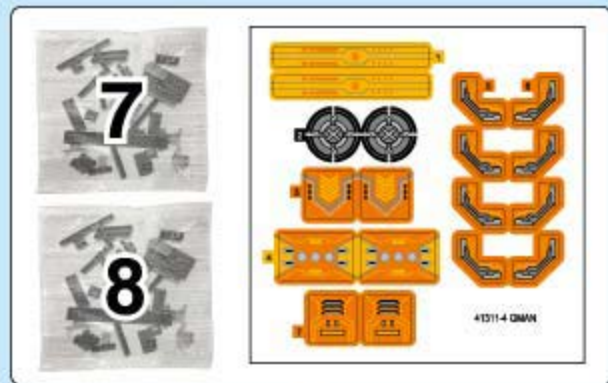
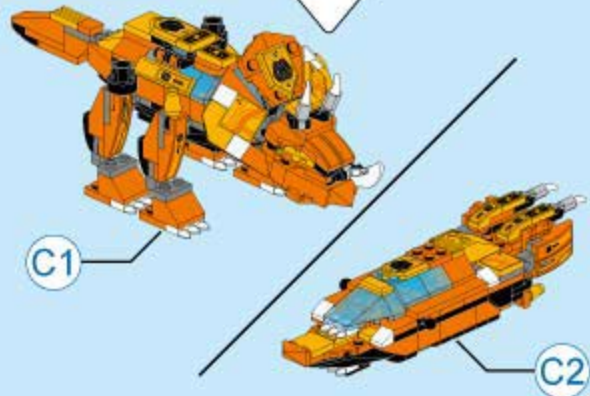
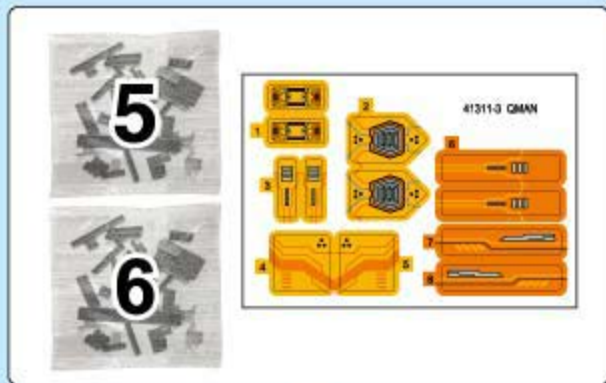

A1

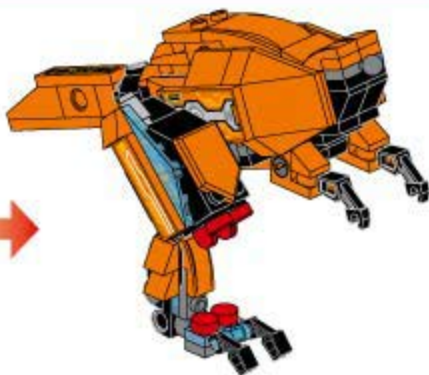

拆件器使用方法, 仅为示例

Usage of Brick Separator, Just for the sample

1



3



2



4



A1



2x

1x

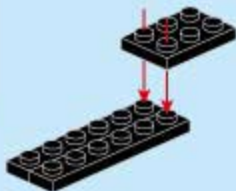

A3



2x

1x

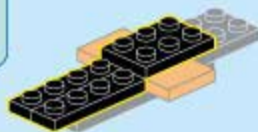

A2



2x

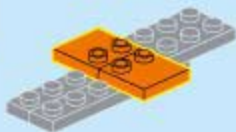

A4



2x

1x

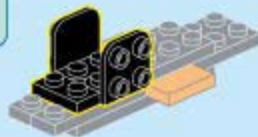

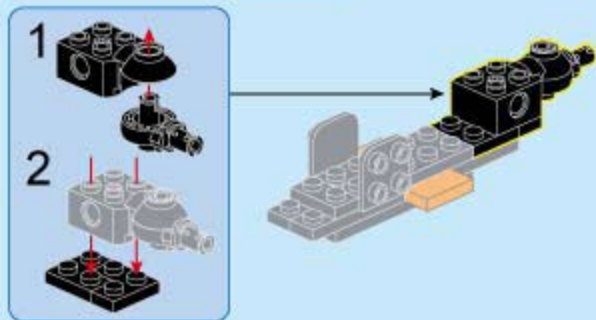
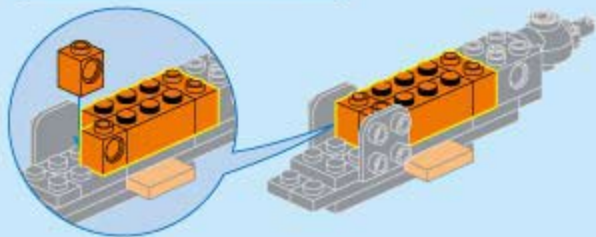
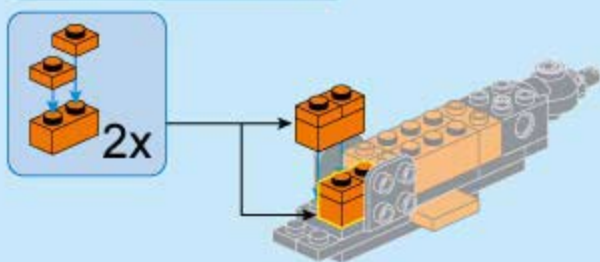
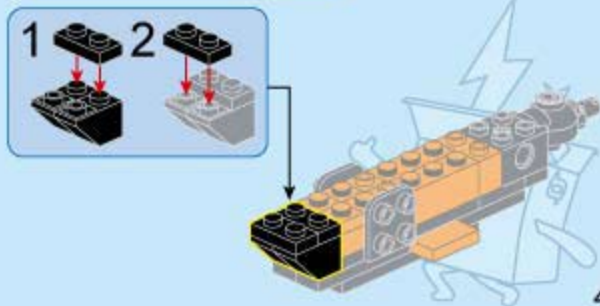
A5**A6****A7****A8**

A9

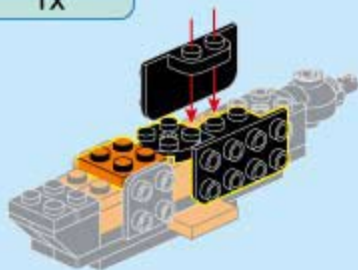

A11



A10

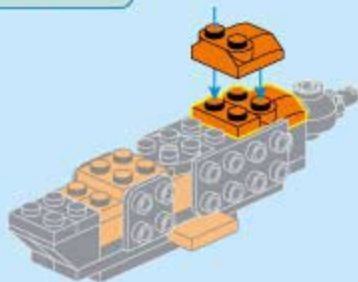

A12

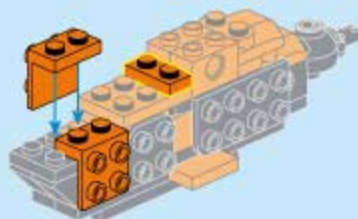
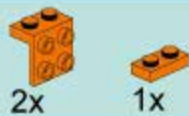

A13

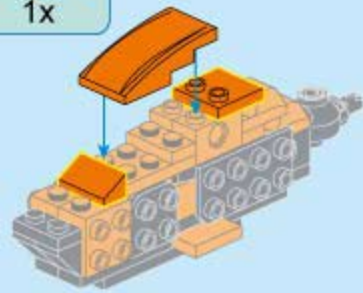
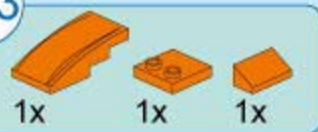

A14

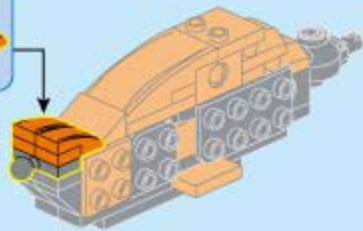
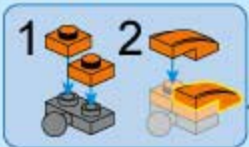

A15

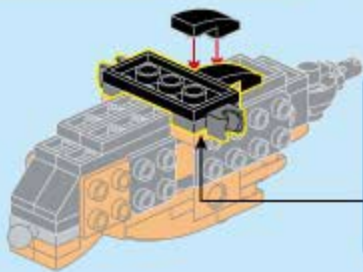

A16

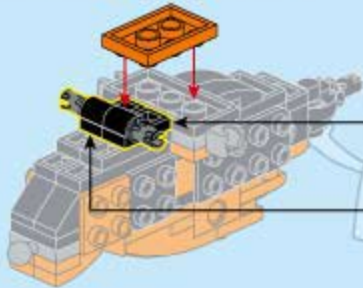

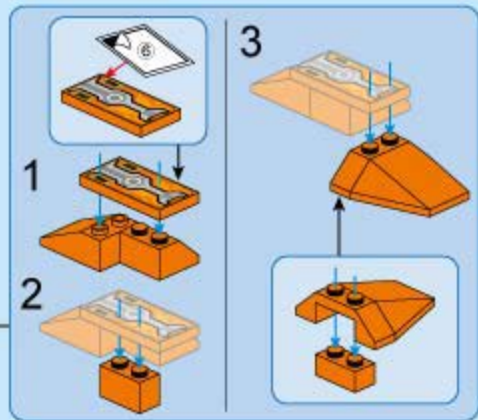
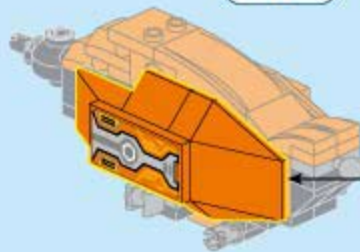
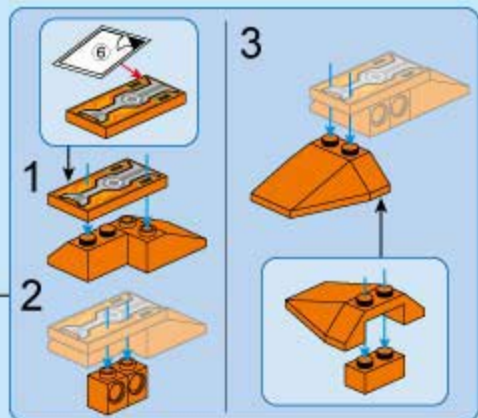
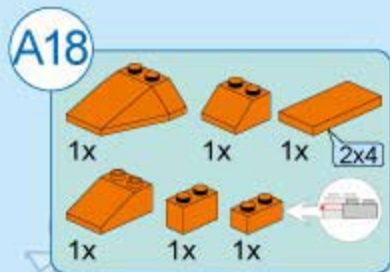
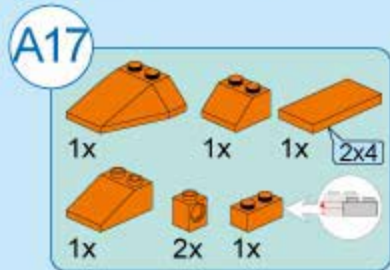

A19

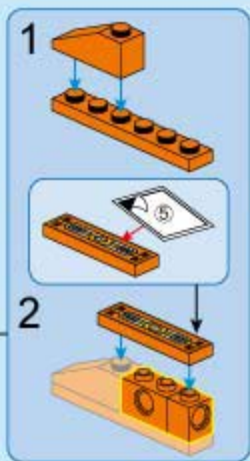
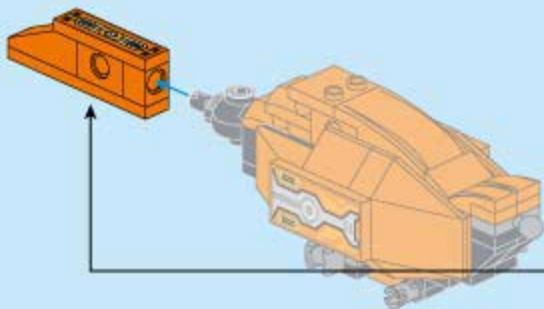
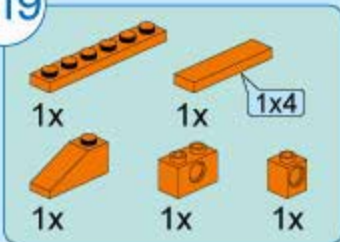

A20

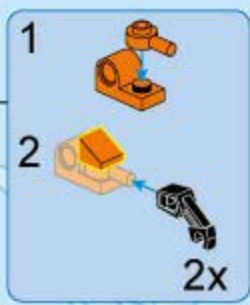



A21



A22

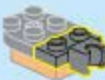

A23



A24



A25

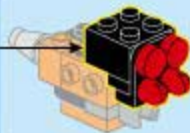

A26



A27

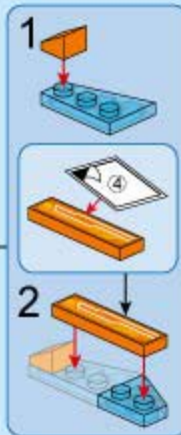
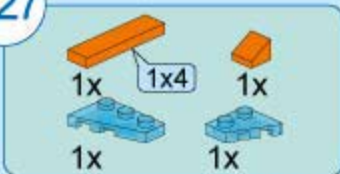

A30



A28

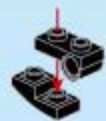

A31



A29

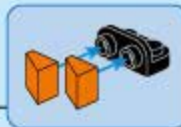

A32



A33

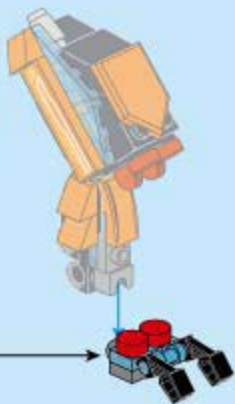
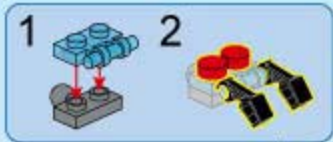

A34

A33

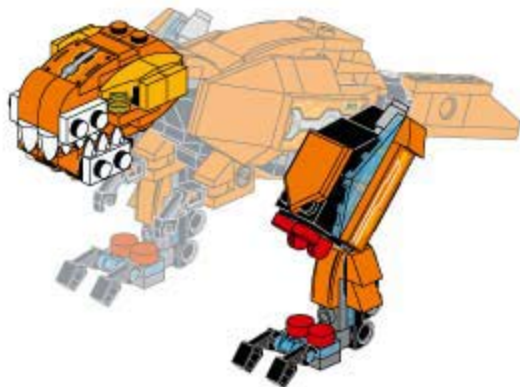
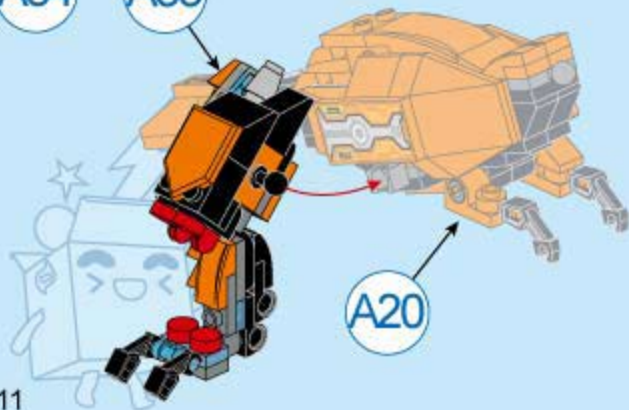



A35



1x

1x



A36



1x



A37



1x

1x

1x



A38



1x

1x

1x

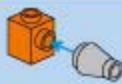

A39



1x

1x

2x

2x

2x

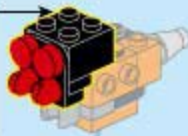

A40



1x

1x



A41

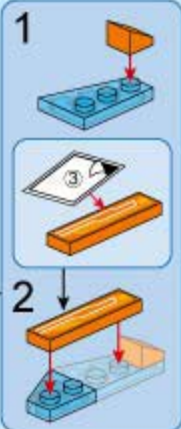
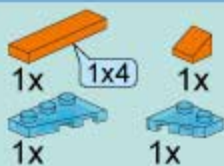

A44



A42



A45



A43

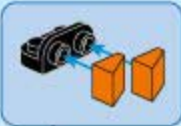

A46

A41

A45



A47

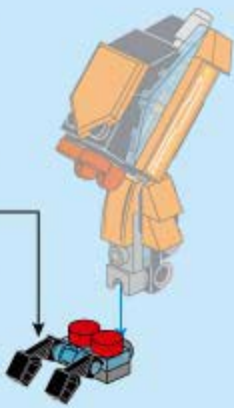

A48

A34

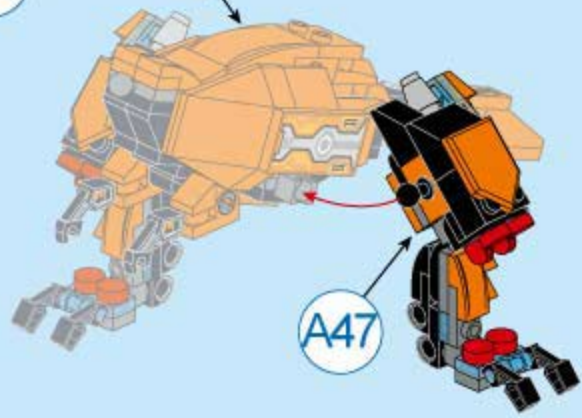

A47

A49



A50



A51



A52



1x

1x

1x

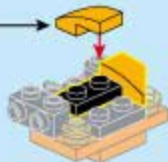

A53



2x

2x



A54

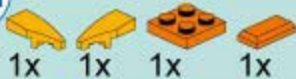

1x

1x

1x

1x



A55



1x

1x



A56



1x

1x



A57



1x

1x

1x



1



2



A58



A59



A60



A61



A62



A63



A64



- 1

Step 1 shows a black 1x3 Technic Technic connector being placed on top of an orange 1x3 Technic brick with holes. Two blue arrows point to the holes on the orange brick, indicating where the black connector's pins should be inserted.
- 2

Step 2 shows an orange 1x2 Technic brick with holes being placed on top of a black 1x2 Technic Technic connector. A blue arrow points to the hole on the orange brick, indicating where the black connector's pin should be inserted.
- 3

Step 3 shows the two sub-assemblies from steps 1 and 2 being joined together. A black 1x3 Technic Technic connector is being inserted into the holes of the orange 1x3 Technic brick with holes. The number '2x' indicates that two of these sub-assemblies are needed.

A65



A64

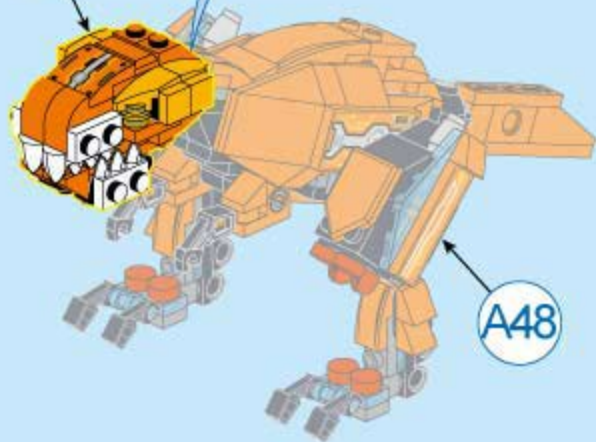



**DIRECTLY
TRANSFORMS**



**DIRECTLY
4-IN-1
TRANSFORMS**

A2



A66

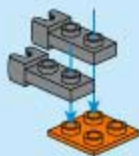

A67



A68

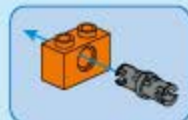

A69

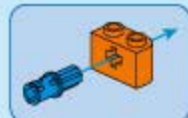

A70

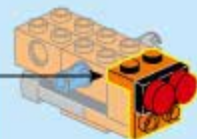

A71



A72

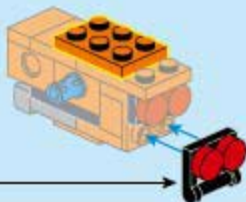

A73

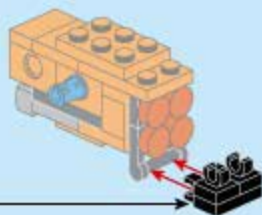

A74

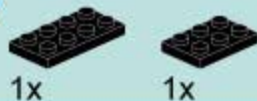

A75



A76



A77

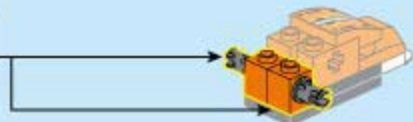

A78



A79



A80



A81

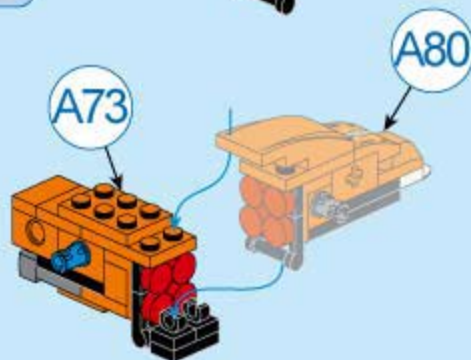

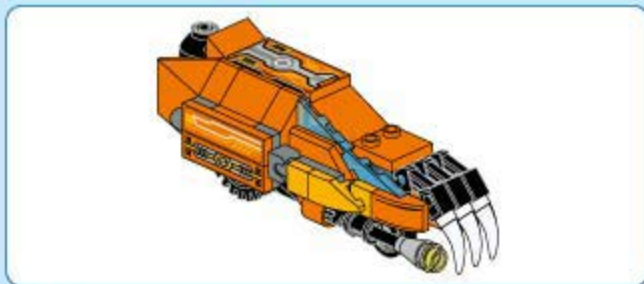

A82

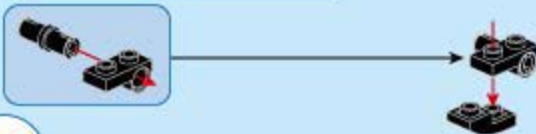

A83



A84

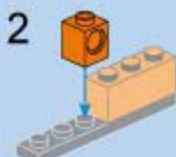
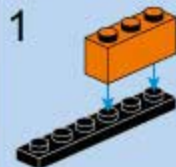
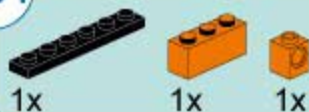

A85

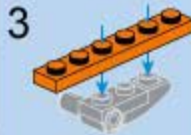
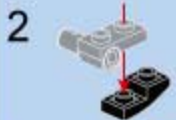
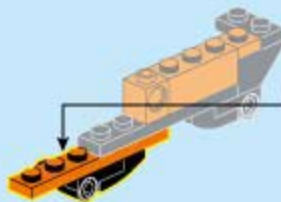
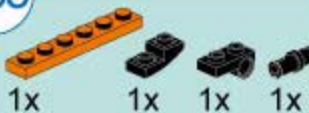

A86



A87

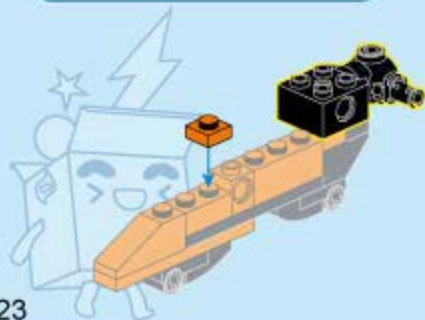

A88



A89

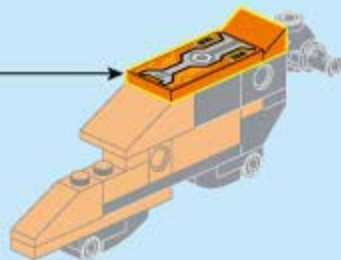
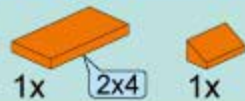

A90

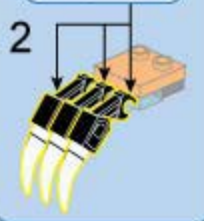

A91



A92



A93



A94



A95

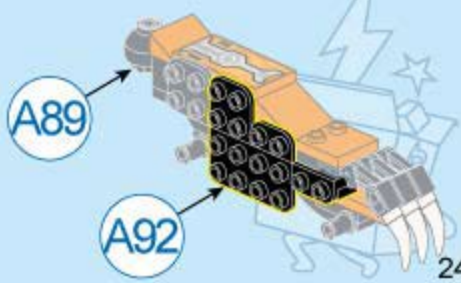

A96

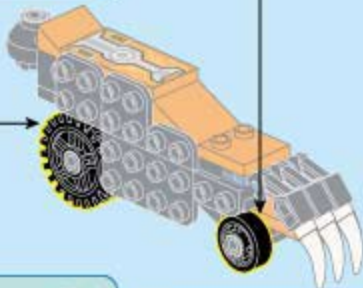

A97

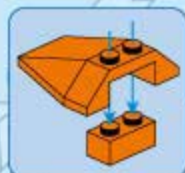
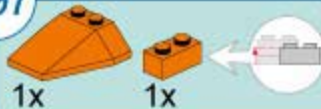

A98

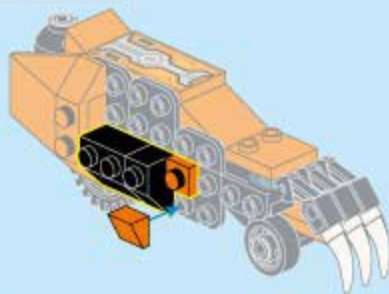

A99

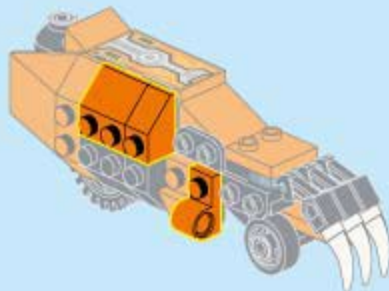

A100



A101



A102

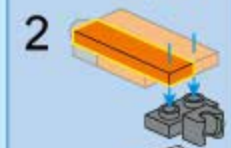
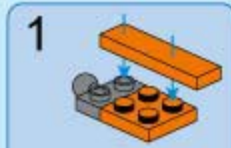
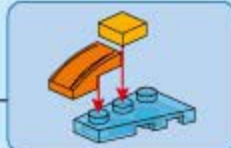
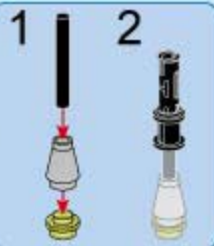
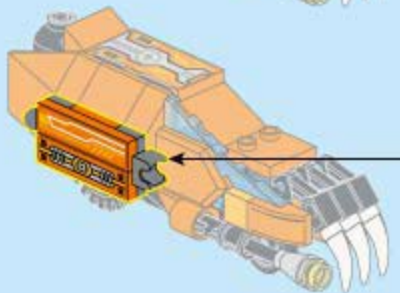
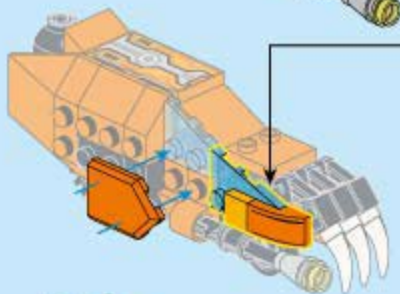
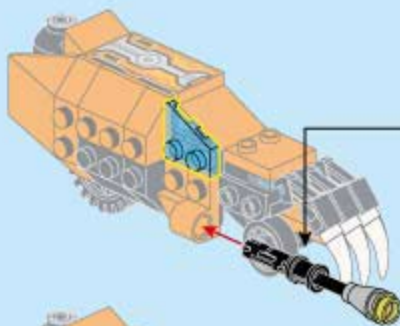

A103

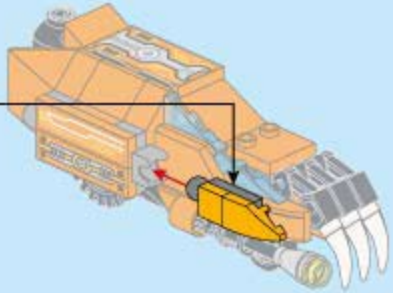

A104



A103

A81

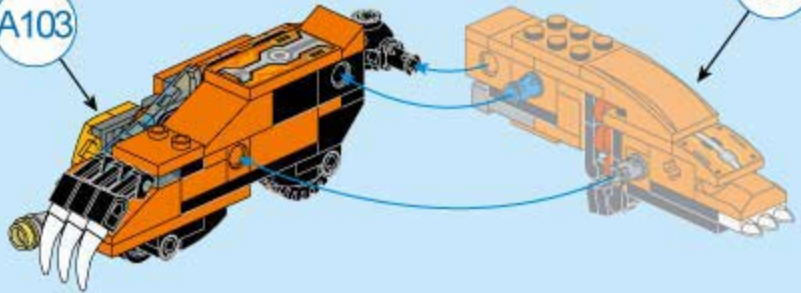



A105

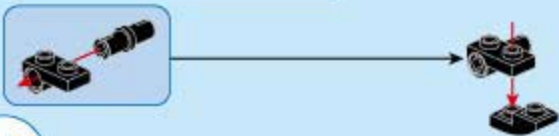

A106



A107

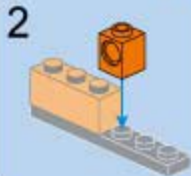
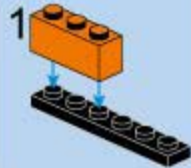
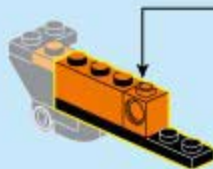
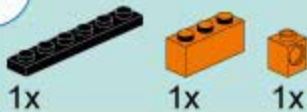

A108

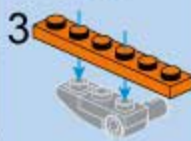
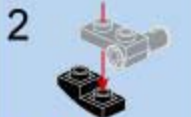
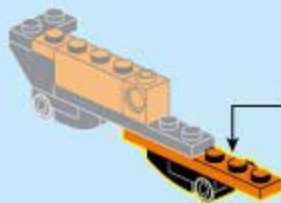
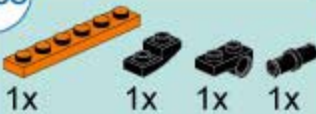

A109



A111



A110

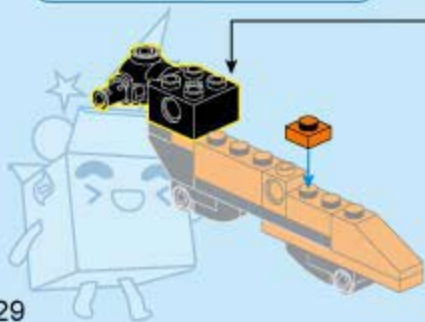

A112

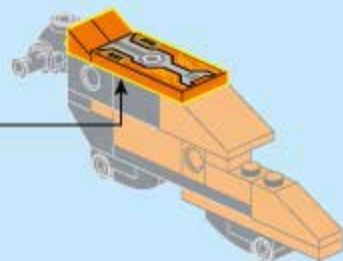

A113

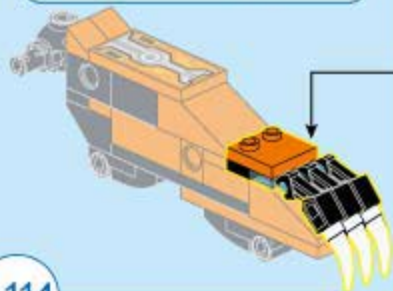

A114

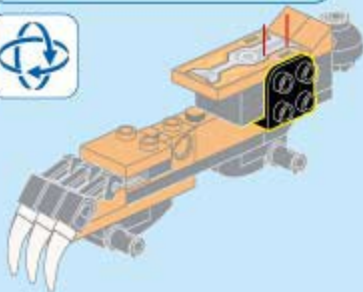

1



3x

2

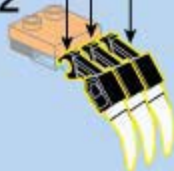

A115



A116



A117

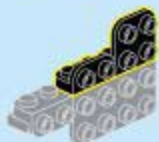

A118

A114

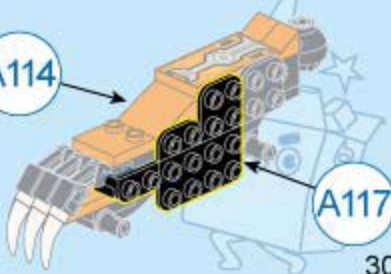

A117

A119

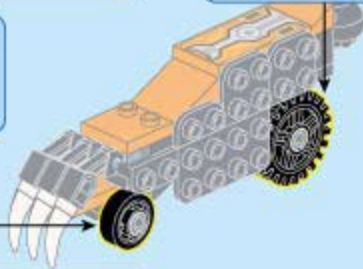

A120

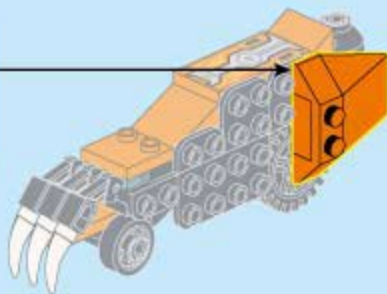
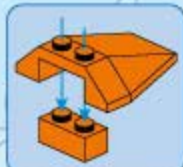
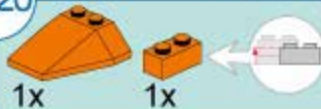

A121

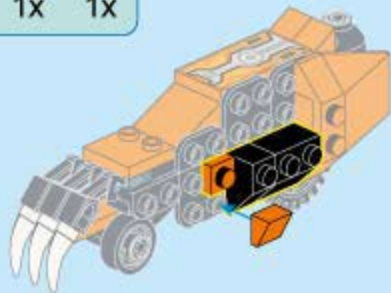

A122



A123

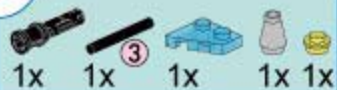

A124



A125

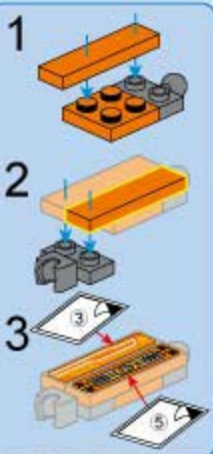
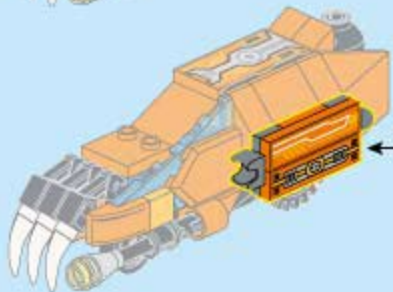
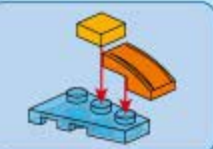
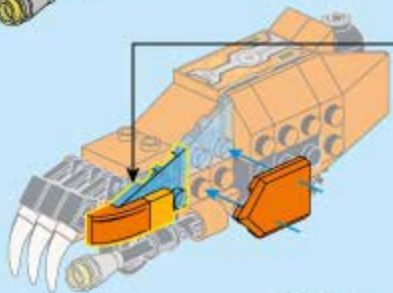
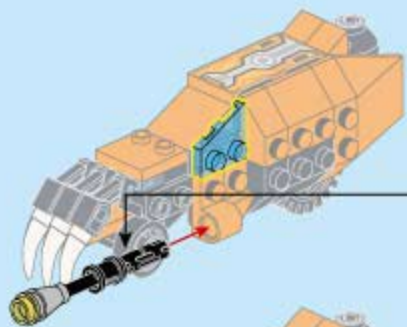

A126

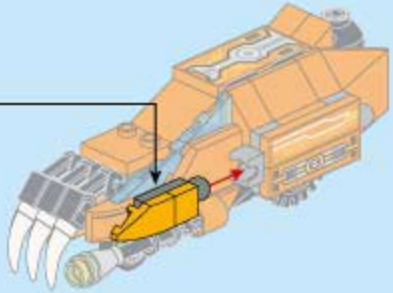

A127

A104

A126

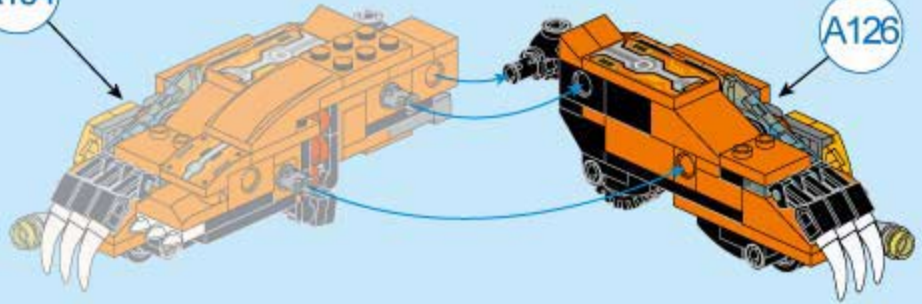

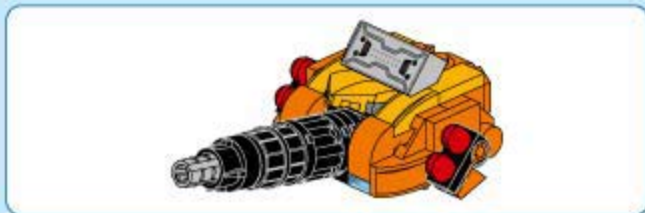

A128

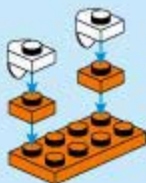

A129



A130



A131



A132

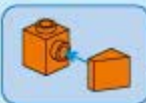

A133

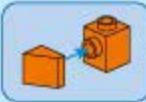

A134



2x



1x



A135



2x



1x



A136



1x

6



1x

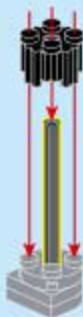

6

1:1

A137



1x



1x



A138



1x



1x



A139

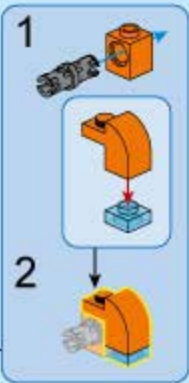

A140

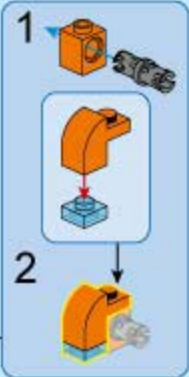

A141

A133

A140

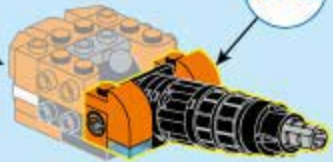

A142



A143

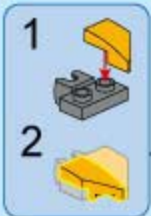

A144

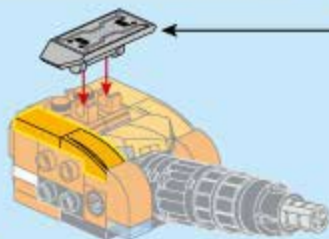

A146

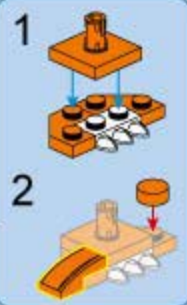
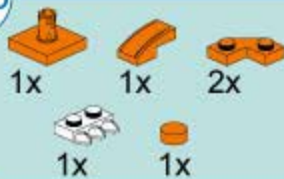

A145

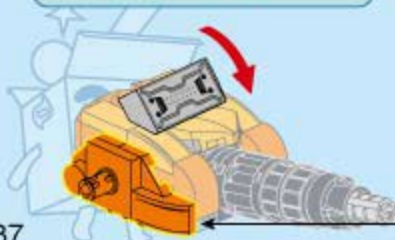
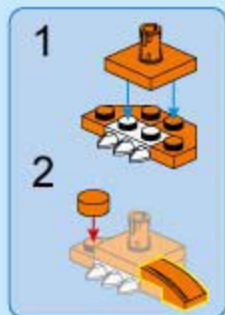

A147

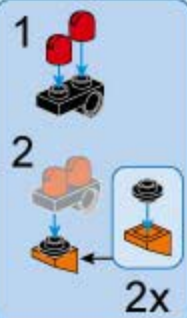
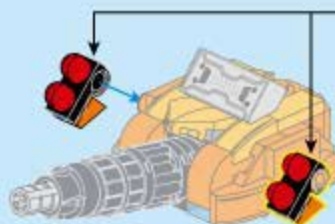

A148

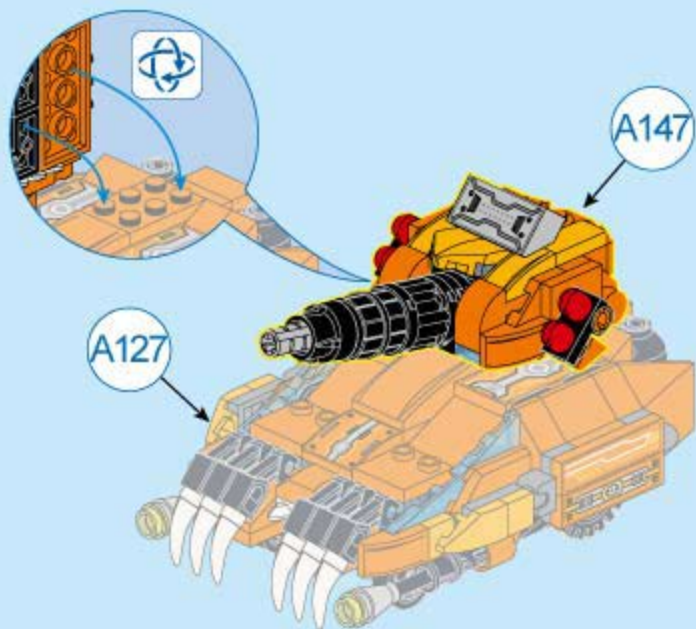

B1

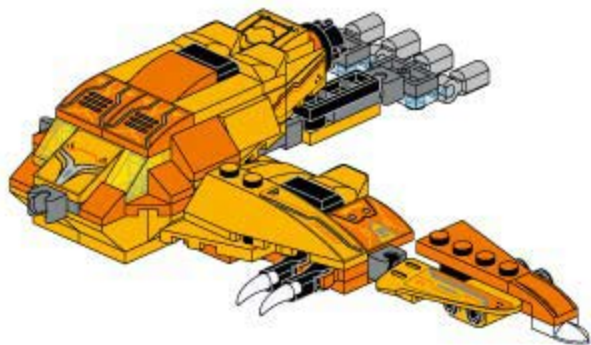

B1

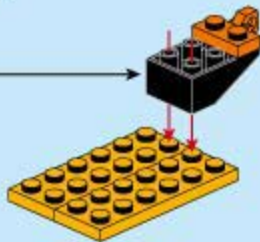
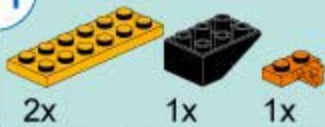

B2

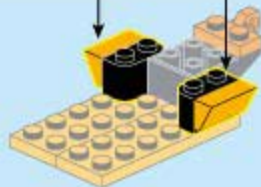

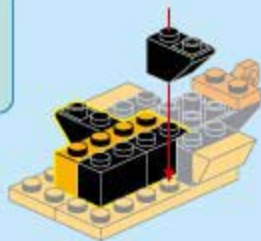
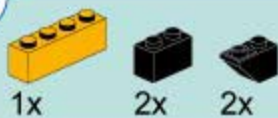
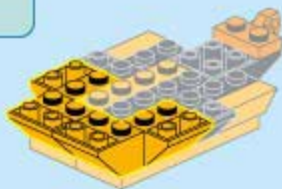
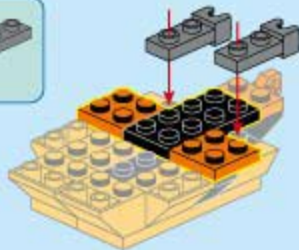
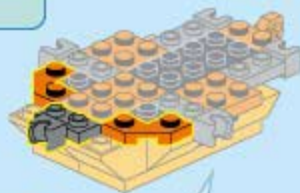
B3**B4****B5****B6****B7****B8**

B9

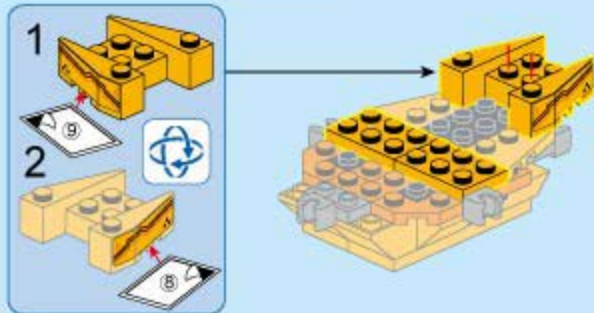
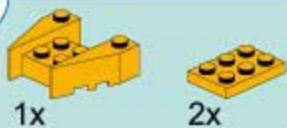

B10

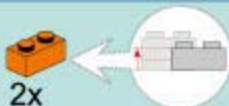

B11



B12



B13



B14

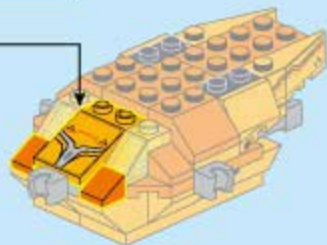

B15

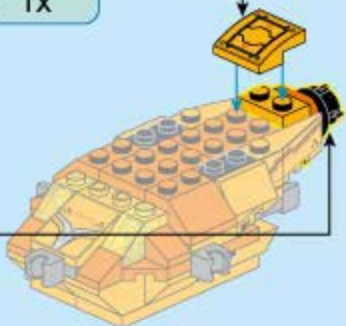
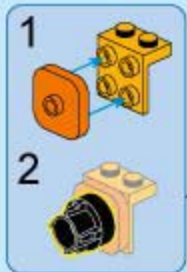

B16

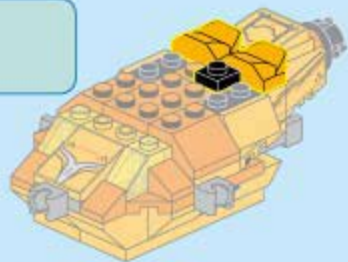

B17

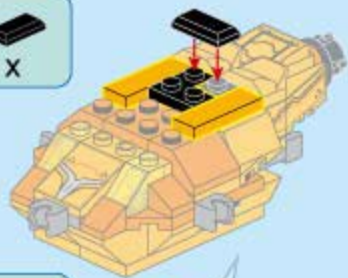

B18

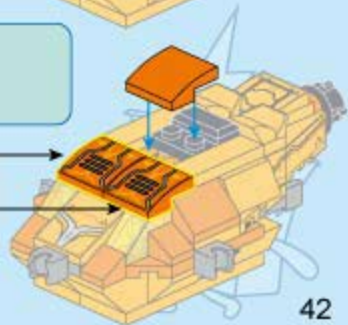



B23



1x

1x



B24



2x



B25



1x

1x



B26



1x

1x

2x



B27

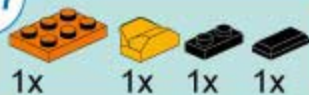

1x

1x

1x

1x



1

2



B28



1x

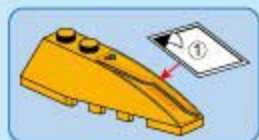
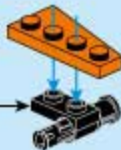
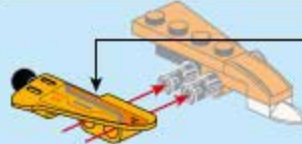
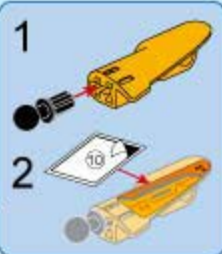
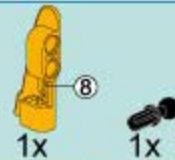

B29**B30****B31****B32****B33****B34**

B35



B30

B34

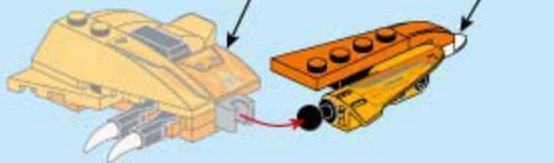

B36

B22

B35

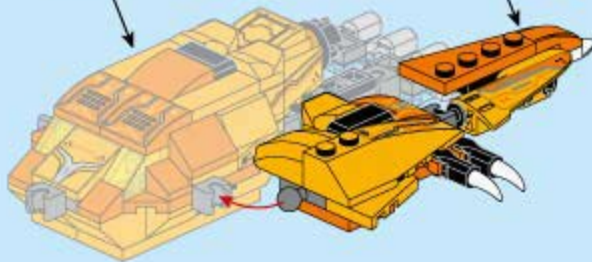

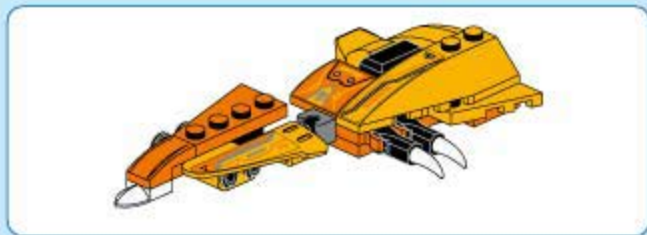

B37



B38



B39



B40

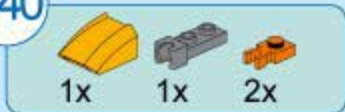

B41

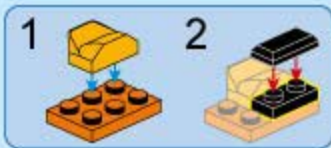

B42



1x



B43



1x



2x



2x



B44



1x



B45



1x



1x



1x

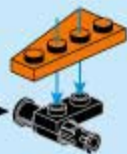

B46



1x



1x



B47



1x



1x



B48

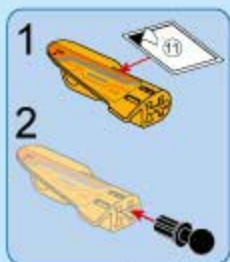
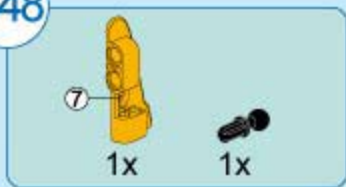

B49



B48

B44

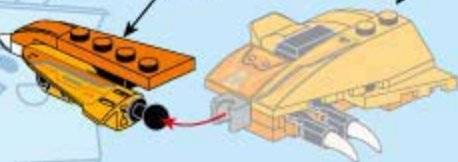

B50

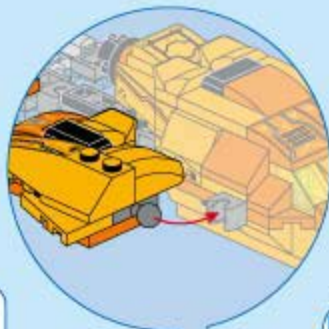

B36

B49

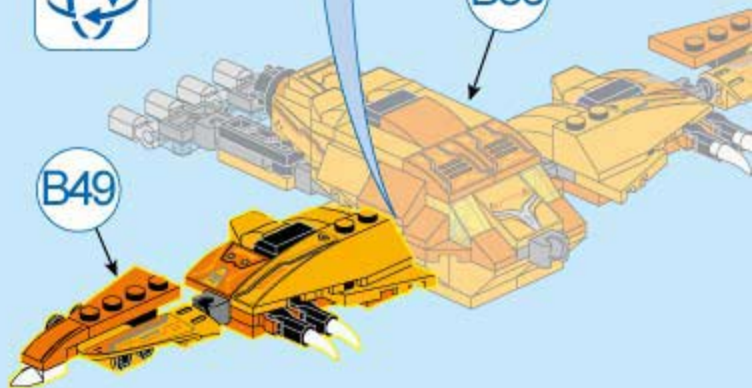



B51



B52



B53

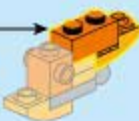

B54

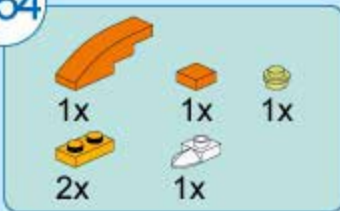

B55

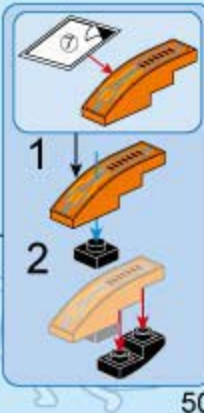
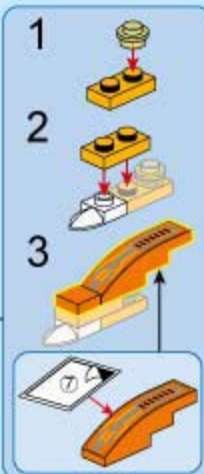
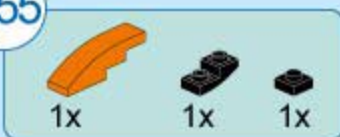

B56



1x



1x

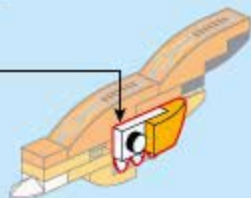

B57



1x



1x

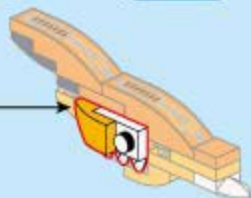

B58

B50

B57

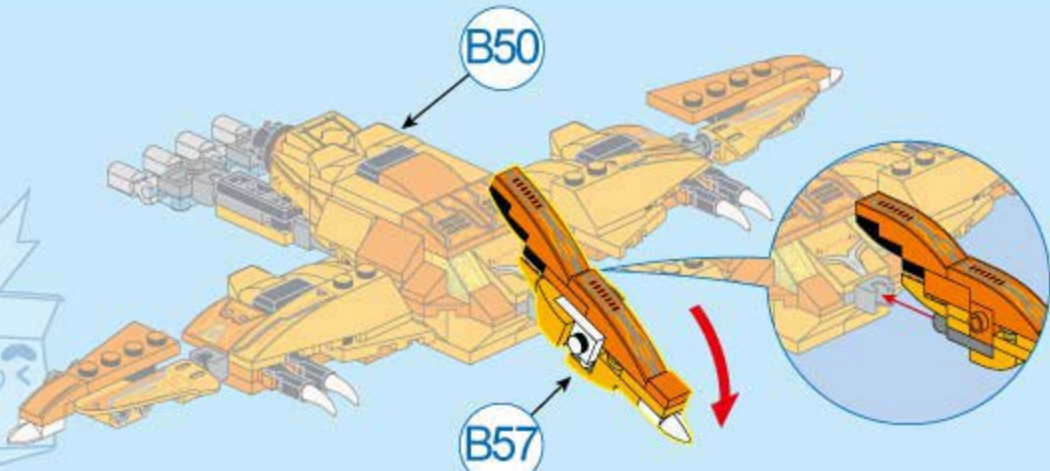



**DIRECTLY
TRANSFORMS**



**DIRECTLY
4-IN-1
TRANSFORMS**

B2



B59

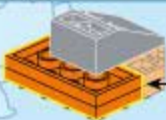
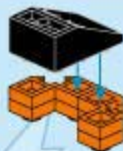

B60

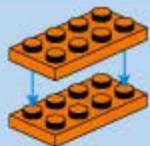

B61

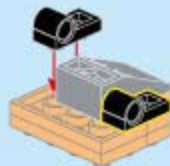

B62

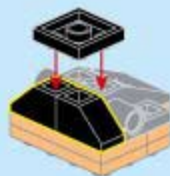

B63

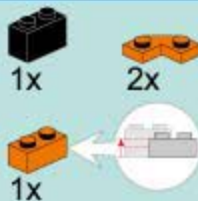

B64

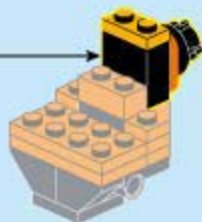
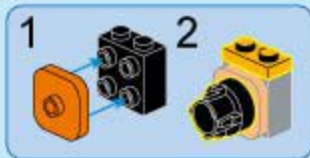

B65

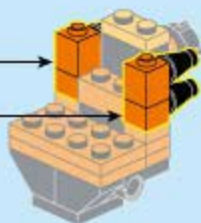
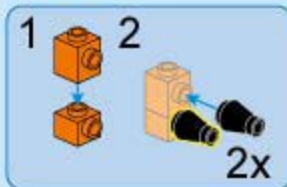

B66

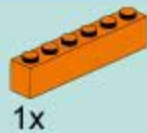

B67

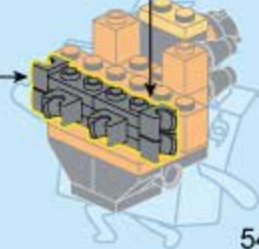
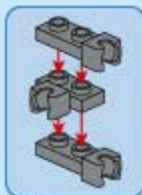
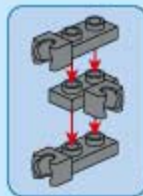
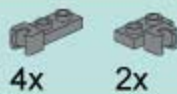

B68

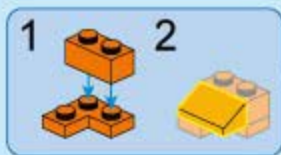
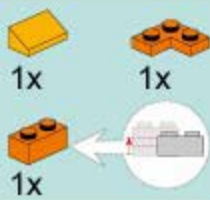

B70

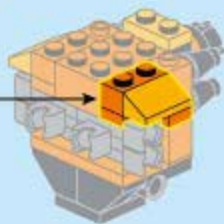
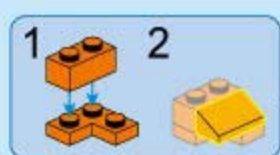
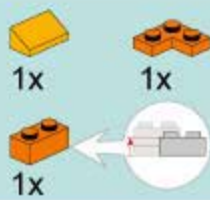

B69

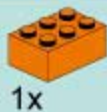

B71

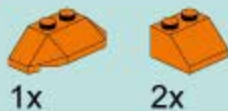

B72

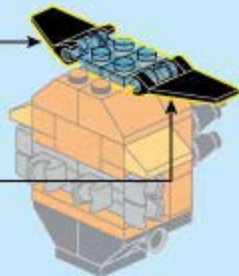

B73

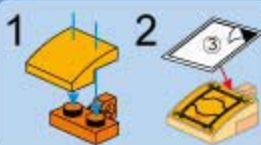

B74

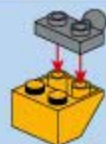
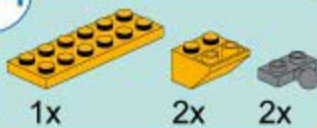

2x

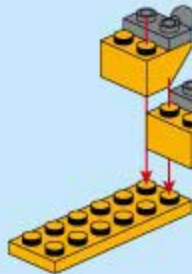

B75

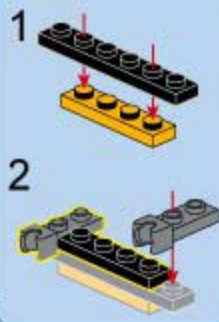
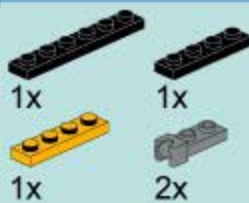

B77

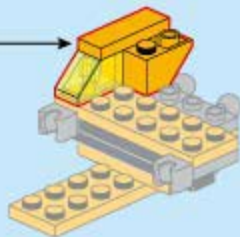
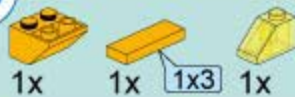

B76

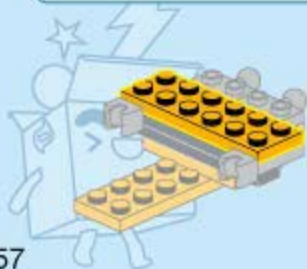
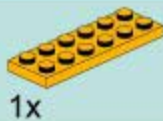

B78

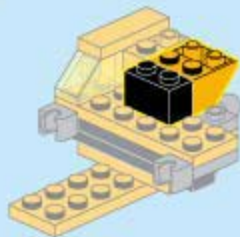

B79

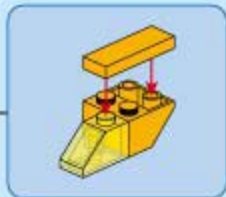
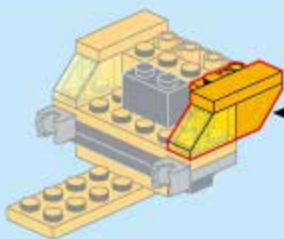
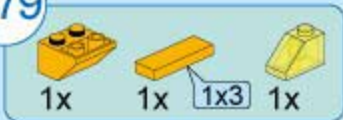

B80

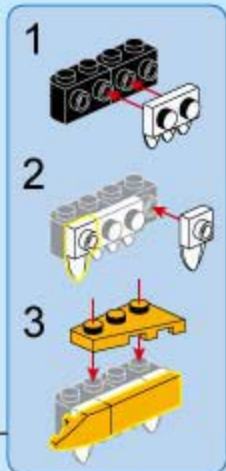
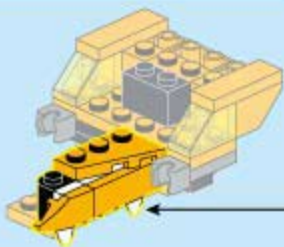
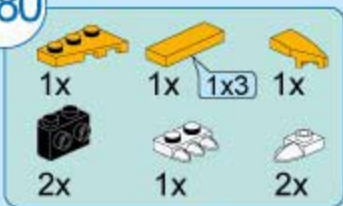

B81

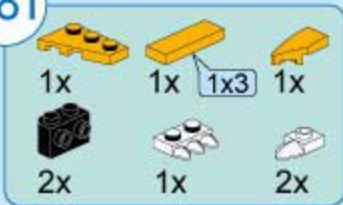

B82

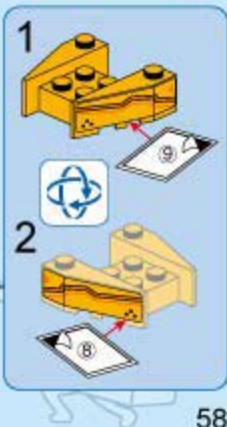
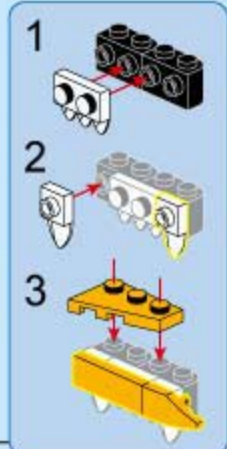
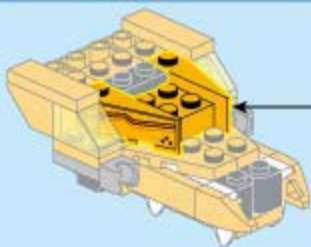
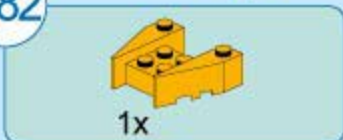

B83

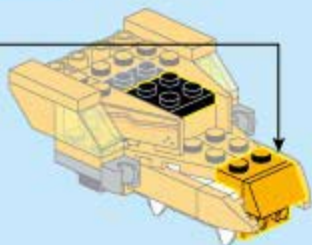
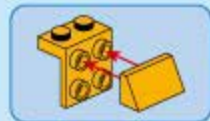

B85

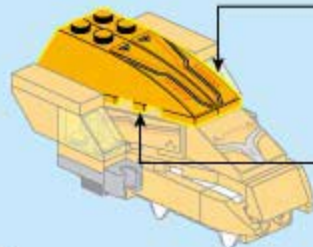
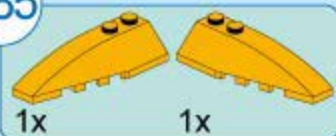

B84



B86

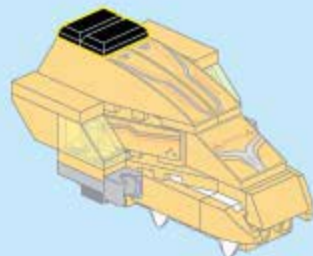

B87



B88

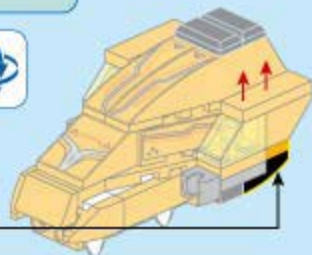

B89

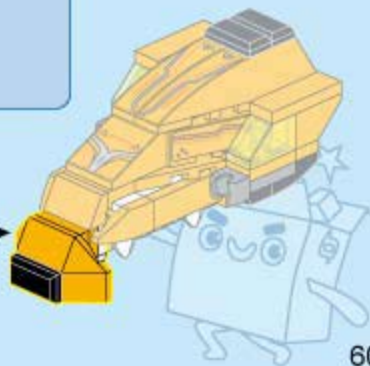
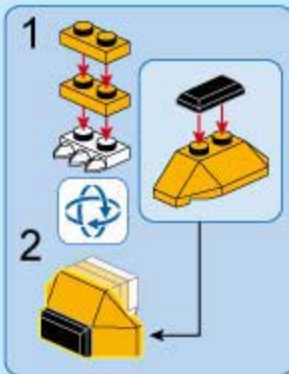

B90

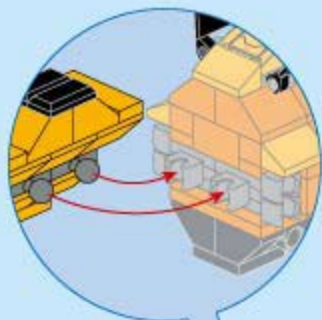

B73

B89

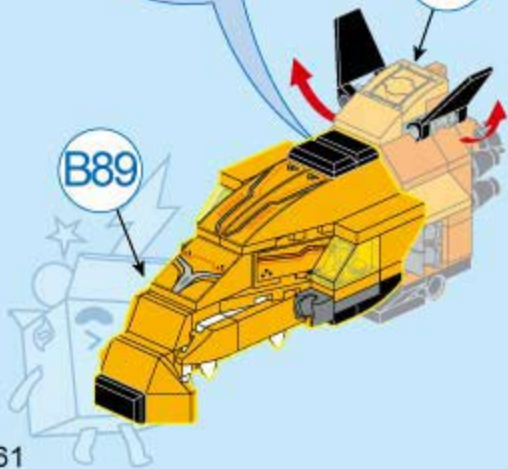

61



③ 1:1

B91

1x ③ 1x 1x

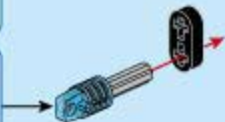

B92

1x ③ 1x 1x

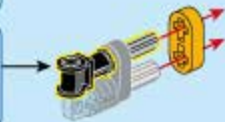

B93

2x

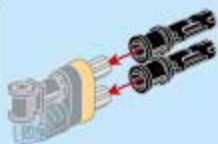

B94

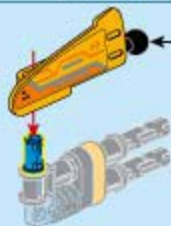

B95

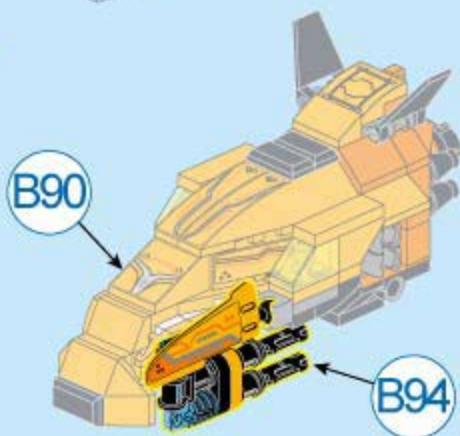

B96



B97



B98



B99



B100



B101



B102



B103

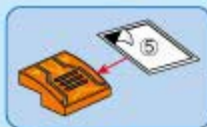

B104



B105

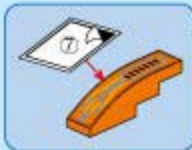

B106

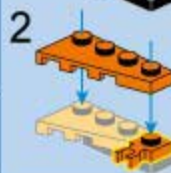
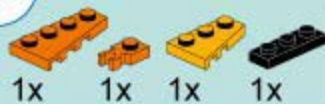

B107



B108

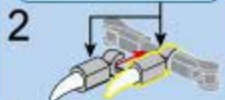
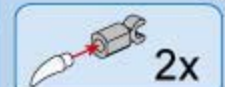
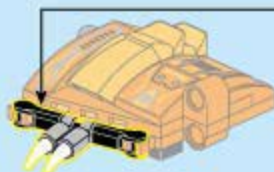

B109



B110

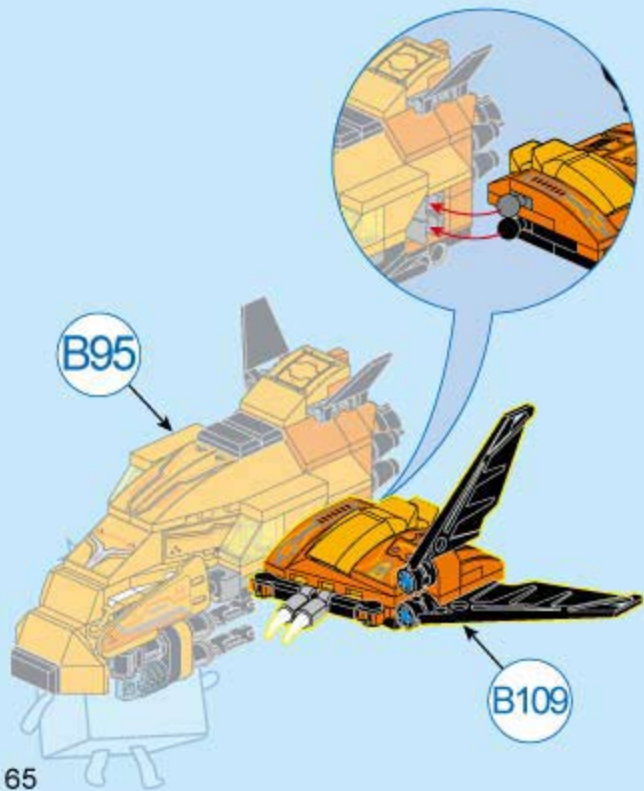

B111



B112



B113



B114

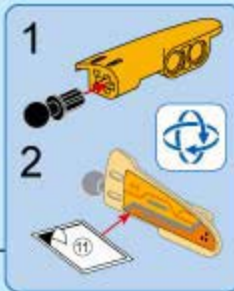
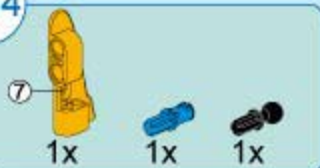

B115

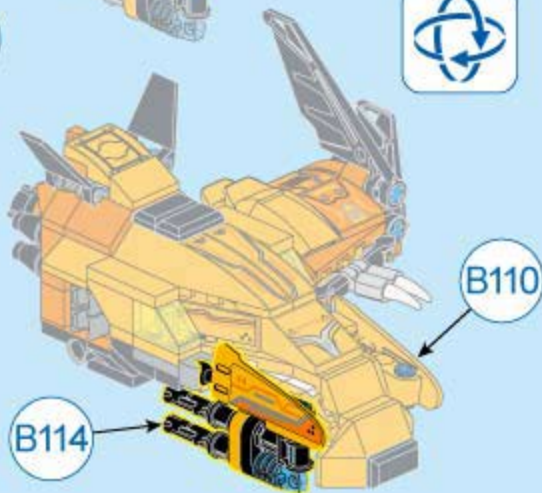

B116



B117



B118



B119



B120



B121



B122



B123



B124



B125



B126

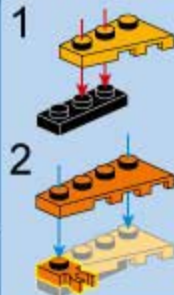
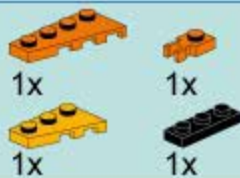

B128

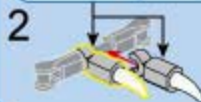
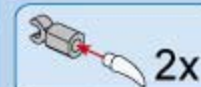

B127



B129

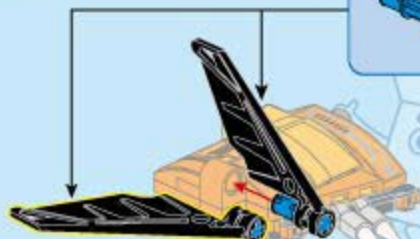

B130

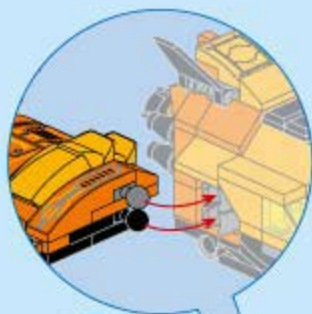

B129



B115



C1



5

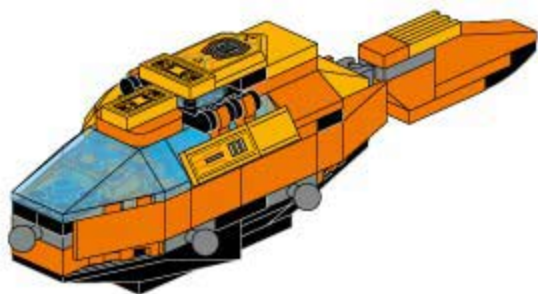

C1



1x

1x



C2



1x

1x

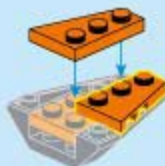

C3



1x

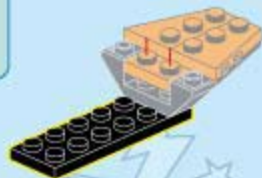

C4



2x



C5

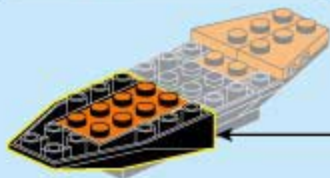
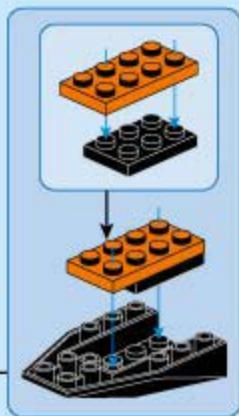
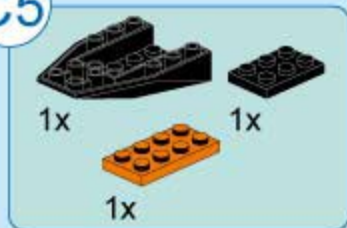

C6



C7

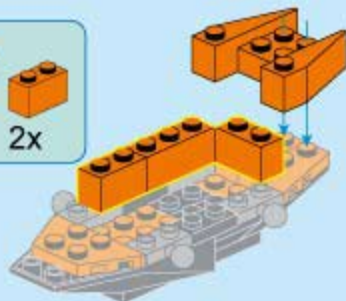
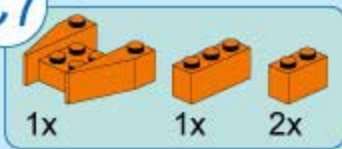

C8

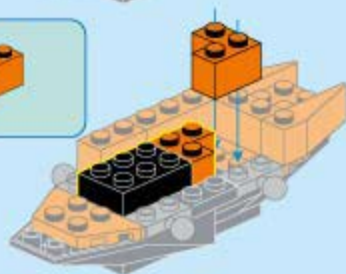

C9

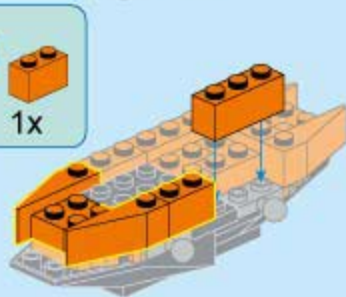
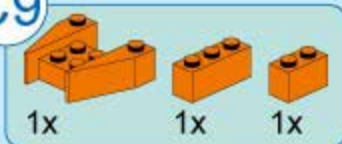

C10

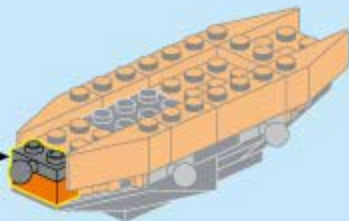

C11



C12



C13

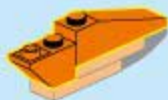
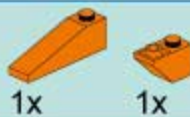

C14

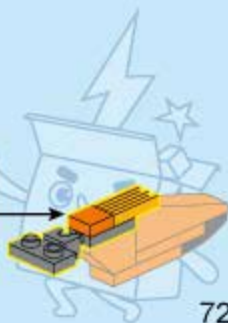
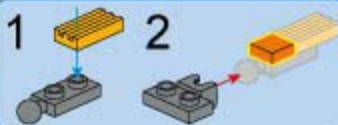

C15



C11

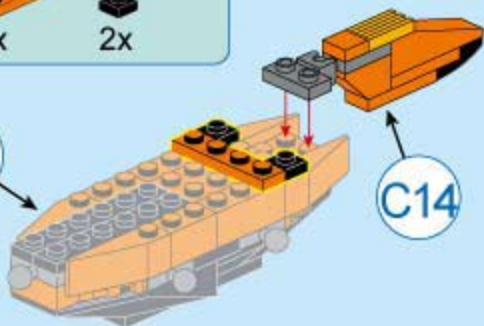

C17

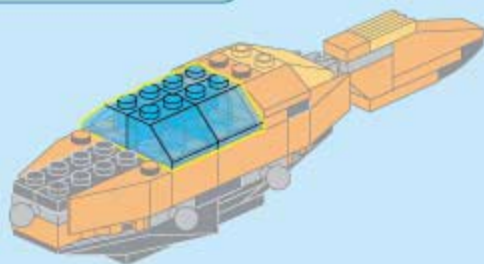

C16

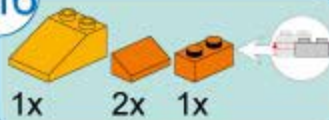

C18

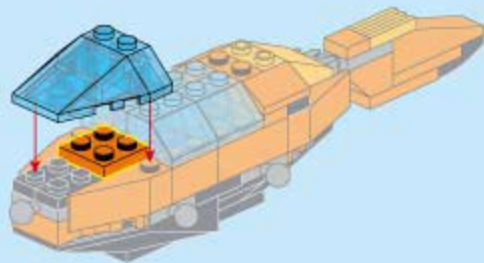

C19

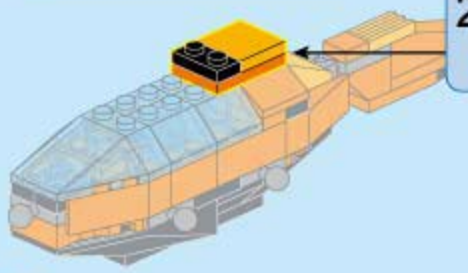
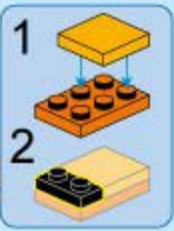

C21

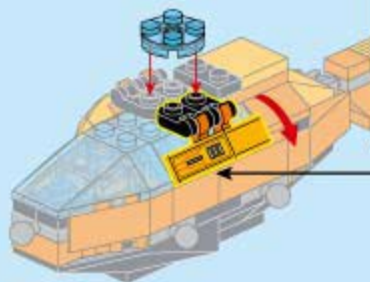
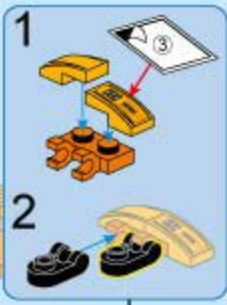

C20

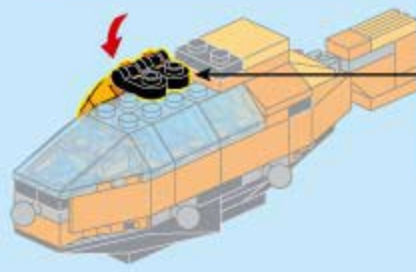
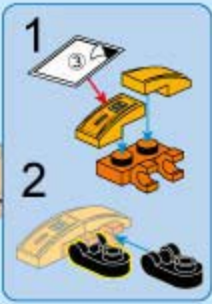

C22

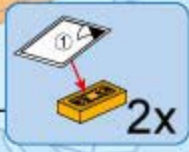
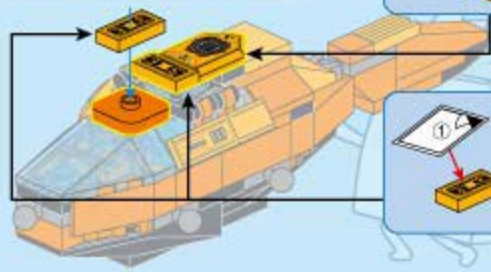

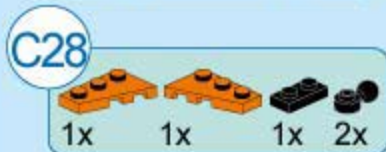
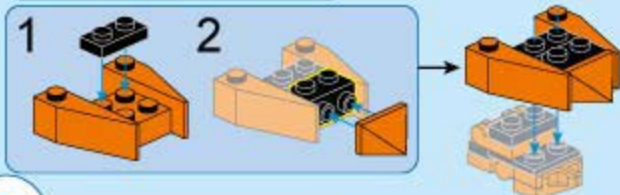
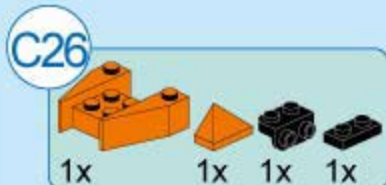
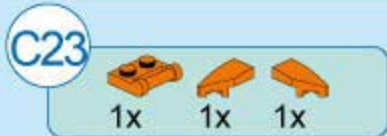

C29

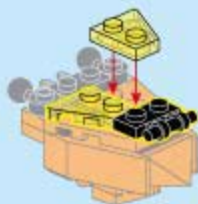

C30

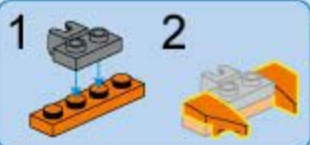

C31

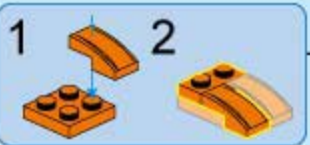

C32

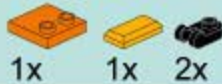

C33

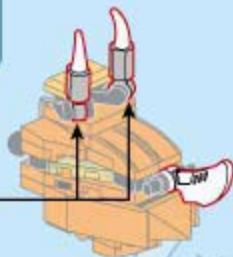
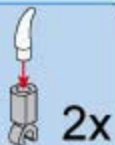

C34



C35



1x 1x 1x

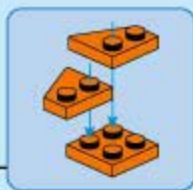

C36



1x 1x



C37

C36

C33

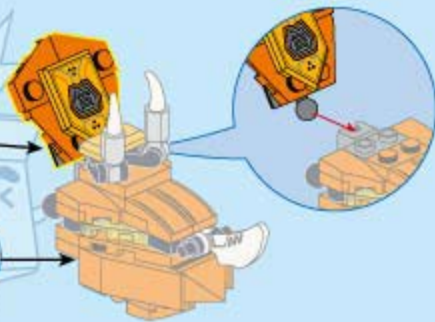

C38



1x 1x

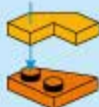

C39



1x 1x 1x



C40



1x 2x

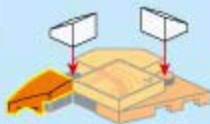

C41

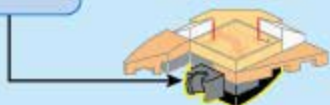

C42

C37

C41

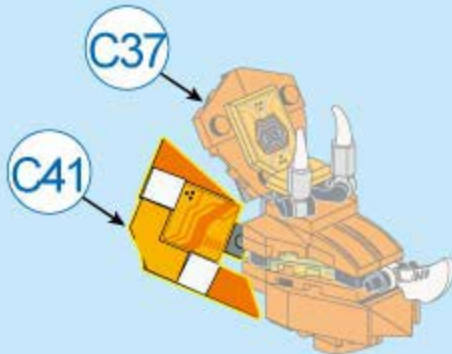

C43

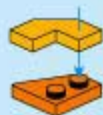

C44



C45



C46



1x



2x

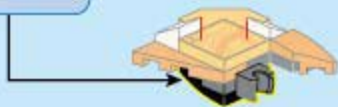

C47



C42

C46



C48



C47

C22

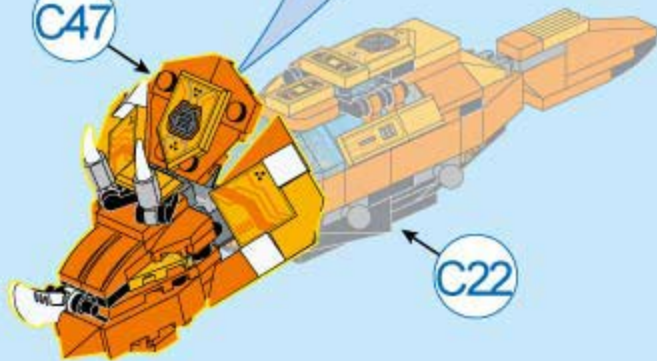

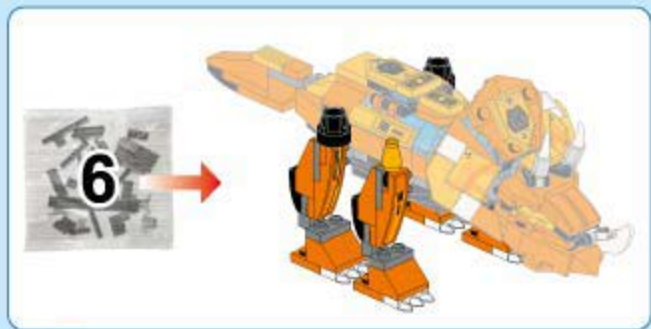

C49

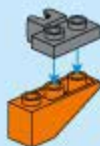

C50

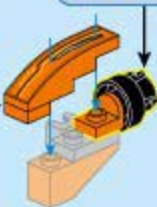
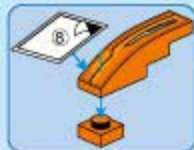
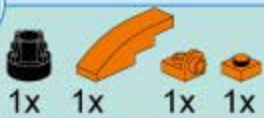

C51



C52

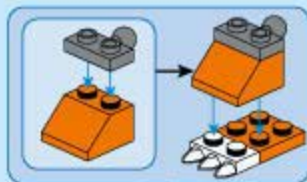

C53

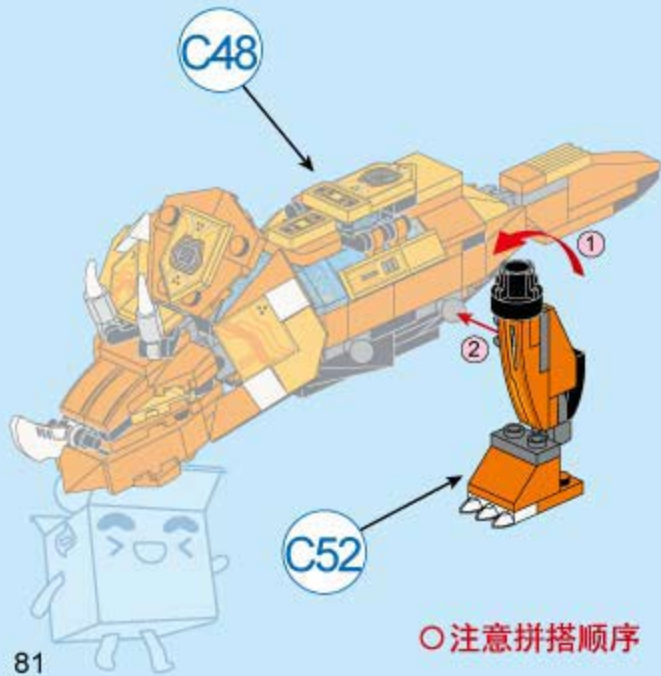

○注意拼搭顺序



C54



C55

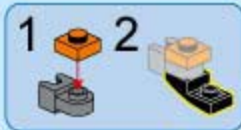

C56



C57

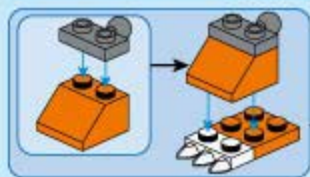
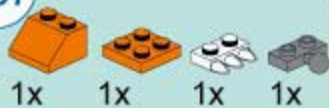

C58

C53

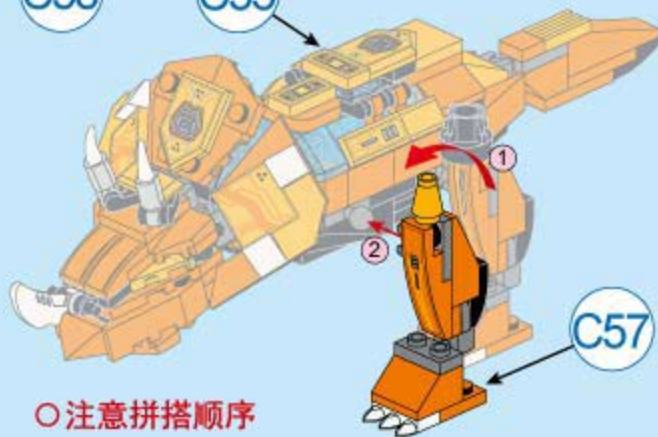

○ 注意拼搭顺序

C59

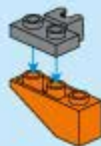

C60

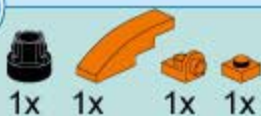

C61

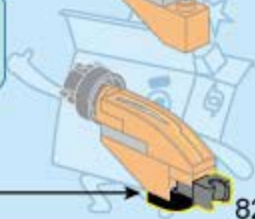

C62

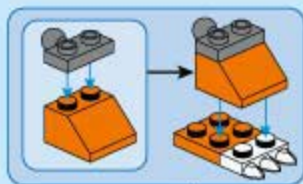

C63



C58



C62

○ 注意拼搭顺序

C64

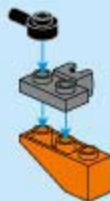

C65

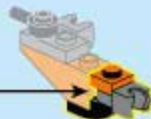

C66



C67

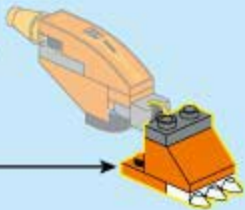
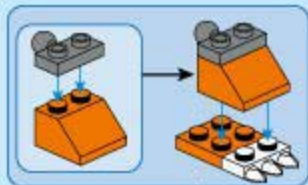

C68

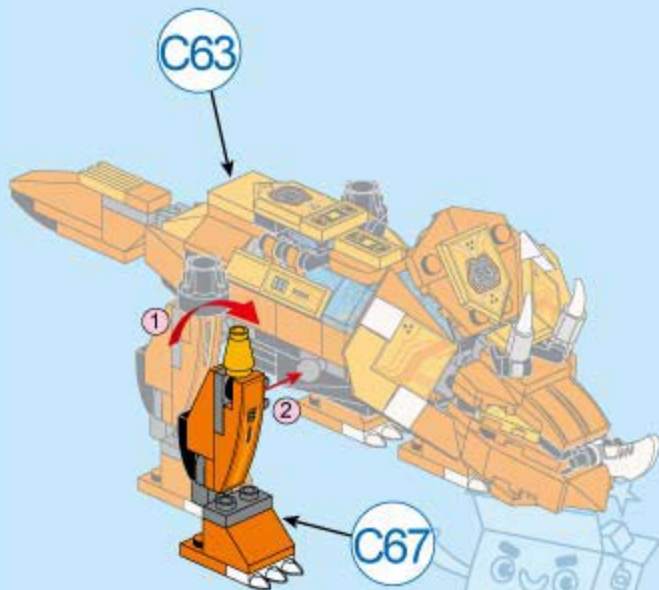

○ 注意拼搭顺序



C2



C69



1x

1x



C70



2x

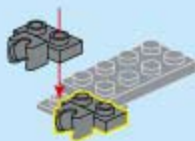

C71



2x

4x

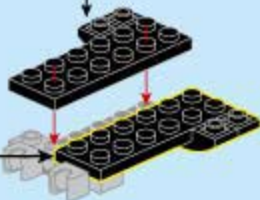
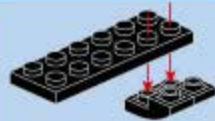
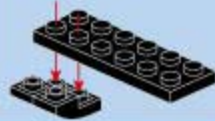

C72



3x



C73

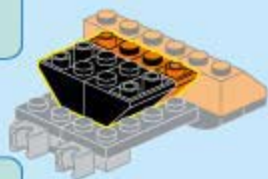

C74

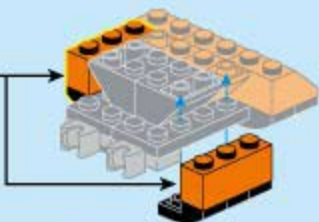
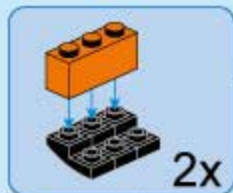

C75



C76

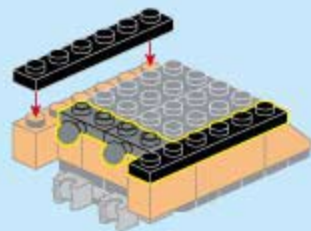

C77

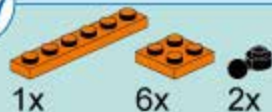

C82

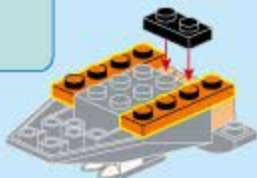

C83



C84



C85



C86

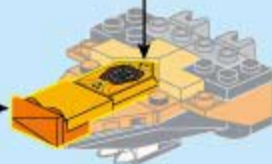
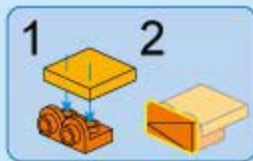

C87



C88

C78

C87

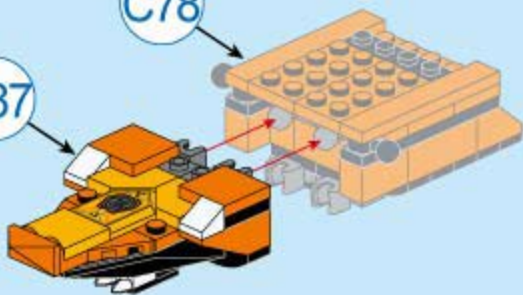

C89

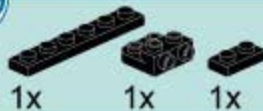

C90

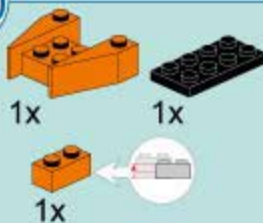

C91

2x 2x 2x



C92

1x 1x 1x



C93

1x 2x

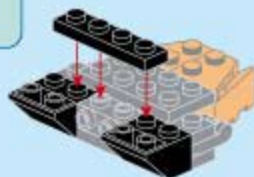

C94

1x 1x 1x
1x 1x

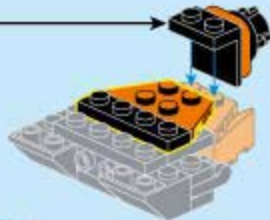

C95

1x 1x



C96



1x

1x



C97



2x

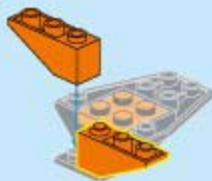

C98

C94

C97

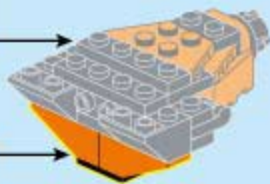

C99



2x

2x



2x

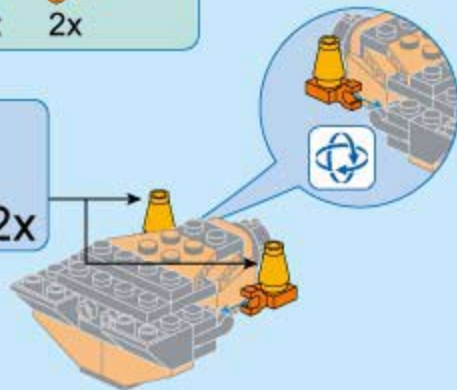

C100

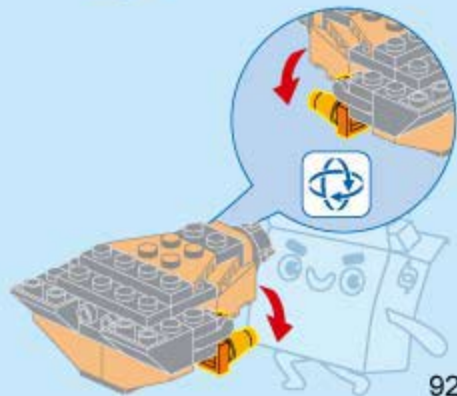



C105



C106

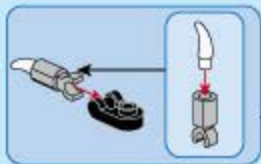

C107

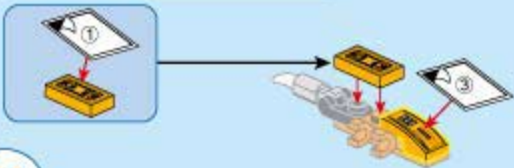

C108



C109

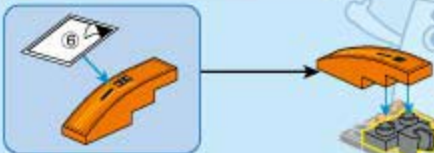
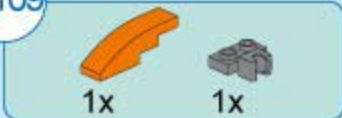

C110



1x

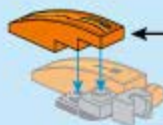
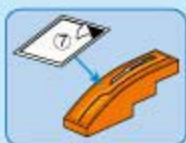

C111



C107

C112

C104

C111

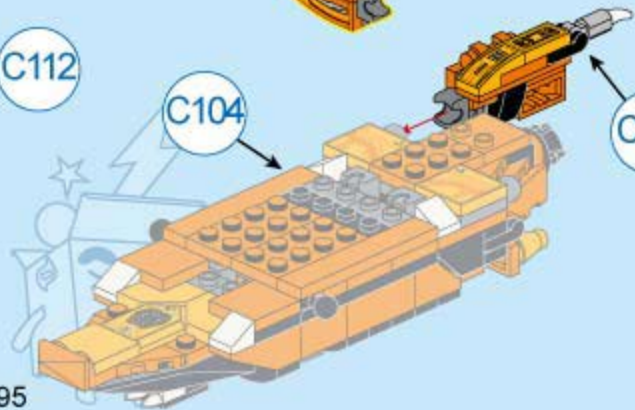

C113



1x



1x



C114



1x



1x



1x

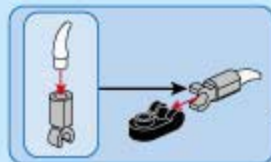

C115



1x 1x



C116



1x 1x



C117



1x 1x

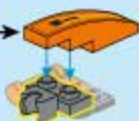
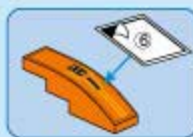

C118



1x

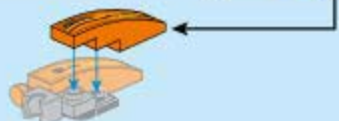
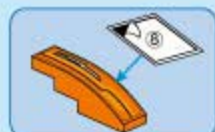

C119

C115

C118



C120

C112

C119

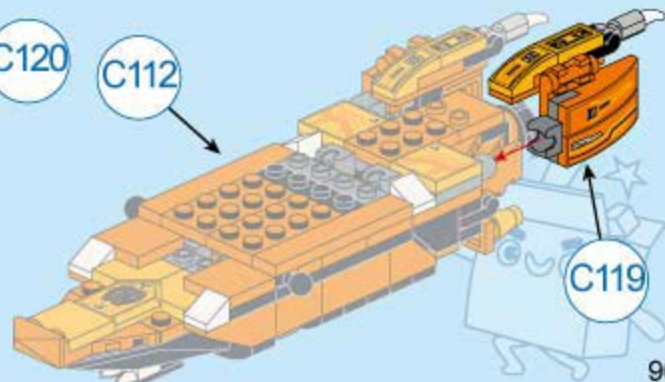

C121



1x

2x

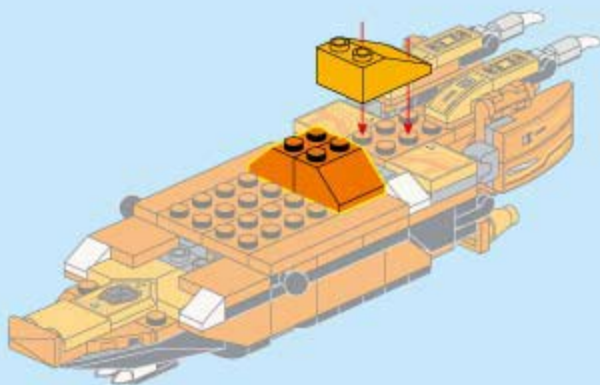

C122



4x

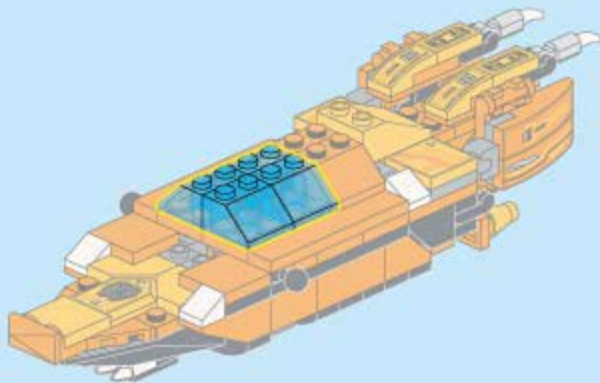

C123

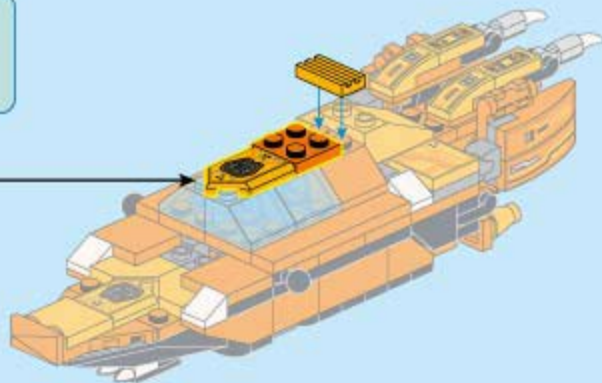

C124

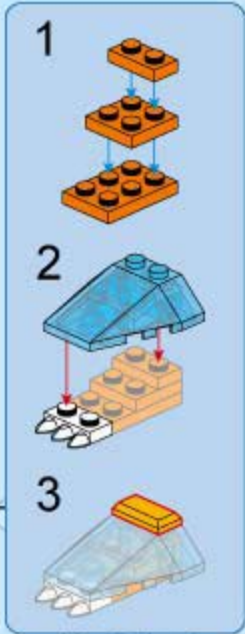
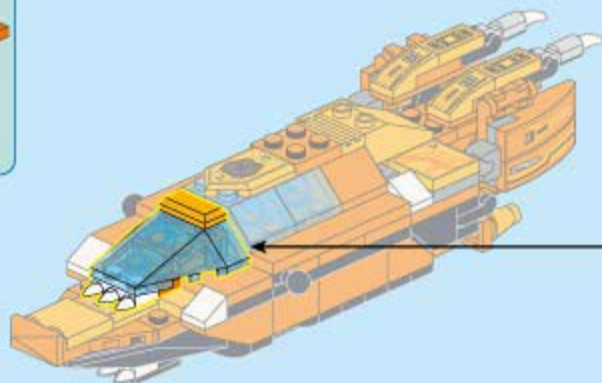
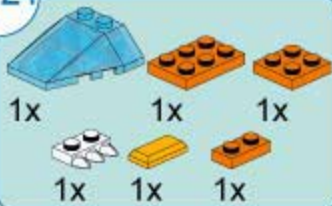

D1



D1



D2



D3



D4

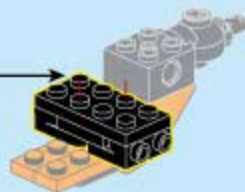
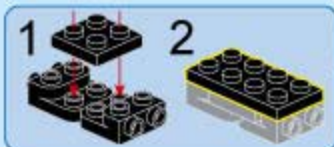

D5

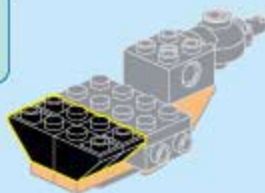

D6

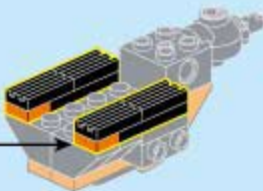

D7

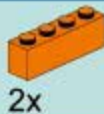

D8

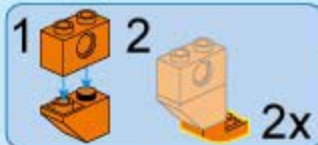

D9

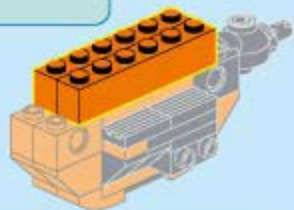
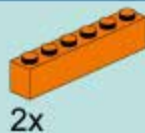

D10

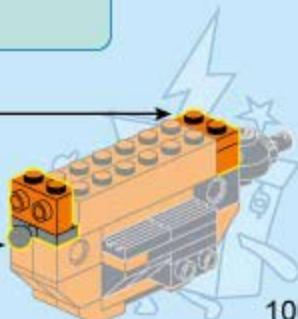
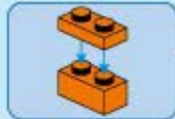
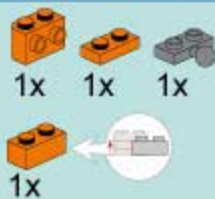

D11



D12

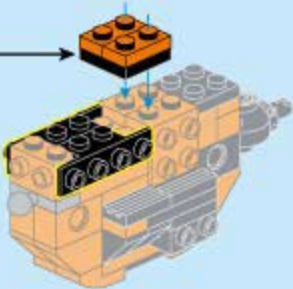

D13

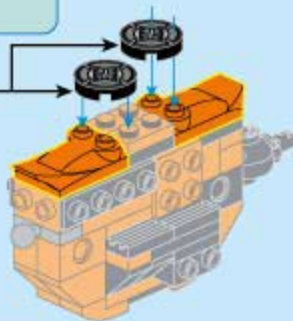

D14

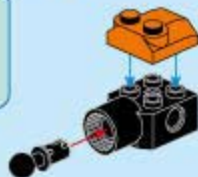

D15

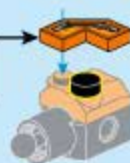

D16



1x



D17

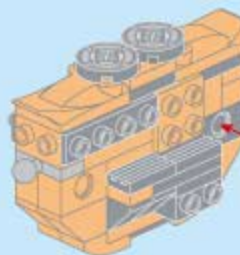

D13

D16



D18



1x

1x



D19



1x



1x



D20



1x



2x



D21

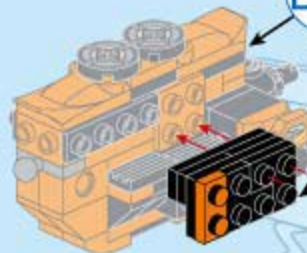

D17

D20

D22



4x

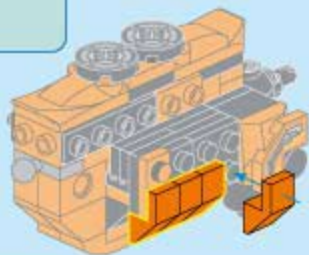

D23



1x



1x



1x



D24



2x



1x

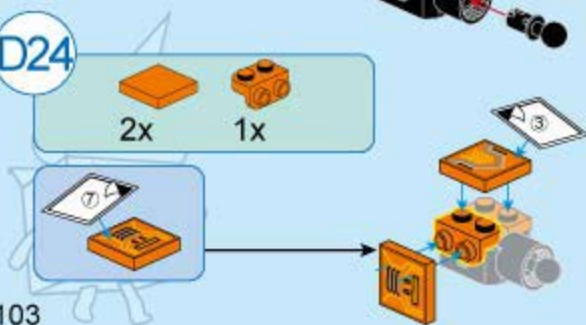

D25



1x



D26

D22



D25

D27



2x



1x



D28



D29

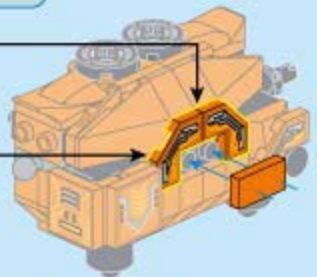

D30



D31



D32



D33



D29

D32

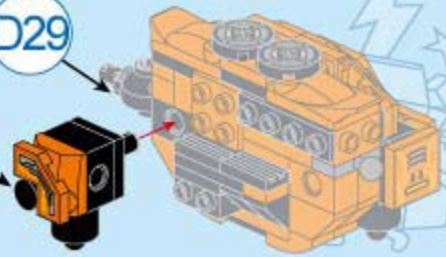

D34



D35



D36

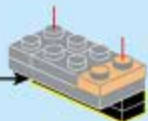
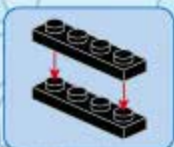

D37

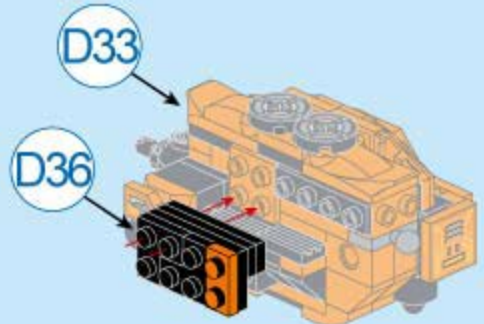

D38



D39



D40

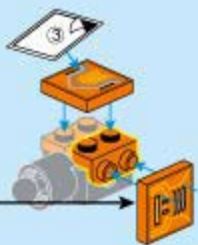

D41



D42

D38



D41



D43

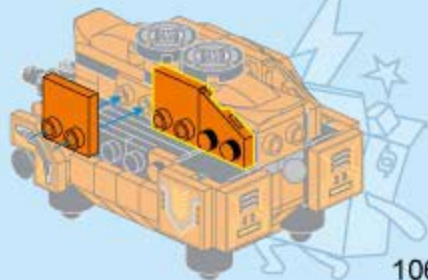

D49



D50



D51

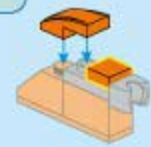

D52

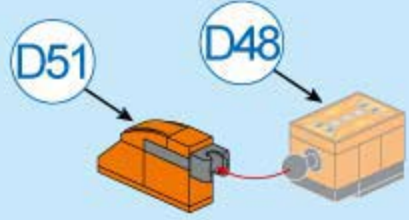

D53

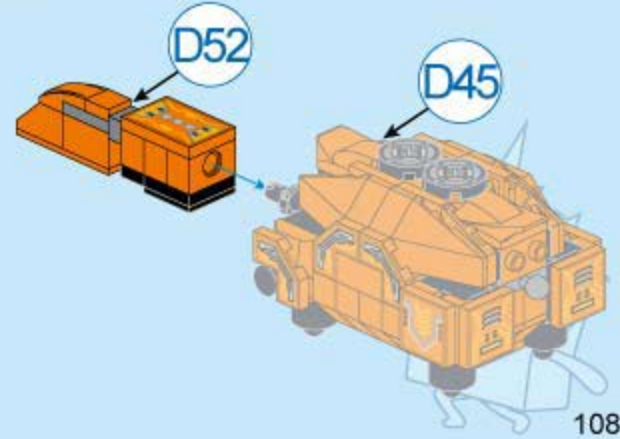

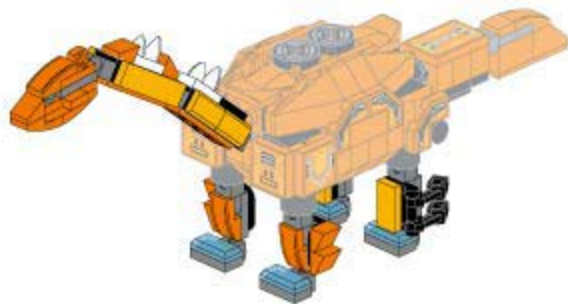

D54



1x

1x

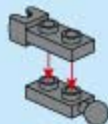

D55



2x

1x

2x



1

2

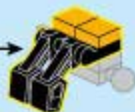

D56



D57



1x

1x

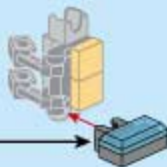

D58

D52

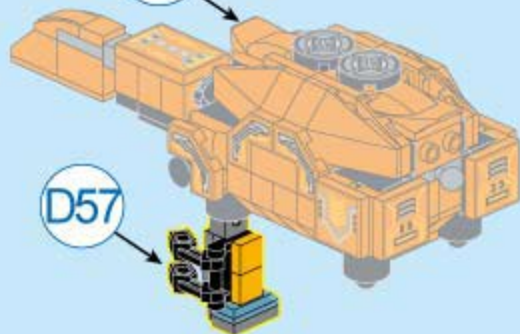

D57



D59

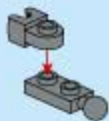

D60



D61

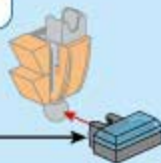
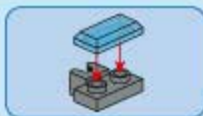

D62

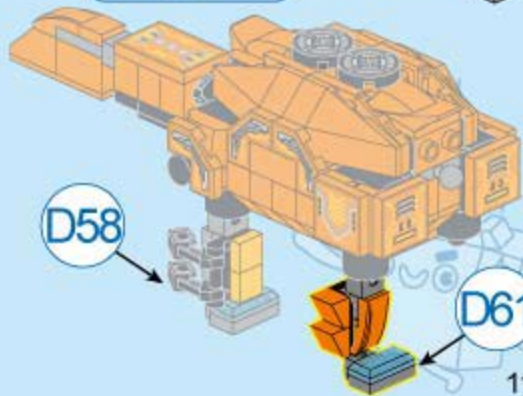

D58

D61



D63



1x

1x

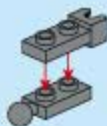

D64



2x

1x

1x



1

2



D65



D66



1x

1x

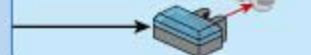

D67



D62



D66



D68

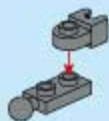

D69



D70

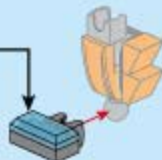
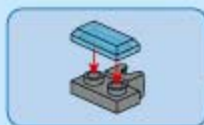

D71

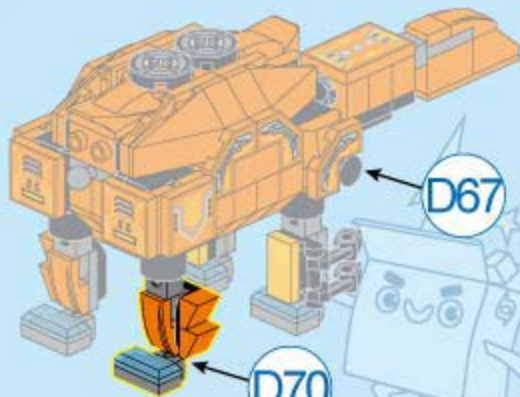



D72

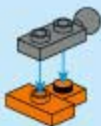
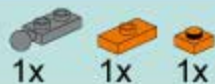

D73



D74

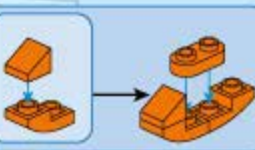

D75

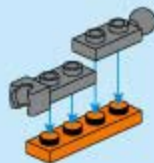

D76

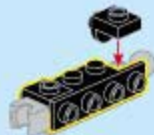

D77

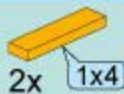

D78

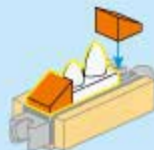

D79



D80

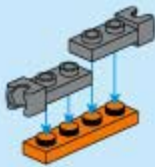

D81



D82

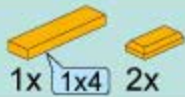

D83

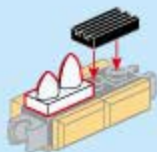

D84

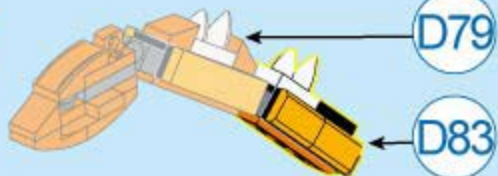

D85

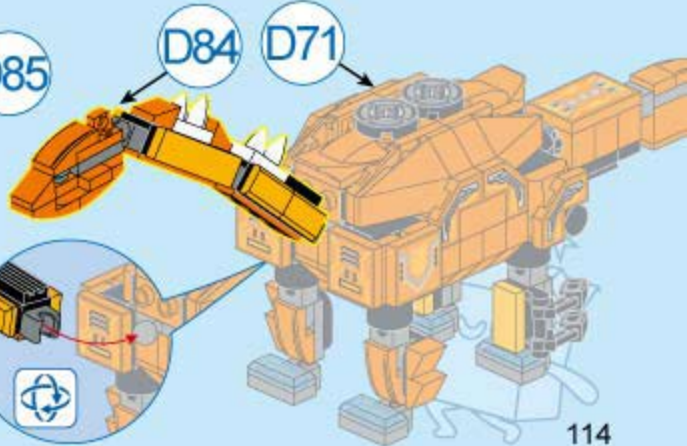



D2



D86

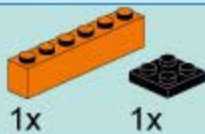

D87

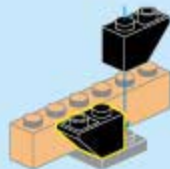

D88

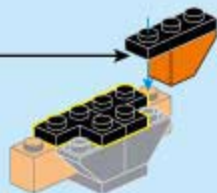

D89

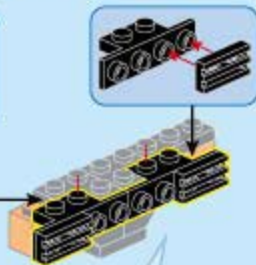

D90

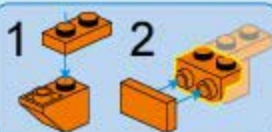

D96

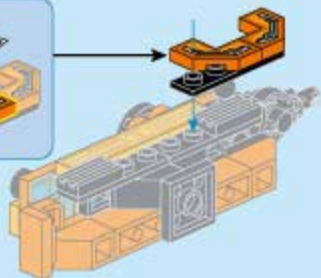

D97

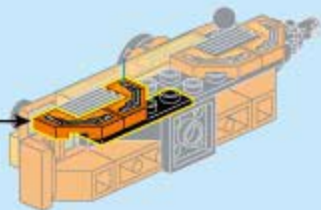
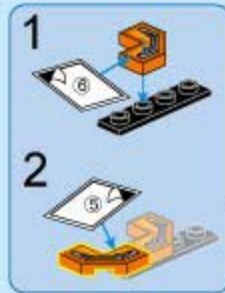

D98

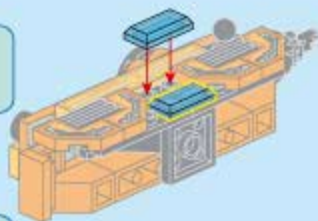

D99

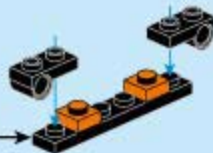
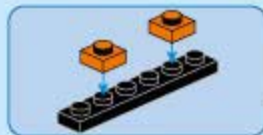

D100

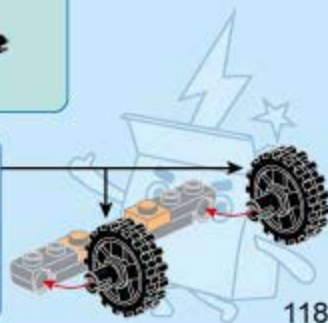

D101

D97

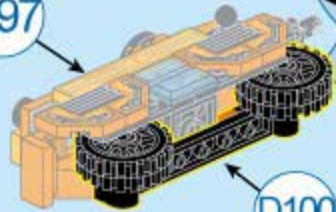

D100

D102



2x

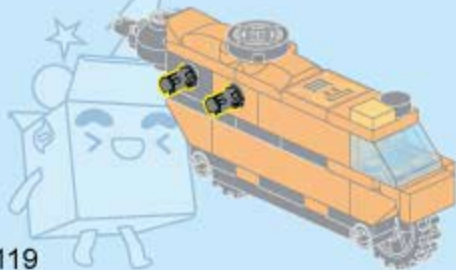

119

D103

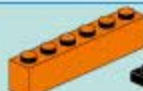

1x



1x

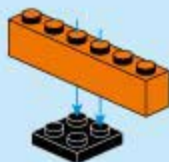

D104



2x



D105



D106

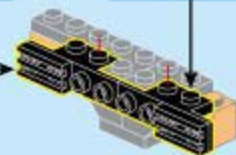

D107

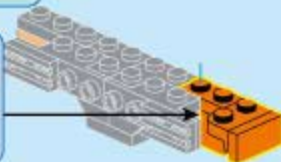
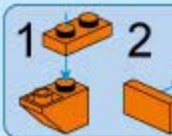
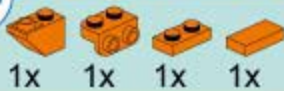

D108



D109

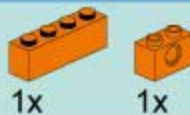

D110

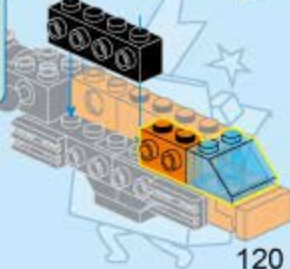
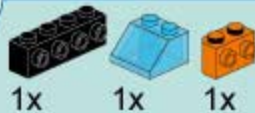

D111

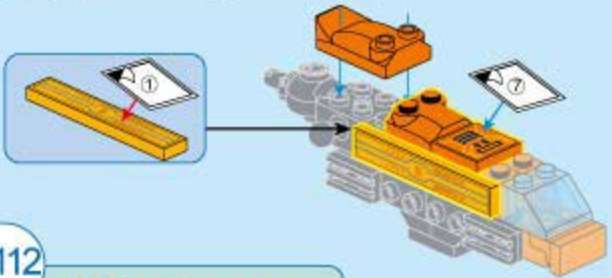
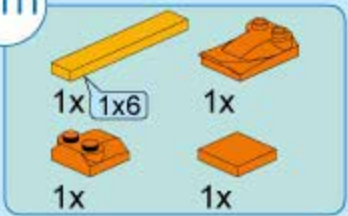

D112

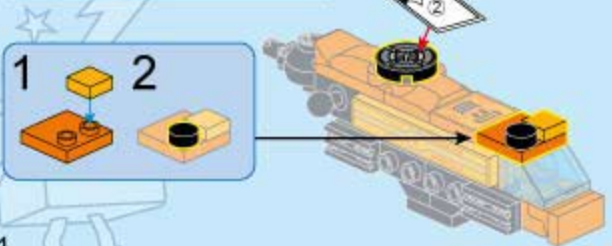

D113

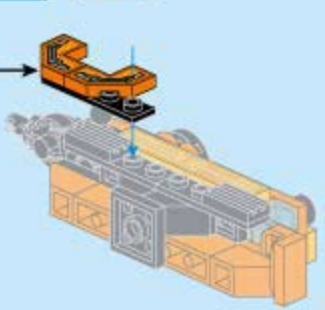
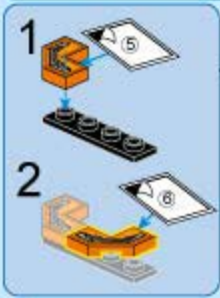

D114

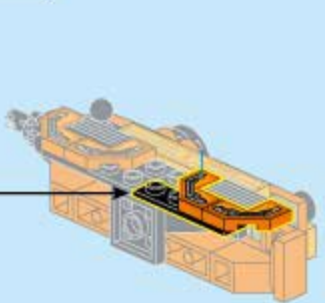
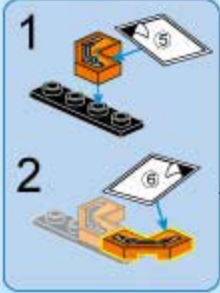

D115



2x

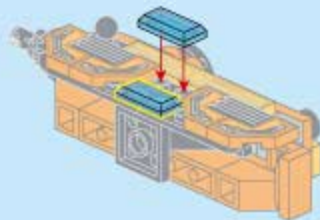

D116



1x



2x



2x

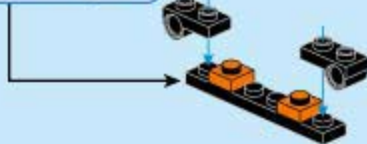
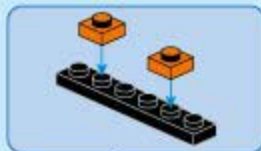

D117



2x



2x



2x



2x

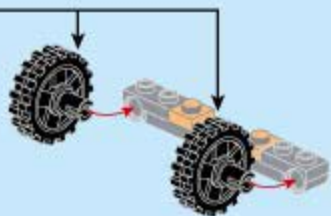

D118



D117

D115

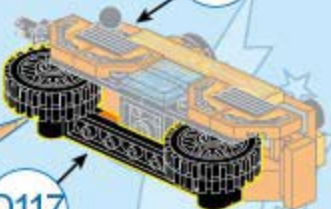

D119



D102

D118



D120



1x

1x



D121



2x



D122

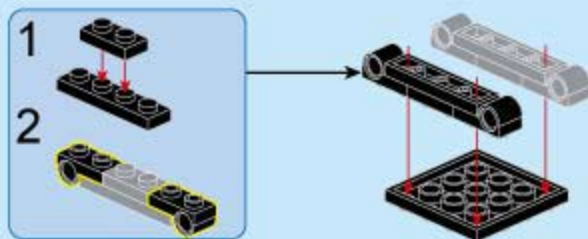
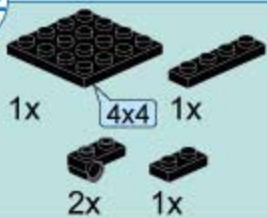

D123



D124



D125



D126

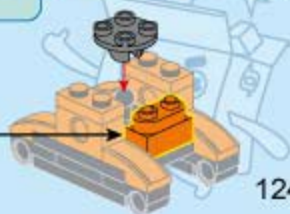
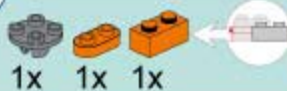

D127

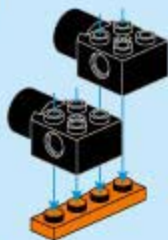

D128

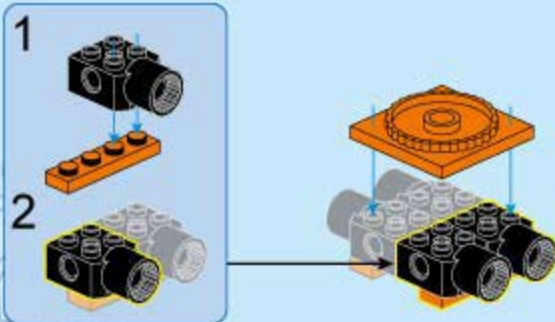
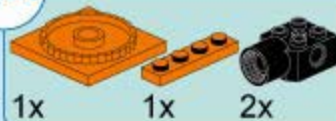

D129

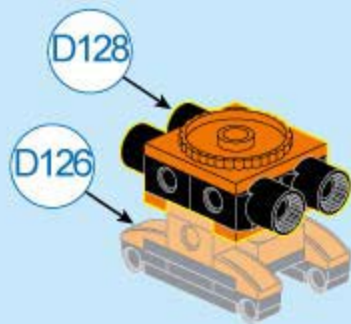

D130

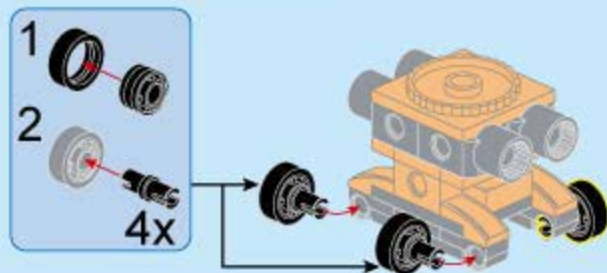

D131

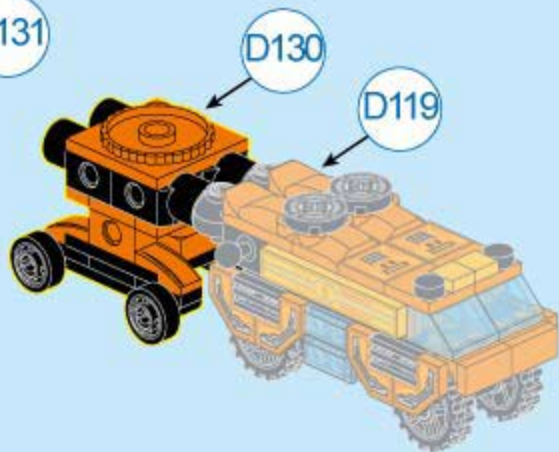

D132



D133



D134



D135

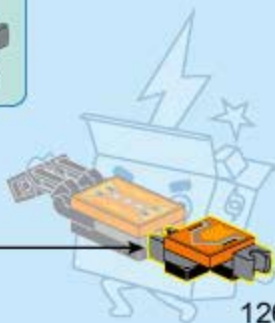
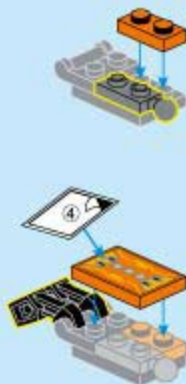
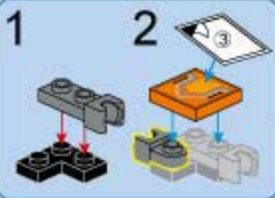

D136

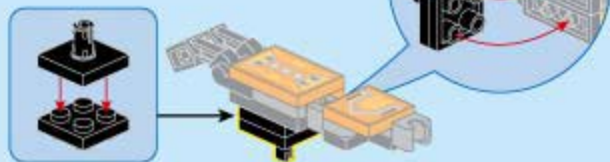

D137

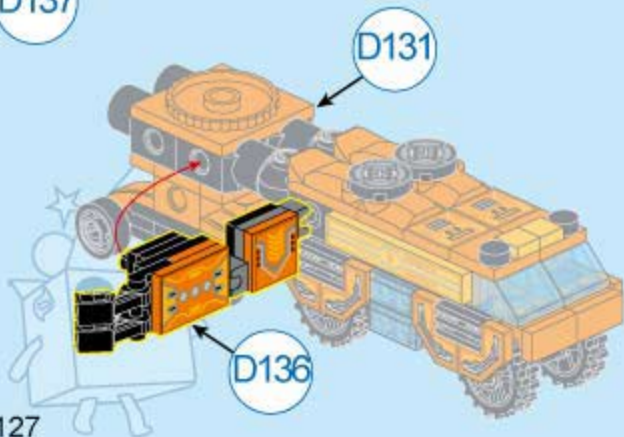

D138



D139



D140



D141

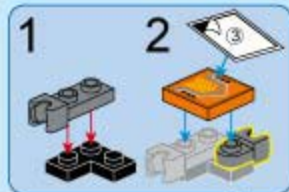

D142

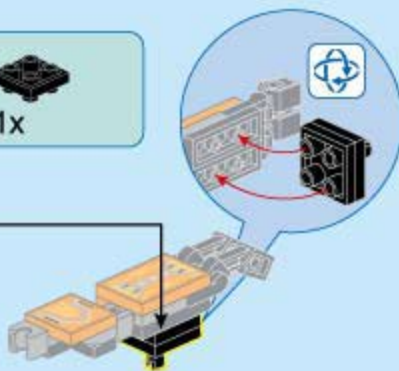

D143



D143





D144



1x

1x



D145



1x

1x



D146



2x

4x

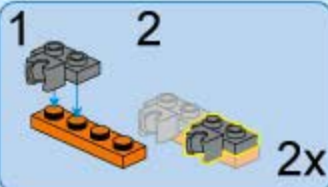

D147



1x

1x

1x



D148



1x

1x

1x



D149



D150

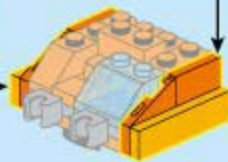
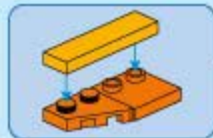
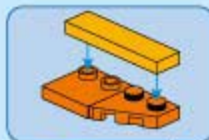
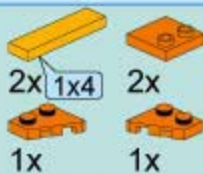

D151

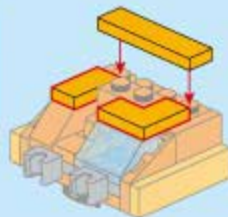
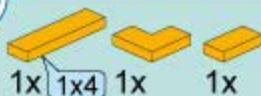

D152



D153

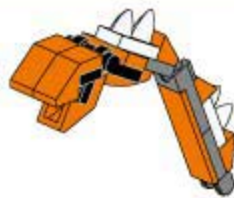

D154

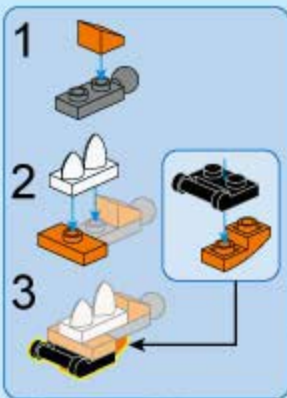
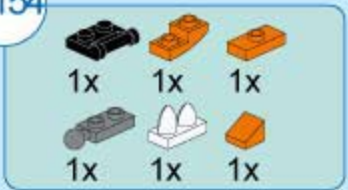

D155

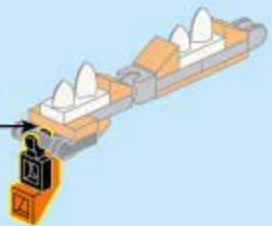

D156

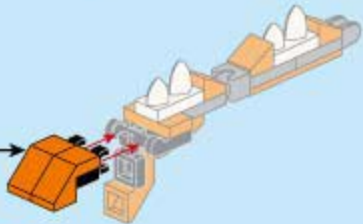

D157



D158

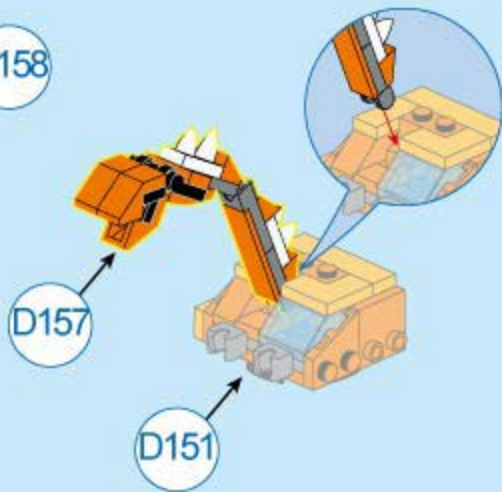

D159

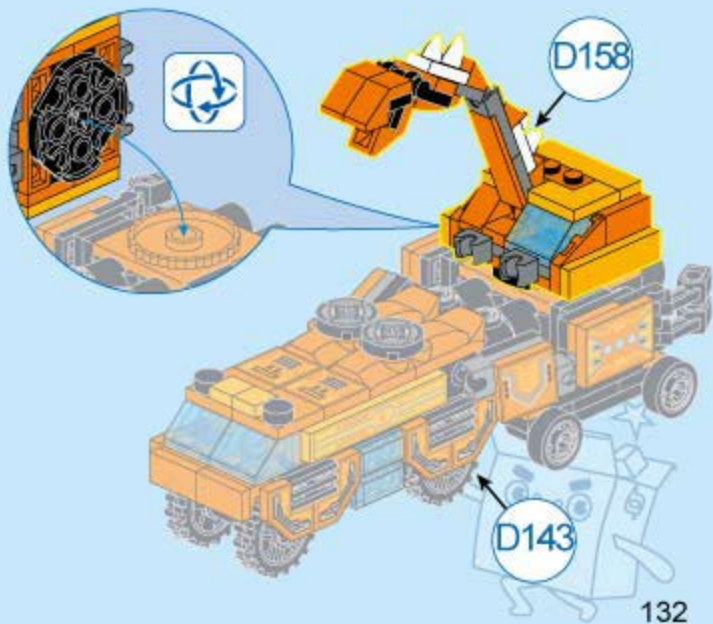

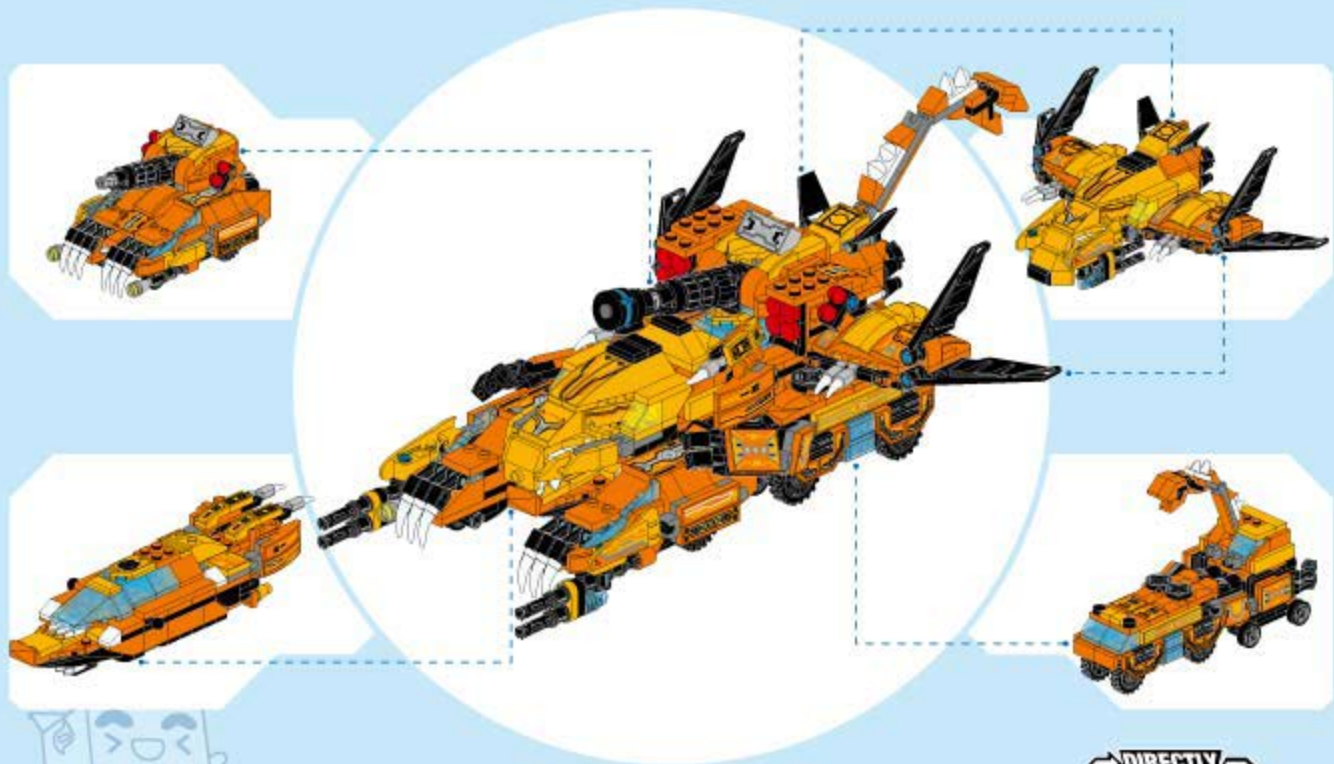



E1



E2

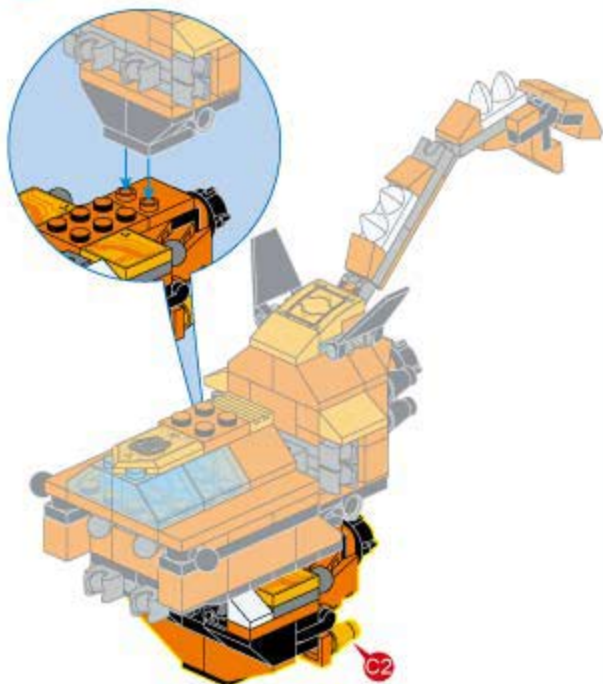

E3

4x

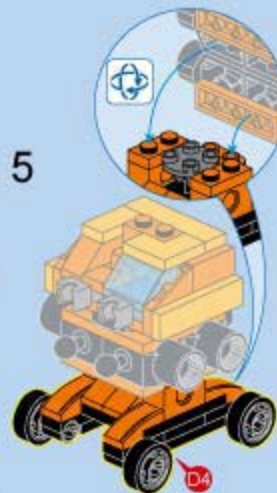
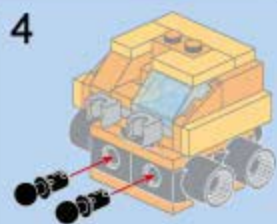

E4

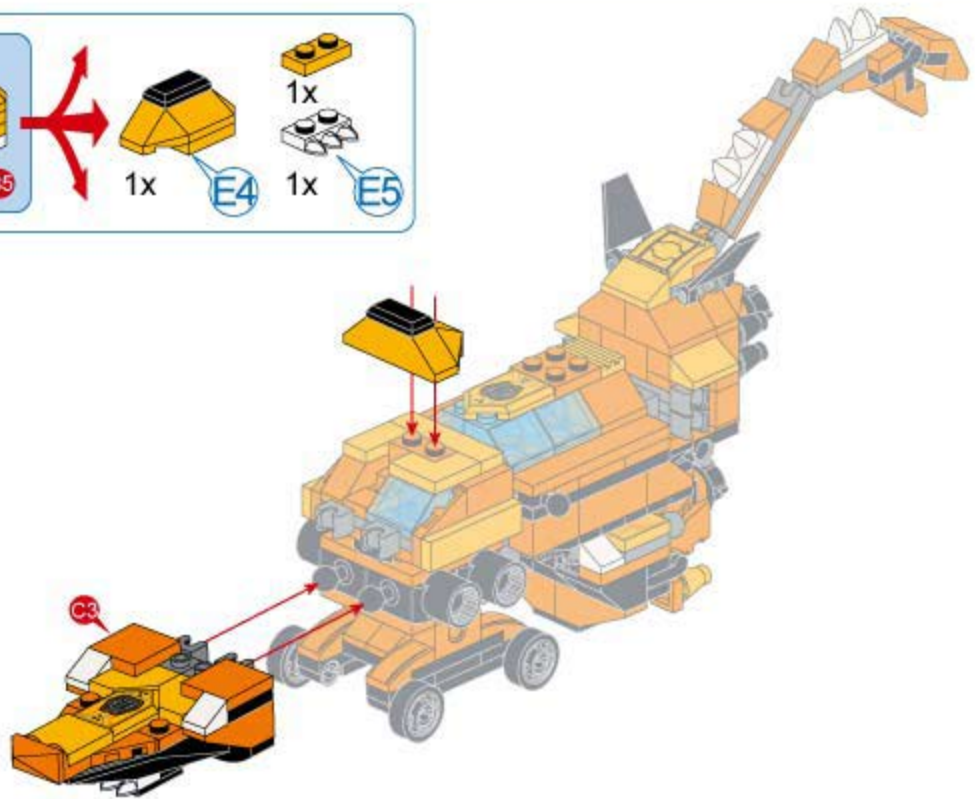
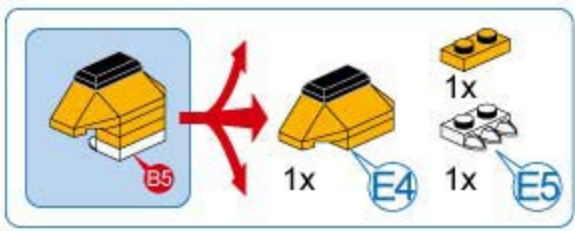

E5



1x



1x

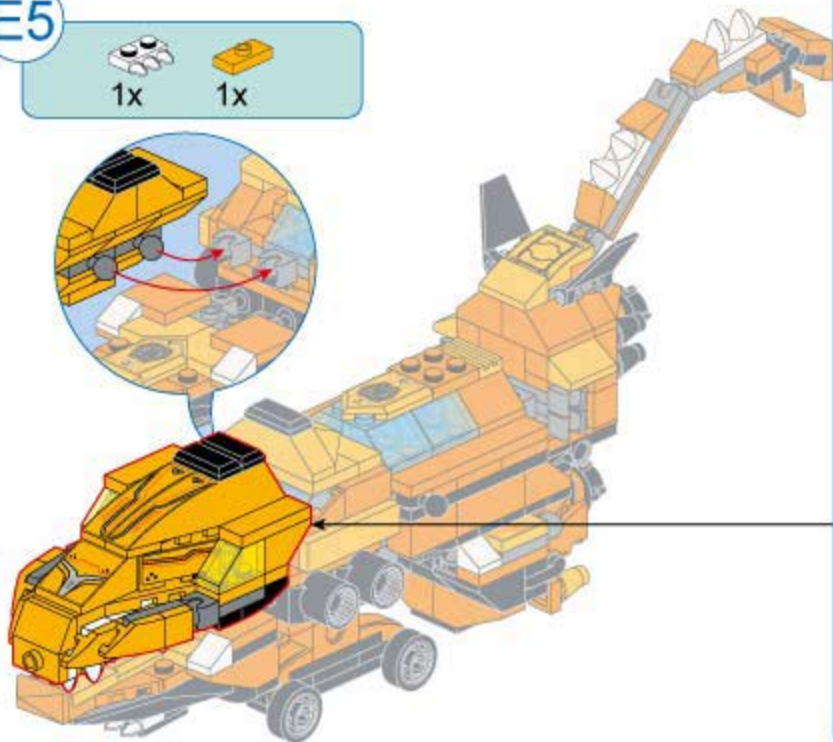

1

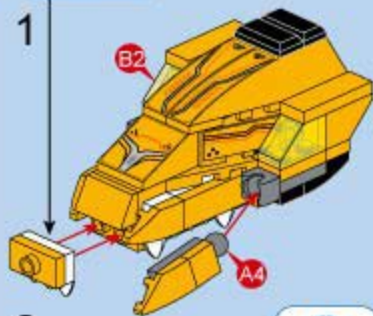

2

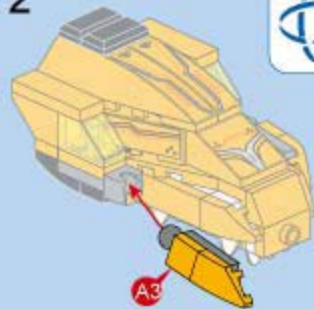

E6

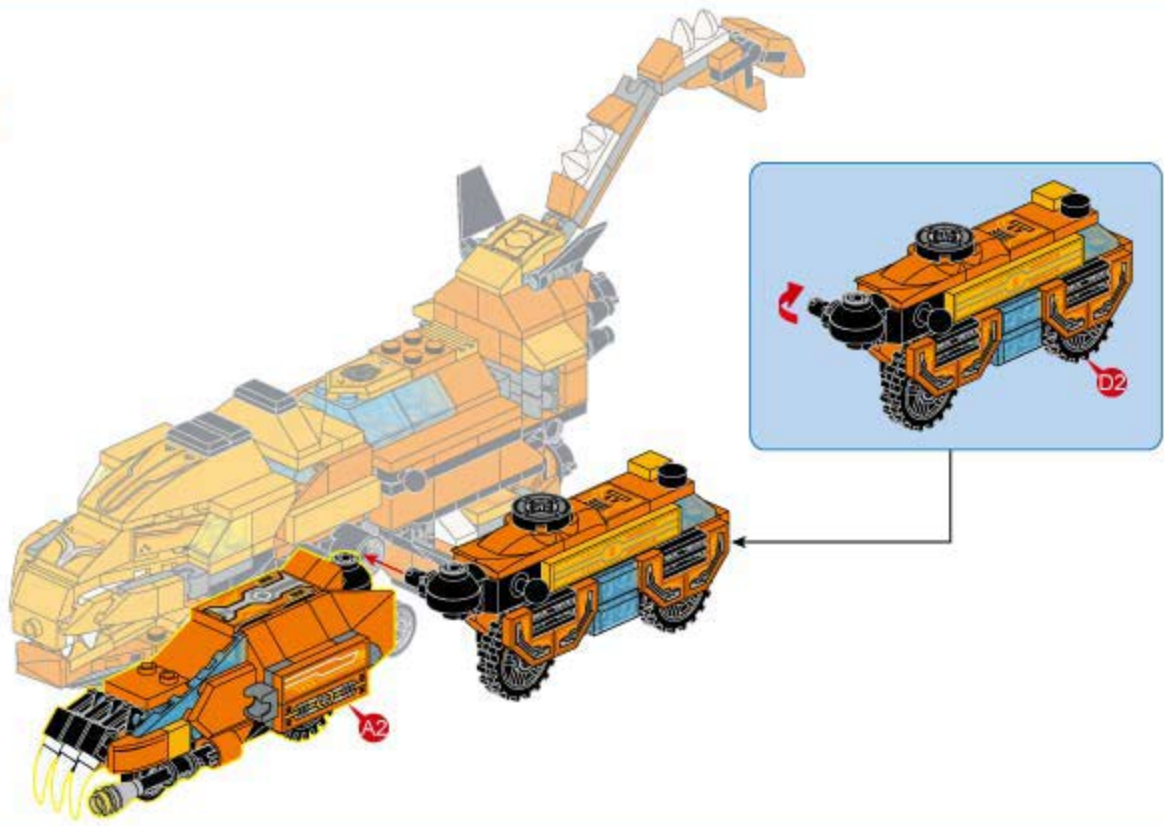

E7

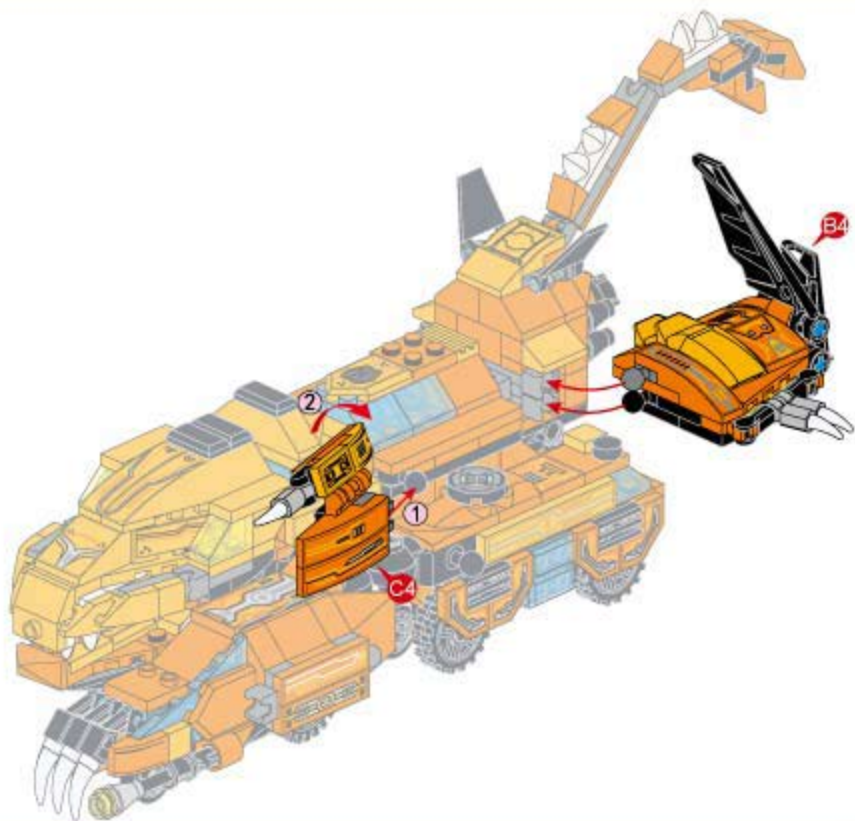

○ 注意拼搭顺序

E8

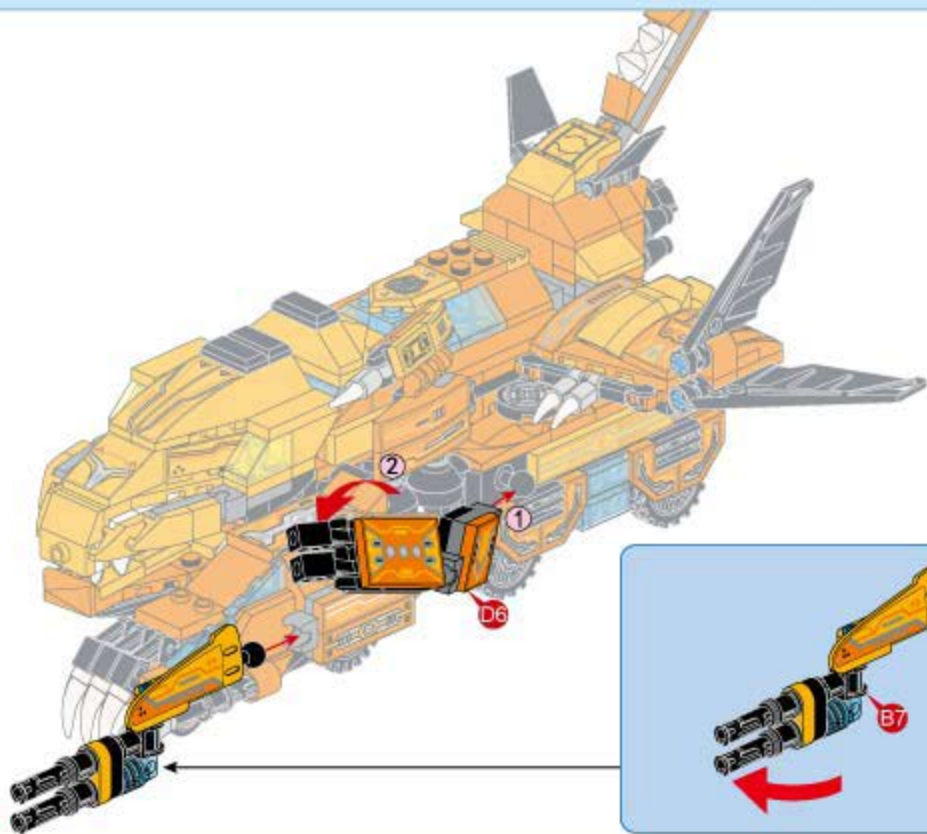

○ 注意拼搭顺序

E9

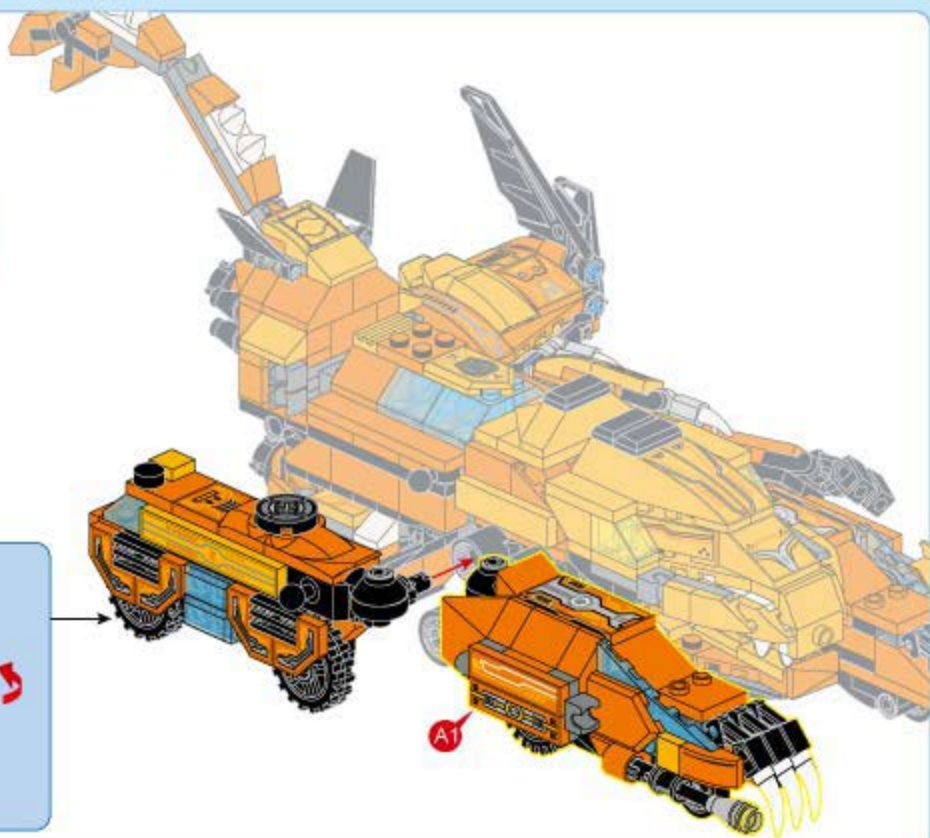
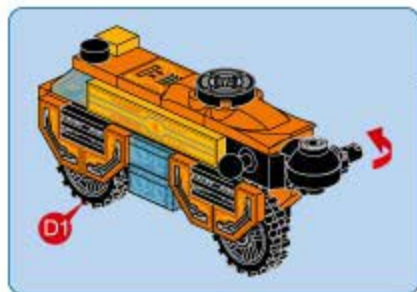

E10

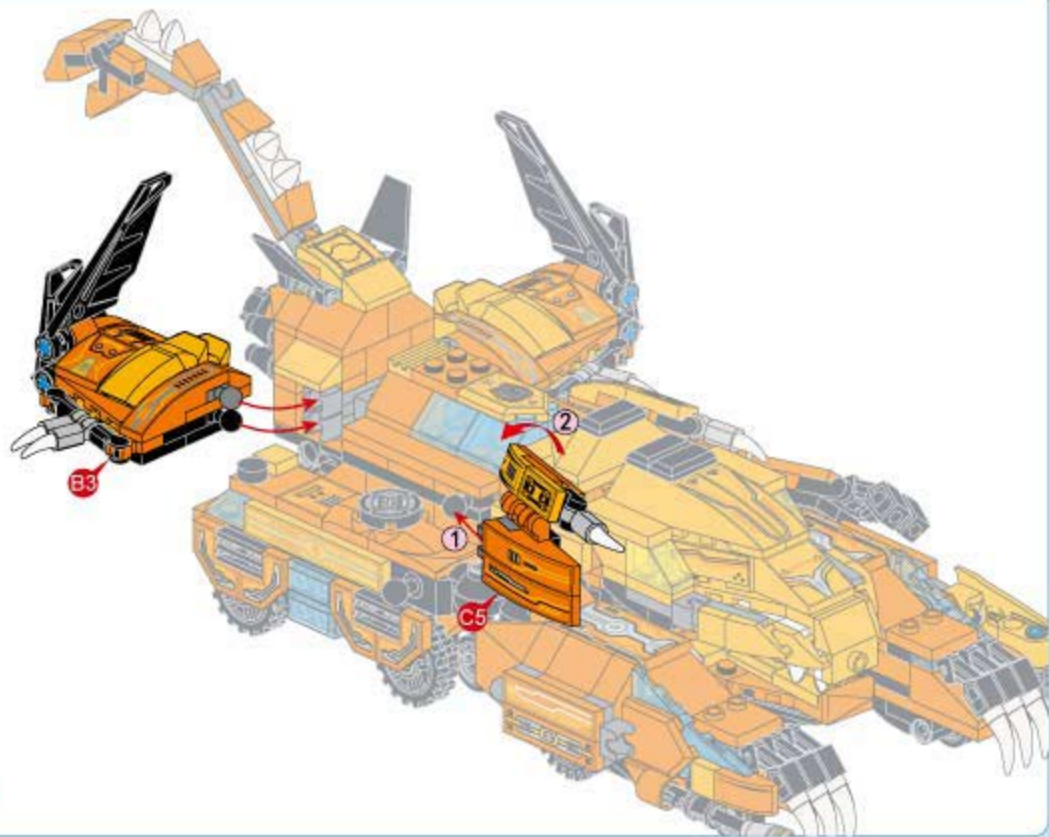

○ 注意拼搭顺序

E11

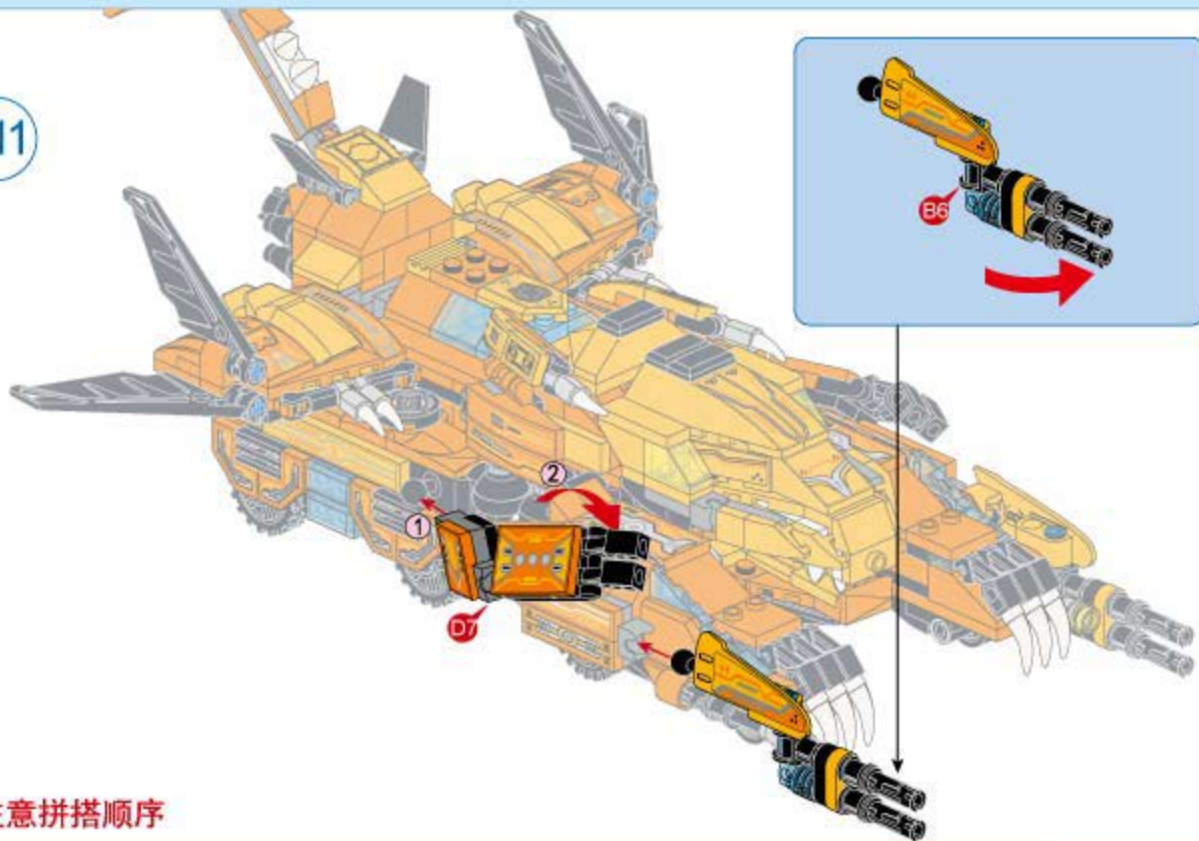

○ 注意拼搭顺序

E12

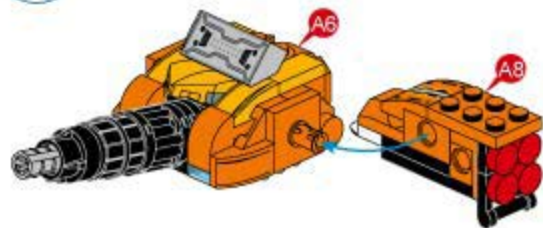

E13



E14

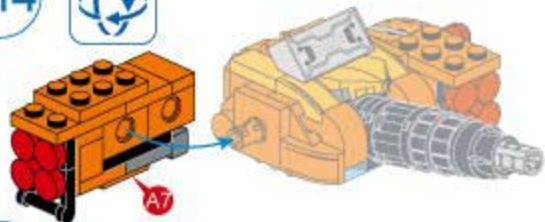

E15



E16

E15

E11

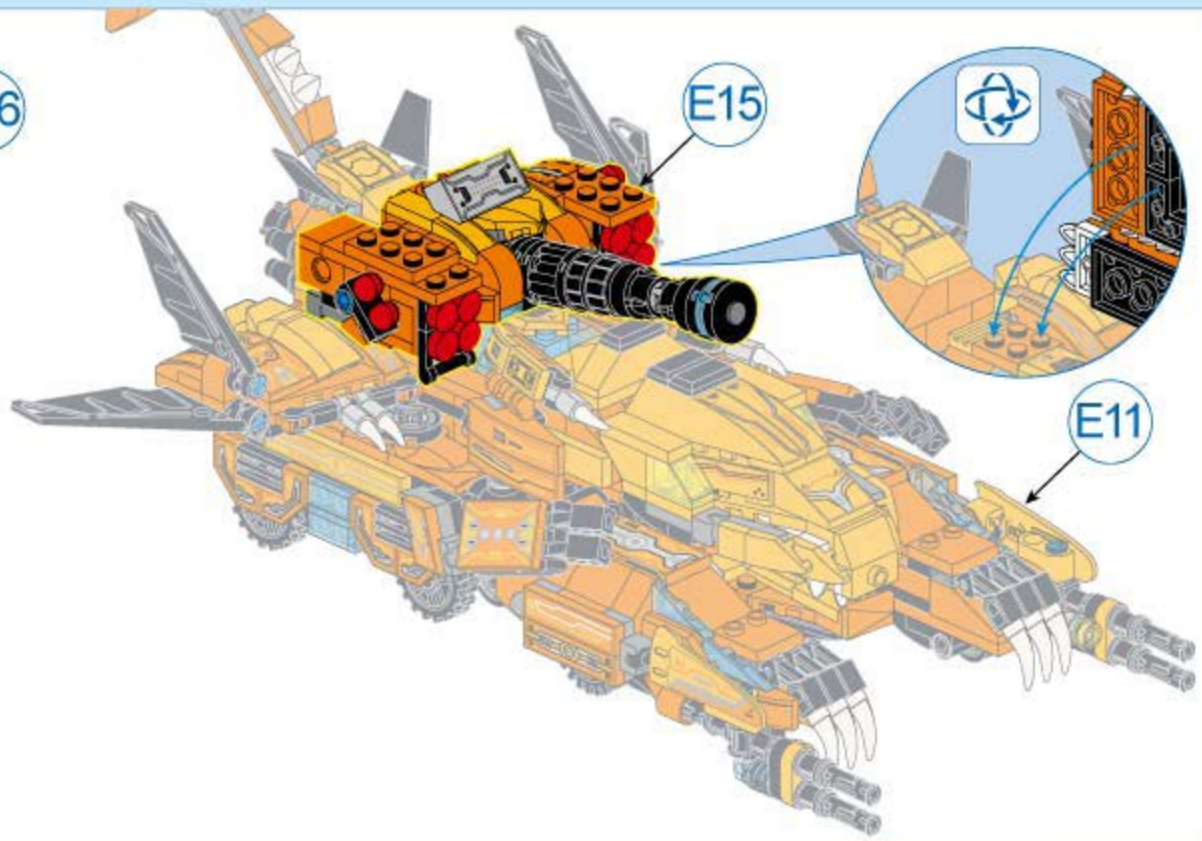

TRANS- COLLECTOR



41311-1 T-rex Tank



41311-2 Pterosaur Warplane



41311-3 Ceratops Patrol Boat



41311-4 Brontosaurus Crane Arm

V1.0