

# QMAN LIGHTEN THE DREAM



**MineCity**  
Armored SWAT vehicle



**11020 | Ages: 6+ | Minifigs: X3 | PCS: 1250**

Pictures are for your reference only. The delivered goods shall prevail.



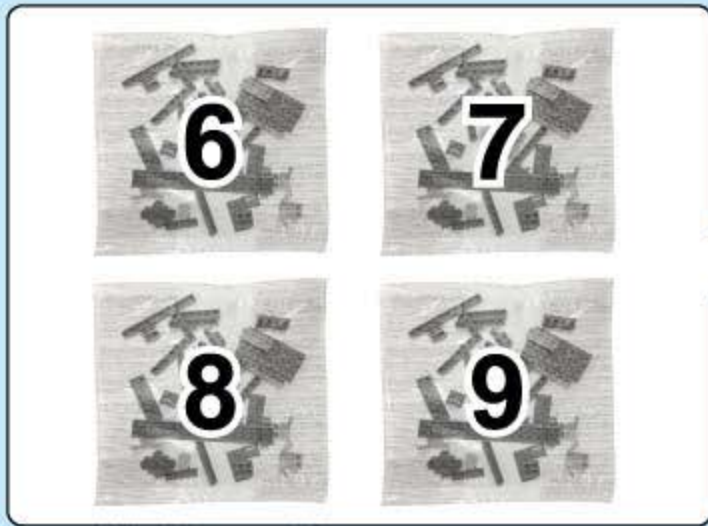
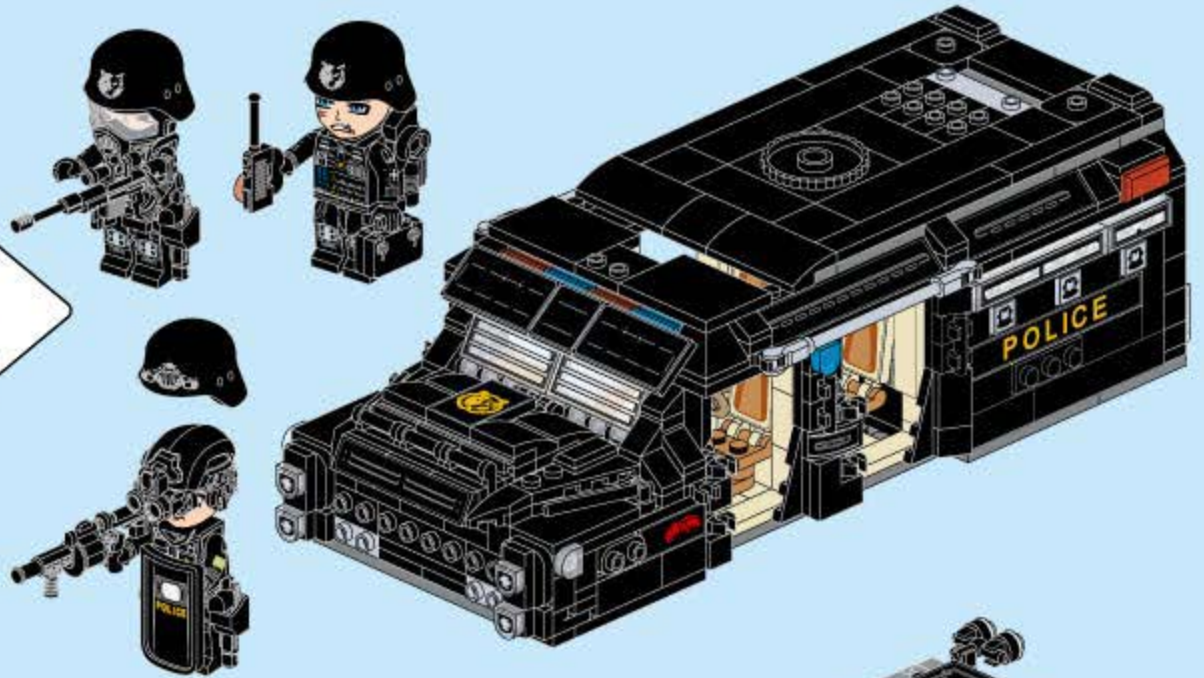
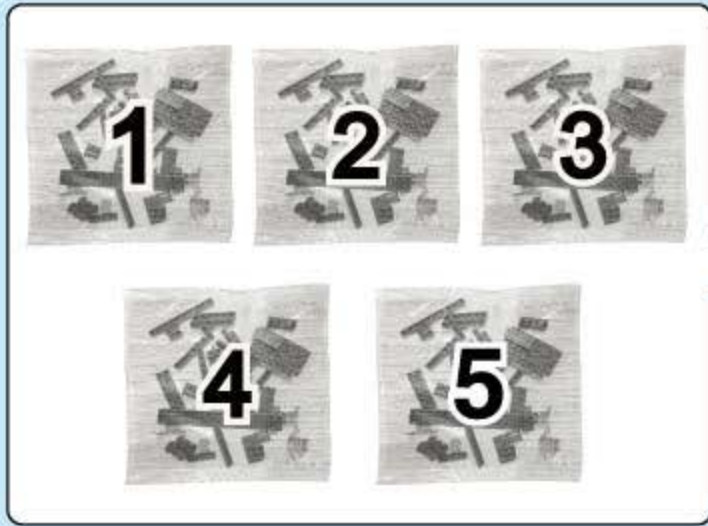

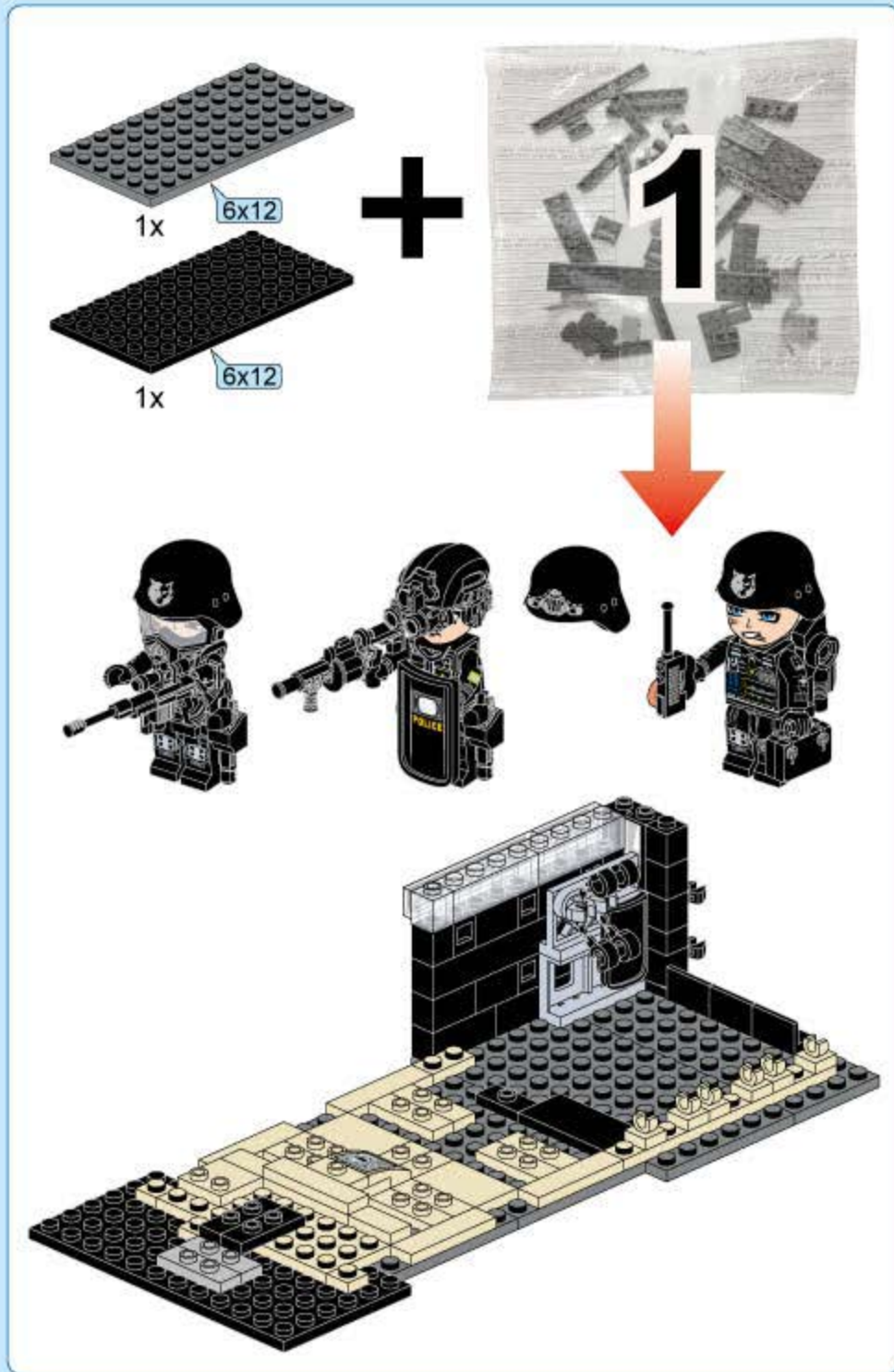

拆件器使用方法，仅为示例

Usage of Brick Separator, Just for the sample

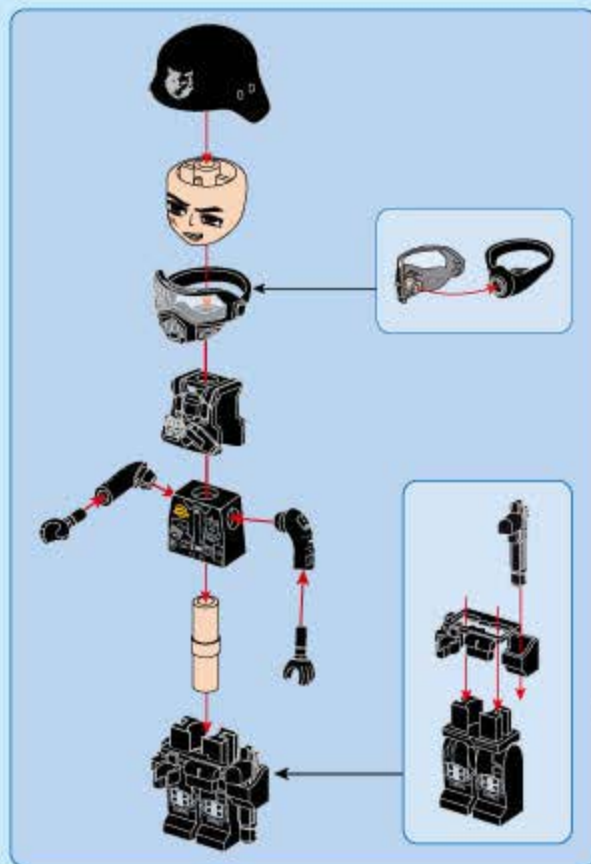
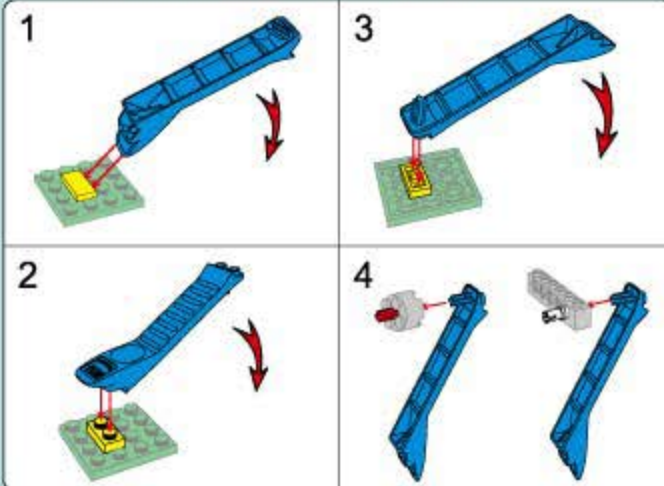



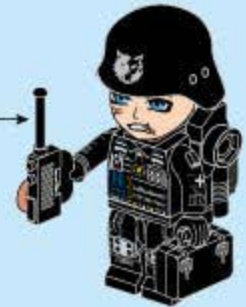
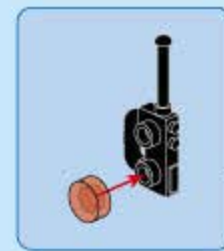
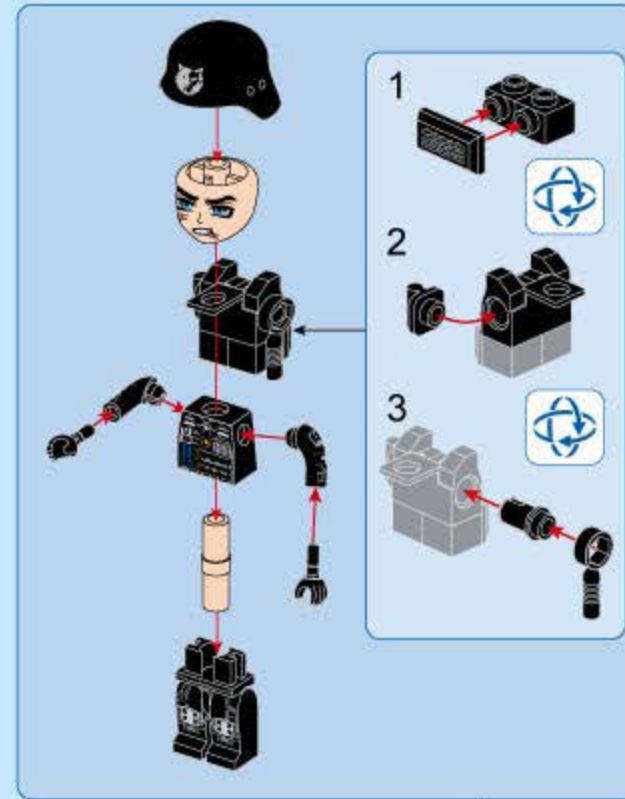
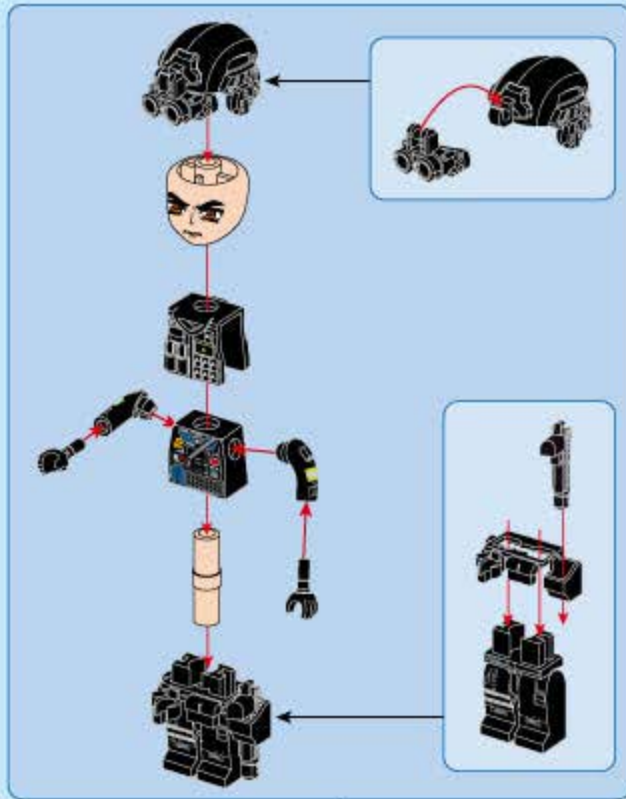



1

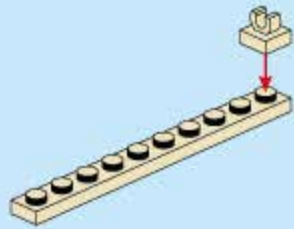
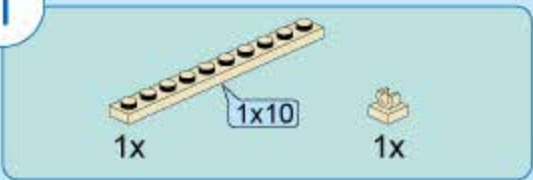

2



3

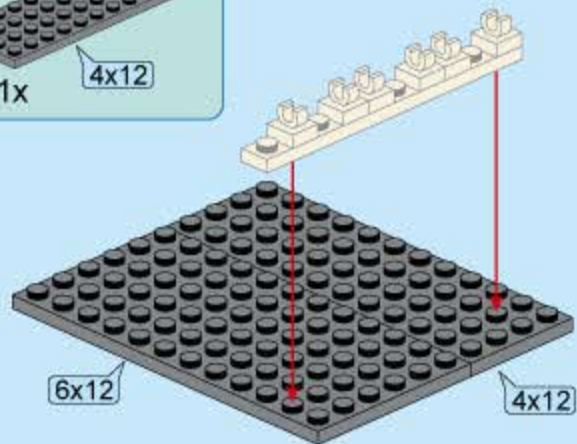
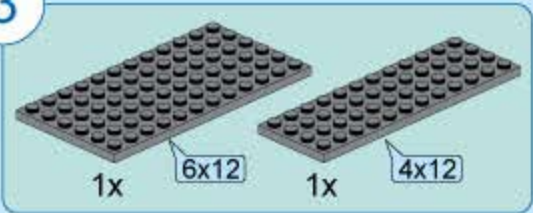

4

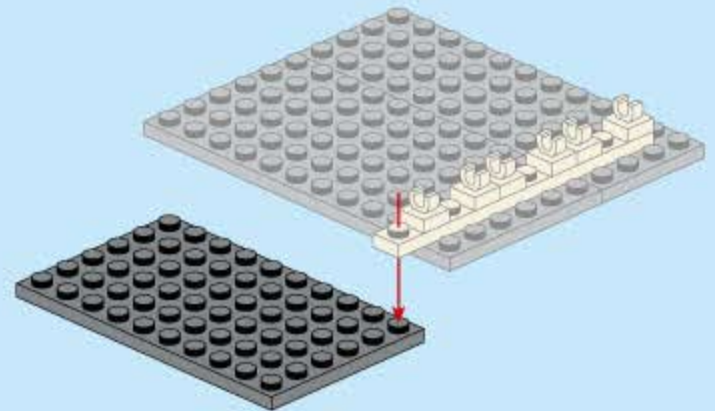
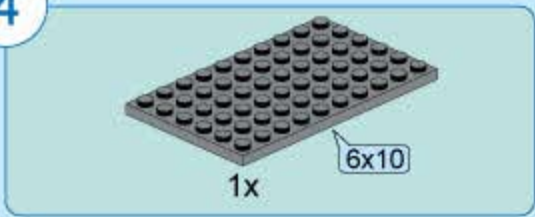

5

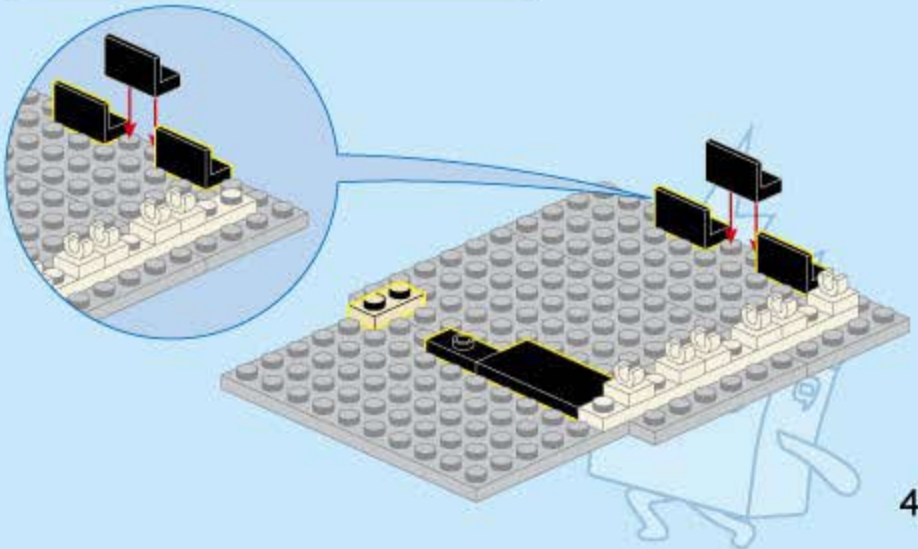

6

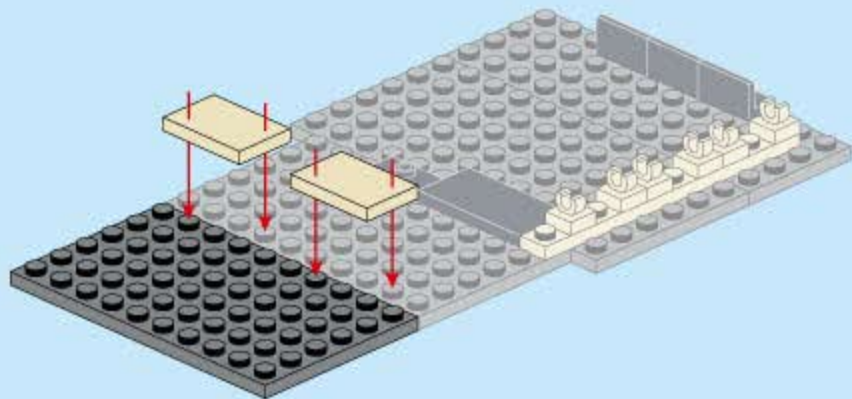
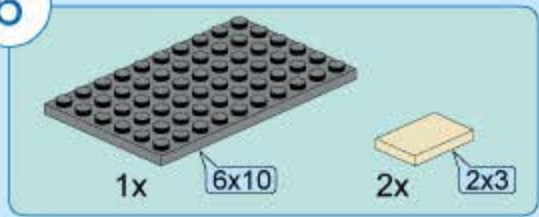

7

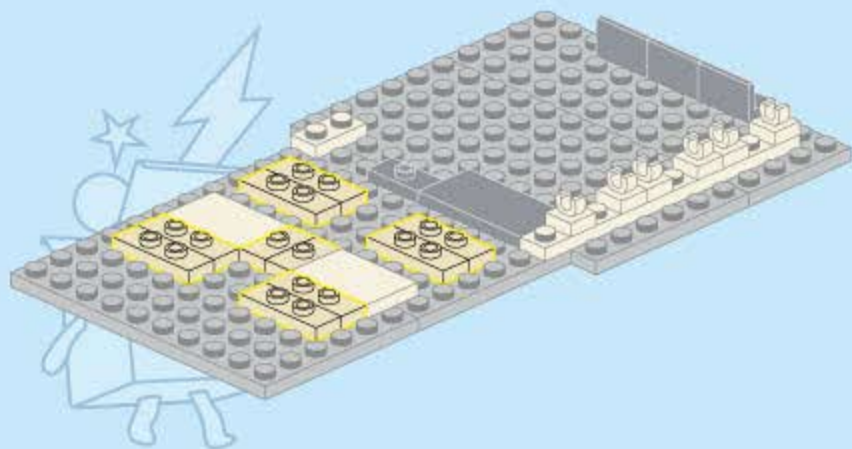

5

8

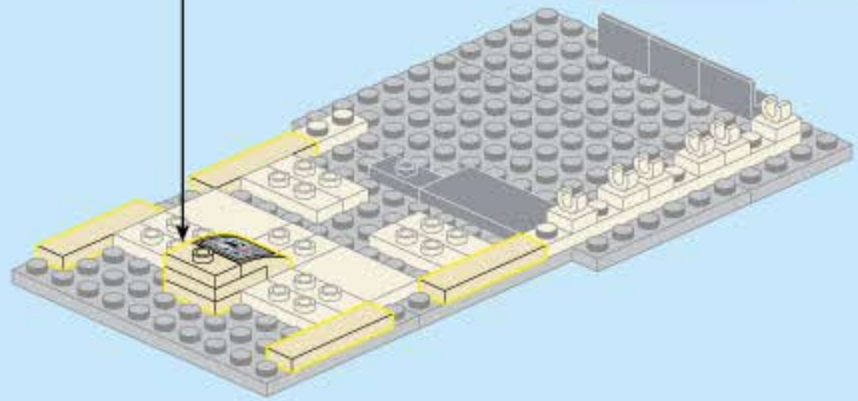
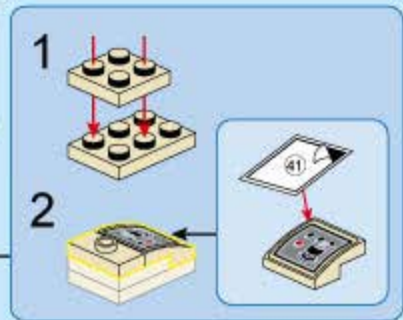
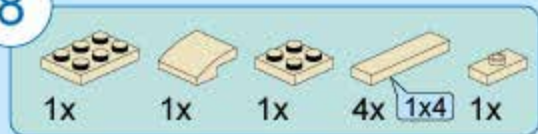

9

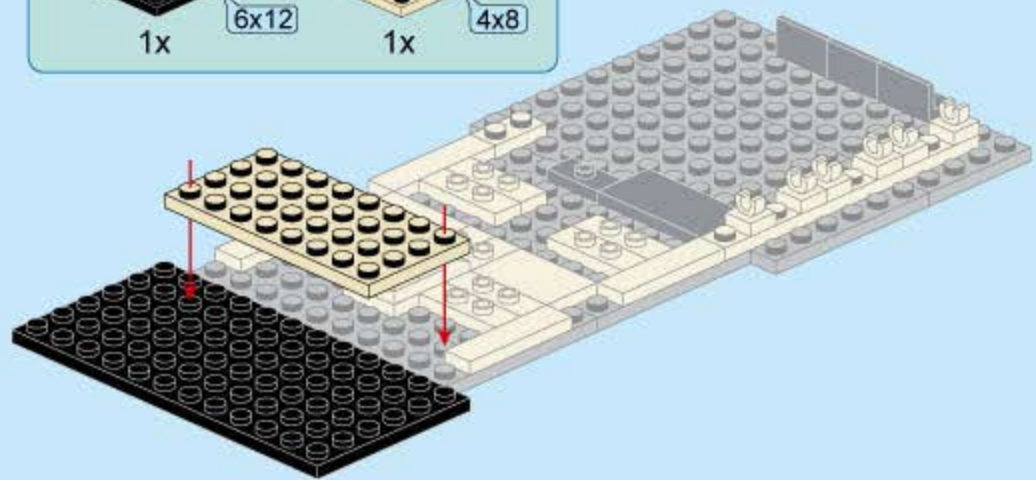
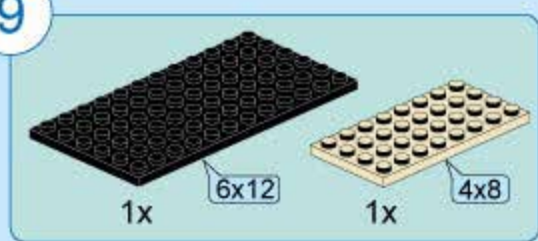



10

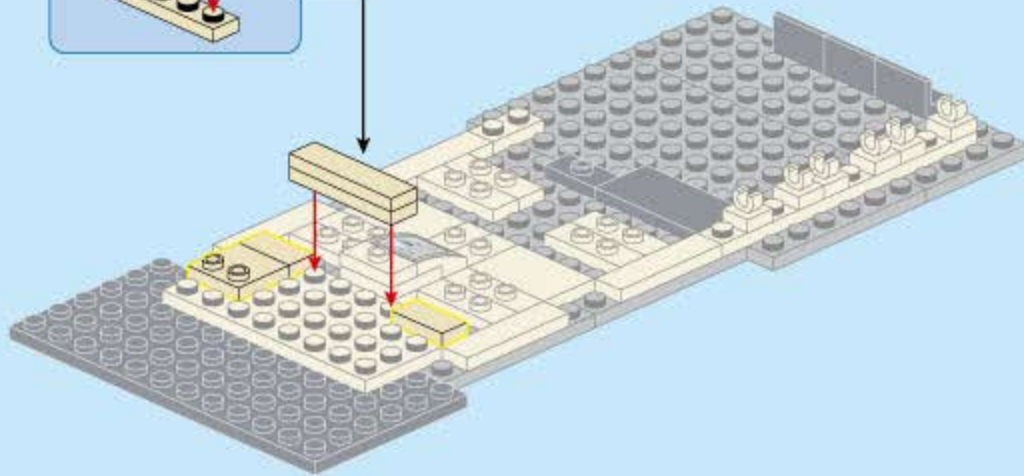
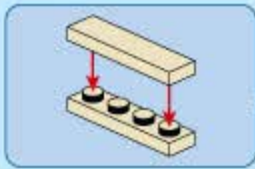
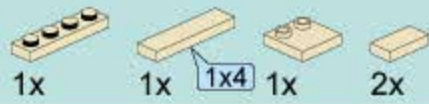

11

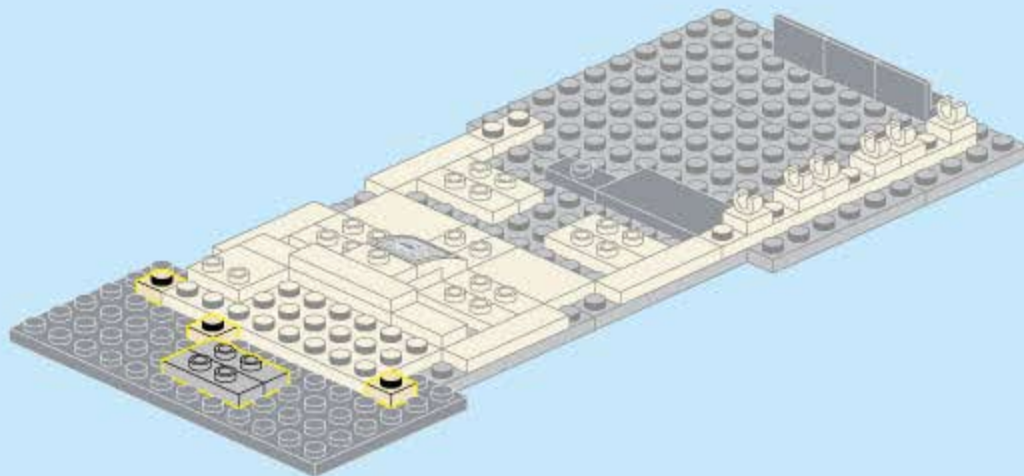

12

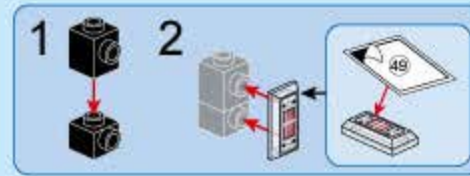

13

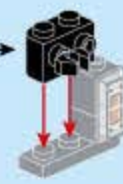

14

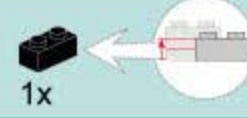

15



16

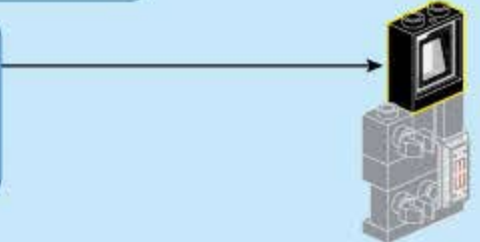
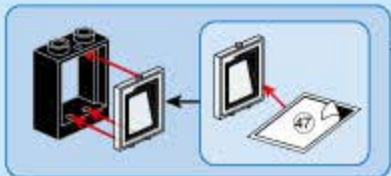

17

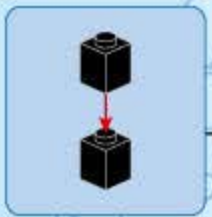

18

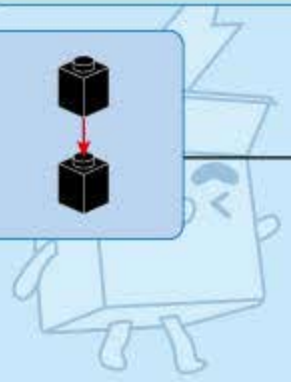
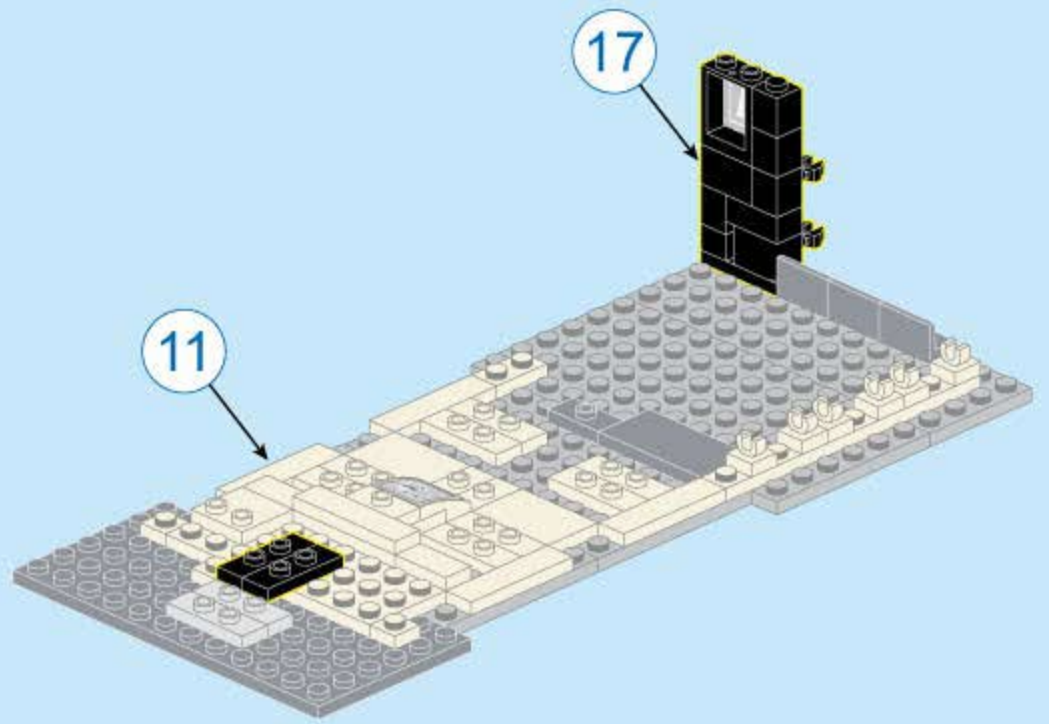





19

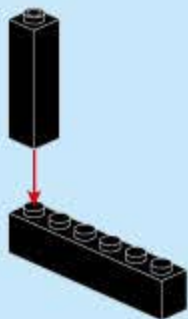
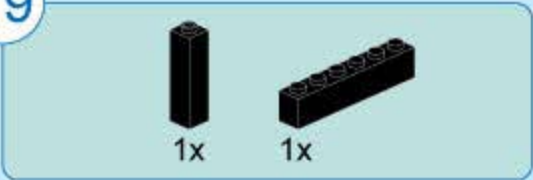

20

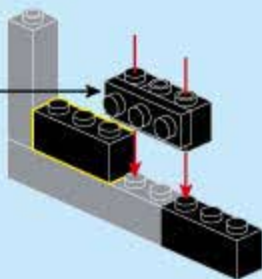
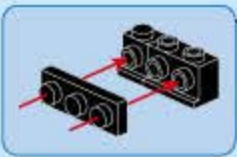

21

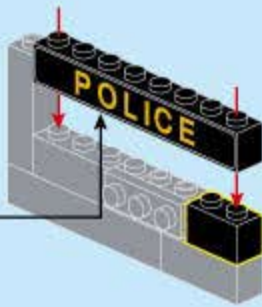
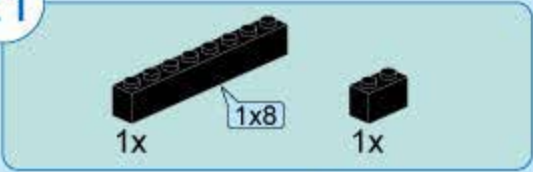

22

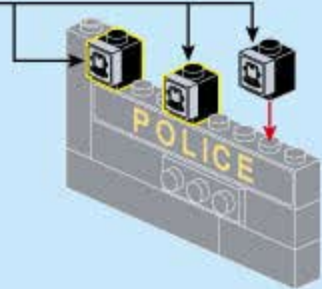
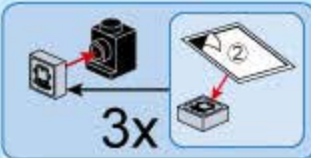

23



24

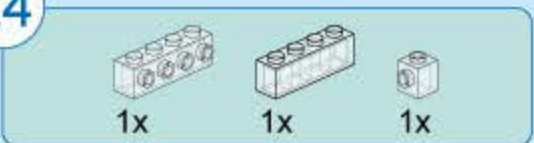

25

1x 1x6 1x 1x3



26

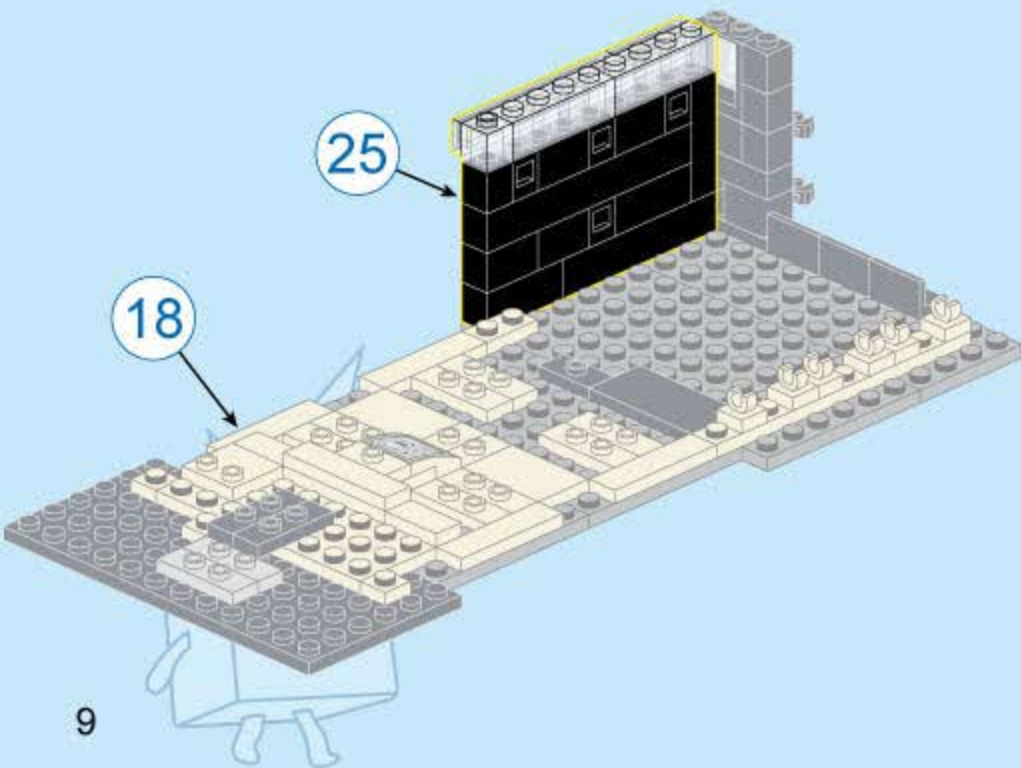

27

1x 1x 1x



28

1x 1x



29

1x 2x

1:1

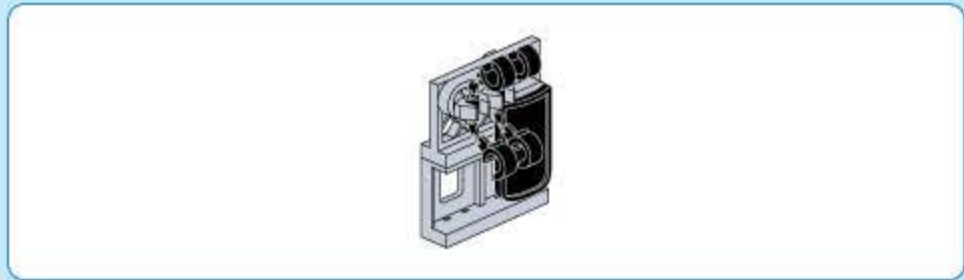
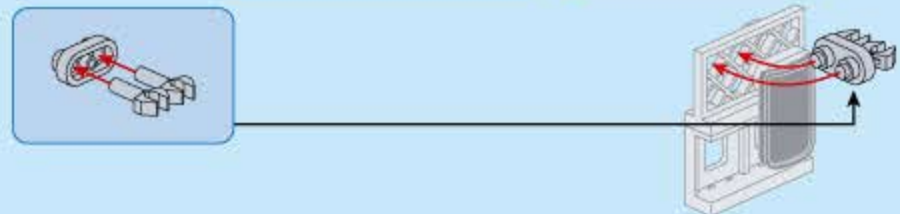



30



2x

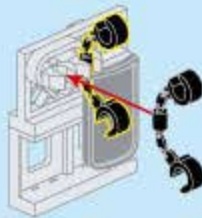

31

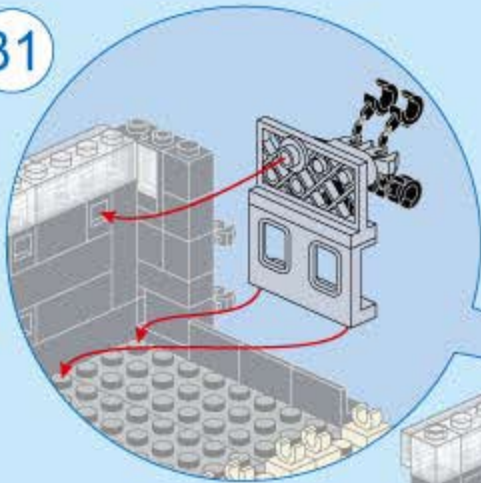

30

26

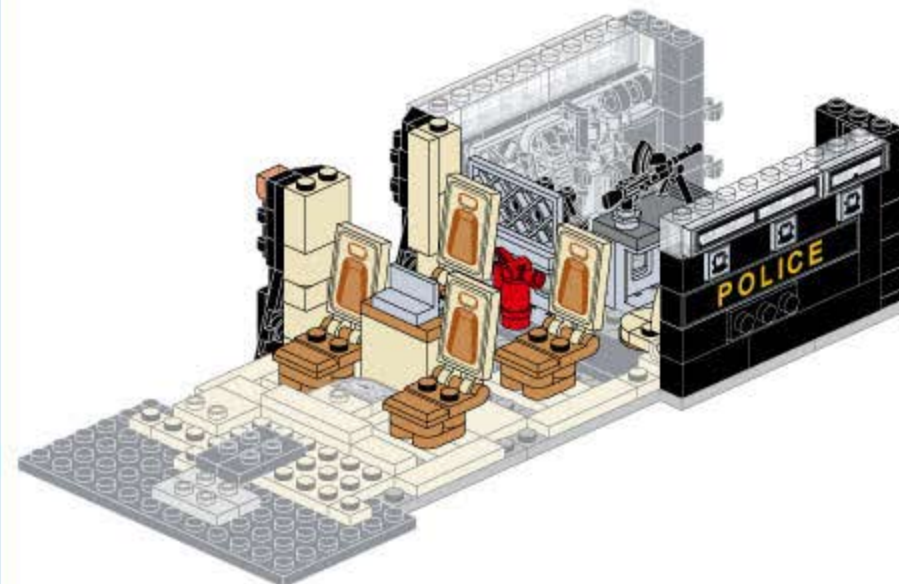
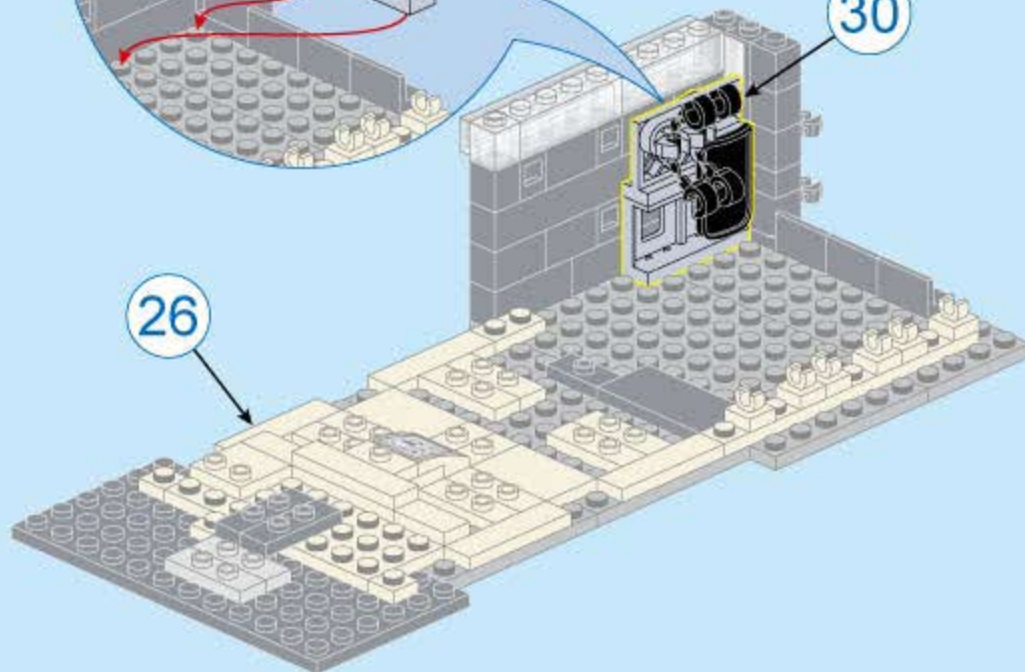

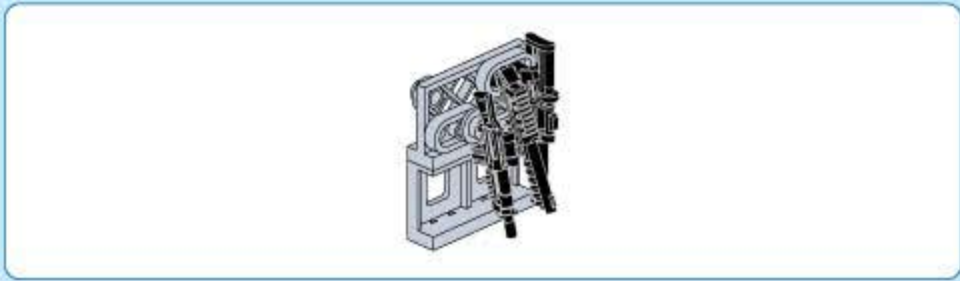

32

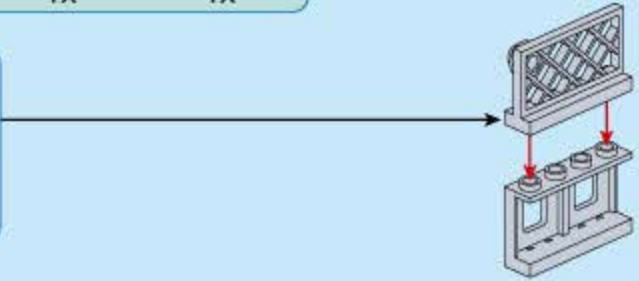
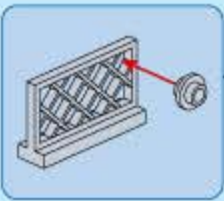
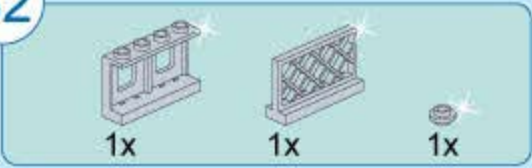

33

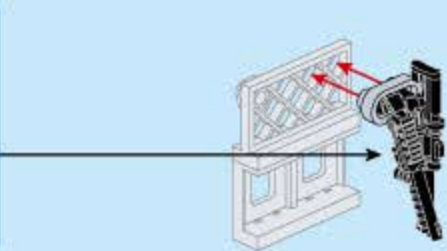
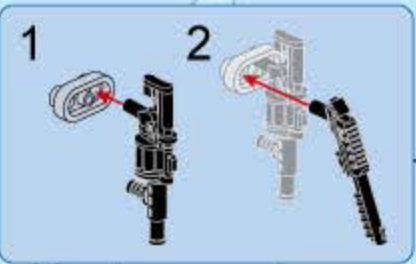

34

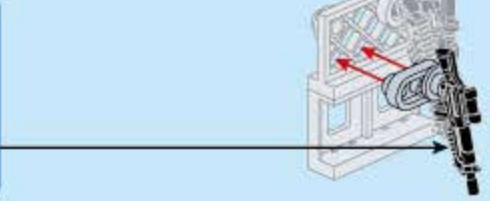
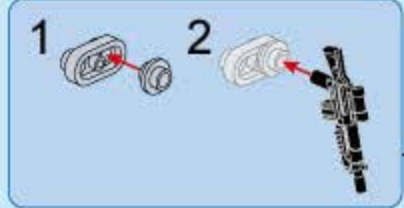
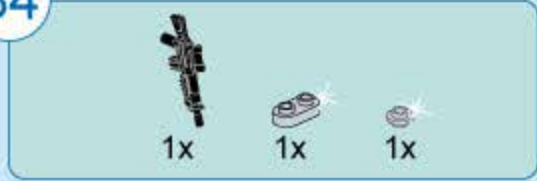

35

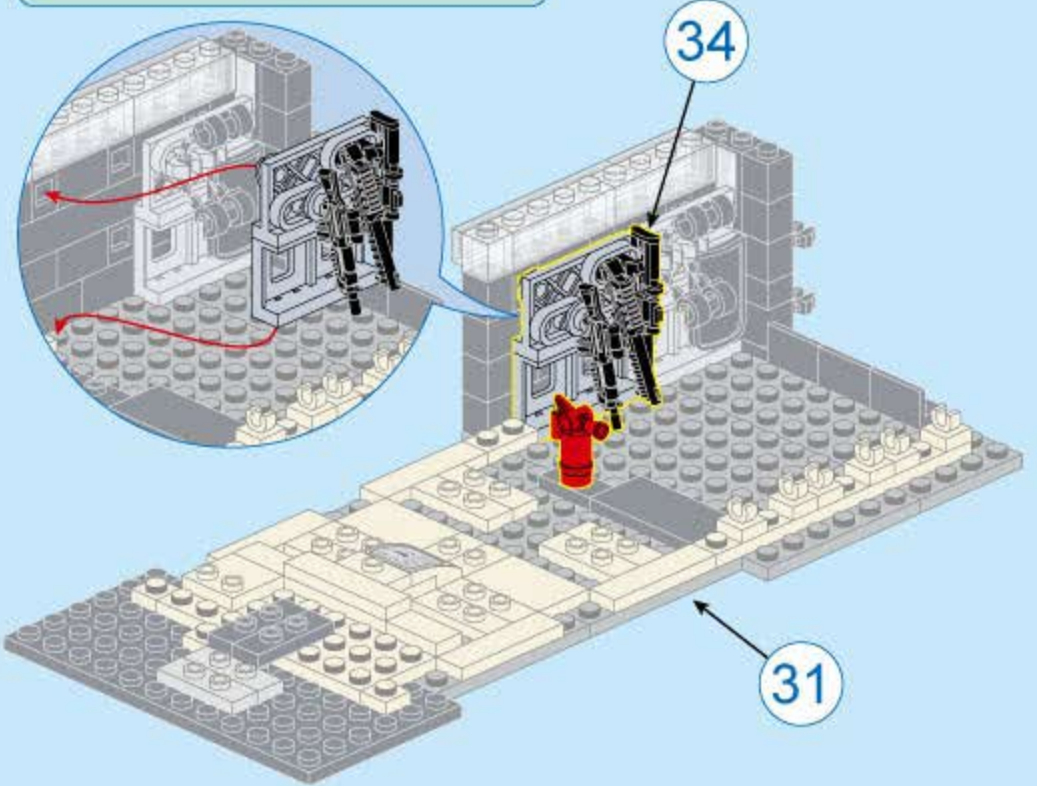
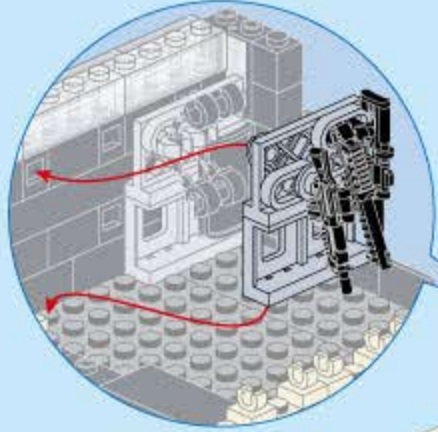



36

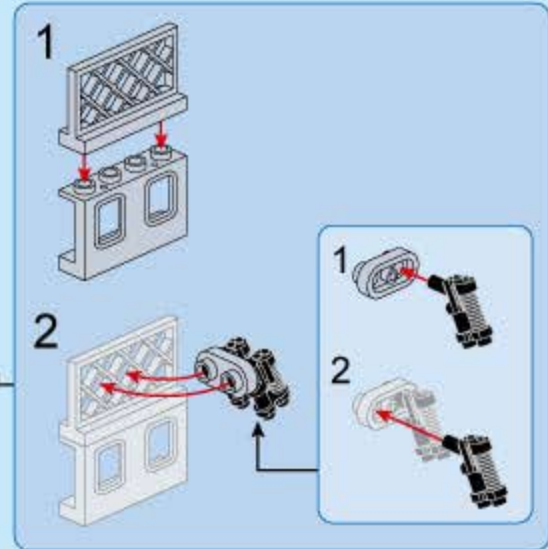
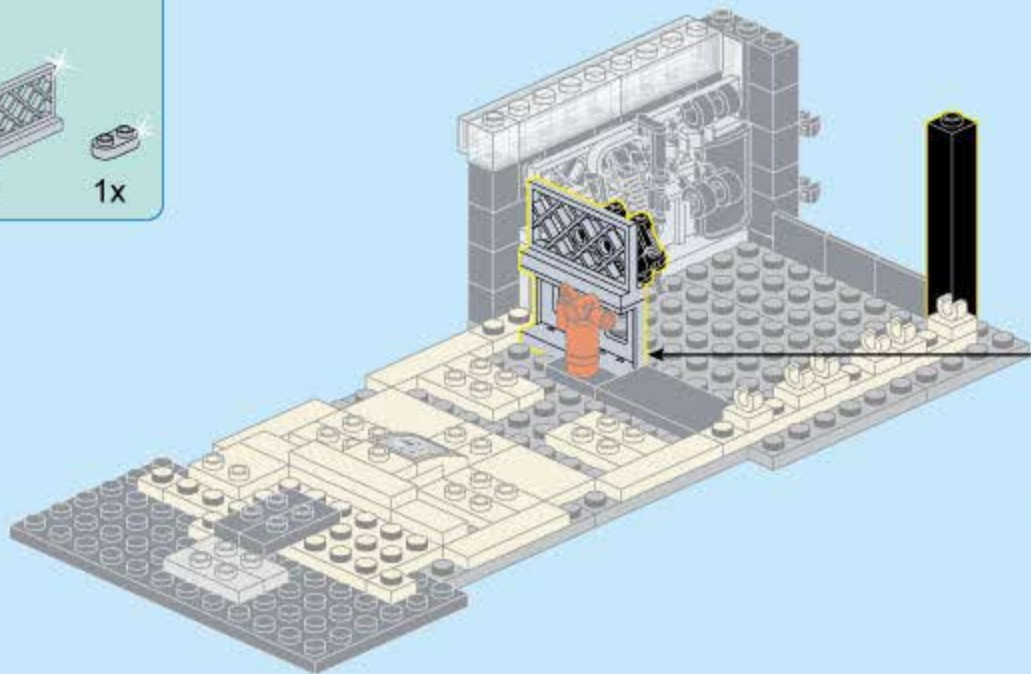
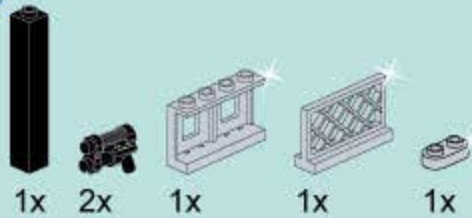

37

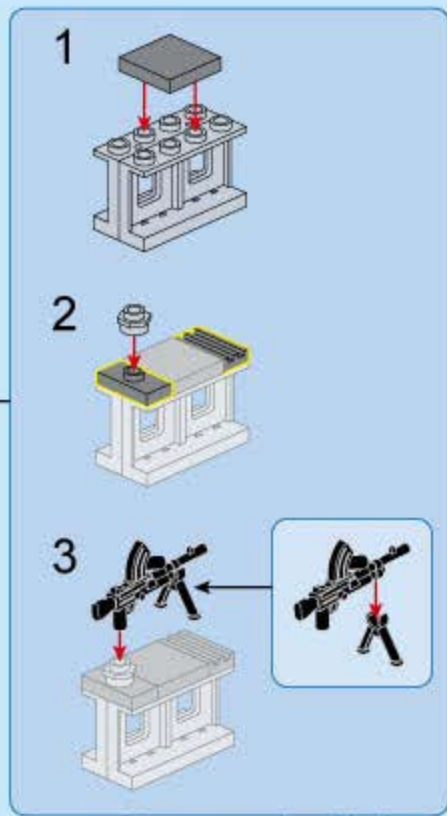
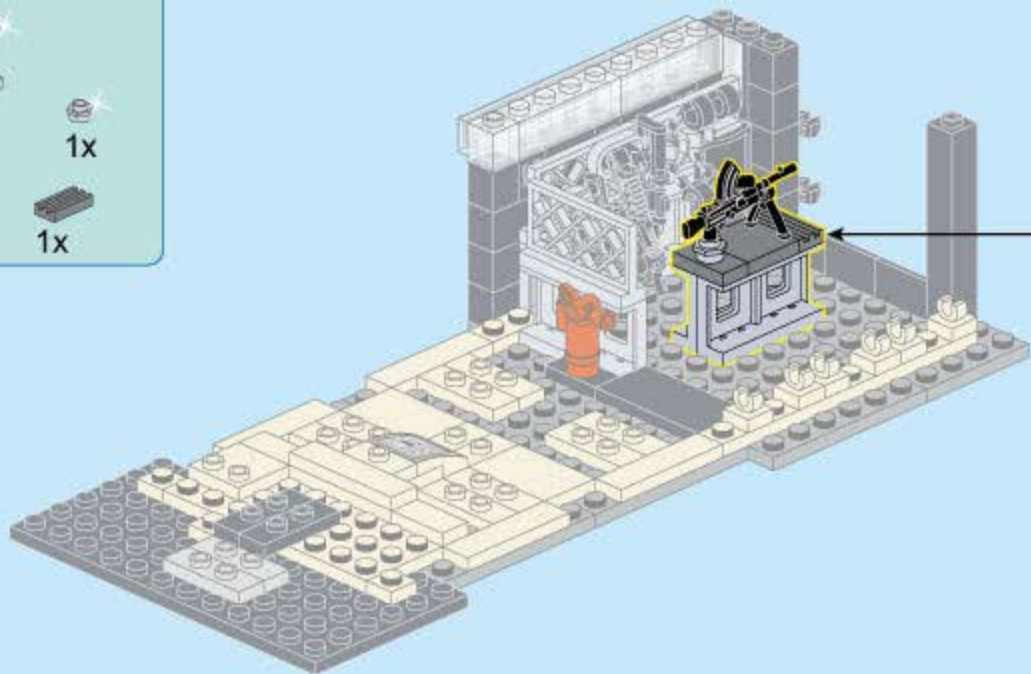
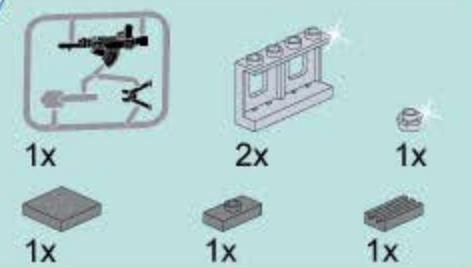

38

- 3x
- 3x
- 6x
- 3x
- 3x

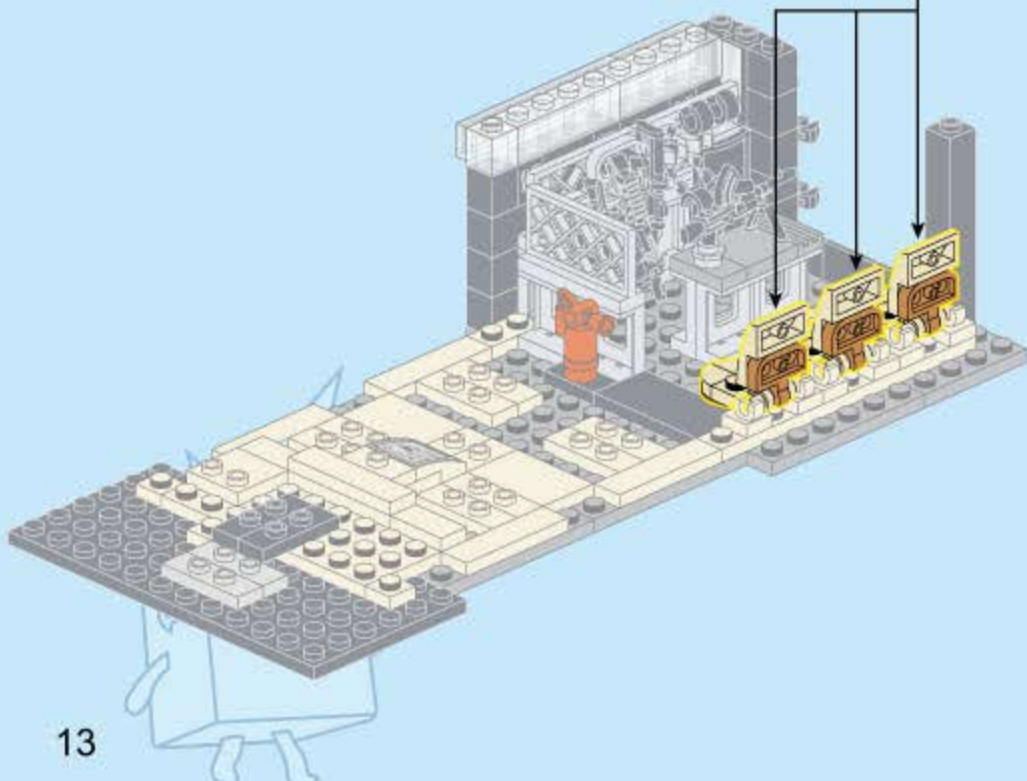
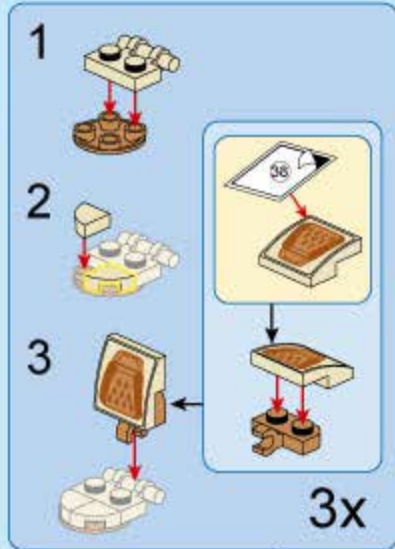

13

39

- 1x
- 1x
- 2x



40

- 1x
- 1x
- 1x

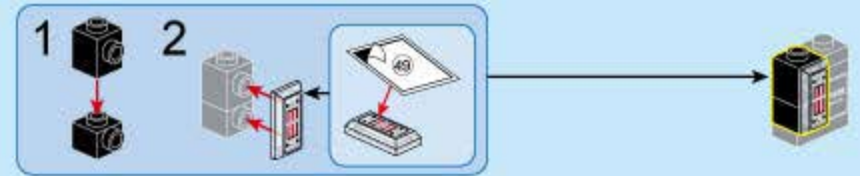

41

- 1x





42

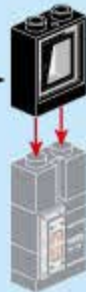
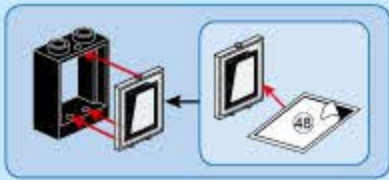

43

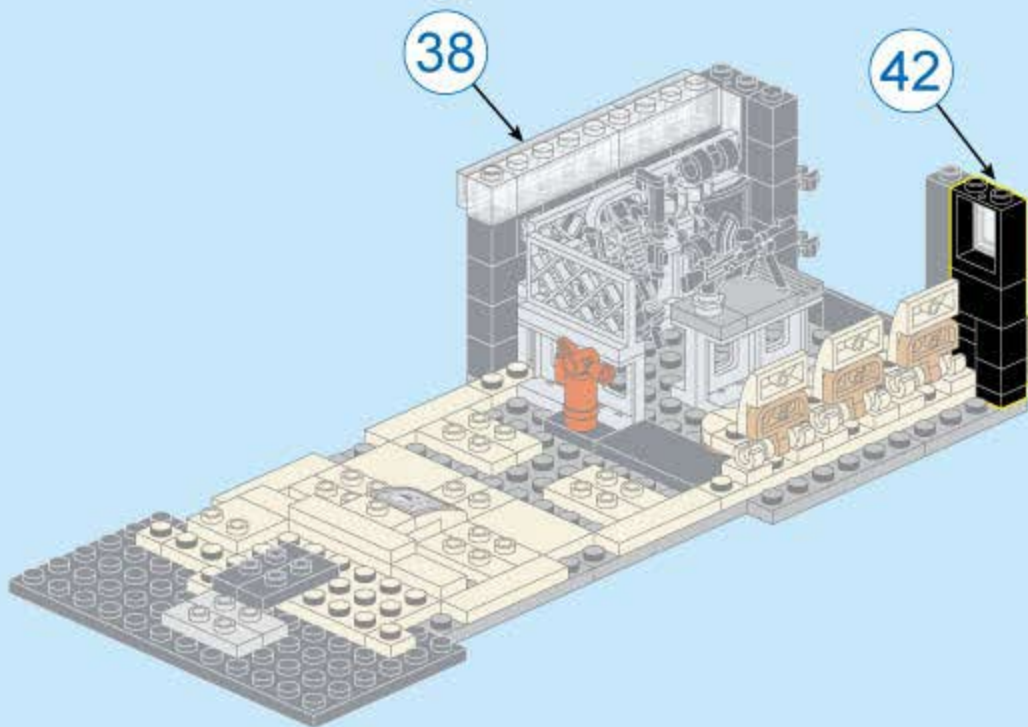

44

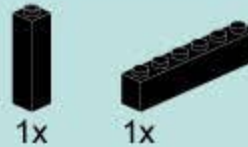

45

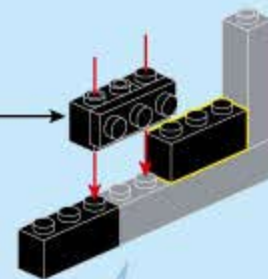
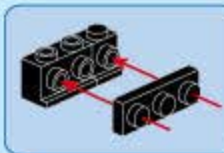

46

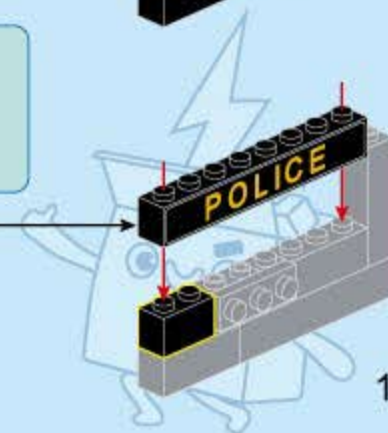

47

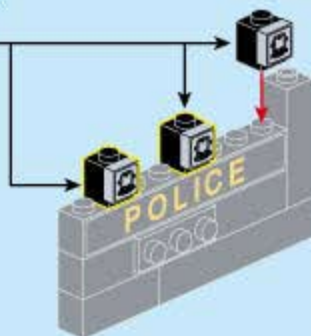
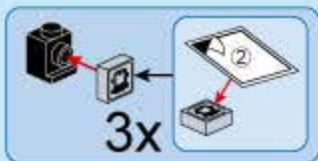

48



49

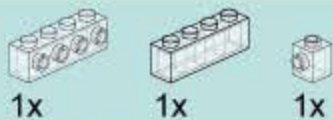

50

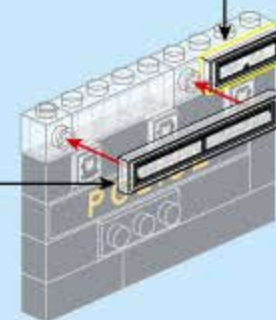
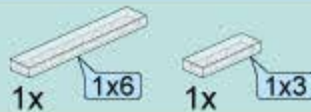

51

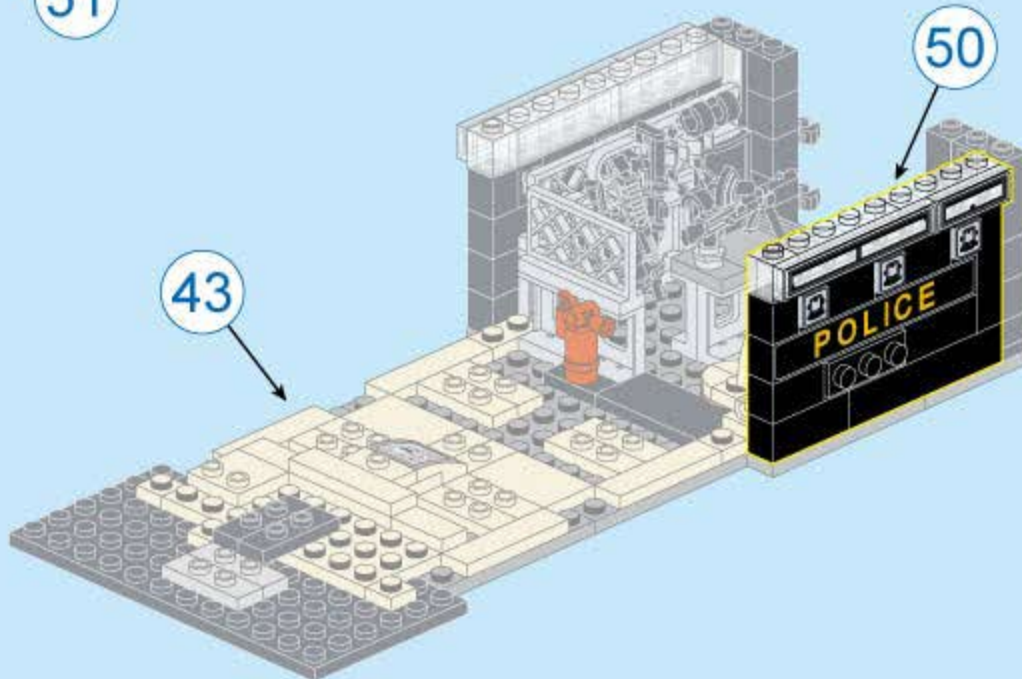



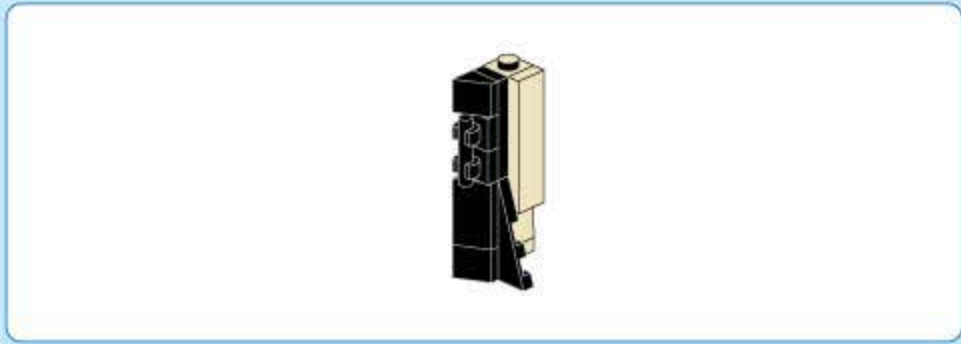

52

1x 1x



53

2x



54

1x 1x4

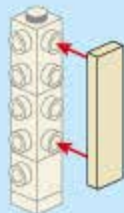

55

1x 1x 2x 1x<sup>2</sup>

1 2

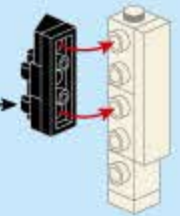

56

1x 1x 1x

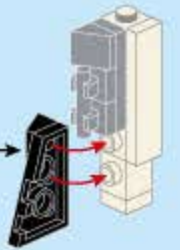

57

51 56

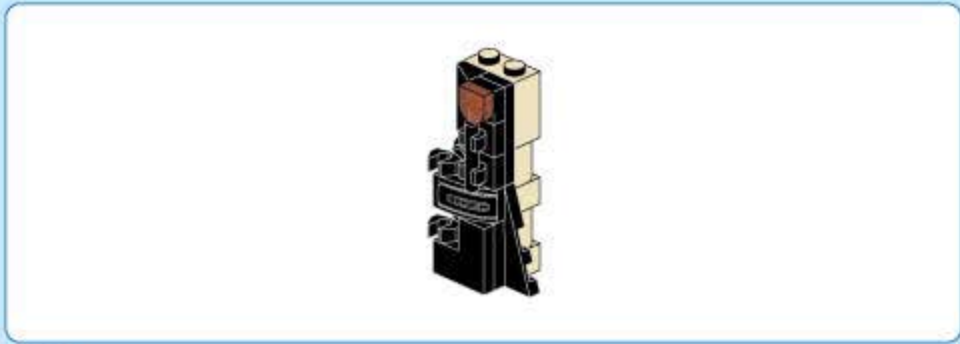

58

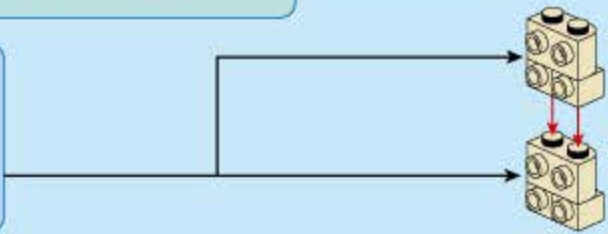
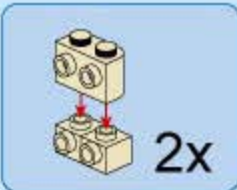

59



60

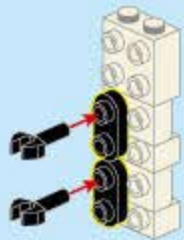

61

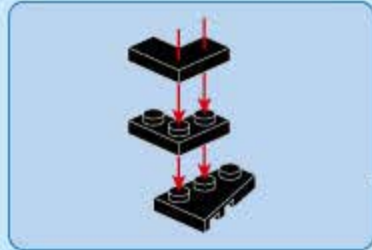

62

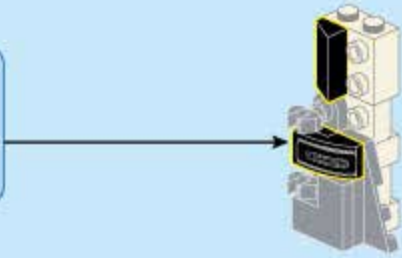

63

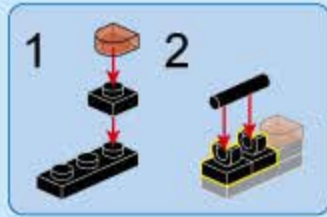



64

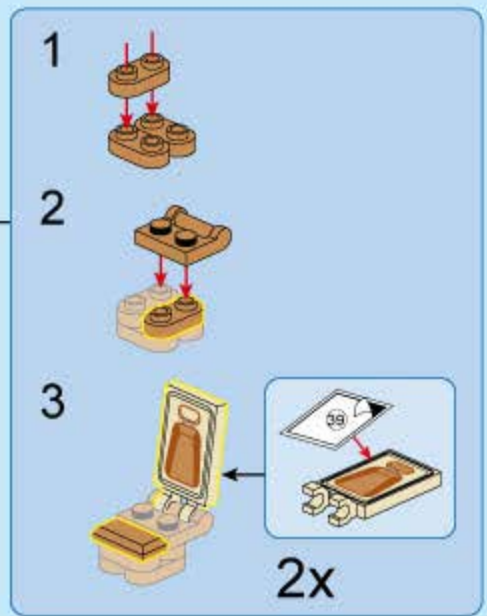
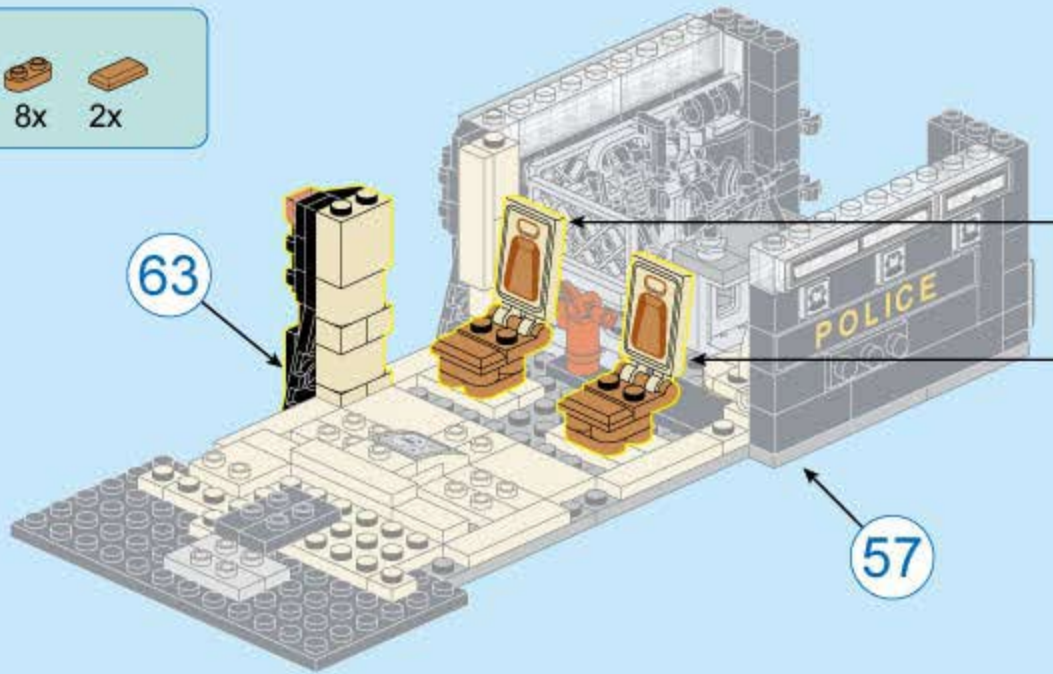

65

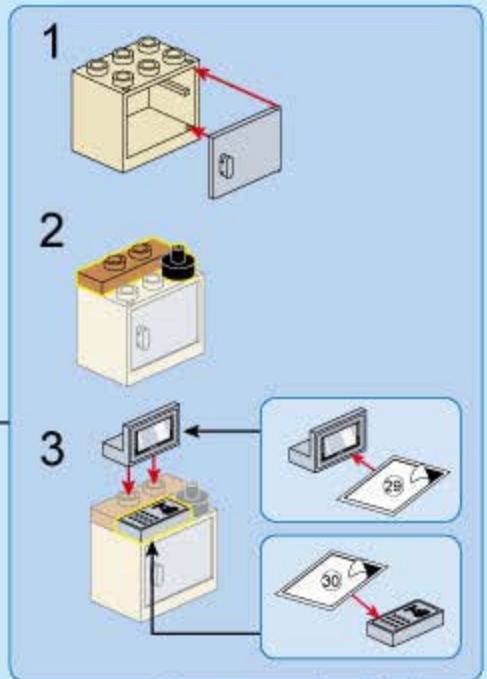
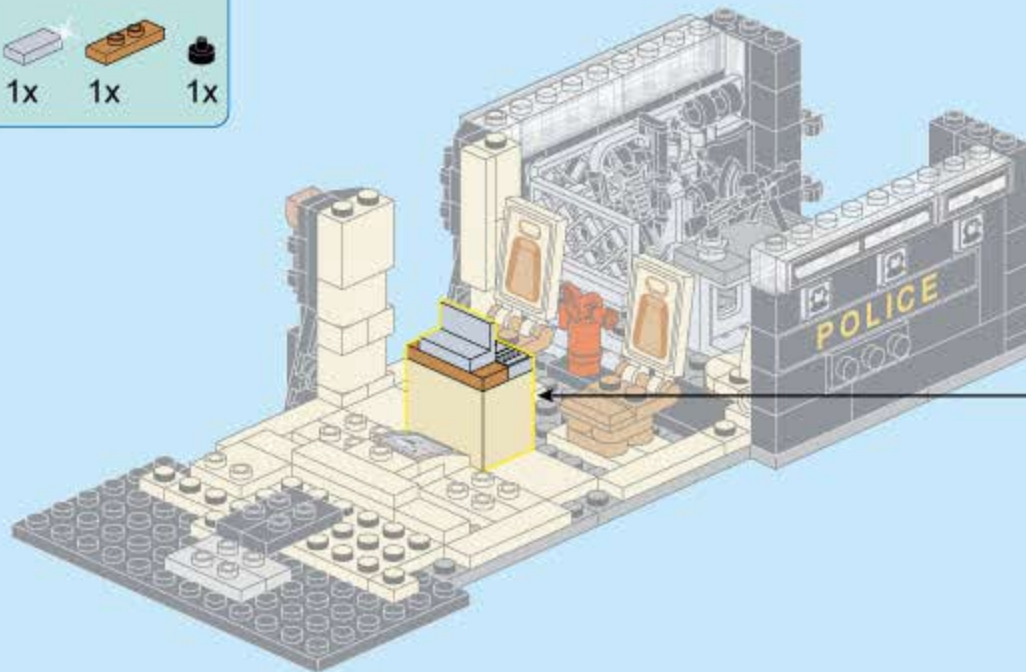
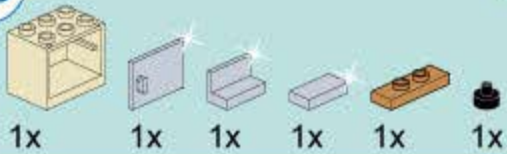

66



2x



2x



8x



2x



2x

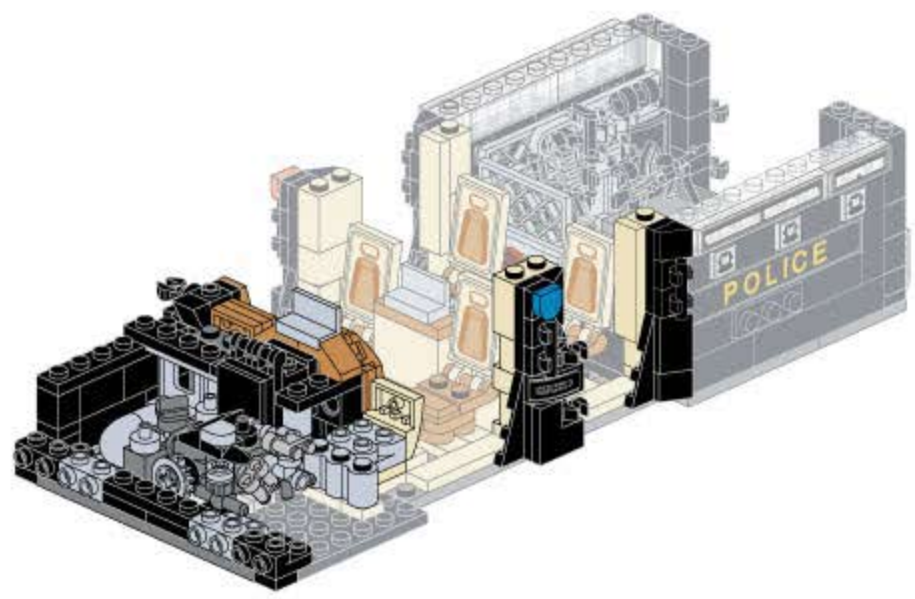
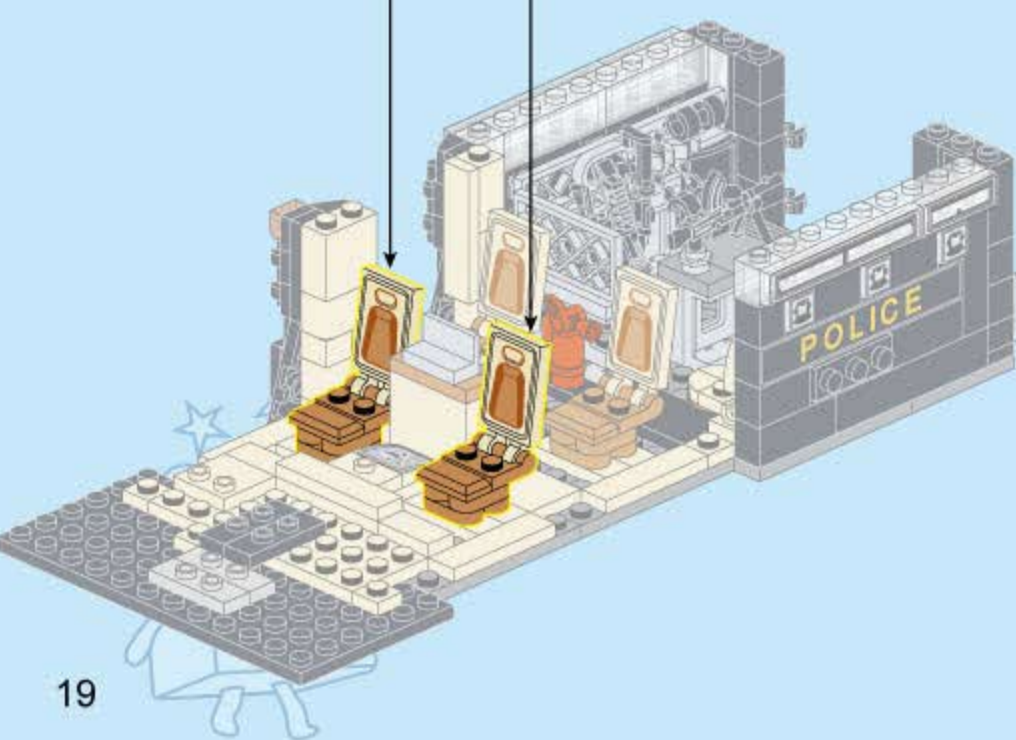





67

1x 2x

1:1



68

1x 1x



69

1x 1x 1x

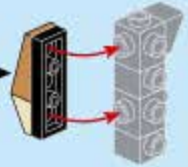
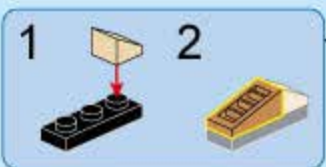

70

2x 2x 2x

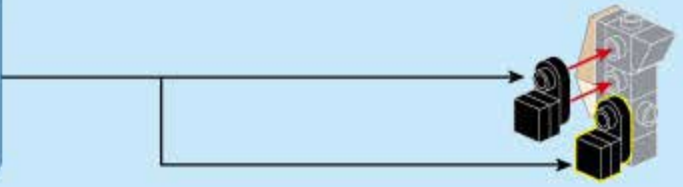

71

2x

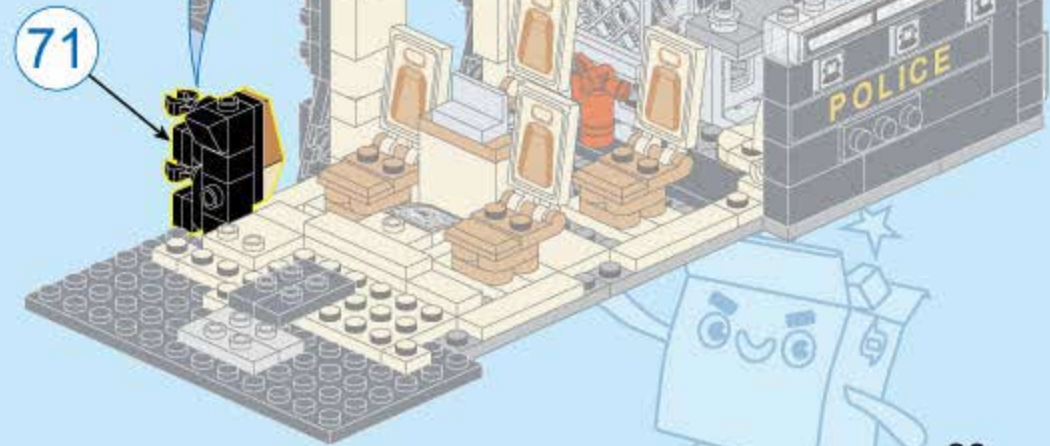
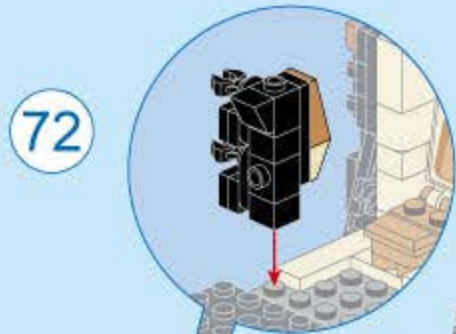

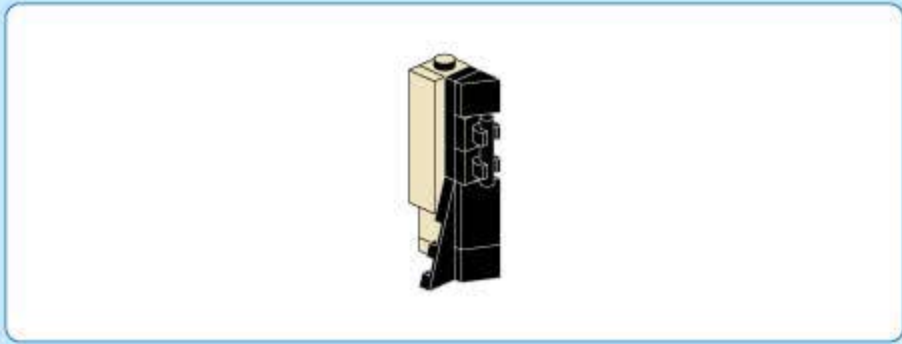

73

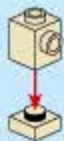

74



75

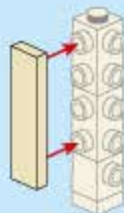
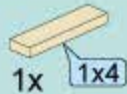

76

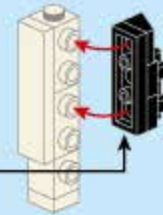
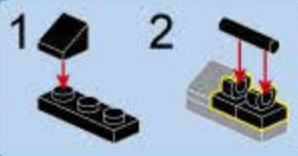

77

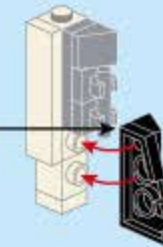

78

72

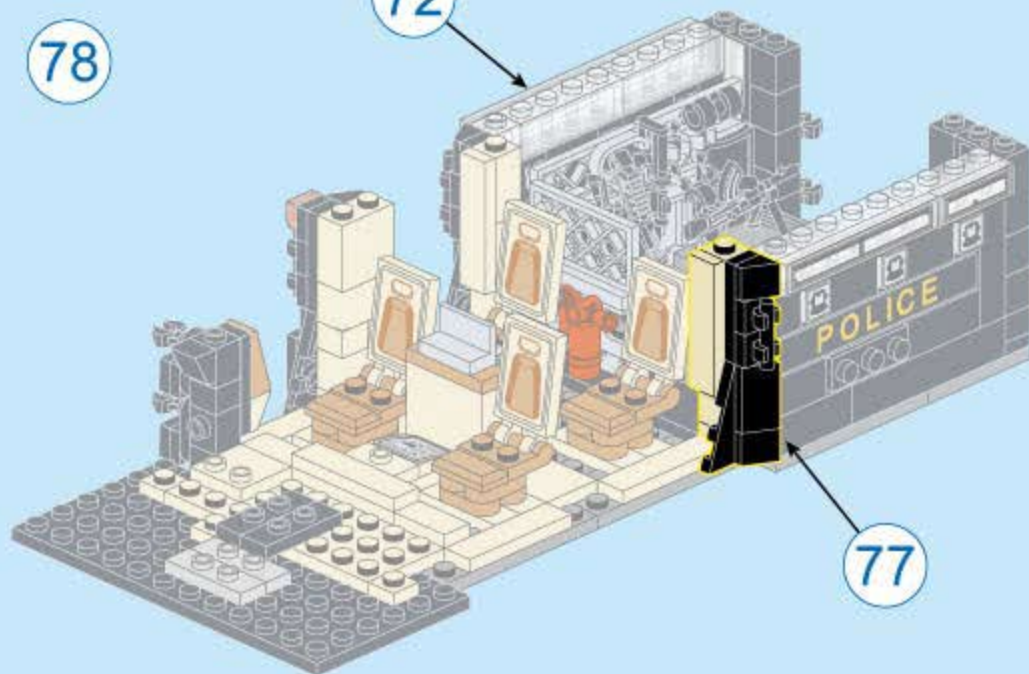

77





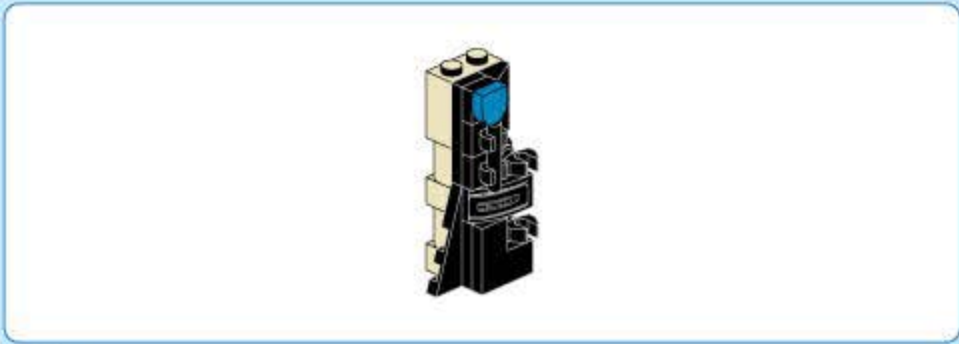

79

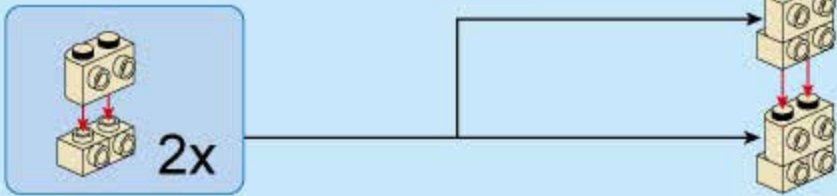

80



81

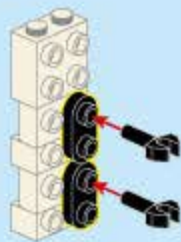

82

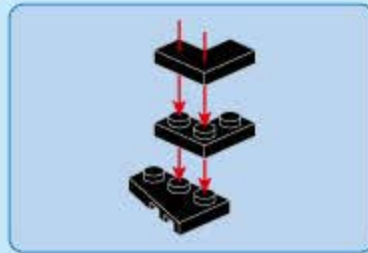

83



84

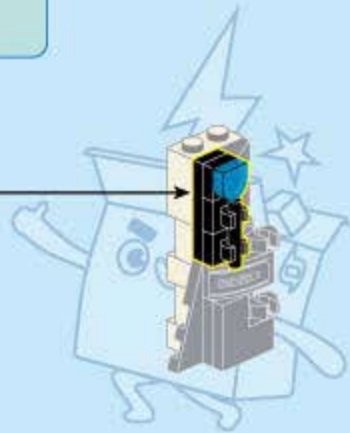
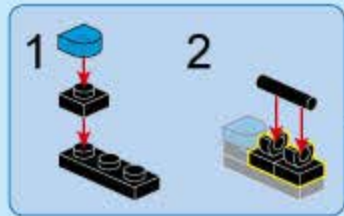

85

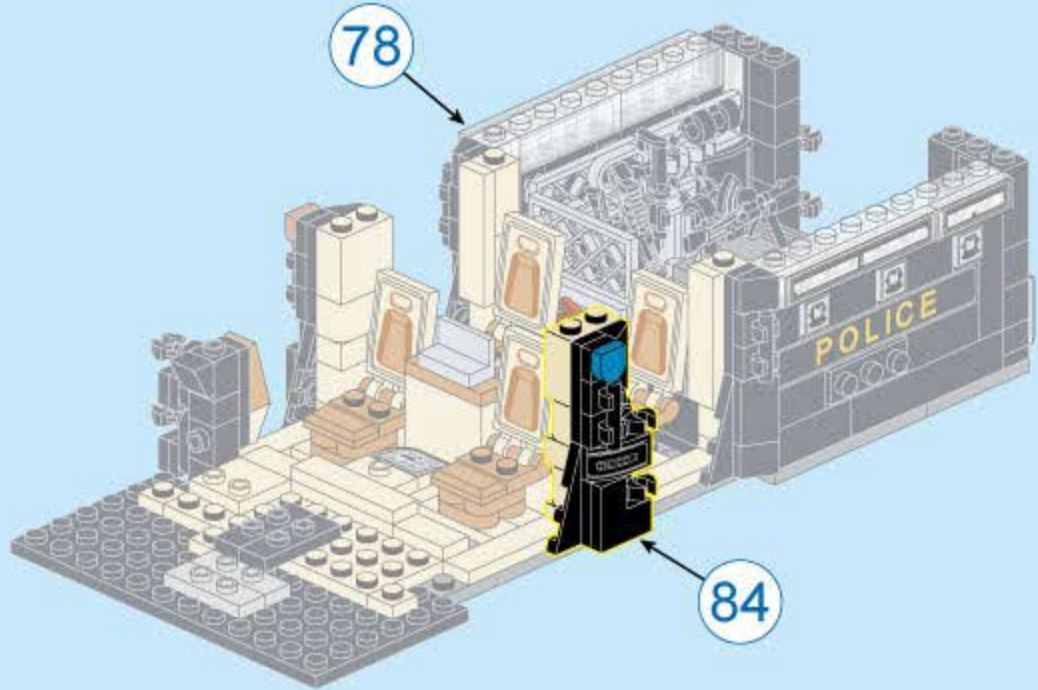

86

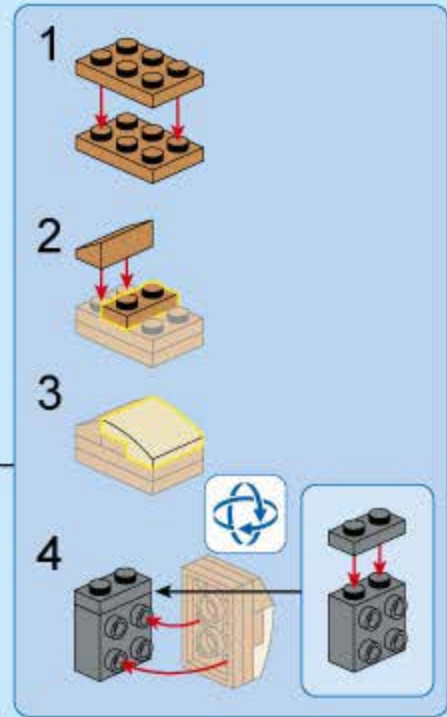
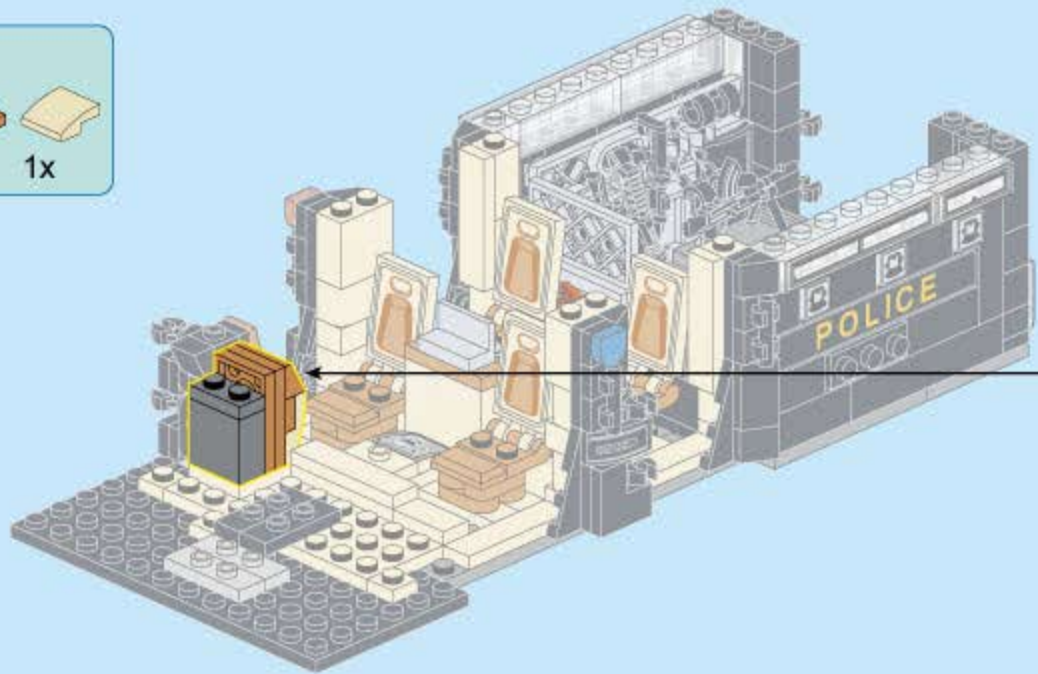
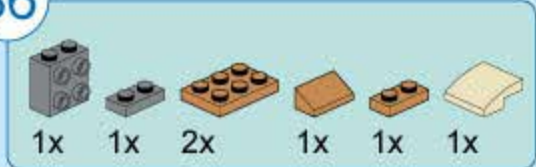







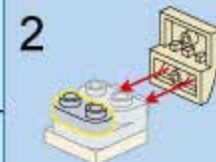
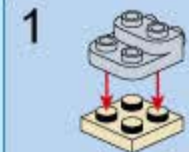
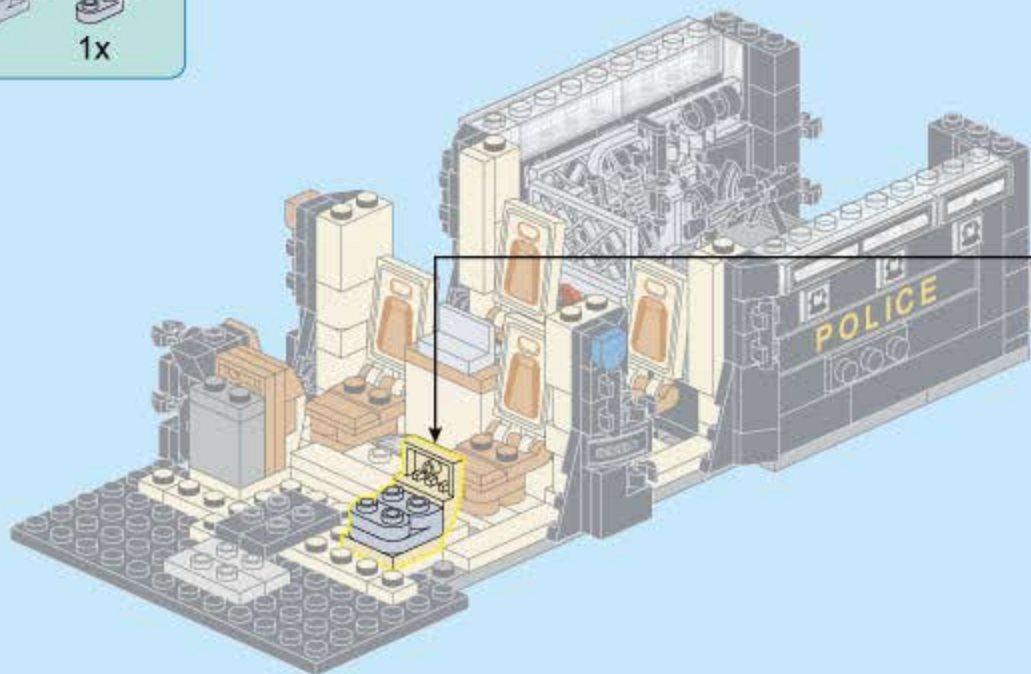

87

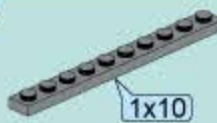
- 1x 
- 1x 
- 1x 
- 1x 



88

- 1x  1x10
- 1x 
- 2x 
- 2x 
- 2x 
- 2x 

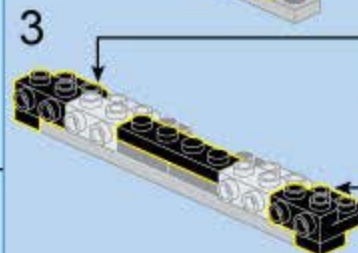
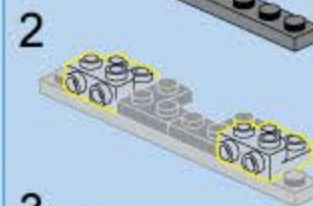
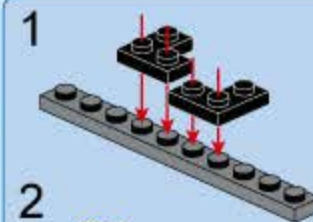
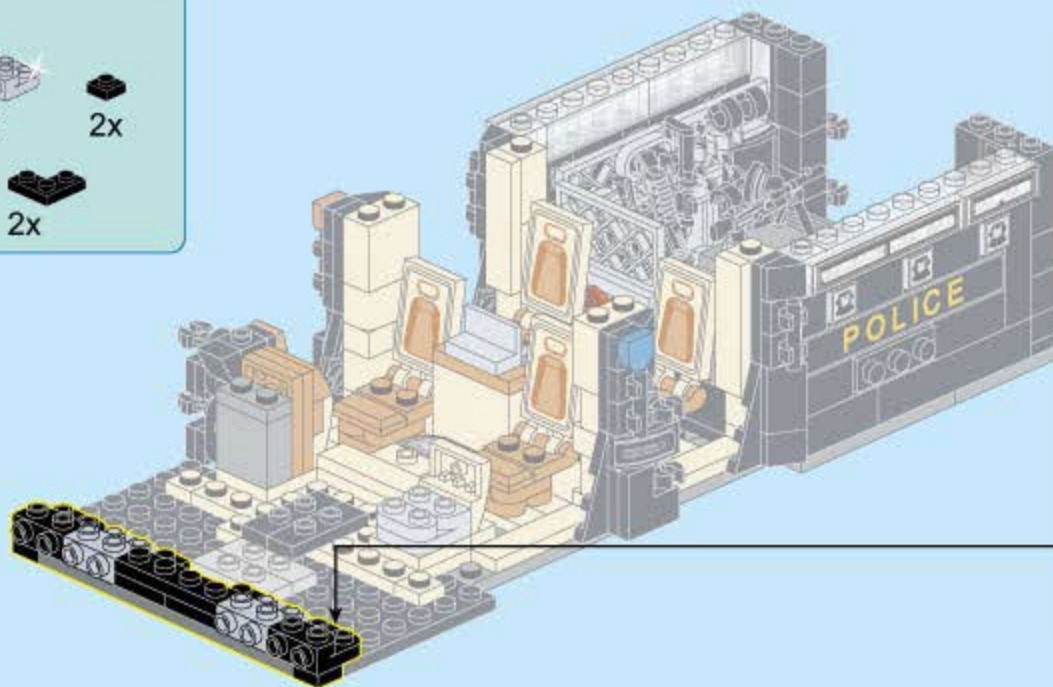

89

- 1x [1x 10-hole black Technic beam]
- 2x [2x 2-hole black Technic pins]
- 1x [1x 2-hole black Technic pin]
- 1x [1x 1-hole black Technic pin]
- 1x [1x 1-hole black Technic pin]
- 1x [1x 1-hole black Technic pin]
- 2x [2x 1-hole black Technic pins]

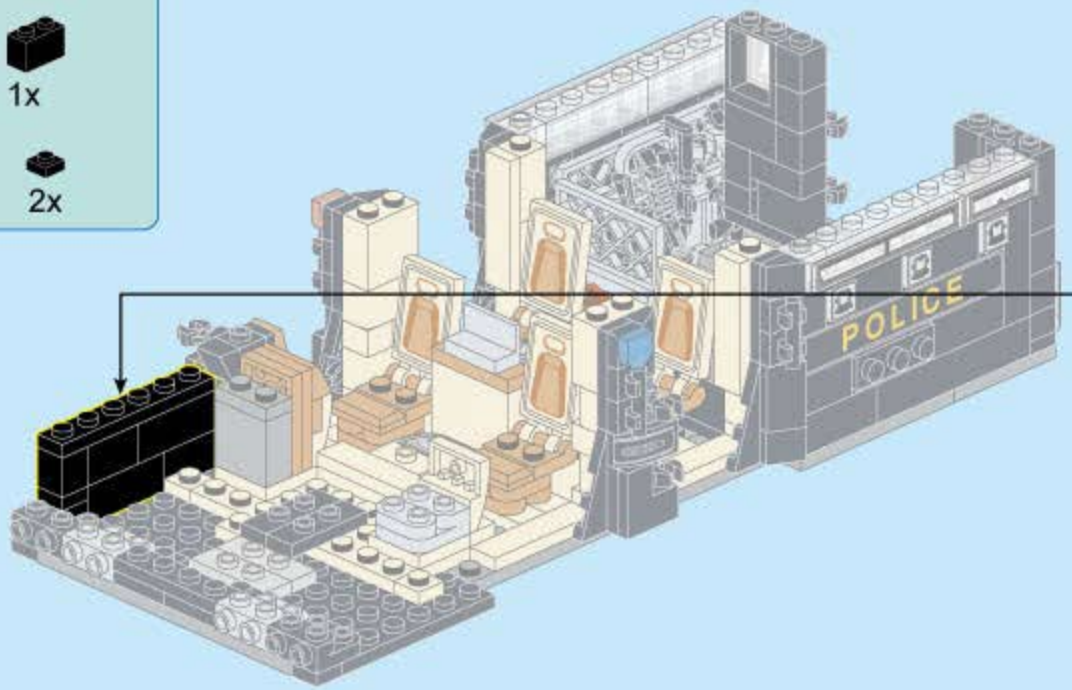

1. [1x 10-hole black Technic beam] ← [1x 2-hole black Technic pin]
2. [1x 10-hole black Technic beam] ← [1x 2-hole black Technic pin]
3. [1x 10-hole black Technic beam] ← [1x 2-hole black Technic pin]

90

- 1x [1x 1-hole black Technic pin]
- 1x [1x 1-hole black Technic pin]
- 1x [1x 1-hole black Technic pin]
- 1x [1x 1-hole black Technic pin]

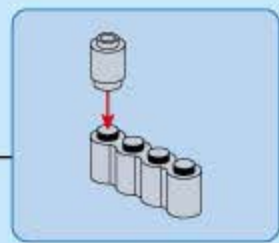
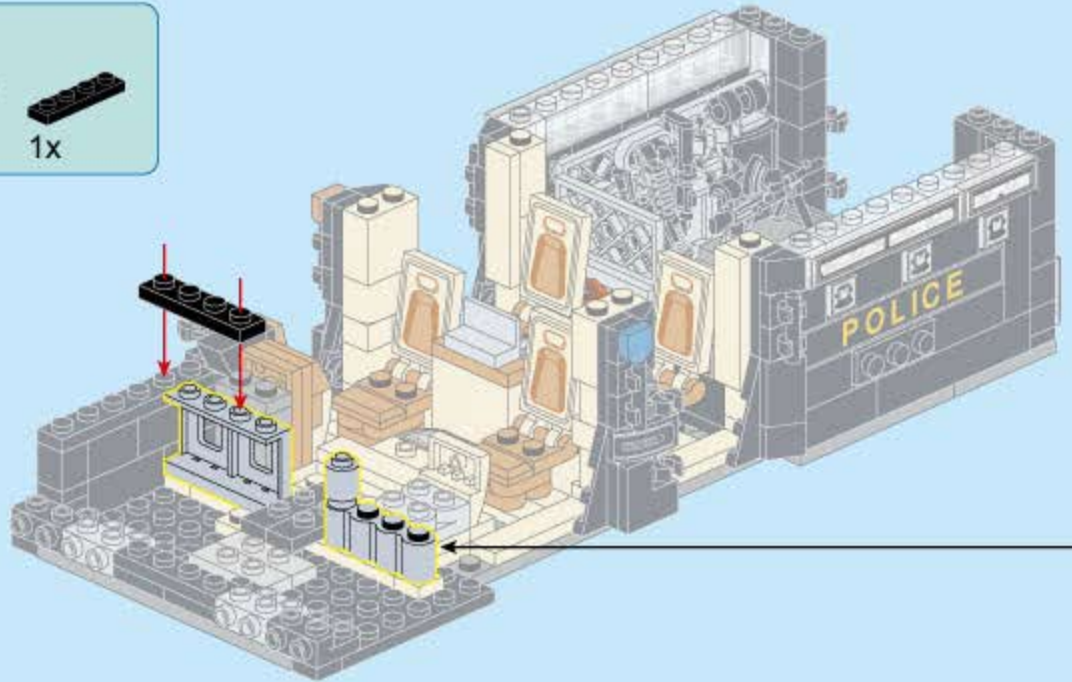





91

1x 2x



92

1x 2x

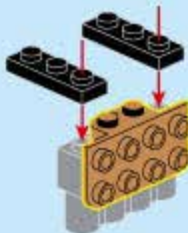

93

1x 2x 1x

1 2



94

1x



95

1x 1x4 1x

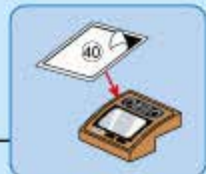

96

1x 1x



97

96

90

98

- 1x [Black 1x2 Technic Brick]
- 1x [Black 1x2 Technic Brick]
- 1x [Black 1x2 Technic Brick]
- 2x [Black 1x2 Technic Brick]
- 2x [Black 1x2 Technic Brick]
- 2x [Black 1x2 Technic Brick]
- 1x [Grey 1x2 Technic Brick]
- 1x [Grey 1x2 Technic Brick]
- 1x [Red 1x2 Technic Brick]

1:1

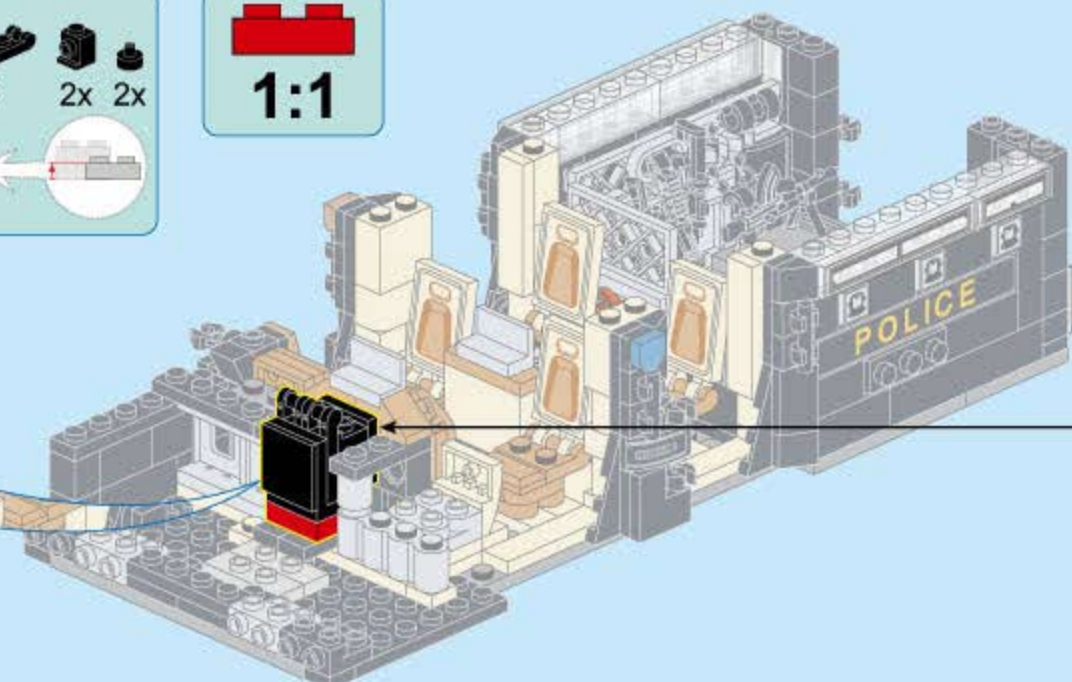
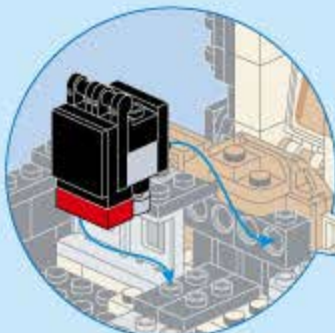

1

2

3

1

2

1

2

3

99

- 1x [Grey 1x2 Technic Brick]
- 2x [Grey 1x2 Technic Brick]
- 2x [Grey 1x2 Technic Brick]
- 1x [Grey 1x2 Technic Brick]
- 1x [Grey 1x2 Technic Brick]

1

2

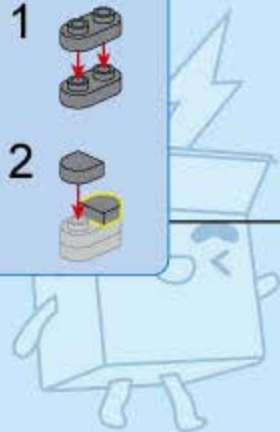
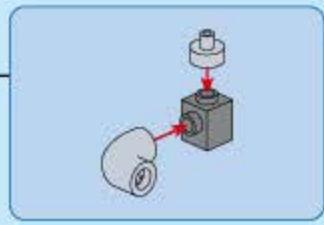
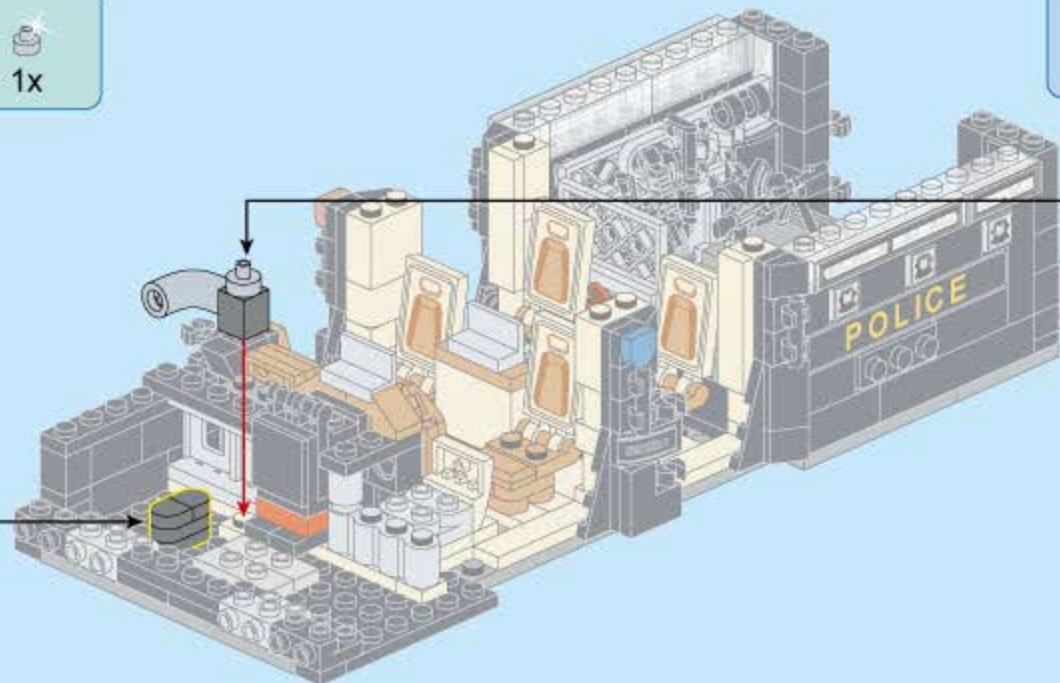





100

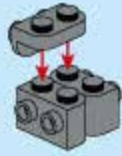

101

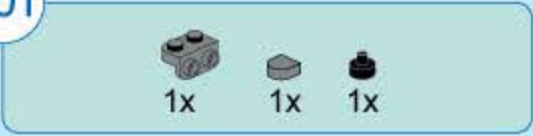

102



103



104



105



106

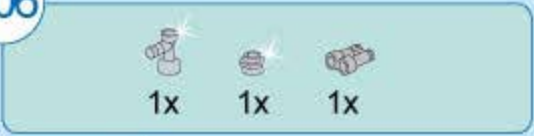

107

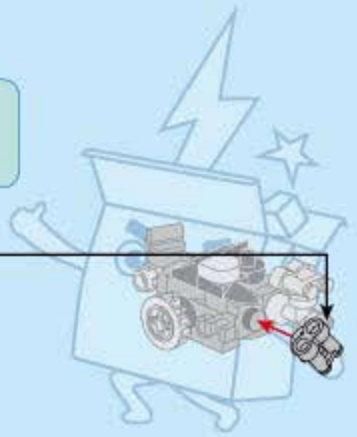
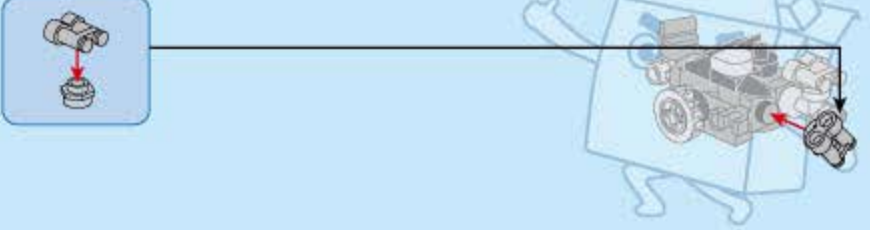
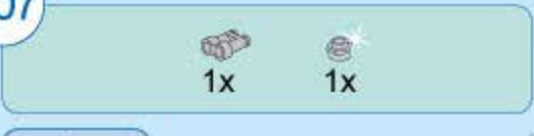

108



1x



1x



1:1

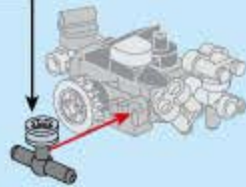
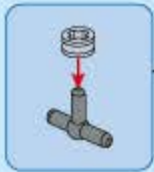

110



1x



1x



1x

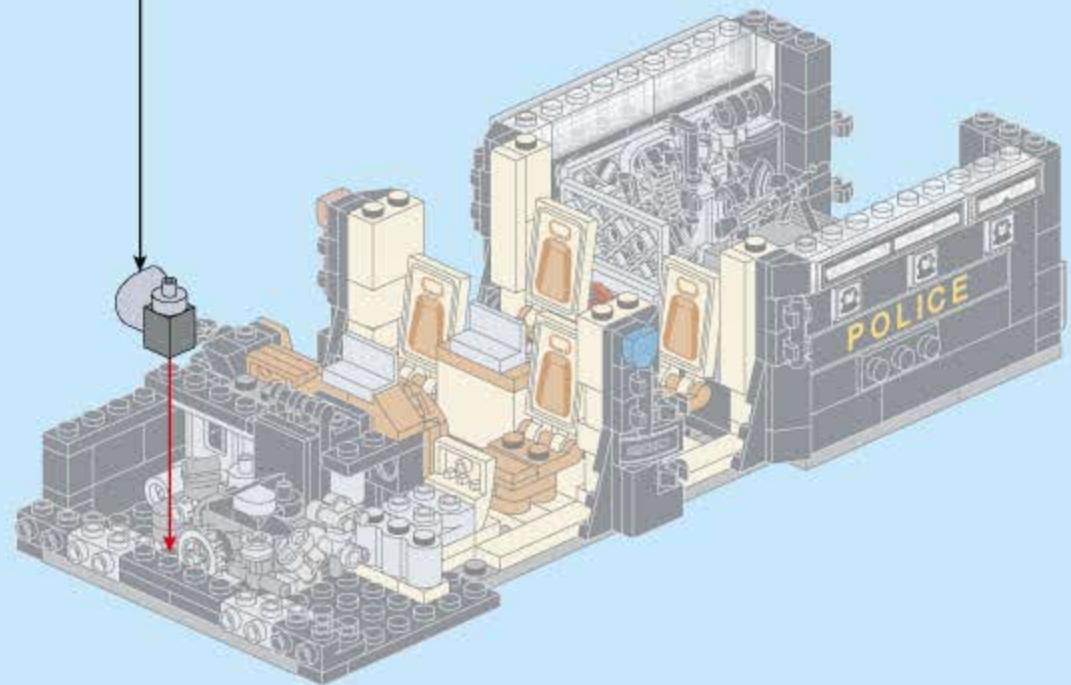
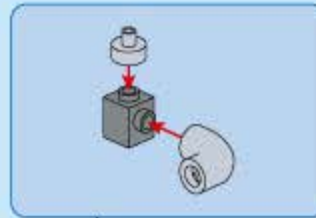

109

99

108

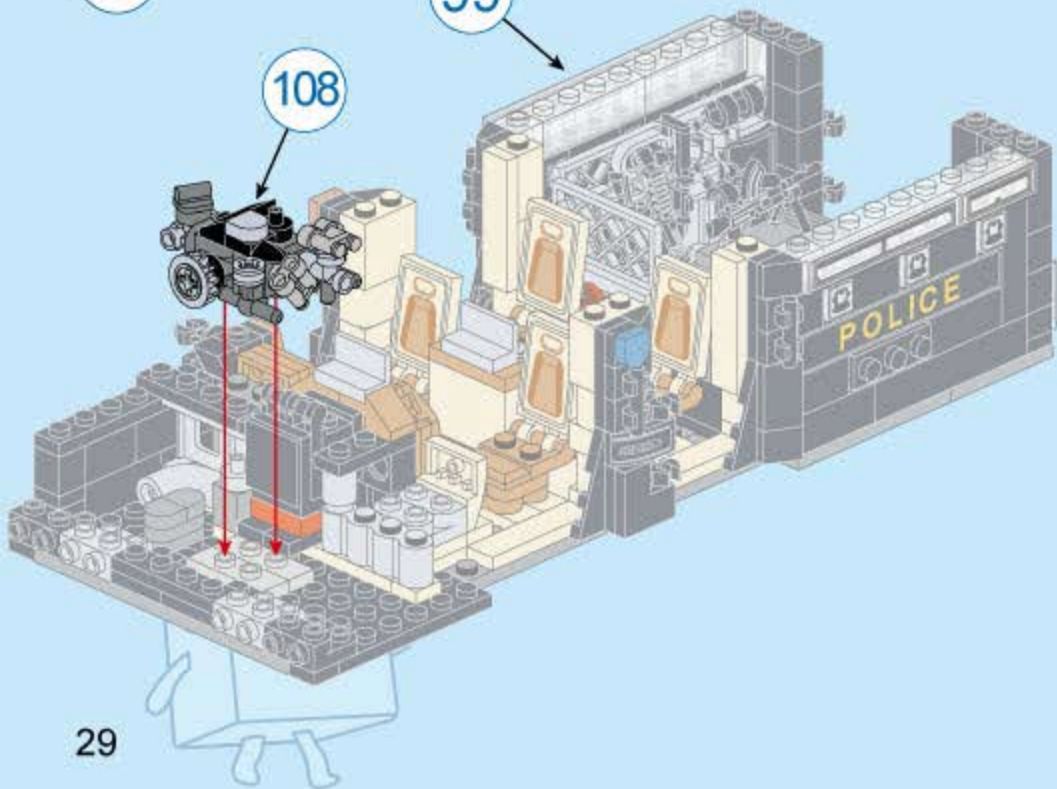



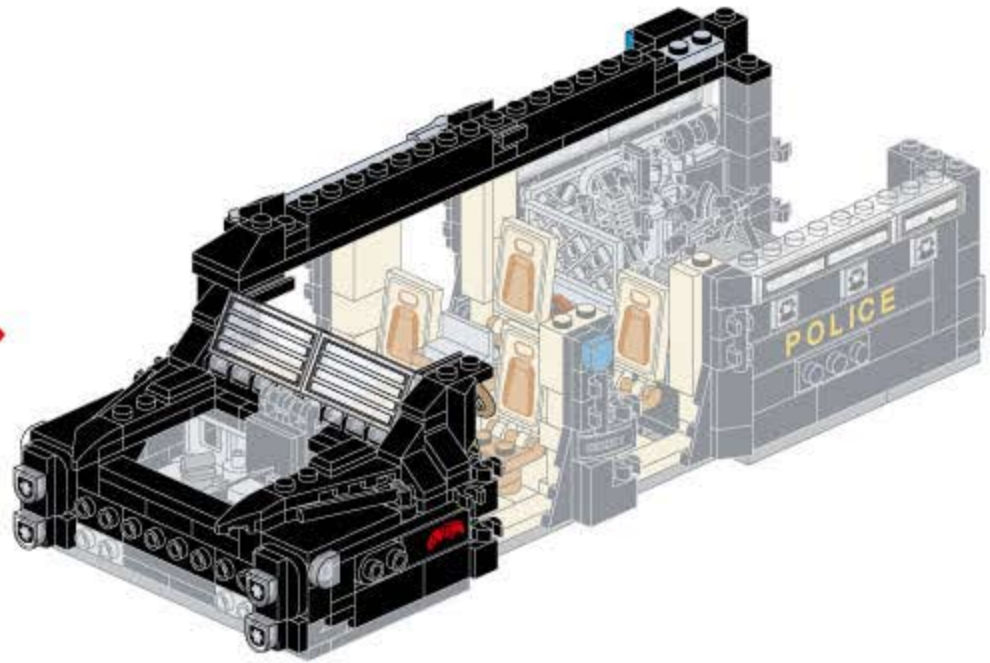

111



1x



2x



1x



2x

1

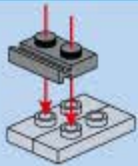

2

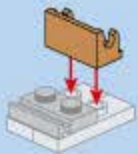

3

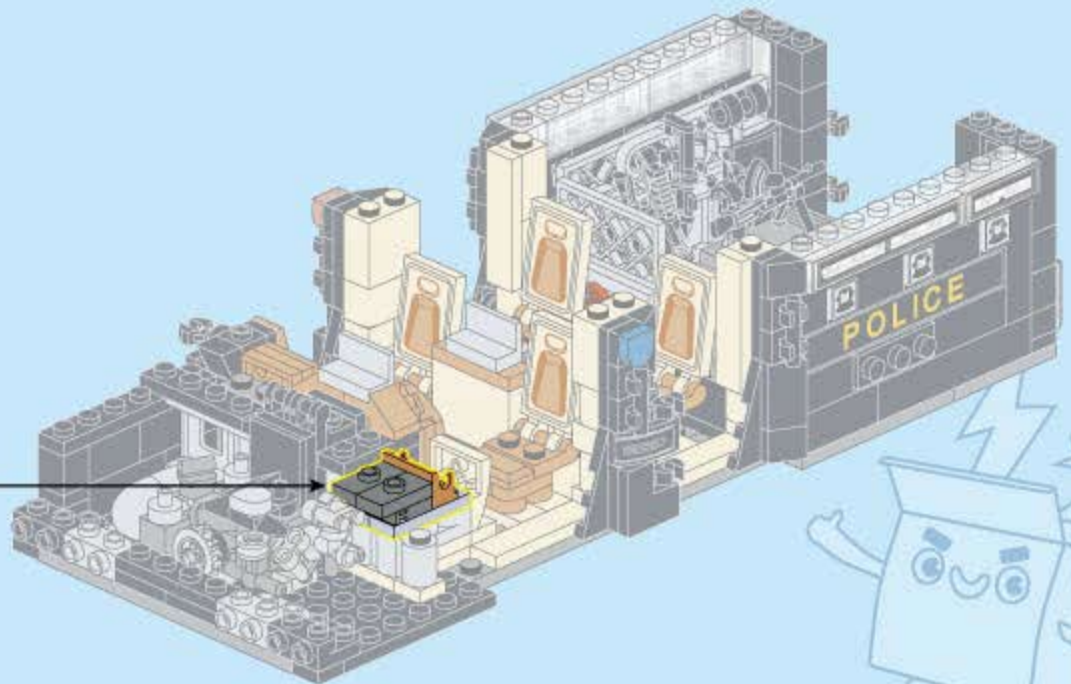

112

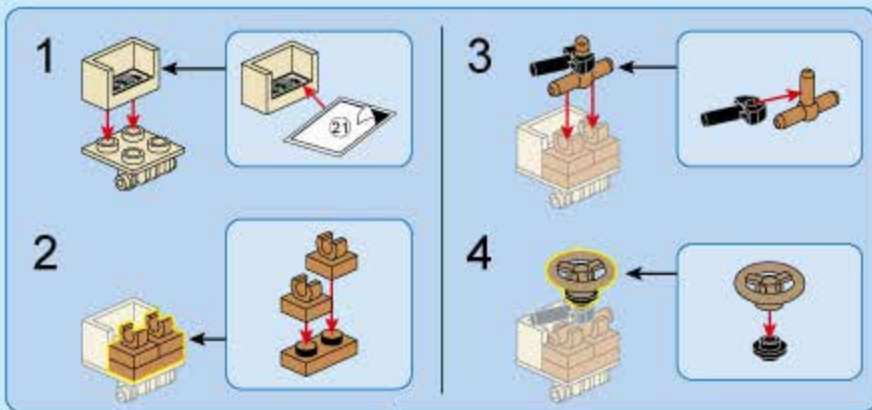
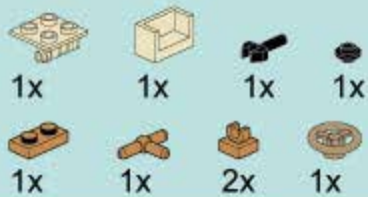

113



114



115

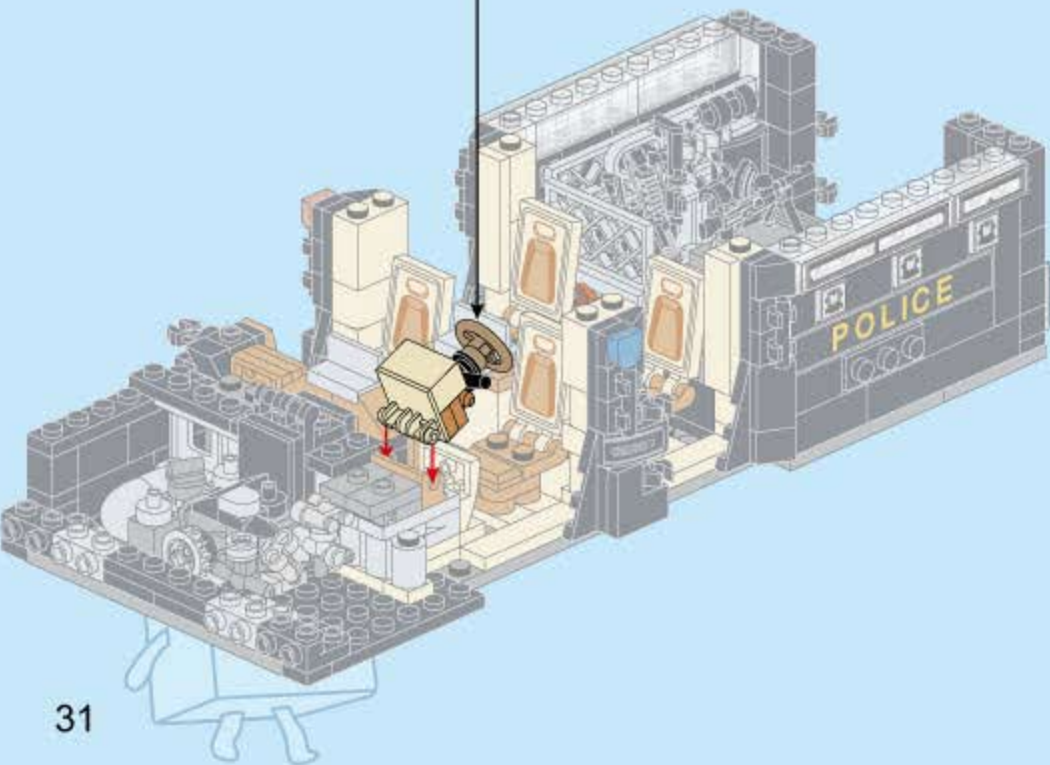
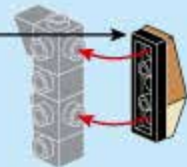
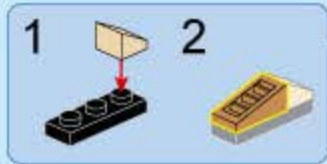



116

2x 2x 2x



2x

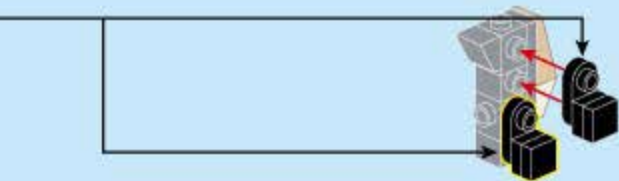

117

2x



118

1x

112

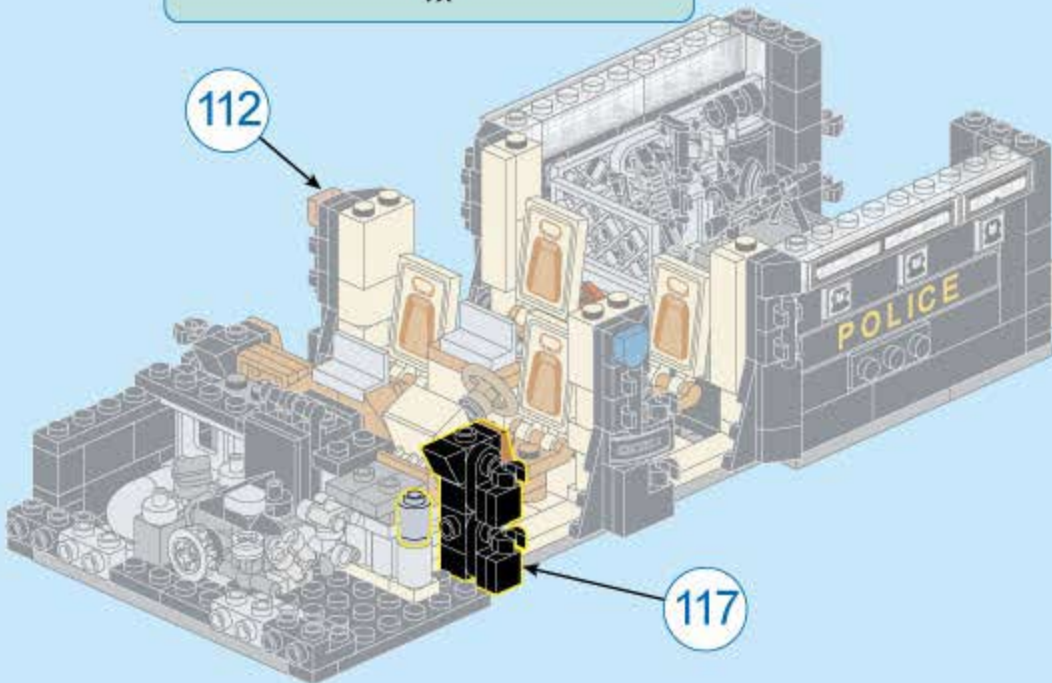

117

119

1x 1x 1x 2x  
2x 1x 1x 1x

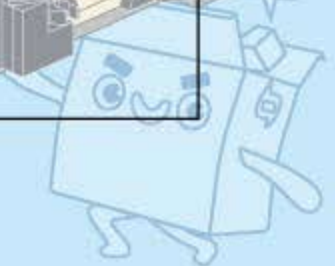
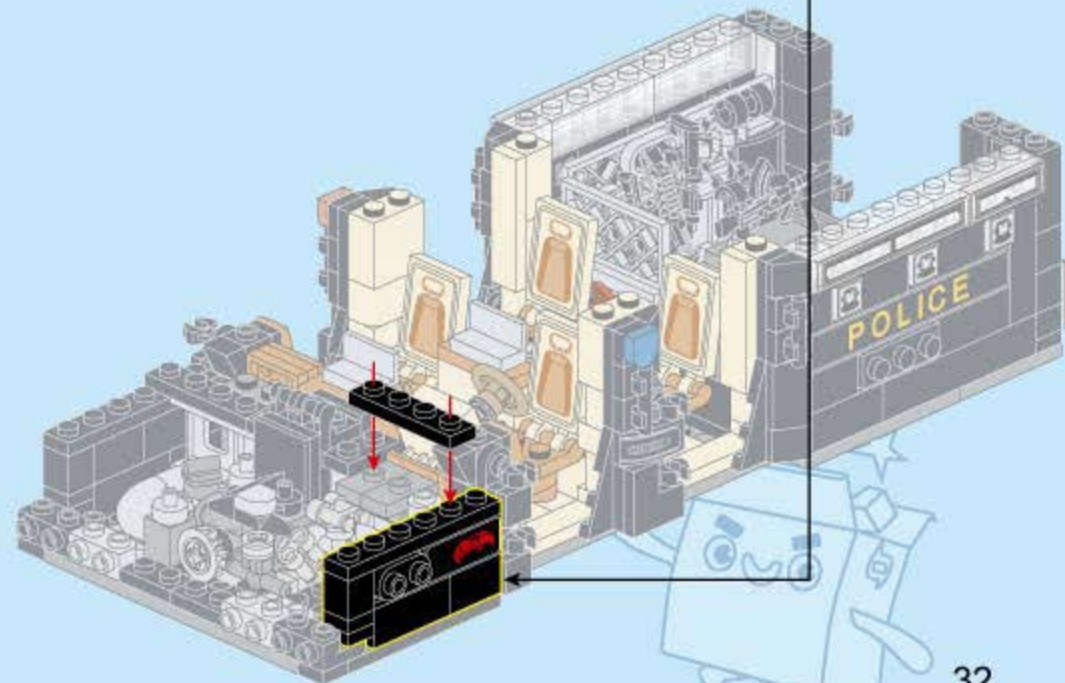
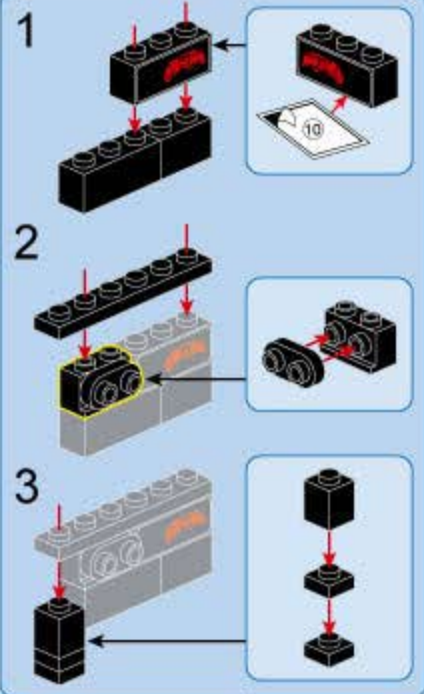

120



2x



6x

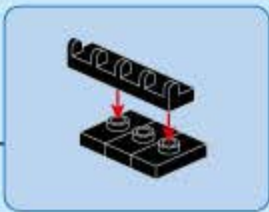
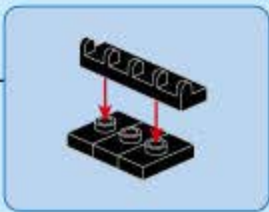
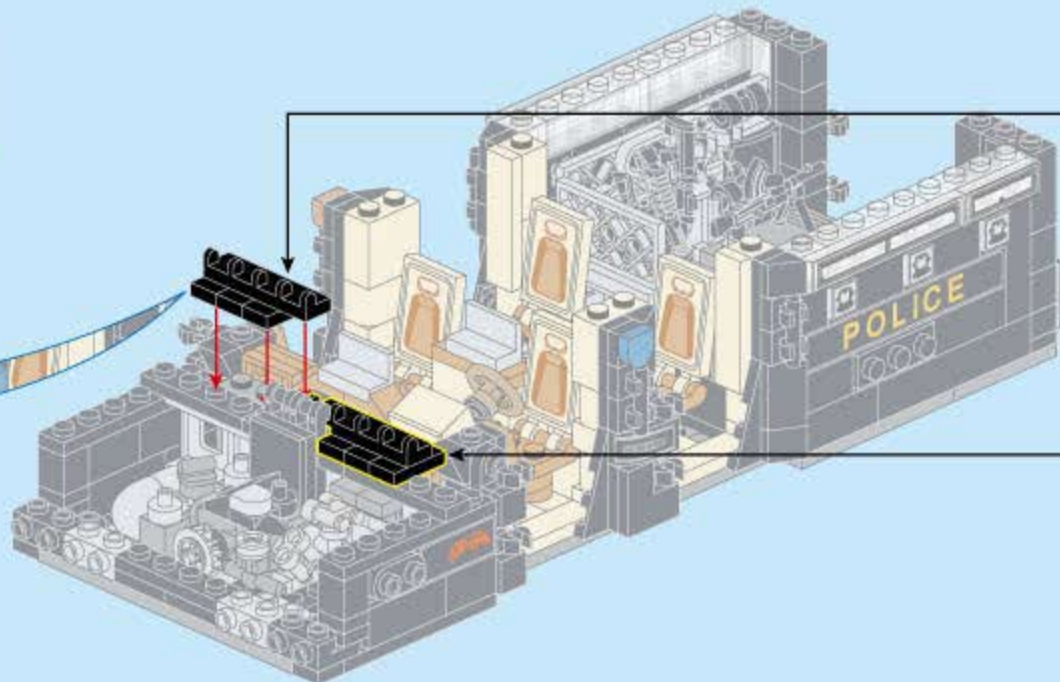
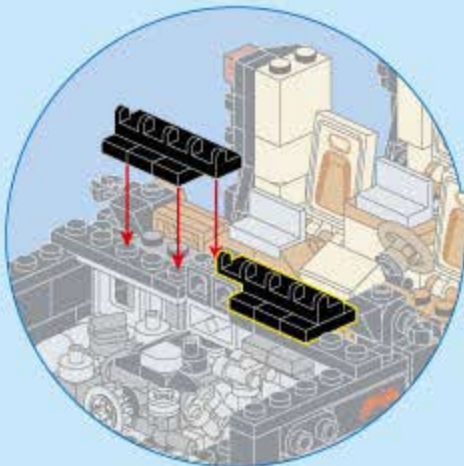

121



2x



2x



2x

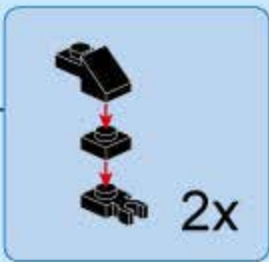
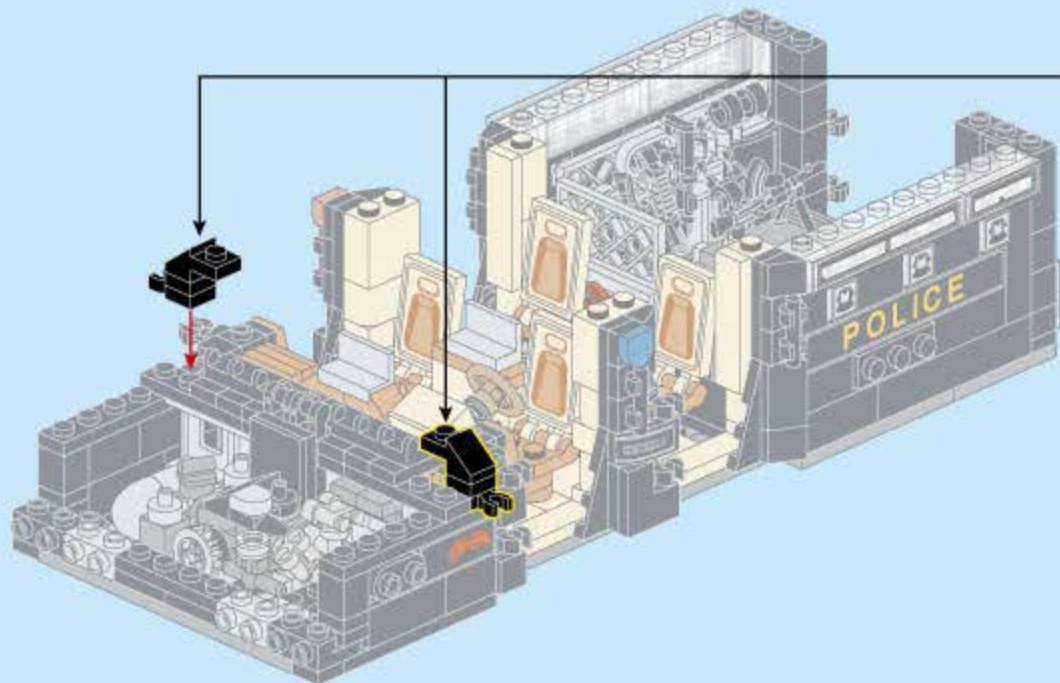



122

4x 2x

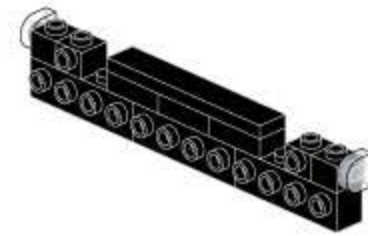
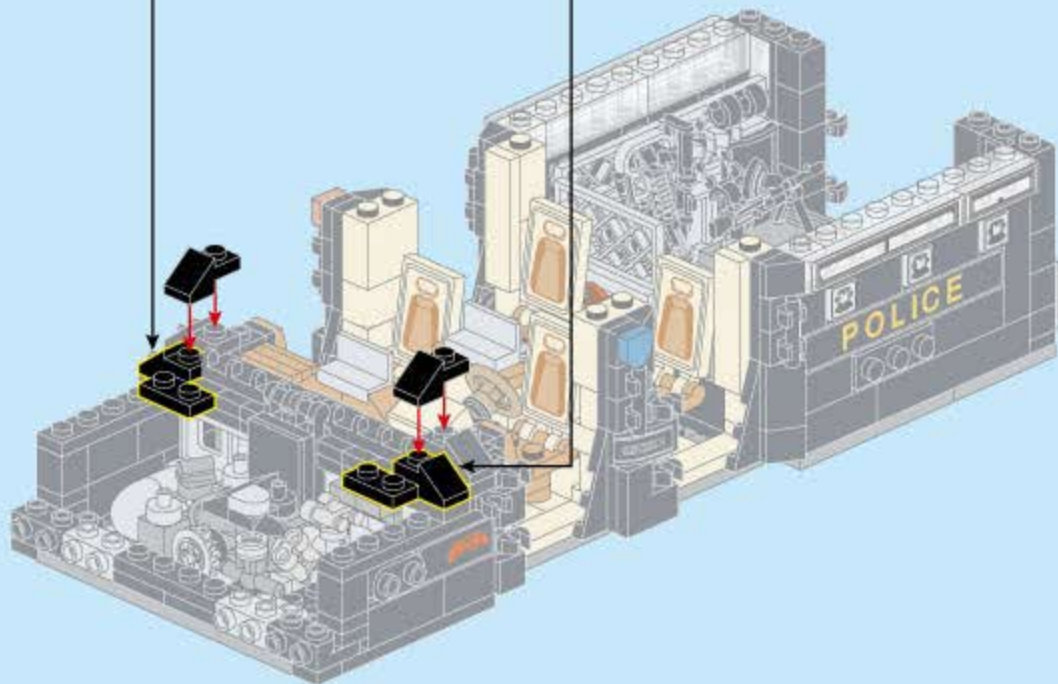

123

2x 1x

1:1



124

1x 2x

1:1

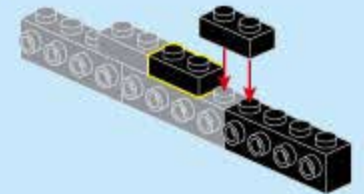

125

2x 1x 1x6 4x

1:1

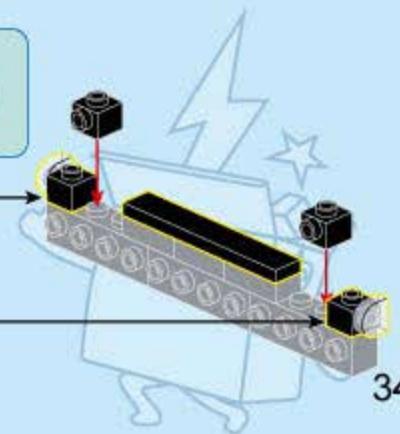

126



122

125

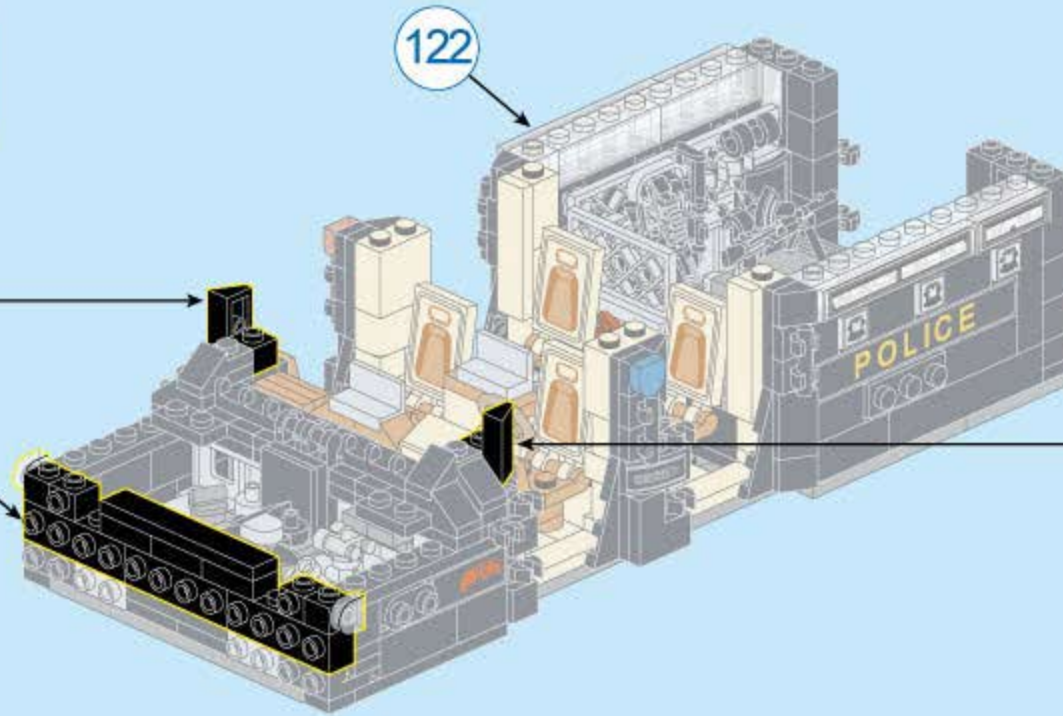

127

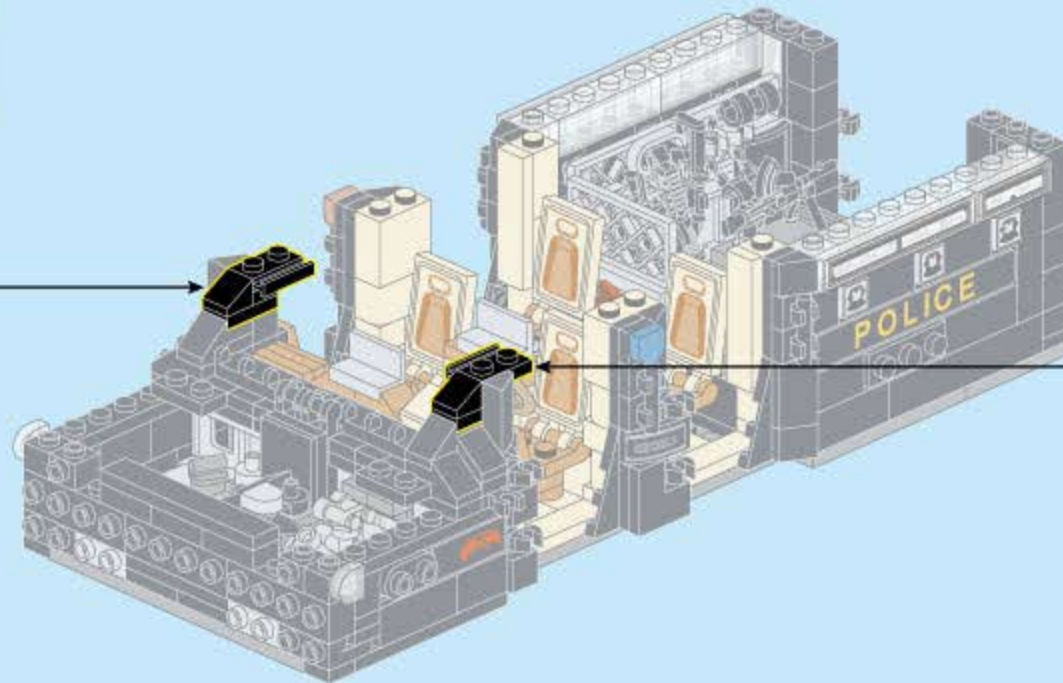
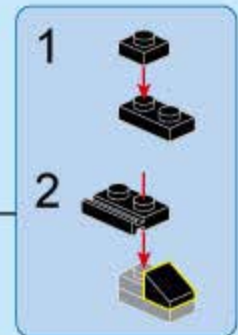
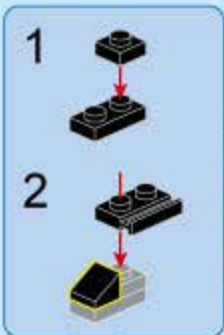



128



2x

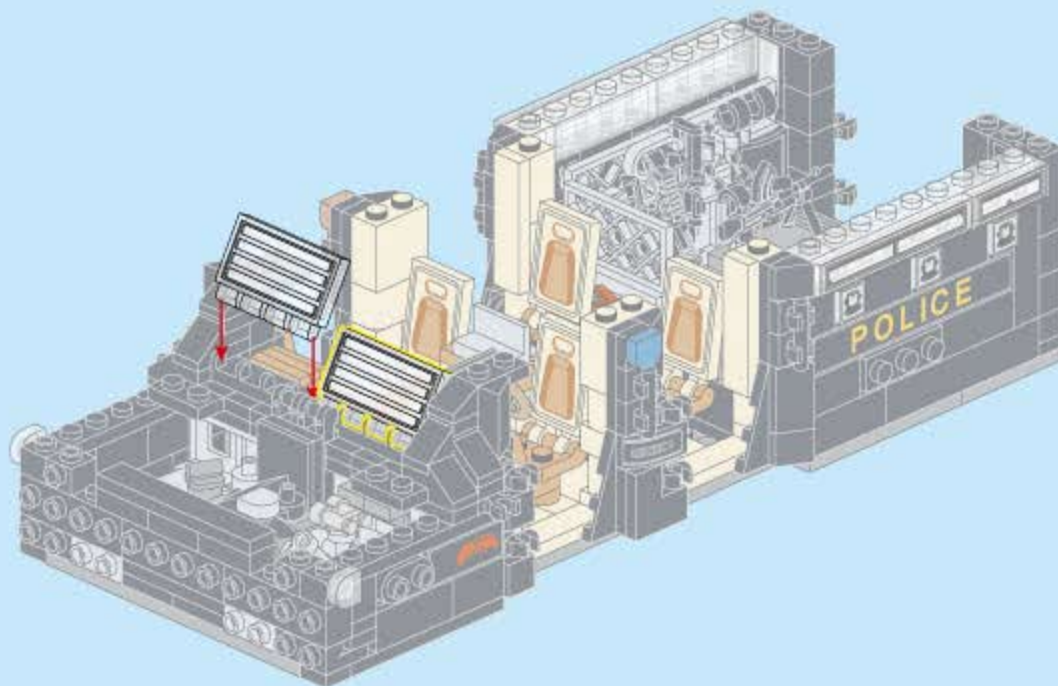

129



2x

2x4



2x

4



2x



2x

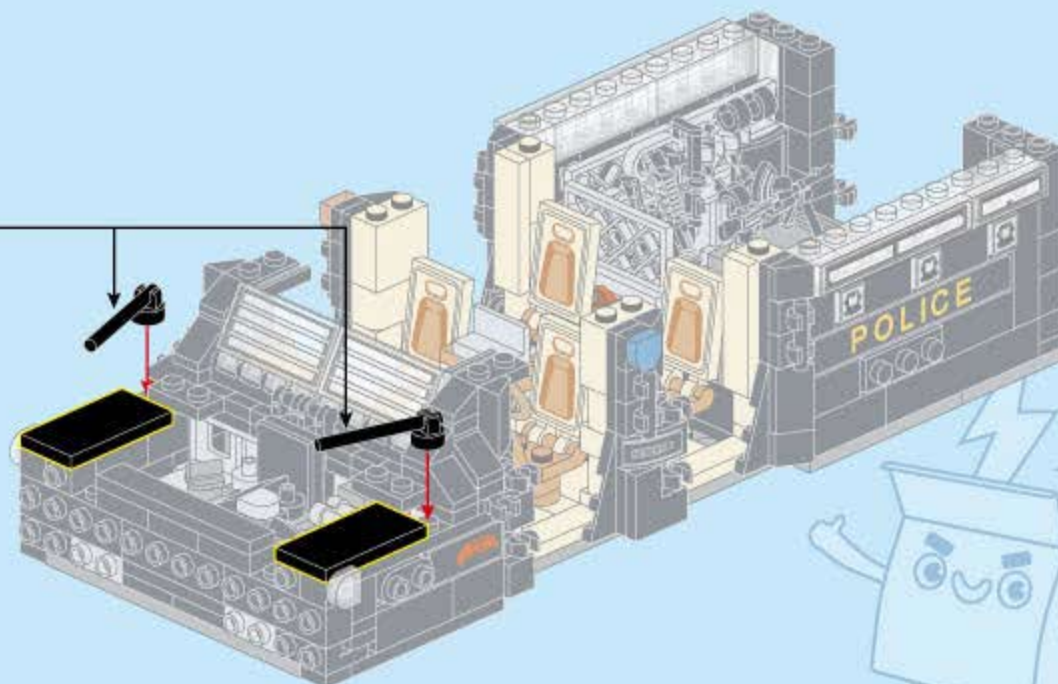

130

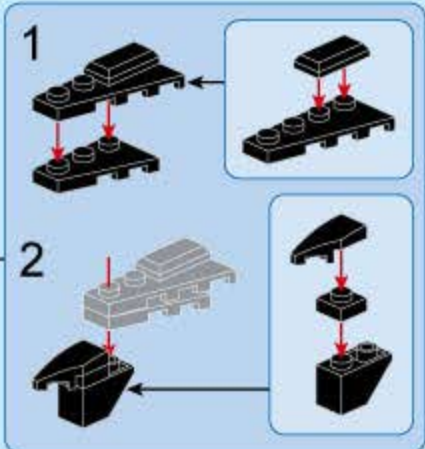
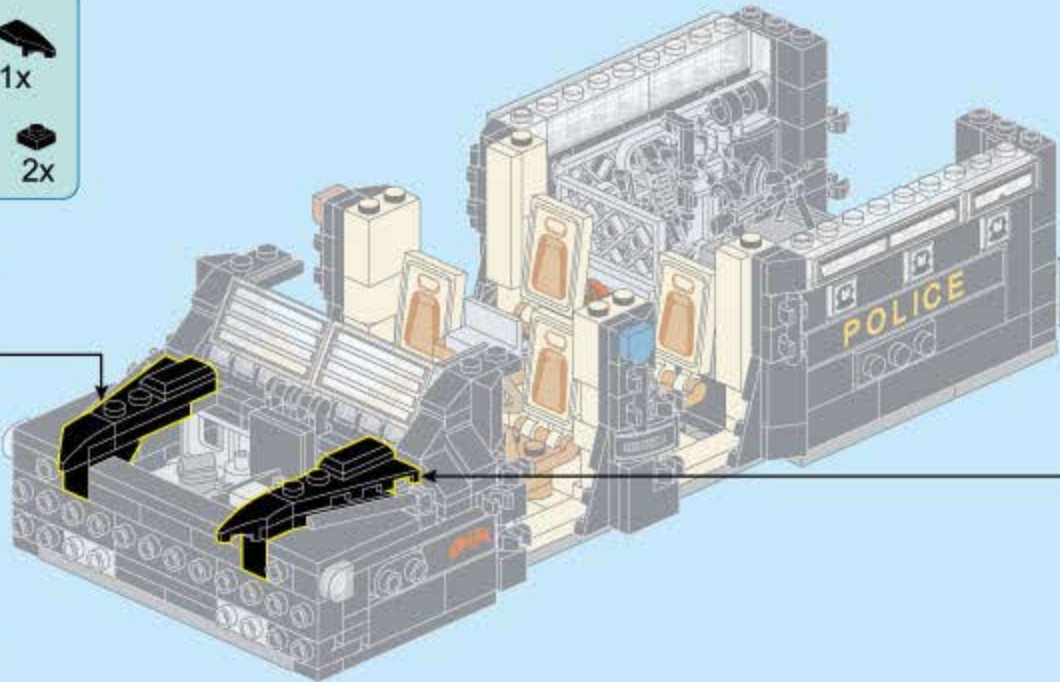
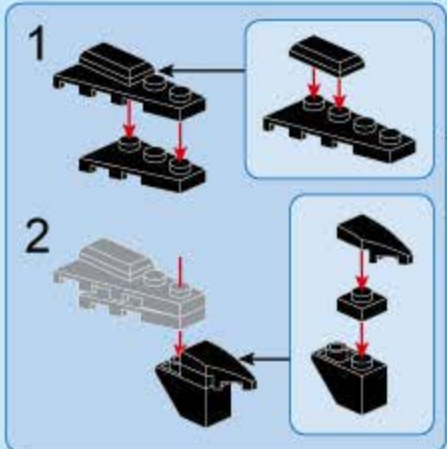
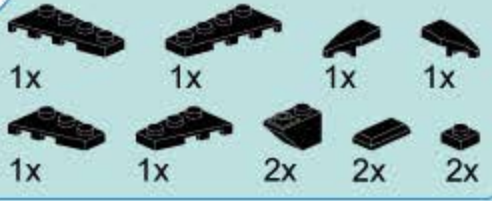

131

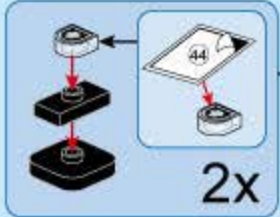

2x

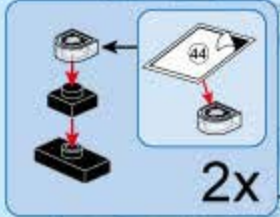

2x

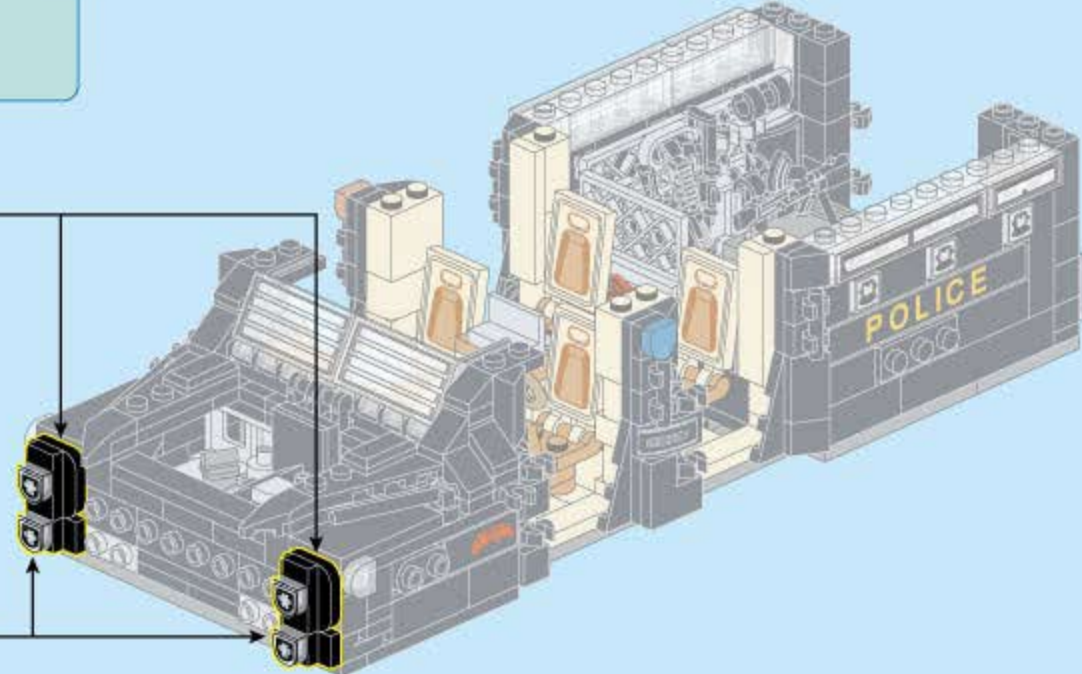



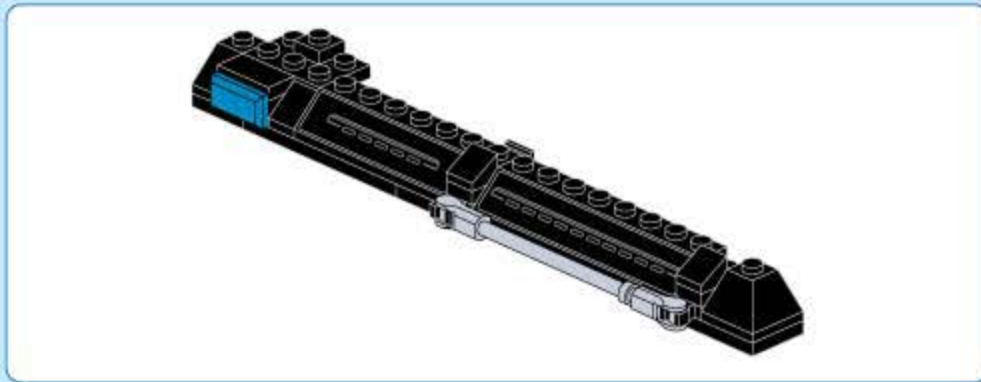

132



133

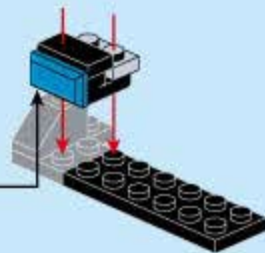
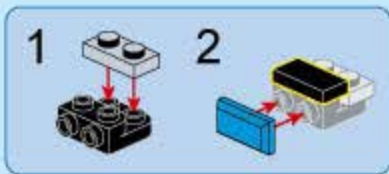

134

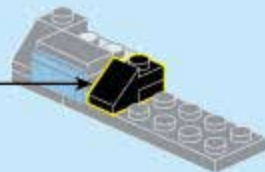

135

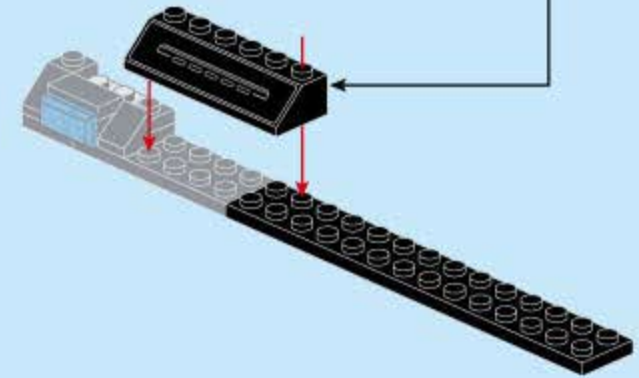
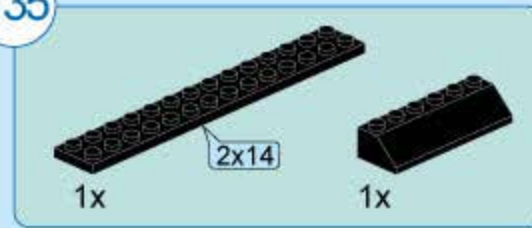

136

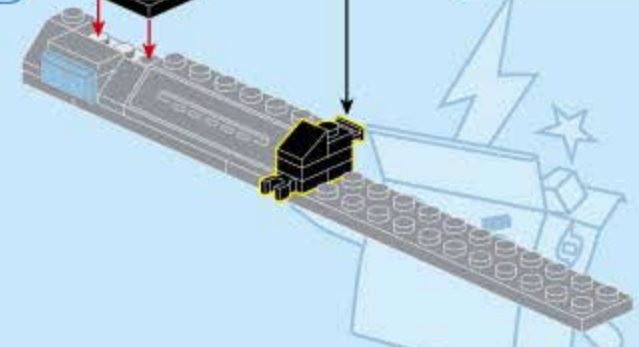
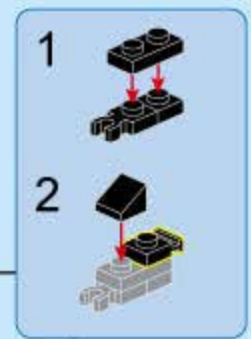
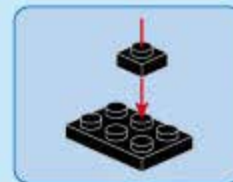

137

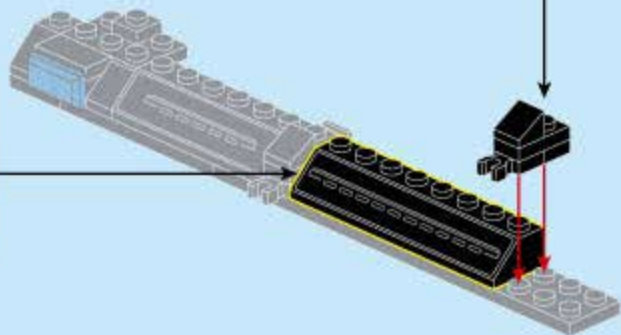
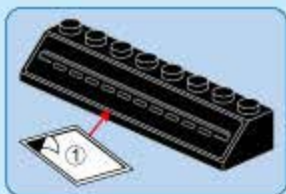
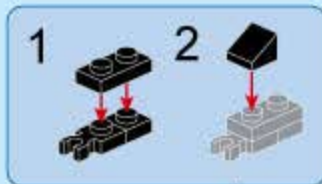
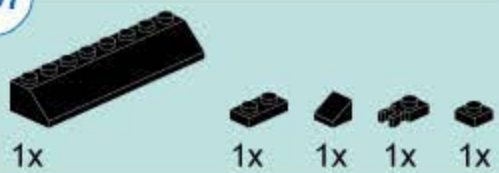

138

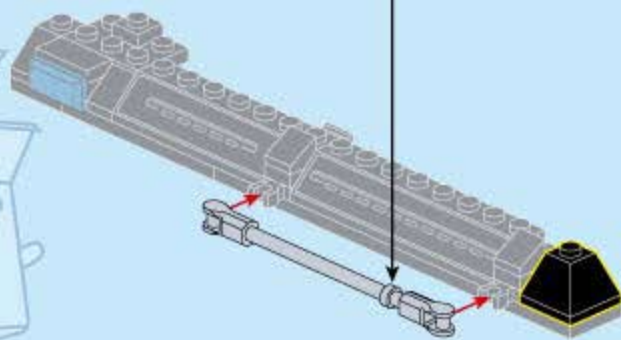
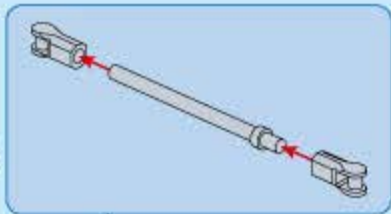

139

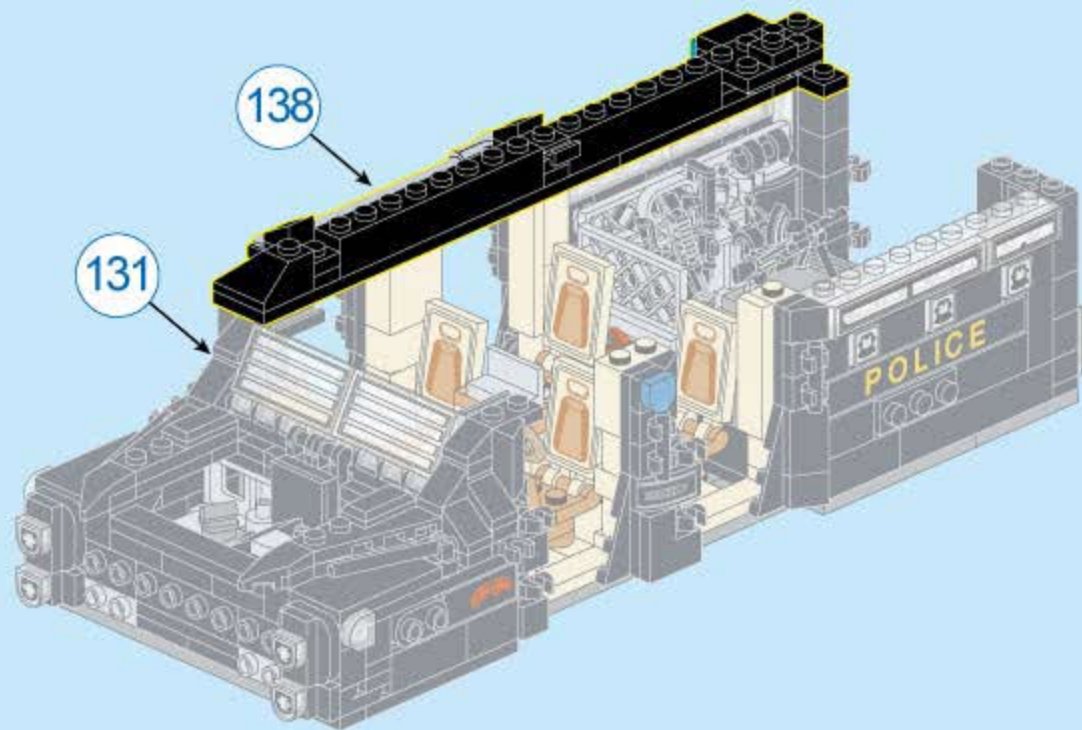



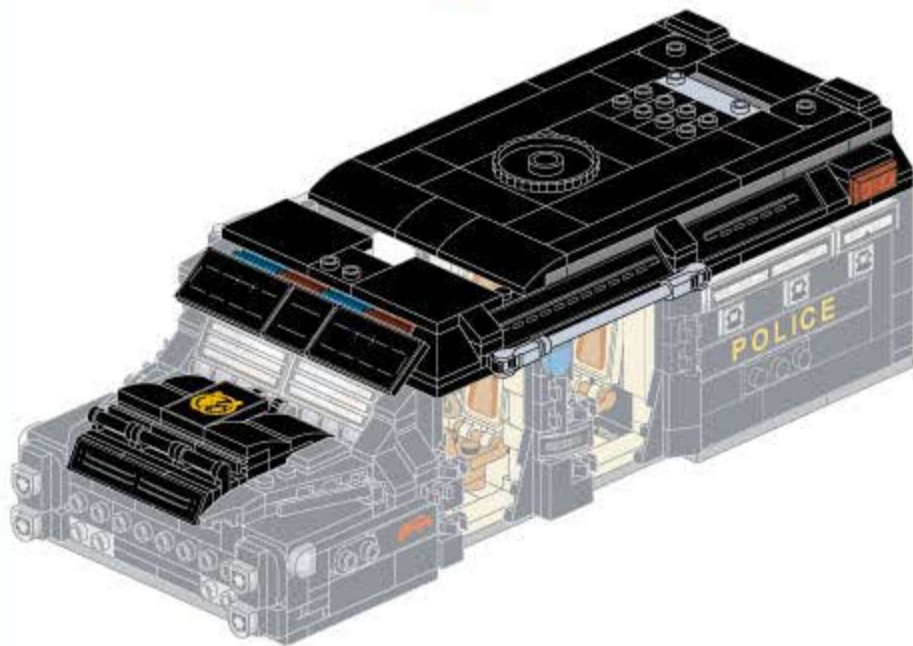

140

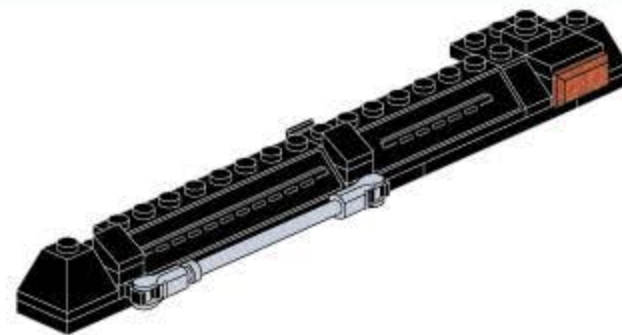

141

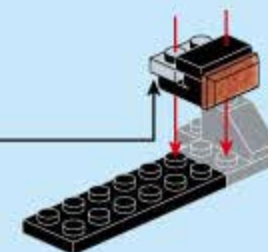
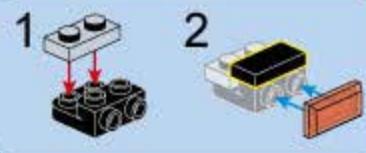

142

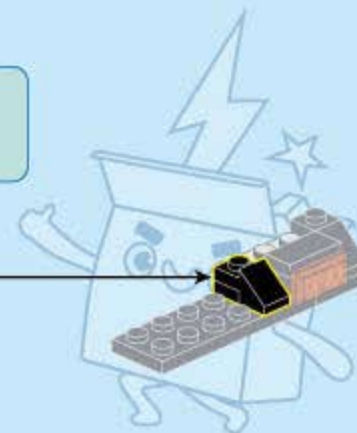

143

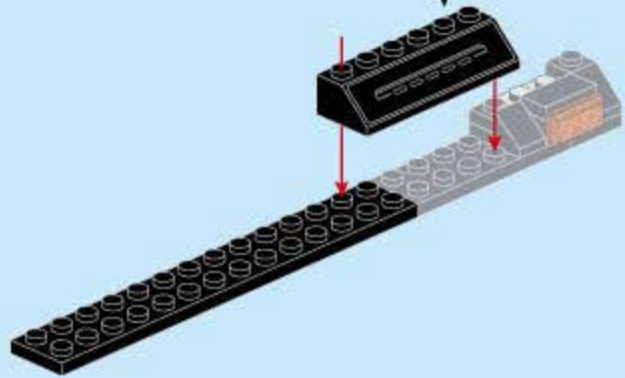
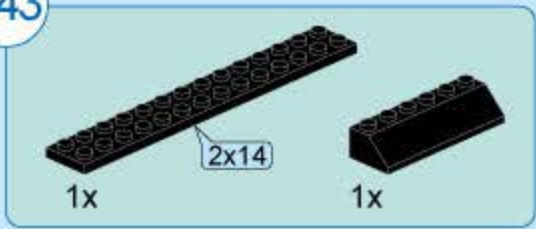

145

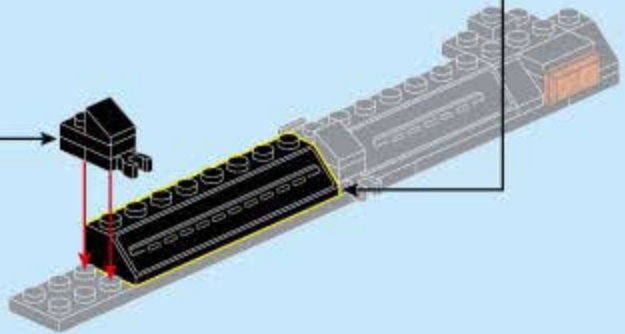
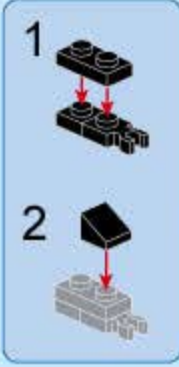
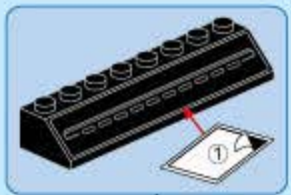
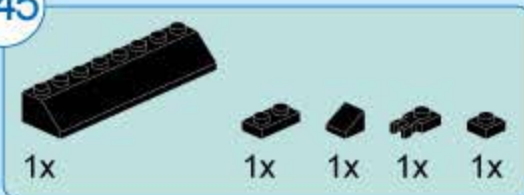

144

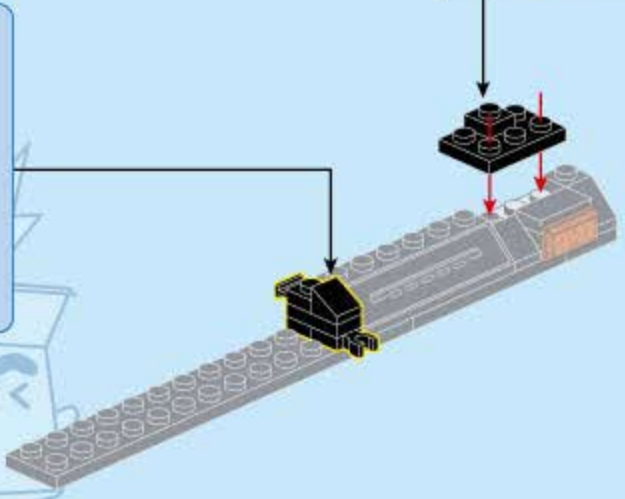
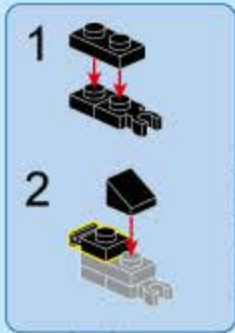
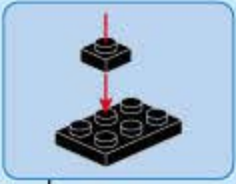

146

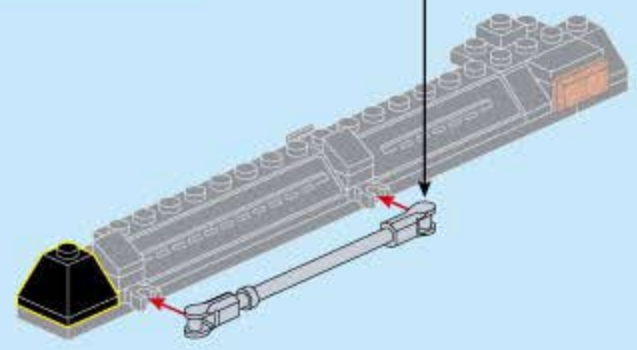
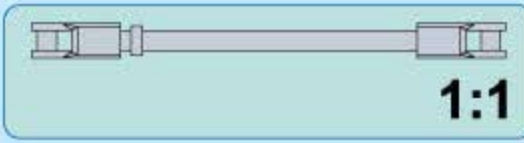
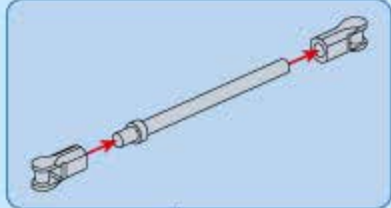



147

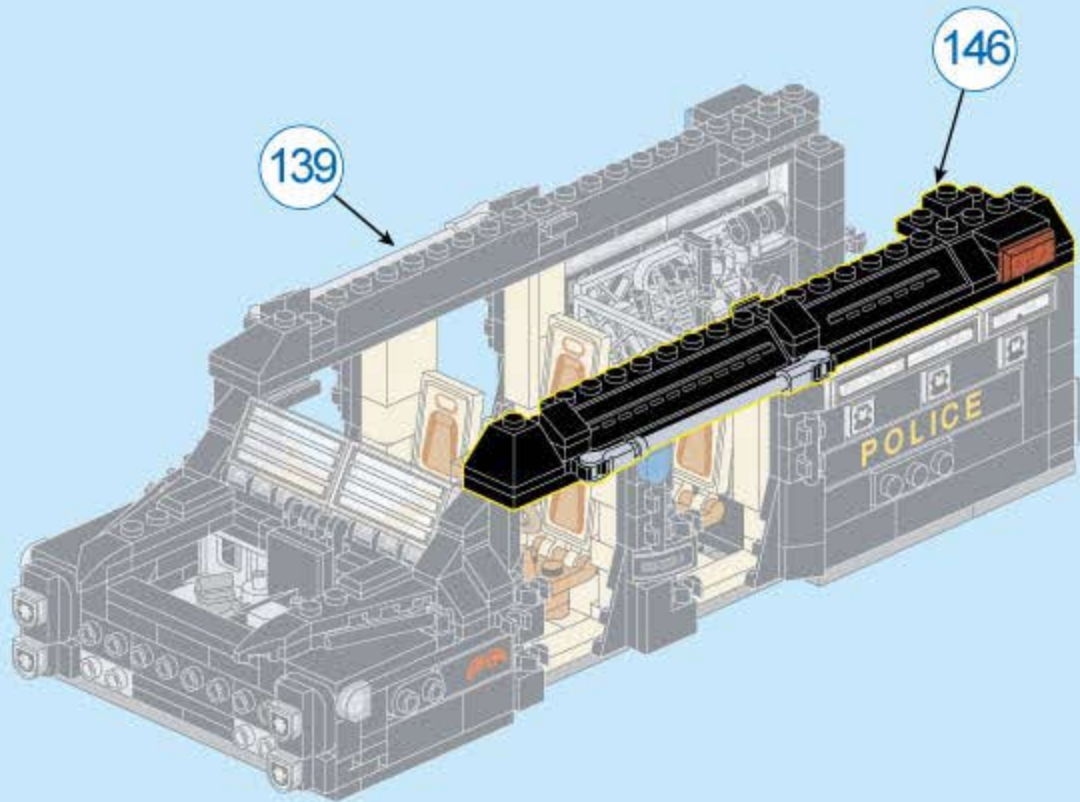

148

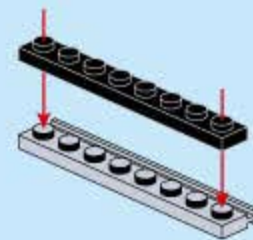

149

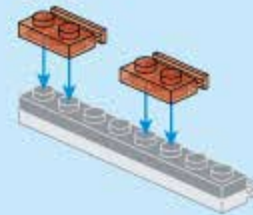

150

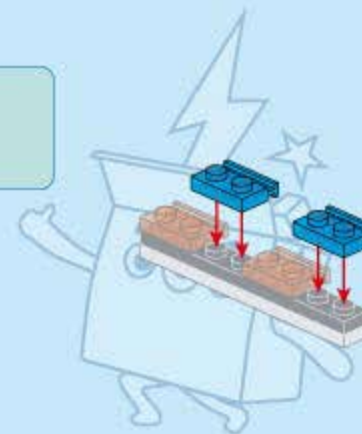

151

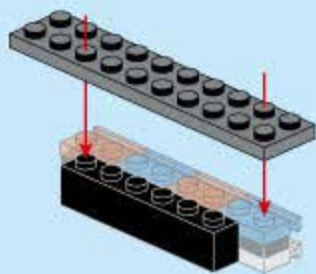
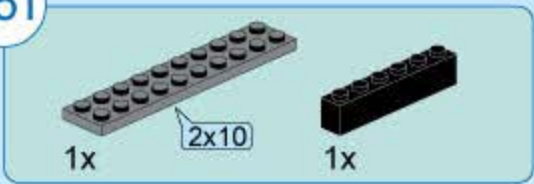

152

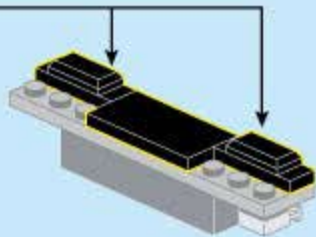
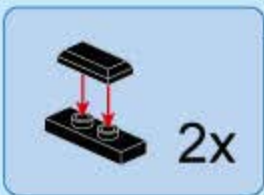

153

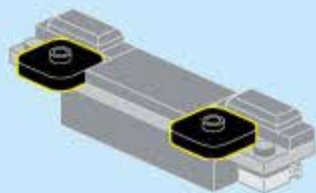

154

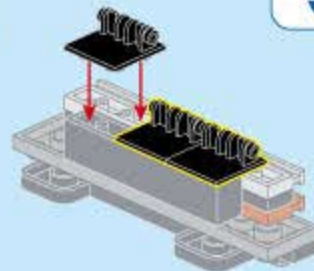

155

154

147

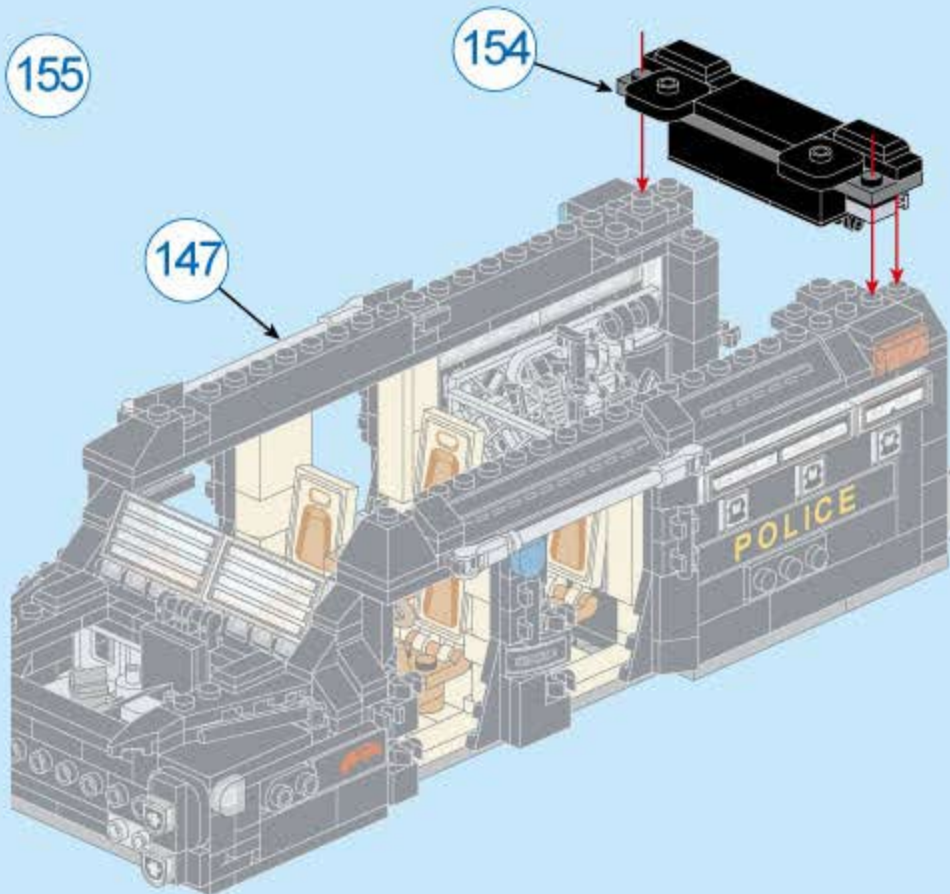



156

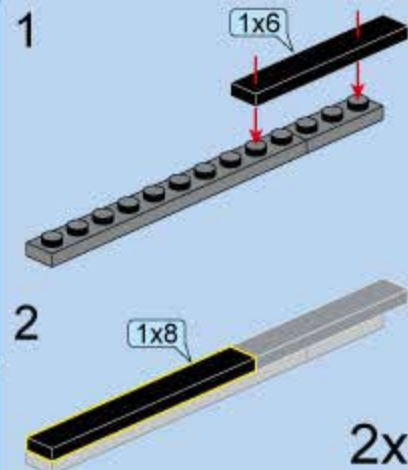
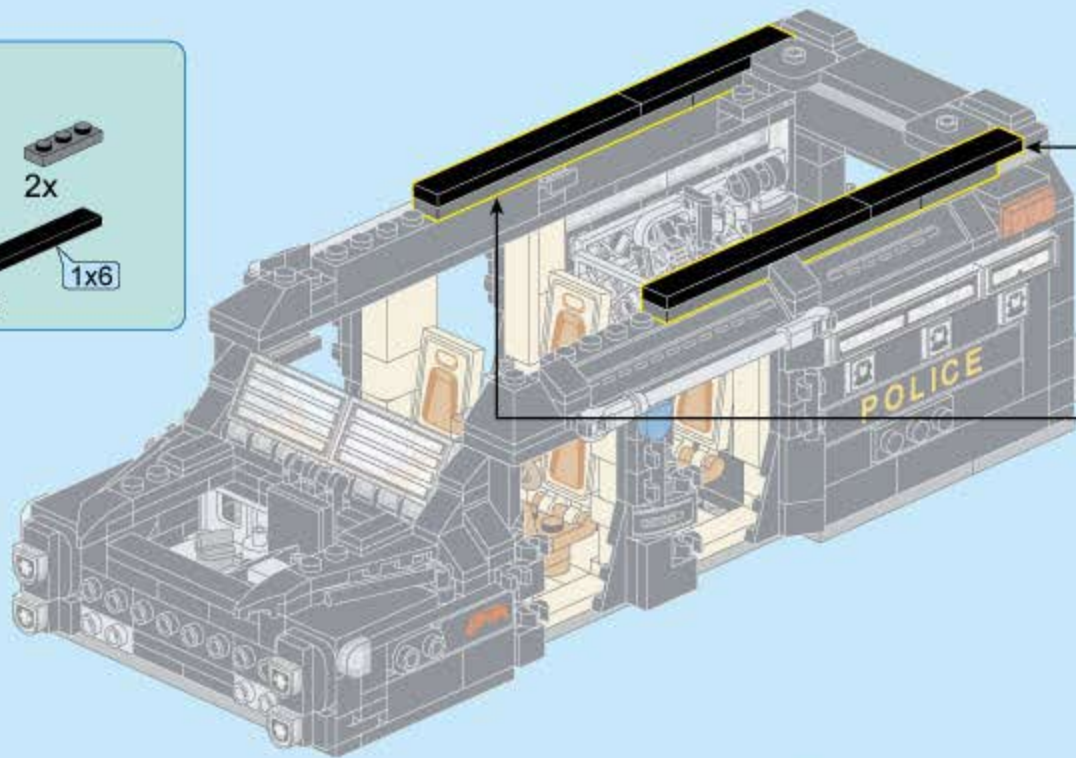
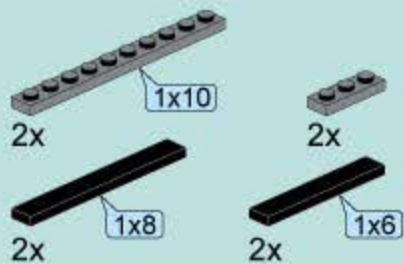

157

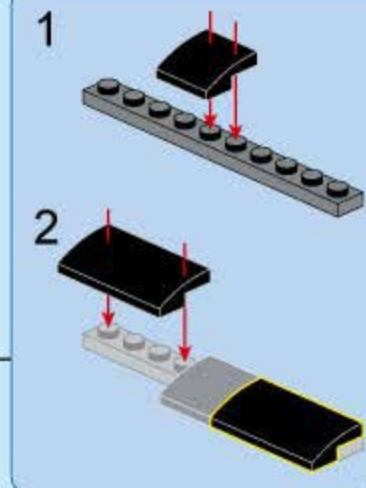
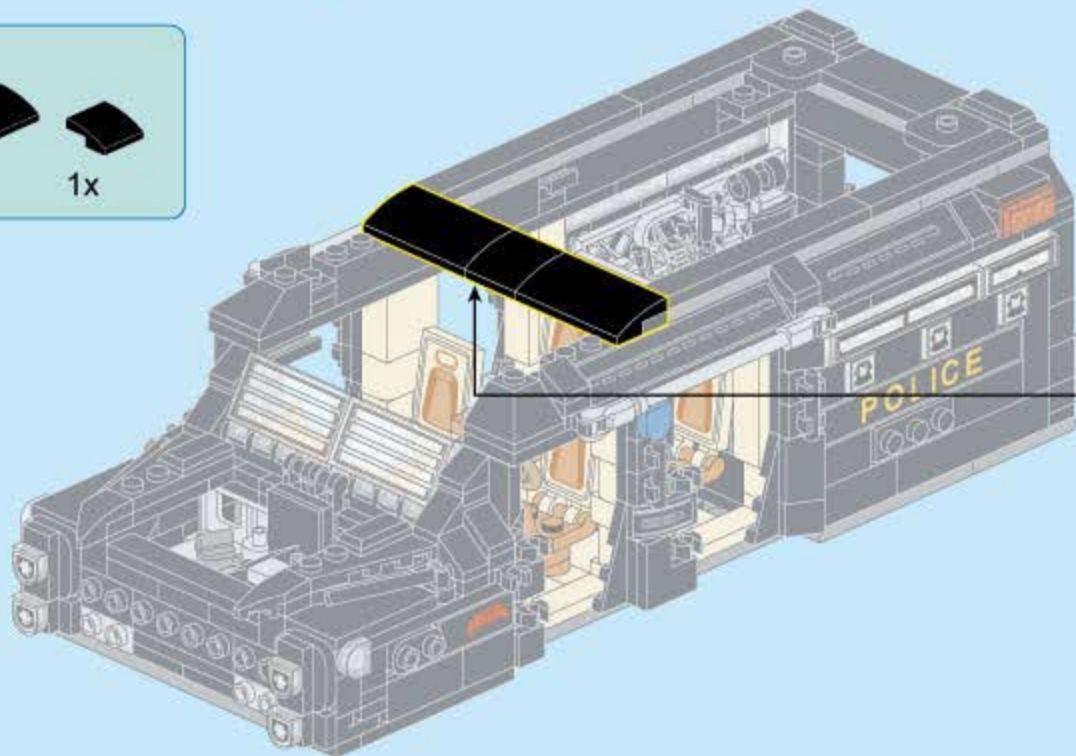
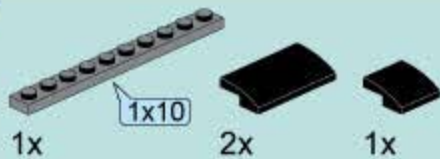

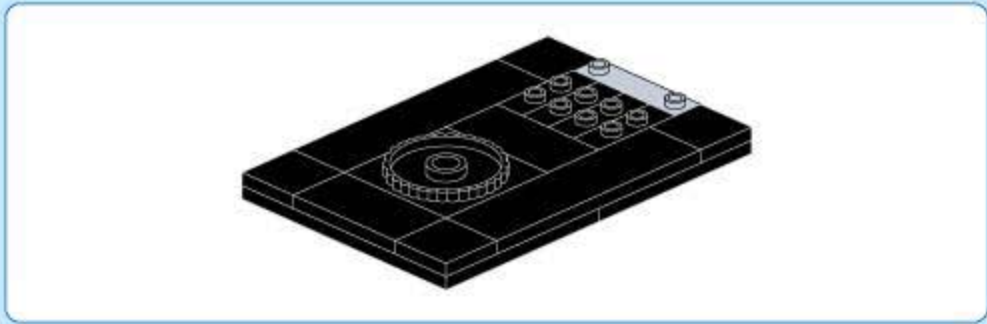

158

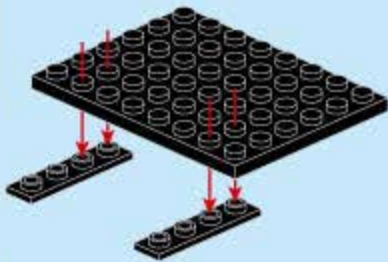
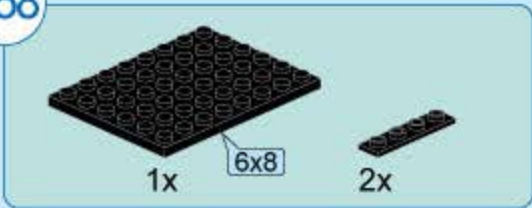

159

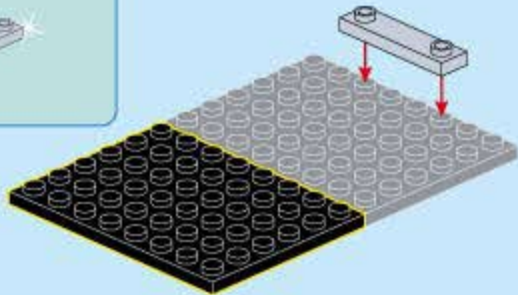
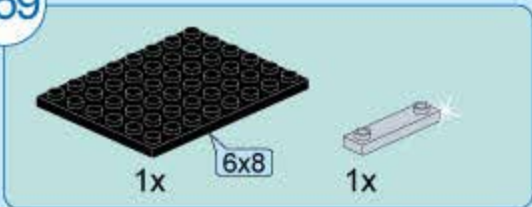

160

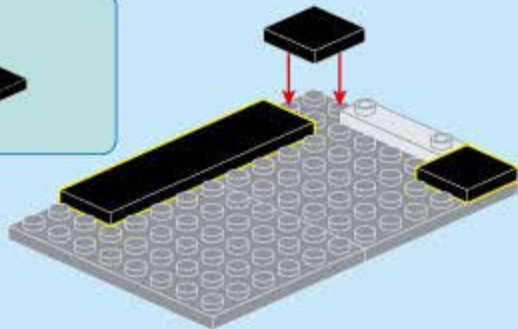

161

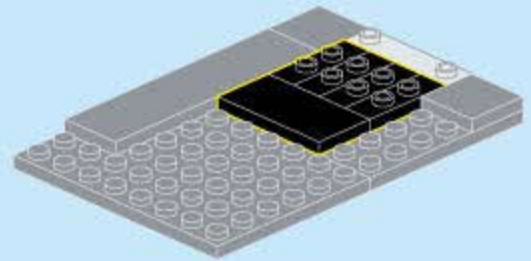

162

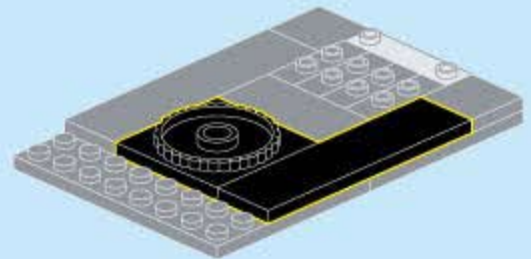
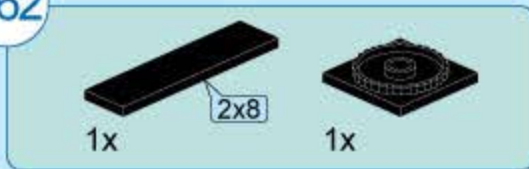

163

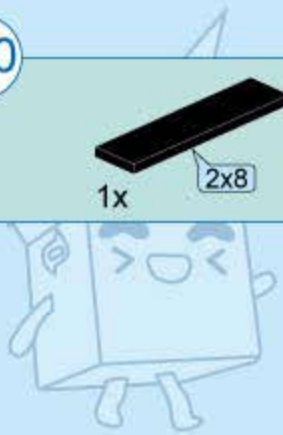
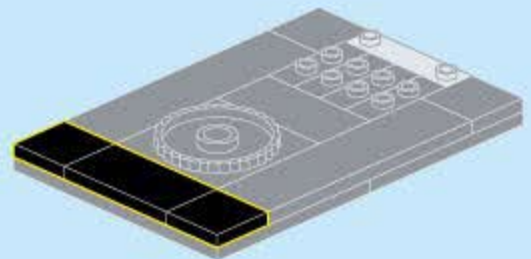



164

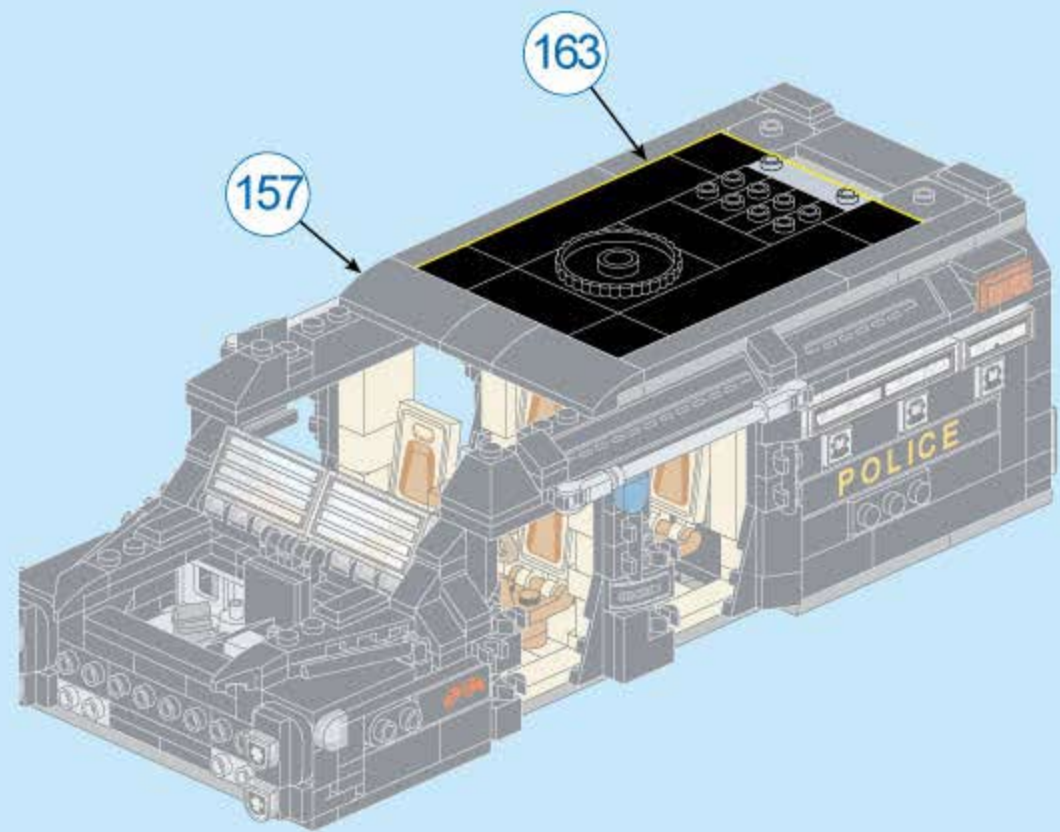
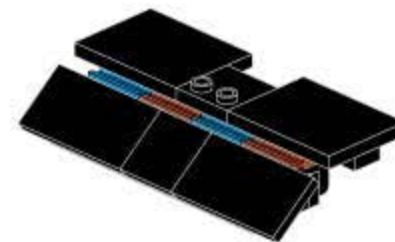

165



166

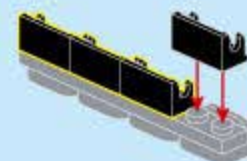

167

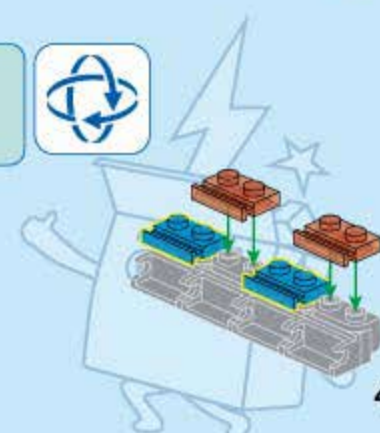

168



169

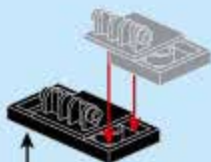

170

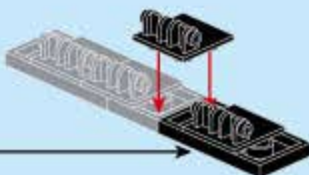

171



170

167

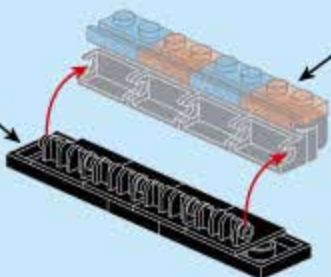

172

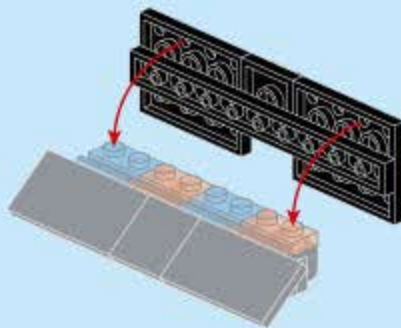
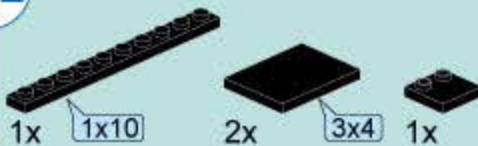

1

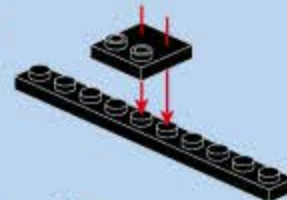

2

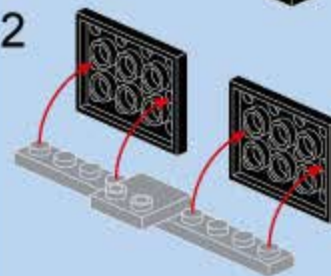

173

164

172

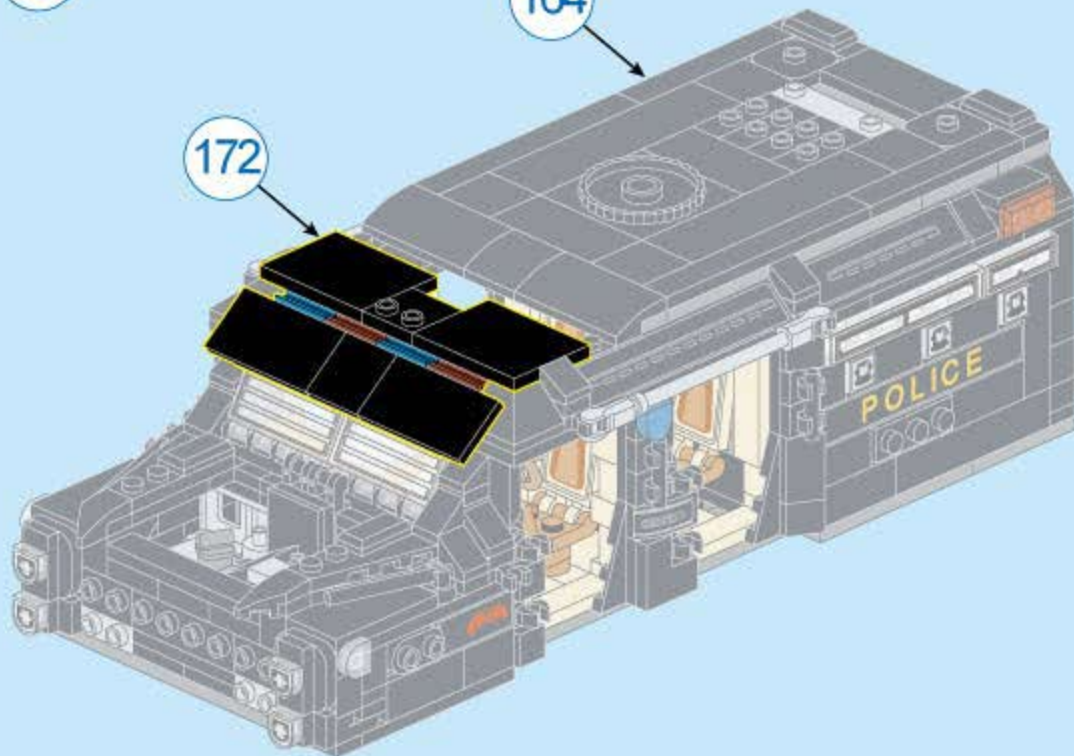





174

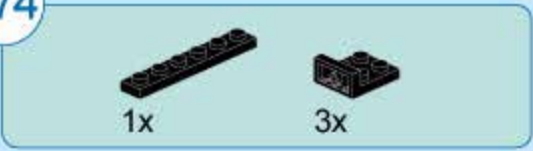

175

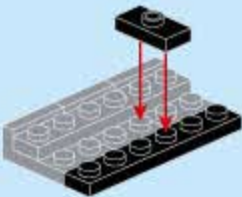

176

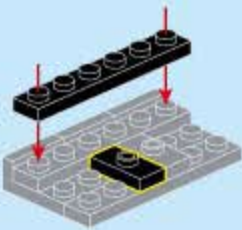

177

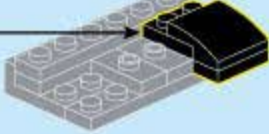
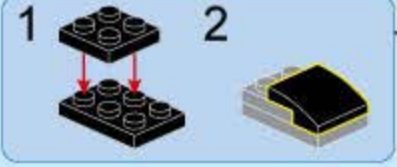

178

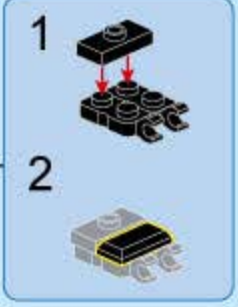
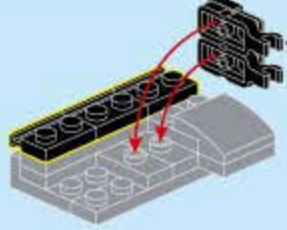

179

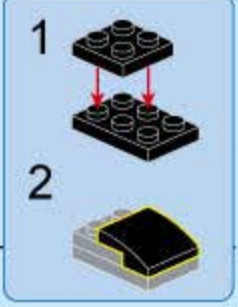
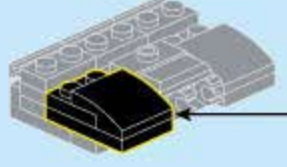

180

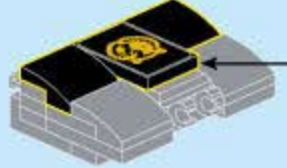

181

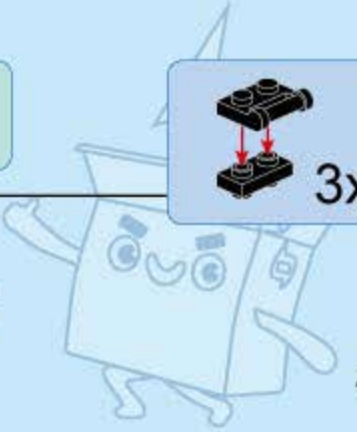
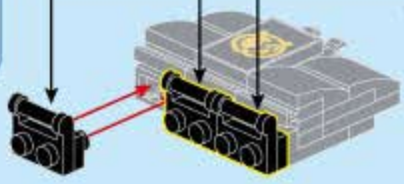

182

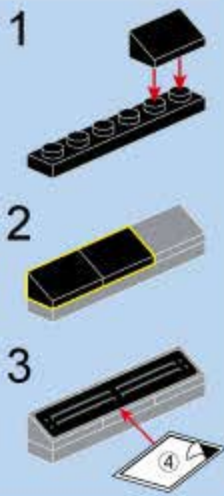
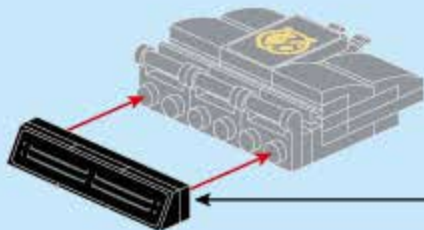

183

173

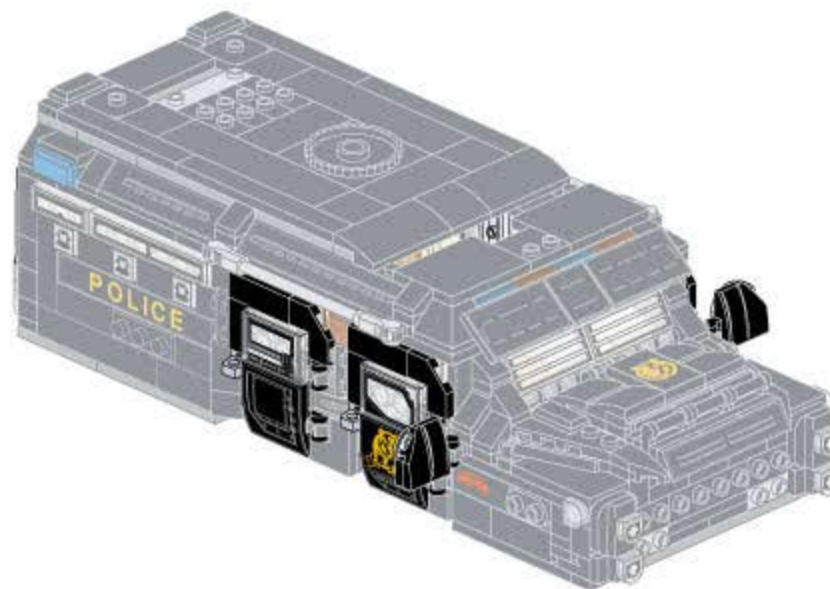
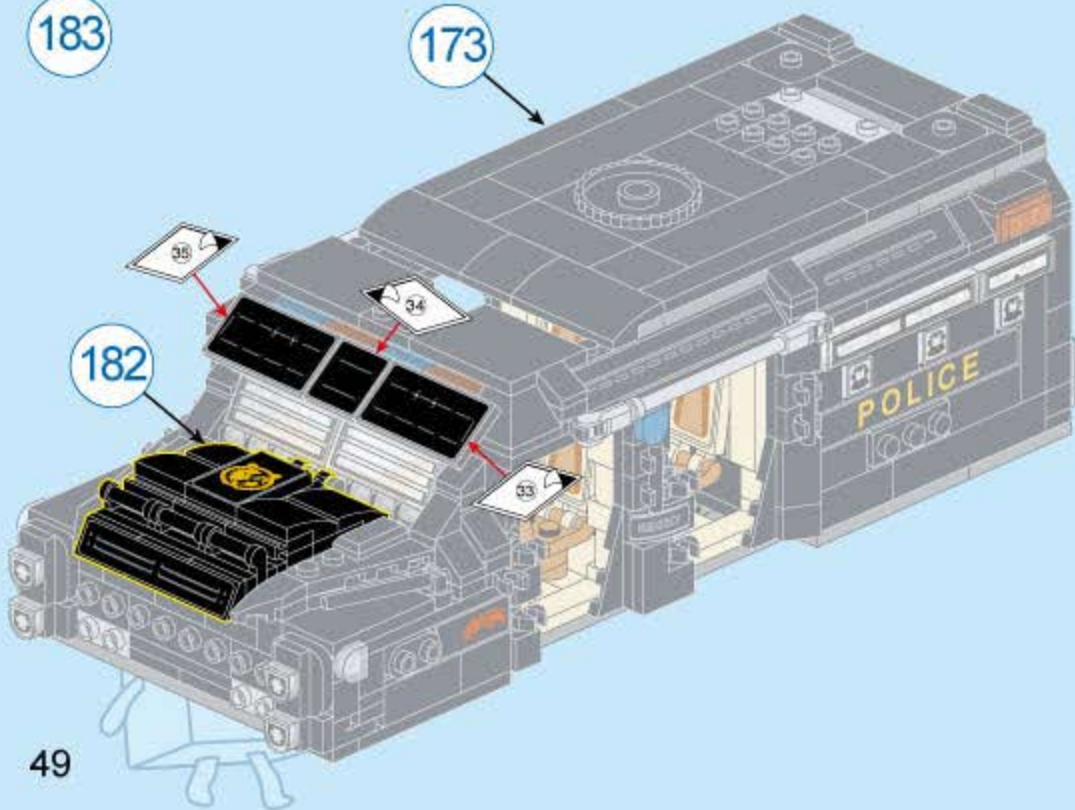



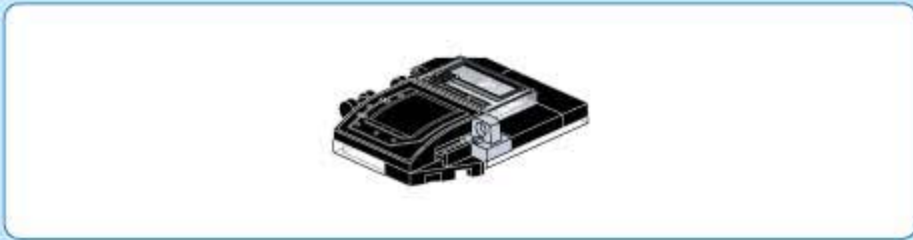

184

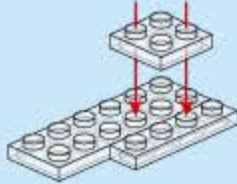
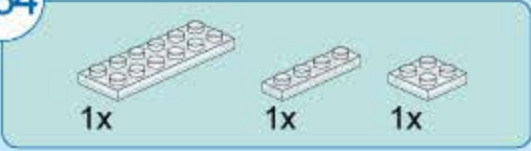

185



186



187

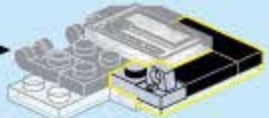
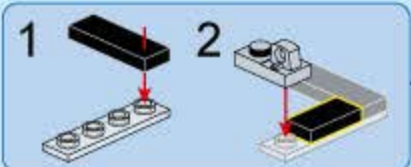
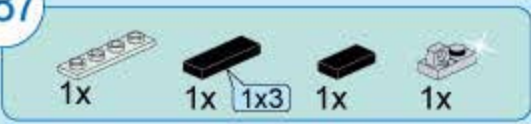

188

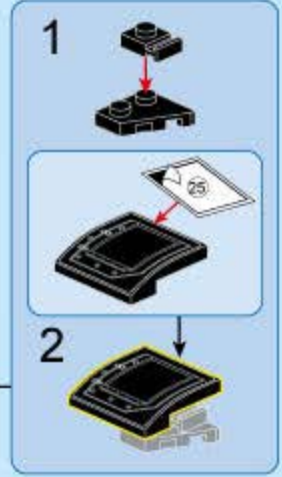
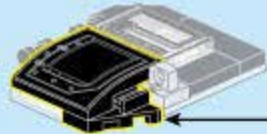

189

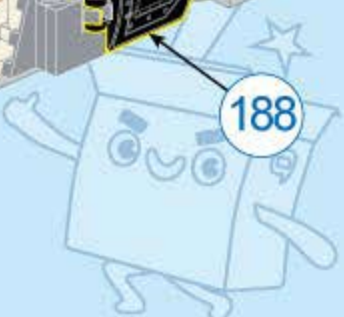
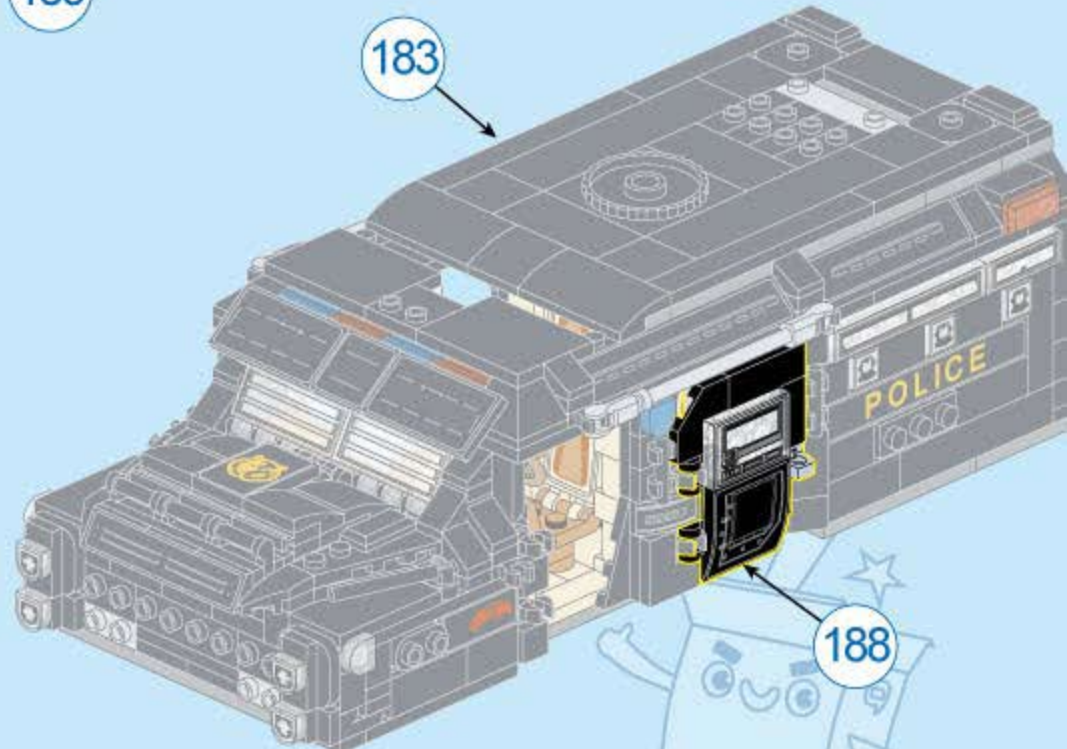



190

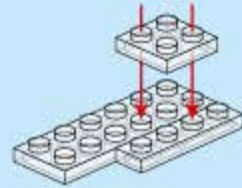
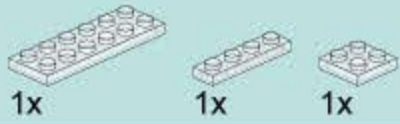

191

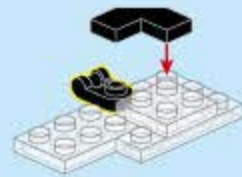

192



193

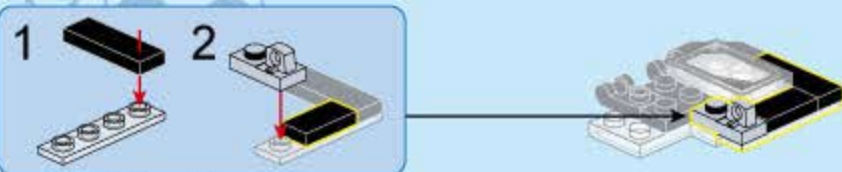

51

194

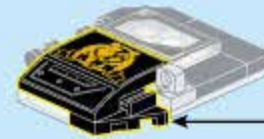
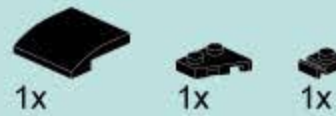

1



2



195

189

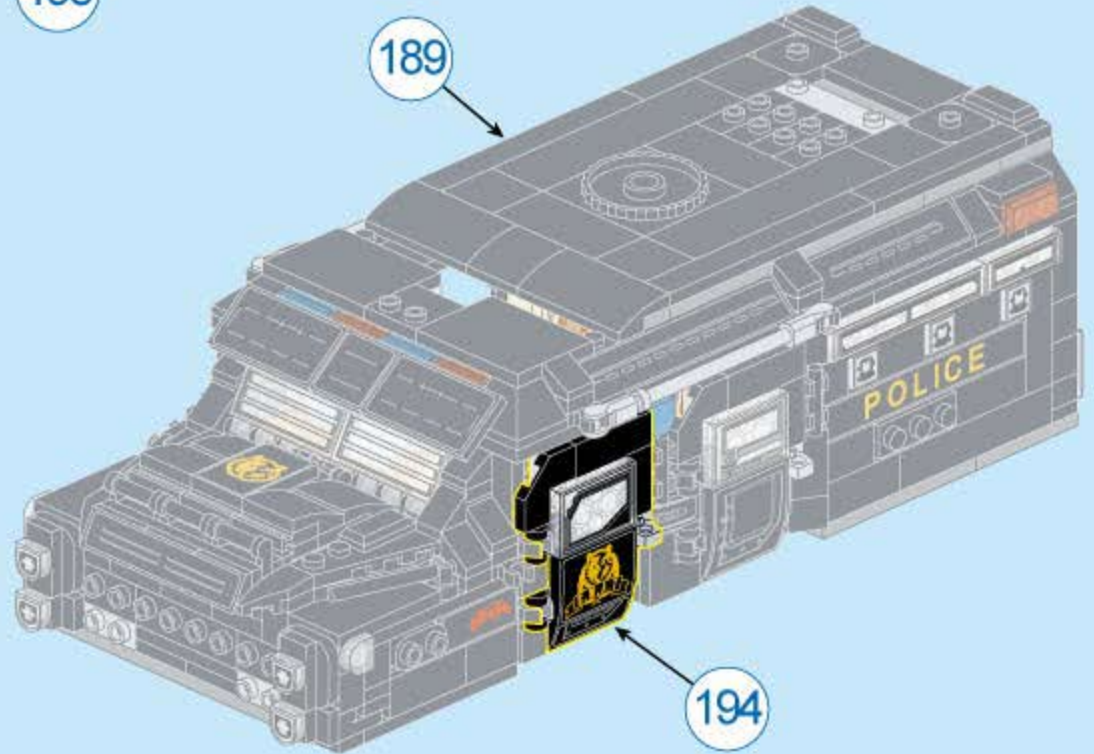

194





196

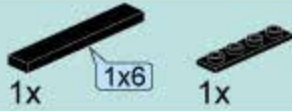

197



198

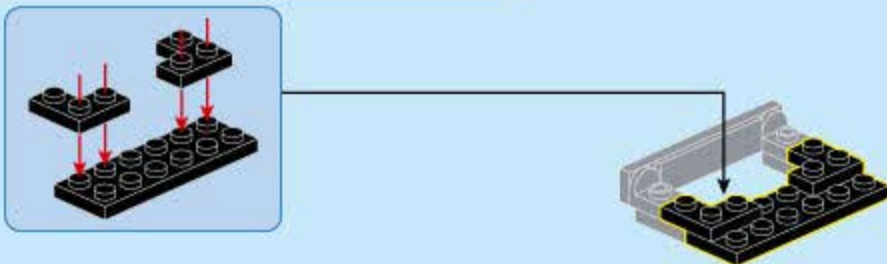

199

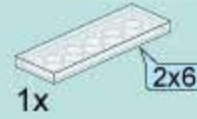

200

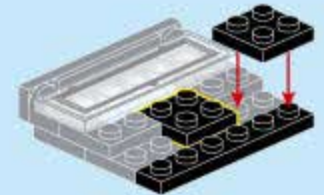

201

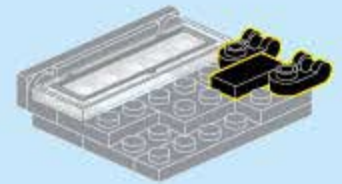

202



203

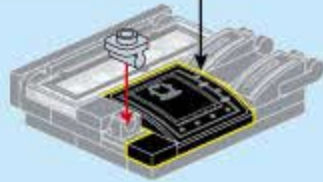

204

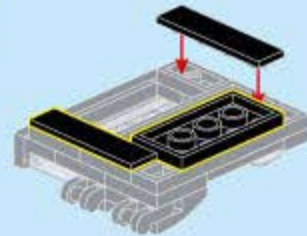

205

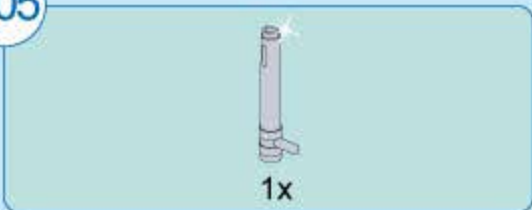



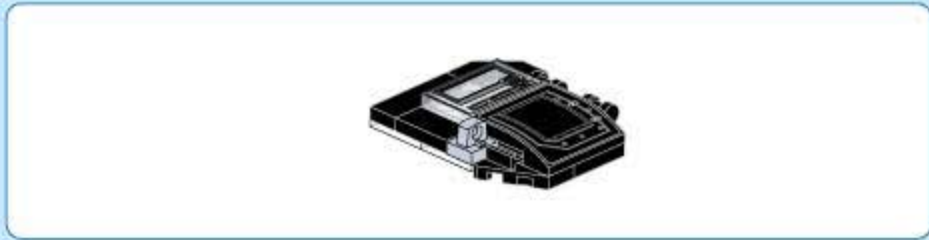

206

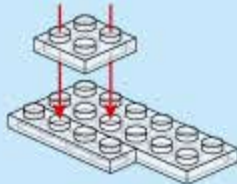
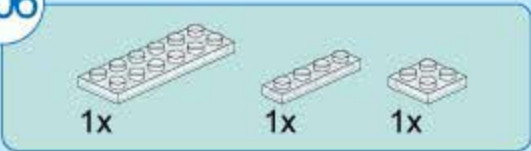

207



208



209

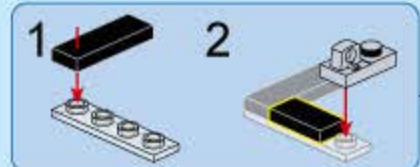
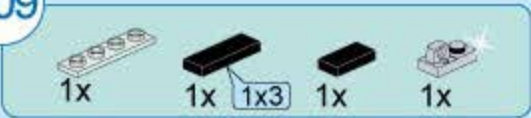

210

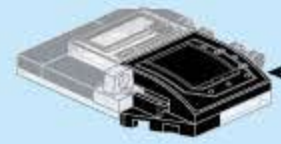
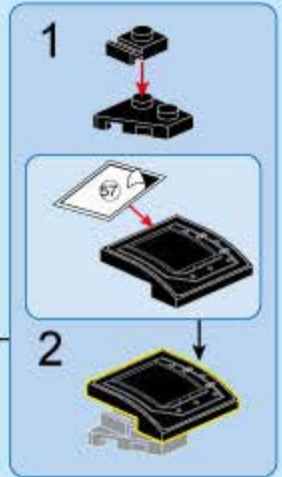

211

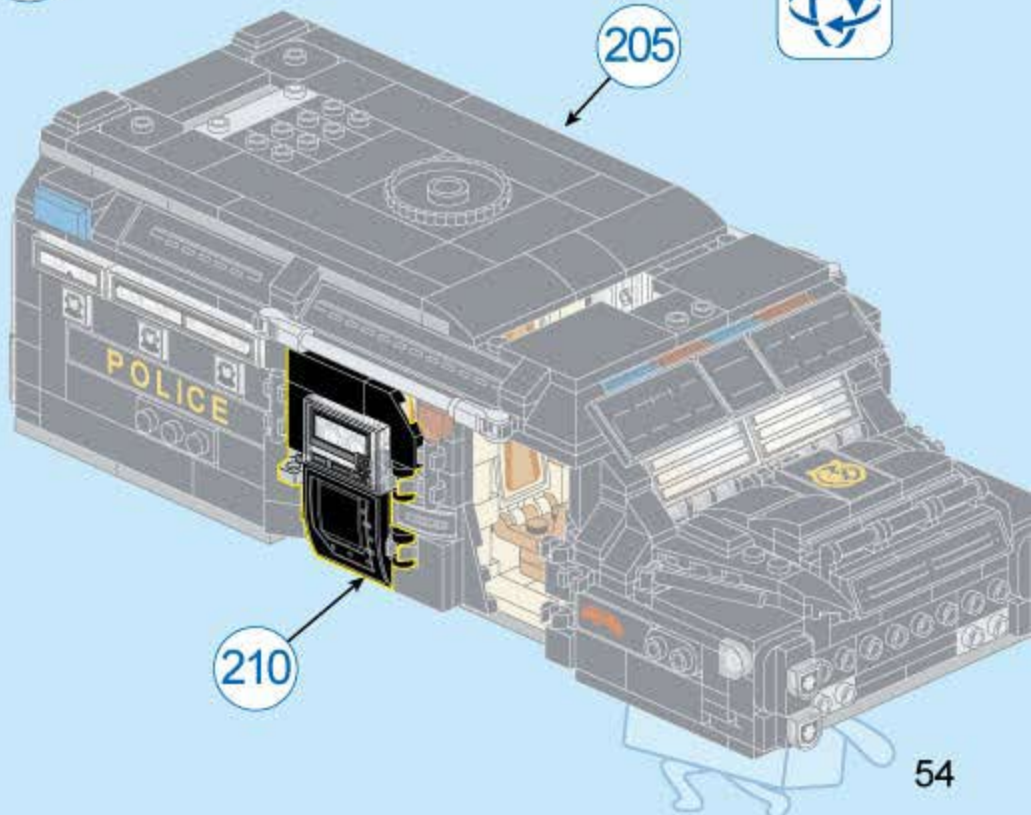



212

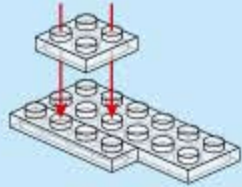
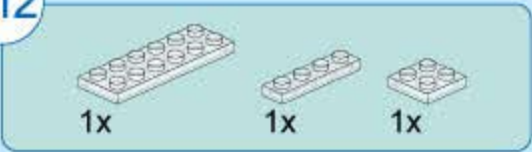

213



214

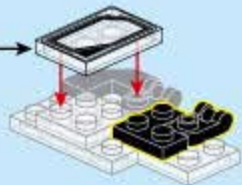

215

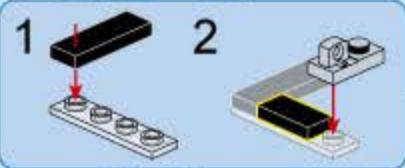
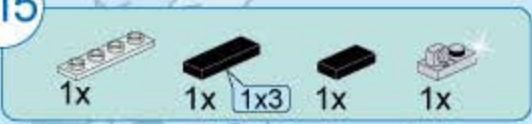

55

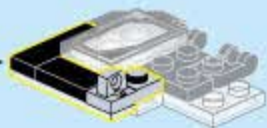

216

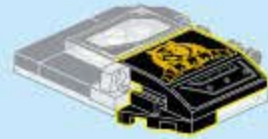
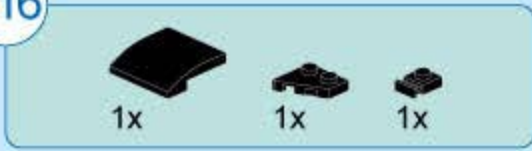

1



2



217

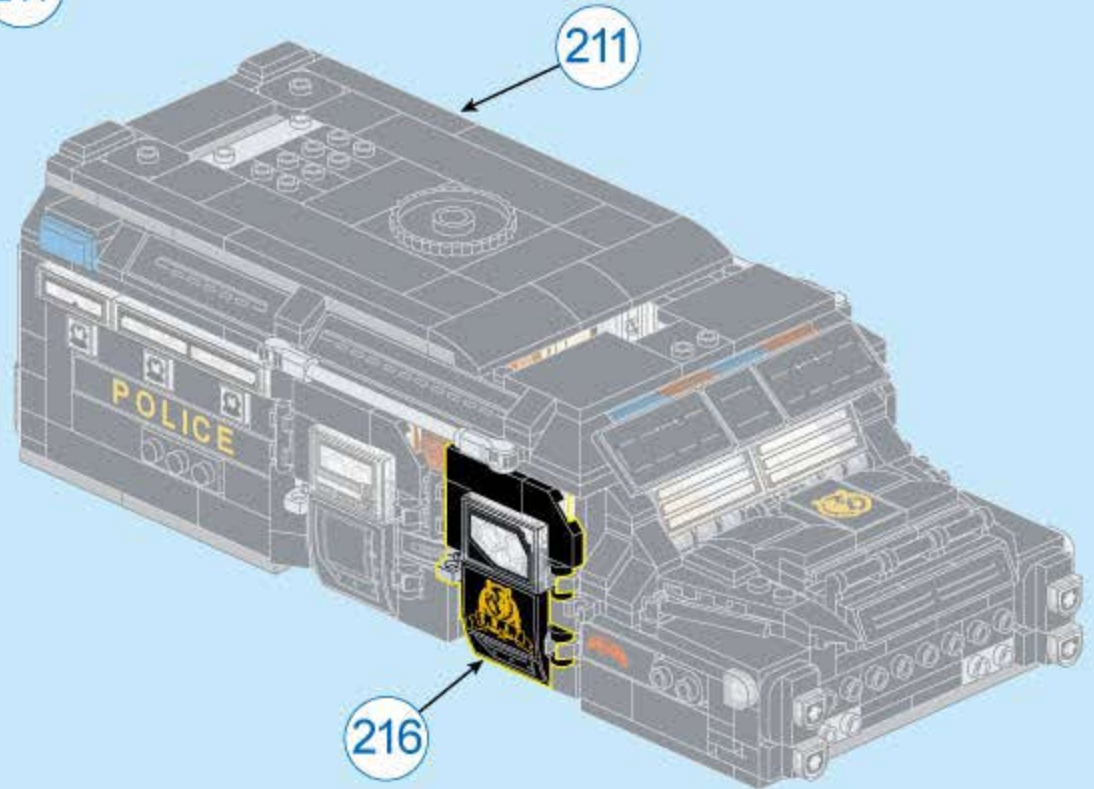



218

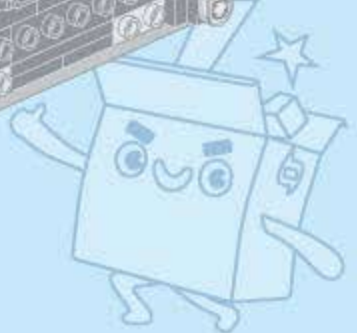
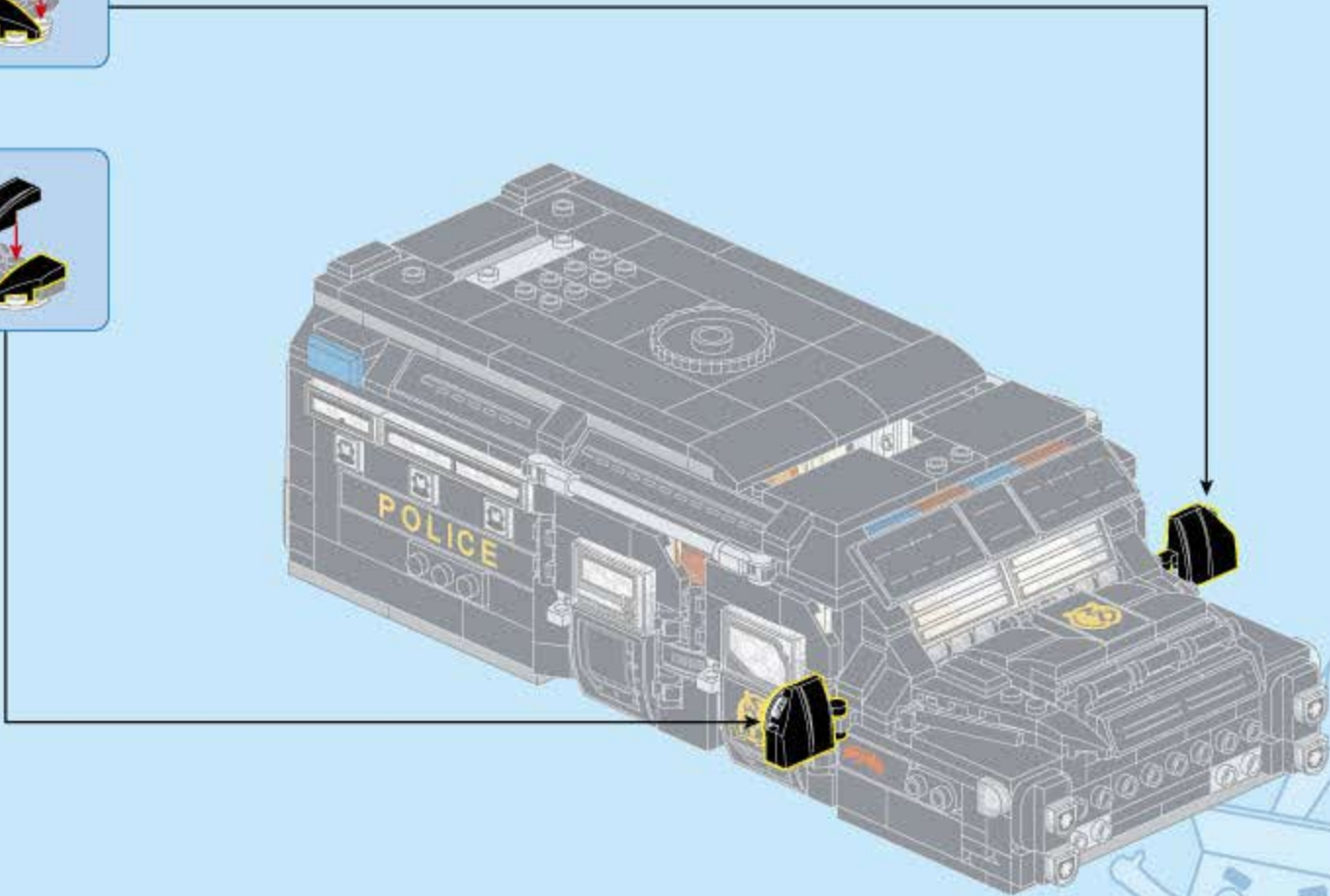
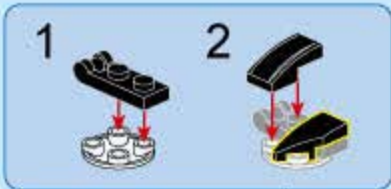
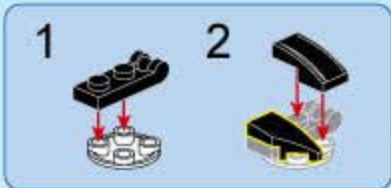

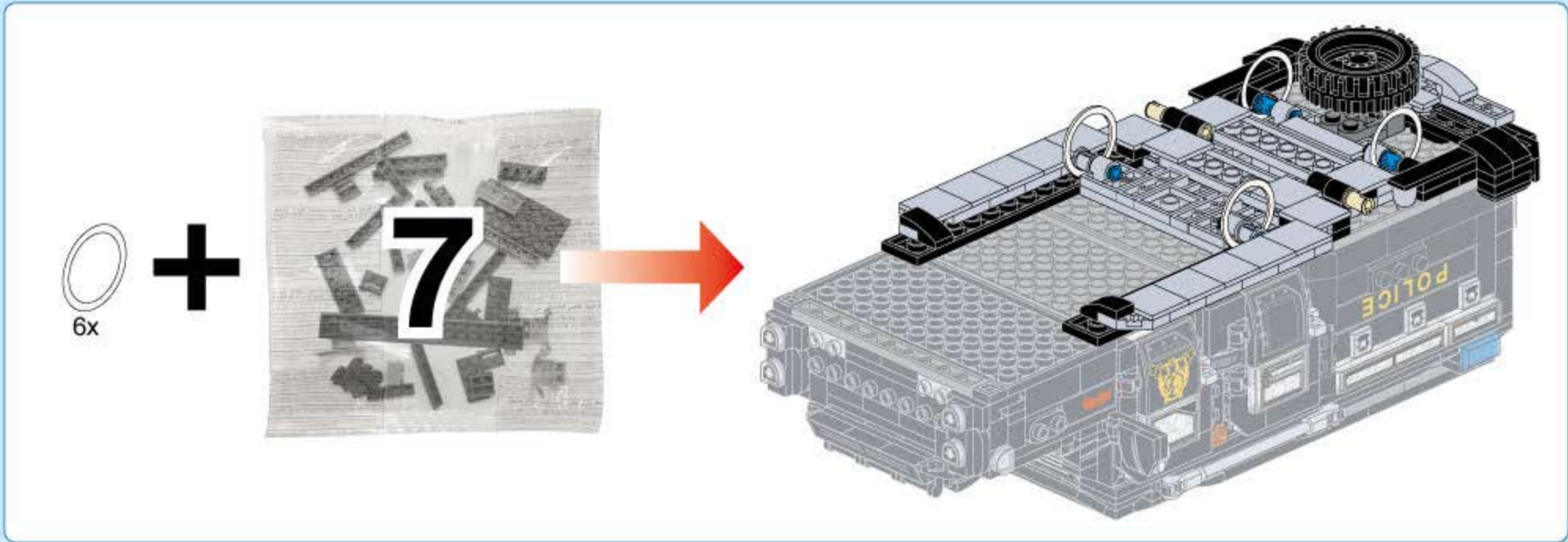

219

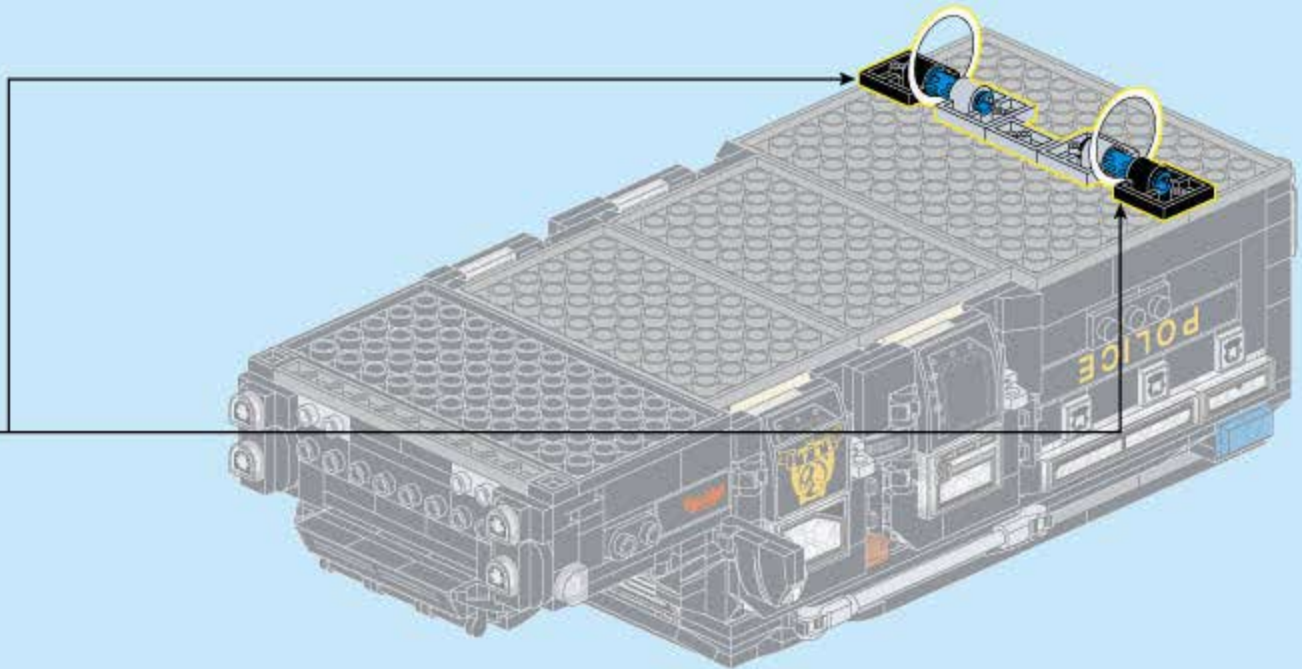
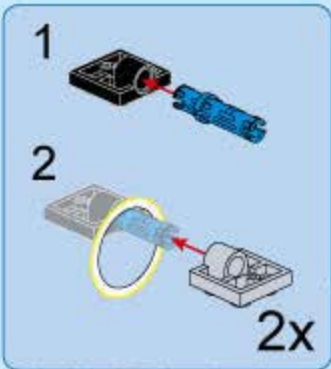



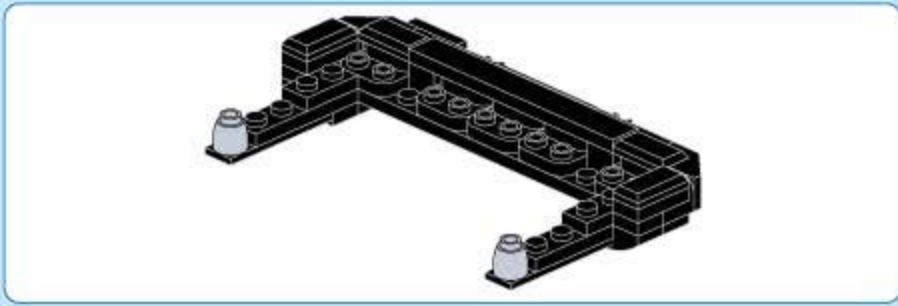

**1:1**

220

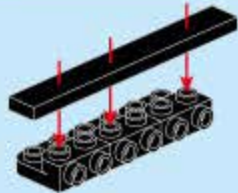
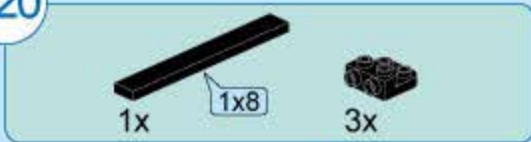

221

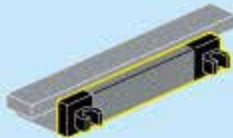

222

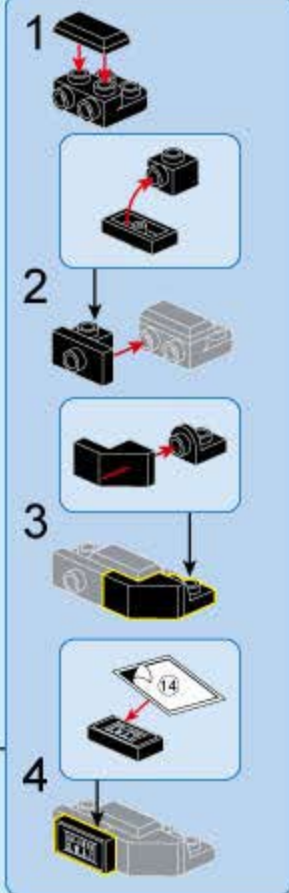
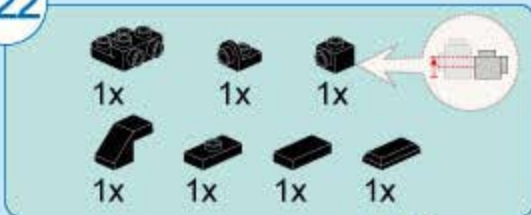

223

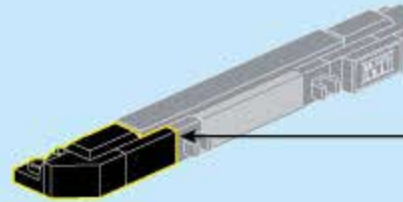

224



225

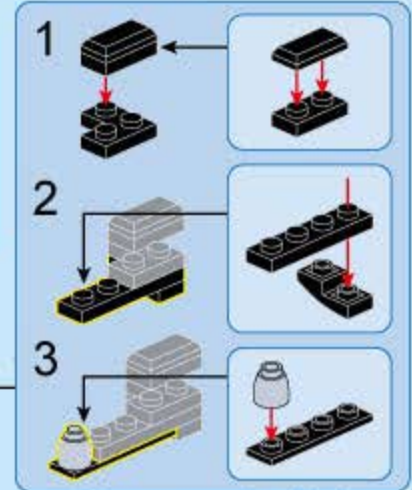
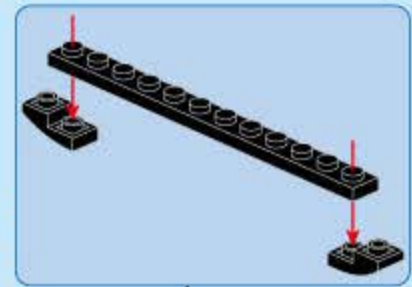
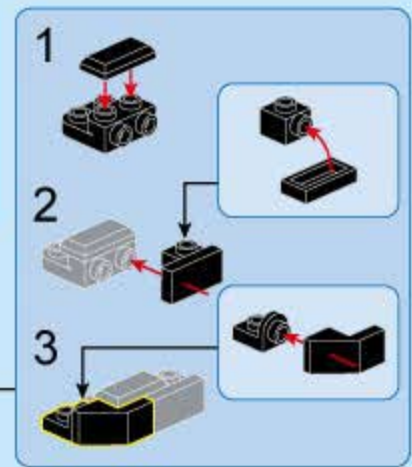
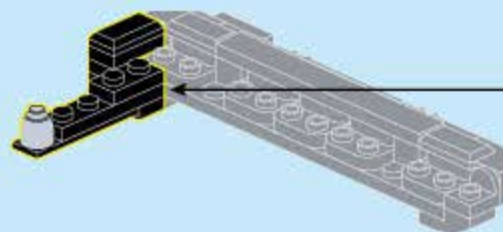
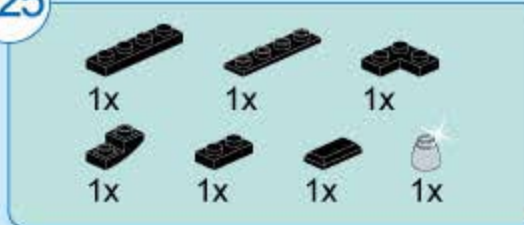

226

- 1x [1x 1x black Technic brick]
- 1x [1x 2x black Technic brick]
- 1x [1x 3x black Technic brick]
- 1x [1x 1x black Technic brick]
- 1x [1x 2x black Technic brick]
- 1x [1x 3x black Technic brick]
- 1x [1x black Technic pin]

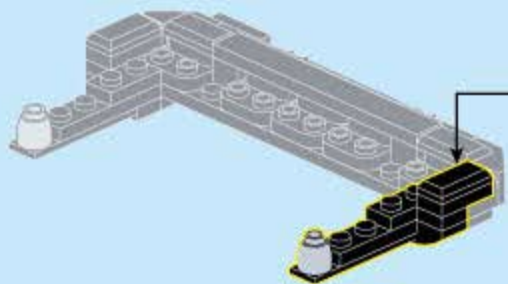

1

2

3

227

219

226

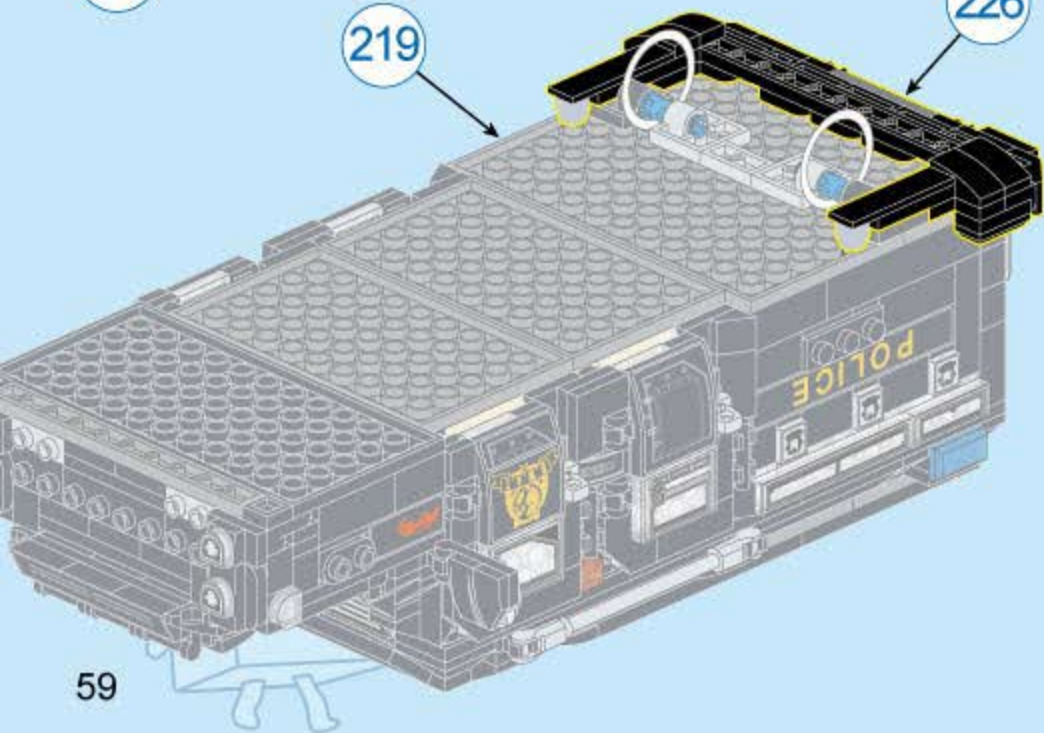

228

- 2x [2x 1x grey Technic brick]
- 2x [2x 1x grey Technic brick]
- 2x [2x 1x grey Technic brick]
- 1x [1x 2x grey Technic brick]



1

2

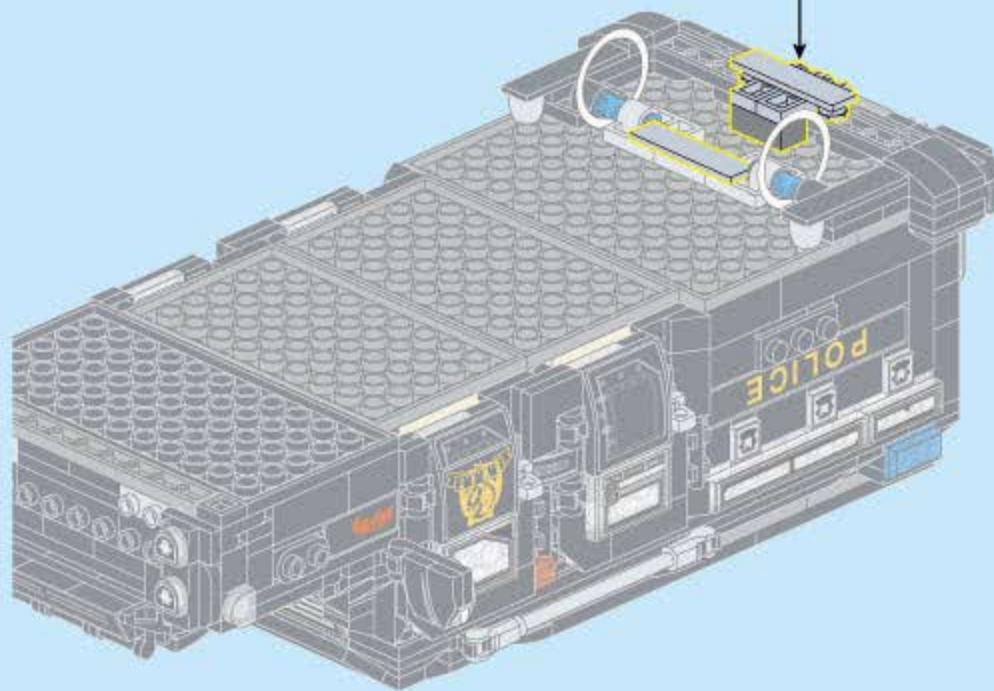



229

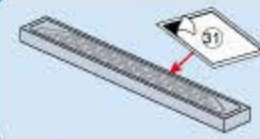
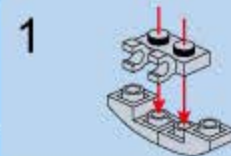
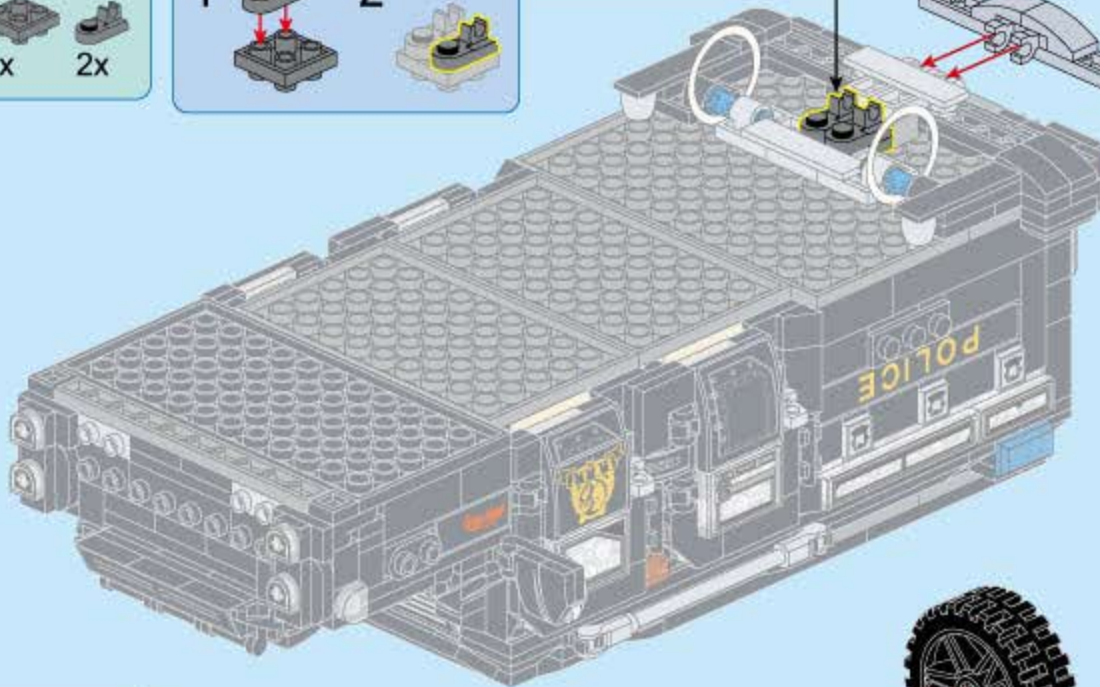
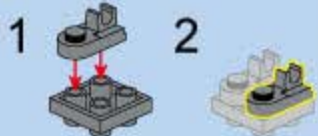
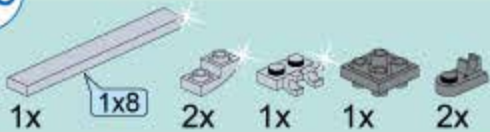

230

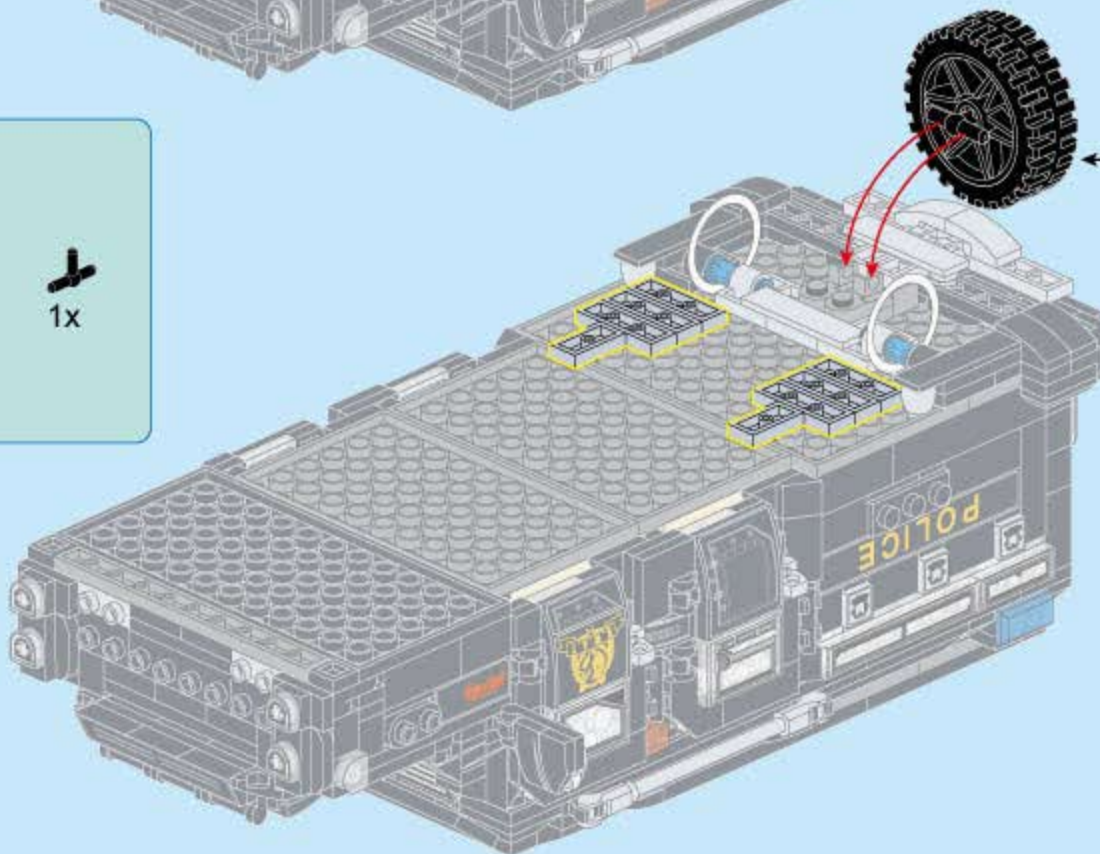

231

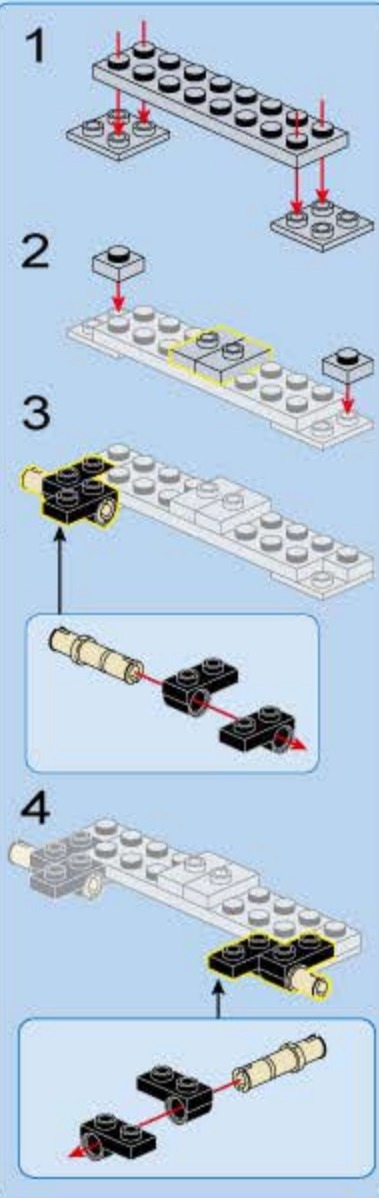
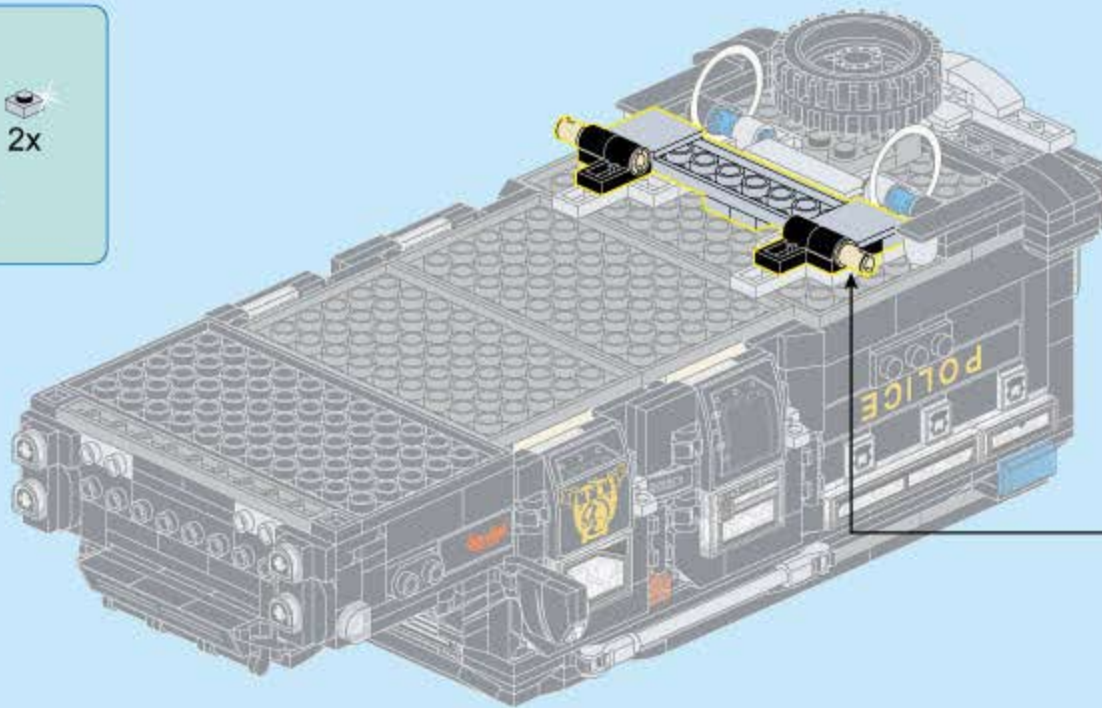
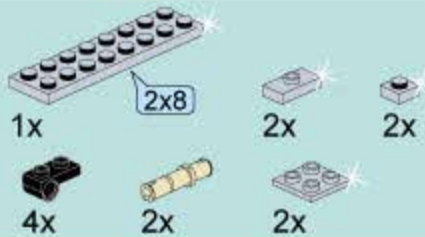

232

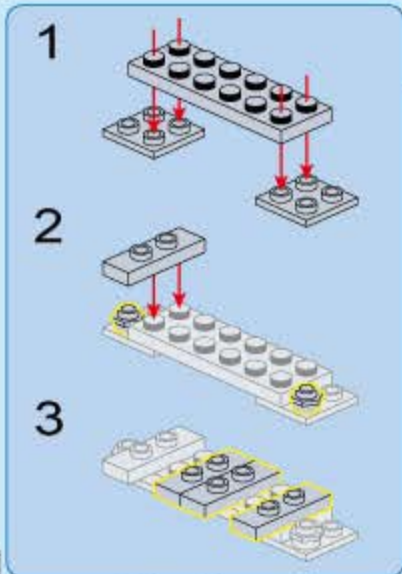
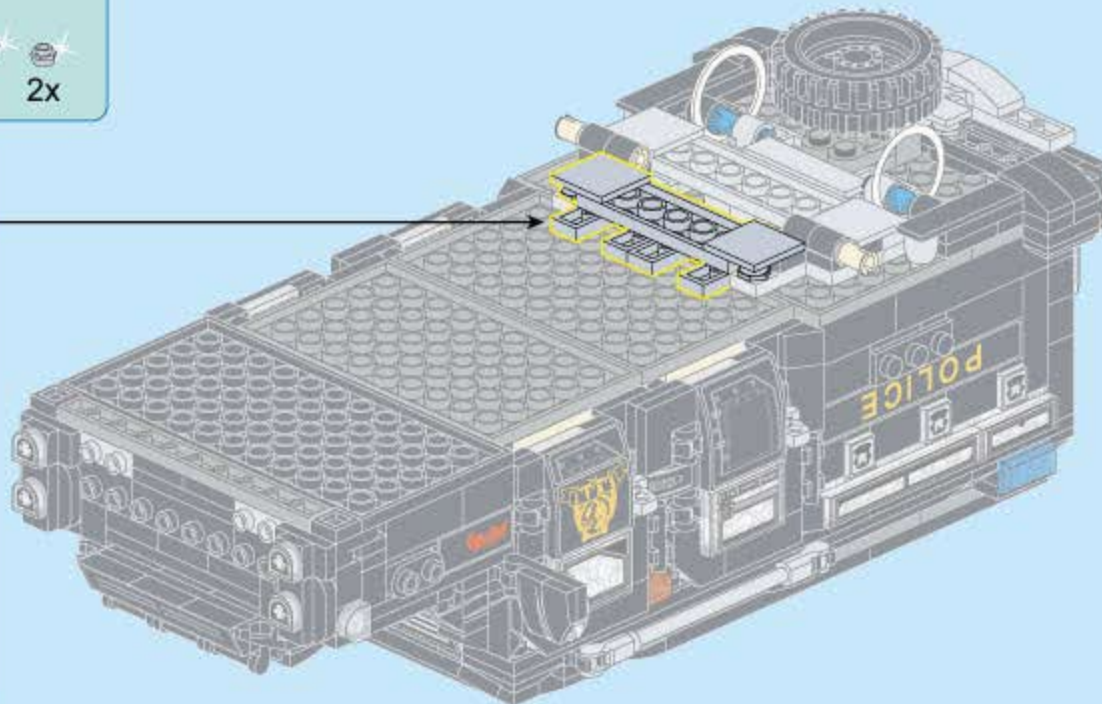
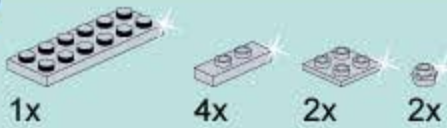





233

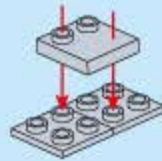

234

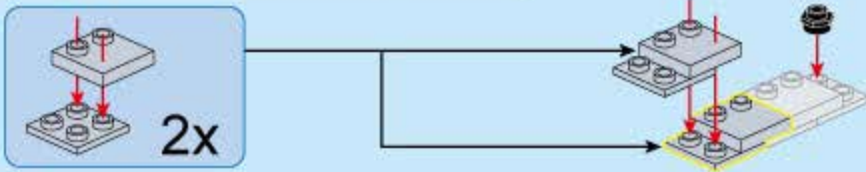

235

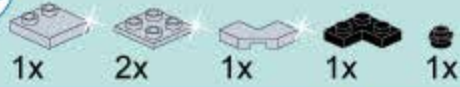

236

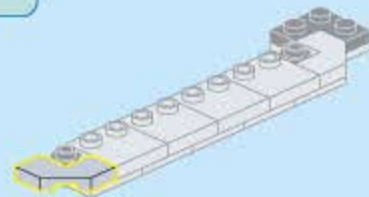

237

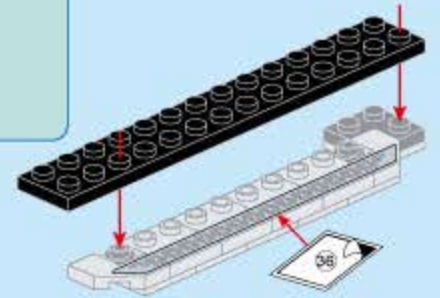
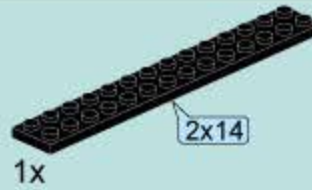

238

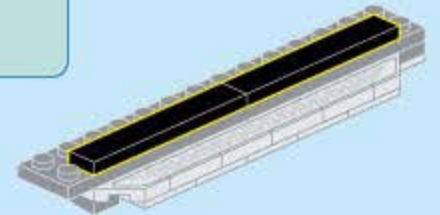
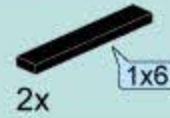

239

232

238

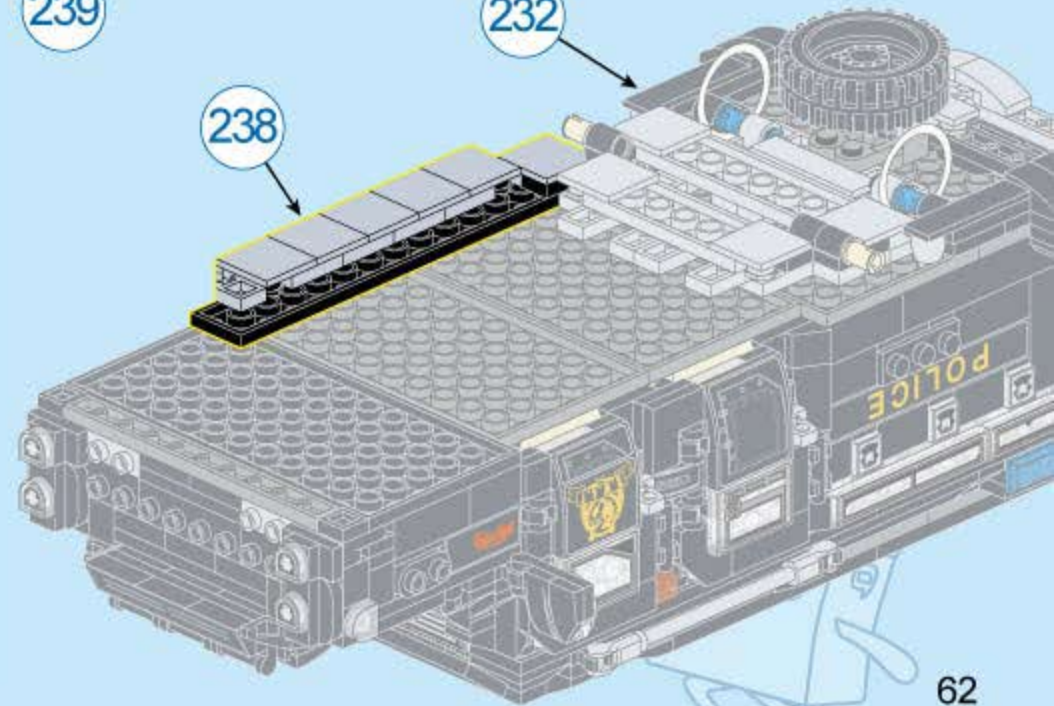



240

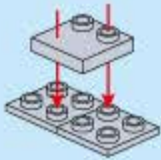

241

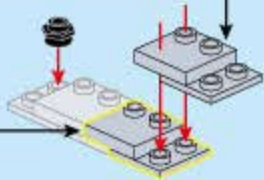
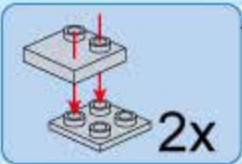

242

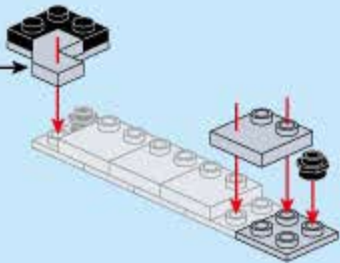
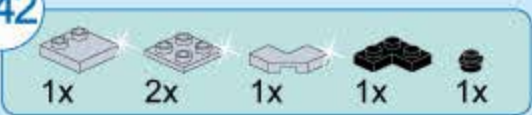

243



244

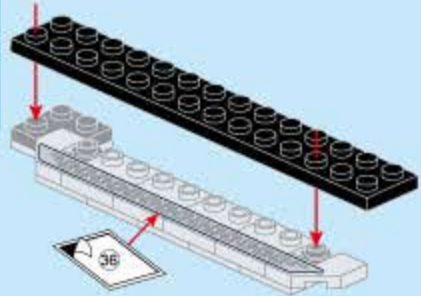
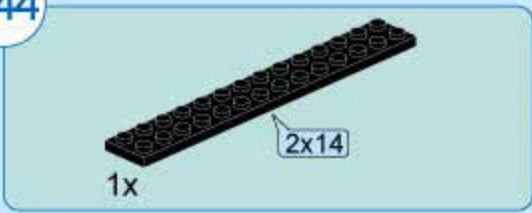

245

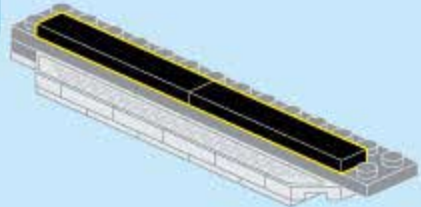

246

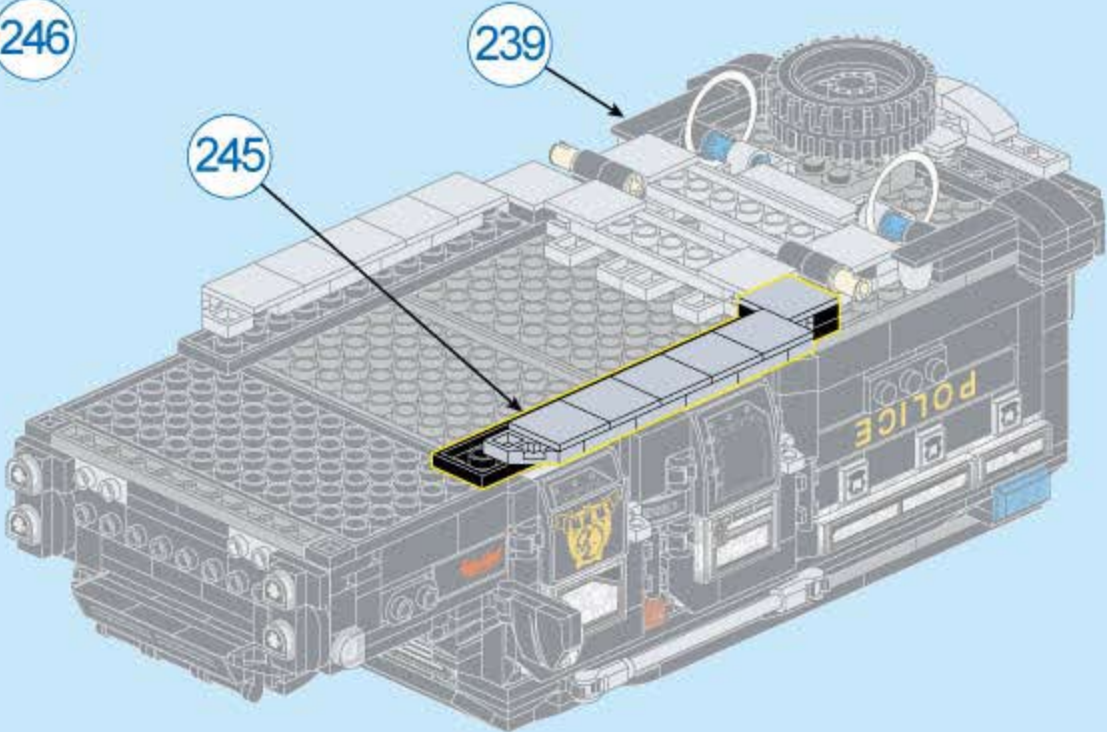



247

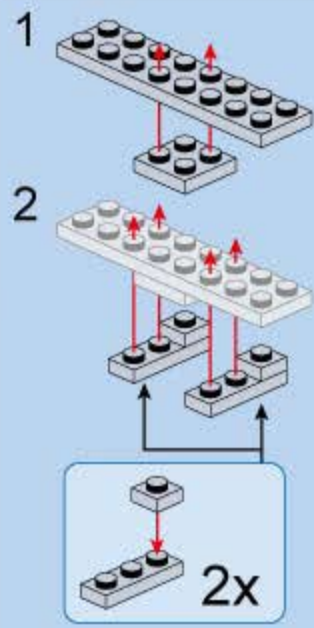
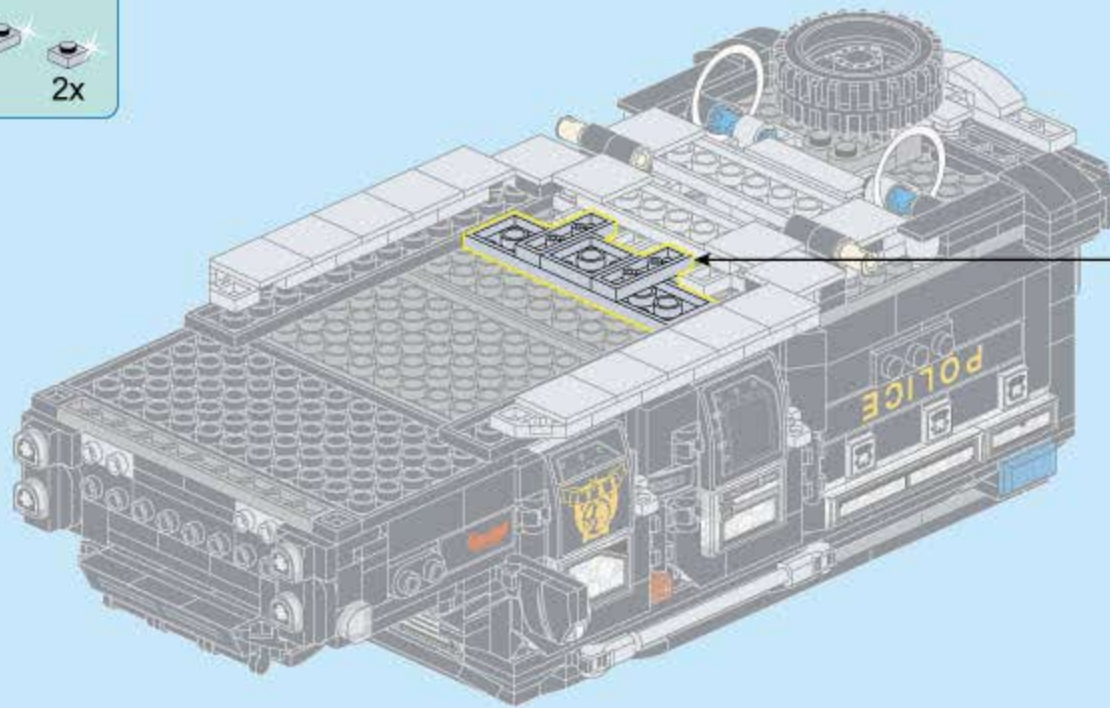
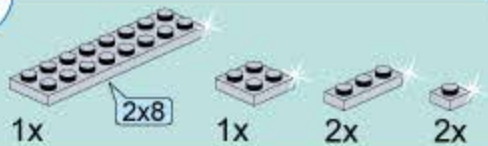

248

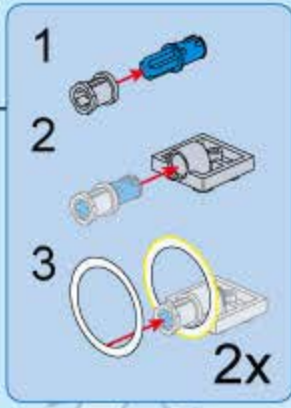
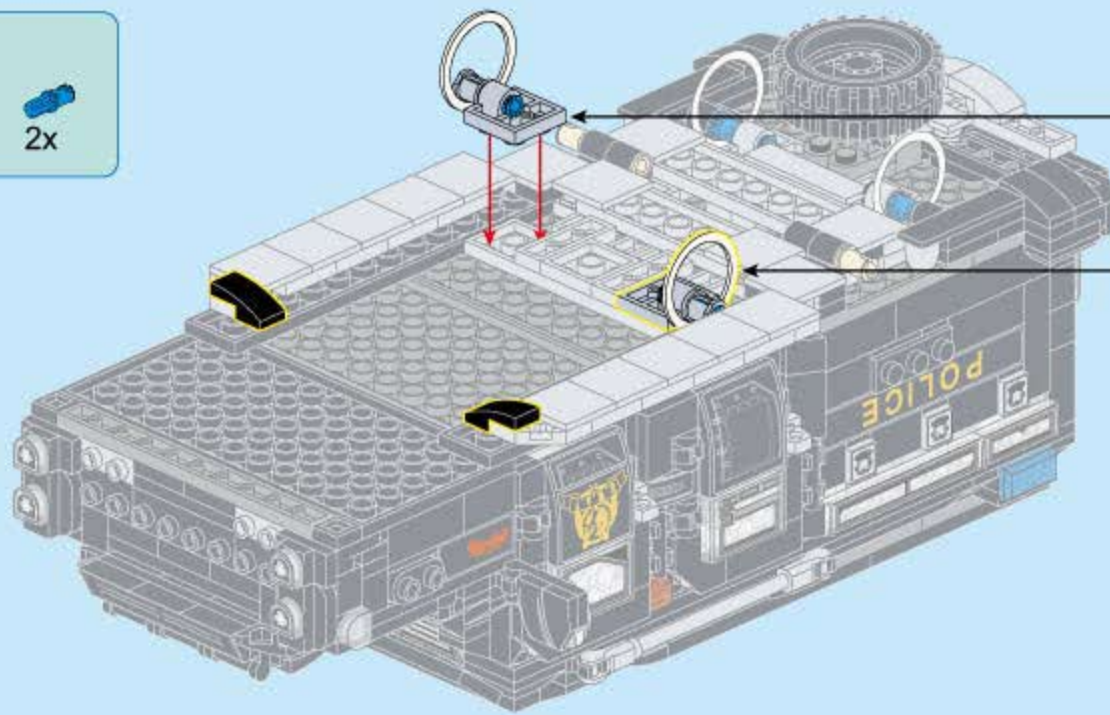

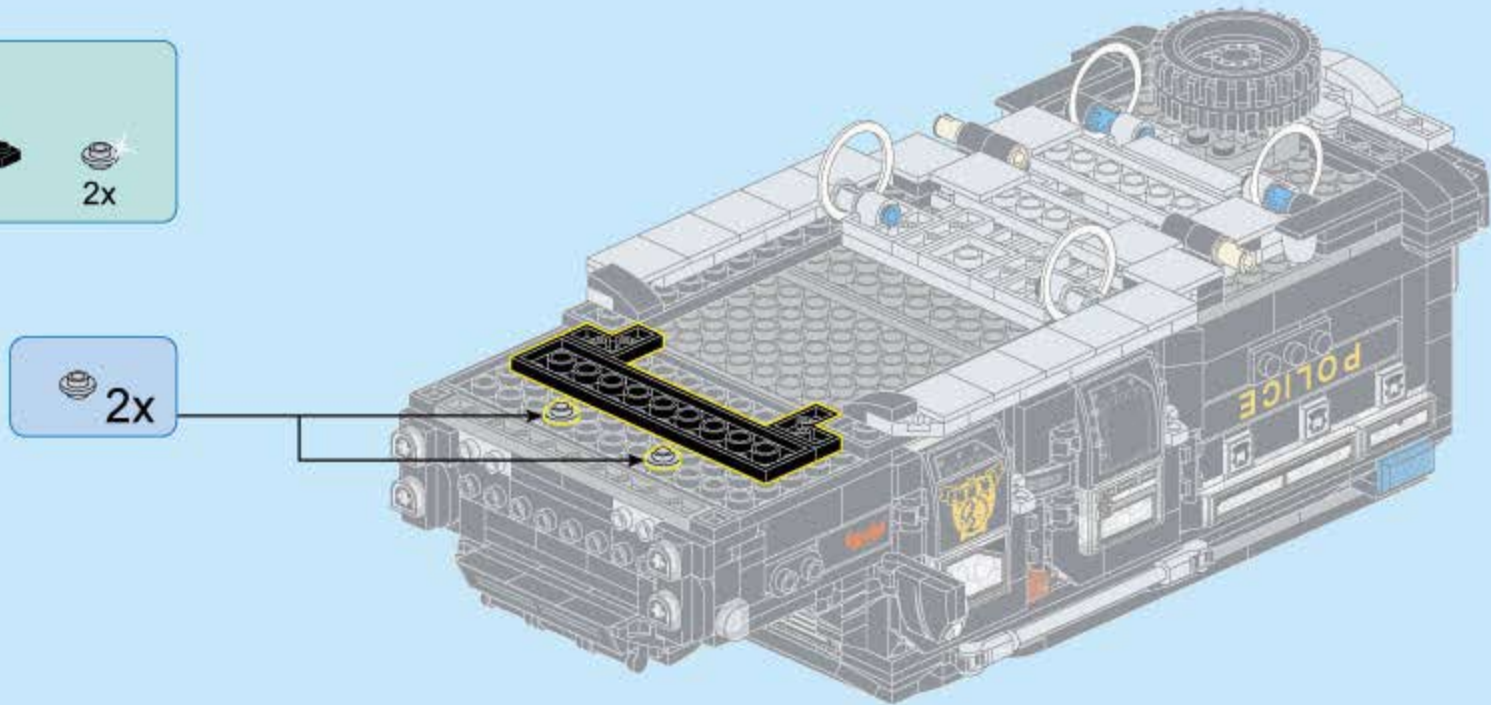
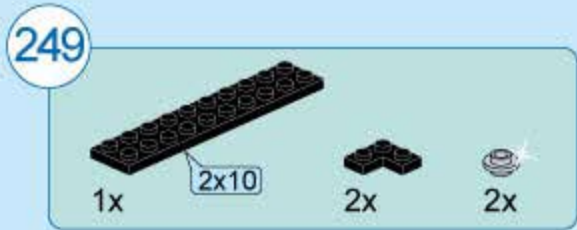
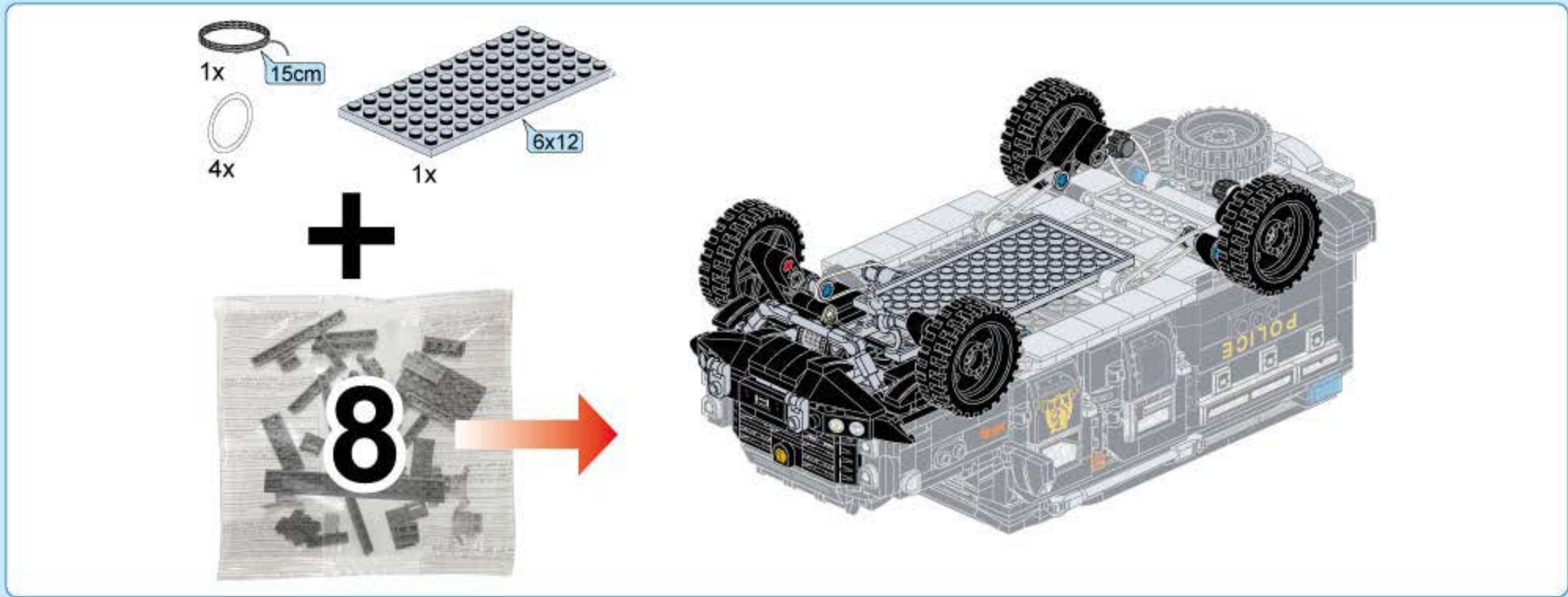



250

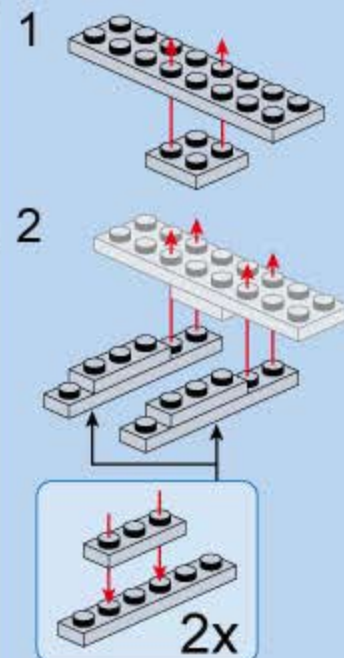
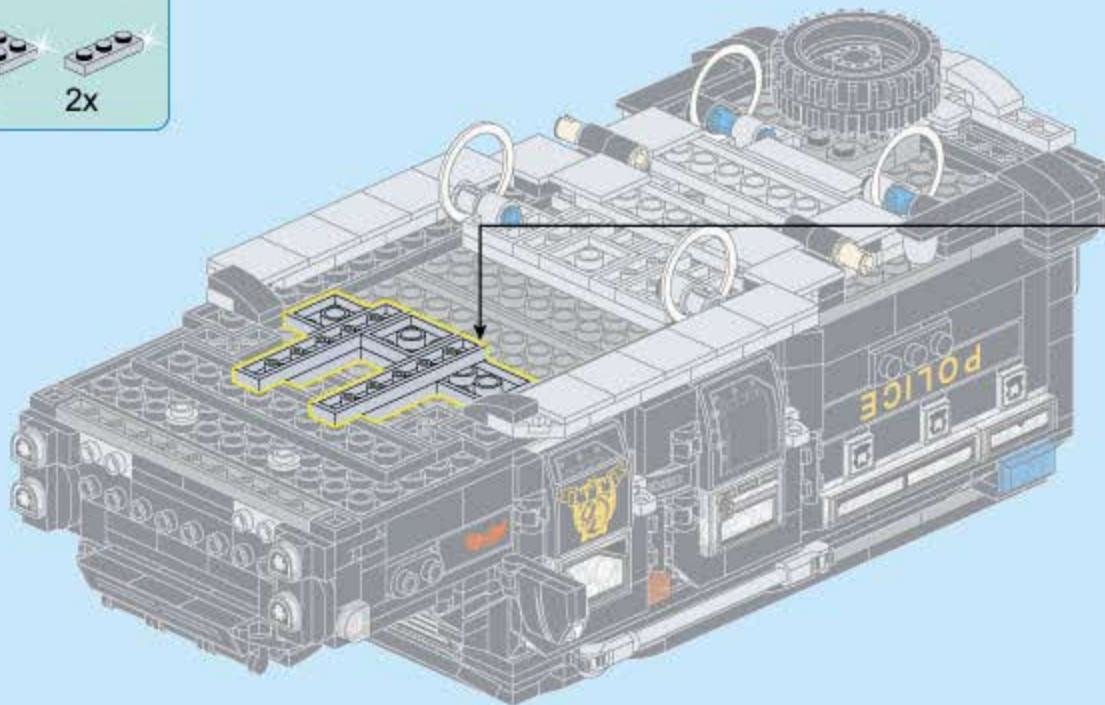
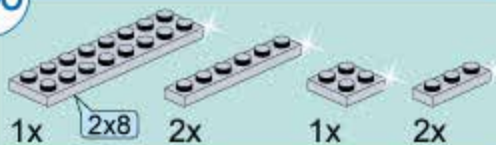

251

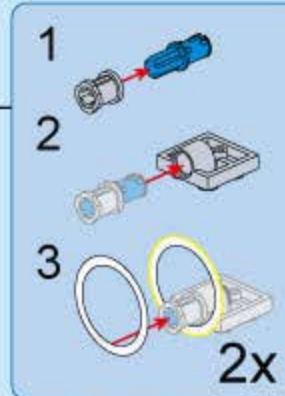
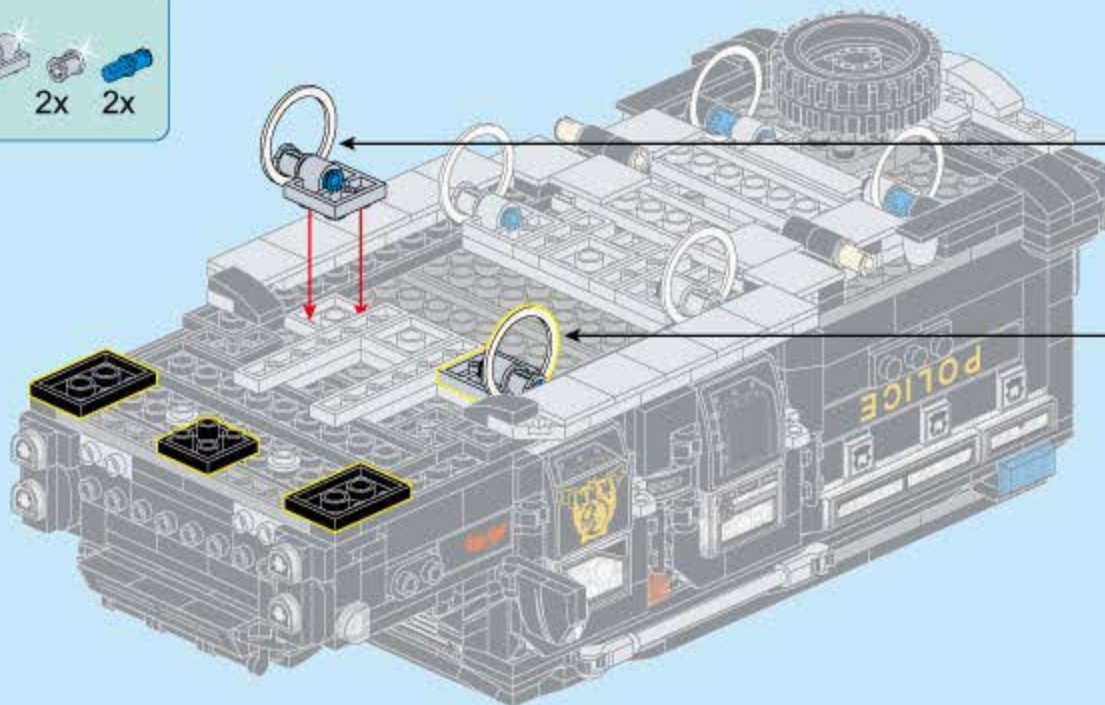



252

- 4x
- 4x
- 4x
- 2x
- 2x

1

2

3

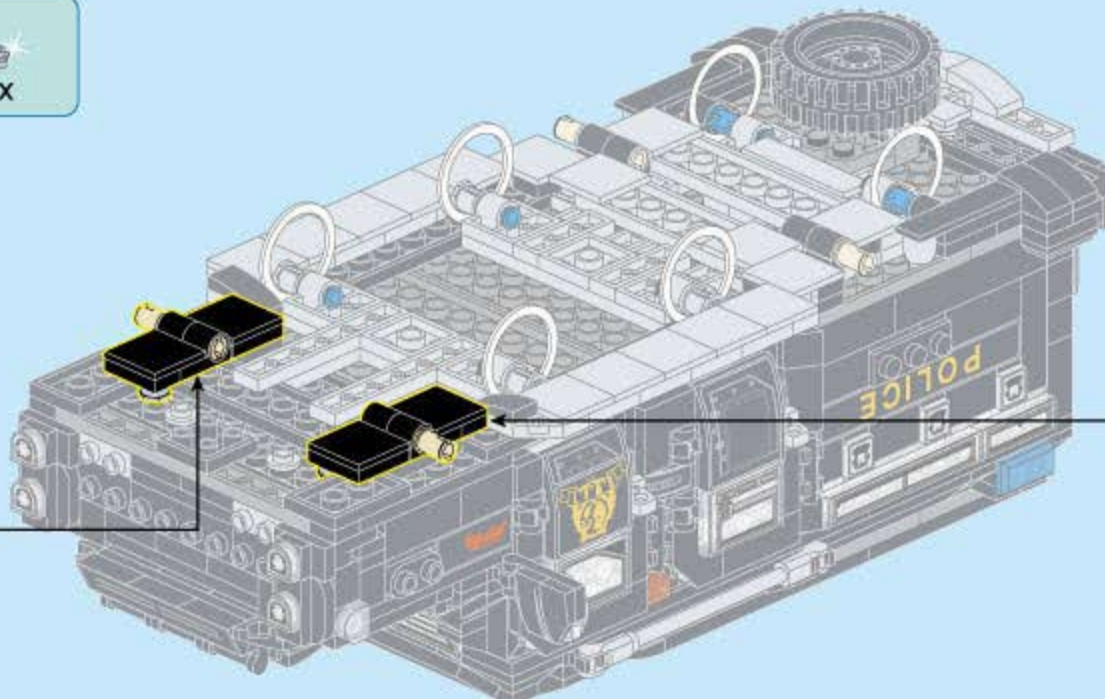

1

2

3

253

- 
- 6x12
- 1x
- 2x
- 2x
- 2x
- 2x
- 8x

1

2

3

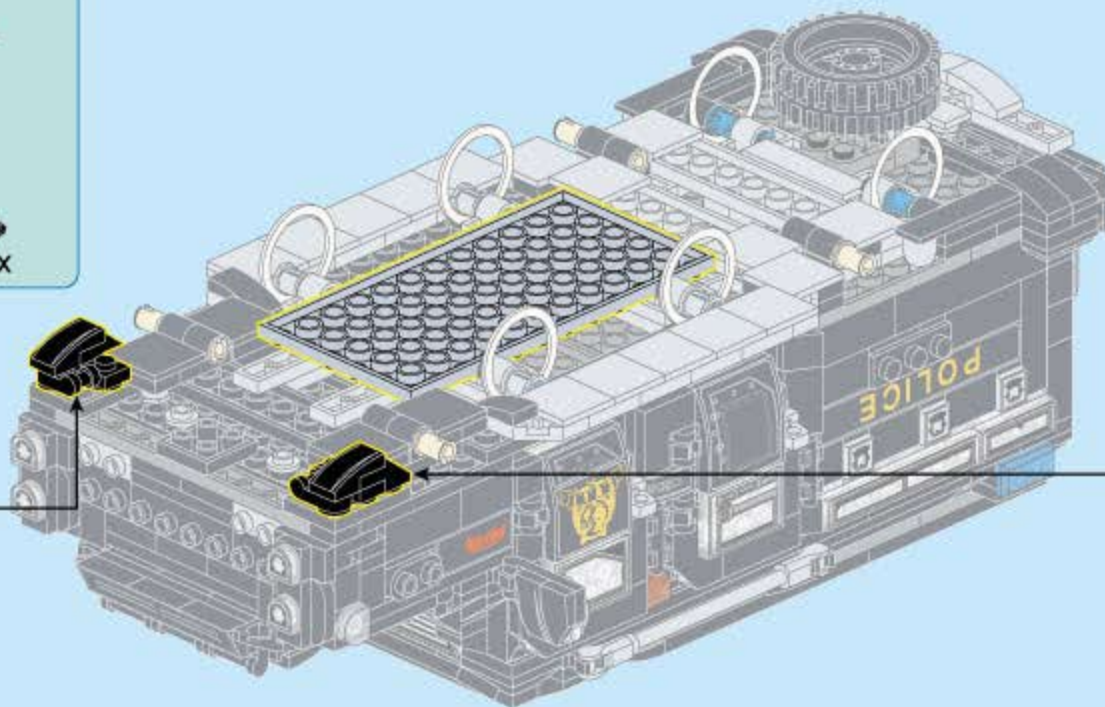

1

2

3



254

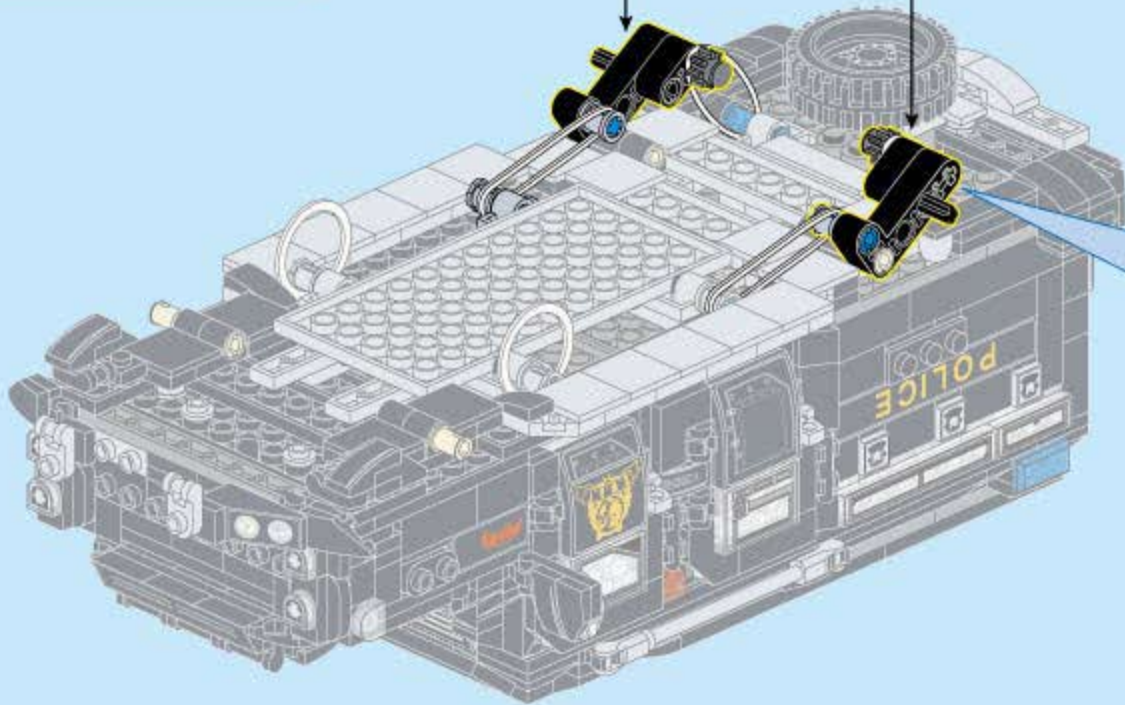
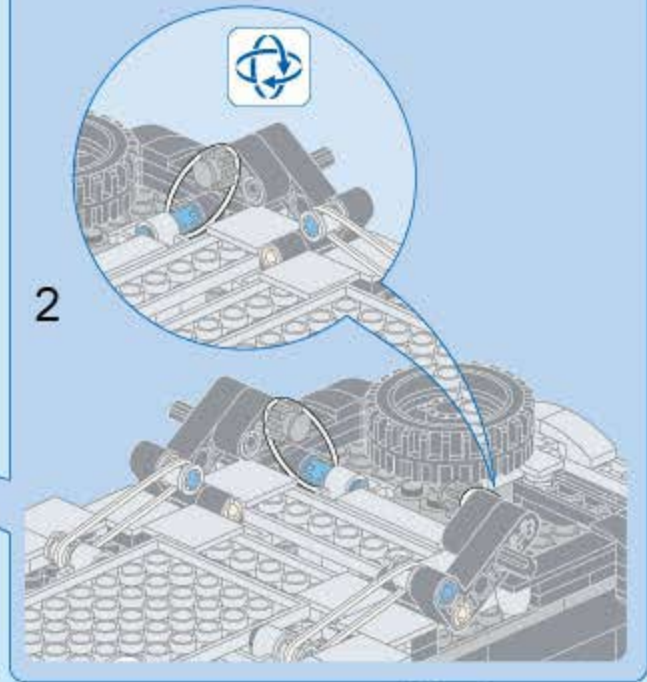
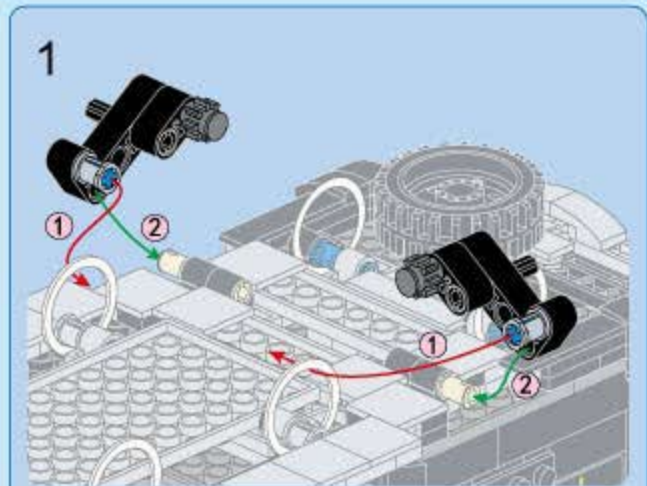
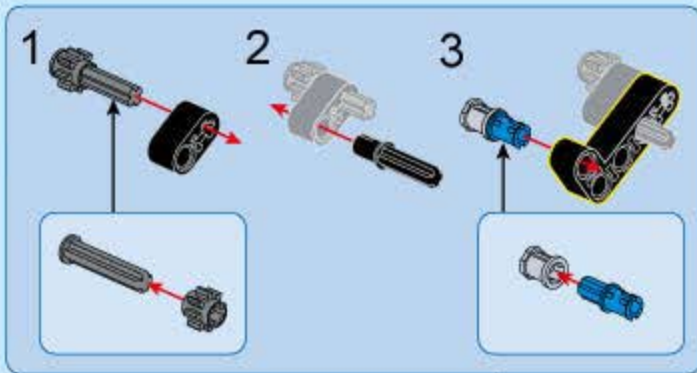
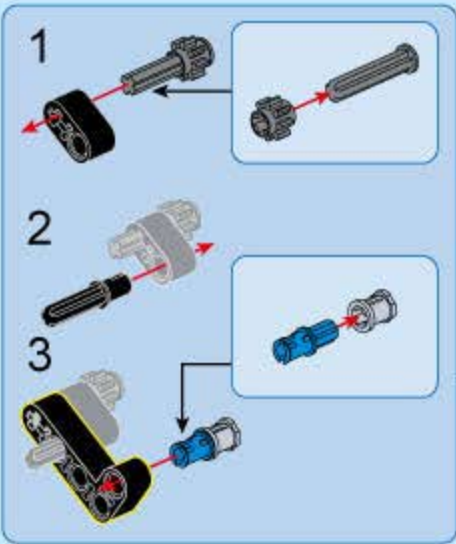

255



1:1

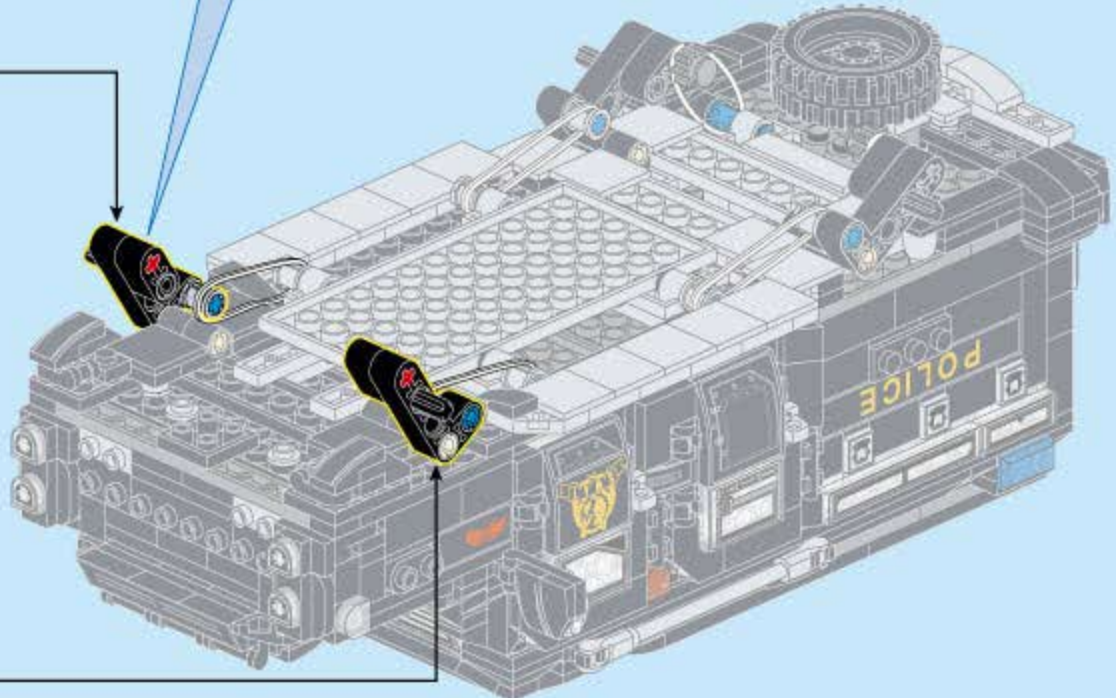
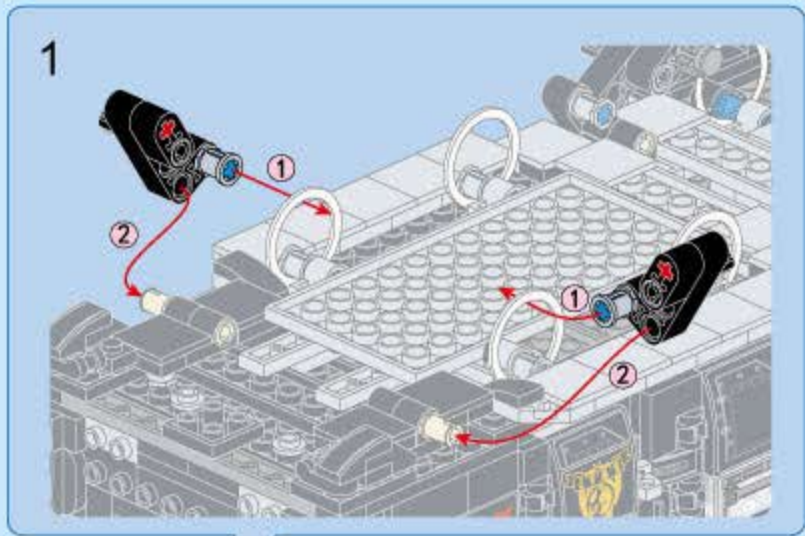
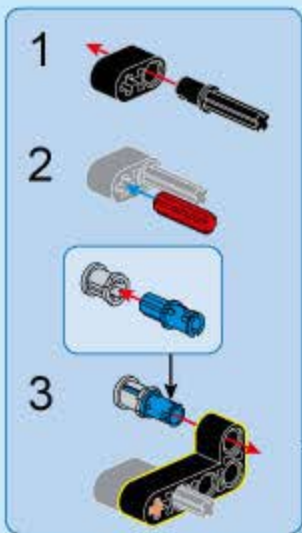
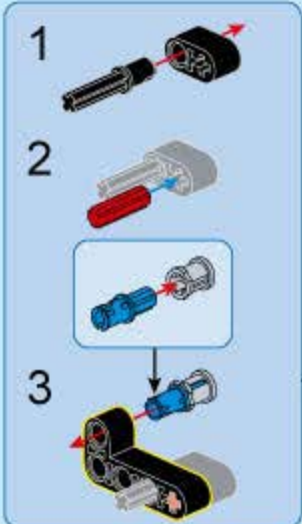



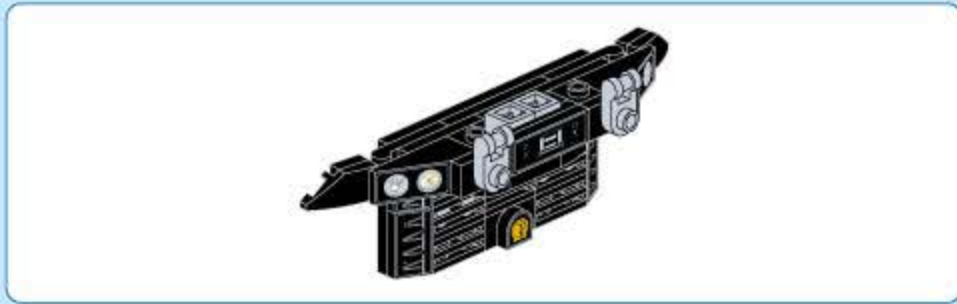

256

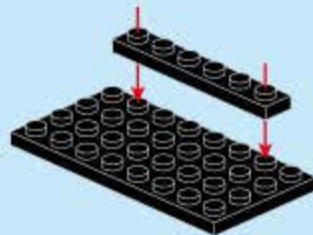
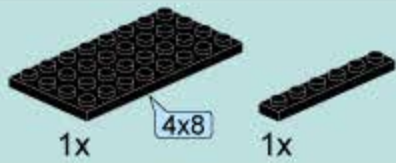

257

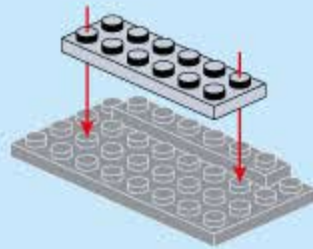

258



259

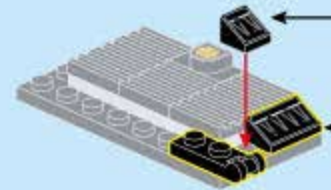

260

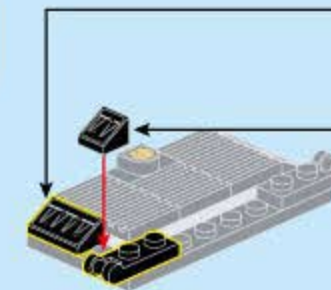

261

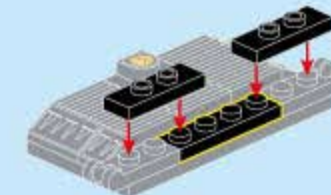

262

1x 1x 1x 2x

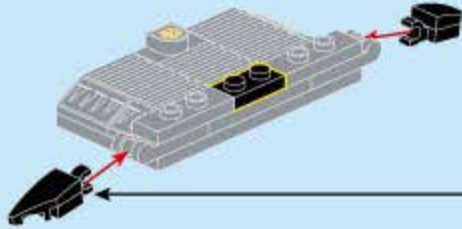

263

1x 1x 1x 1x3  
1x 1x 1x 2x

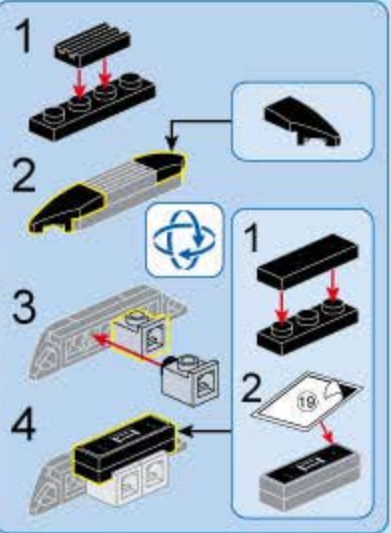
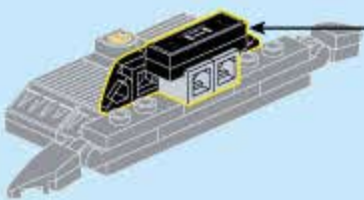

264

2x 2x

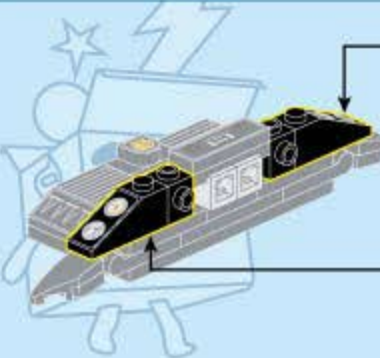

265

2x 2x

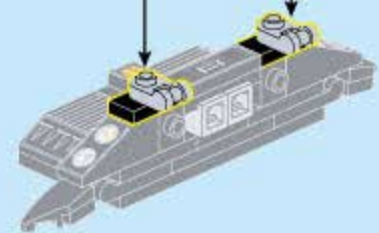

266

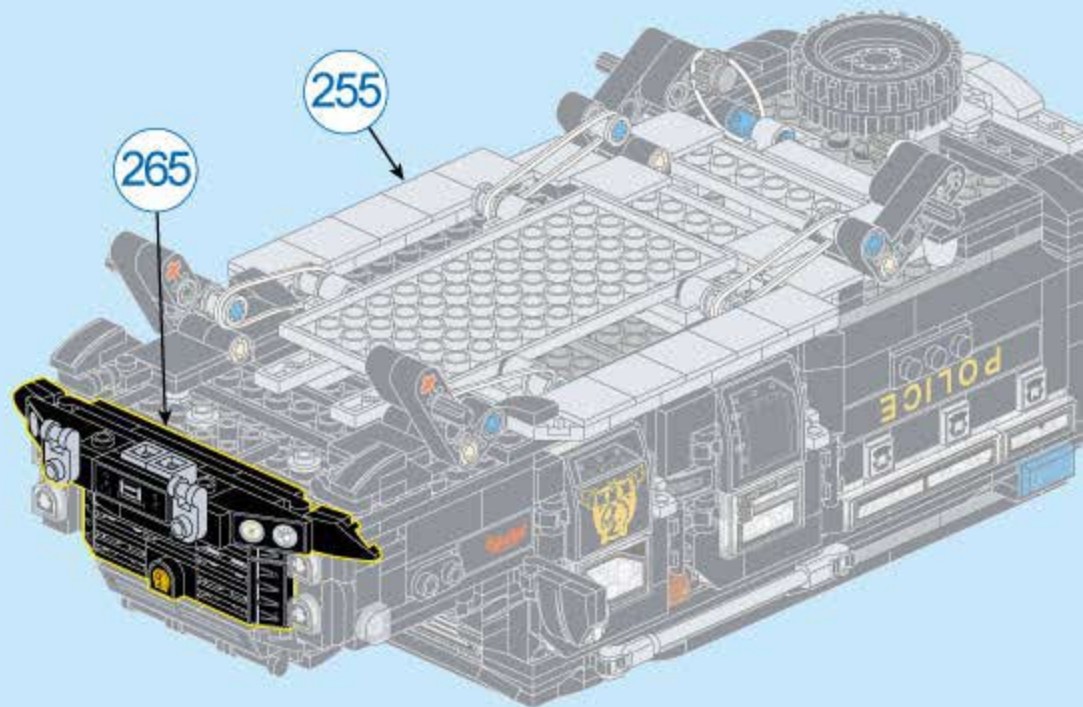



267

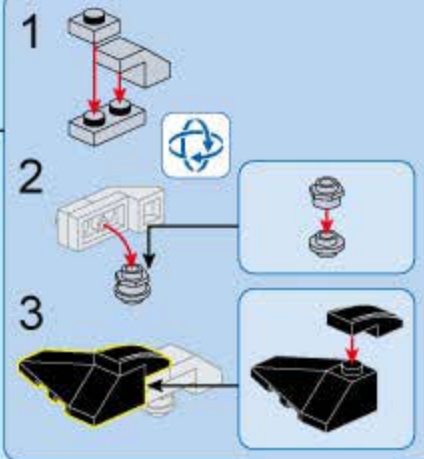
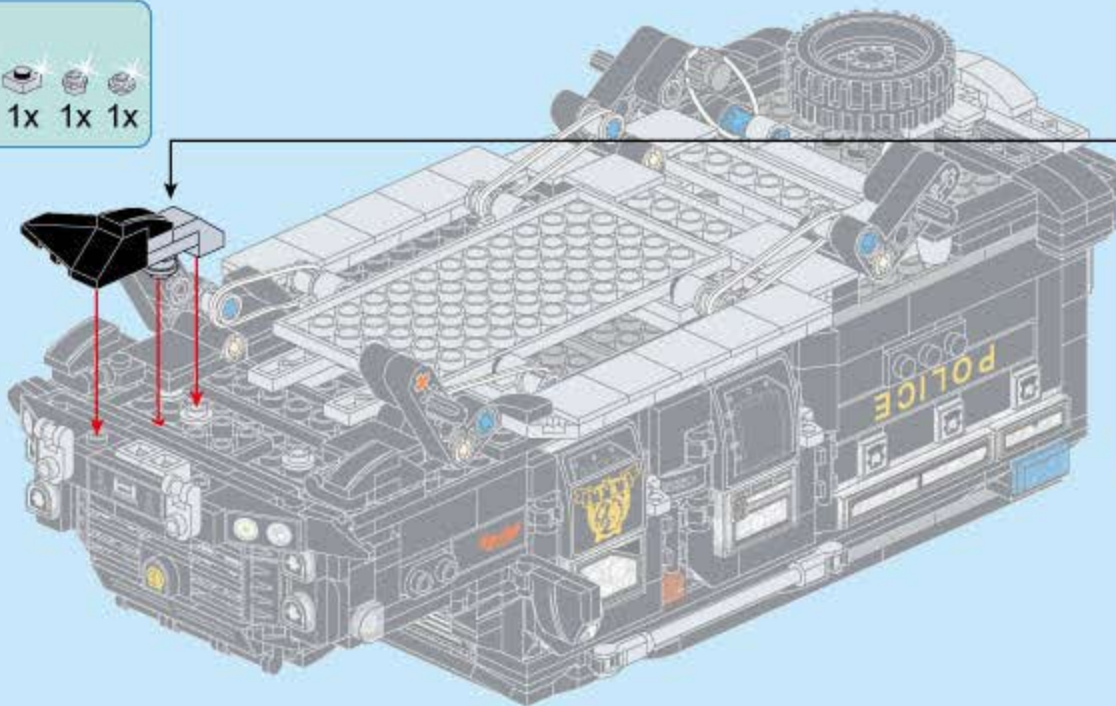

268

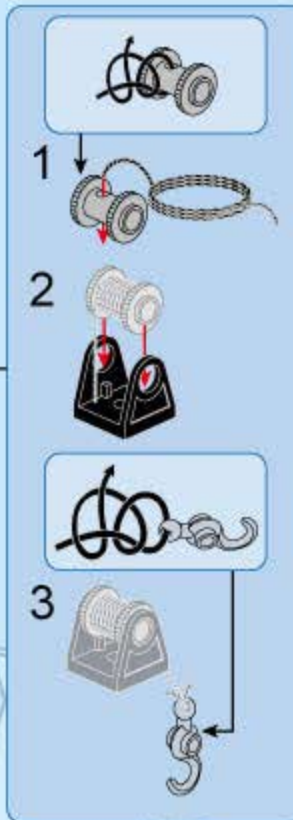
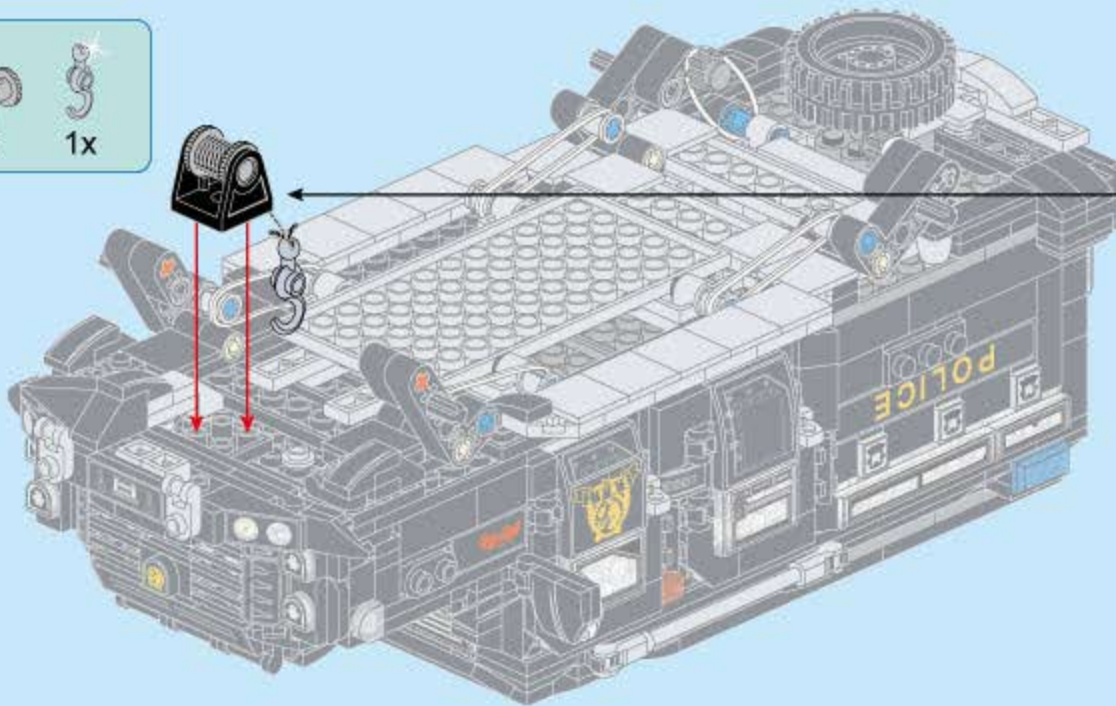

269

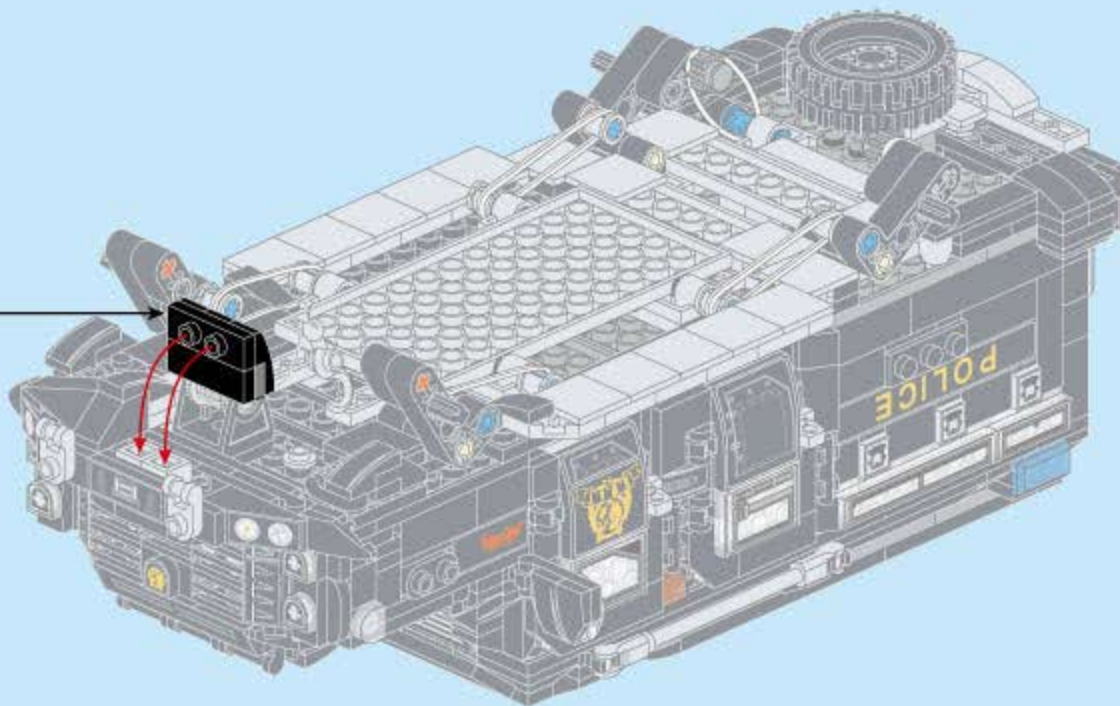
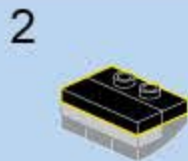
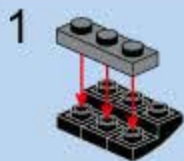

270

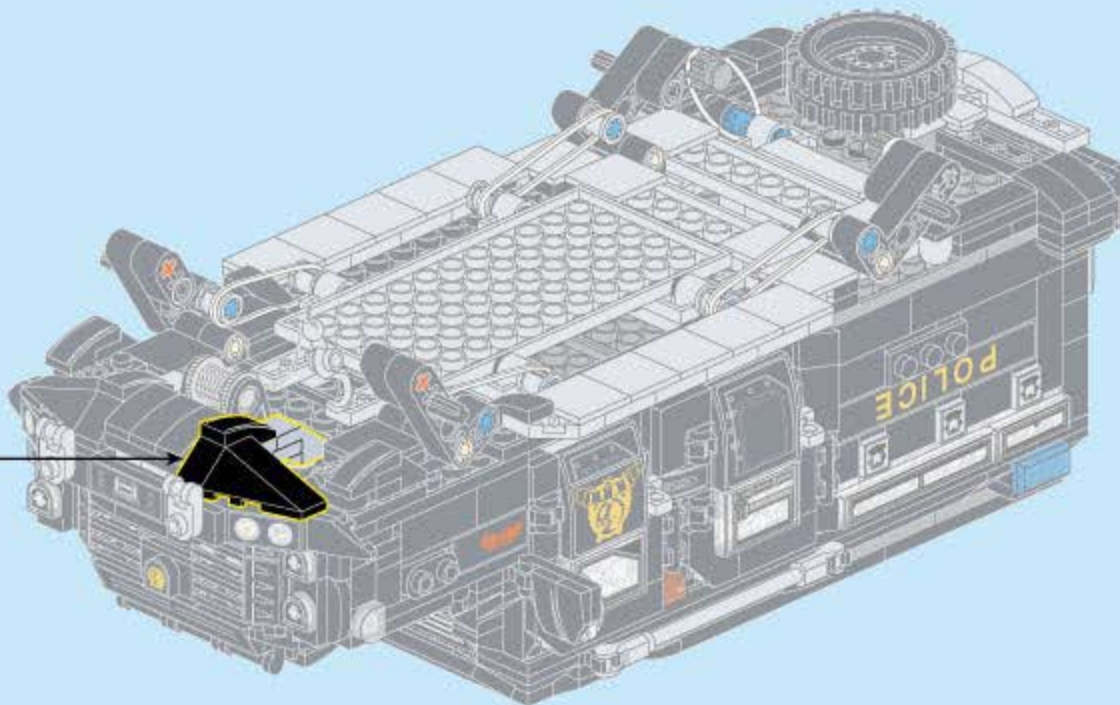
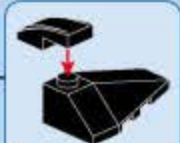
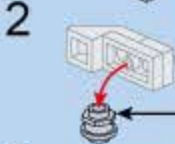
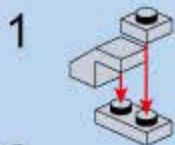



271

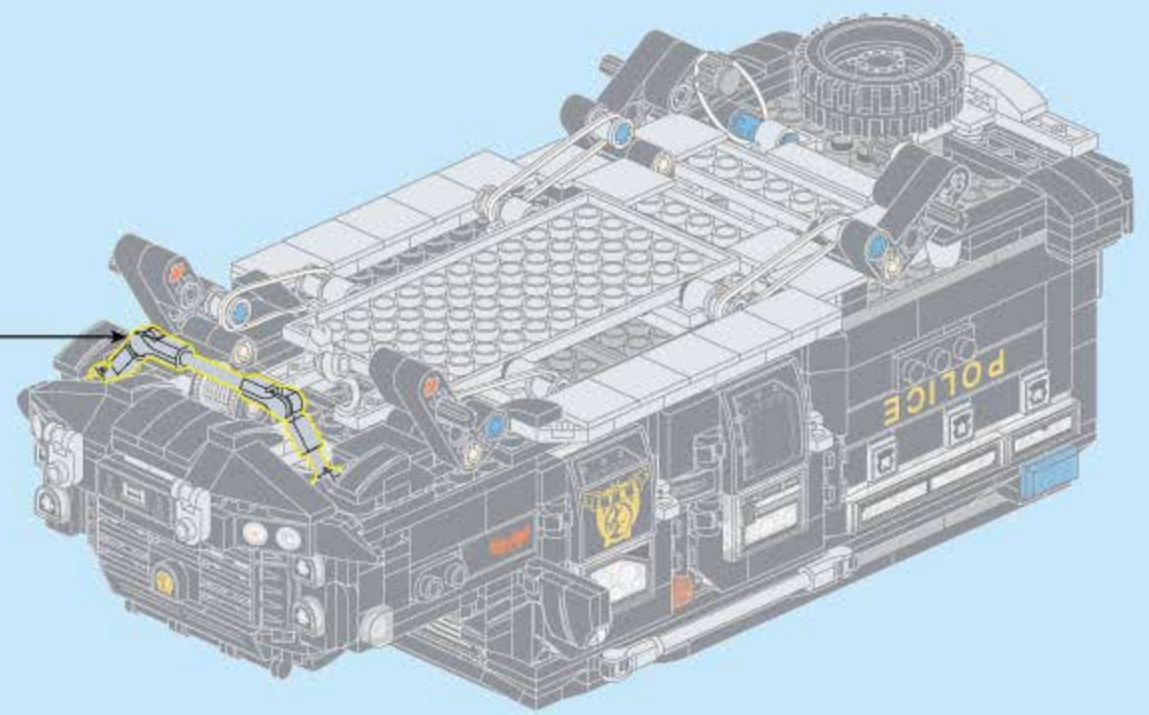
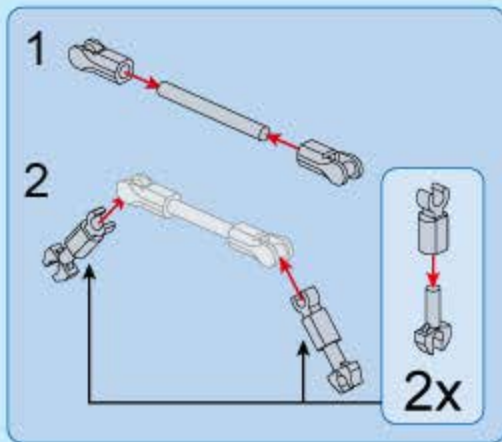

272

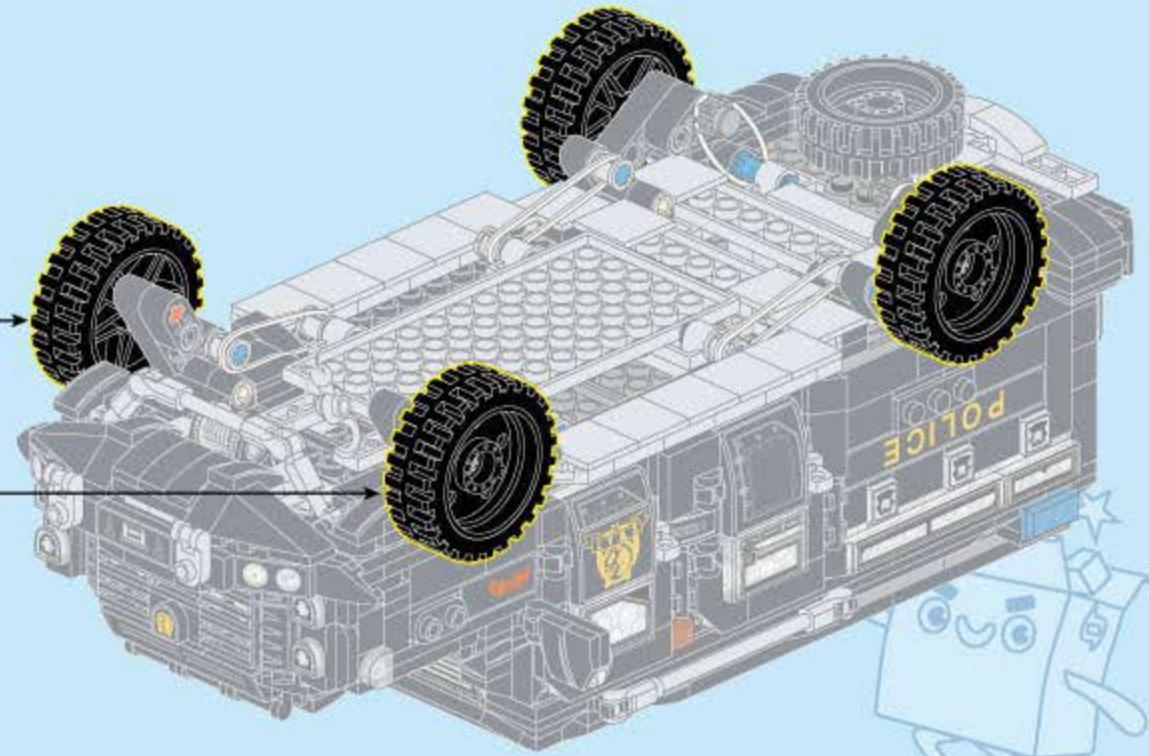

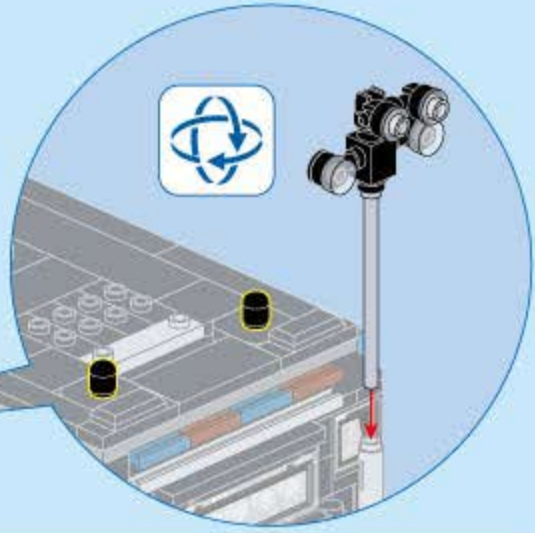
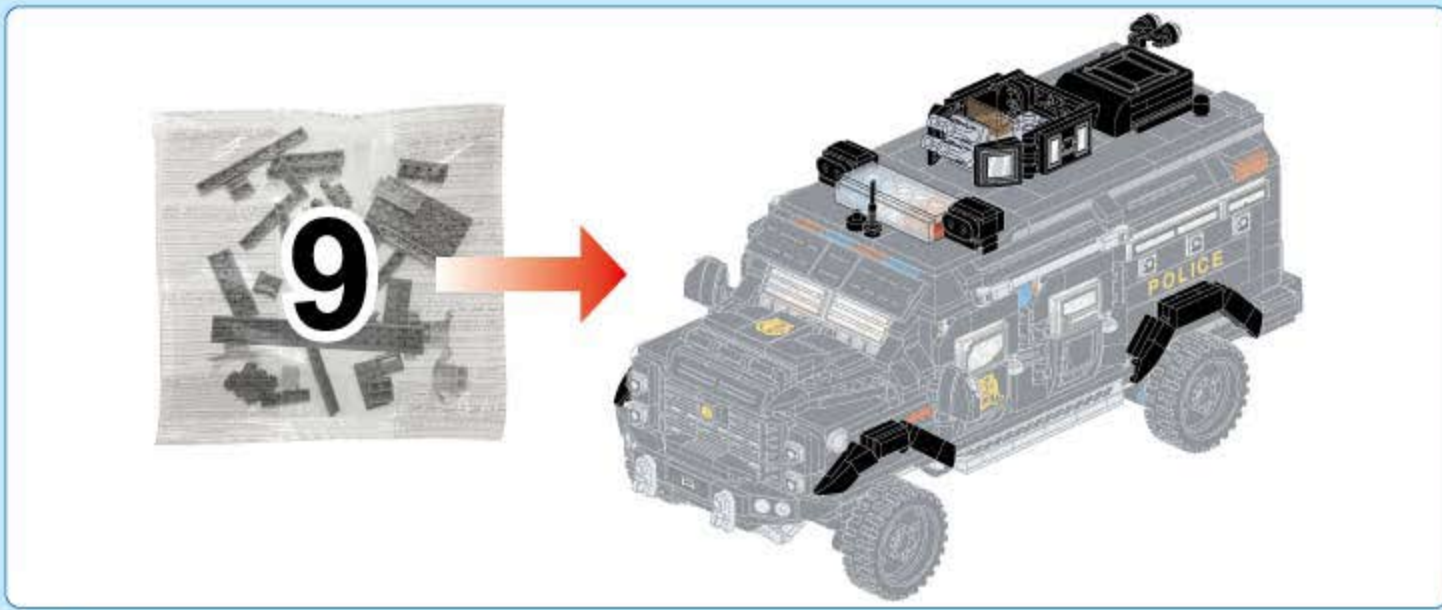

- 273
- |    |    |    |    |
|----|----|----|----|
|    |    |    |    |
| 1x | 1x | 2x | 1x |
|    |    |    |    |
| 3x | 2x | 2x | 2x |
|    |    |    |    |
| 2x | 2x | 2x | 2x |

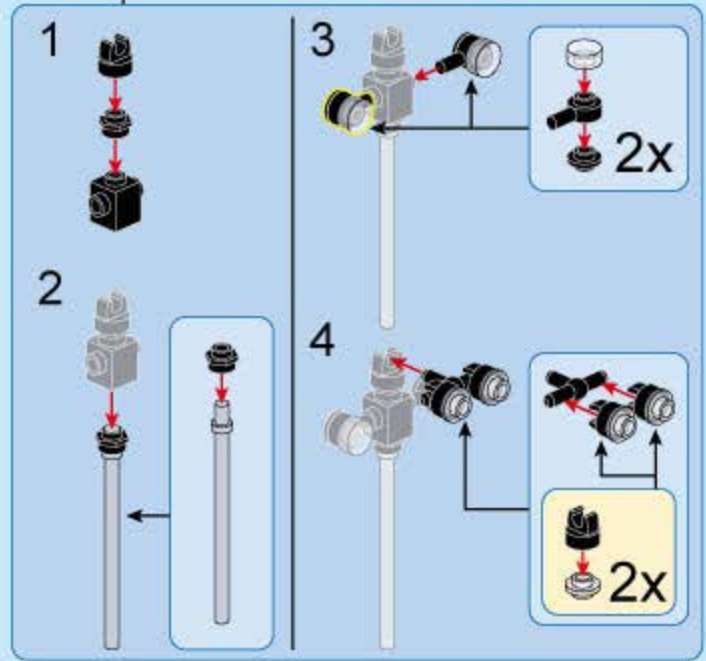



274

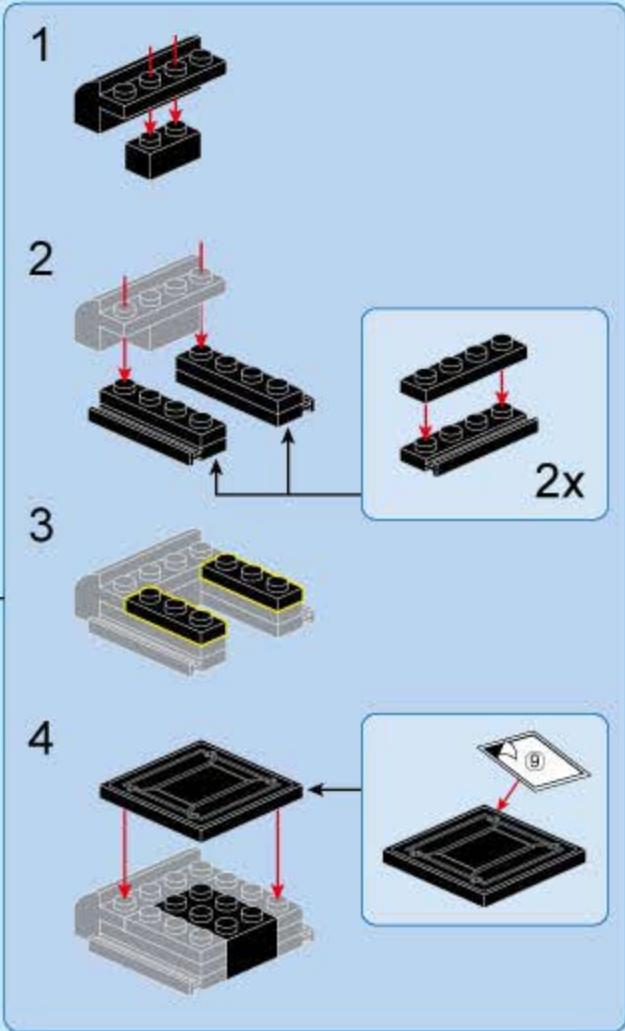
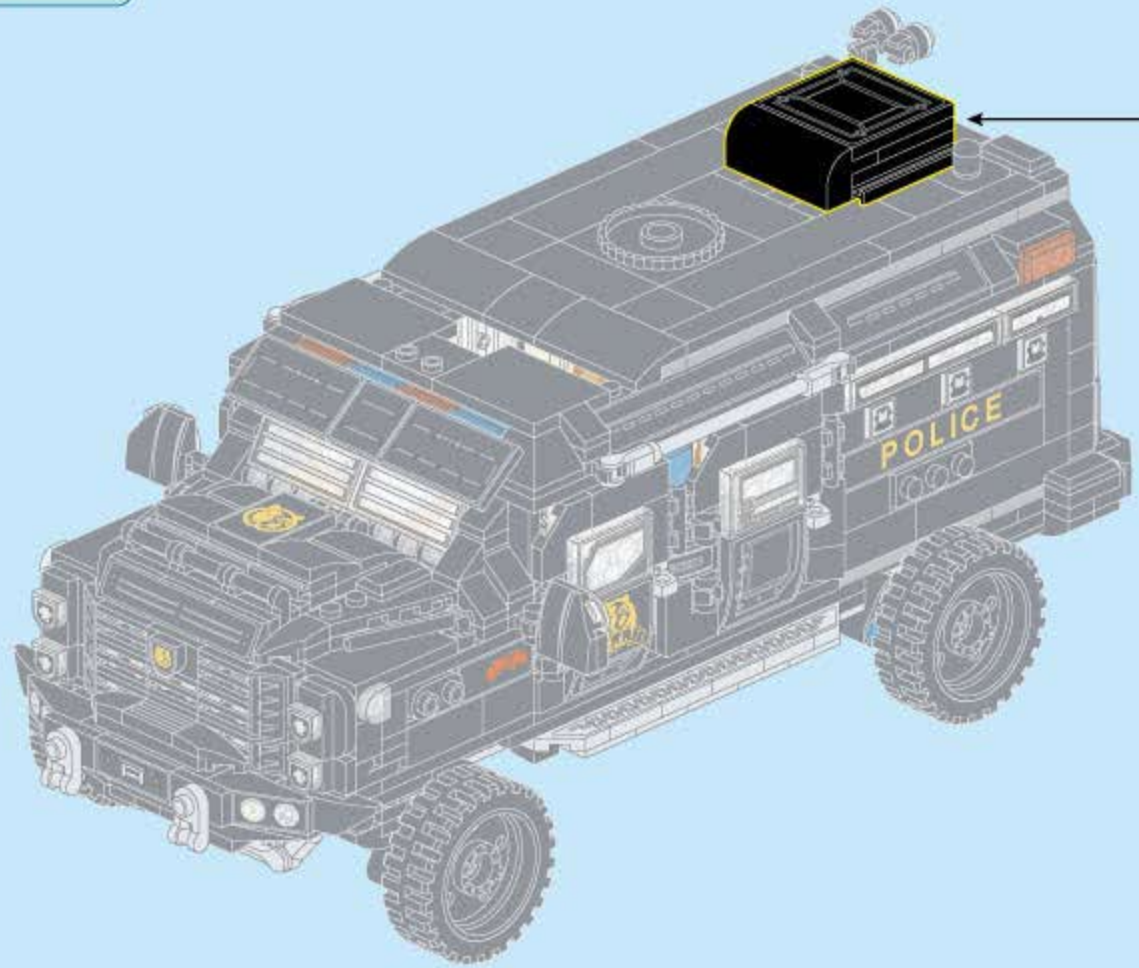
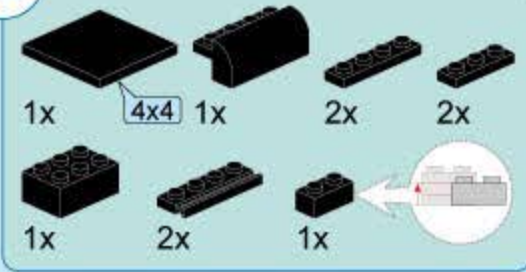

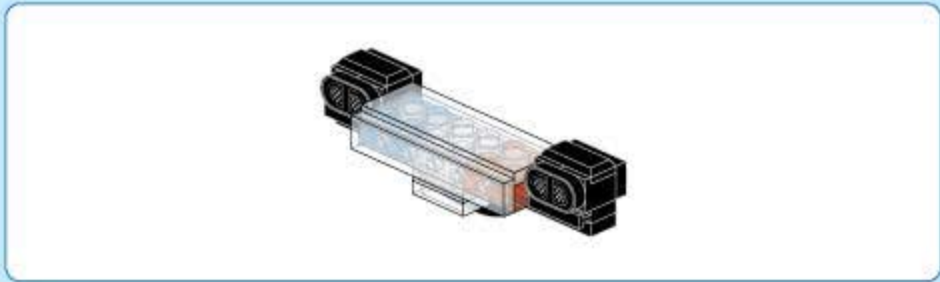

275



1x



2x



276



1x



1x



1x

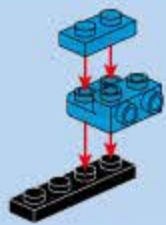

277



1x



1x



1x

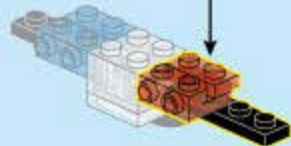
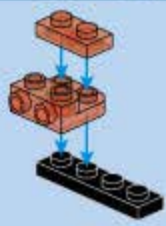

278



1x

2x6



279



2x



2x



2x



2x



4x

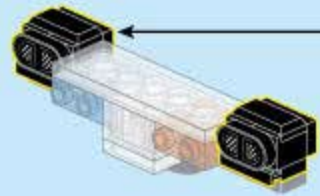

280



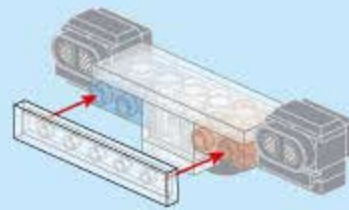

1x

1x6

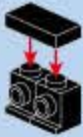

1 

2 

3 



2x



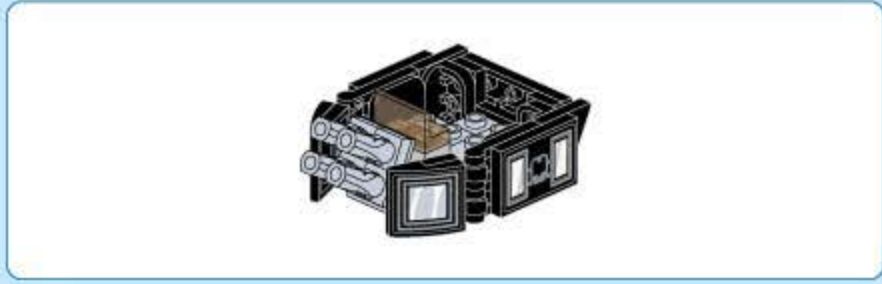
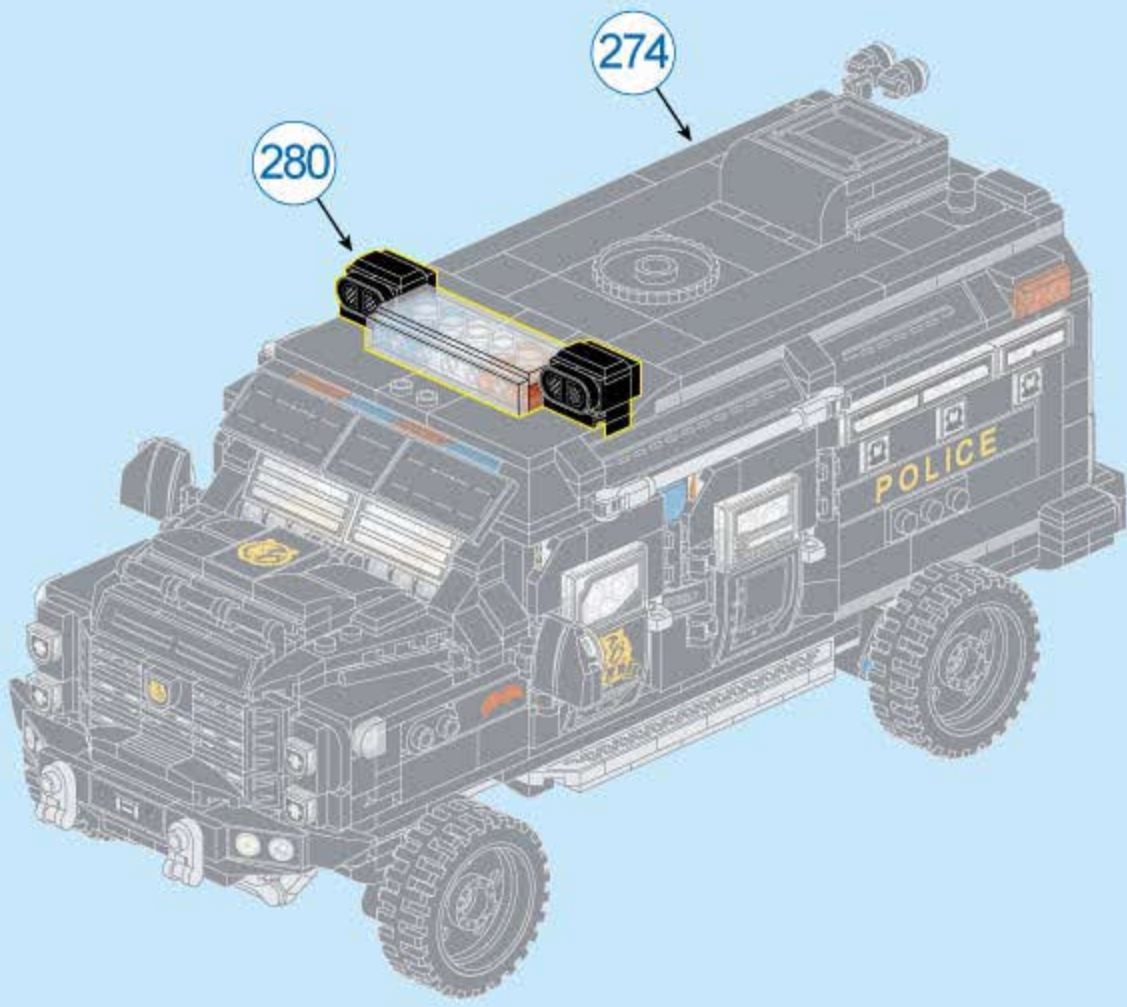

282

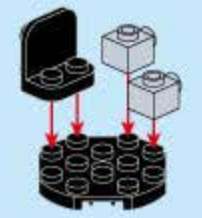

283

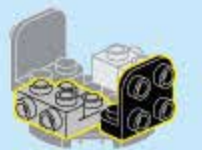

284



285

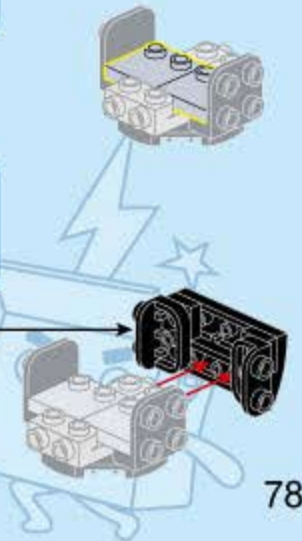
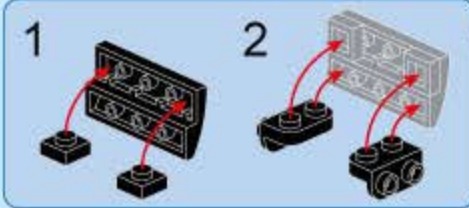

286

1x 2x3 2x 1x

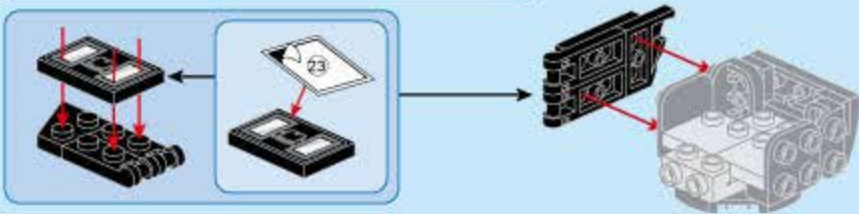

287

1x 1x 1x

1:1

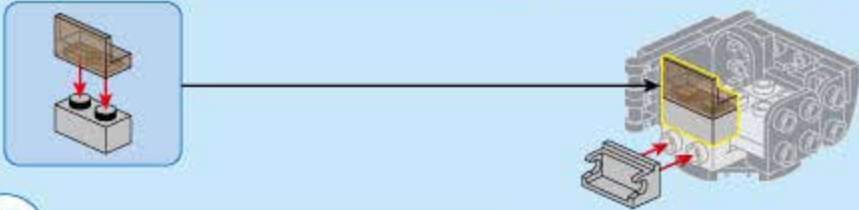

288

1x 2x3 2x 1x



289

1x 1x



290

1x 4x 4x

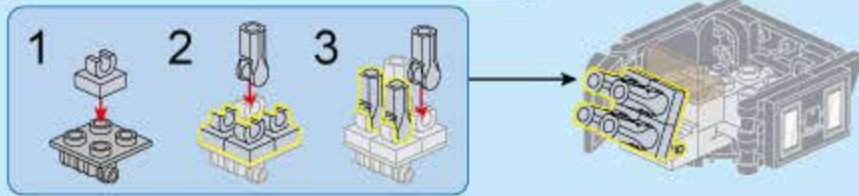

291

1x 1x

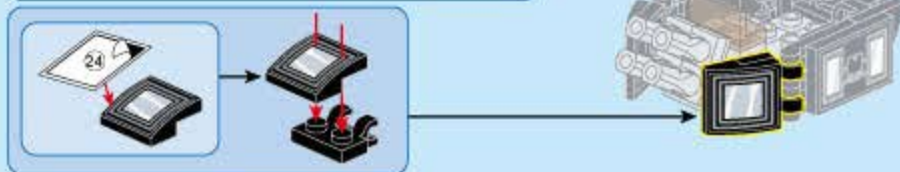

292

1x 1x 1x

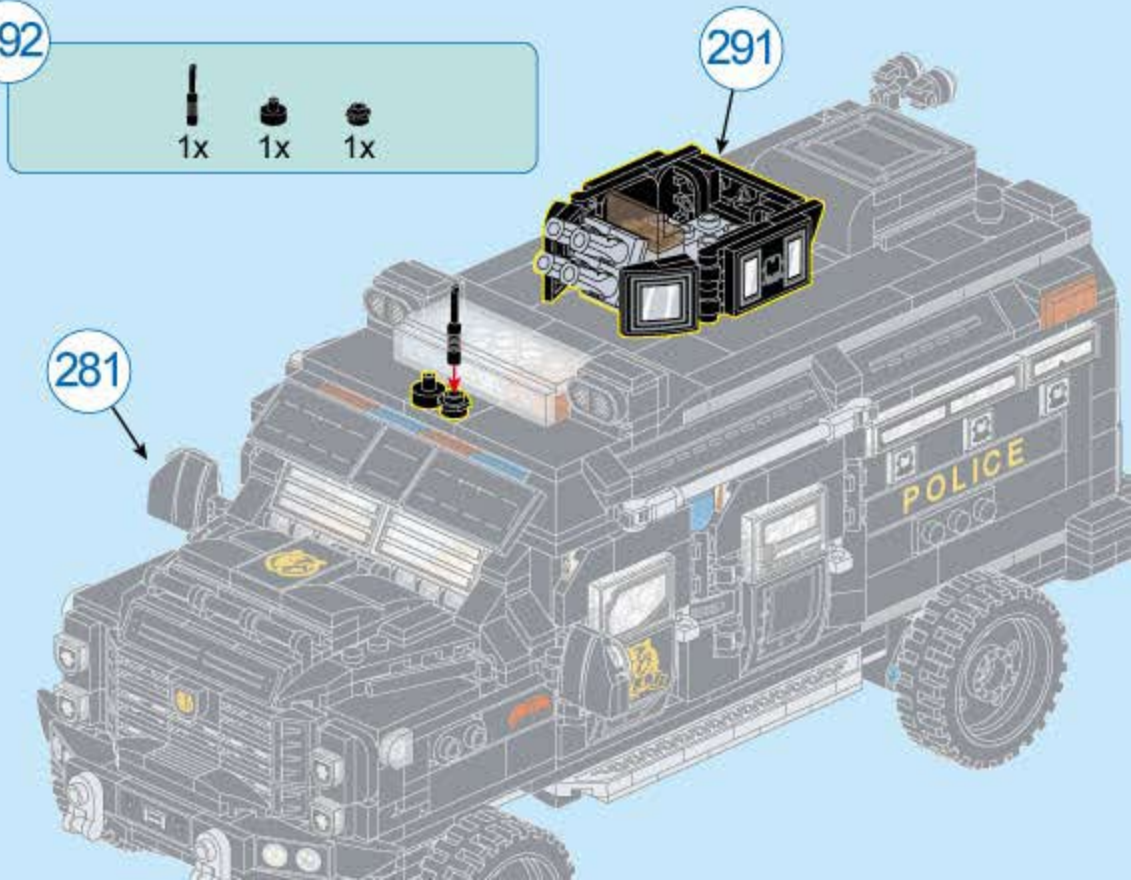



- 2x  1x3  2x  2x  2x 
- 2x  4x  4x  2x  2x 

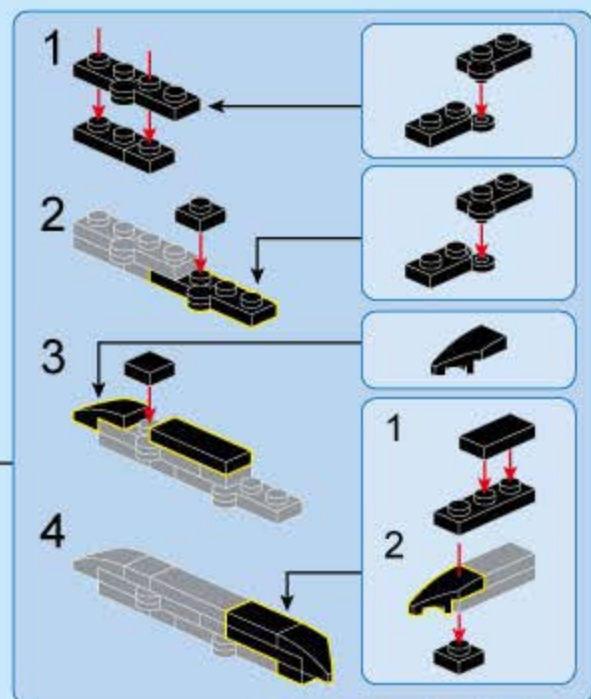
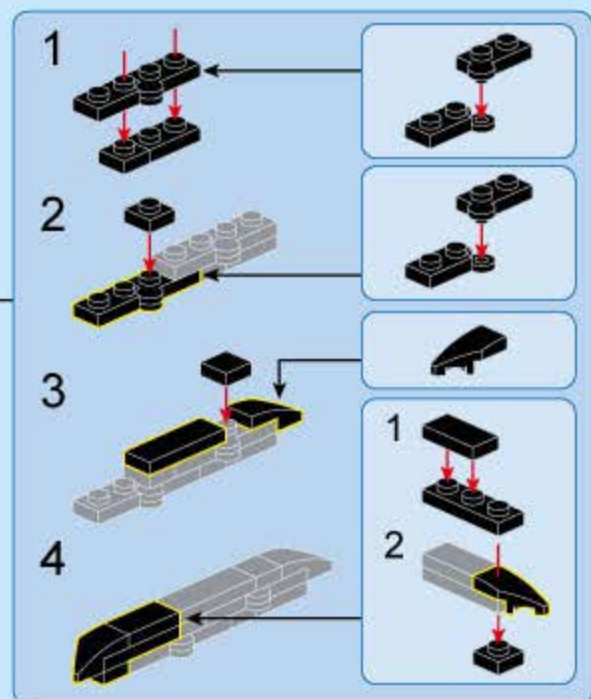
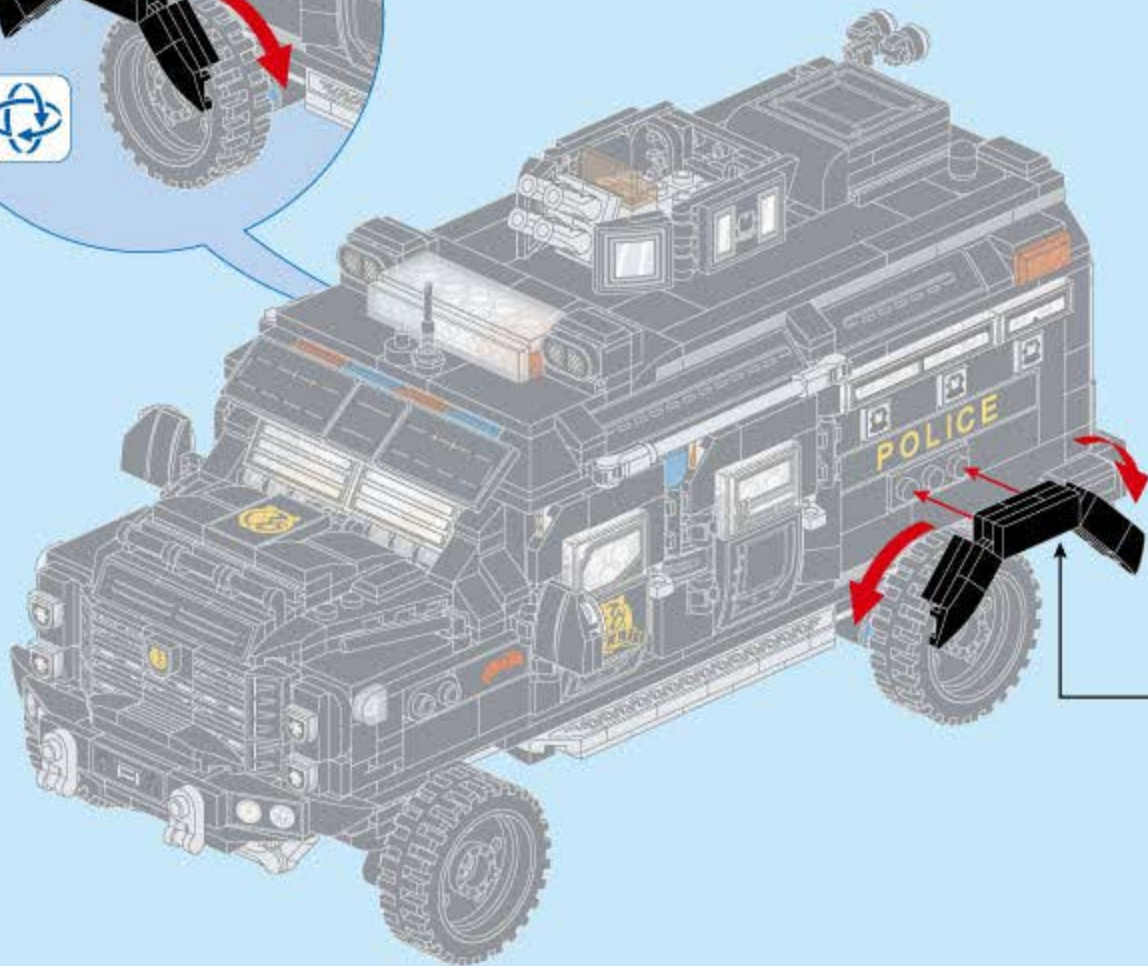
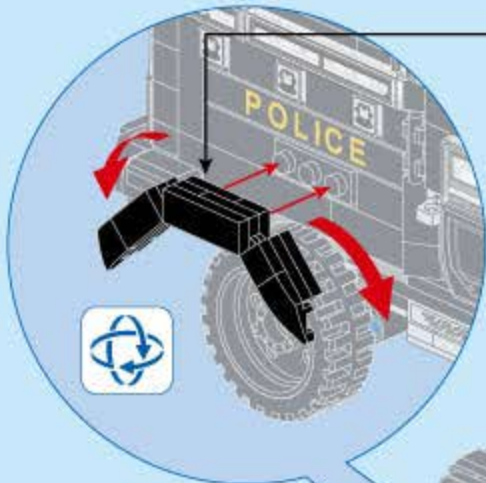

- 2x [1x3 Technic Brick]
- 2x [1x2 Technic Brick]
- 2x [1x2 Technic Brick]
- 2x [1x2 Technic Brick]
- 4x [1x2 Technic Brick]
- 4x [1x2 Technic Brick]
- 2x [1x2 Technic Brick]
- 2x [1x2 Technic Brick]
- 2x [1x2 Technic Brick]

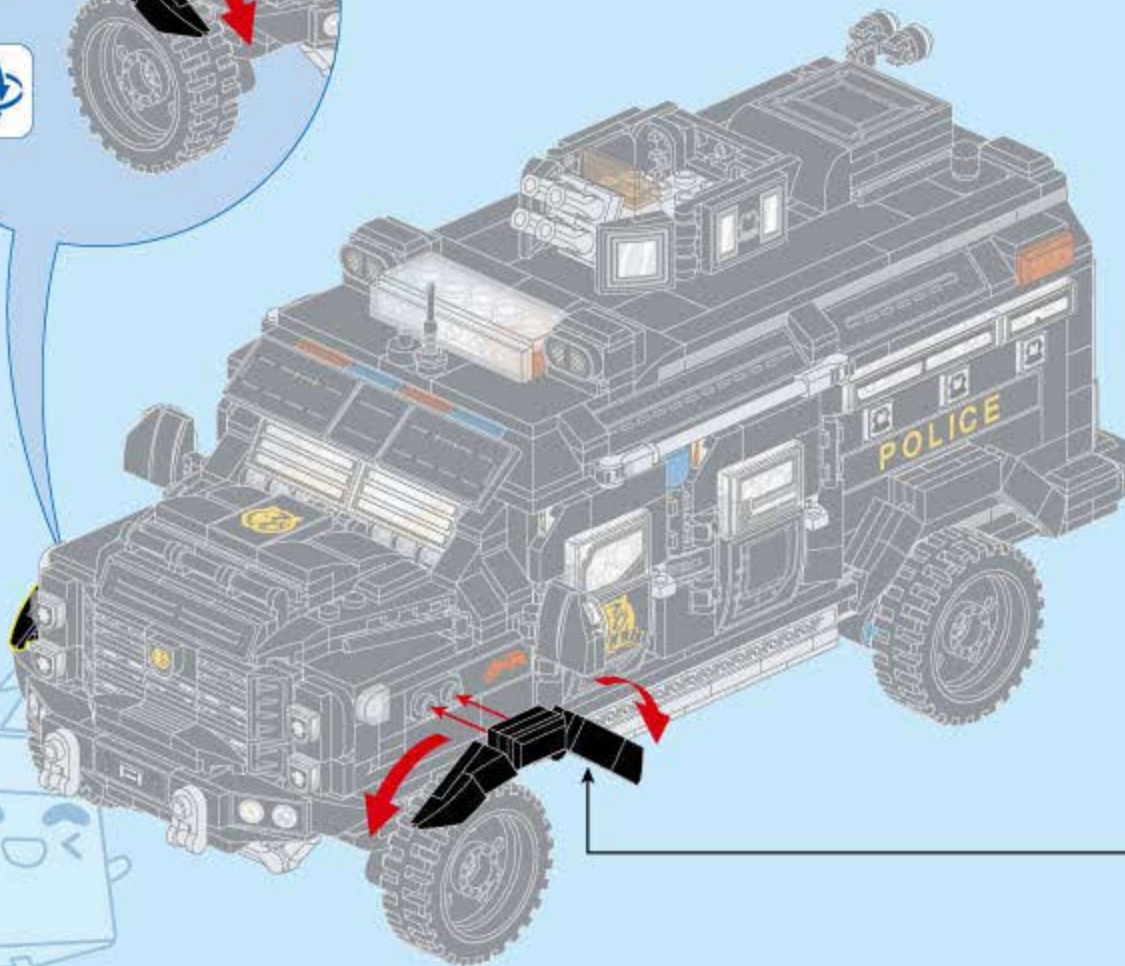
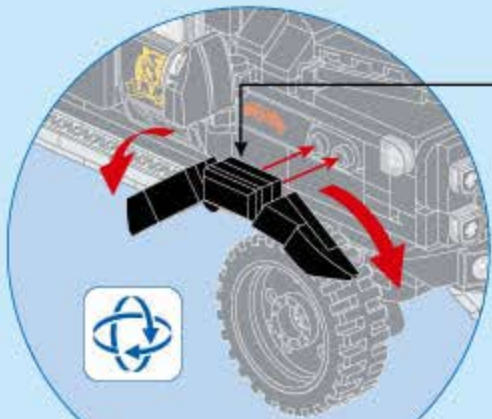

1

2

3

4

1

2

3

4



# 灯光玩法： Playing Method:

