



抗疫天使

PCS
294



DZ0126



品牌理念

随着信息社会的快速发展，电子产品的普及，导致一些社会问题。父母没有时间陪孩子，导致孩子玩手机打游戏，对学习不感兴趣，造成孩子近视、叛逆、缺少童年乐趣；积木能锻炼孩子的专注力，培养孩子的空间想象能力，手脑协调能力，锻炼孩子的耐心细心。减少孩子对电子产品的接触，对孩子智力开发有帮助，重要的是可以促进亲自之间的互动。

小萌鸡日记品牌不仅是积木，它是会讲故事的积木；融合了插图、绘本、故事为一体，每一个颗粒都有一个故事，通过玩小萌鸡日记品牌积木了解中国历史，弘扬中国传统文化！

小萌鸡日记 会讲故事的积木

向世界 讲好中国故事！

致敬抗疫天使

五千年文化,三千年诗韵。

我们的文化从未断流。

抗击疫情,让我们认识了真正的英雄。

他们有:“遥知百战胜,定扫鬼方还”的决绝!

他们有:“谓我不愧君,青鸟明丹心”的赤诚!

他们有:“驱驰一世豪杰,相与济时艰”的担当!

他们有:“衣沾不足惜,但使愿无违”的执着!

他们有:“封侯非我意,但愿海波平”的纯粹!



致敬以生命赴使命、用挚爱护
苍生舍小我顾大局抗疫英雄们!

这一战,你矗立在死神和患者之间!

那一晚,我们用血肉筑成新的长城!

2020年新春伊始,一场猝不及防的肺炎疫情席卷全国大地。在全国上下抗击新型冠状病毒感染的肺炎疫情战役中,有那么一群人毅然奔赴抗疫前线,是他们的坚守和付出,筑起了一道守护人民健康的防护线。他们是最美“逆行者”!在这场突如其来的战“疫”面前,一群“最美逆行者”没有退缩,逆风而行,迎难而上,为抗击疫情奉献力量、传递温暖。他们义无反顾的逆行,是最勇敢的坚守,是最温暖的守护,值得我们每一个人点赞和致敬!最美逆行者,肩负的是责任与担当,责任重于泰山、面对疫情,广大医护工作者,写下请战书,按下鲜红的指印,主动请缨,毅然奔赴这场没有硝烟的战场。

新时代最可爱的人





他们手挽手、肩并肩,冲锋陷阵,为抗击疫情、稳定局面默默无闻奉献着,正是这些抗疫英雄们,用义无反顾的行动诠释着责任与担当!用执着和坚守诠释着“爱的奉献”诠释着“大医精诚”!

他们都是新时代最可爱的人、最可敬的人!
他们守护的是生命和希望!传递的是信心与力量!
他们无愧于“英雄”称号

**疫情就是命令
防控就是责任**



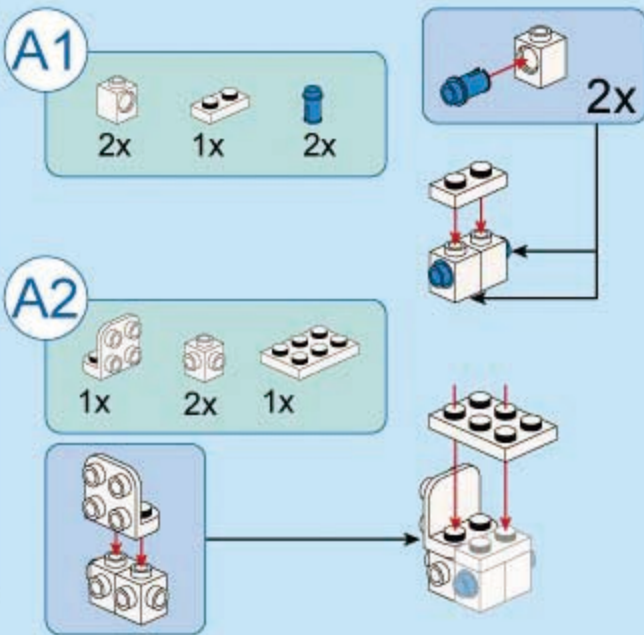
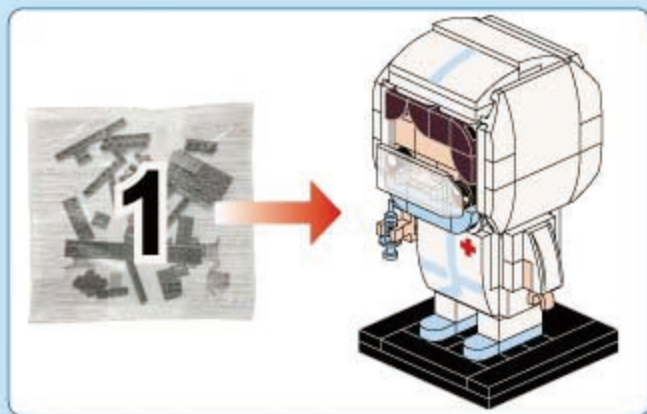

在抗击新冠肺炎疫情的战斗中，“天使”们白衣执甲，逆旅出征。你辛苦忙碌的身影，伴随着患者从黑夜直到天亮；你替代了家人的角色，用细致温柔的护理，让无数人看到希望。

A3



1x



2x

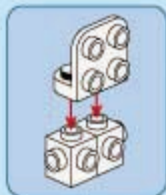

A4



2x



1x



2x

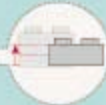

1:1

1

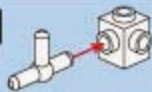

2

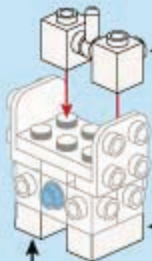

2x



疫情来临时，肩上的责任和入警时的铮铮誓言，让全国各地医护人员毅然投入到疫情防控的阻击战中。他们守一道卡，护一城人；他们迎难而上，通宵达旦；他们心中有责，不畏艰险，不断抗击疫情最前沿，处处有他们温暖而坚定的身影。

A5



1x



1x

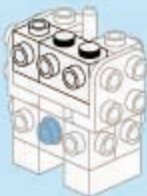

A7



1x

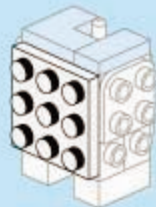

A6



1x



1x

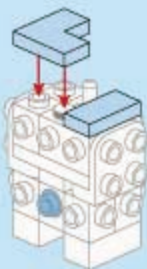

A8



1x

3x3

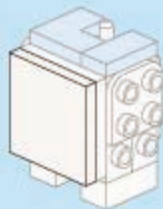

在这些基建工人没日没夜的努力下，武汉火神山医院终于在10天后验收通过，总建筑面积为3.39万平方米，可容纳床位700-1000。正常情况下这样体量的医院至少需要两年工期。

A9



1x

1x

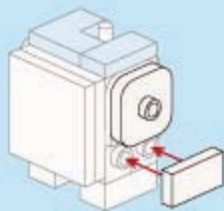

A10



1x

1x

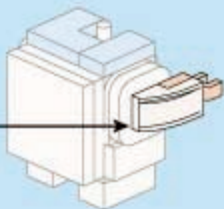

A11



1x

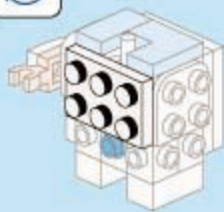

A12



1x

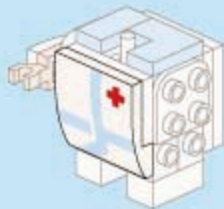

疫情近400万名城乡社区工作者奋战在65万个城乡社区的疫情防控一线，平均6个社区工作者守护着一个社区，每名社区工作者面对350名群众。社区工作者是守门员、配菜员、心理辅导师、维修工一人身兼数职，每天面临的感染风险远超普通民众，超负荷工作更是常态。

A13



2x



1x

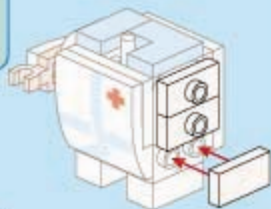

A14



1x



1x



1x

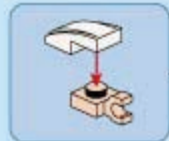
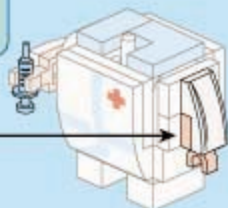

A15



2x



1x



全国各地的志愿者同心协力、辛勤值守，为各地区的疫情防控工作增添了不少力量，让市民感受到了城市的温暖。志愿者们参与体温测量、人员排摸、隔离安置、防疫宣传、楼道消毒等等一系列志愿活动

A16

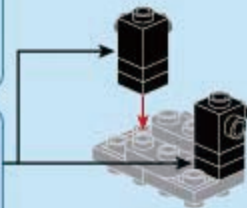

A17



A18



A19

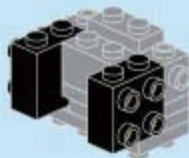

中国工程院院士，再次临危受命，挂帅亲征，敢于发声，家喻户晓，一声号令，全民不动，是一位院士，也是一位战士，更是一位国士。

A20



2x

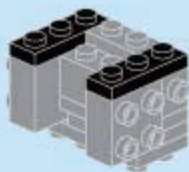

A21



1x



1x

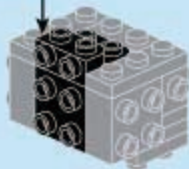
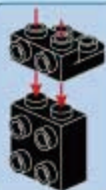

A22



1x



1x



A23



1x



2x

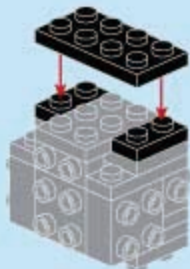

李兰娟

中国工程院院士，对打赢这场战役都有着不可磨灭的功勋，第一个提出“武汉封城”的人，奋斗在抗疫一线，呕心沥血，带领团队研发疫苗。

A24



2x



2x

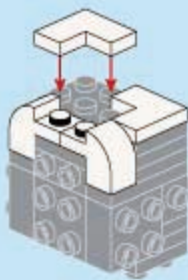

A25



1x

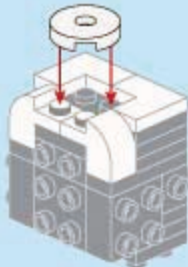

A26



1x



1x

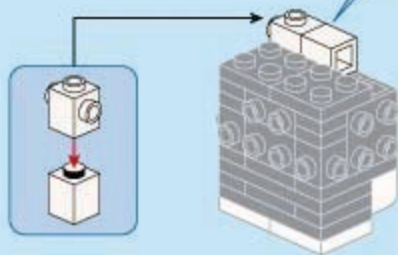
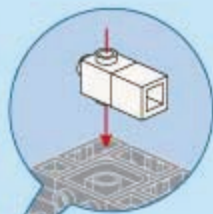

中国工程院院士，生化专家，病毒终结者，缩短核酸检测时间，加快了确诊速度，为抗疫做出重大贡献。

A27



1x



1x

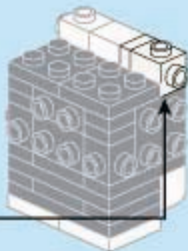
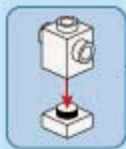

A28



1x



1x



A29



1x



1x

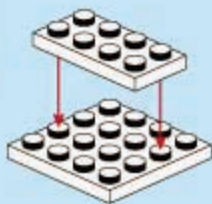

A30



1x



1x

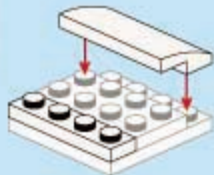

张文宏

上海市医疗救治专家组组长、复旦大学附属华山医院感染科主任，更像是一个医术高超的心理治疗师，他在和人们调侃的同时医治着疫情带给人们心灵的创伤，“最有效的药物是什么？人的免疫力”“你在家隔离也是战士，病毒都给你闷死了”，“都在歌颂医生，完整说法应该是医护人员”。

A31

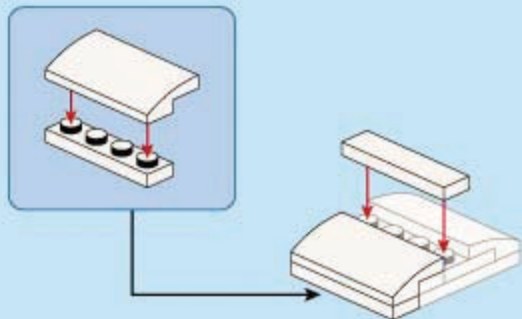
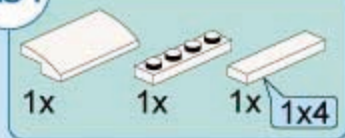

A32

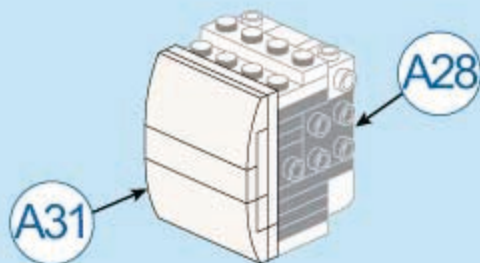

A33

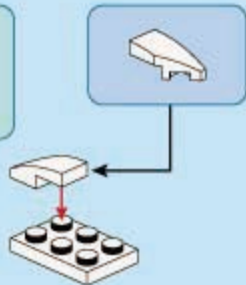

武汉市中心医院医生，疫情上报第一人，奋战在抗疫第一线，急病人所急，“我这次把一生的眼泪流光了！”

A34



1x

1x



A36



1x

1x

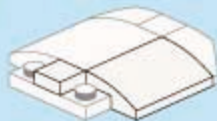

A35



1x

1x

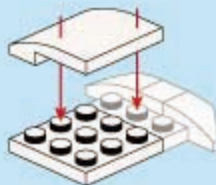

A37



1x

1x

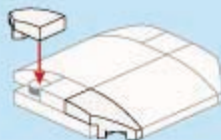

王辰

中国工程院院士，国内首屈一指的呼吸病学与危重症医学专家，与钟老齐名，大胆提出建设方舱医院的设想，让武汉在短短24小时之内，迅速建成3所“方舱医院”，增加了4000多张床位，是火神山医院床位的4倍还多。

A38

A32

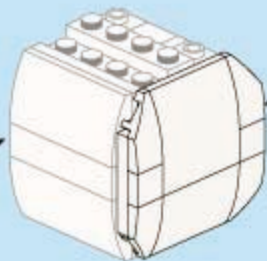

A37

A39



1x



2x

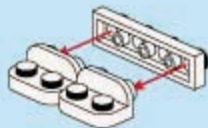

A40



1x



1x



A41



1x



1x



1x

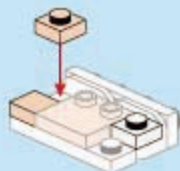

张佰礼

中国工程院院士，发挥中医药独特优势，提高了中度和轻度病人治愈率，降低了重度和危重病人死亡率。

A42

1x 3x

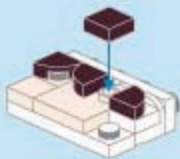

A43

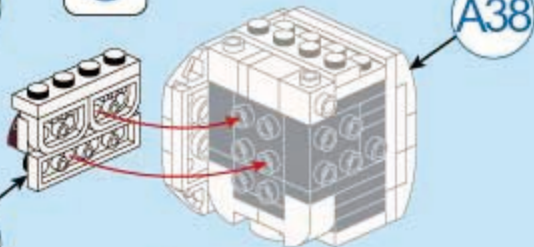

A38

A42

A44

2x 1x



A45

2x 1x



张定宇

武汉市金银潭医院院长，疫情狙击手，身患渐冻症依然战斗在抗疫一线。“我必须跑得更快，才能跑赢时间；我必须跑得更快，才能从病毒手里抢回更多病人。”这位硬汉、这位狙击手眼中只有一个目标——新型冠状病毒，狙击、狙击、再狙击。

A46



A47

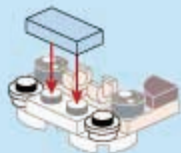

A48



A49

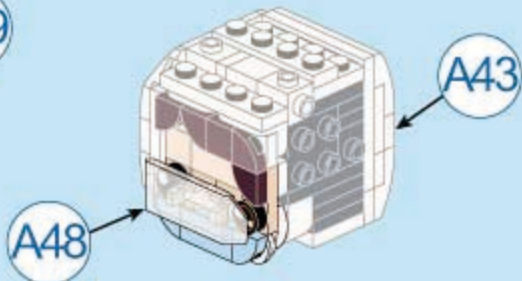

张思兵

武汉火神山医院院长，解放军总医院卫勤部部长。2003抗击非典年他和他的医院做到了三个“零感染”，援建小汤山医院，这次抗疫临危受命，他要把救治流程搞好，因为流程很重要。

A50

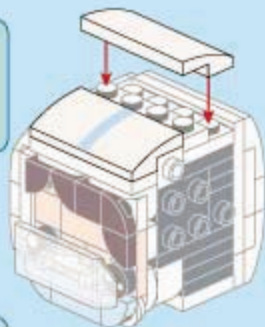

A52



A51

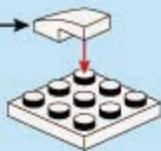

A53

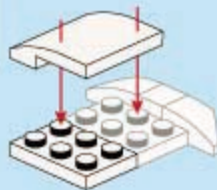

王行环

武汉雷神山医院院长，武汉大学中南医院院长。“一切为病人着想”，是王行环的座右铭。“尽量针对不同的病人制定不同的方案，做到因人而异、个性化治疗。”截至2月16日，雷神山医院收治患者总人数近600人。

A54



1x

1x

A55



1x

1x

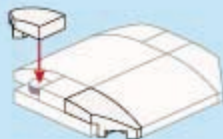
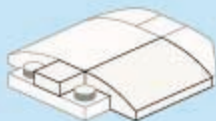

A56

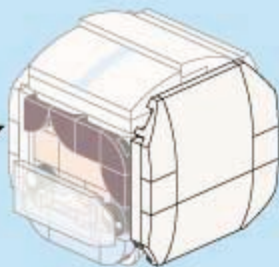

A55

A50

A57



1x

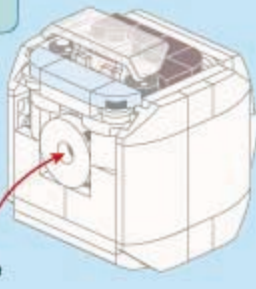

单霞护士

武汉大学人民医院护士单霞为了节约穿防化服的时间，在奔赴一线工作前就将自己的长发剃光，她说头发可以再长，而现在最重要的是要保护那些需要保护的人。

A58



A57

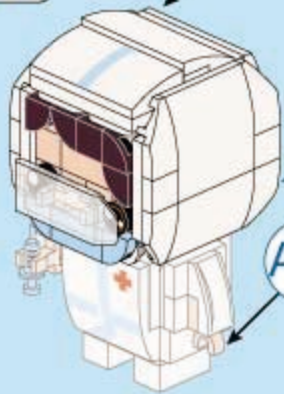
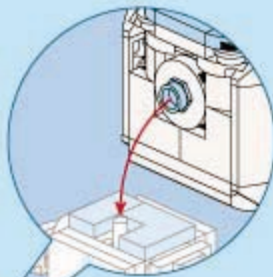

A14

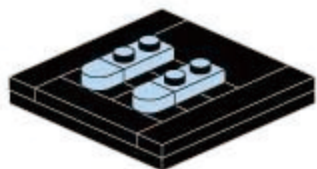

A59



1x

6x6

1x

2x4

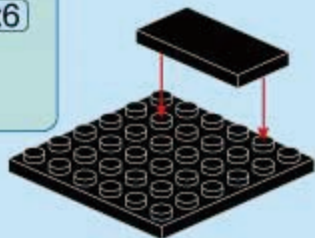

新闻记者

用镜头和文字，传递世间的一切。中国记者这个特殊时期，几乎所有人都闭门不出，却有一群人和医务工作者共同逆流而上，不论何时，他们时刻像战士一样，以冲锋的姿态战斗着。

A60

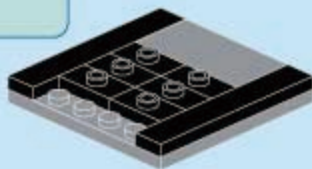

A61

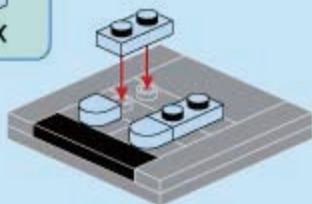

A62

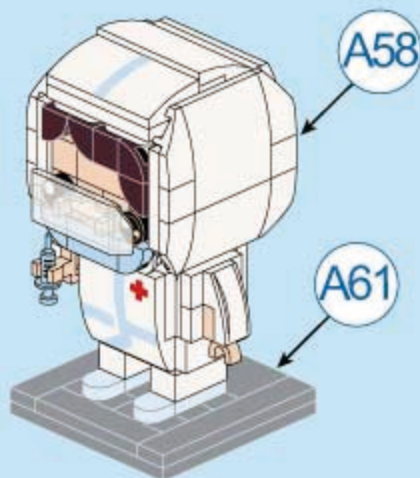

医务人员已夜以继日、连夜奋战在疫情防控的第一线，一些医务人员不幸感染，有的医务人员不幸献出了他们的生命，他们的工作体现了敬佑生命、救死扶伤、甘于奉献、大爱无疆的崇高精神。

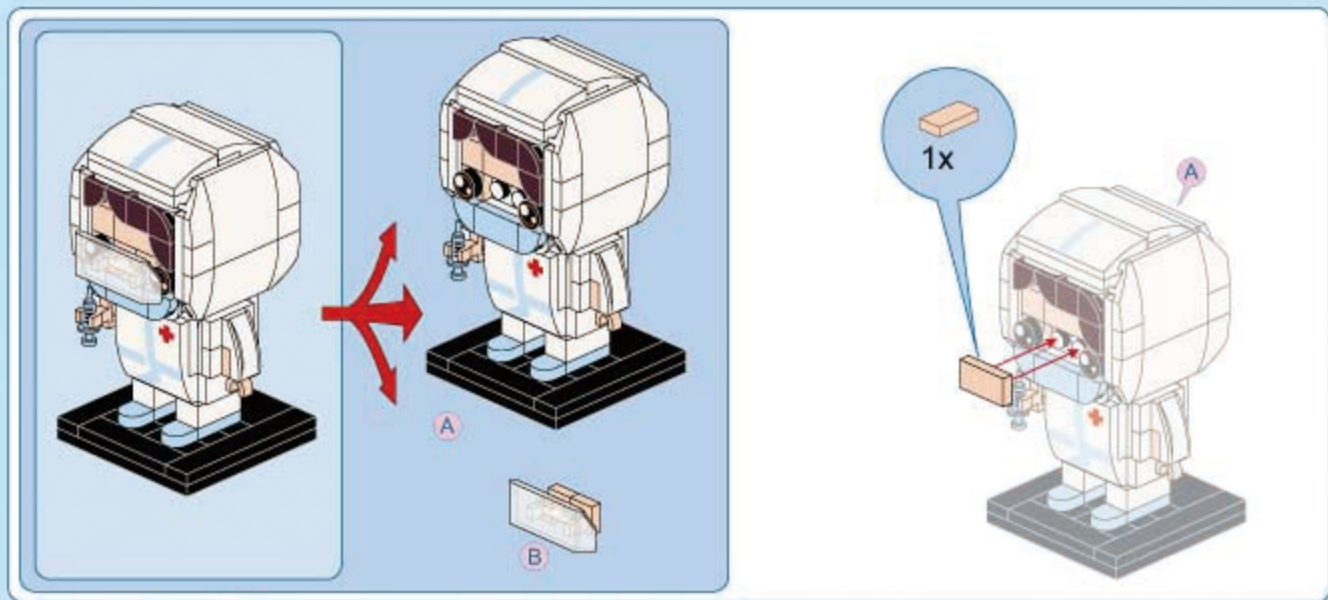

有一群被忽略的逆行者，他们出现在疫情站的第一线；在疫情严峻的形势下，人们的生活仍要继续，正是这群特殊群体——物流司机，用日复一日的坚守执著，连接着人民生活的血脉，输送着人民生活的必需物资。

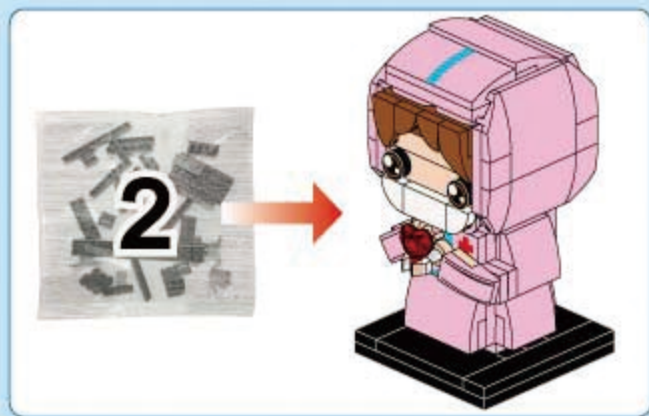

B1



1x



1x

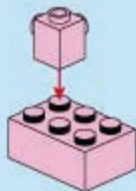

B2



1x



1x



自疫情防控阻击战打响以来，众多快递小哥成为“逆行者”，他们戴着口罩、头盔，骑着电动车，奔跑在城市的各个角落，保障居民日常生活物资配送，满足医院和市民的日常所需

B3



2x



1x



B5



1x

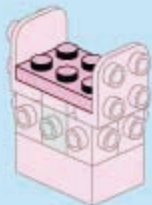

B4



2x



1x

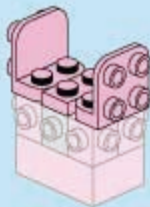

B6



2x



1x

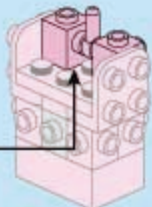

湖南一农民一次性捐出15000只医用口罩，而这批口罩的“货源”让人意外。这位农民称他曾在一家口罩生产工厂务工，后来工厂效益不好辞职了。当时工厂发不出工资，就给了他这批口罩用以抵工资。

B7



1x



1x

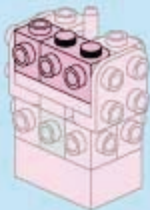

B8



1x



1x

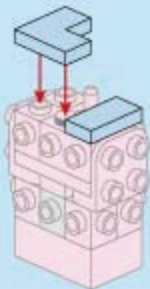

B9



1x



1x

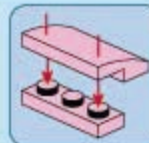

B10



1x



1x

2x3

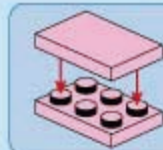

春节假期，环卫工人照常出勤、加倍付出，守护城市环境和万家团圆。而突如其来的疫情，给环卫作业带来量的增加，提出更加严格的工作要求。同时一线环卫工人不仅要自身防护和作业环境消毒，也要提醒广大市民做好防护措施。

B11

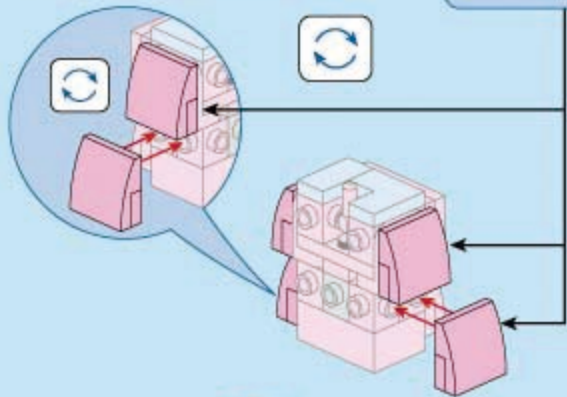
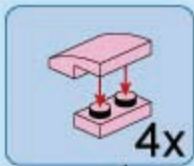

B12

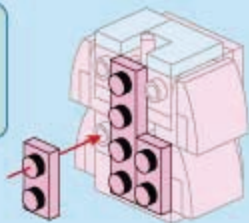
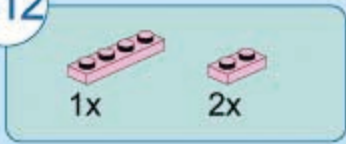

B13

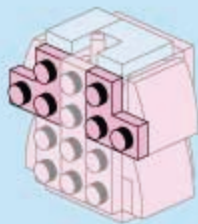

由于武汉爆发的新型冠状病毒肺炎疫情，这也导致举国上下处于严防状态，各地封村闭户，每个村口也都可以看到一个或者多个把守路口的工作人员，疫情期间为国家也做出了一份贡献。

B14



1x

1x

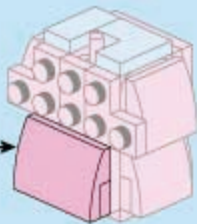
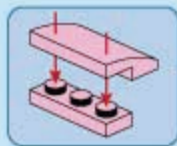

B15



1x



2x

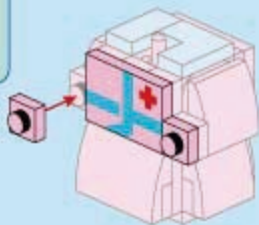

B16



2x



2x

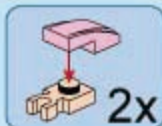

2x

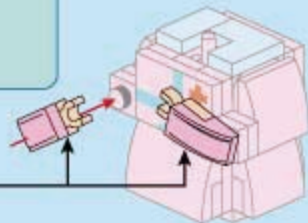

B17



1x



1x

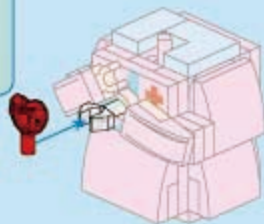

新型冠状病毒疫情牵动着全国上下的心，无数人为此付出努力甚至生命，众志成城争取早日战胜病毒迎来新一年的春日暖阳，很多出租车司机助力战疫情的公益行为，他们的付出同样值得铭记，他们的故事也让人感动或是揪心。

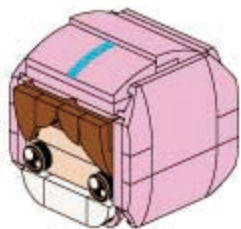

B18



2x



1x



B19



2x



4x



1



2



2x

2x

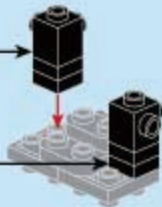

B20



1x



1x



在这个人人自危的时刻，他（她）们依然要站在柜台前，为前来购买双黄连，口罩白菜的人们热气的服务。商场饭店可以停，超市药店不能停。

B21



1x



1x



B23



2x



B24



1x



1x

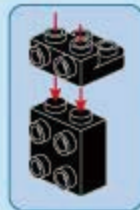

B22



2x

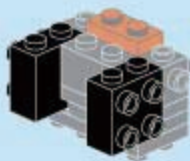

过年期间流动人口比较大，为了防止传染病毒，我们应该在家待着不出去聚会，不去扎堆，取消全部的外出活动，别出门“在家待着就是对社会最大的贡献”

B25



1x

1x



B26



1x

2x



B27



2x

2x

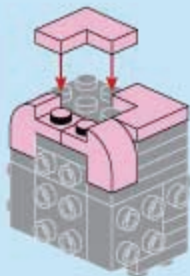

B28



1x

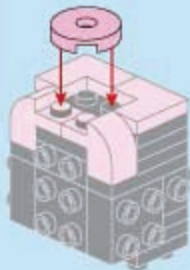

在第一时间组成抗击疫情一线最强大的物流服务团队，为武汉地区提供救援物资运输服务，向湖北武汉、黄冈等地各大医院运送医疗防疫物资。

B29



1x



1x

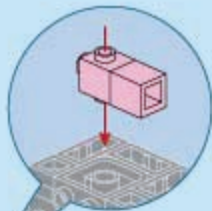

B30



1x



1x

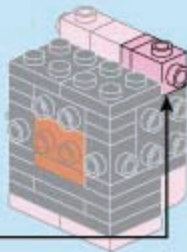

B31



1x



1x



海外华侨

新冠肺炎疫情爆发以来，世界各大洲华侨华人纷纷行动起来，积极参与疫情防控，大力支持中国抗击疫情。捐赠物资并开展募捐行动，全力支持中国抗击疫情。

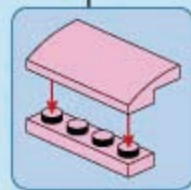
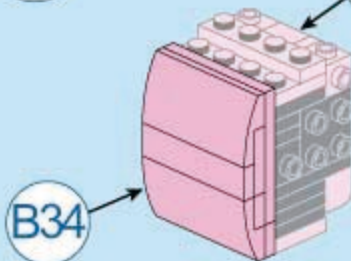
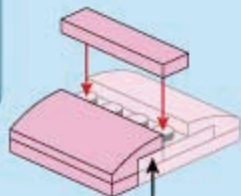
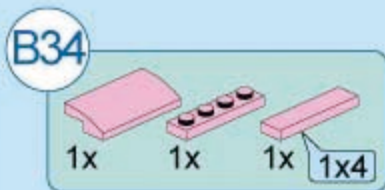
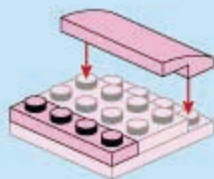
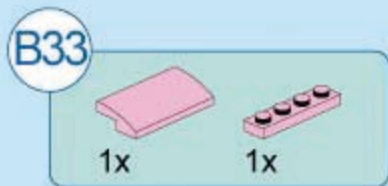
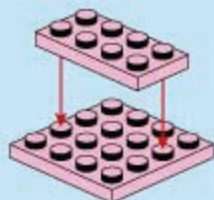
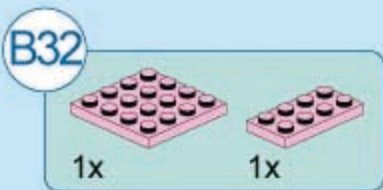

新型冠状病毒肺炎肆虐中国，世界多个国家、地区和国际组织输送医疗物资、提供资金支持，帮助中国抗击疫情。

B36



1x

1x

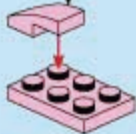

B37



1x

1x

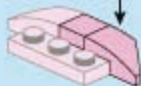

B38



1x

1x

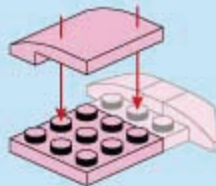

B39



1x

1x



在新冠肺炎疫情防控斗争中，我们敢于斗争，坚持人民至上，科学防控，加强国际合作，展现的中国精神成为众志成城、共克时艰的力量之本、信心之源，凝聚起抗击疫情的强大精神力量。

B40



1x

1x



B41

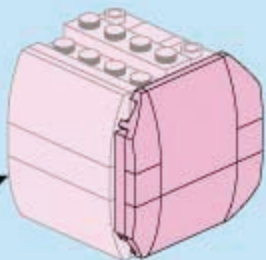

B40

B35

B42



1x



2x

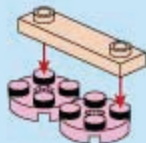

B43



1x



2x



疫情期间各路影视演员也都率先担起社会责任积极捐款捐物，向疫区捐款。全国上下都是有钱出钱，有力出力。无论多少，不论先后，艺人捐款体现他们的担当，更是一份爱心，利用号召力让更多人捐款支援武汉。

B44



1x



2x



2x



B45



B41

B44

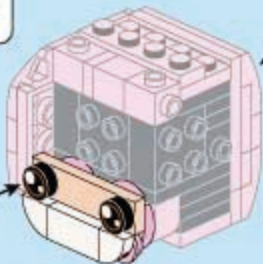

B46



1x



1x

1x4

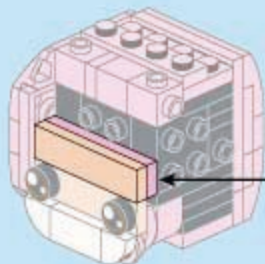
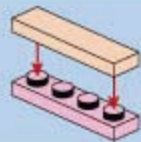

在新冠肺炎疫情防控斗争中，我们敢于斗争，坚持人民至上，科学防控，加强国际合作，展现的中国精神成为众志成城、共克时艰的力量之本、信心之源，凝聚起抗击疫情的强大精神力量。

B47

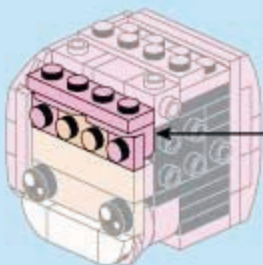

1

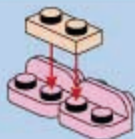

2

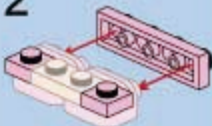

B48



1

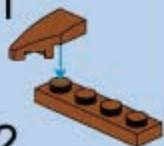

2

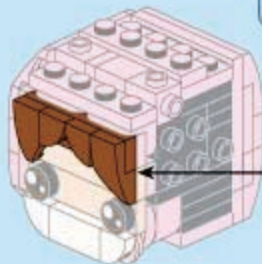

红十字会主动作为，靠前指挥、加强指导，第一时间对红十字会参与疫情防控工作进行周密安排部署依法履职勇挑重担。在疫情防控工作领导小组的统一领导下，成立了以主要领导为组长的疫情防控领导小组，建立快速接受发放绿色通道，搭建起社会参与群防群控的爱心平台，打响了一场全民参与的人民战争。

B49

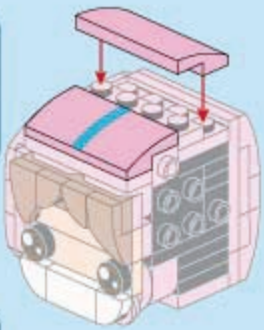
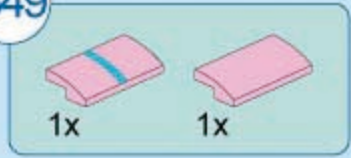

B50

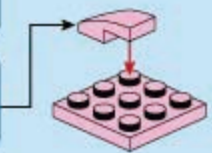

B51

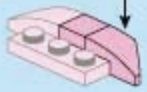

B52

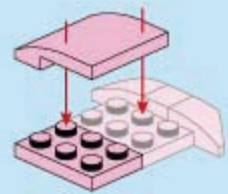

停课不停学！疫情虽然停课，但是老师也没得闲。居家学习，网络课程，已是一个全新的教学方式。这种教学模式对老师来说也是一种挑战，只为了让每一个孩子都能够上网课。隔离病毒，但不隔离学习。

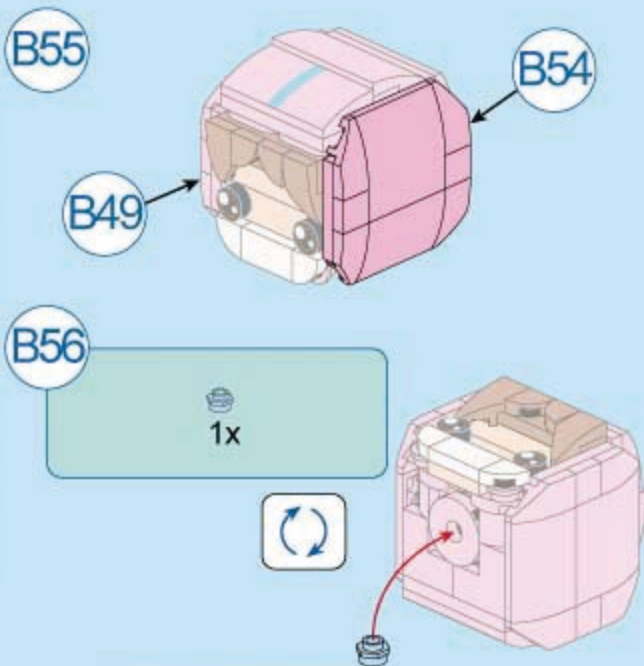
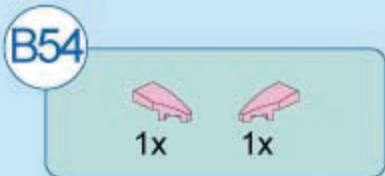
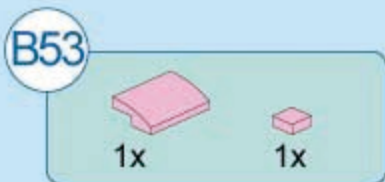

武汉的一家餐馆老板小邱因为在朋友圈中看到医护人员在这段特殊时期不能上热乎的饭菜而感到内心难受，因为自家就是经营餐饮的，因此对于医护人员表示自己愿意24小时为医护人员送餐，虽然店里面只有五个人，做出饭菜的分量也是有限的，但是他们愿意一直坚持下去。

B57

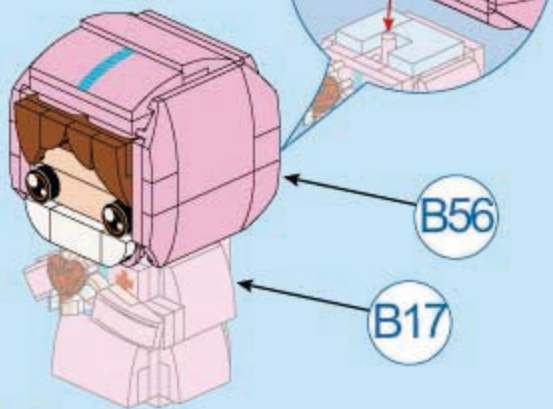

B56

B17



除夕的前一天。当家家户户门前代表祝福与喜庆的大红灯笼和对联还笼罩在黎明前的黑暗中时，武汉市疫情防控指挥部发布1号通告：自当日上午10时起，全市城市公交、地铁、轮渡、长途客运暂停运营；机场、火车站离汉通道暂时关闭。武汉“封城”！900多万人留在了这座被迫按下暂停键的城市之中。

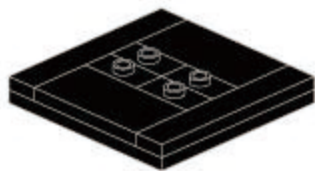

B58



1x

6x6

1x

2x4

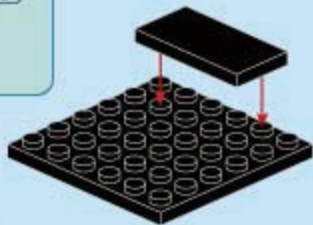

B59

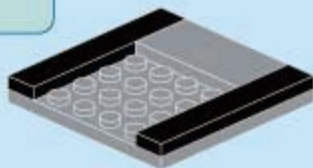
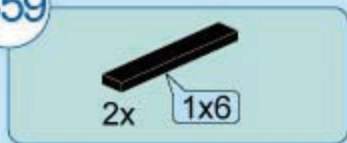

B60

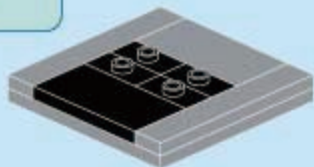
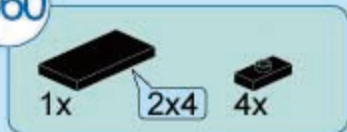

B61



春节是中国人最重要的传统节日，“回家过年”不仅是公认的年俗，也是中国人心中抹不去的情结，国务院应对新冠肺炎疫情联防联控机制综合组也下发了通知由政府出面倡议人们“就地过年”

安全防疫小知识





48mm

52mm

90mm

男医生



48mm

54mm

90mm

女护士