

KeepPlay

名偵探 **柯南**

© Goshō Aoyama/1996-2022 Shogakukan, YTV, TMS



**K20708**

图片仅供参考，请以实物为准。

**正版授权**

黑暗组织对决



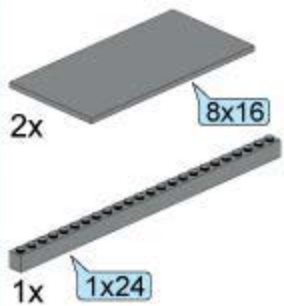

+



拆件器使用方法, 仅为示例

Usage of Brick Separator, Just for the sample

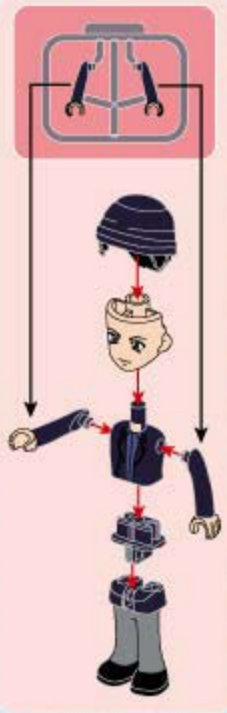
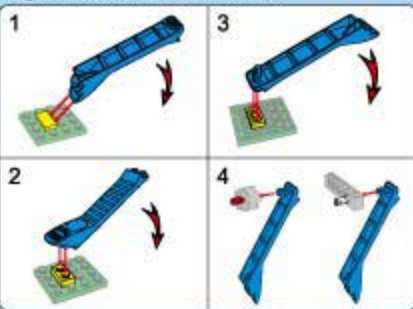

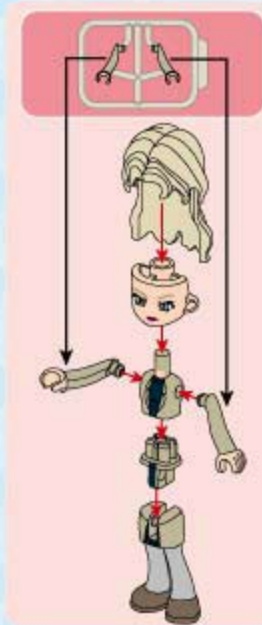
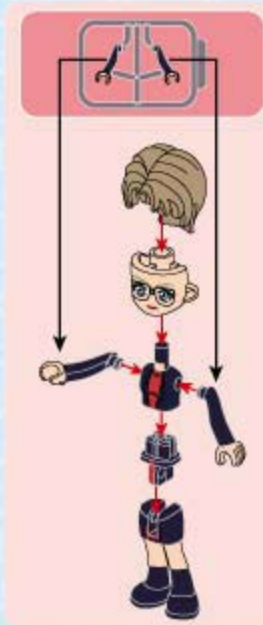

A1

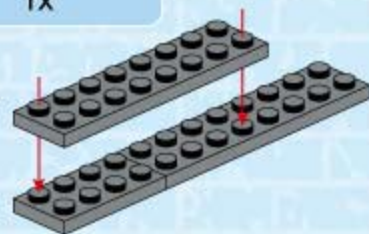
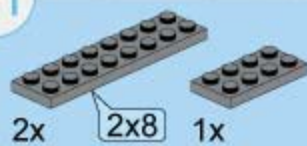

A2

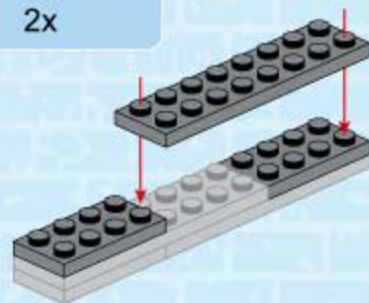
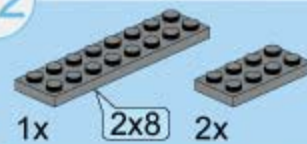

A3

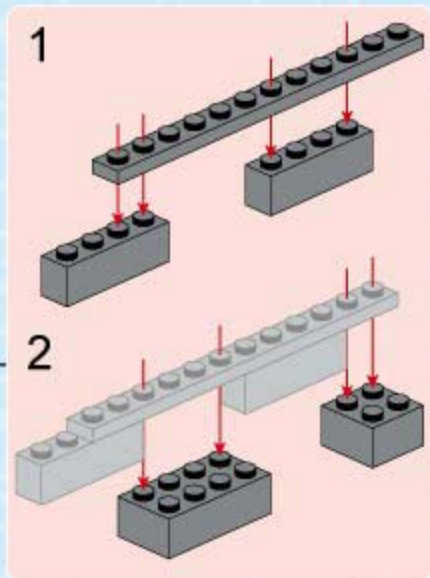
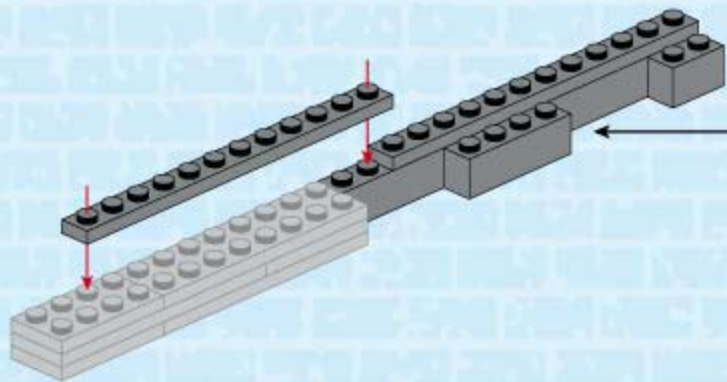
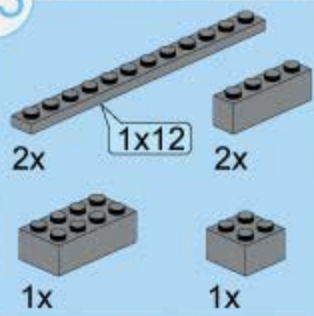

3

A4



1x



1x



1x

1x8

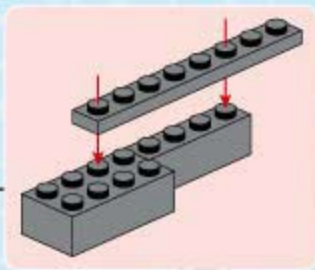
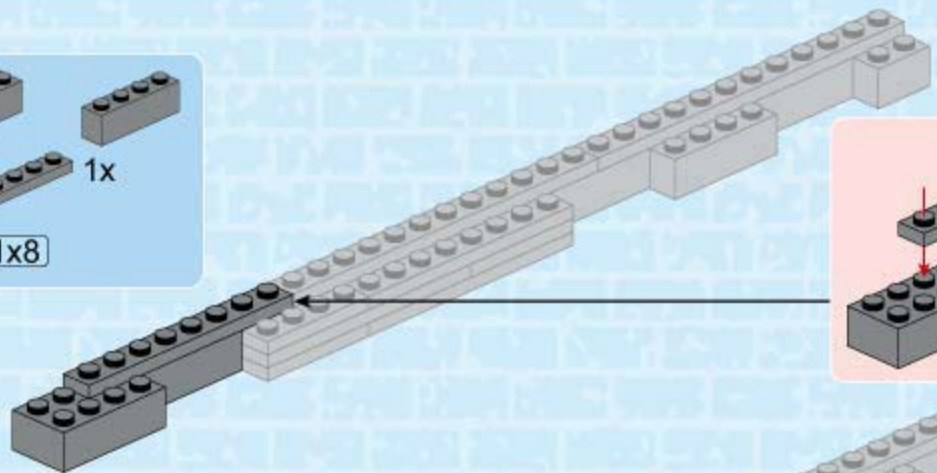

A5



1x

1x8



1x



1x

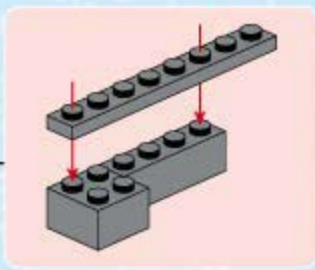
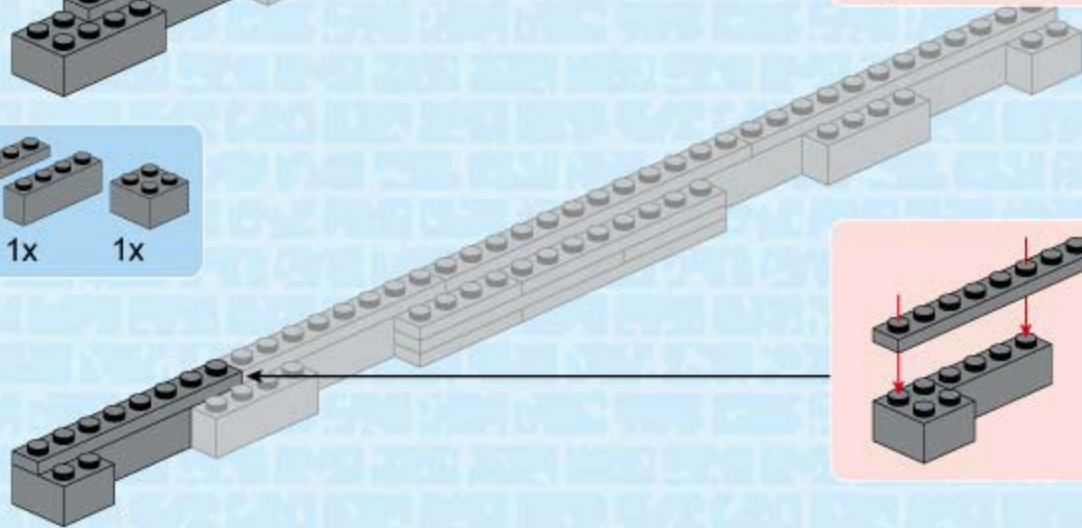

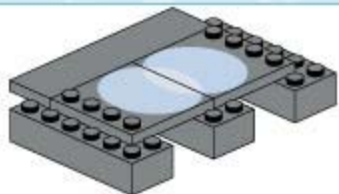

A6

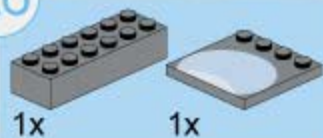

1x

1x

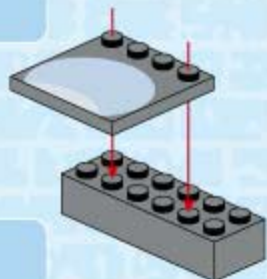

A7

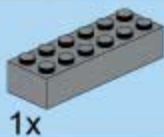

1x

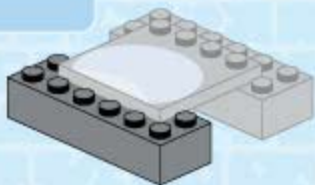

5

A8

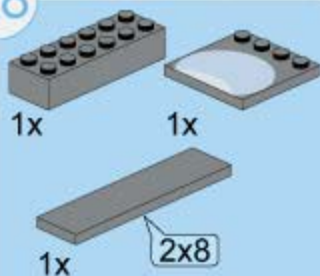

1x

1x

1x

2x8

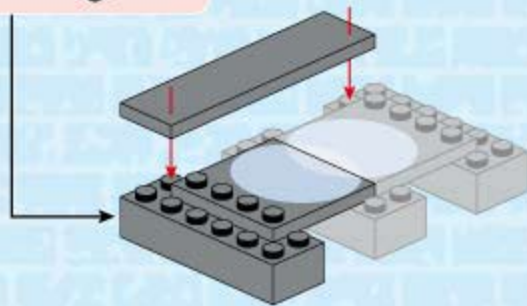
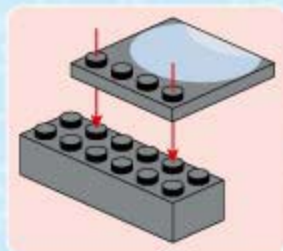

A9

A5

A8

A10

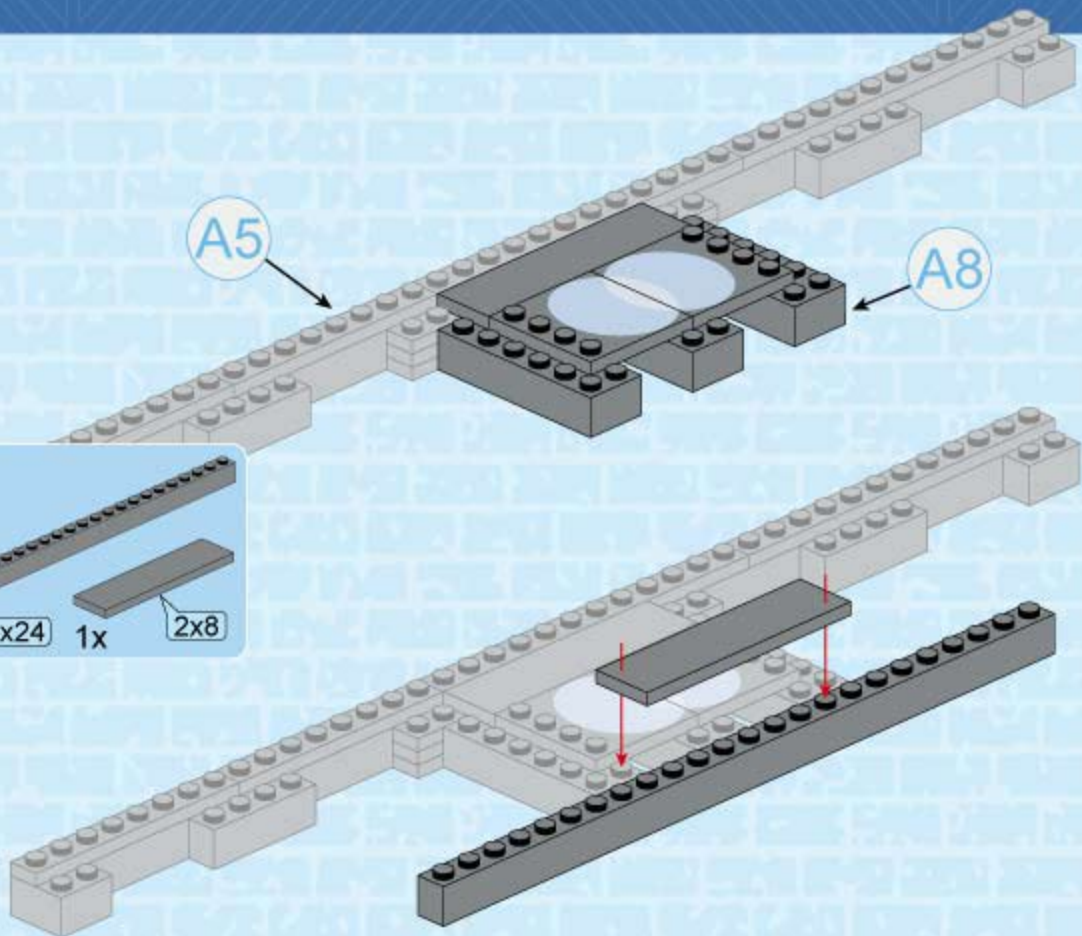
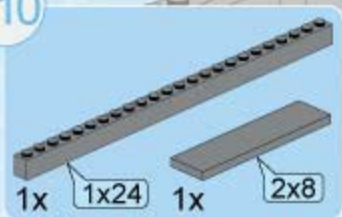

A11

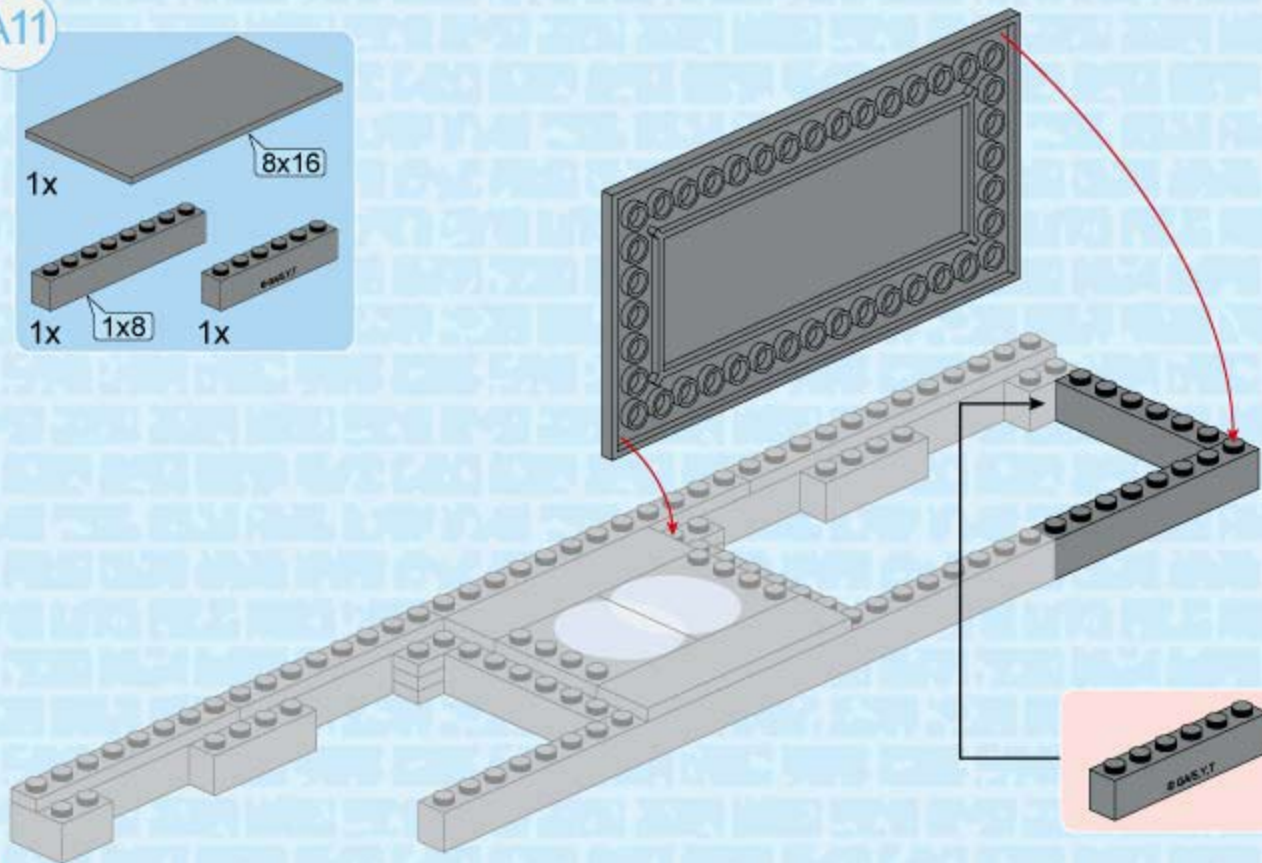
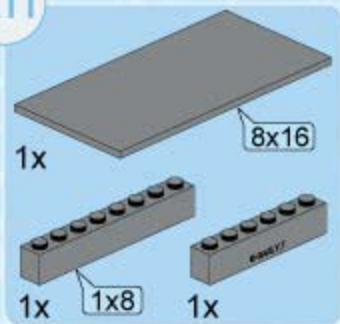

7



A12

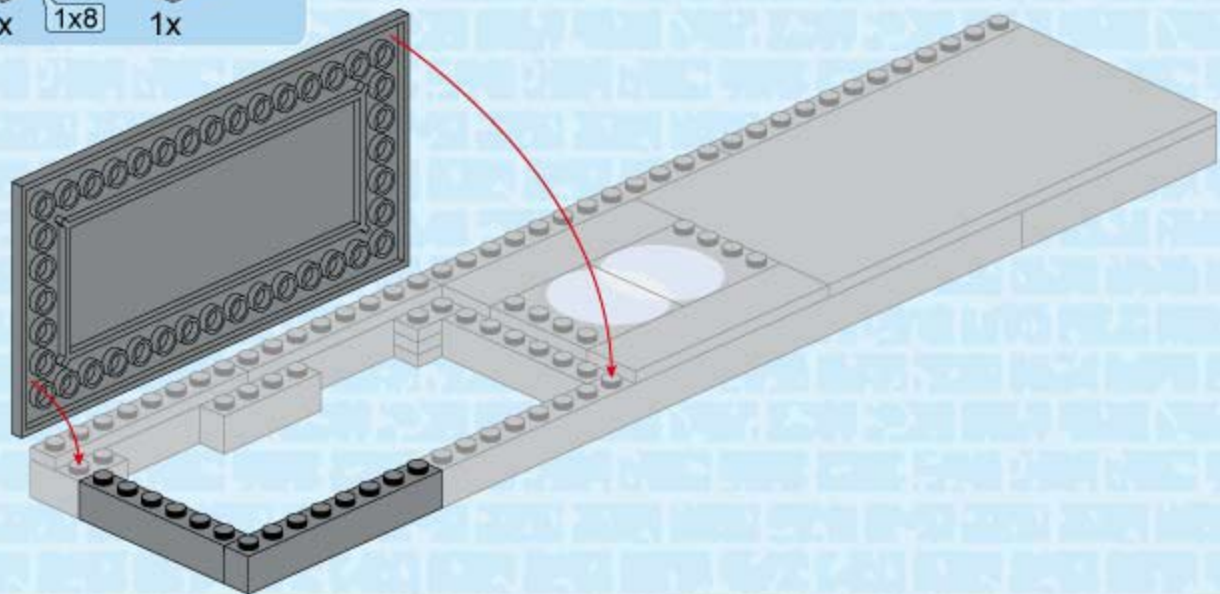
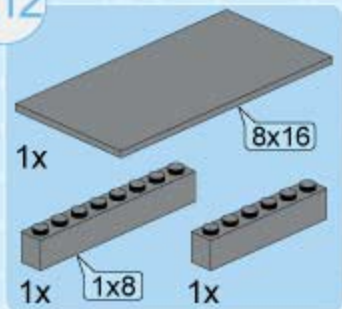



A13



1x



1x

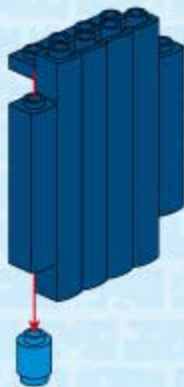

A14



1



2

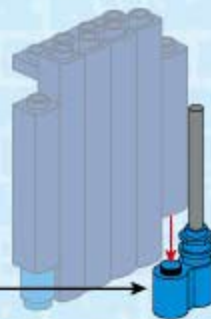
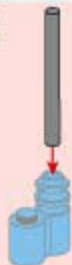

A15

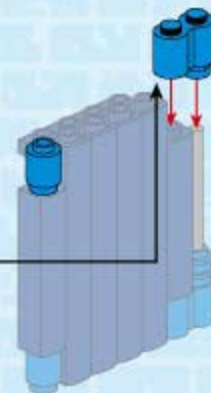
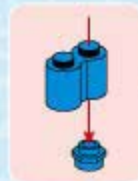

A16

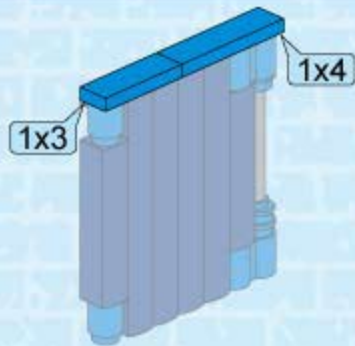
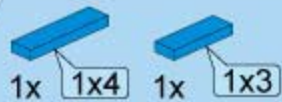

A17

A16

A12

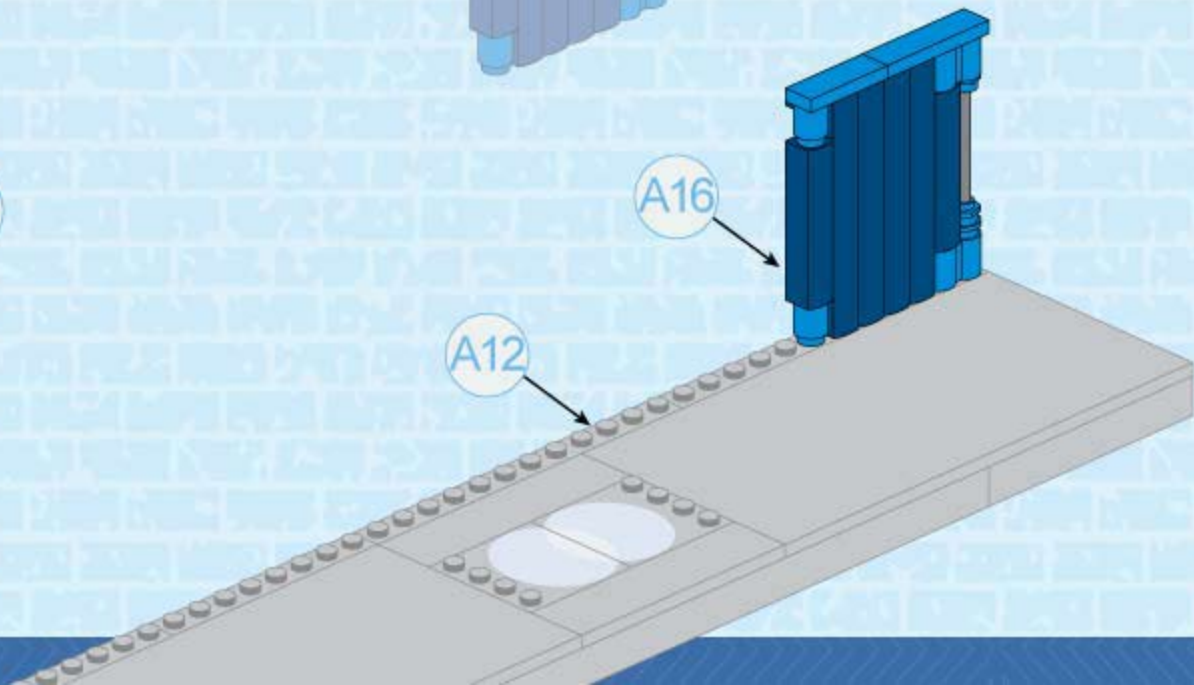



A18



1x



1x



1x

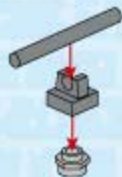

A19



2x



2x



2x

1



2



2x

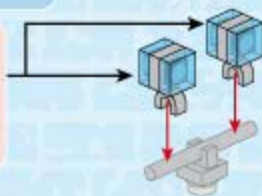

A20



1x



1x

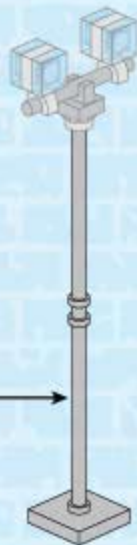
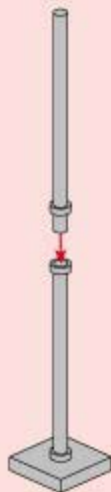

A21



1



2



A20



A17



A22



1x



2x

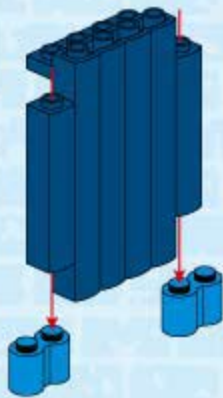

A23



1x



2x

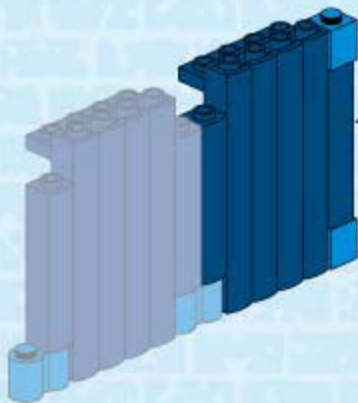
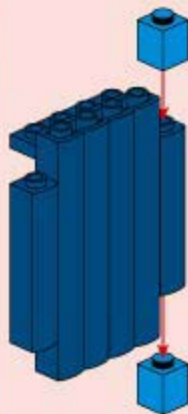

A24

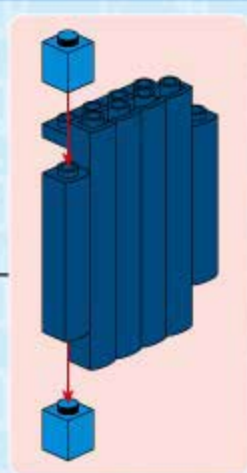
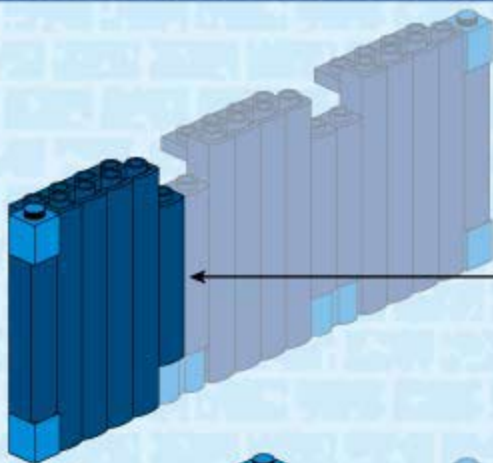
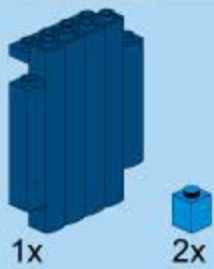

A25

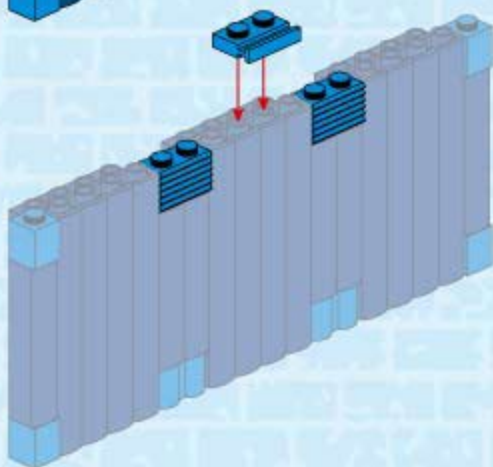

A26

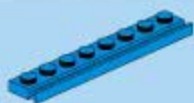

2x

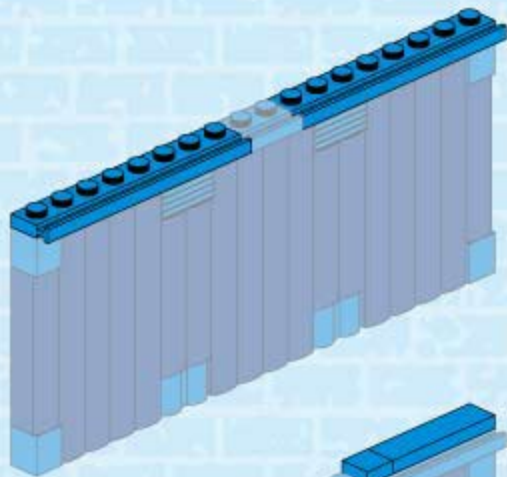

A27



1x

1x4



2x

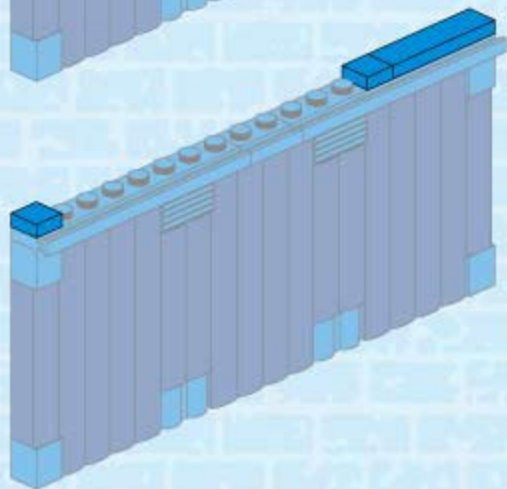



A28

A27

A21

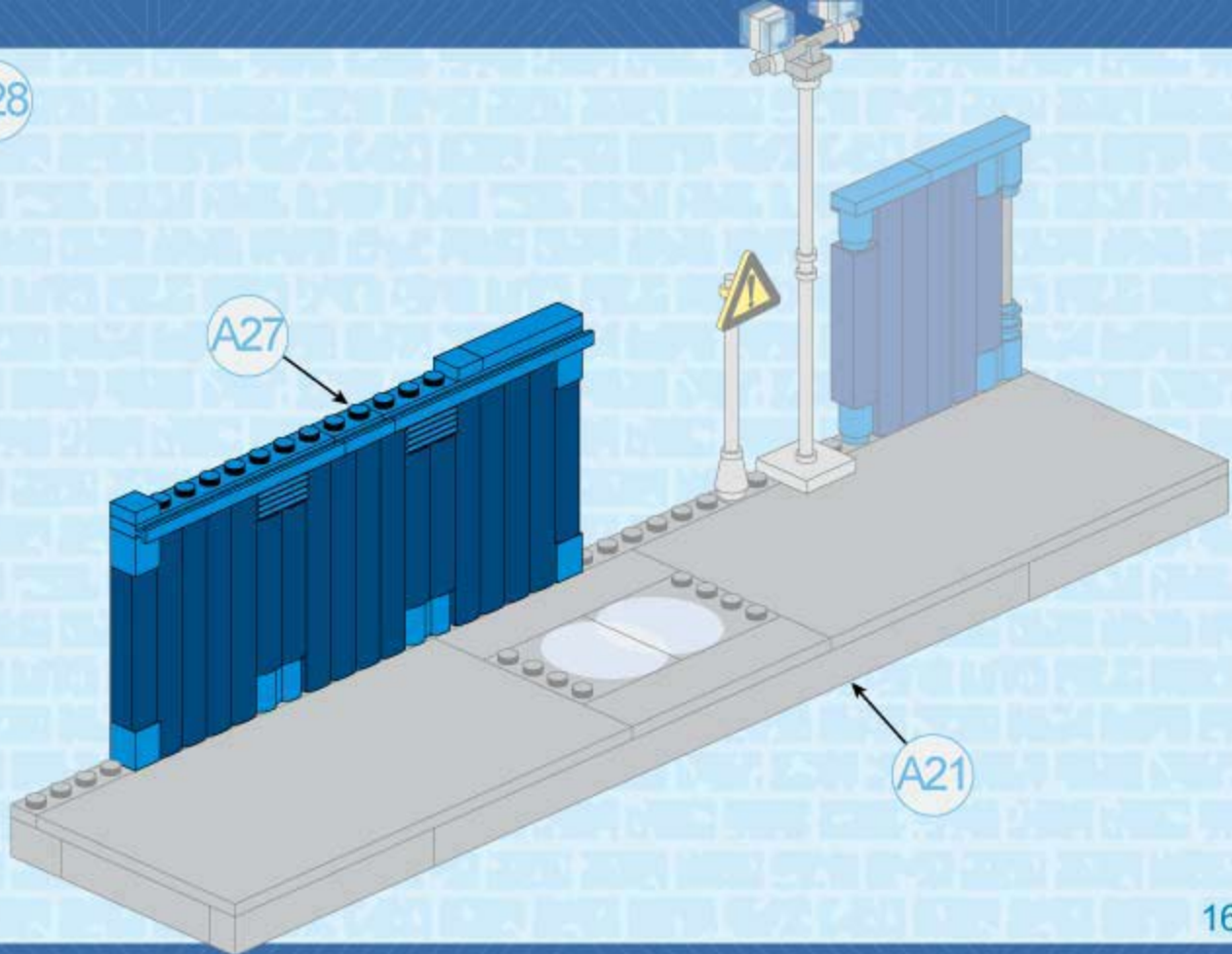



A29



1x



1x



1x



A30



1x



1x

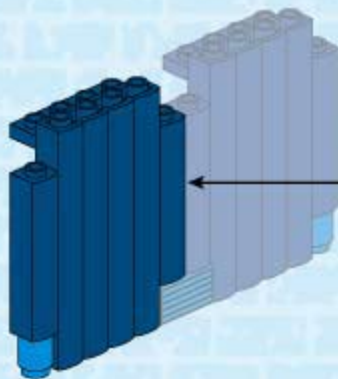
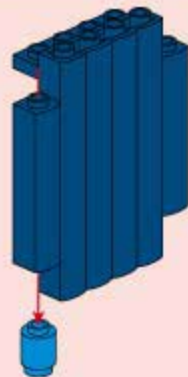

A31



1x



2x



1x

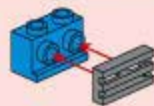
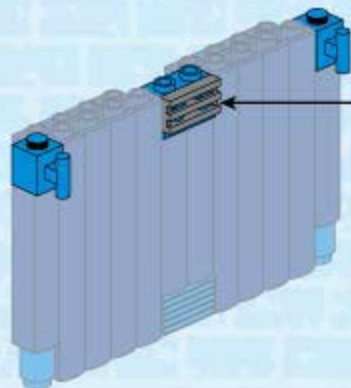

A32



1x

1x8



1x

1x4

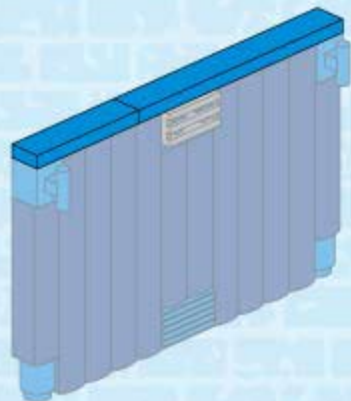

A33

A32

A28

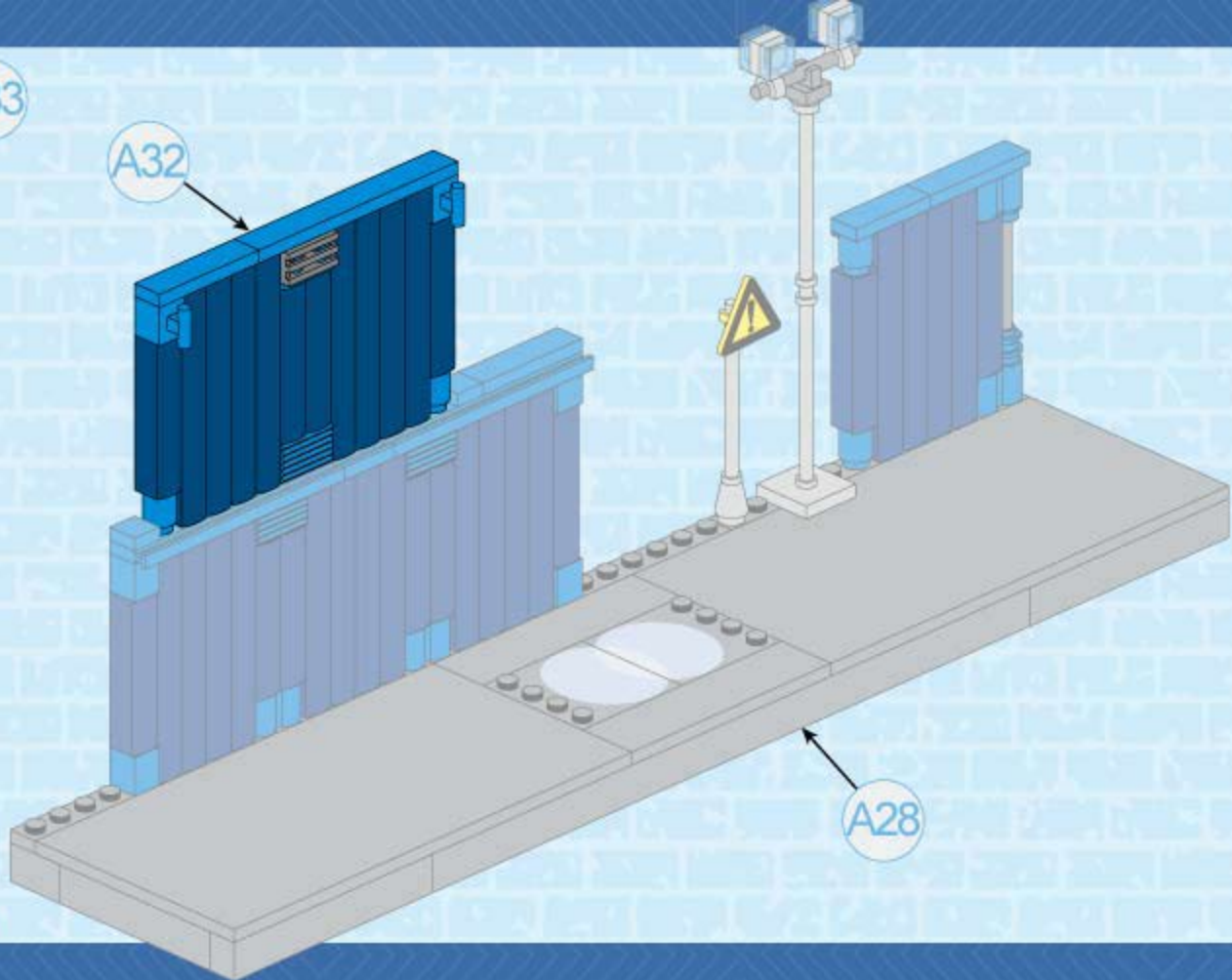



A34



1x



1x

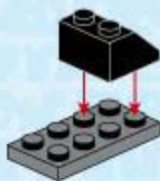

A35



1x



A36

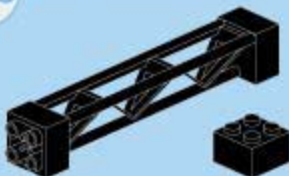

1x

1x



A37

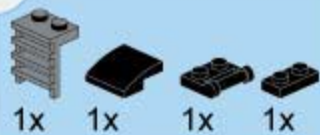

A38



A39

A38

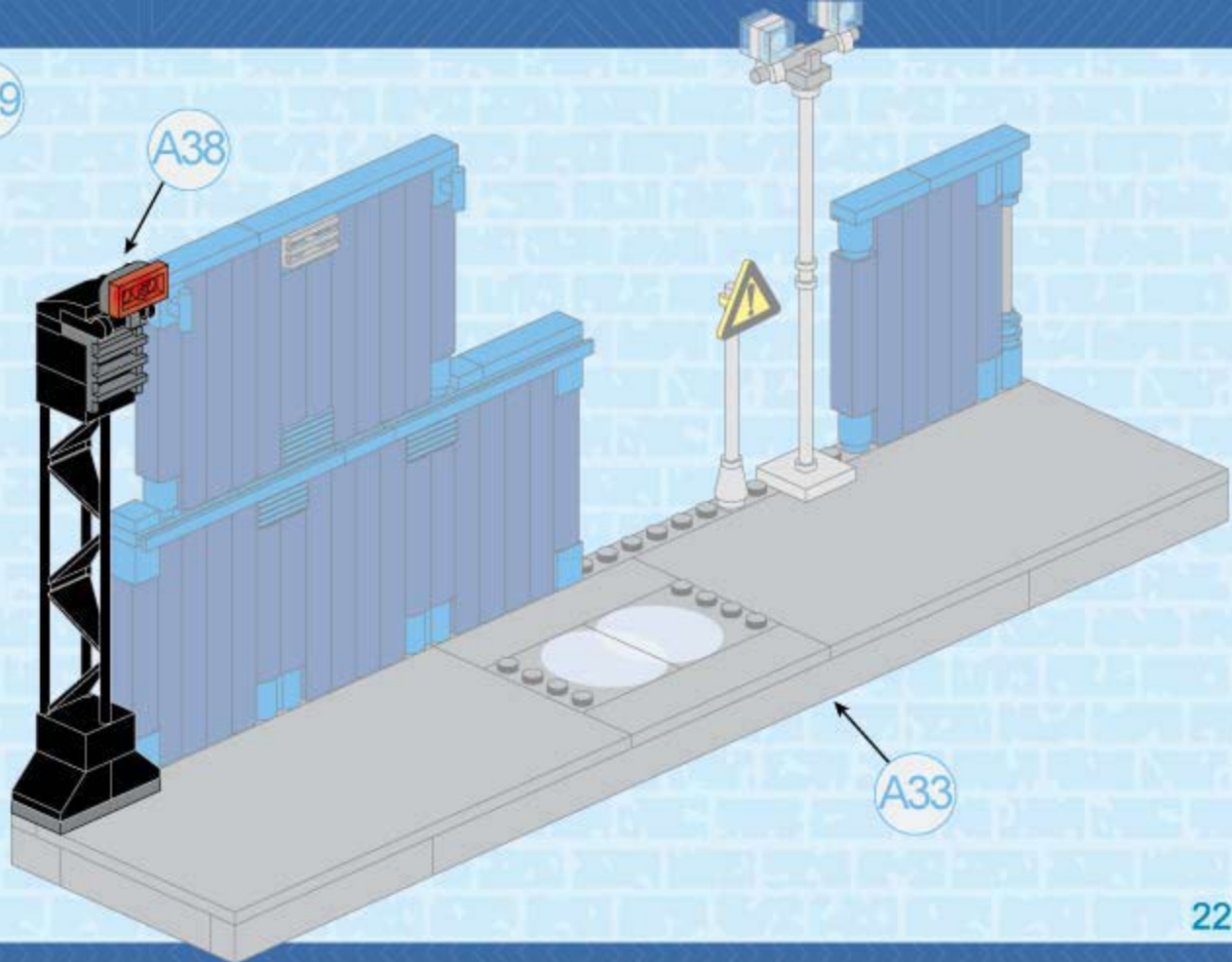

A33

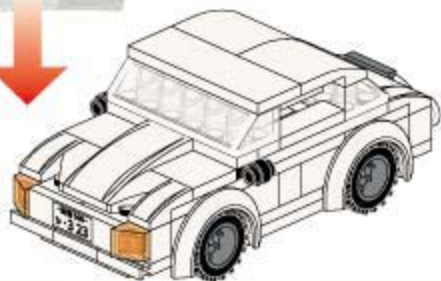

B1

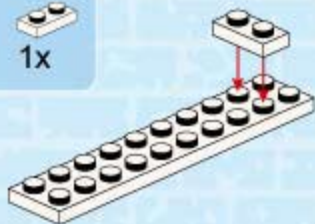
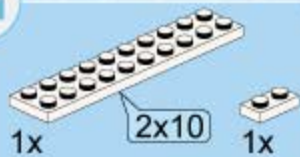

B2

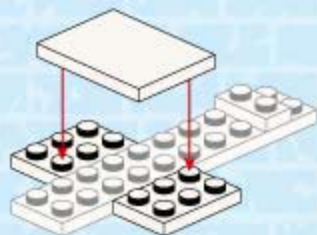

B3

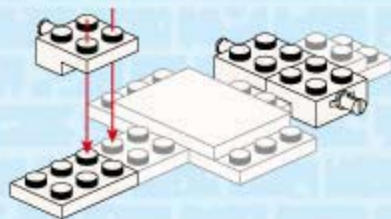



**B4**

1x

2x

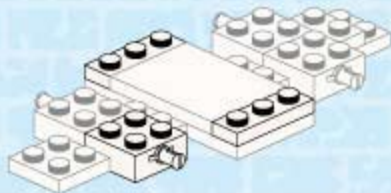
**B5**

1x

2x

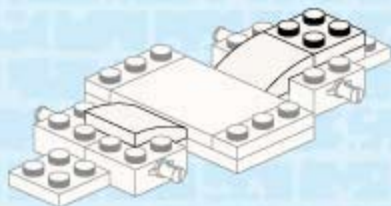
**B6**

1x

1x

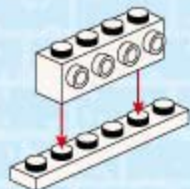
**B7**

1x

1x

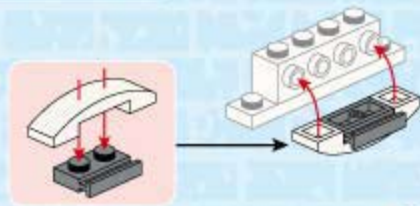

**B8**

2x



2x

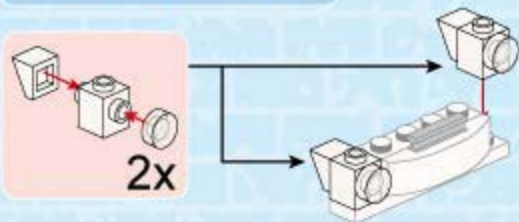
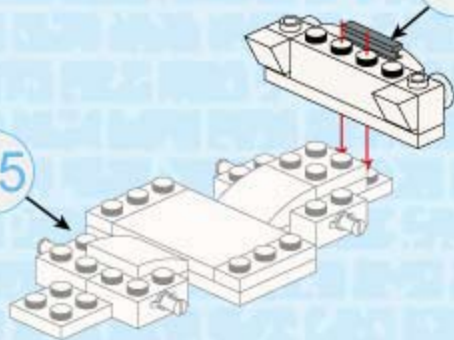

2x

**B9****B5****B8****B10**

2x

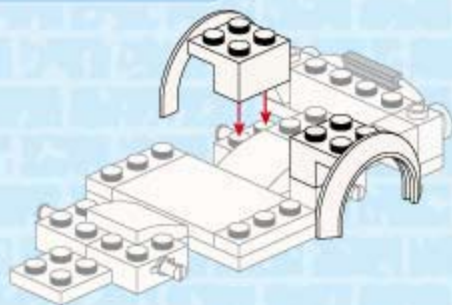
**B11**

4x



2x

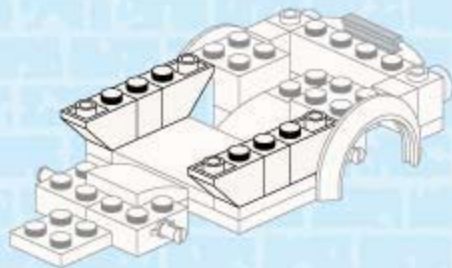

B12



2x

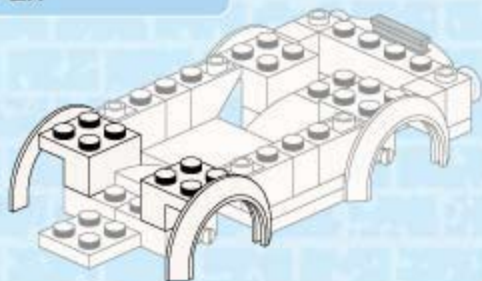

B13



1x



2x

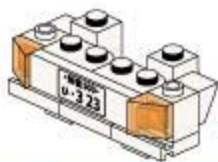
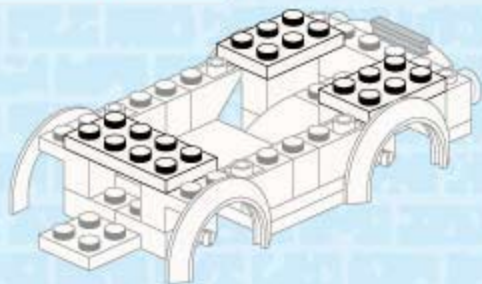

B14



1x



1x

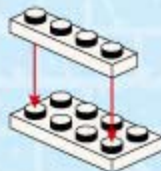

B15



1x



1x



1x

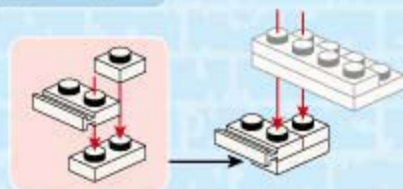

B16

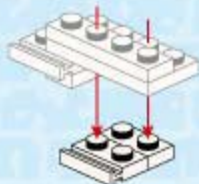

B17

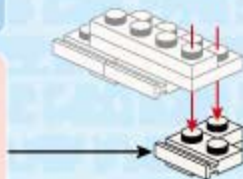
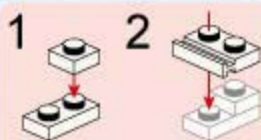

B18

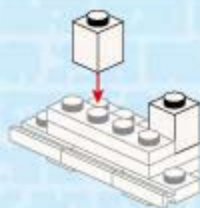

B19

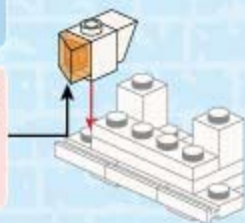
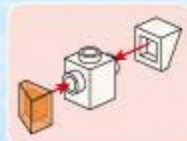

B20

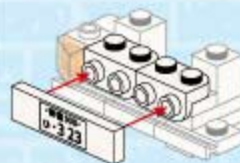

B21

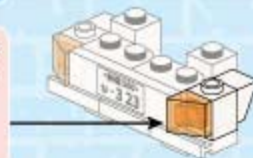
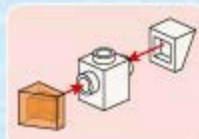

B22

B21

B13

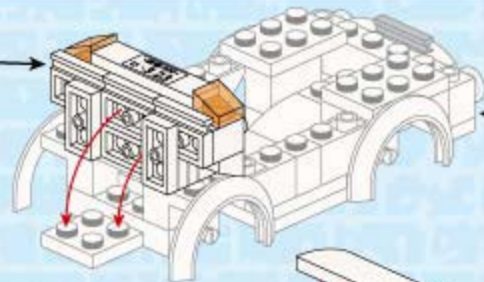

B23

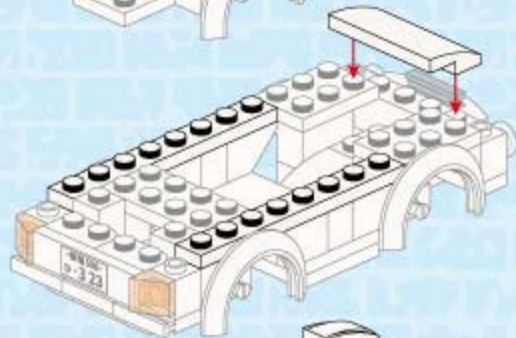
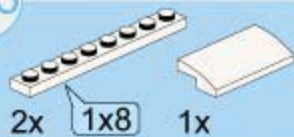

B24

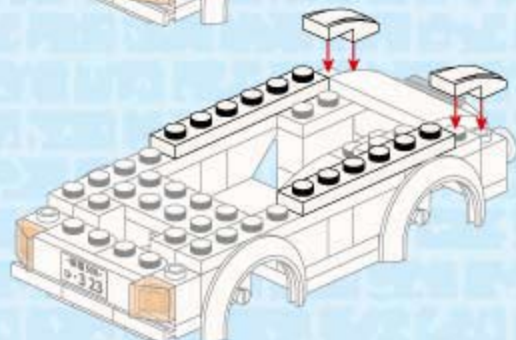

B25

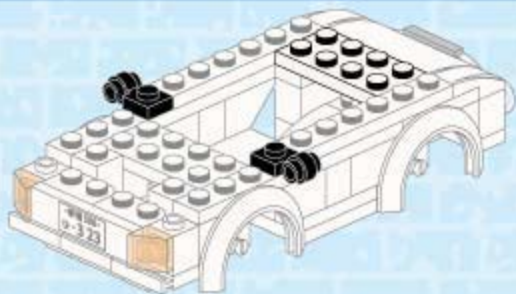

B26

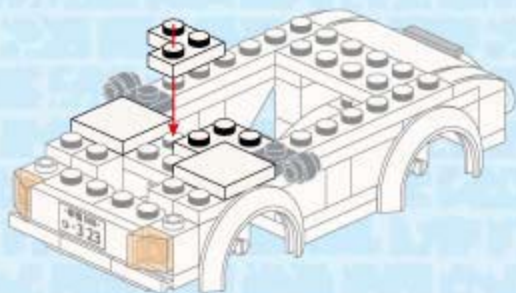

B27

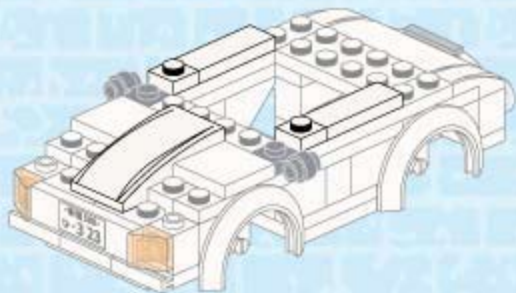
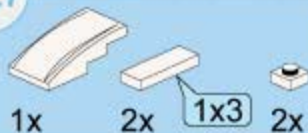

B28

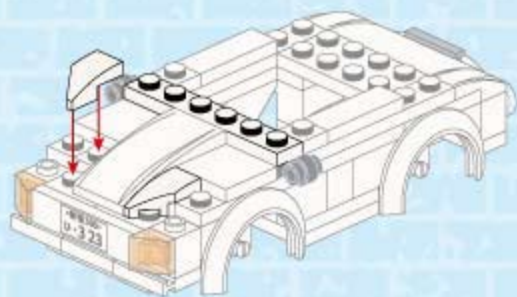
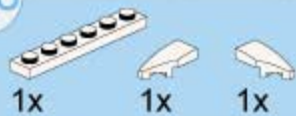

B29

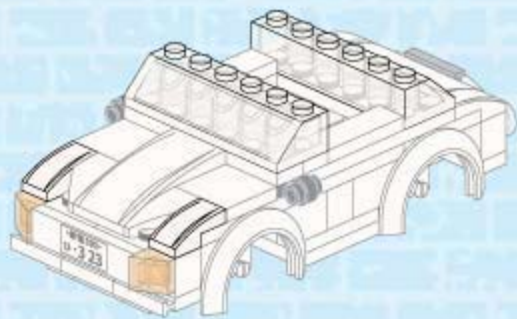

B30

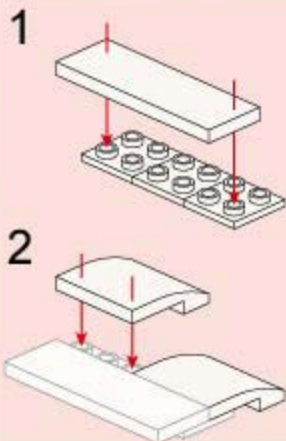
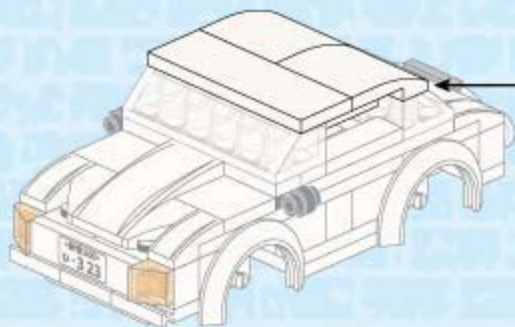
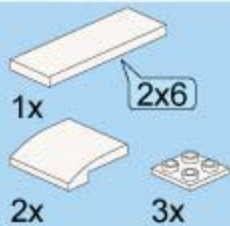

B31

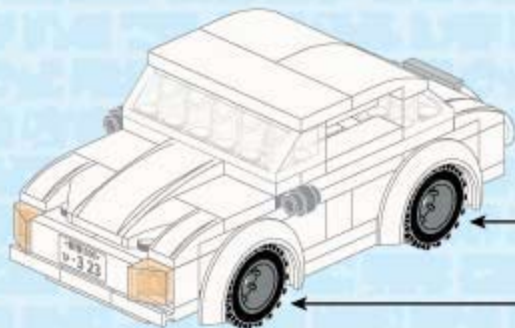





C1

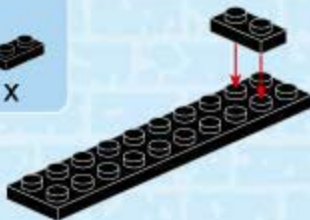

C2

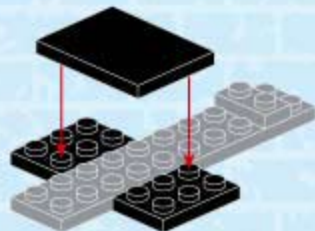
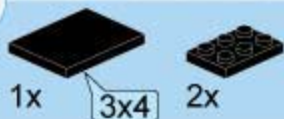

C3

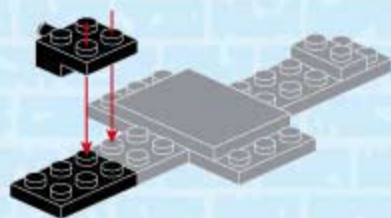
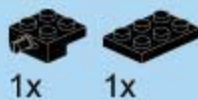

C4

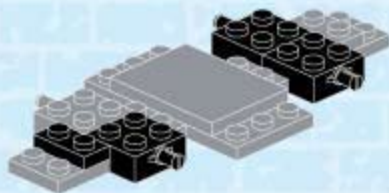

C5

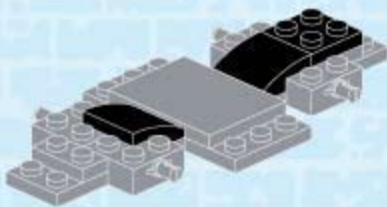
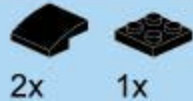

33

C6

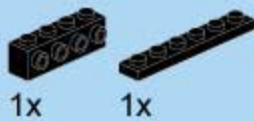

C7

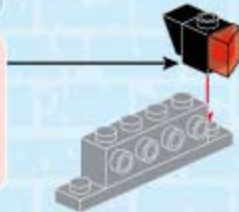
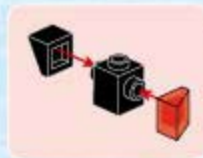

C8

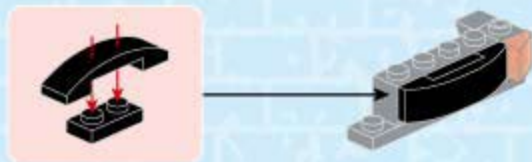

C9

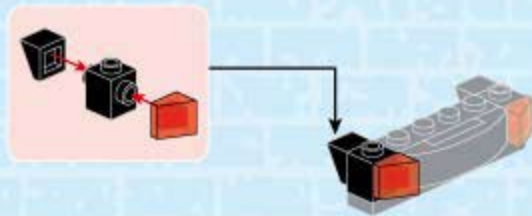

C10

C9



C5

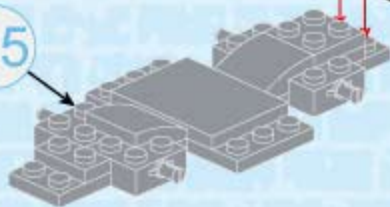

C11

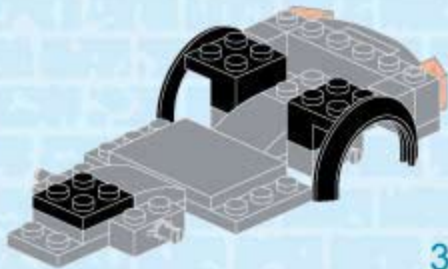

C12



1x 1x 1x



1x 1x 1x

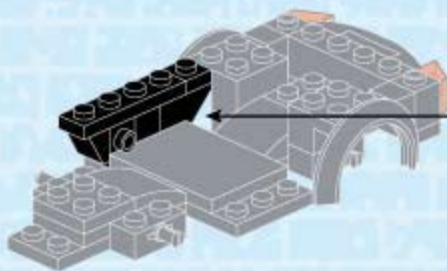

2



C13



1x 1x 1x



1x 1x 1x



2



C14



2x





C15



1x

2x



C16



1x

2x

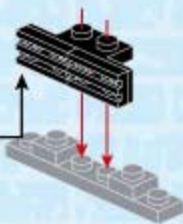

C17



1x



C18



2x

2x

2x

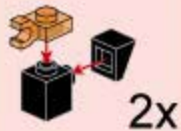
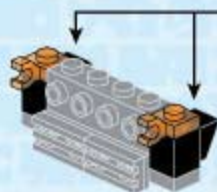

2x

C19



1x

1x4

1x



C20

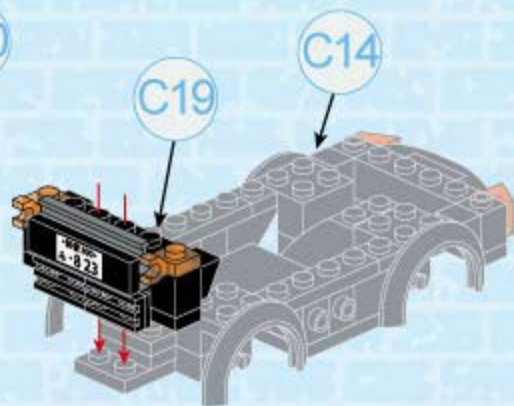

C21

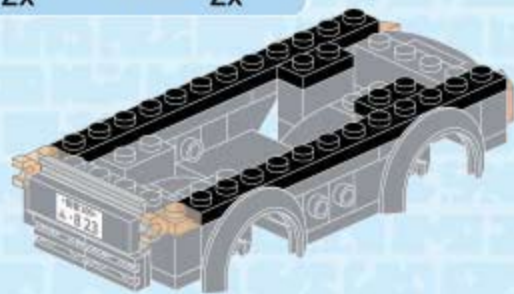

C22

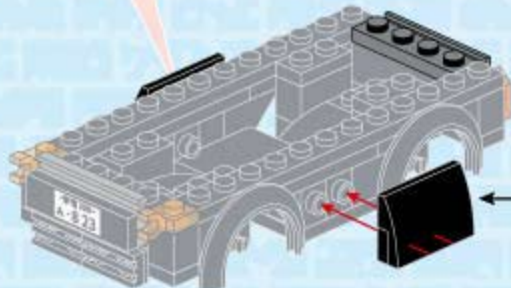
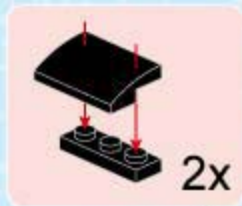
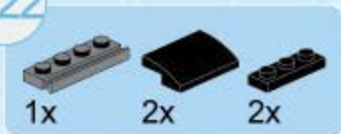

C23

2x 4x

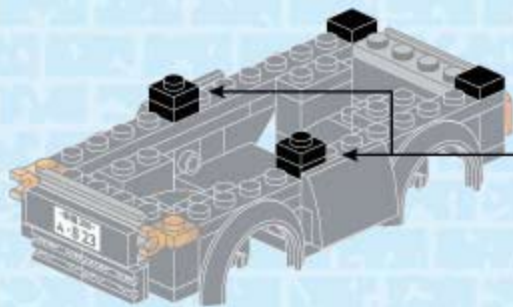

2x

C24

1x 1x 1x 2x

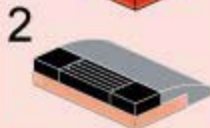
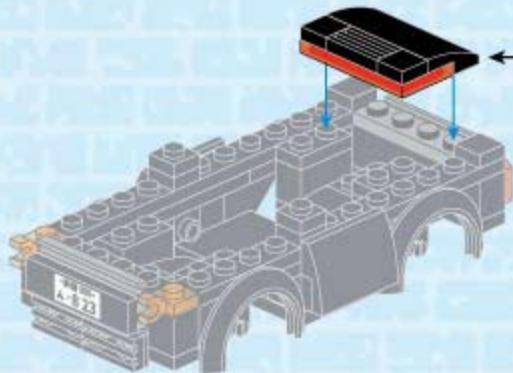

C25

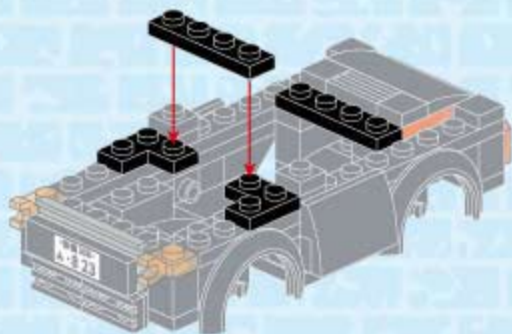

C26

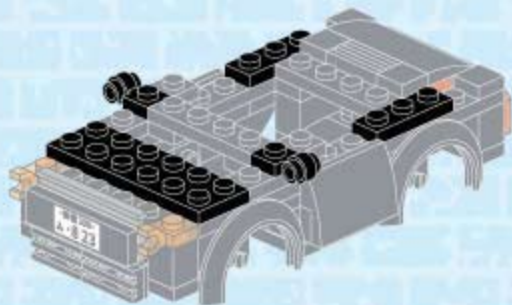
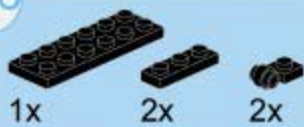



C27

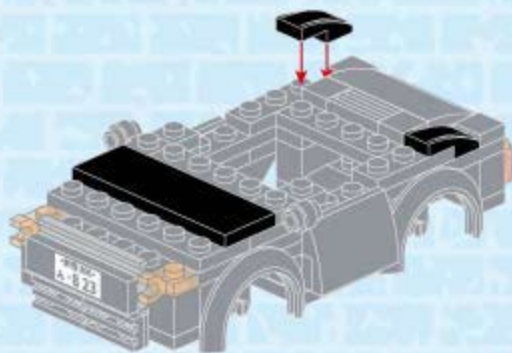

C28

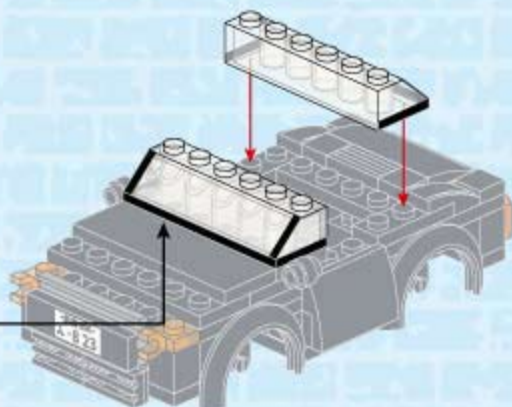

C29



1x



2x

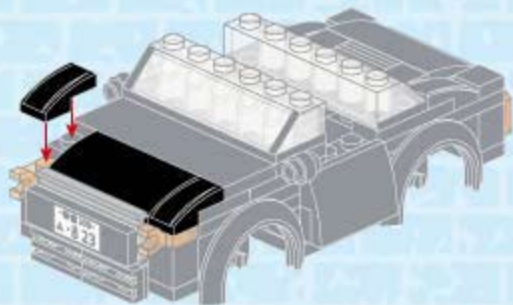

C30



2x



2x



2x



2x

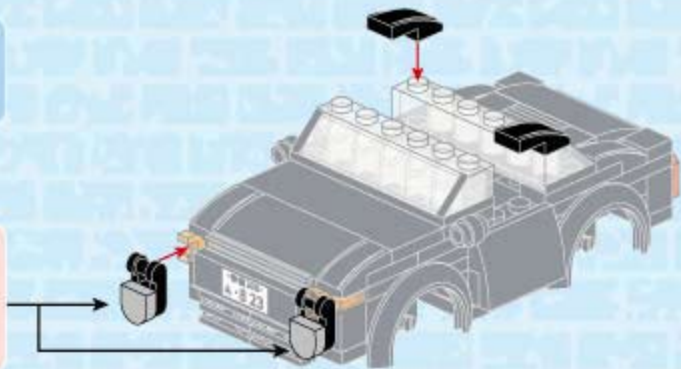

C31

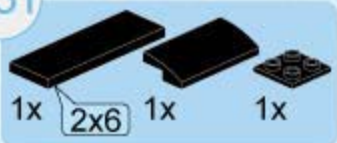

C32

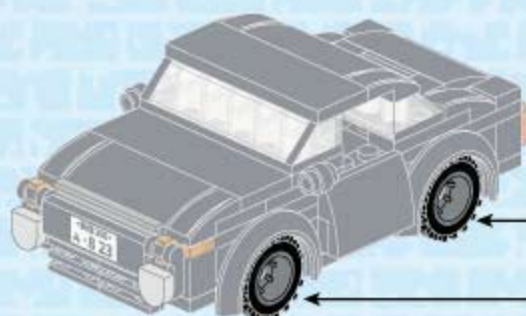

keeppley

名侦探  
**柯南**

© Goshō Aoyama/1986, 2022 Shogakukan YTV, TMS



**K20708 黑暗组织对决**



**K20709 毛利侦探事务所**



**K20710 白罗咖啡店**