

Keepplay

POKÉMON
宝可梦



K20216

©Nintendo, Creatures, GAME FREAK, TV Tokyo, ShoPro, JR Kikkaku, ©Pokémon.
TM, ®, and character names are trademarks of Nintendo For sale in China only.

超级
喷火龙X





A1

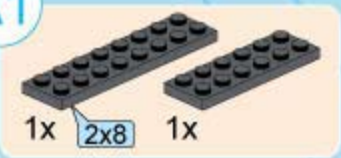

A2

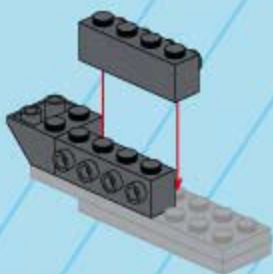

拆件器使用方法, 仅为示例
Usage of Brick Separator, Just for the sample

<p>1</p>	<p>3</p>
<p>2</p>	<p>4</p>

A3

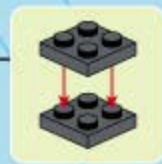
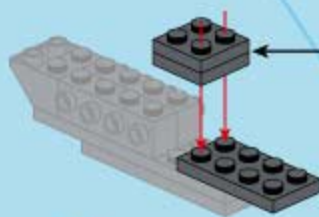

A4

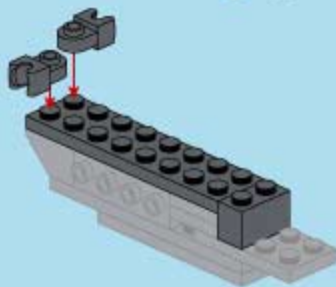
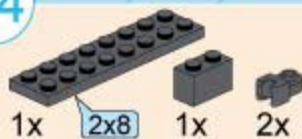

A5

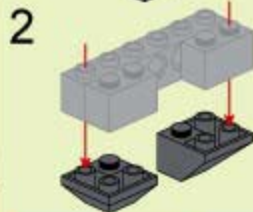
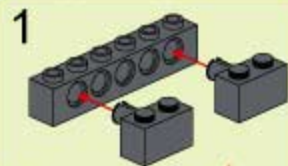
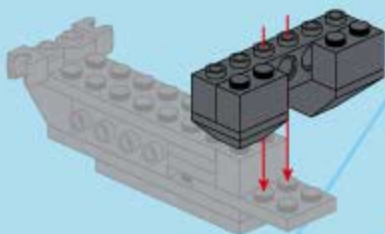

A6

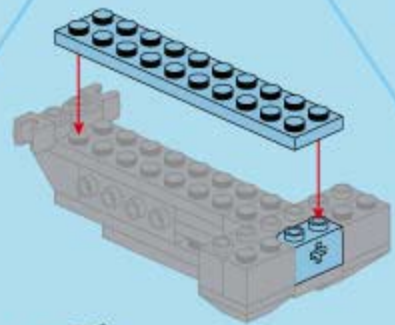
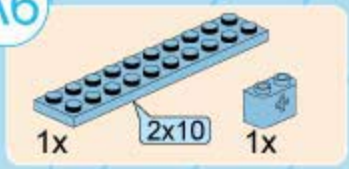

A7

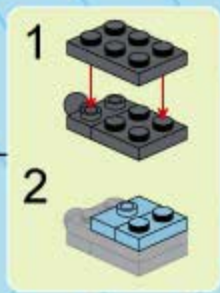
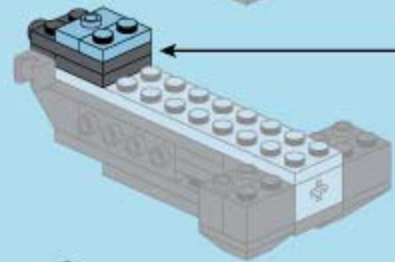
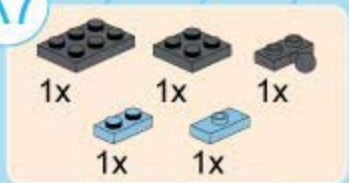

A8

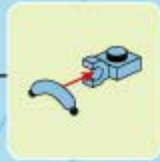
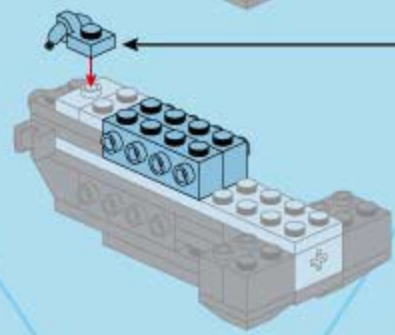

A9

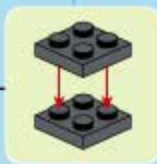
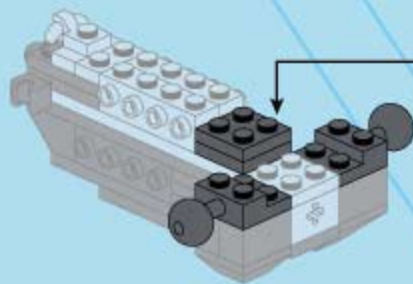

A10

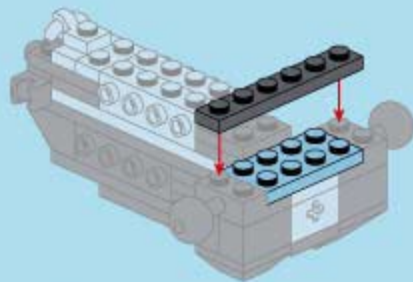
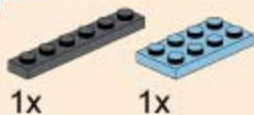

A11

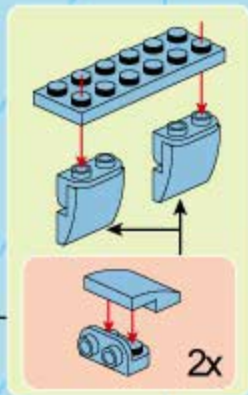
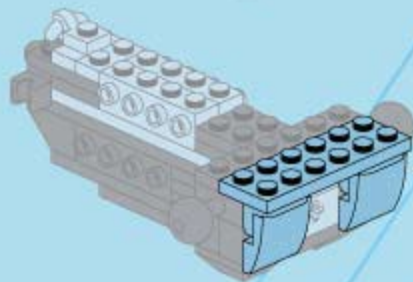
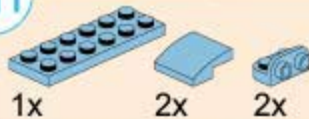

A12



1x



2x

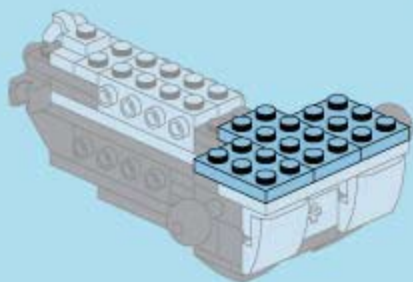

A13



1x



1x



1x

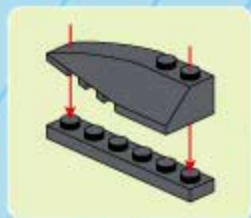
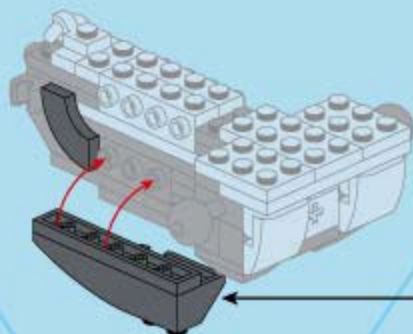

A14

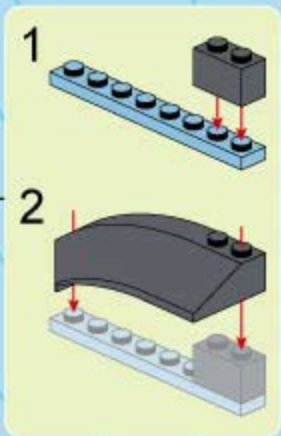
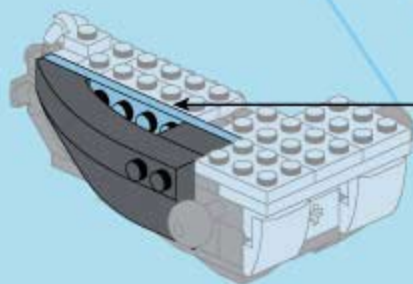
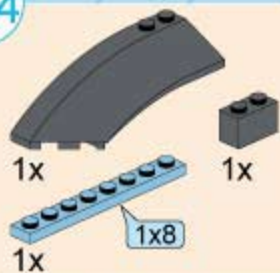

A15

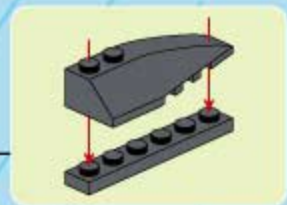
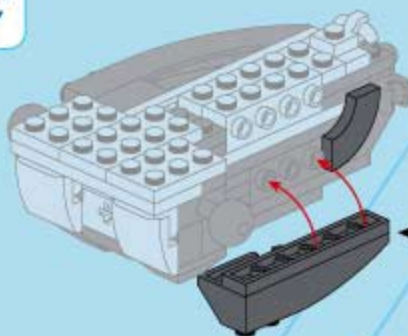
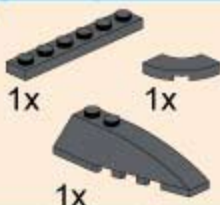

A16

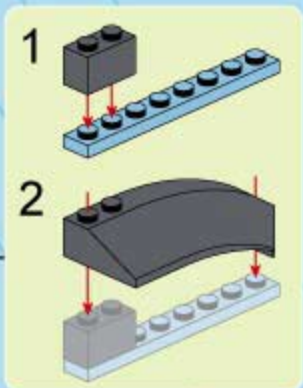
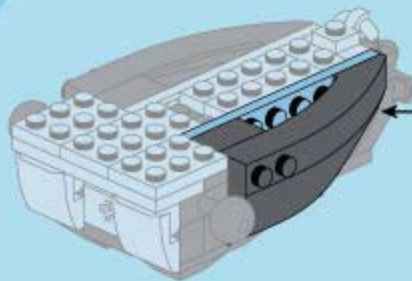
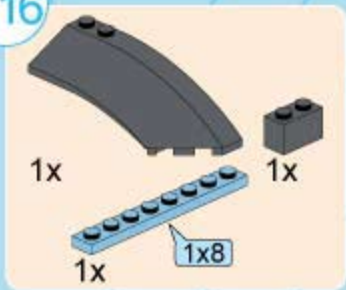

A17

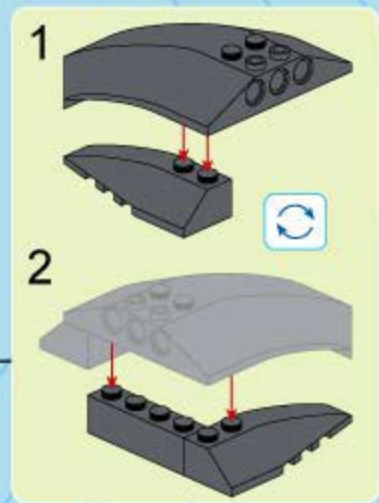
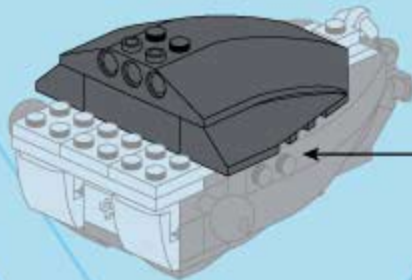

A18



1x

2x

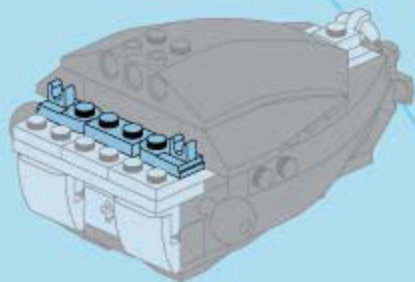

A19



1x

2x

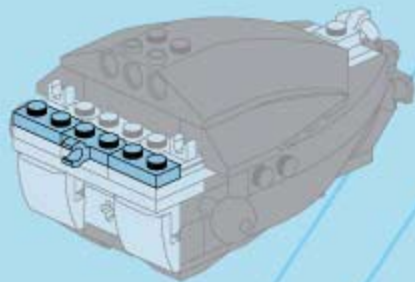

A20

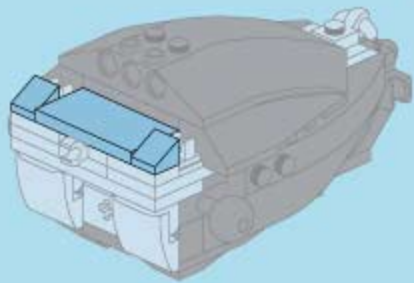

A21

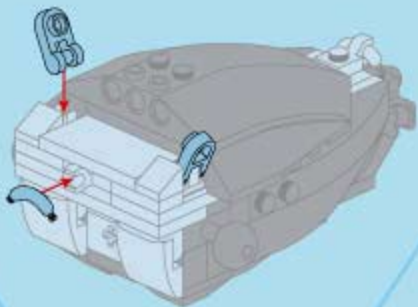



A22



A23

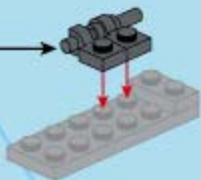

A24

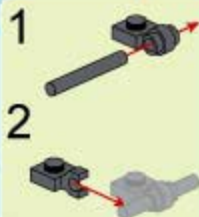

A25

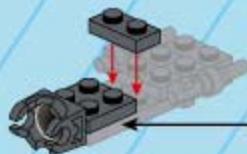

A26



A21

A25

A27

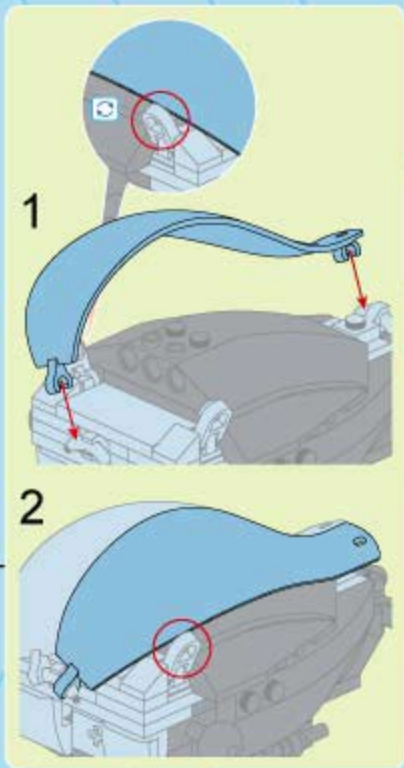
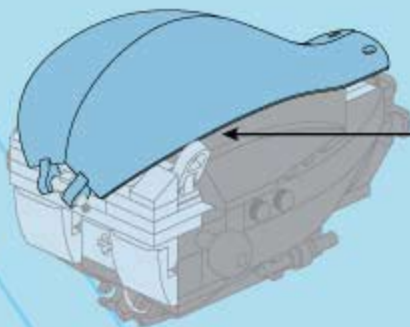
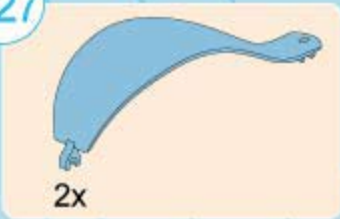



A 2x

A28



1x



3x



A29



1x



1x

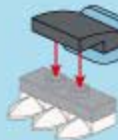

A30



1x



1x



1x

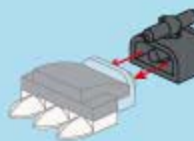



B 2x

A31



1x



2x



1x

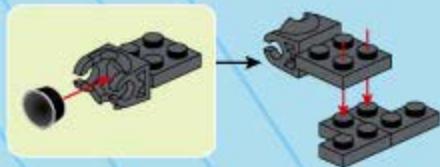

A32



2x



1x



A33



1x



1x



A34

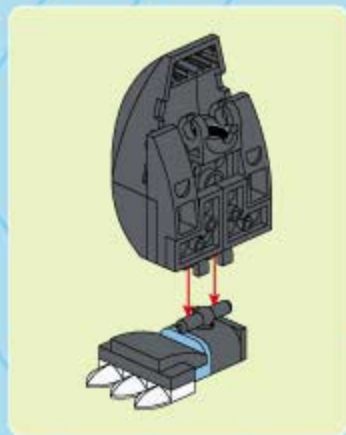
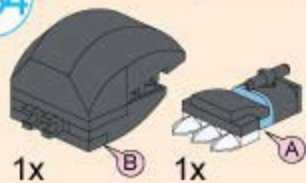

A27

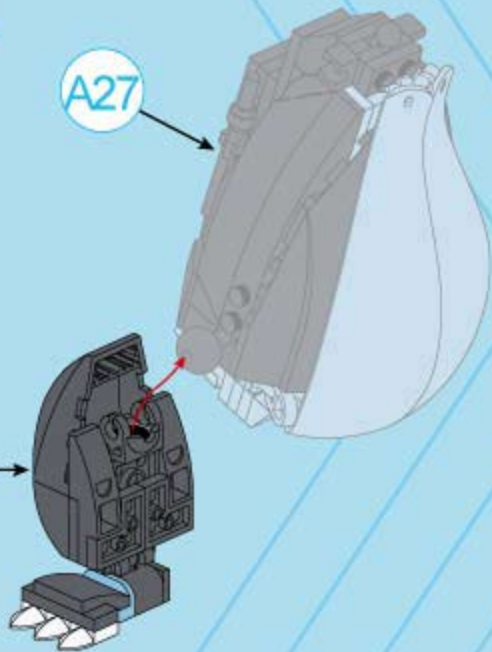

A35

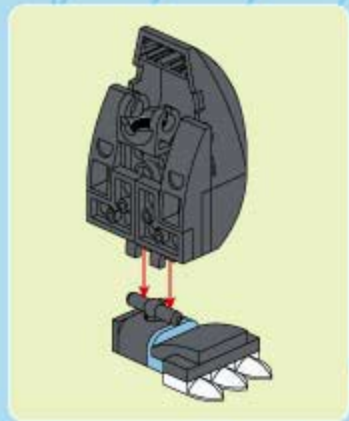
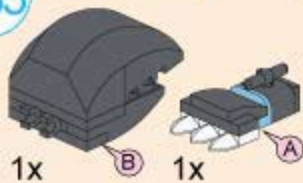

A34



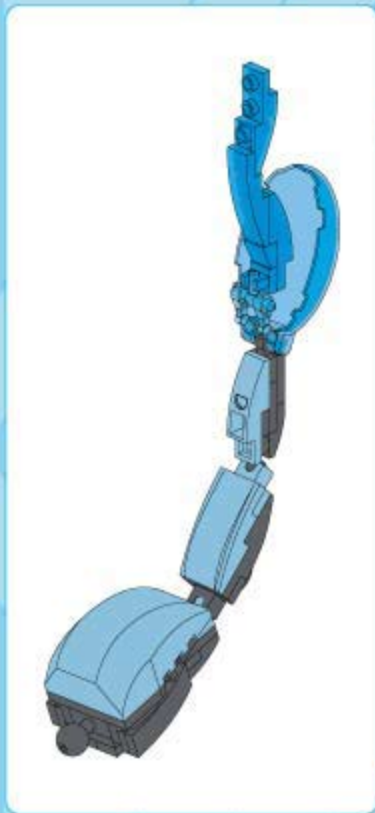

A36



2x

1x



A37



1x

1x



A38



2x

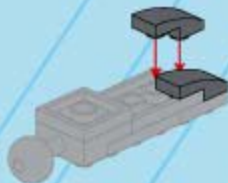

A39



2x

A40

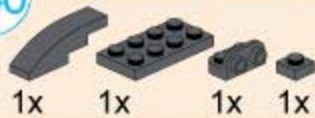

1x

1x

1x

1x

A41



1x

1x

1x

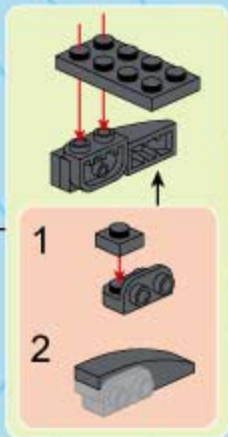
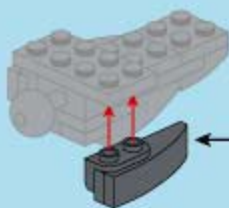
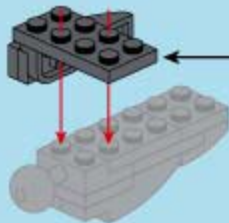
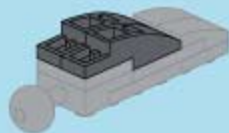

1



2

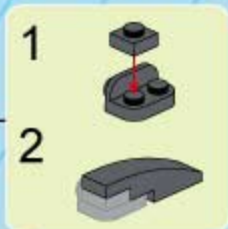

1



2

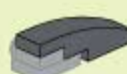

A42



1x



1x



1x



A43



2x



1x



1x



1x



1x

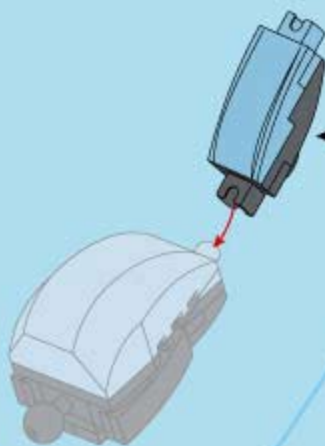

1



2



3

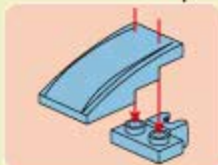
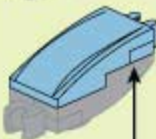

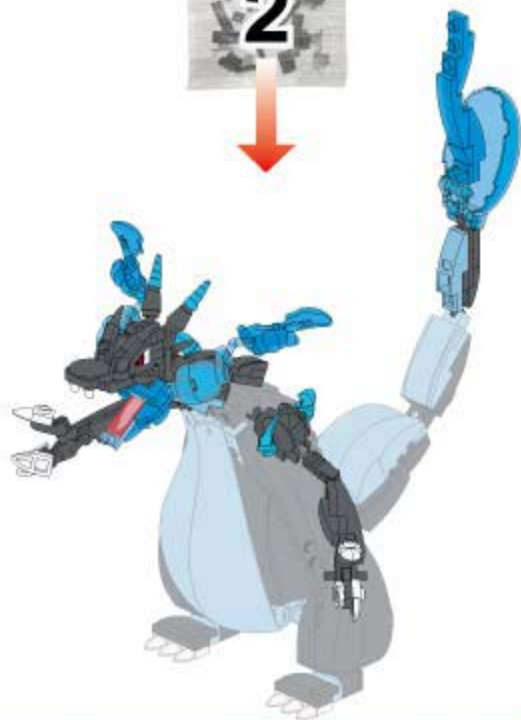

A44

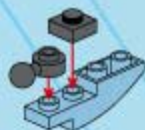

A45



A46

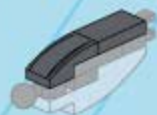

A47



1x



A48



1x

1x

1x



A49



1x



1x

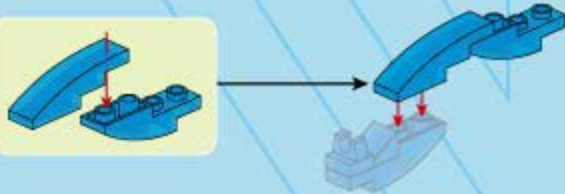

A50



2x



1x



A51

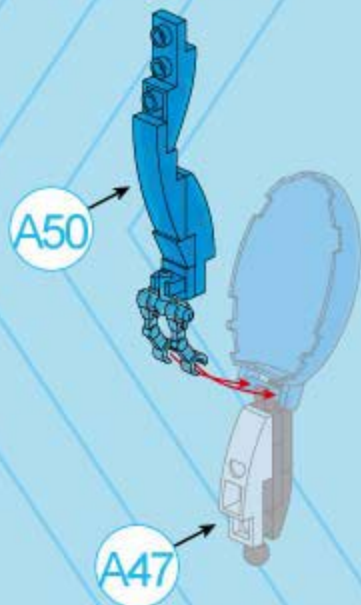

A52

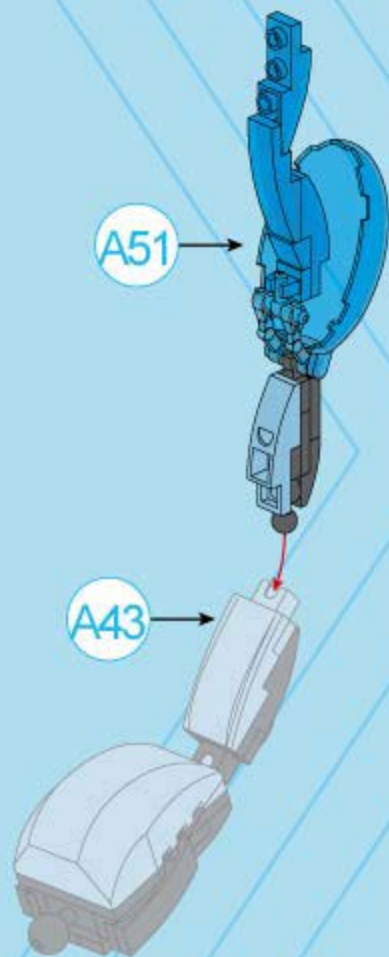

A53

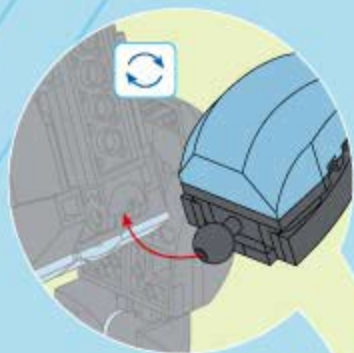

A52

A35

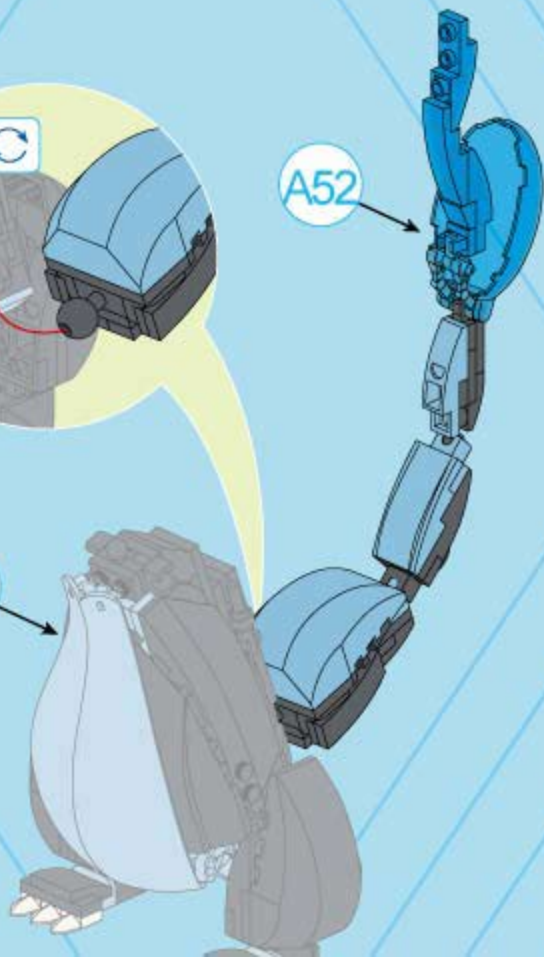

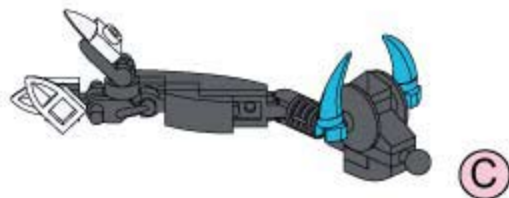

A54



A55

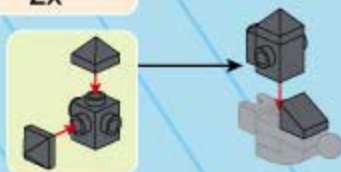

A56

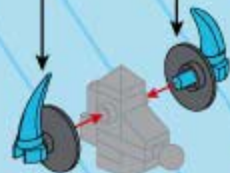

A57

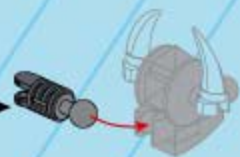
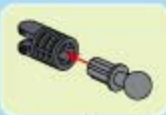

A58

1x 1x



A59

1x 1x



A60

1x 2x

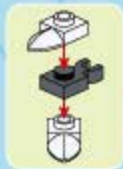

A61

1x 1x 1x 1x

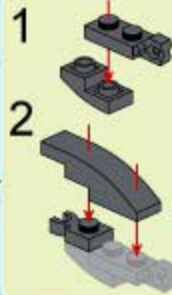

A62

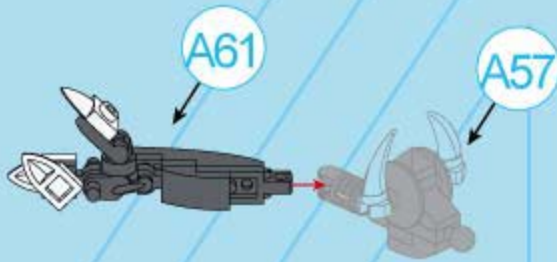

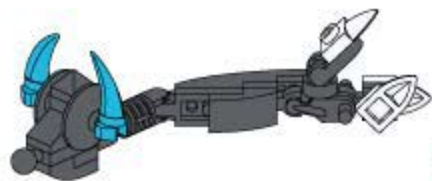

D

A63

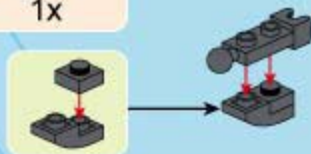

A64

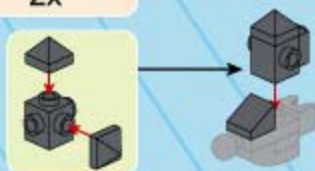

A65

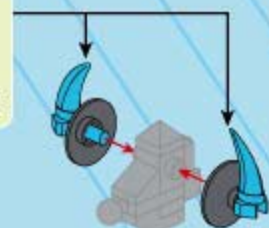

A66

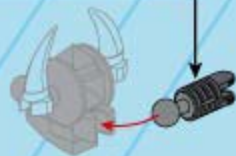
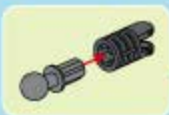

A67



A68



A69



A70

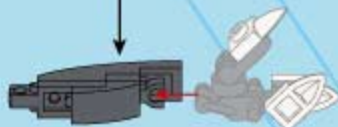
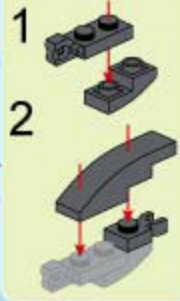

A71

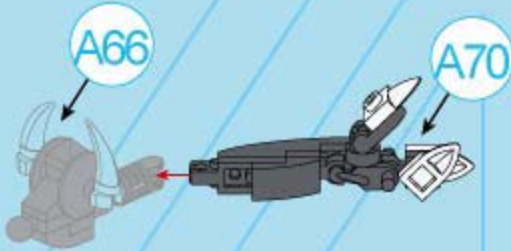

A72

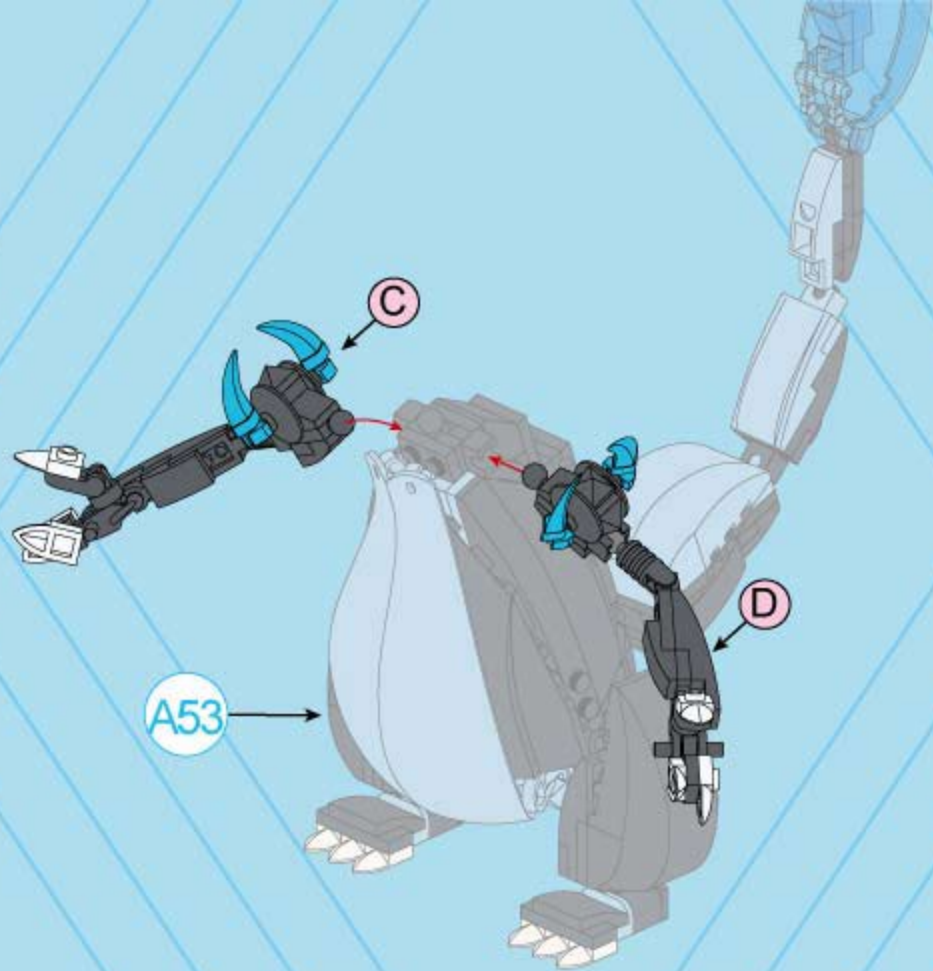



A73

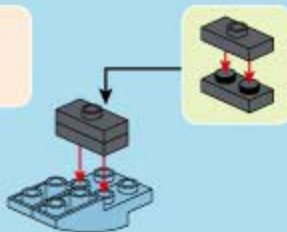
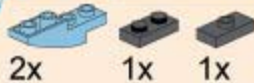

A74

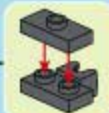
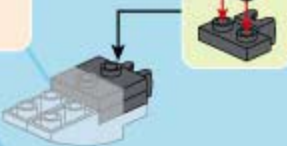

A75



A76

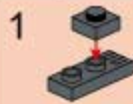
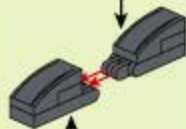
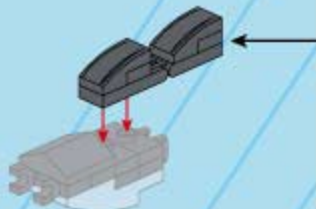

A77

1x 2x 2x

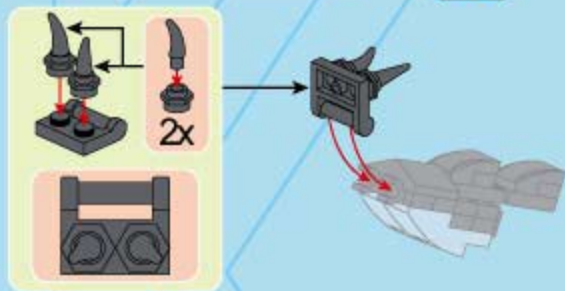

A78

1x 2x 1x



A79

1x

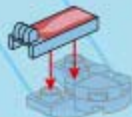

A80

1x 1x 1x3 2x 1x

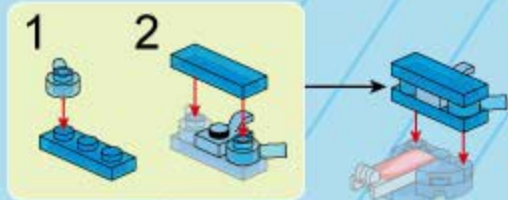



A81



1x

1x



A82



1x



A83



1x



A84



1x



1x



1x



A85



A84

A80



A86



1x

1x



A87



1x



A88



1x



A89

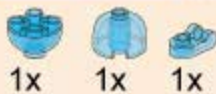

1x

1x

1x

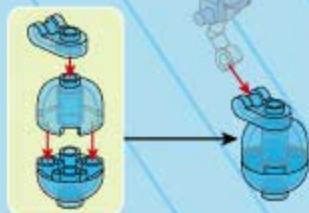

A90

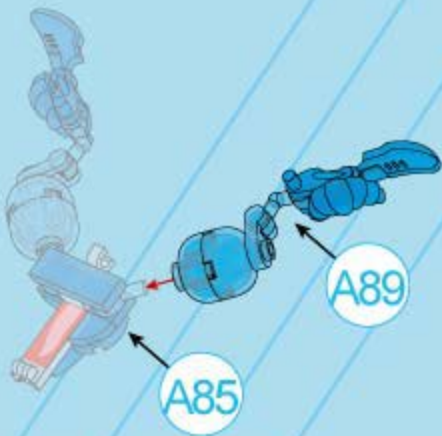

A91

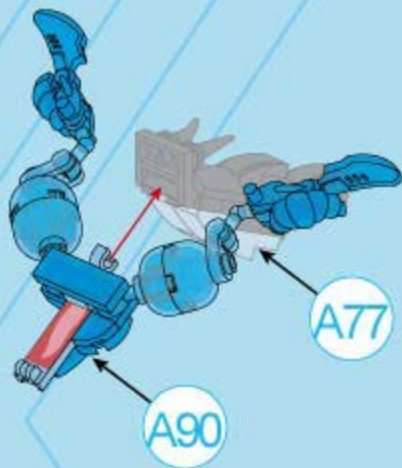

A92

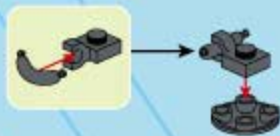

A93

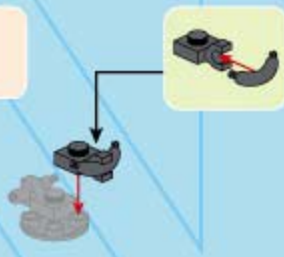

A94

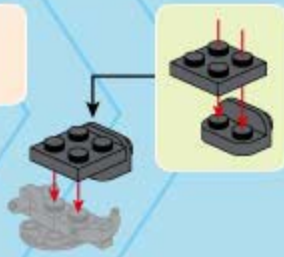

A95

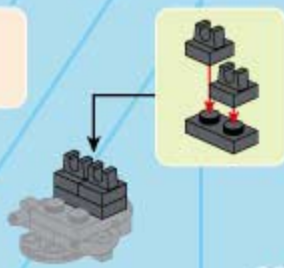

A96

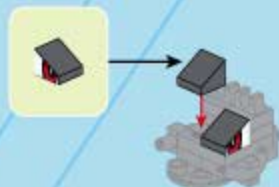

A97

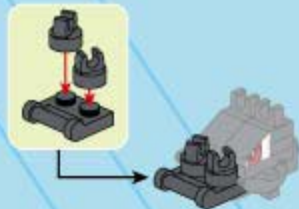

A98

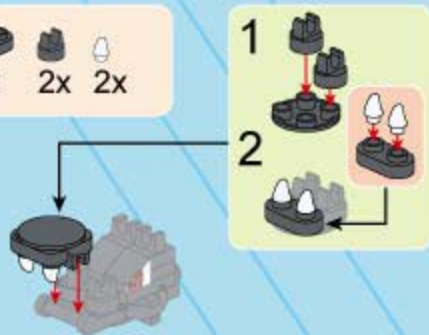

A99

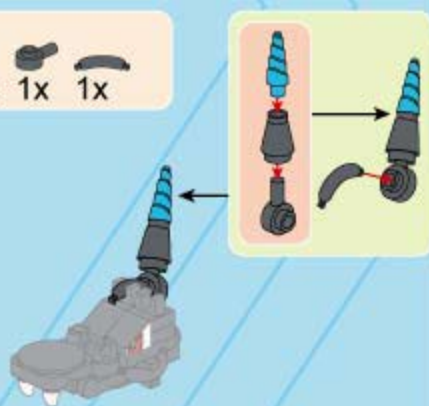

A100

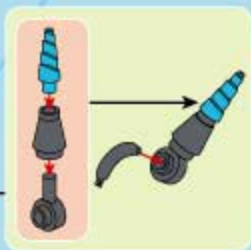

A101

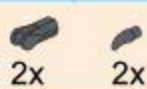

A102

A101

A91

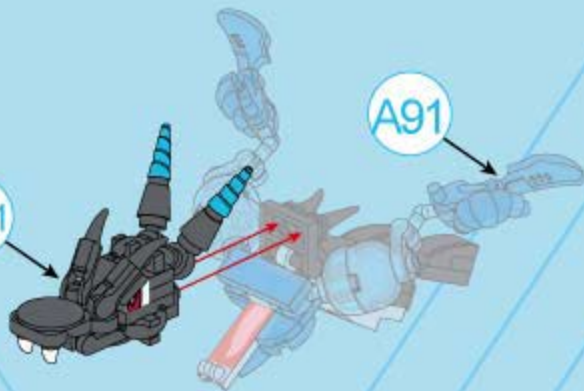

A103





1x

16x16



1x



1x



1x



1x



1x

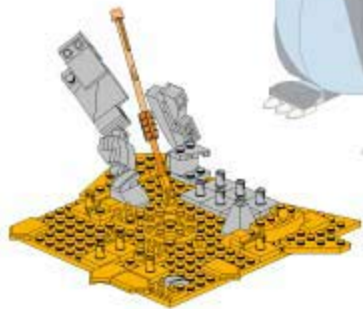

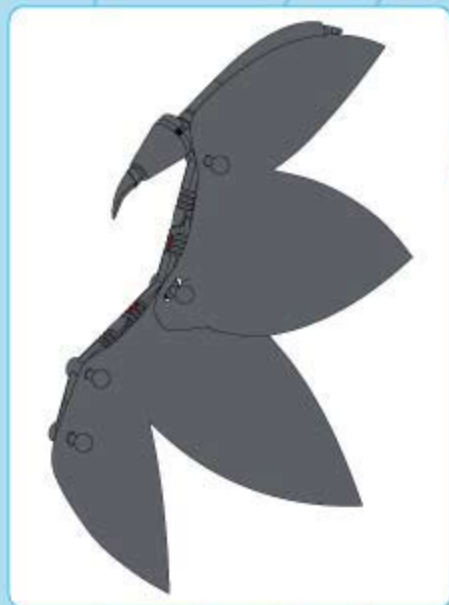

 ② **1:1**

A104



A105

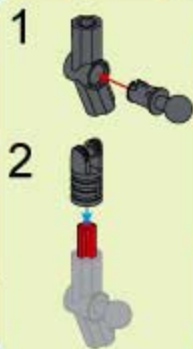

 ② **1:1**

A106

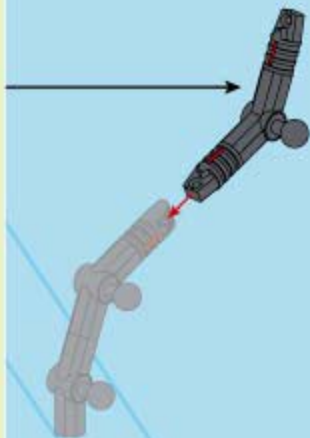
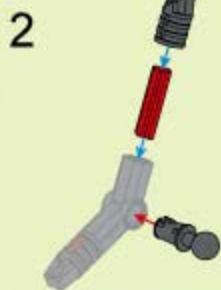

A107

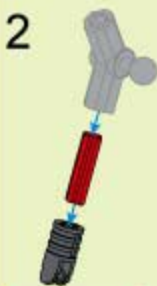
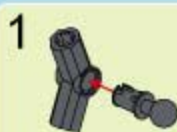

A108



A109

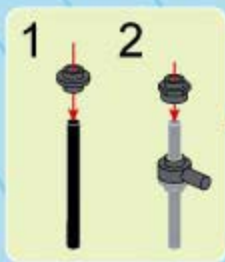

A110



A111

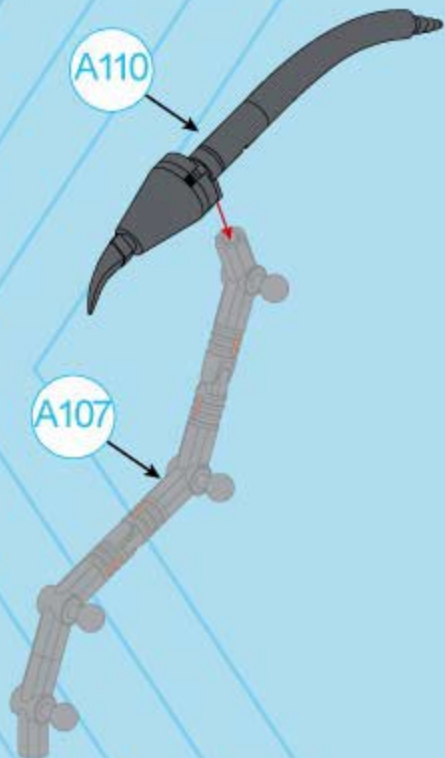

A112

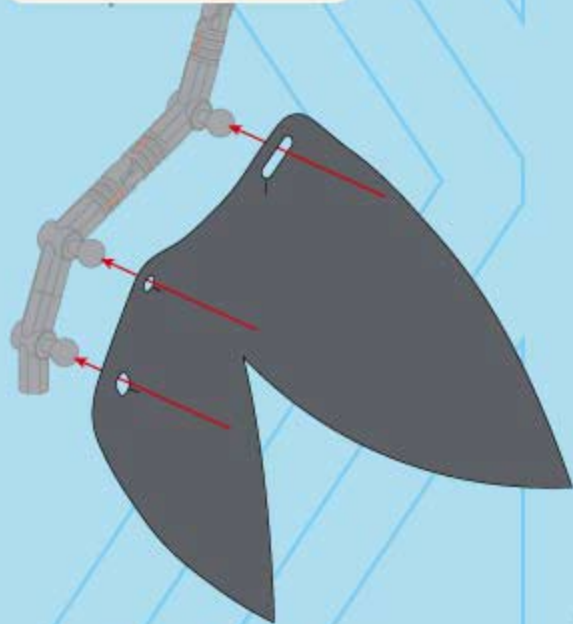

A113



A114



A113

A103

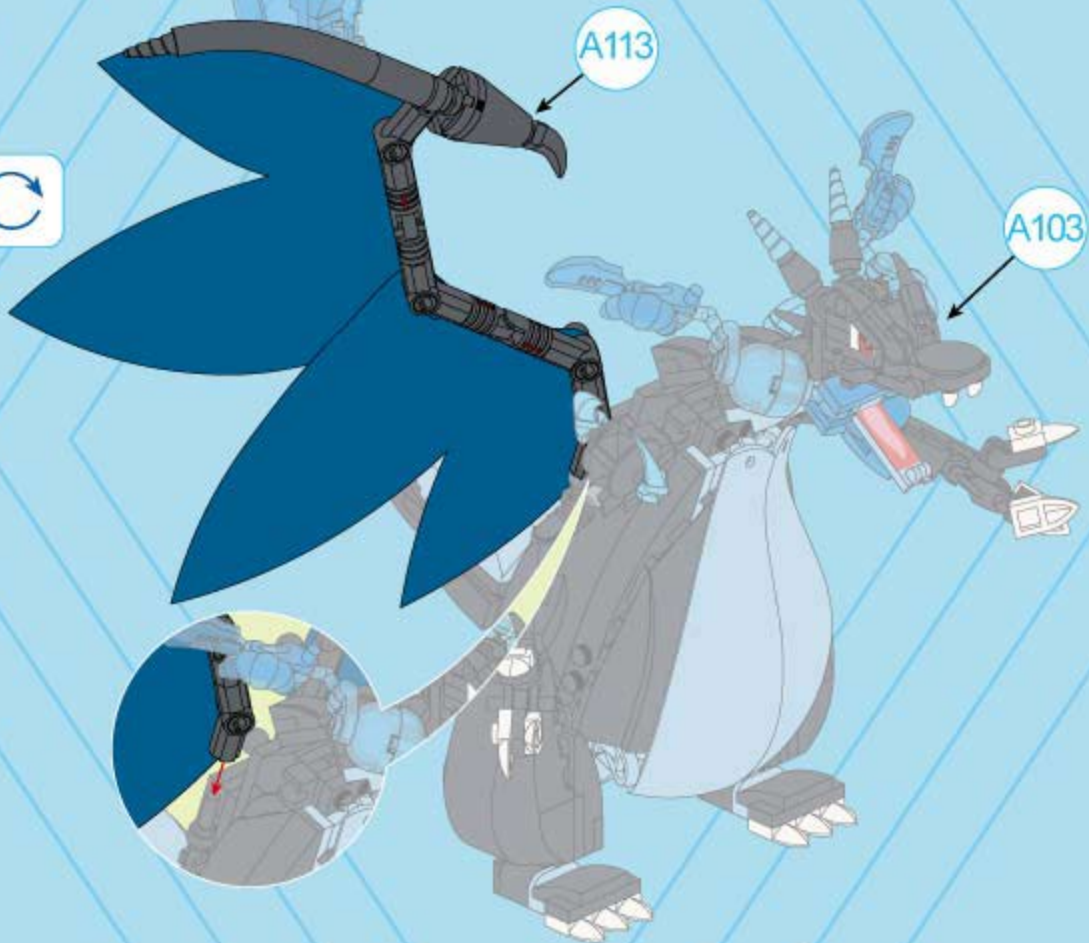

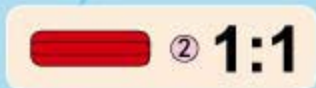
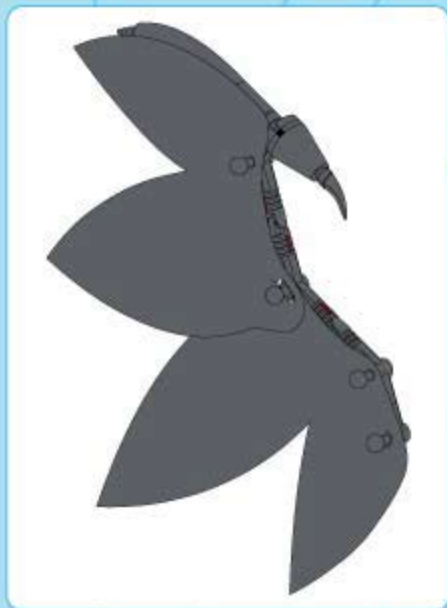

A115



A116

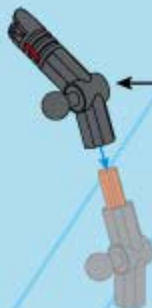
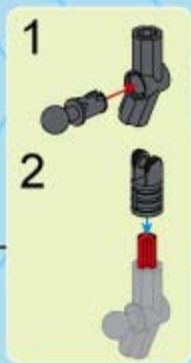

 ② **1:1**

A117

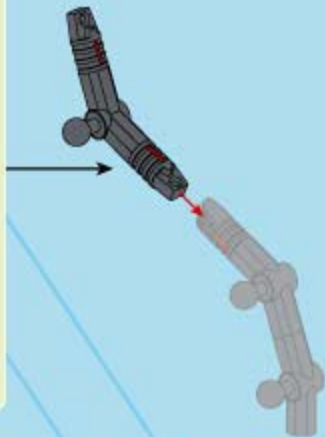
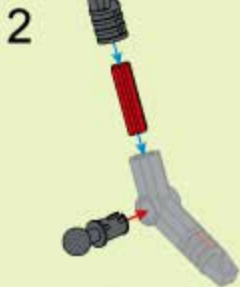
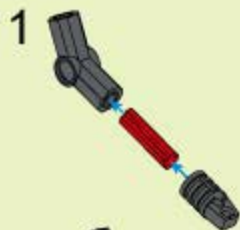

A118

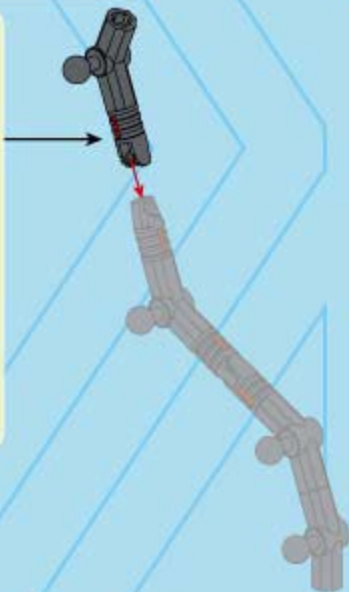
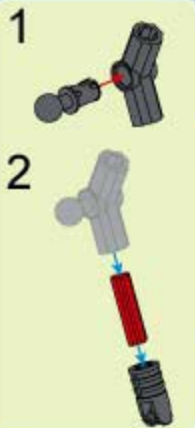

A119



A120



A121



A122



A121

A118

A123

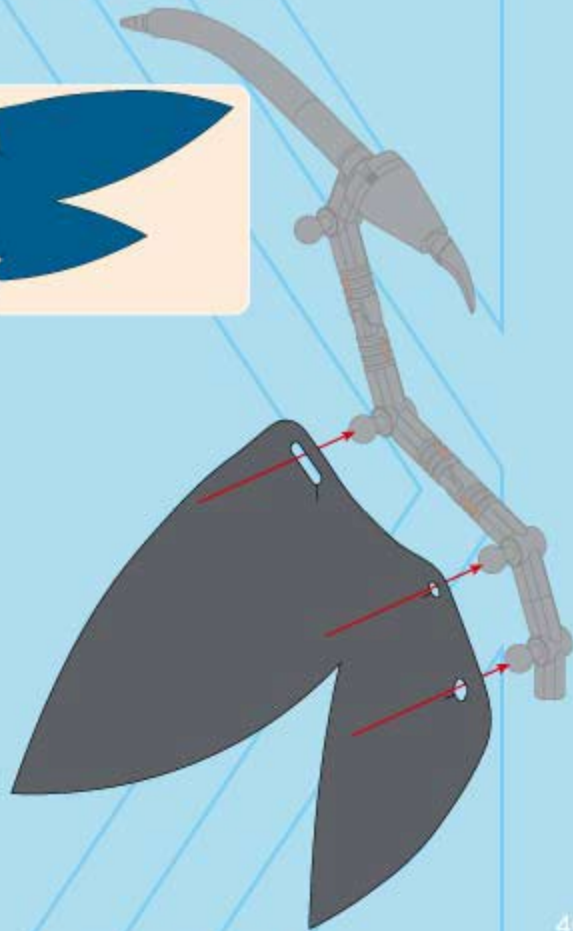
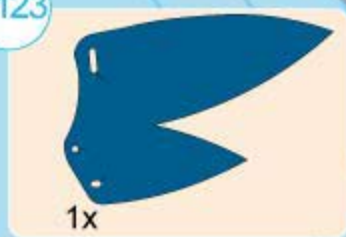

A124



A125



A114

A124



A126



1x



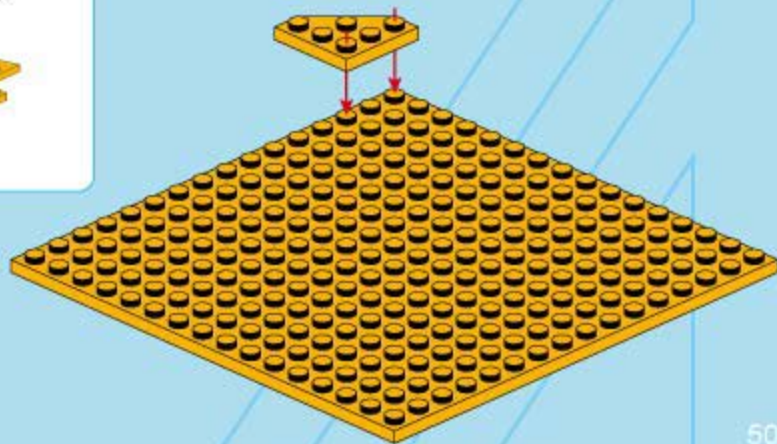

B2

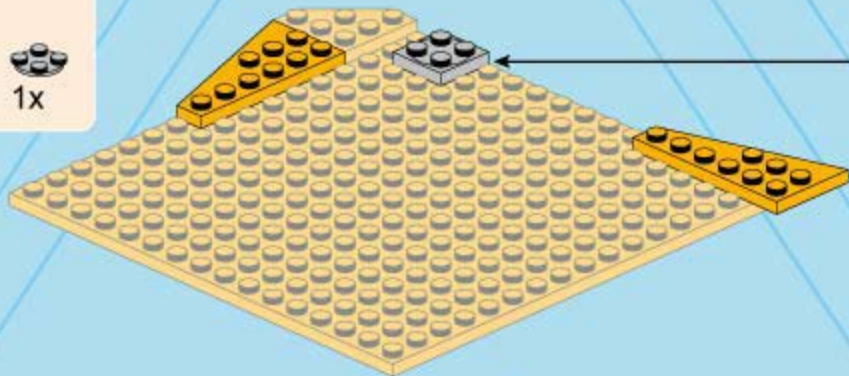
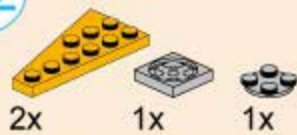

B3

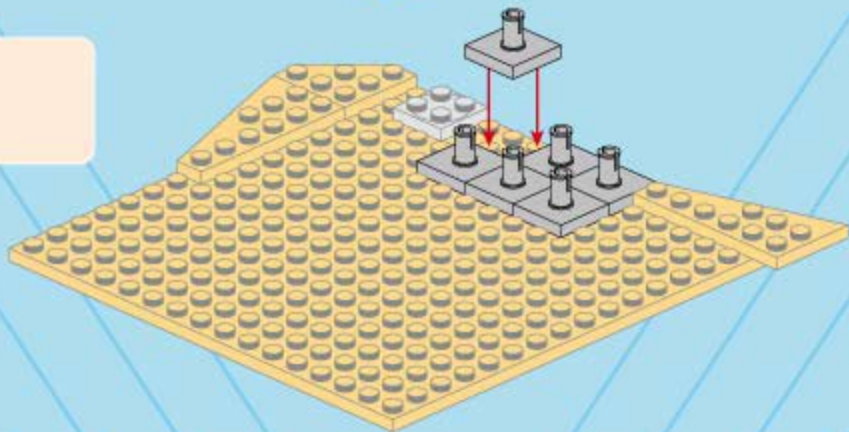

B4

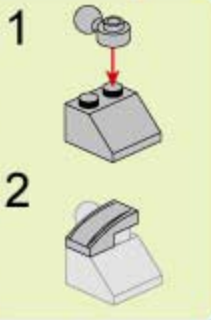
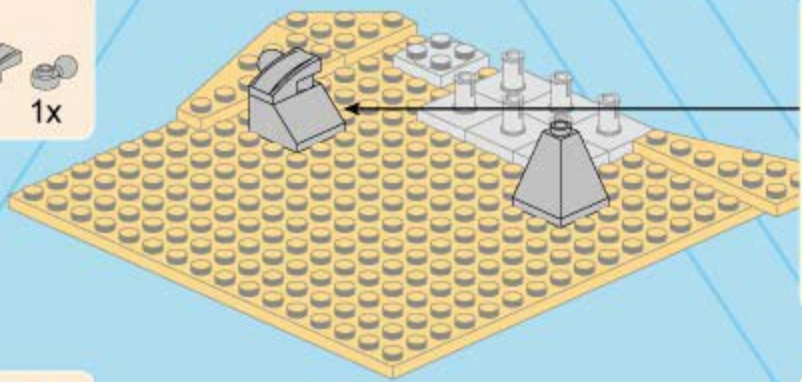
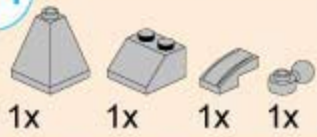

B5

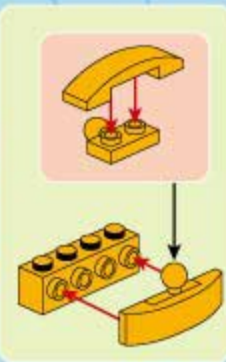
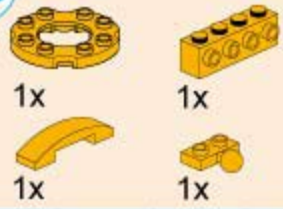

B6



6x



2x



1x

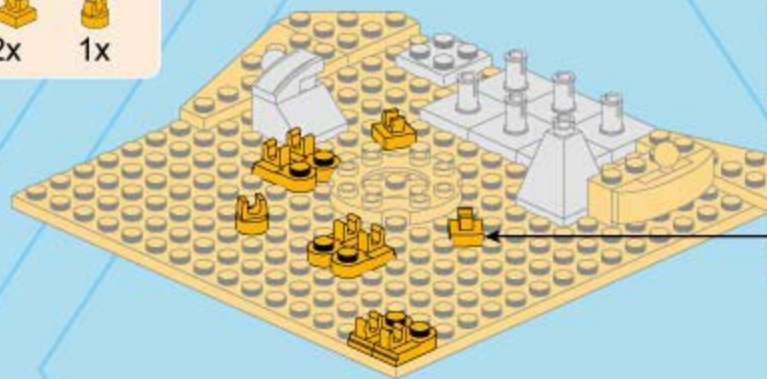

B7



1x



5x

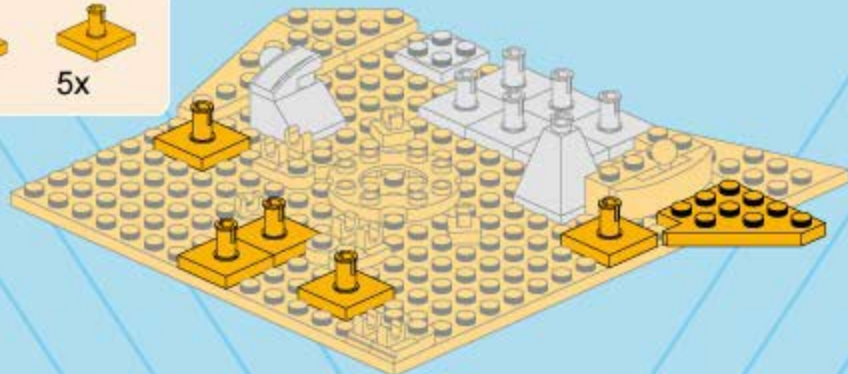

B8



2x



2x



2x

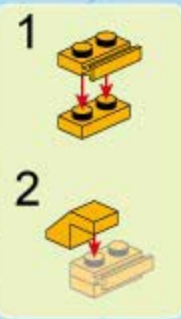
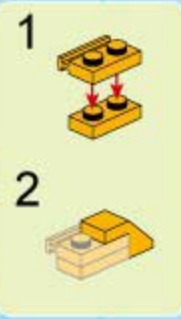
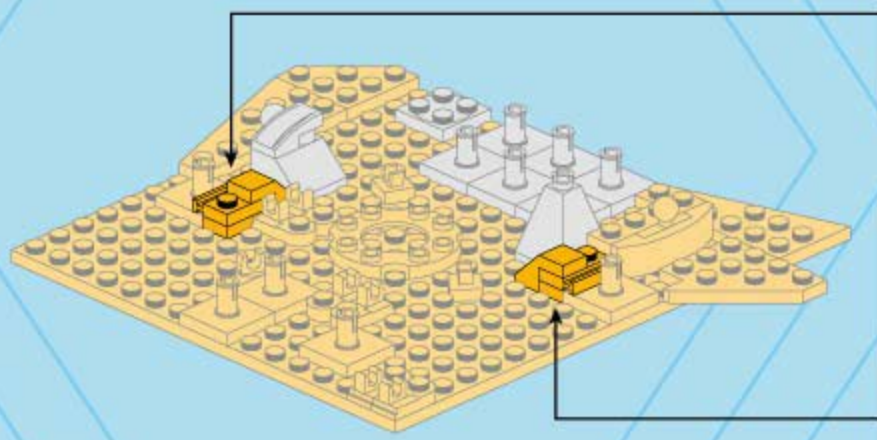

B9



4x



1x



1x

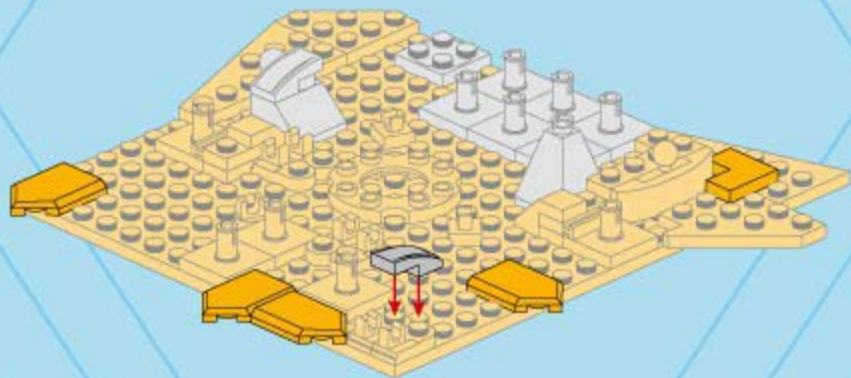



B10

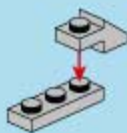

B11

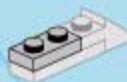

B12



B13

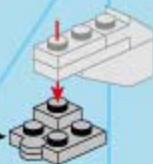
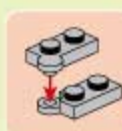

B14



1x

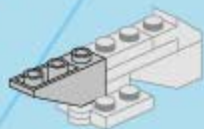

B15



1x



B16



1x



1x

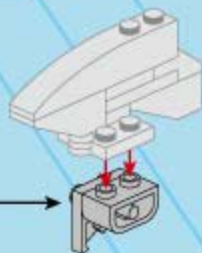
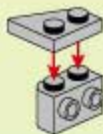

B17



B18

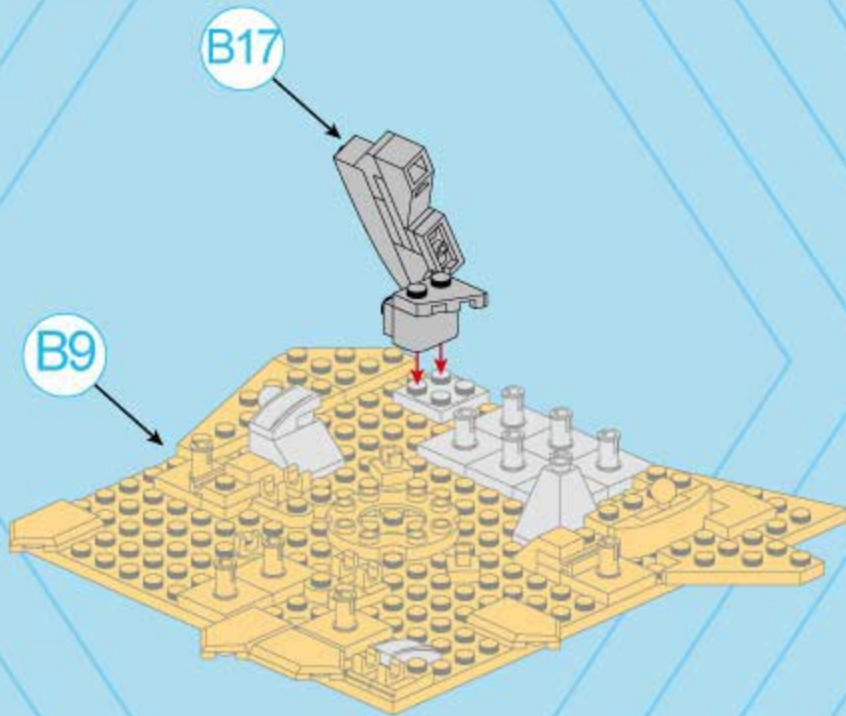

B19

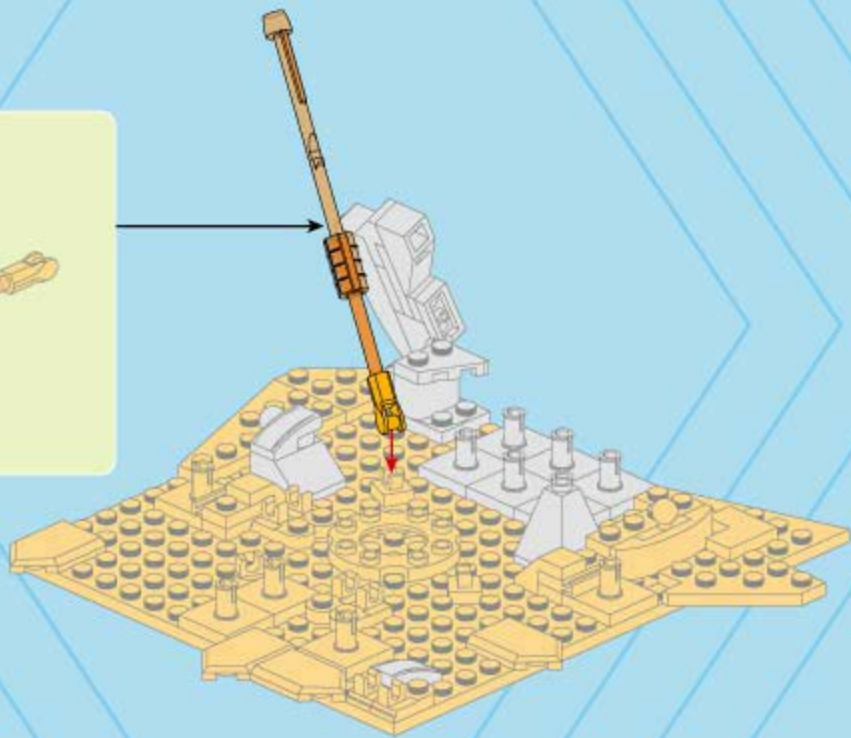
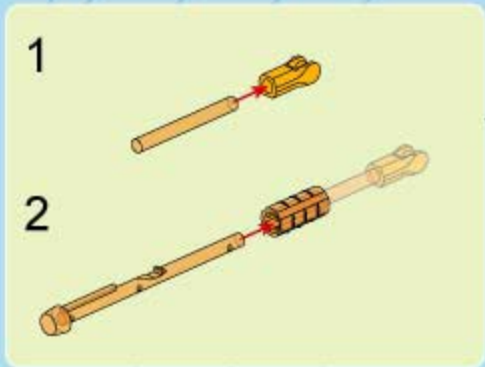

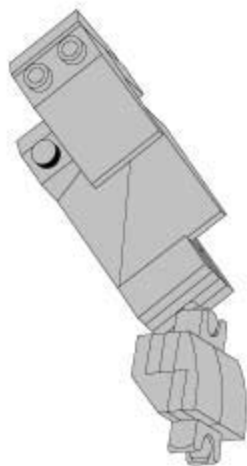

B20



1x



1x

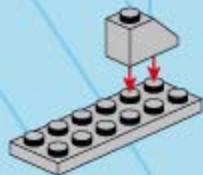

B21



1x



1x

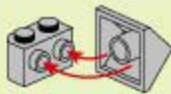

B22



1x

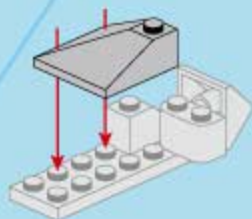

B23



1x

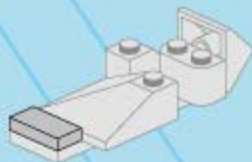

B24



1x

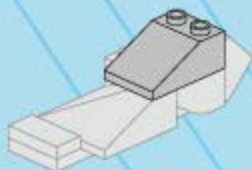

B25



1x



1x



1x

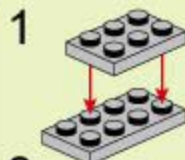

2

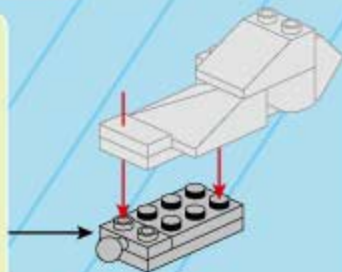

B26



2x



2x



2x



1x



1

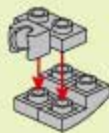

2



3



4



B27

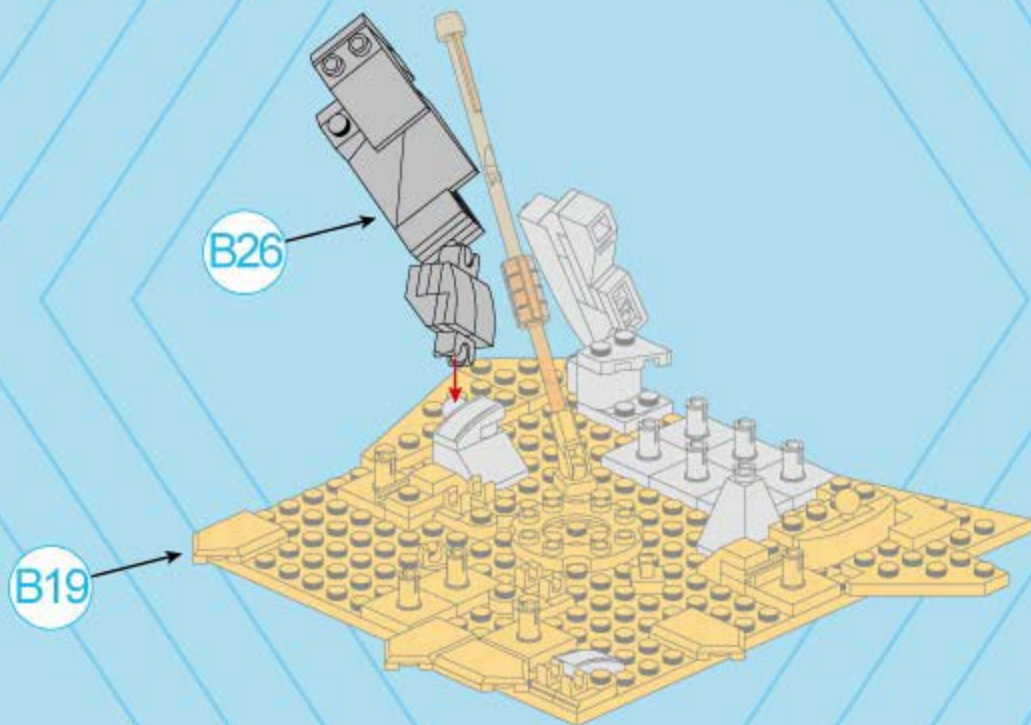

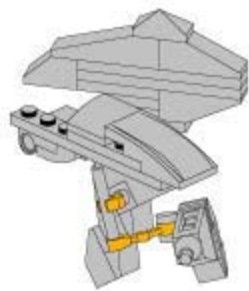

B28

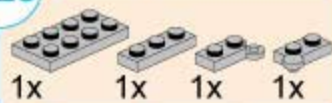

1x

1x

1x

1x

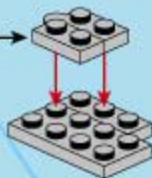
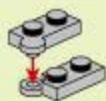

B29



1x



1x



B30



1x



1x



B31

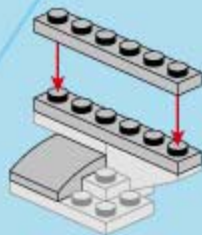

B33

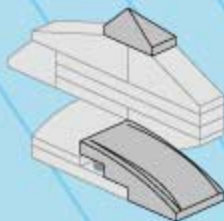
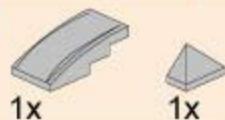

B32

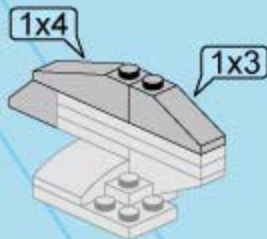
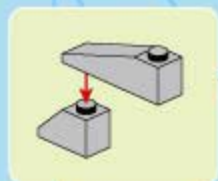
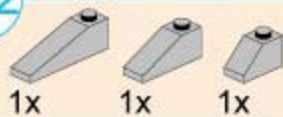

B34

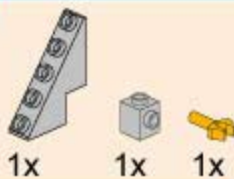

B35

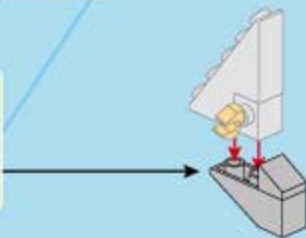
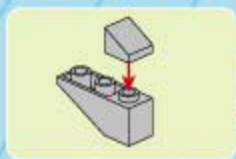

B36

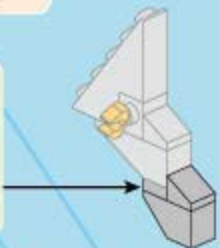
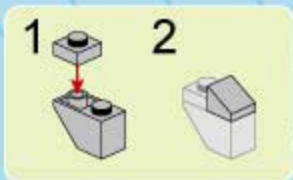

B37

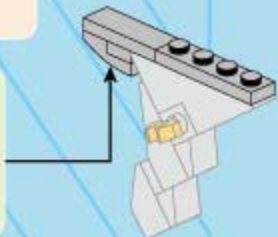
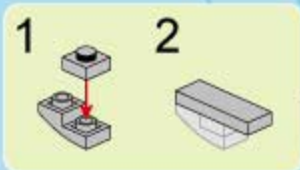
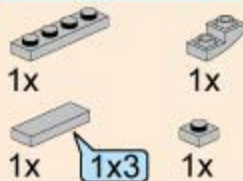

B38

B33

B37

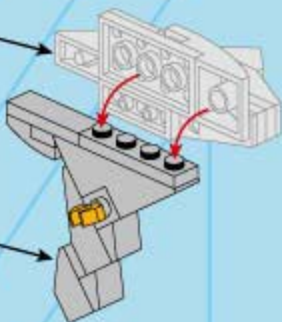

B39

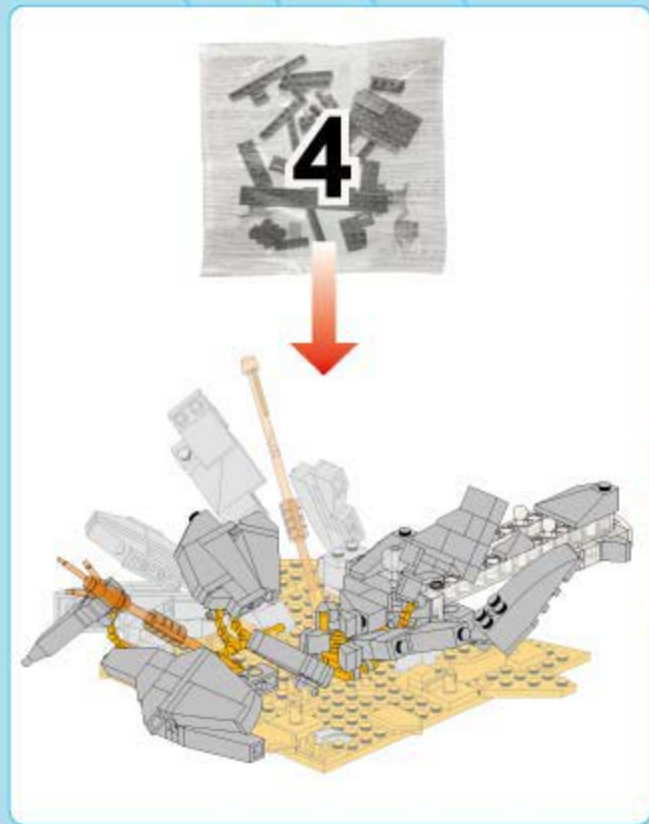
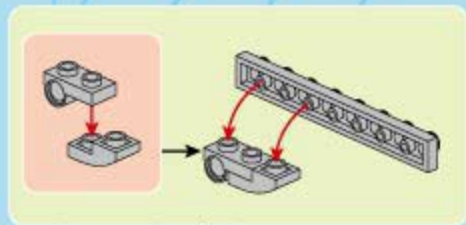
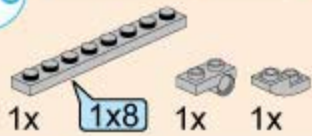

B40



1x



1x



B41



1x



1x



1x

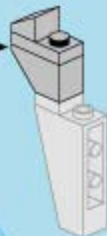
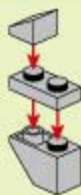

B42



1x



2x

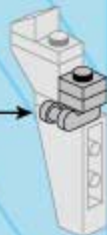

B43



1x



B44



1x



B45



1x



1x



B46

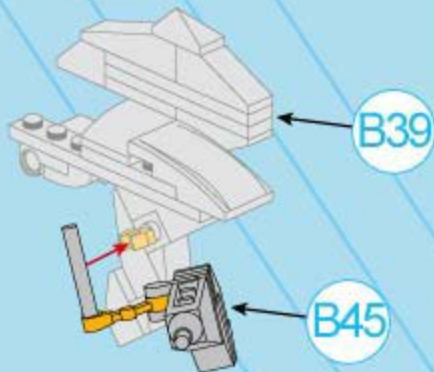

B47

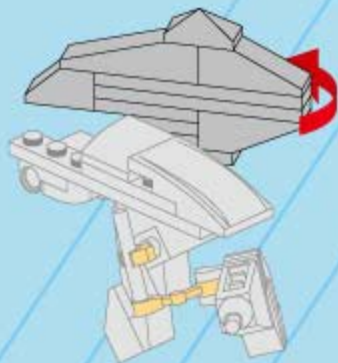

B48

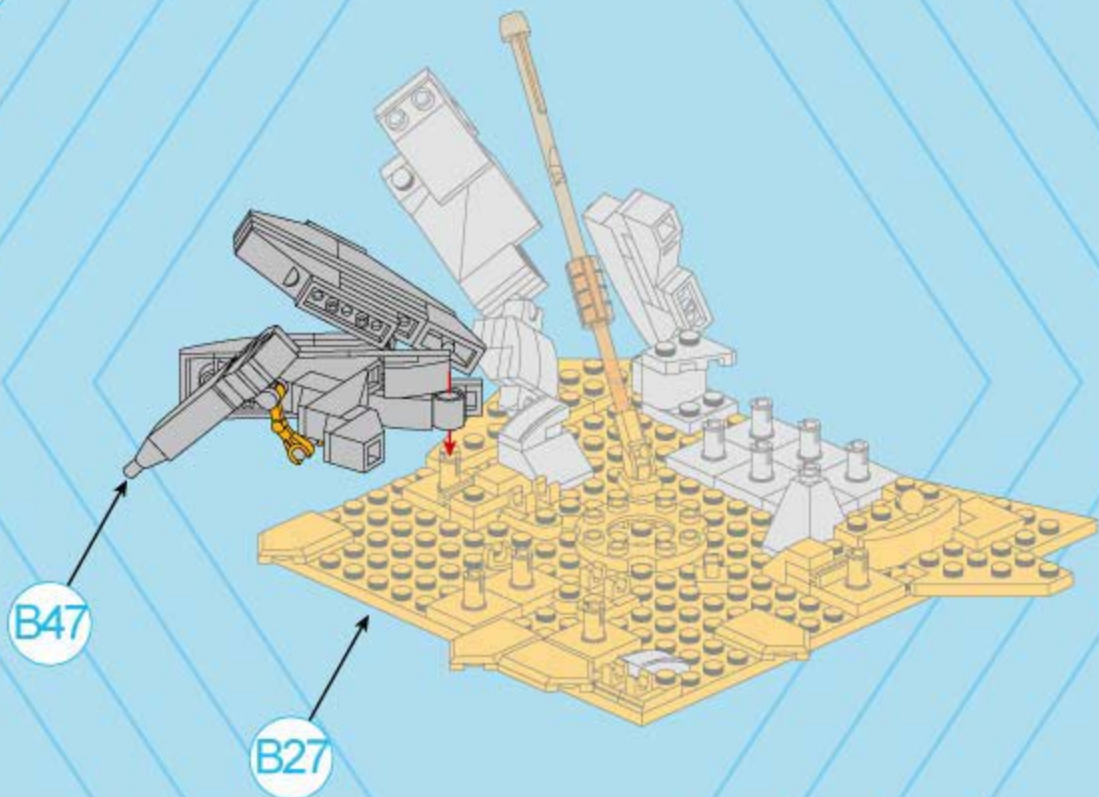

B47

B27



B49

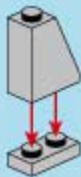
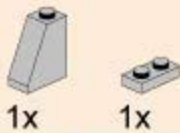

B50



B51

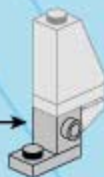
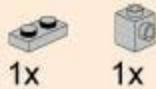

B52

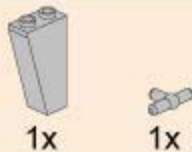

B53



1x

1x

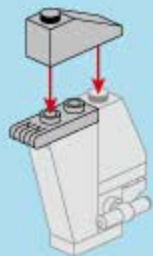

B54

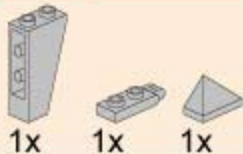

1x

1x

1x

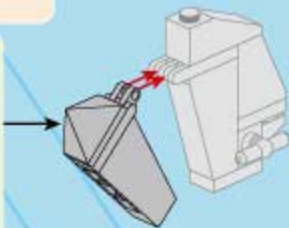
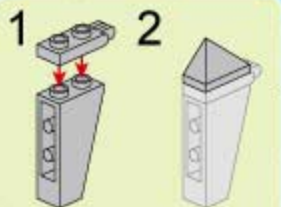

B55



2x



B56



1x

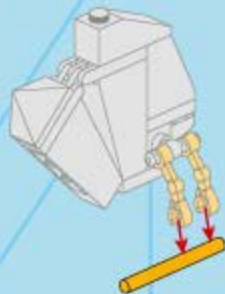

B57

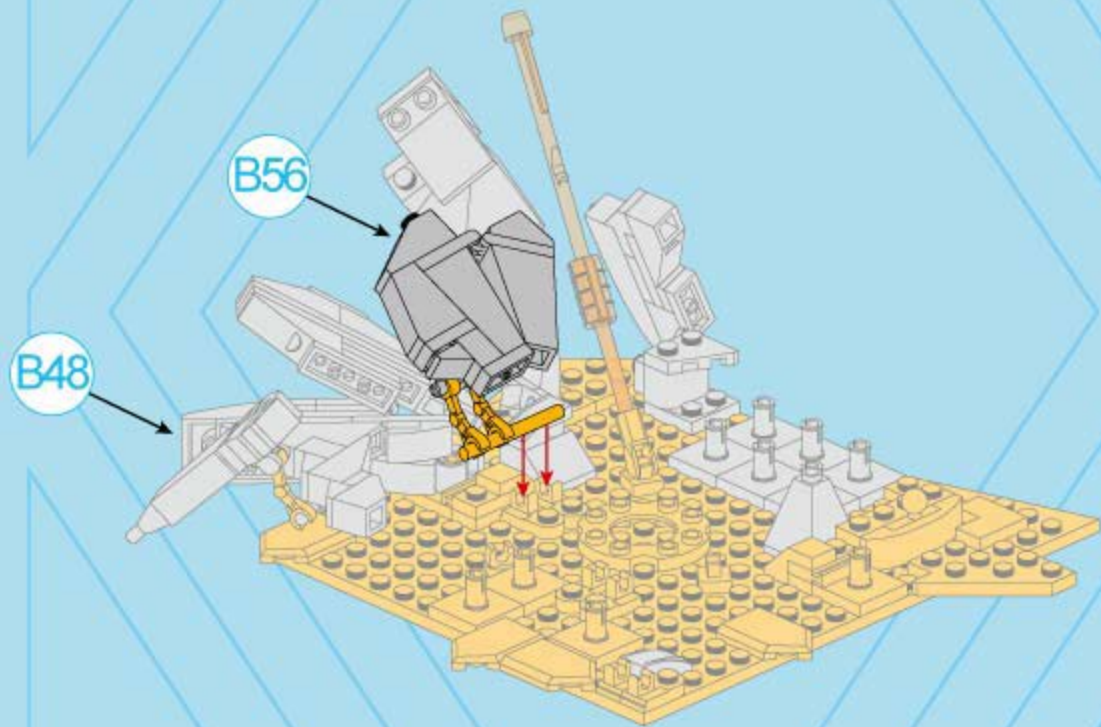

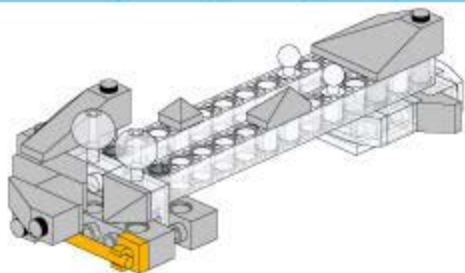

B58



2x



1x

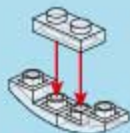

B59



1x



1x

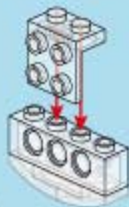

B60



2x



2x

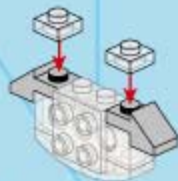

B61



1x



1x

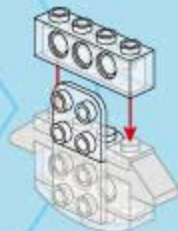

B62



1x

2x4



1x

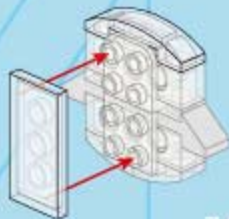

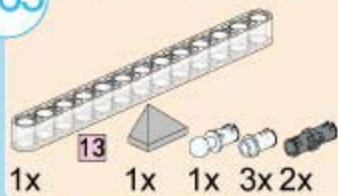
**1:1****13****B63**

1x

1x

1x

3x 2x

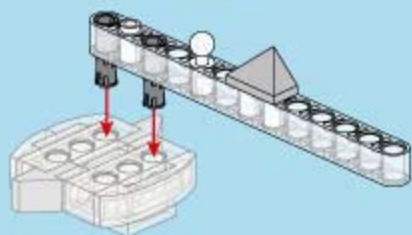
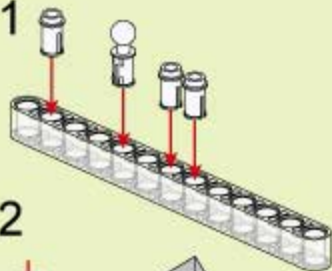
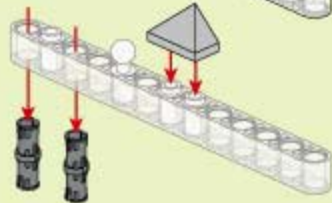
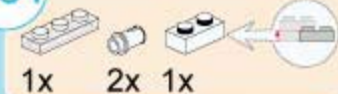
**1****2****B64**

1x

2x

1x

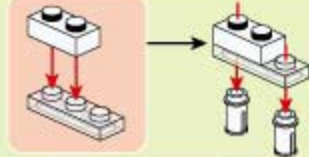
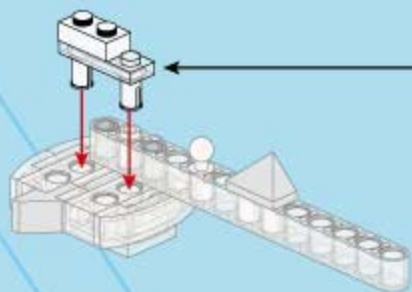

13 **1:1**

B65

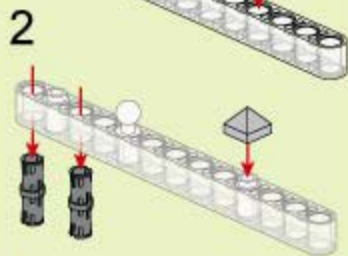
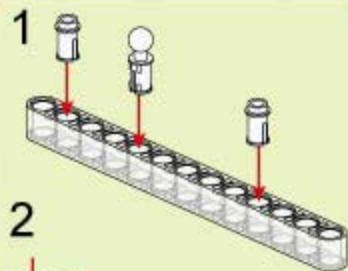
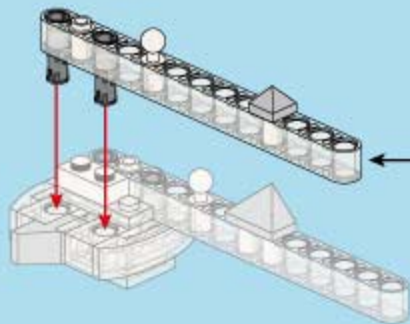
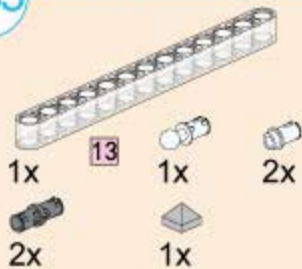

B66

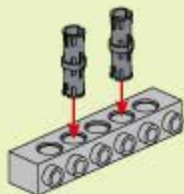
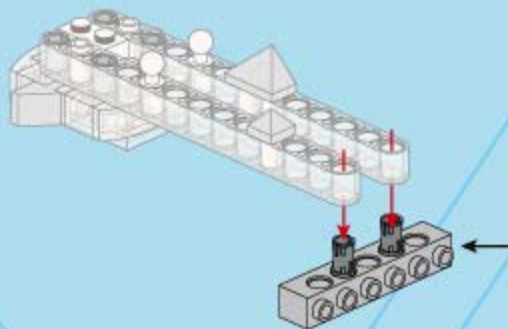
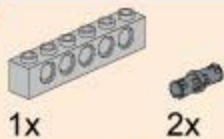

B67

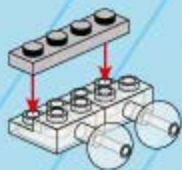
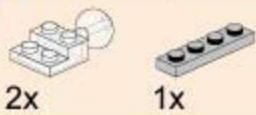

B68

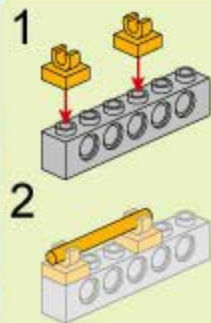
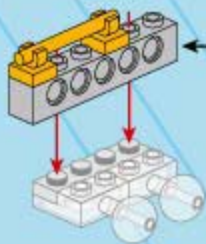
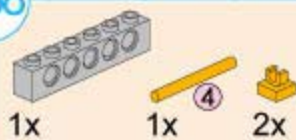

B69



B70



B71



1x



1x

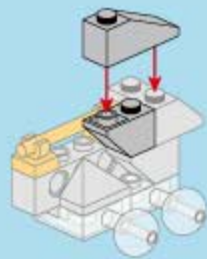

B72



B66

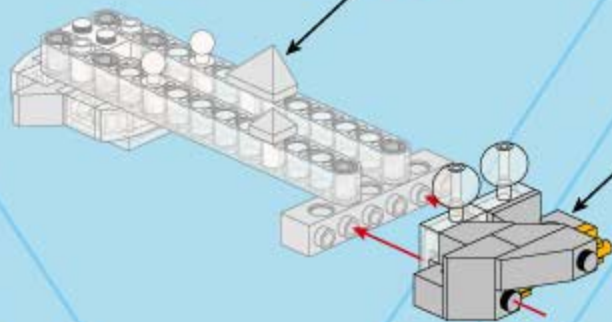

B71

B73

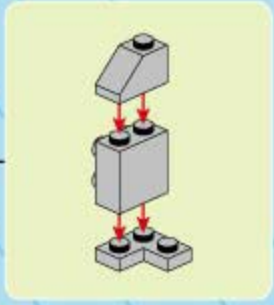
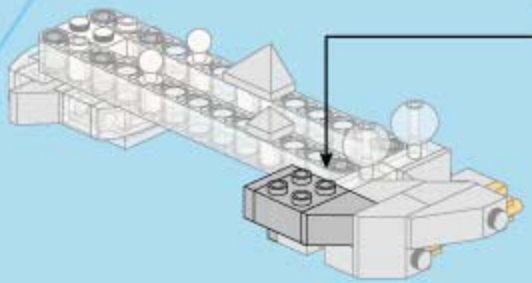
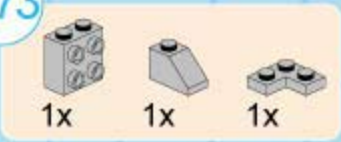

B74

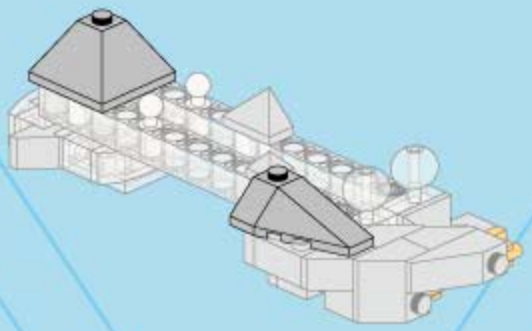
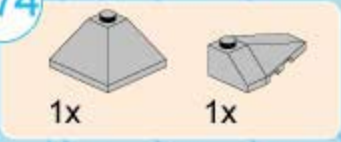

B75

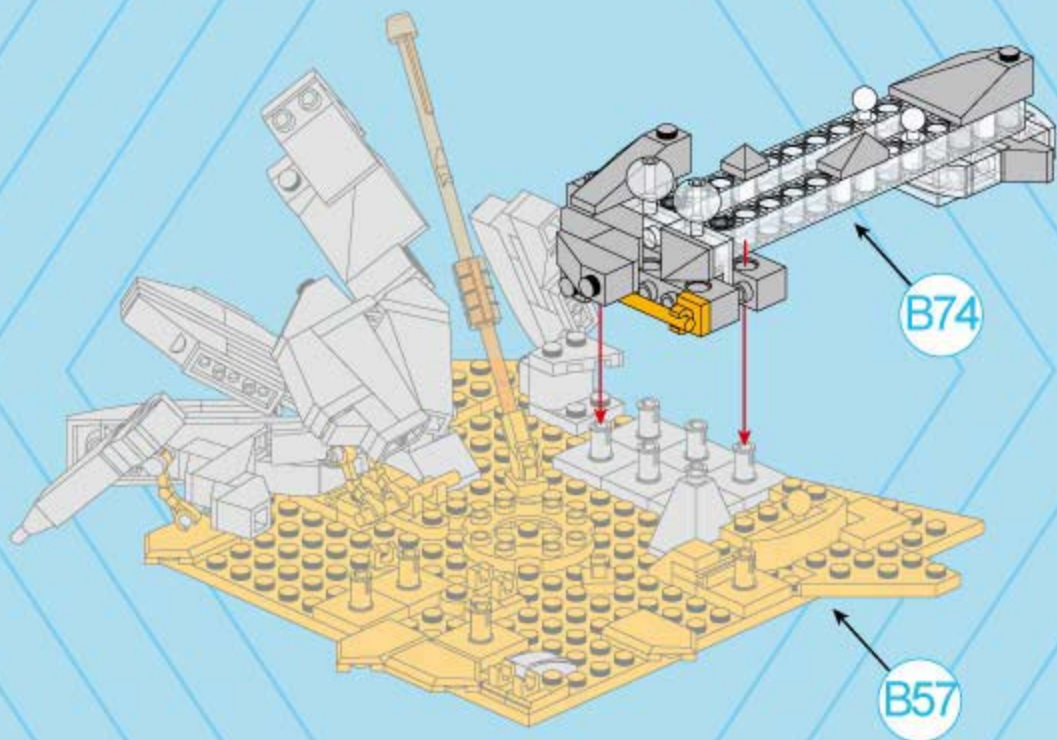

B74

B57

B76

- 1x 
- 1x 
- 1x 
- 1x 
- 1x 

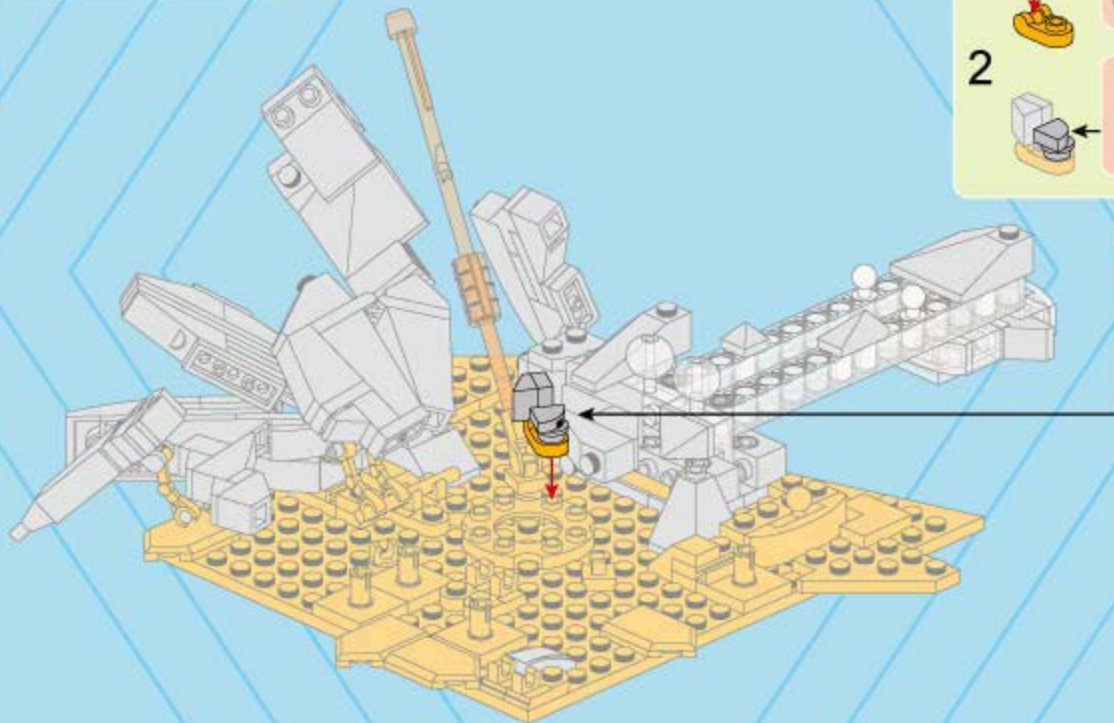
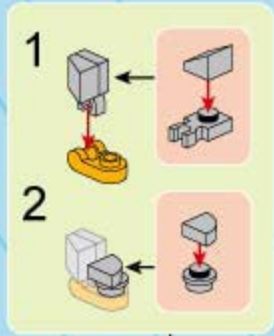

B77



1x



1x

3



2x

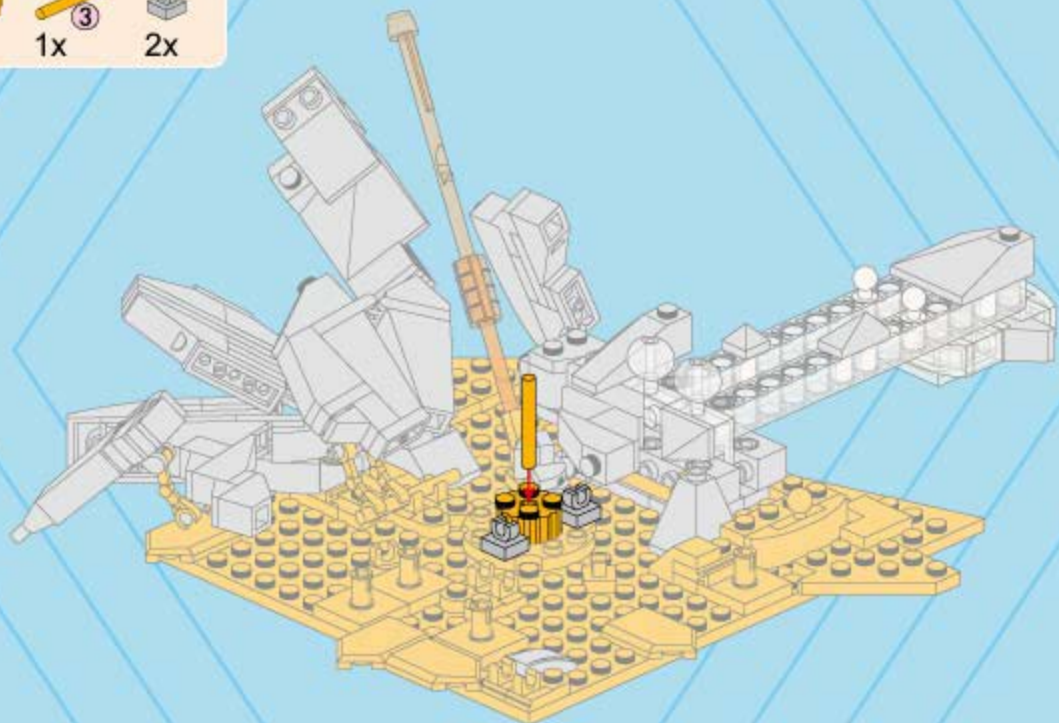

B78



2x



1x

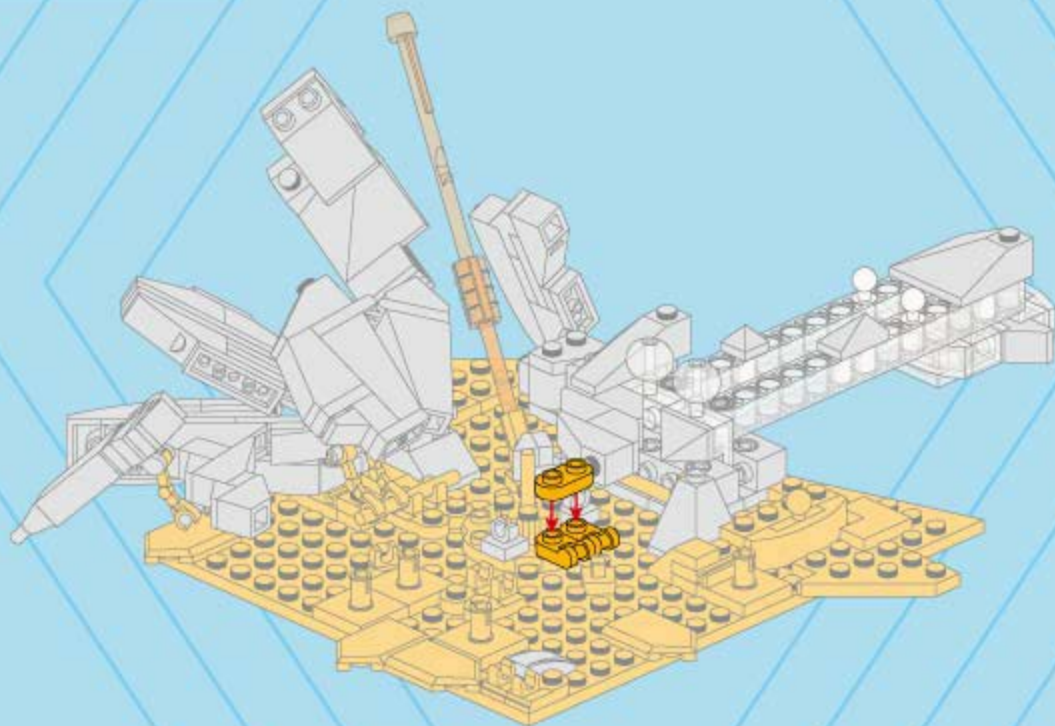

B79



2x

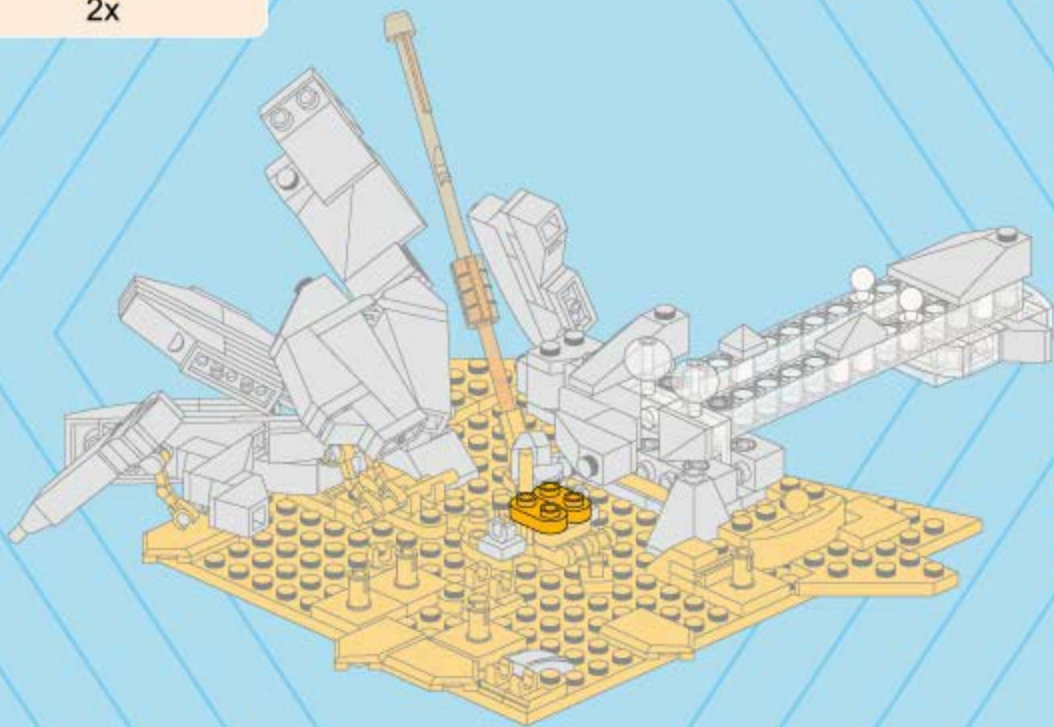

B80



2x



2x



2x

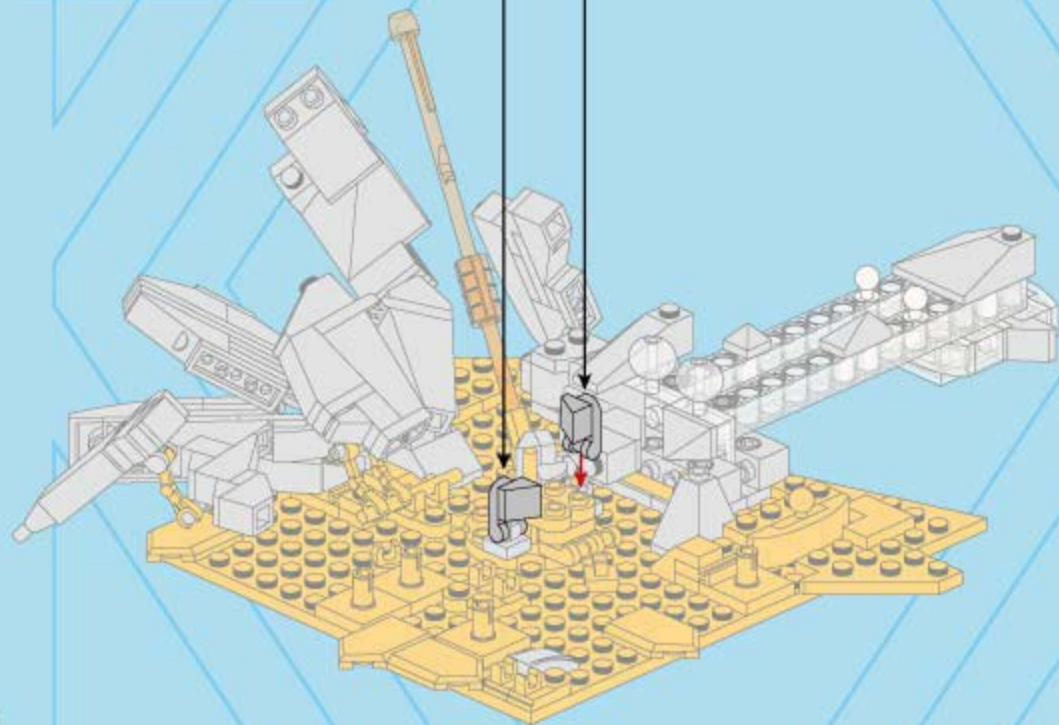

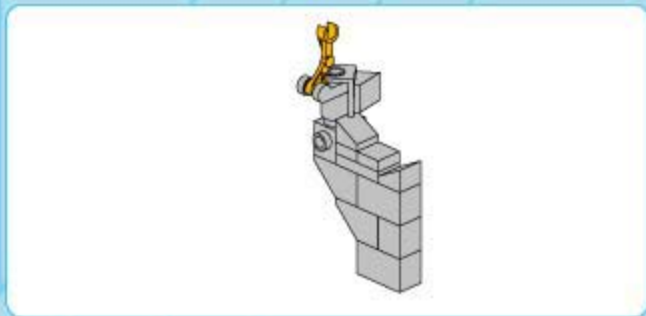

B81



1x

1x

1x

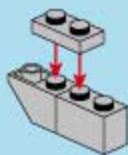

B82



2x

1x

1x

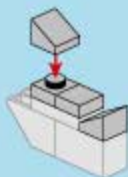

B83



1x

1x



B84



1x

1x

1x



B85



1x



1x

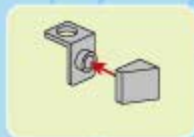

B86



1x

2



B87



B86

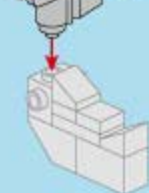

B83

B88



1x



1x



1x



1

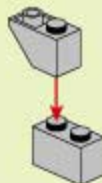

2



B89

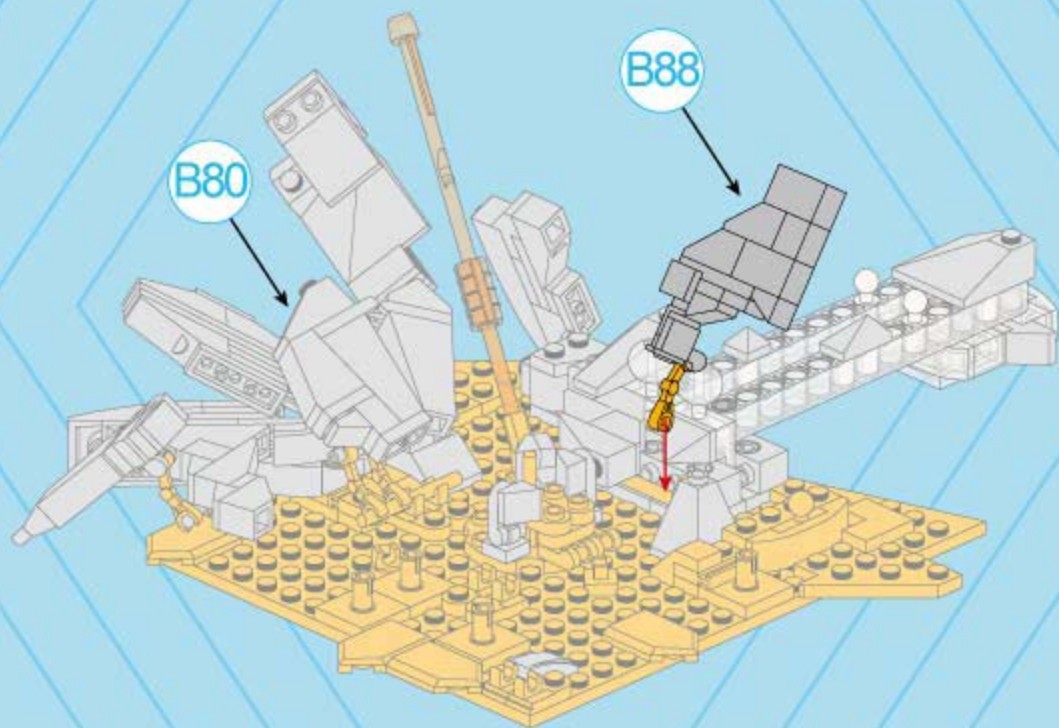

B90



1x

1x



1x

1x

1x

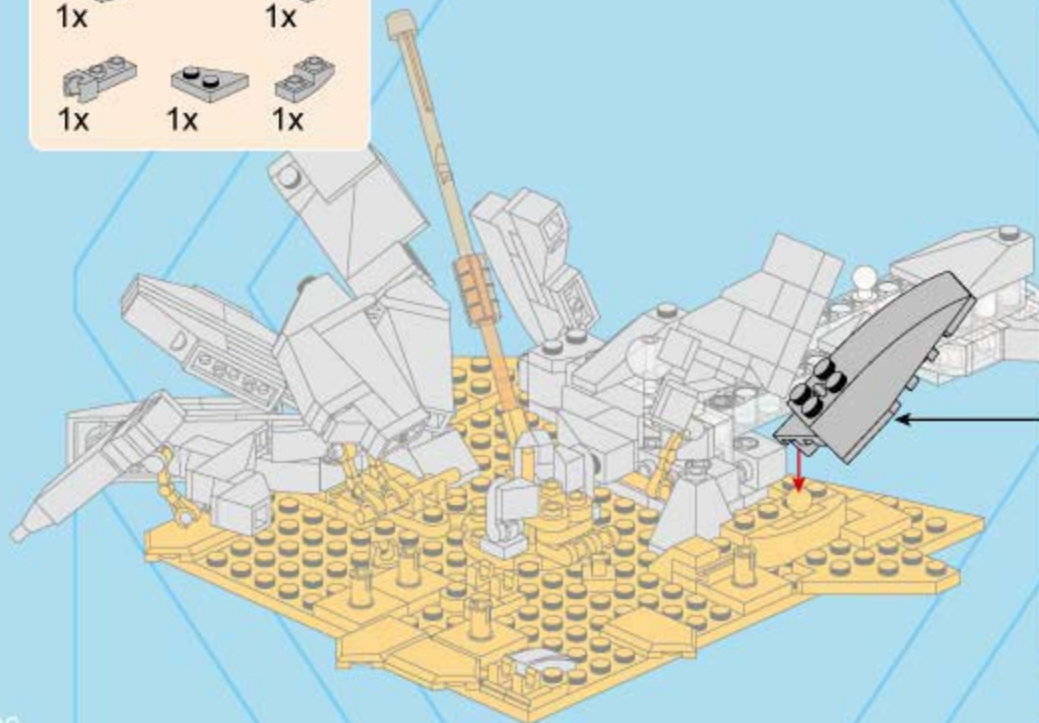

1

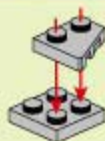

2

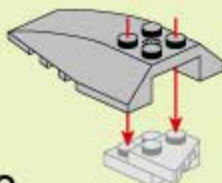

3

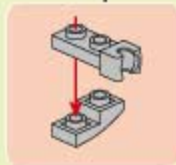

B91

- 1x
- 1x
- 1x
- 1x
- 1x

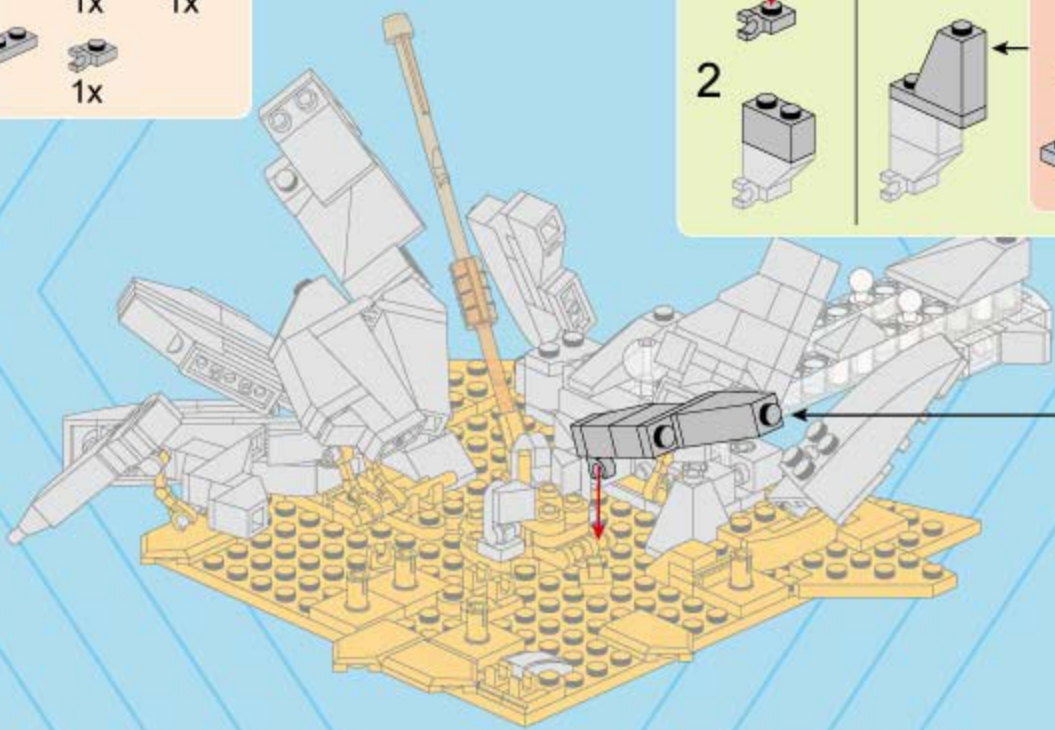
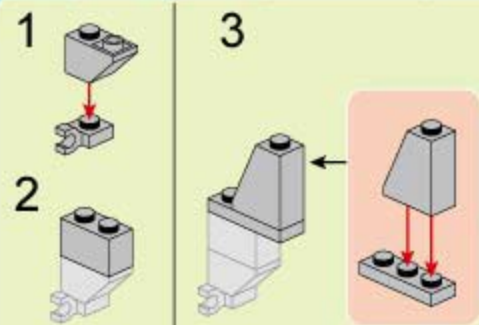

B92



1x



1x

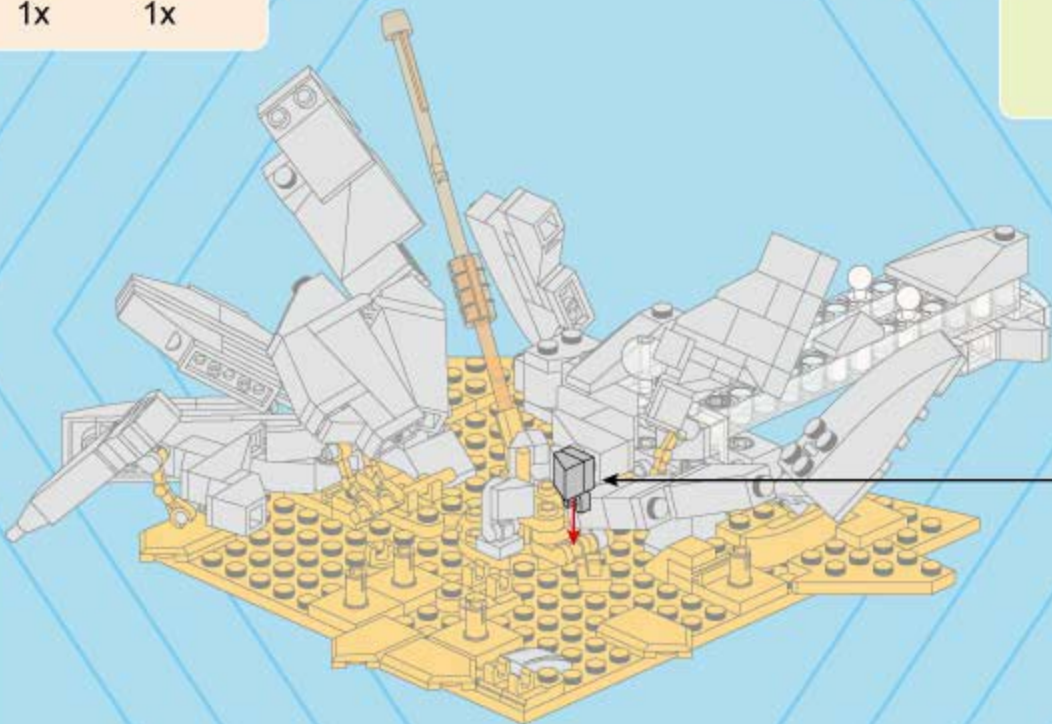

B93

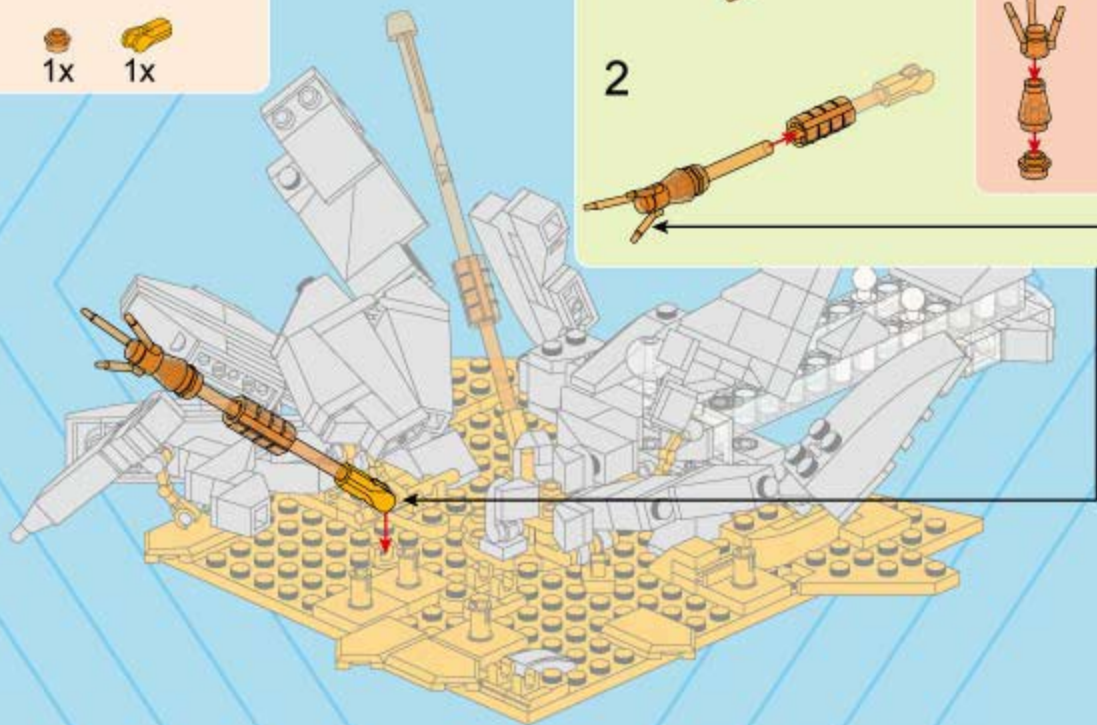
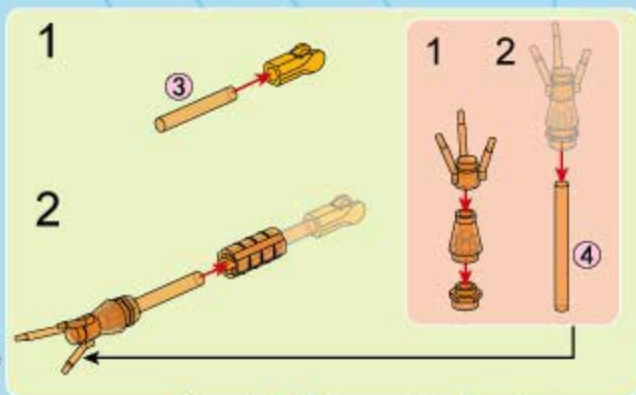

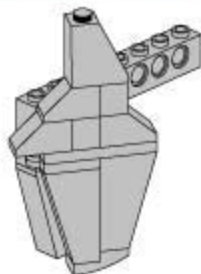

B94



1x



1x

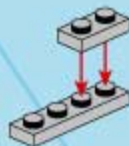

B95



1x



1x

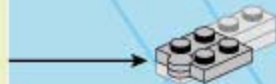
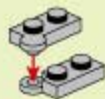

B96

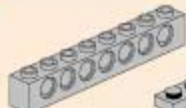

1x



1x

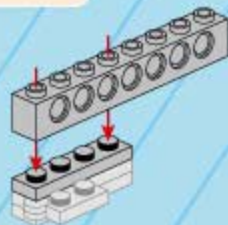

B97



1x

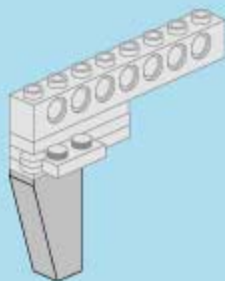

B98



2x



1x

1

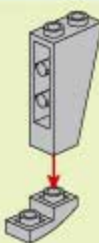

2

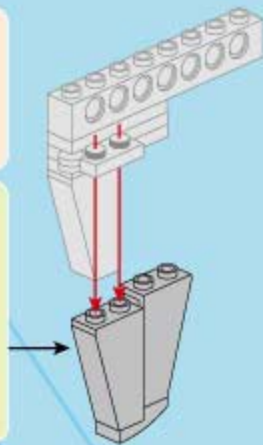
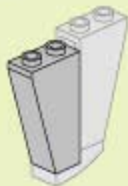

B99



1x



1x

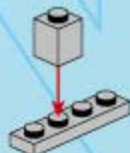

B100



2x

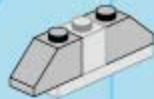

B101



1x



1x



B102



1x



B103

B102

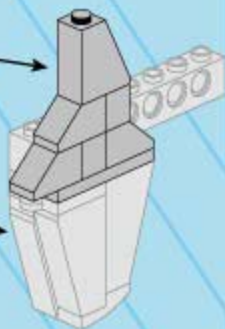

B98

B104

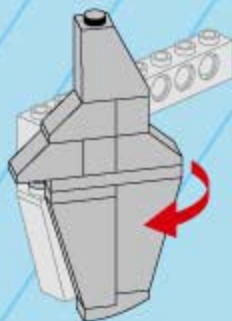

B105

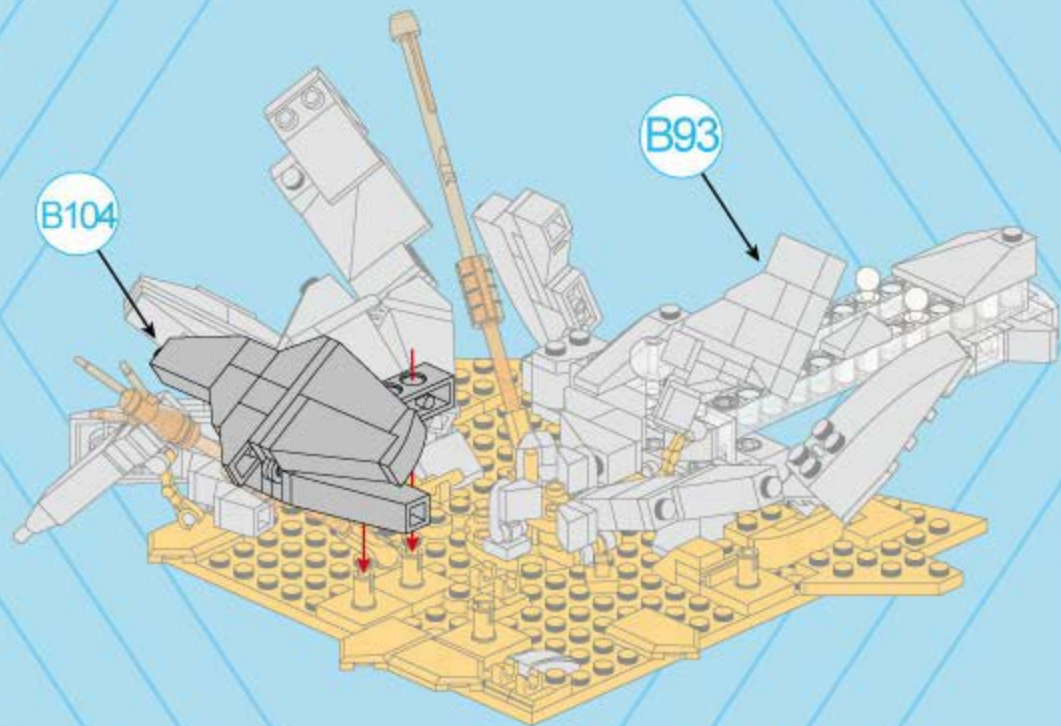

B106

- 1x [Grey Technic Slope 1x3 with Hole]
- 1x [Grey Technic Brick 1x2 with Hole]
- 1x [Grey Technic Slope 1x2 with Hole]
- 1x [Grey Technic Brick 1x1 with Hole]
- 1x [Grey Technic Brick 1x2]
- 3x [Grey Technic Brick 1x1]
- 1x [Grey Technic Pin]



1. [Grey Technic Slope 1x3 with Hole] is placed on top of [Grey Technic Brick 1x2 with Hole].
[Grey Technic Brick 1x2 with Hole] is then placed on top of [Grey Technic Brick 1x2].
2. [Grey Technic Brick 1x2] is placed on top of [Grey Technic Brick 1x2 with Hole].
An inset shows [Grey Technic Slope 1x3 with Hole] being placed on top of [Grey Technic Brick 1x2 with Hole].
3. [Grey Technic Slope 1x3 with Hole] is placed on top of [Grey Technic Brick 1x2 with Hole].
[Grey Technic Pin] is inserted into the hole of [Grey Technic Brick 1x2 with Hole].

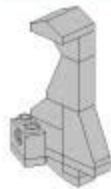
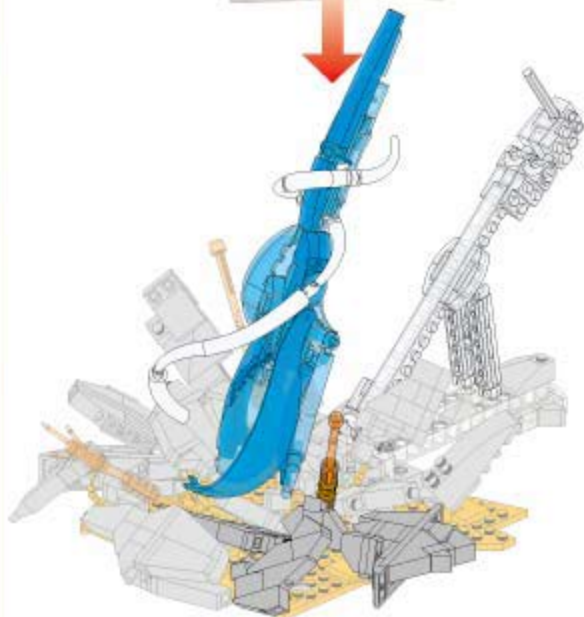

B107



1x



1x



1x

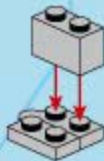
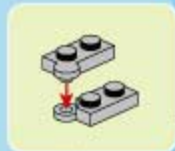

B108



1x



1x



B109



2x



1x

1

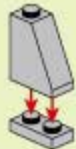

2

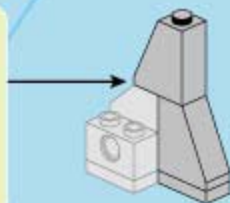

B110



1x



1x

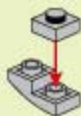

B111



1x



1x

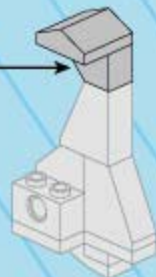
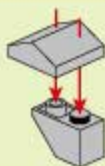

B112



B113

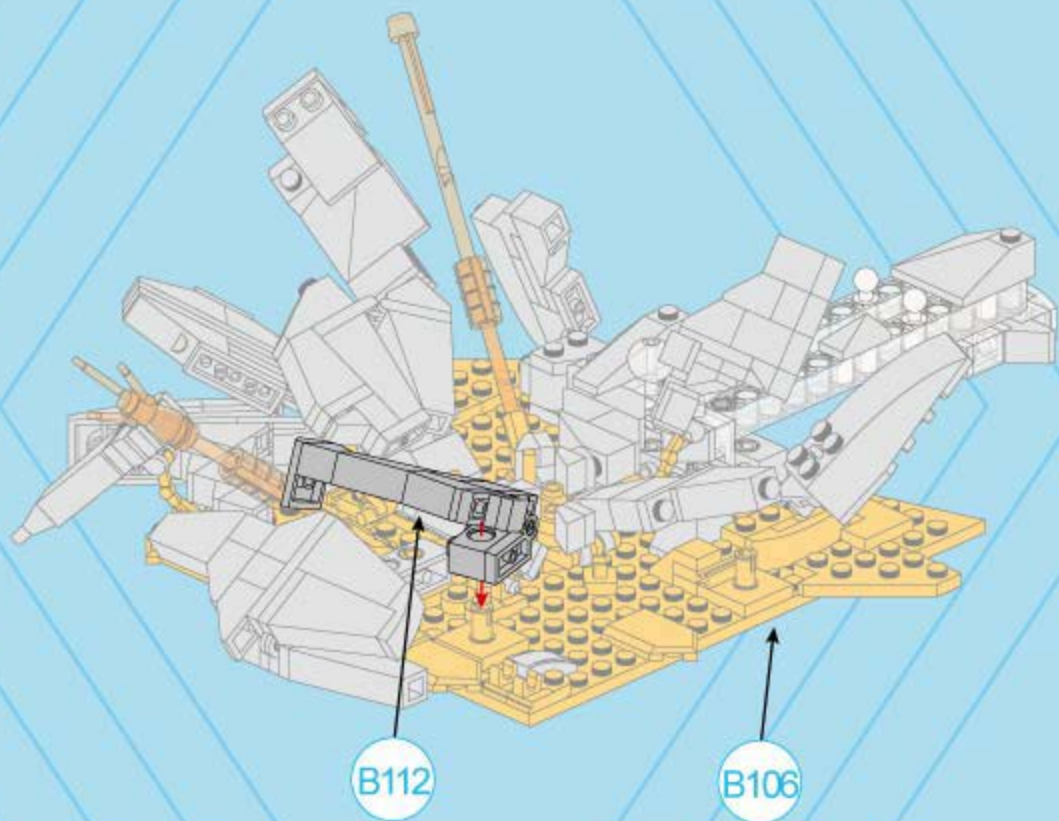

B112

B106

B114

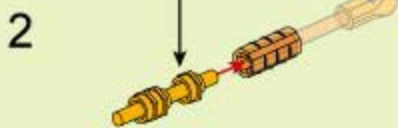
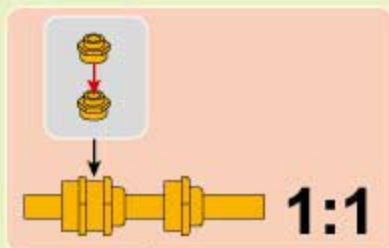
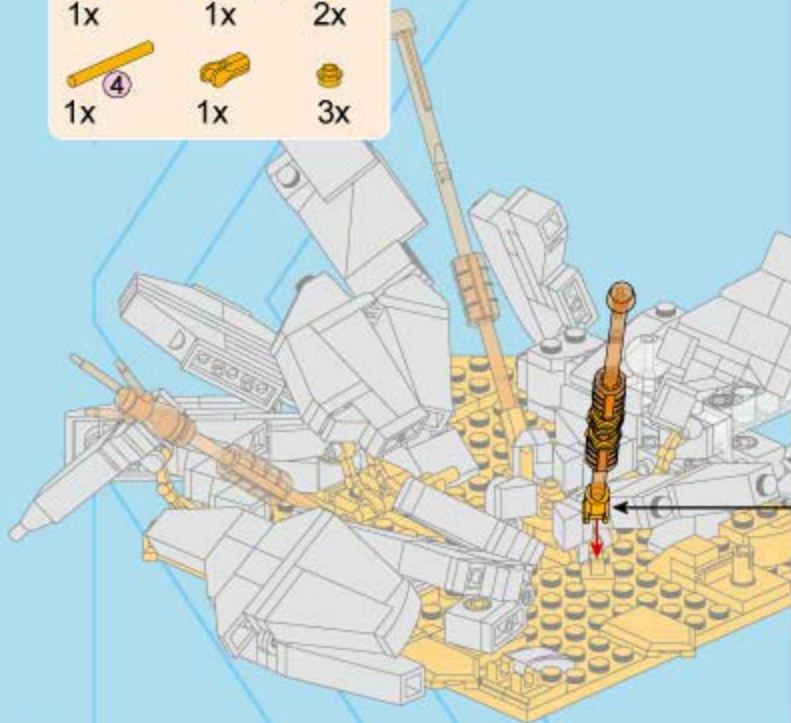
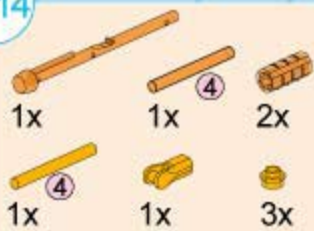

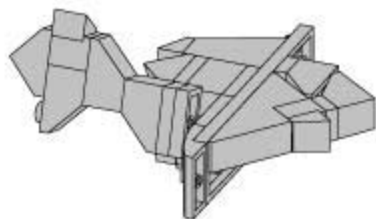

B115

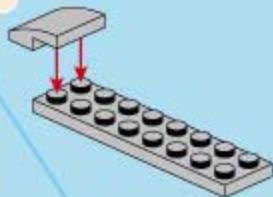
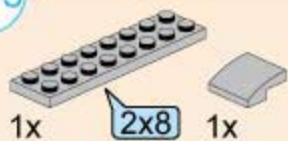

B116

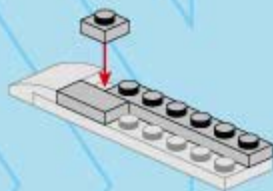
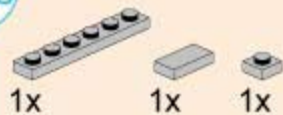

B117



B118



1x



B119



2x



1x



1x



1x

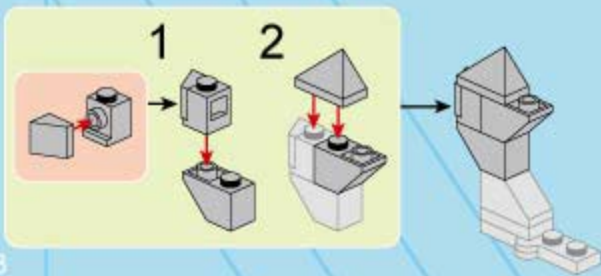

B120

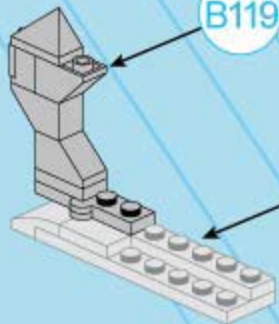

B119

B116

B121



1x



1x



1x



1x

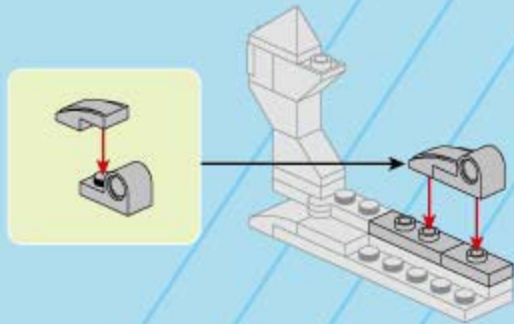

B122



1x



1x



2x

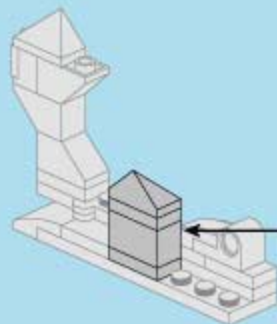

1

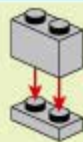

2

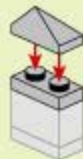

B123



1x



1x

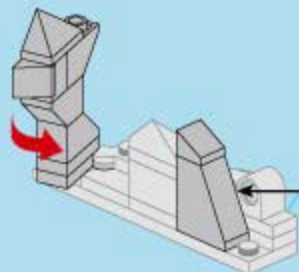

B124



1x



1x

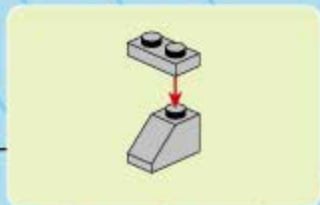
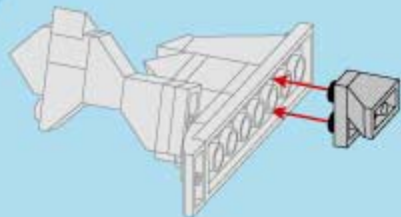

B125



1x



1x



1x



1x



1x

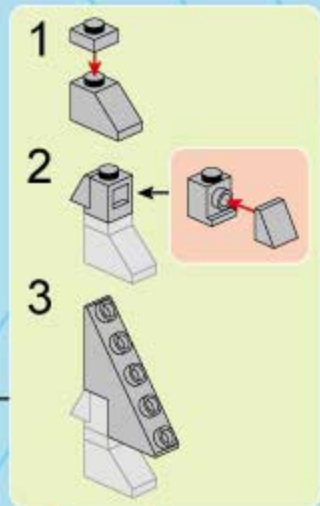
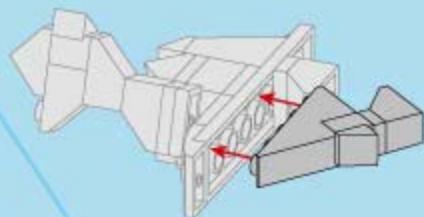

B126

B114

B125

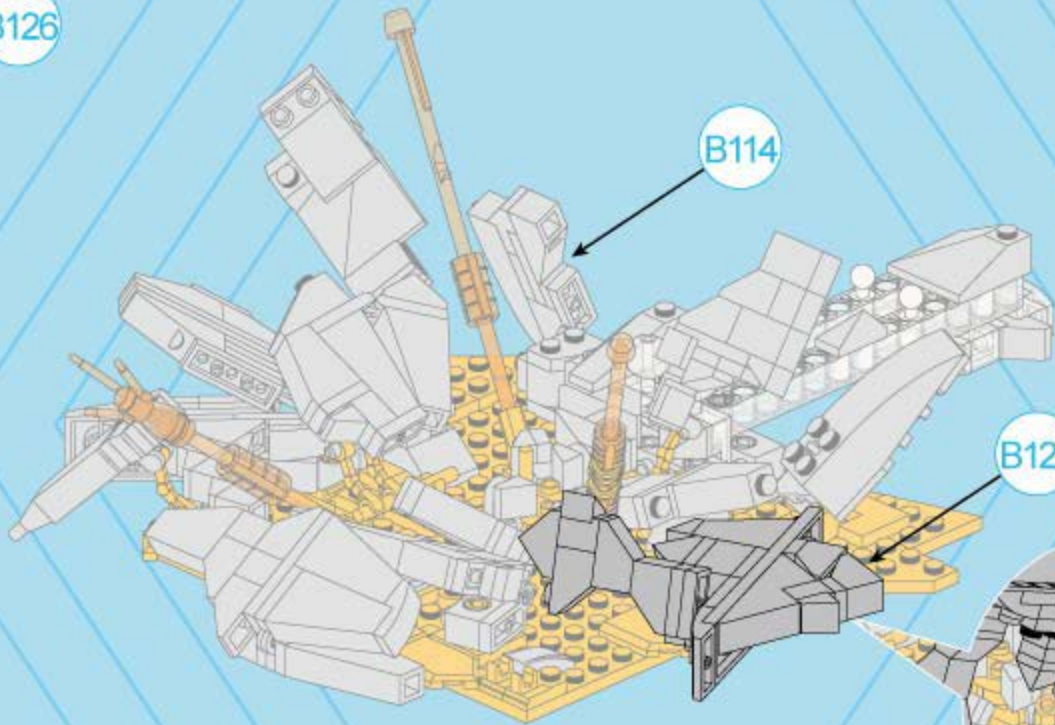

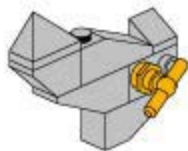

B127

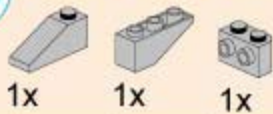

1x

1x

1x

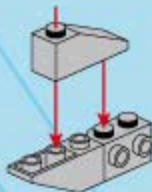

B128



1x

1x

1x

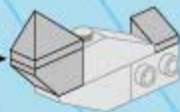
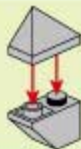

B129



1x



B130

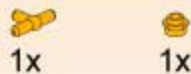

1x

1x



B131

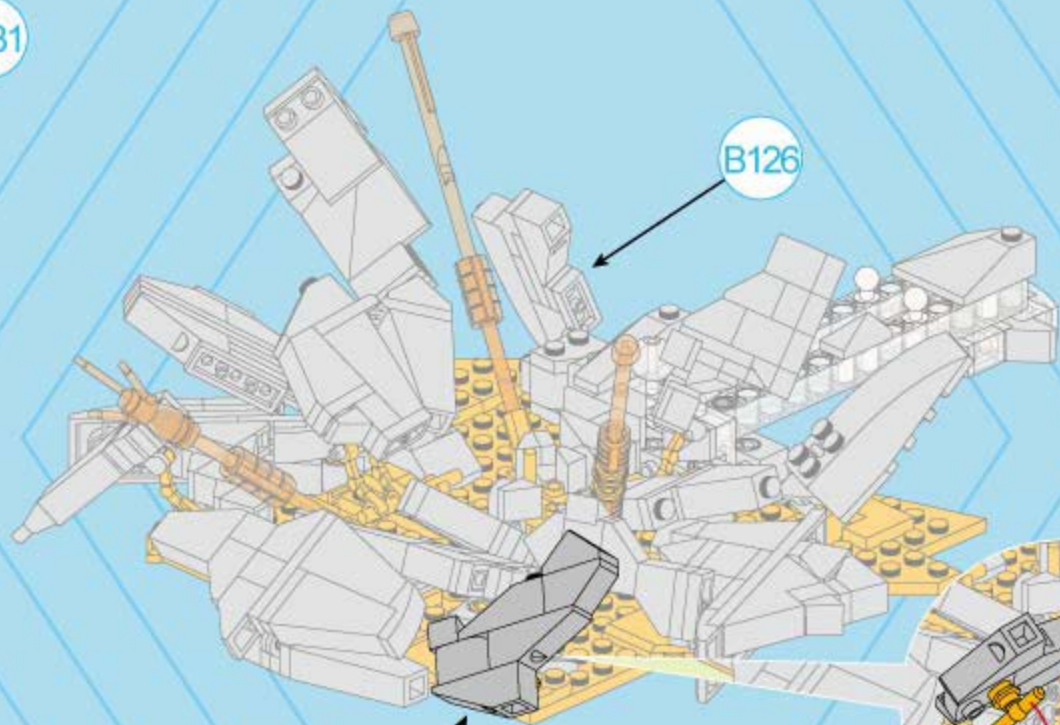

B126

B130



B132

2x 2x 1x6

1x 4x



1

2

3

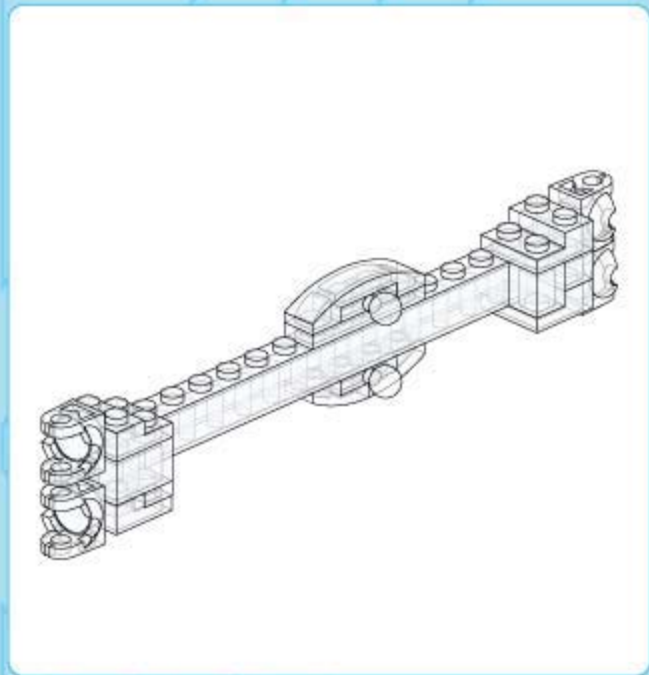

B133

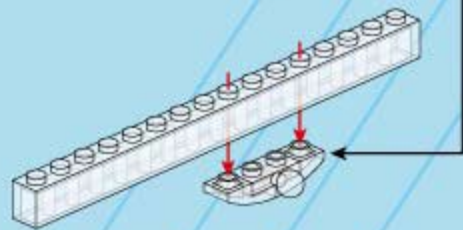
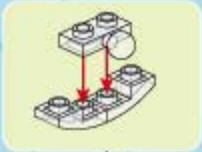
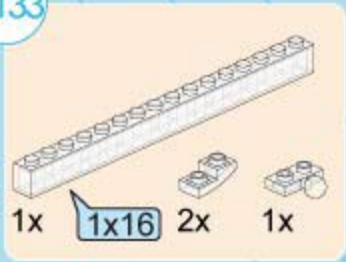

B134



1x

1x

1x



1x



1:1

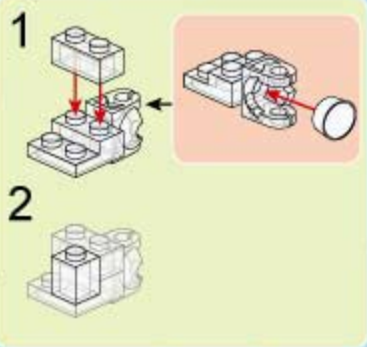
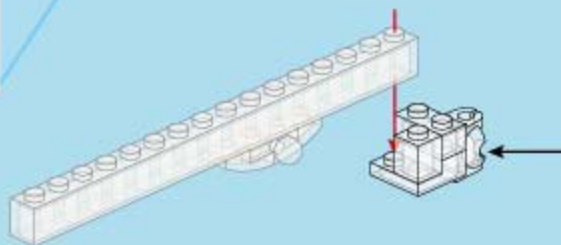

B135



1x

1x

1x

1x

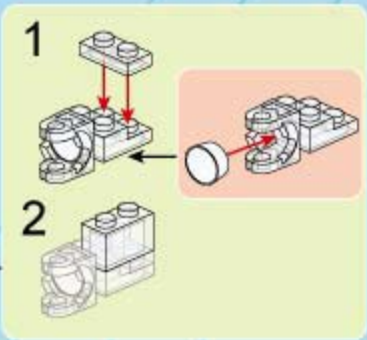
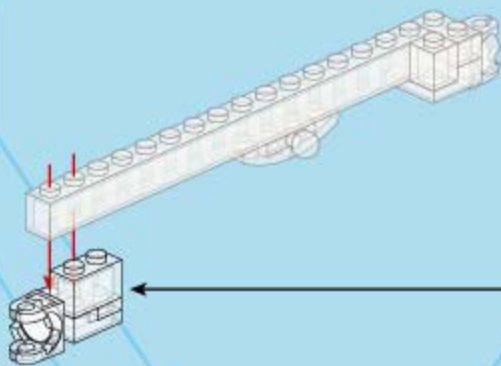

B136



2x



2x

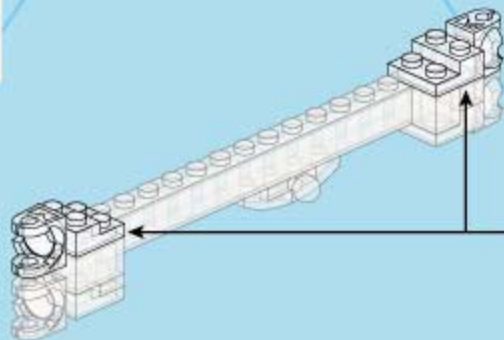

2x

B137



1x



1x



1x

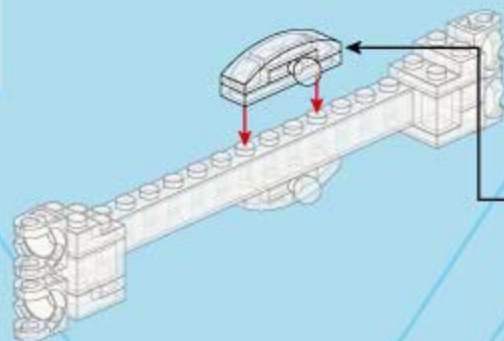

1

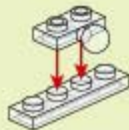

2



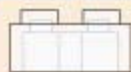

1:1

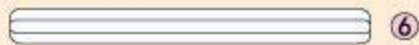

B138



2x

1x



2x



1x

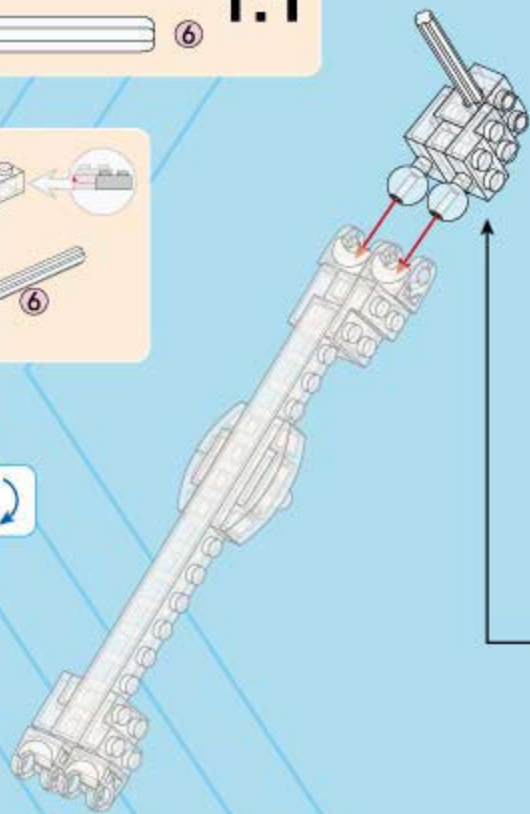

1

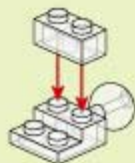

1

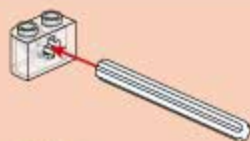

2

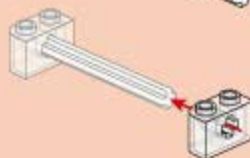

2

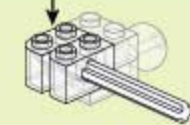

3



B139

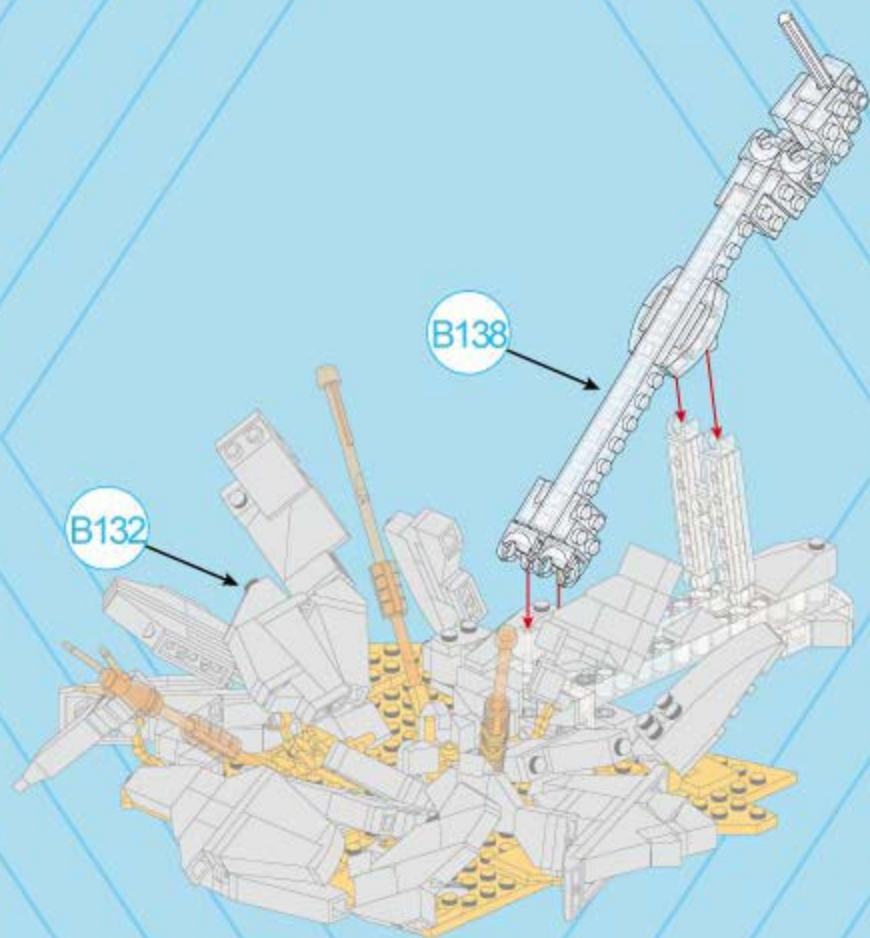

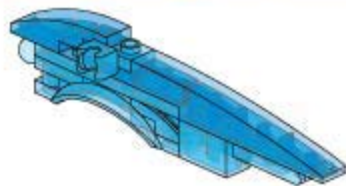
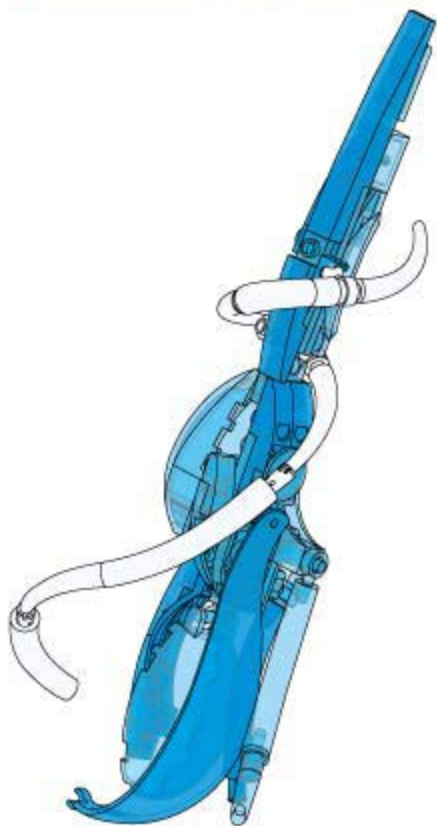

B140

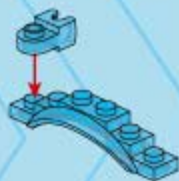
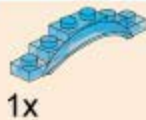

B141

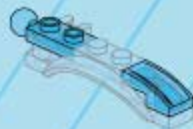

B142

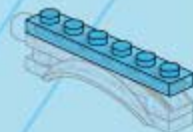

B143



B144

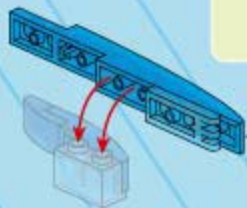
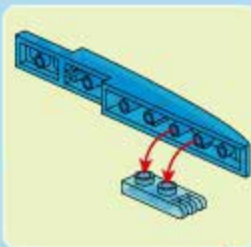
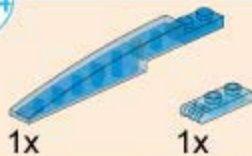

B145

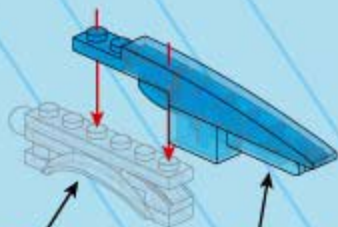

B142

B144

B146

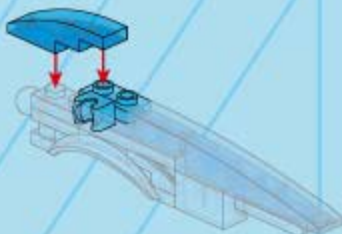
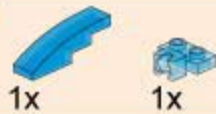

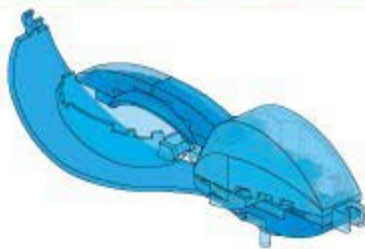

B147



1x

1x



B148

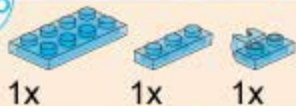

1x

1x

1x

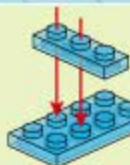

B149



1x

1x



B150



1x

1x



B151



1x

1x

1x²

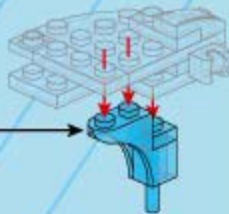
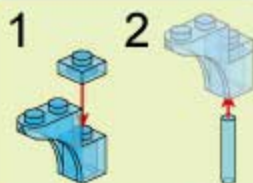

B152



1x

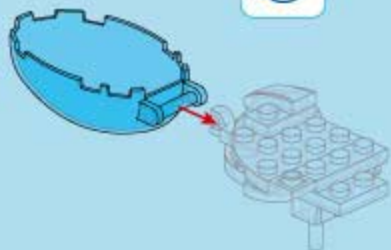

B153



1x



2x



1x



1x

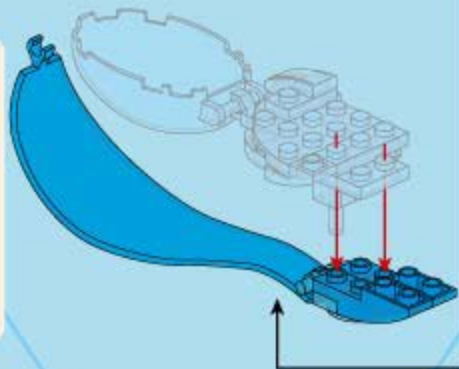

1



2



3



4

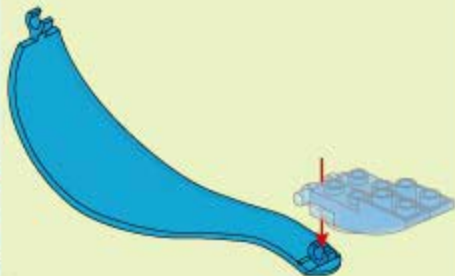

B154



1x

2x

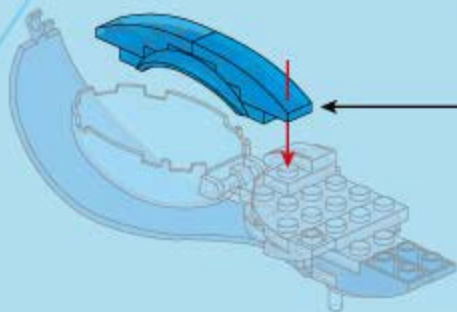

1



2

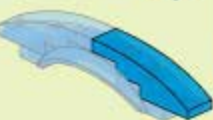

B155



1x

1x

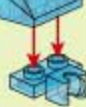
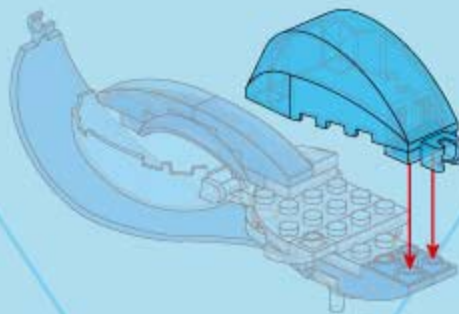

B156



1x



1x



1x

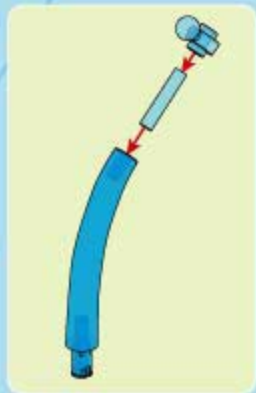

B157



1x



1x



1x



1x

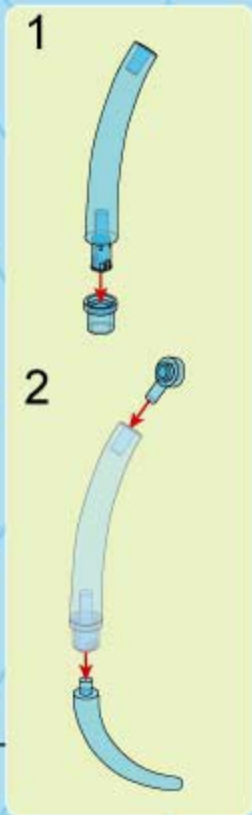
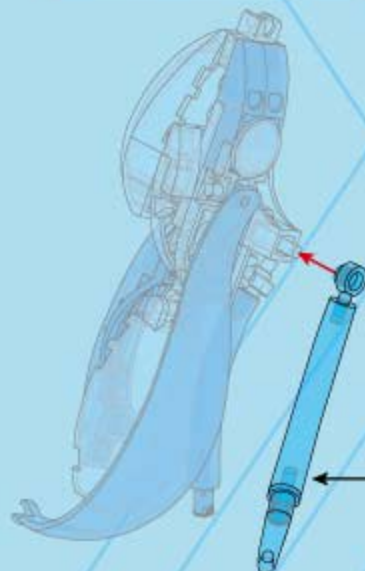

B158

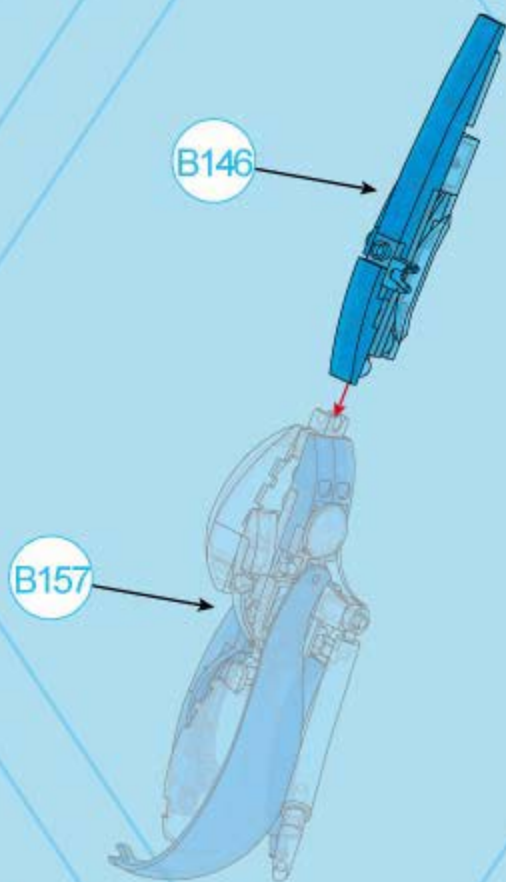

B159



1x



1x



1x



1x

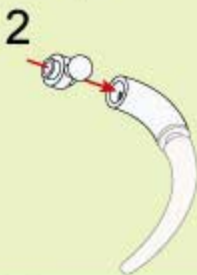
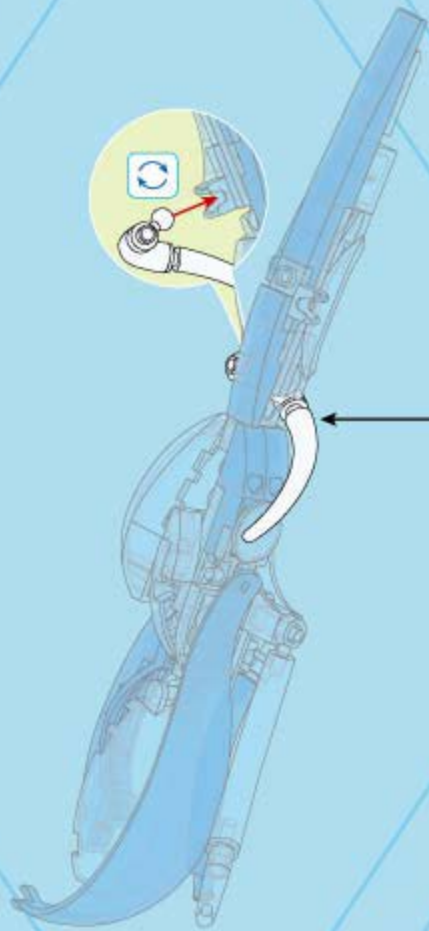

B160



2x



1x

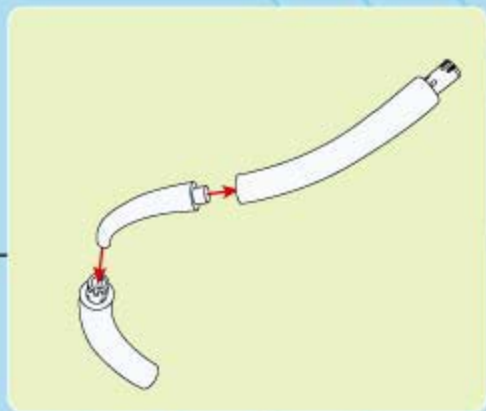
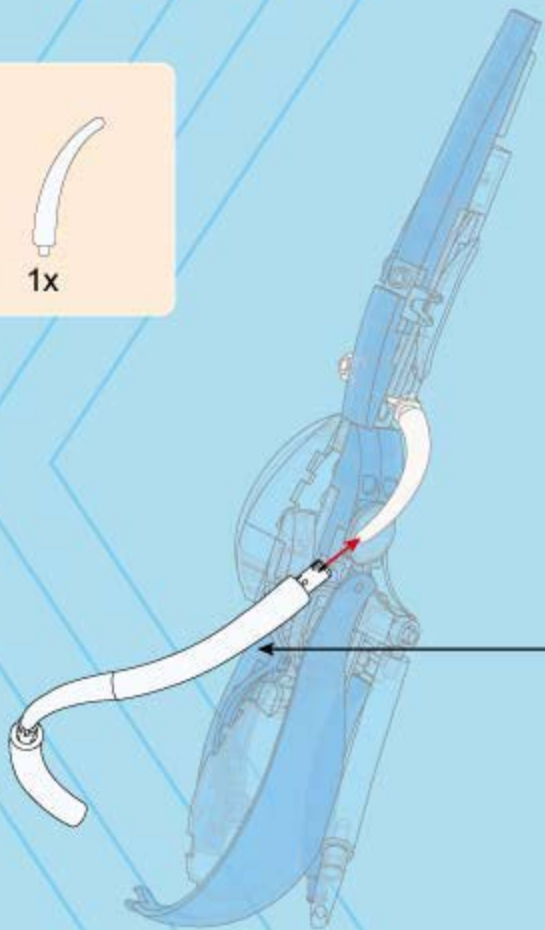

B161



2x



1x



1x



1x



1x



1x²

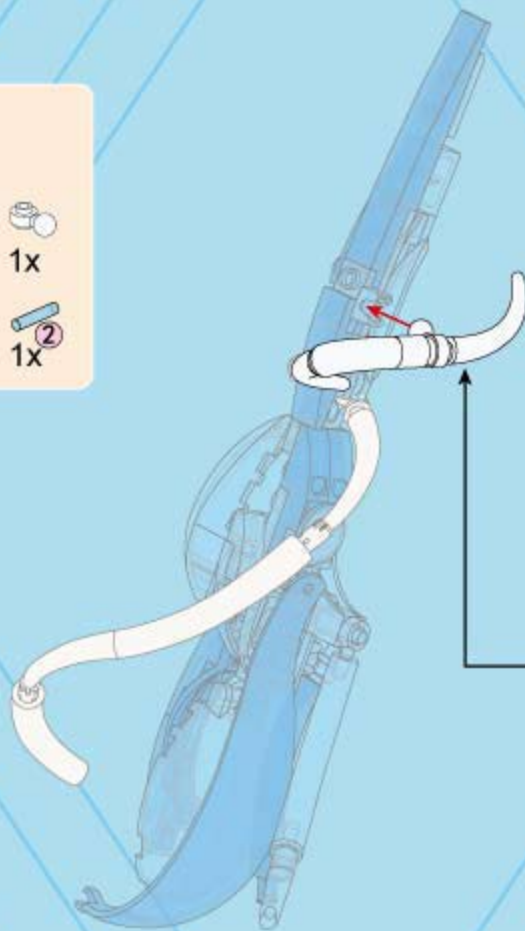

1



2

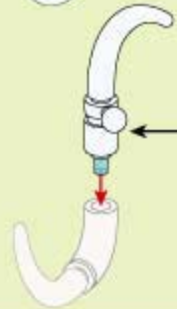

1



2



B162

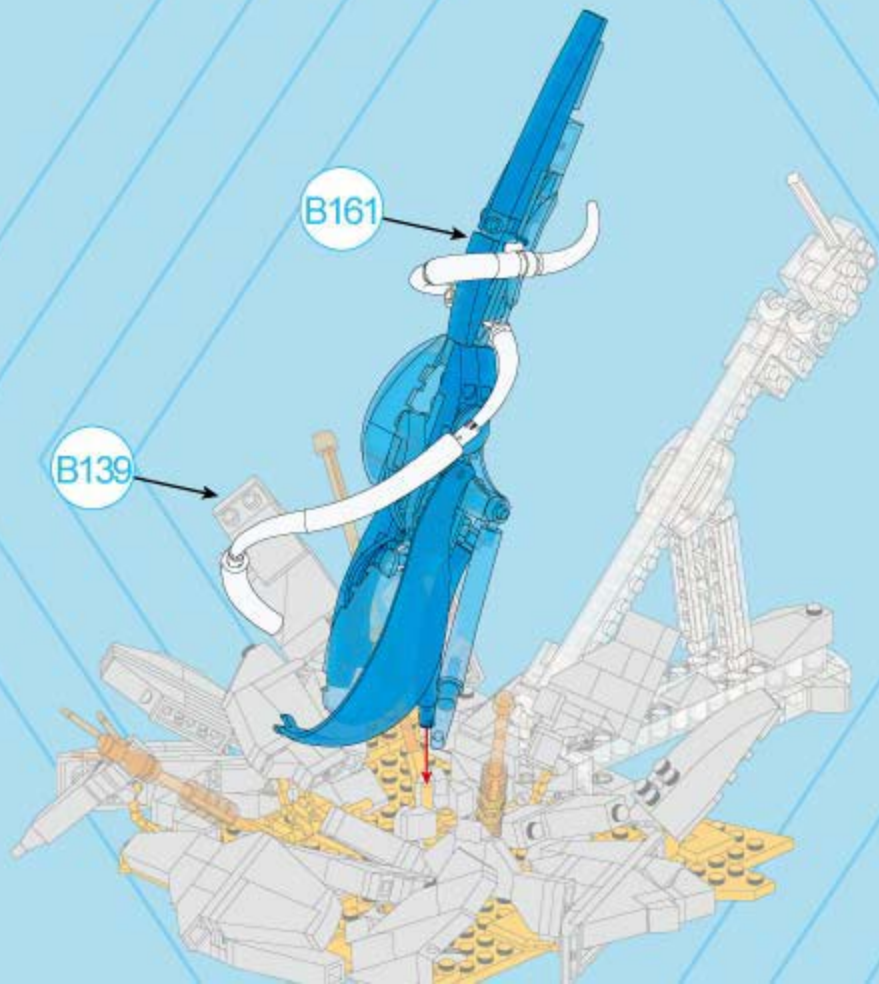

B163



A126

B162

POKÉMON
宝可梦™



V1.0