



33018

年龄:6+

人仔数:X5

片数:1253

月明仙鹤白，花舞榭歌台，
一身翩鸿过，两袖清风来。

九州
芳华录

梁扶书画



图片仅供参考，请以实物为准。

花月水舞楼



中国舞

中国在五千年以前就已经出现了舞蹈，它产生于奴隶社会，发展到秦汉之际已形成一定特色。我国古代乐舞理论中有：“情动于中而行于言，言之不足故嗟叹之；嗟叹之不足故咏歌之；咏歌之不足，不知手之舞之足之蹈之也。”

中国舞是中国古典舞与中国民族舞、民间舞的一个“泛称”，创立于二十世纪五十年代，它借鉴结合了芭蕾舞的训练体系，并融合中国武术、传统戏曲、民间杂技的手、眼、身、法、步等技术。翻身是中国舞的民族技巧，在跳的过程中呈现：拧、倾、翻、闪、展、腾、挪。



我昔元和侍宪皇，曾陪内宴宴昭阳。

千歌万舞不可数，就中最爱霓裳舞。

舞时寒食春风天，玉钩栏下香案前。

案前舞者颜如玉，不著人间俗衣服。

虹裳霞帔步摇冠，钿璫累累佩珊珊。

娉婷似不任罗绮，顾听乐悬行复止。

——【唐】白居易《霓裳羽衣舞歌》节选



建议在成人陪同
监护下使用



远离火源



请勿投掷



请勿吞食



注意空隙



按分装包来搭建

搭建手册使用说明

1

搭建步骤图



切换方向

2x

搭建零件所需数量

搭建步骤详解

1

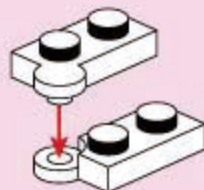

2

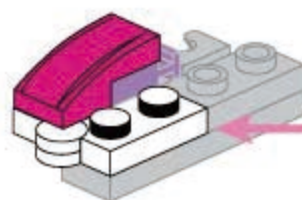
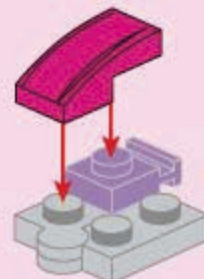

搭建步骤图

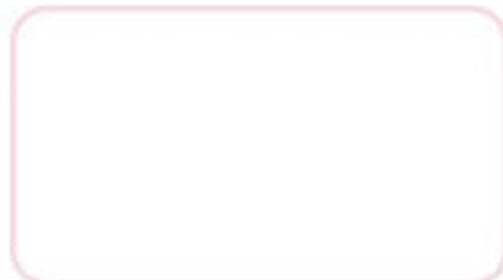

区域完成效果图

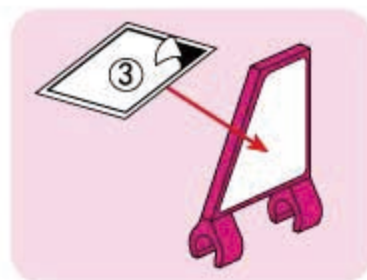

贴上贴纸

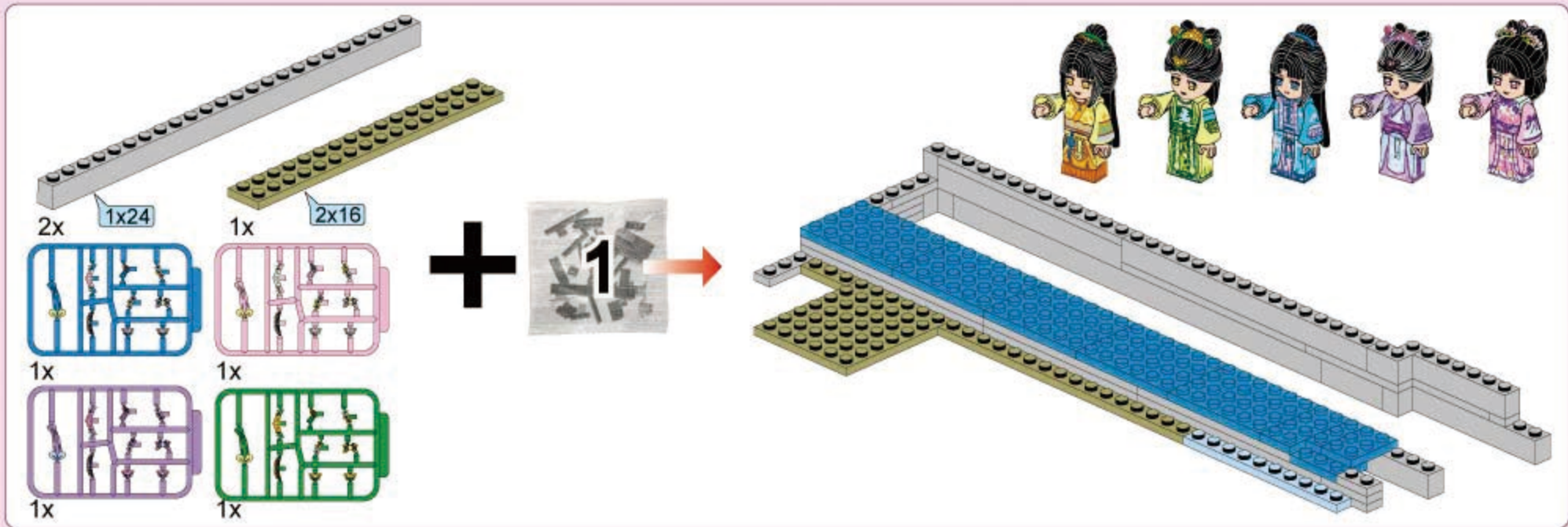

拆件器使用方法，仅为示例

Usage of Brick Separator, Just for the sample

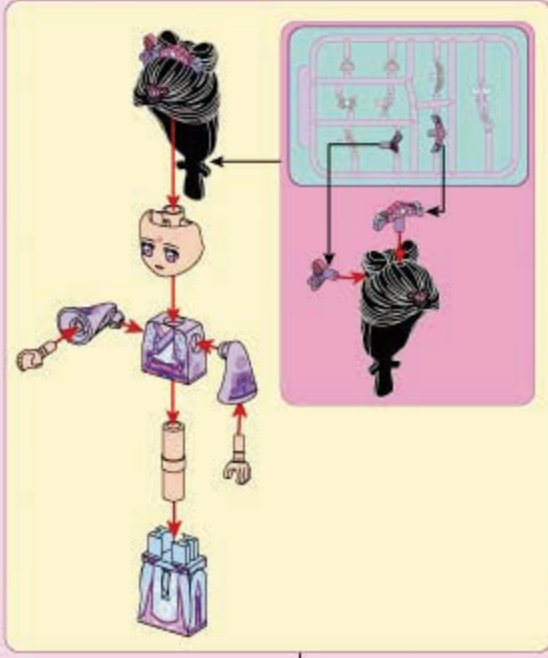
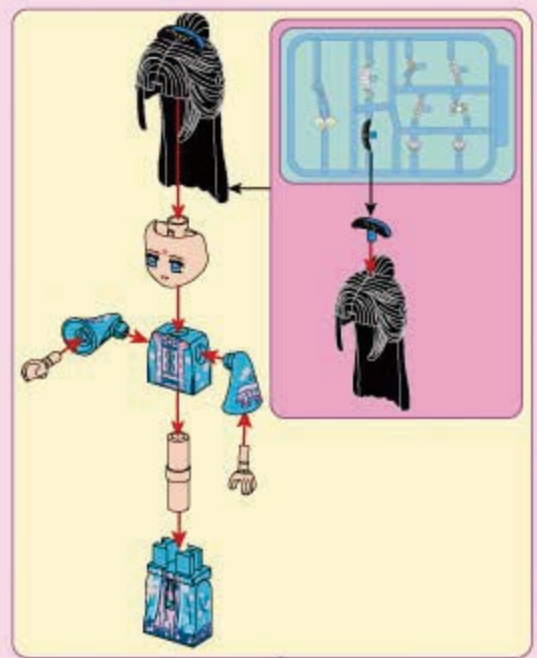
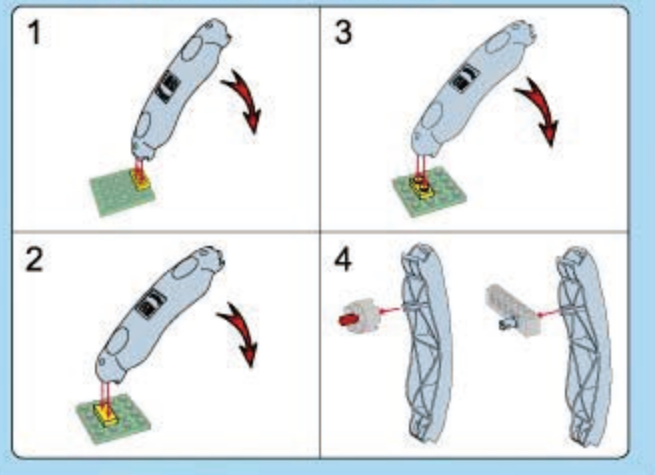

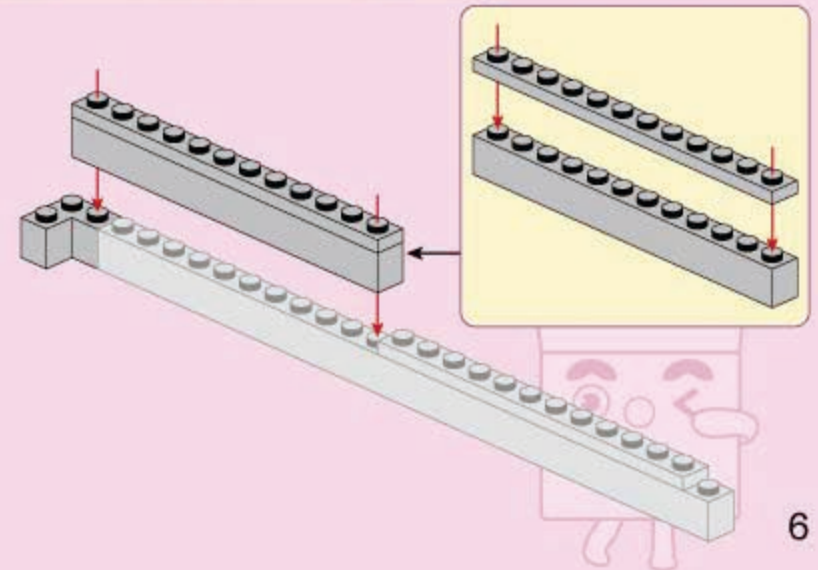
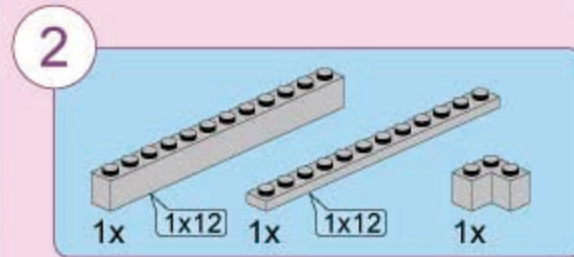
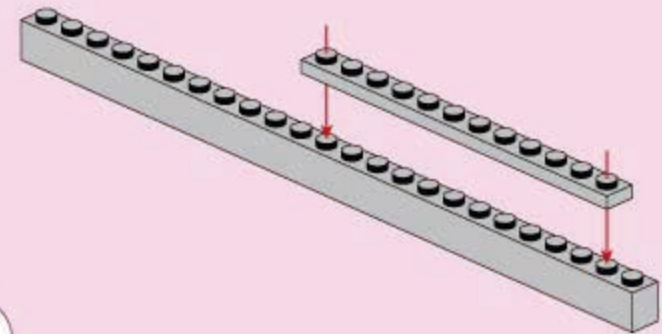
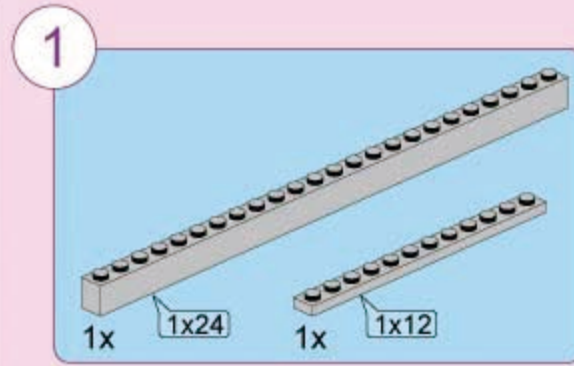
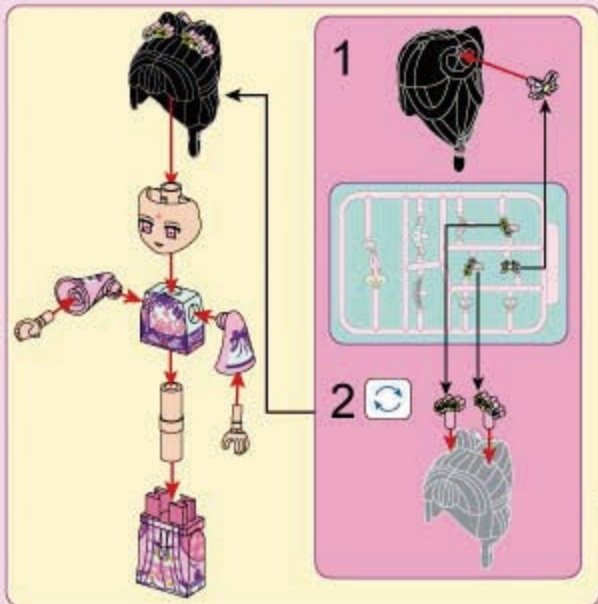
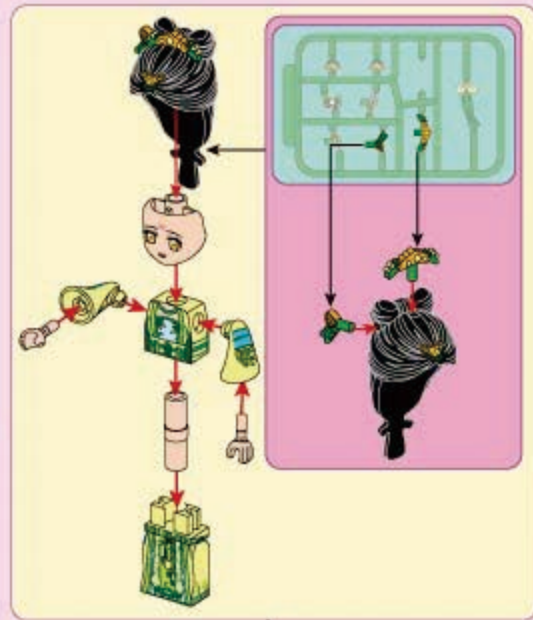
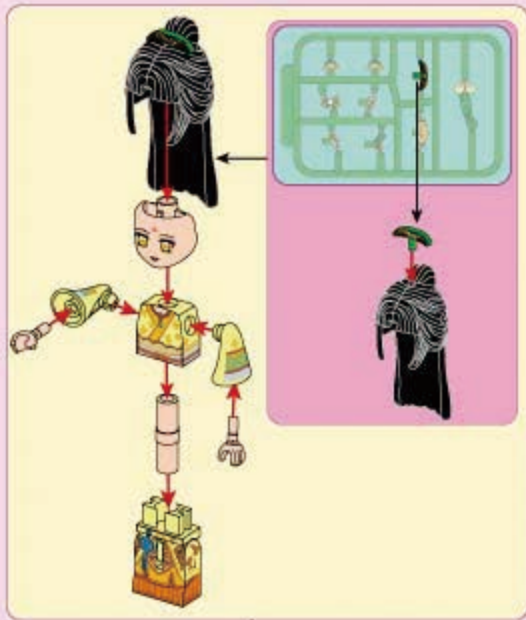

3

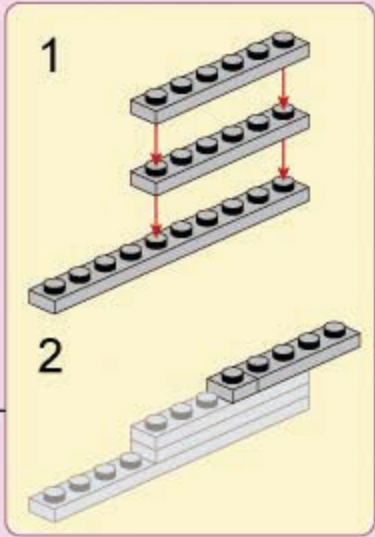
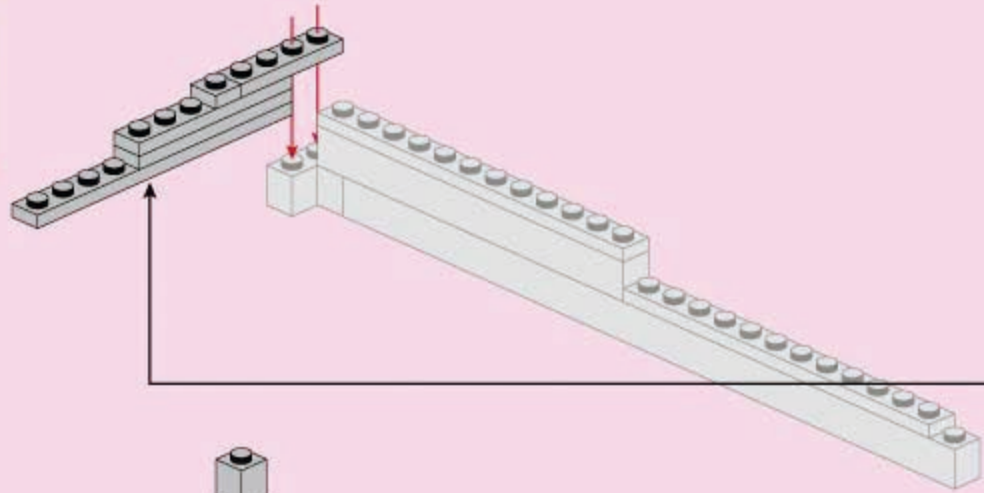
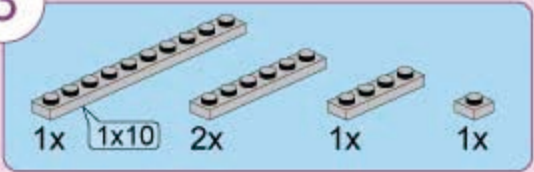

4

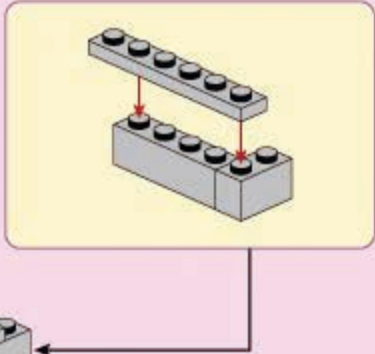
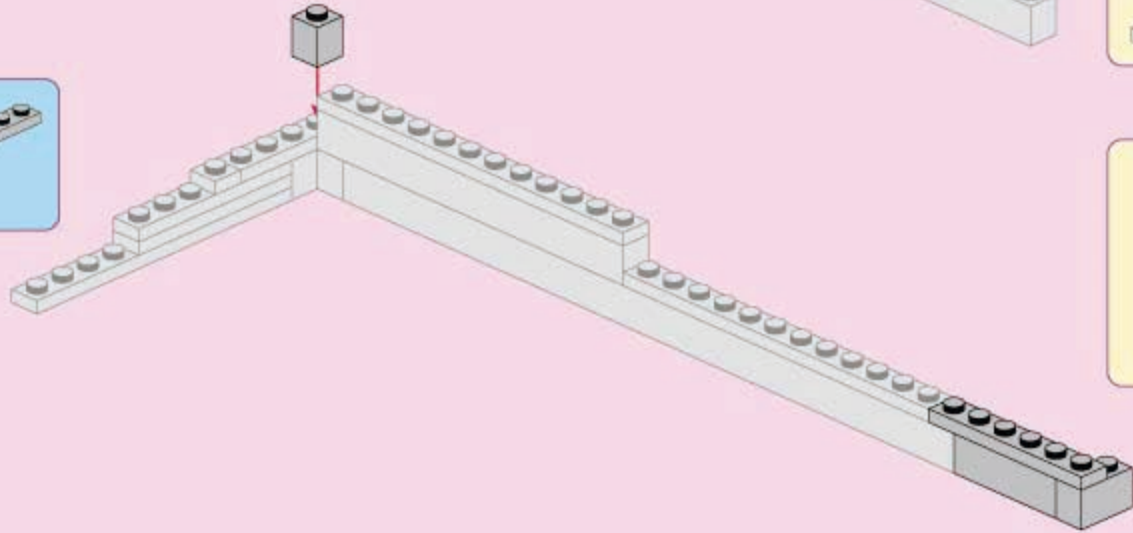
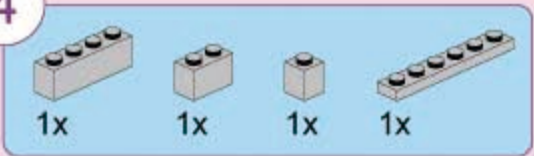

5

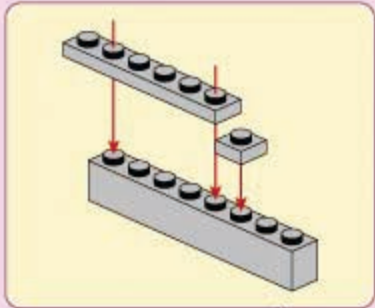
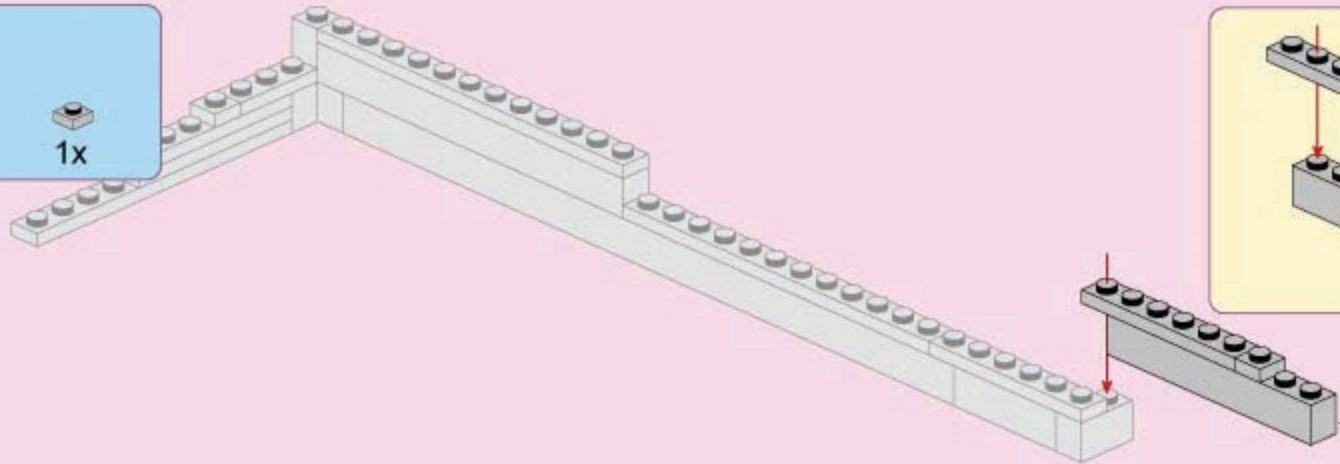
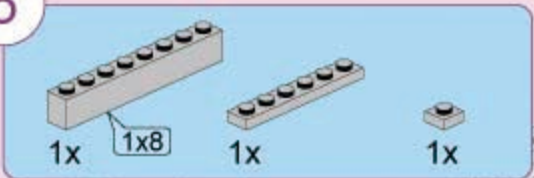

6

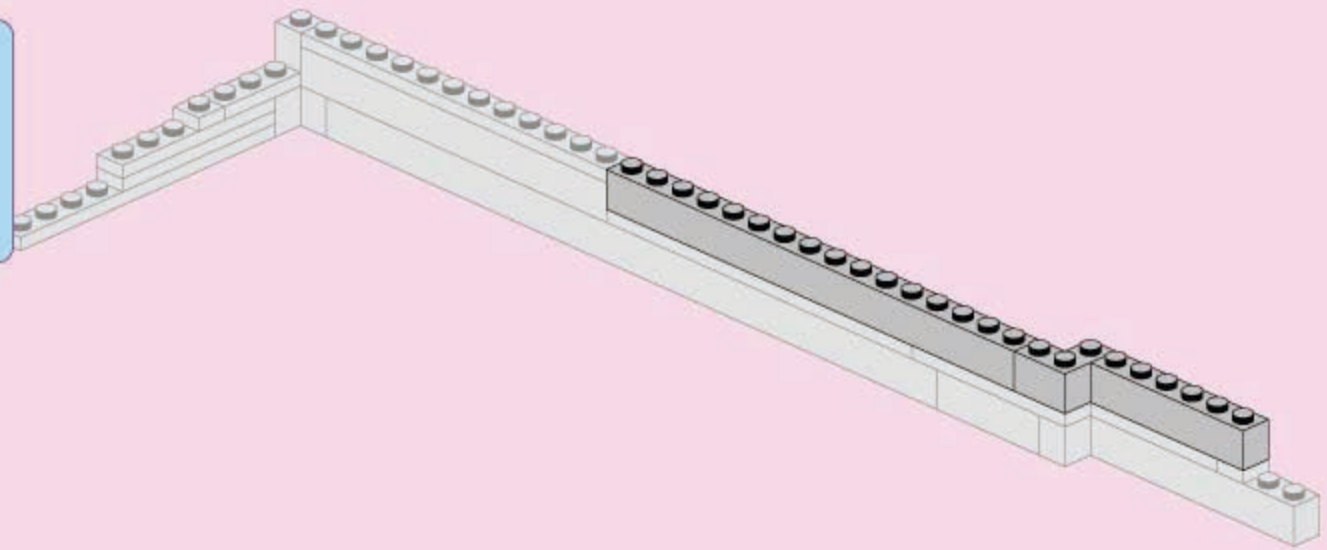
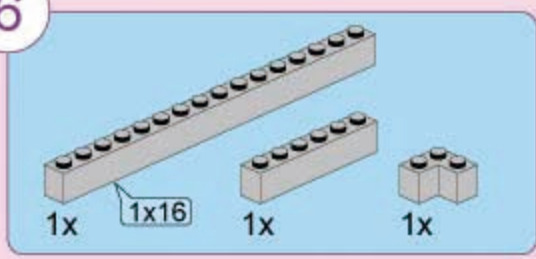

7

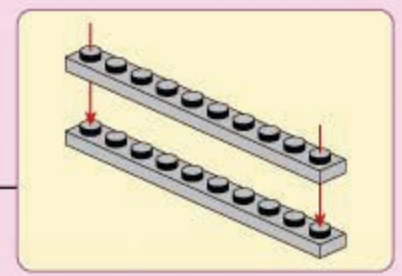
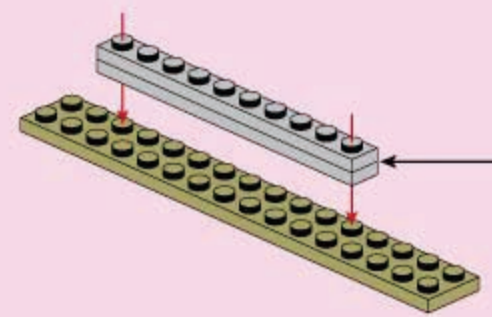
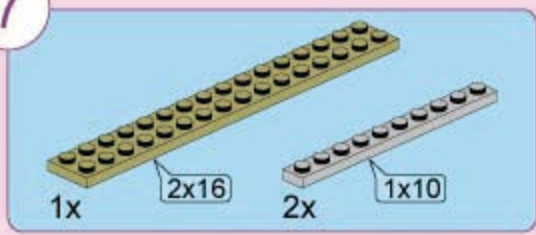

8

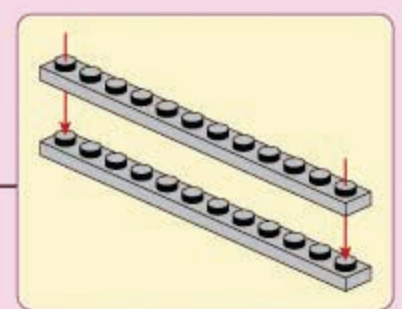
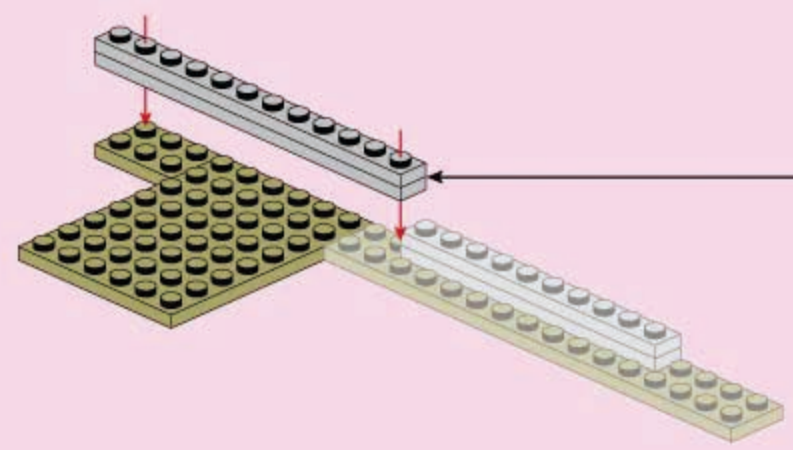
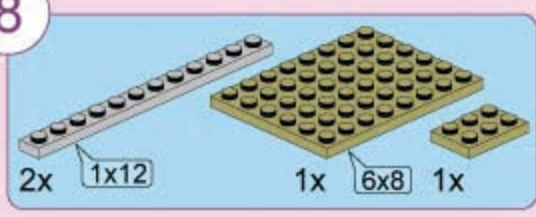

9

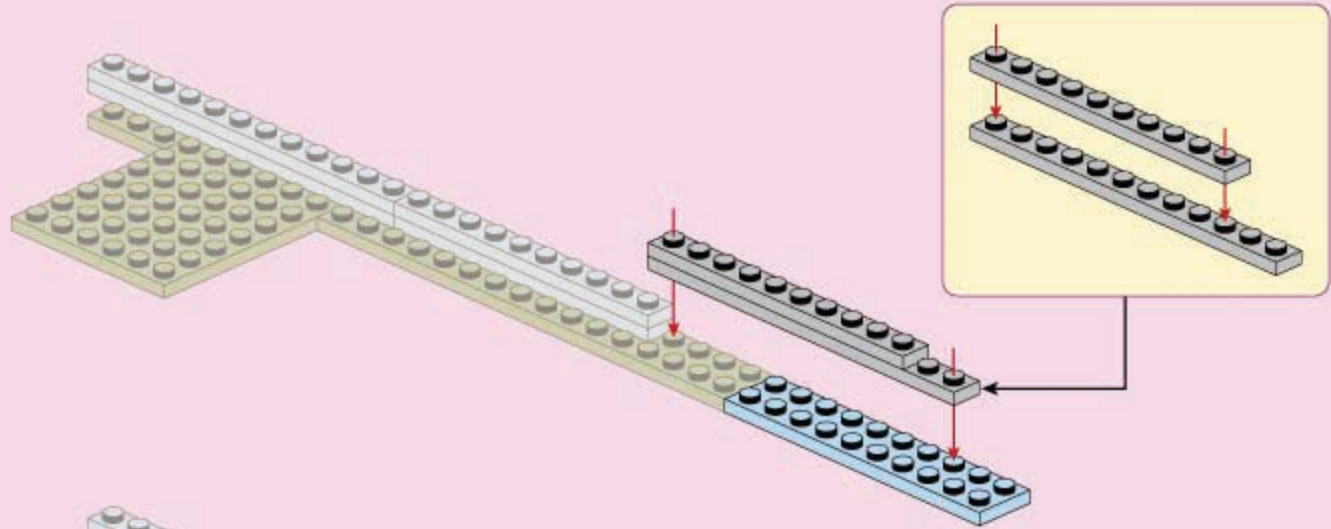
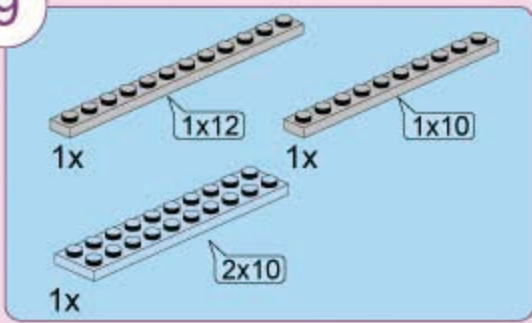

10

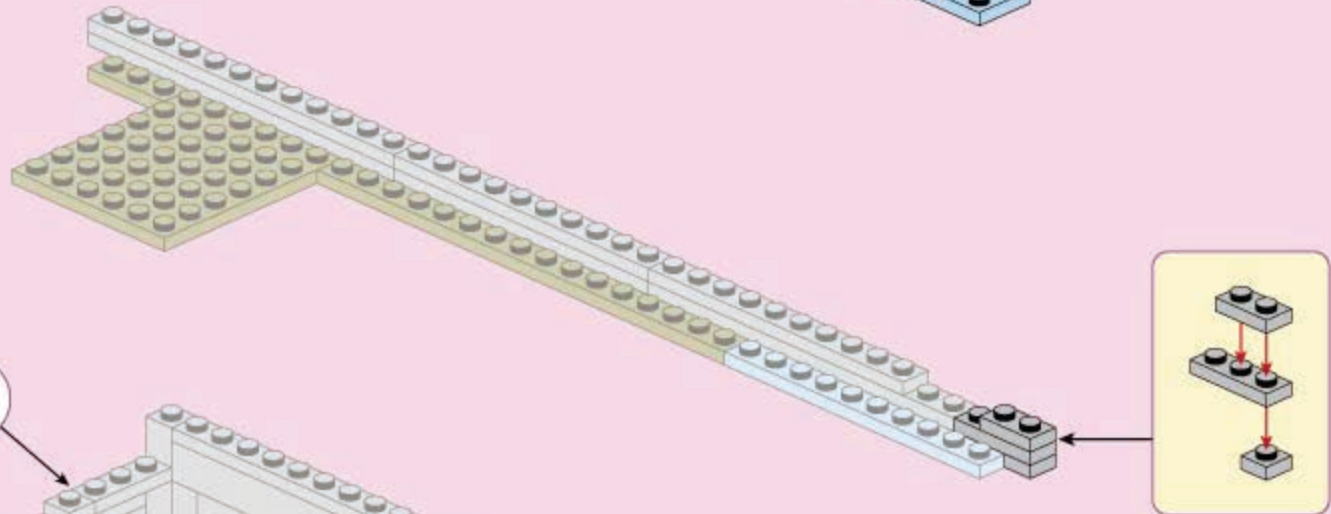

11

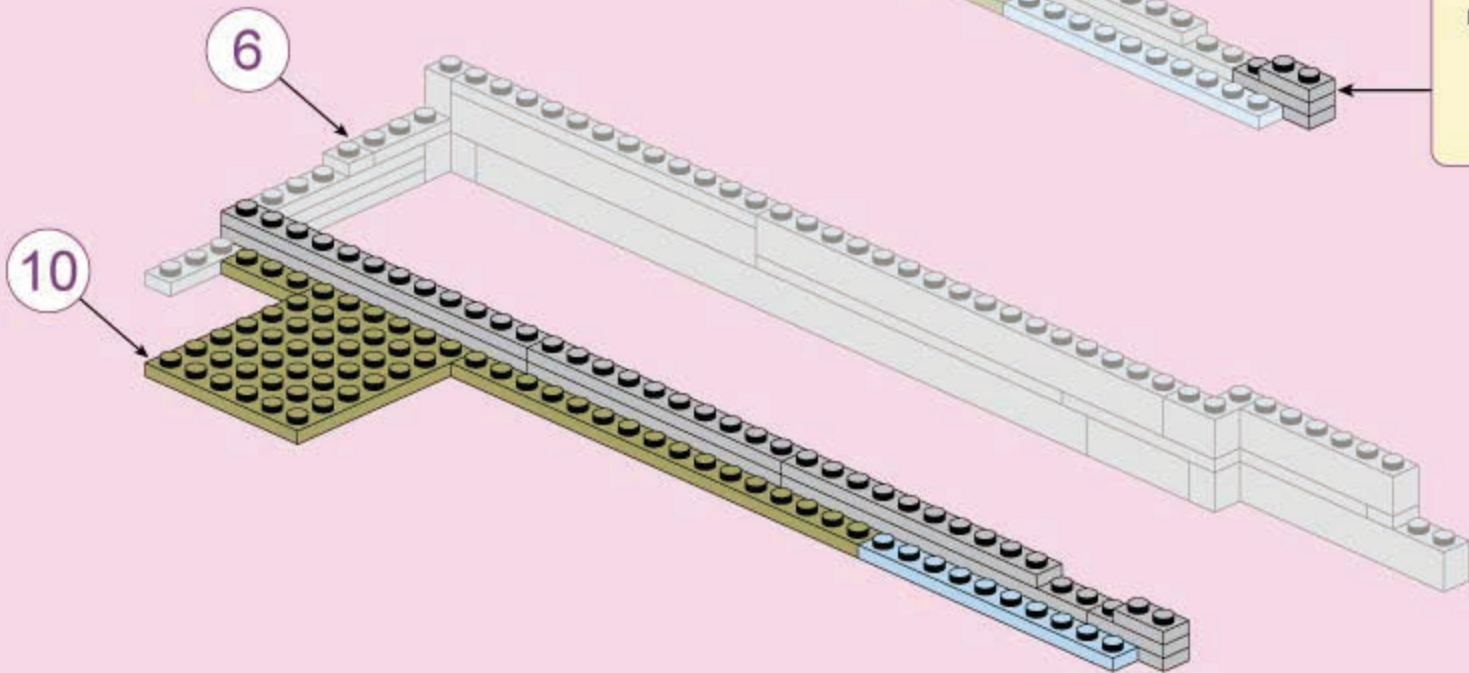

12

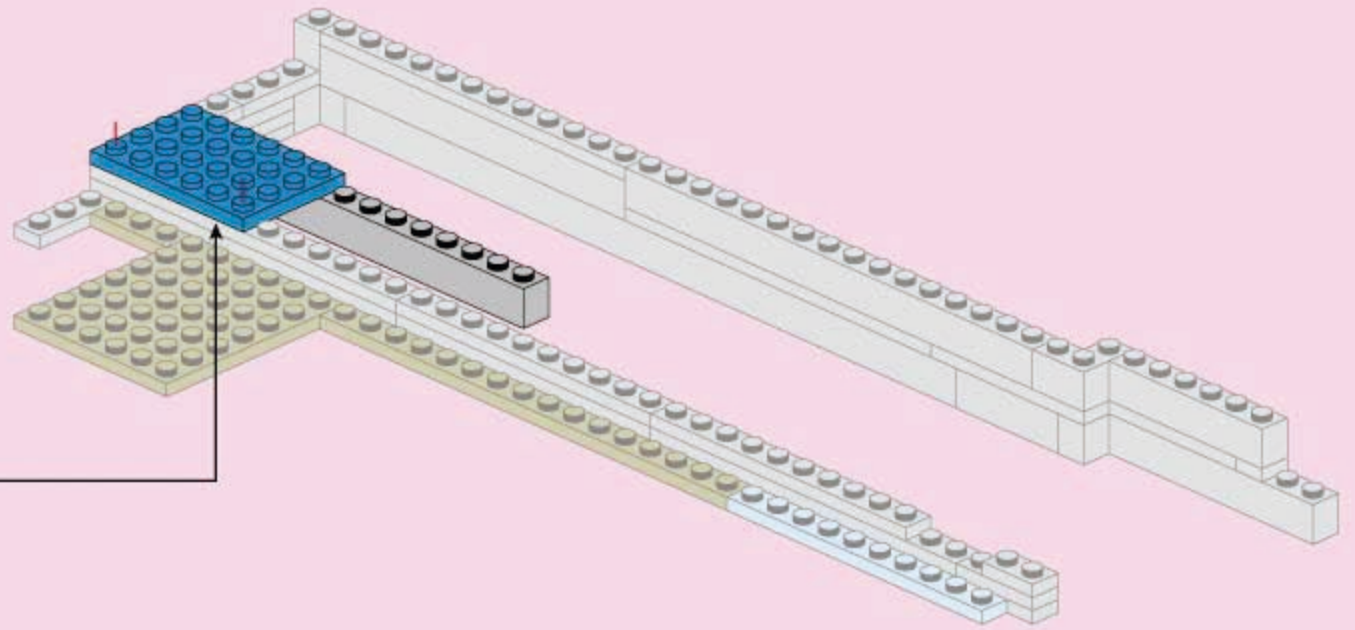
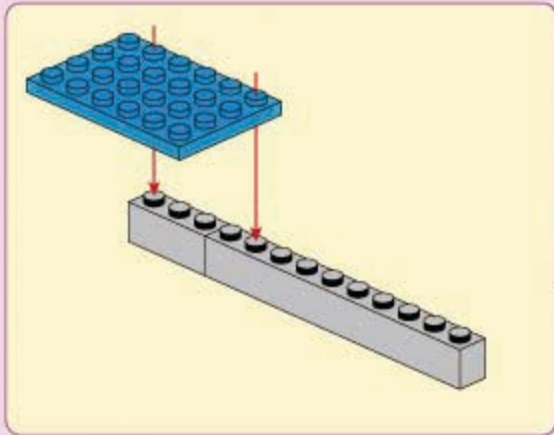
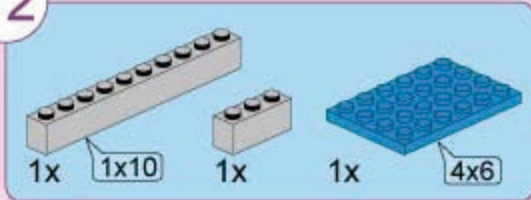

13

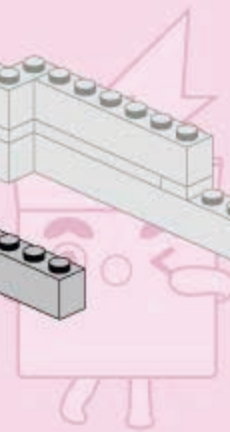
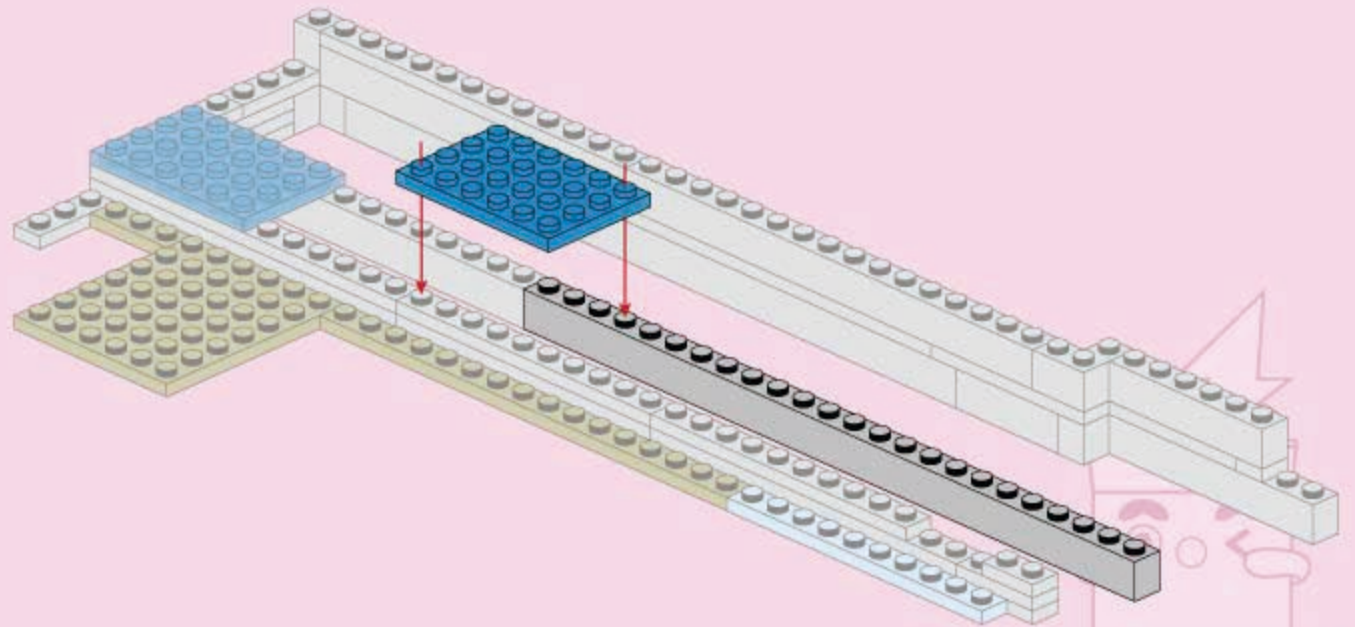
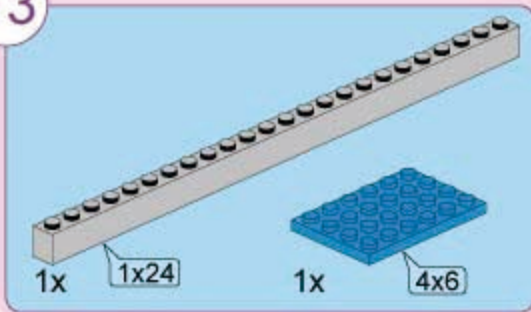

14



3x

4x6

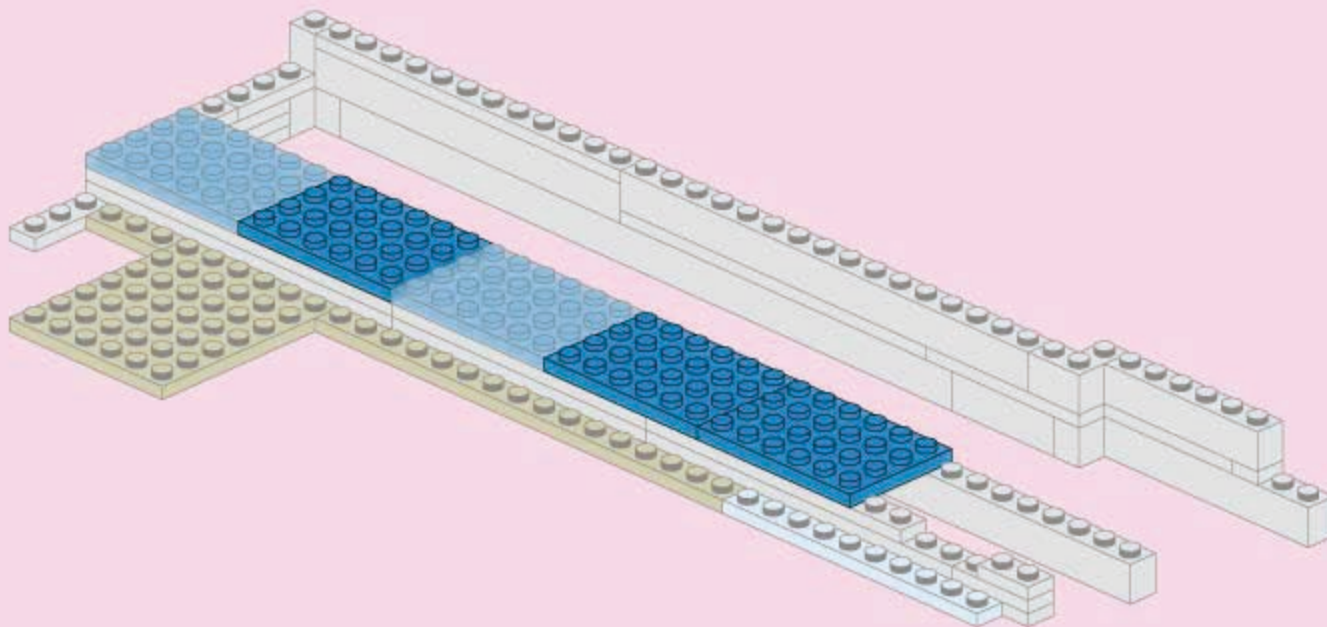

15



1x



2x



1x

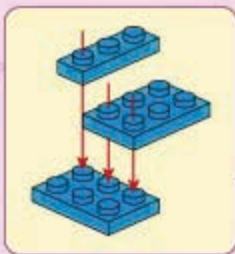
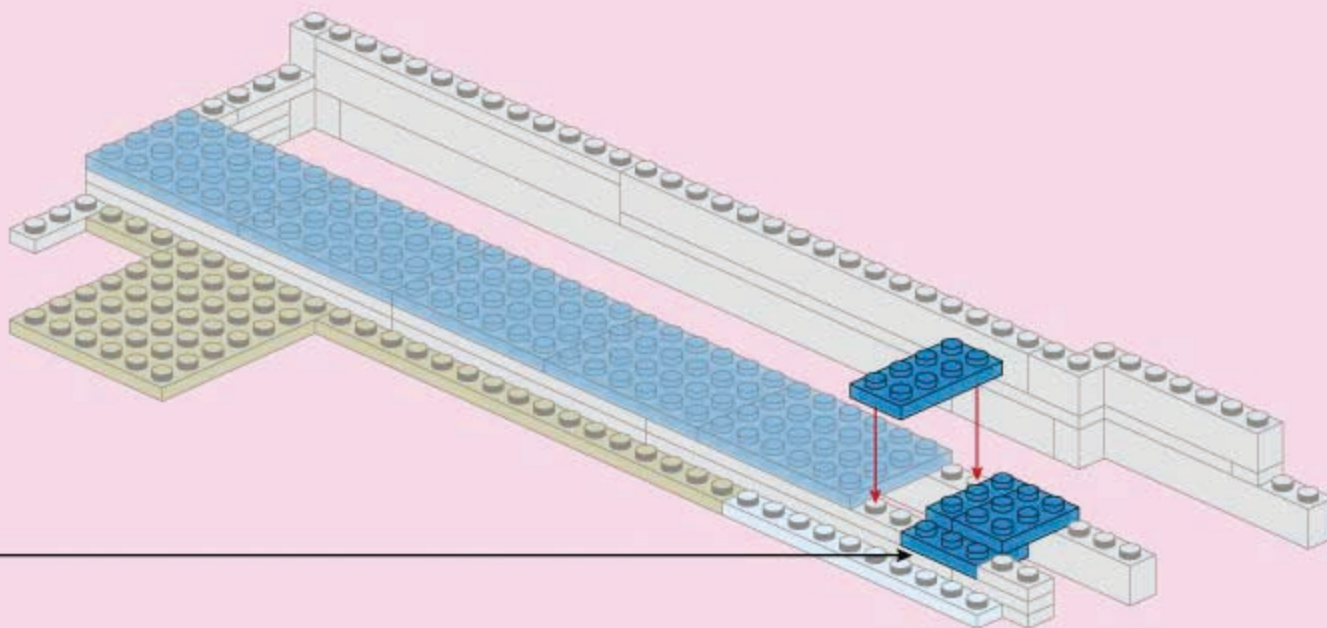

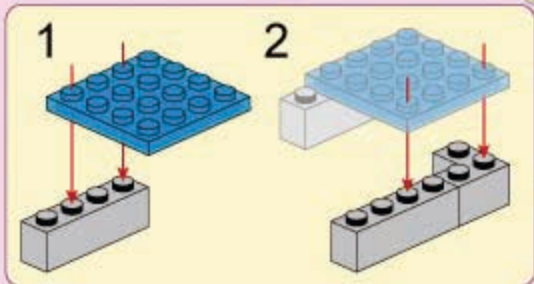
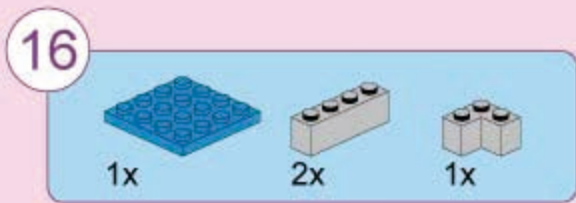
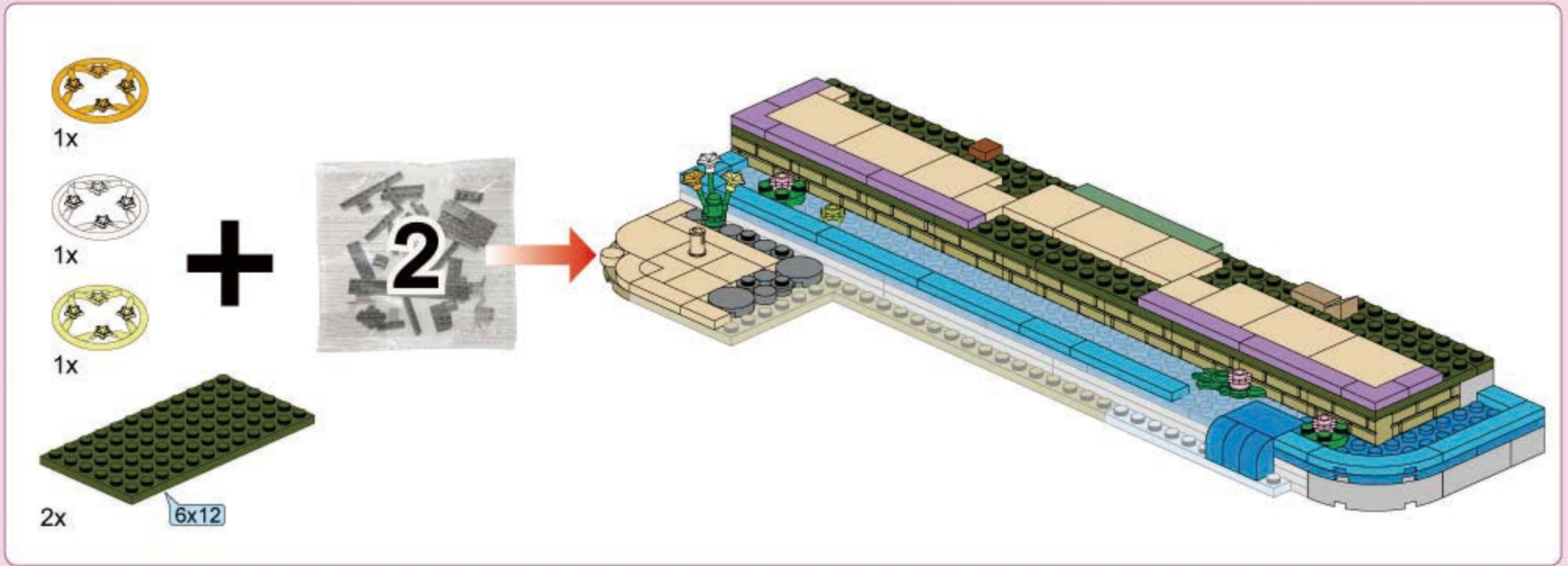

17

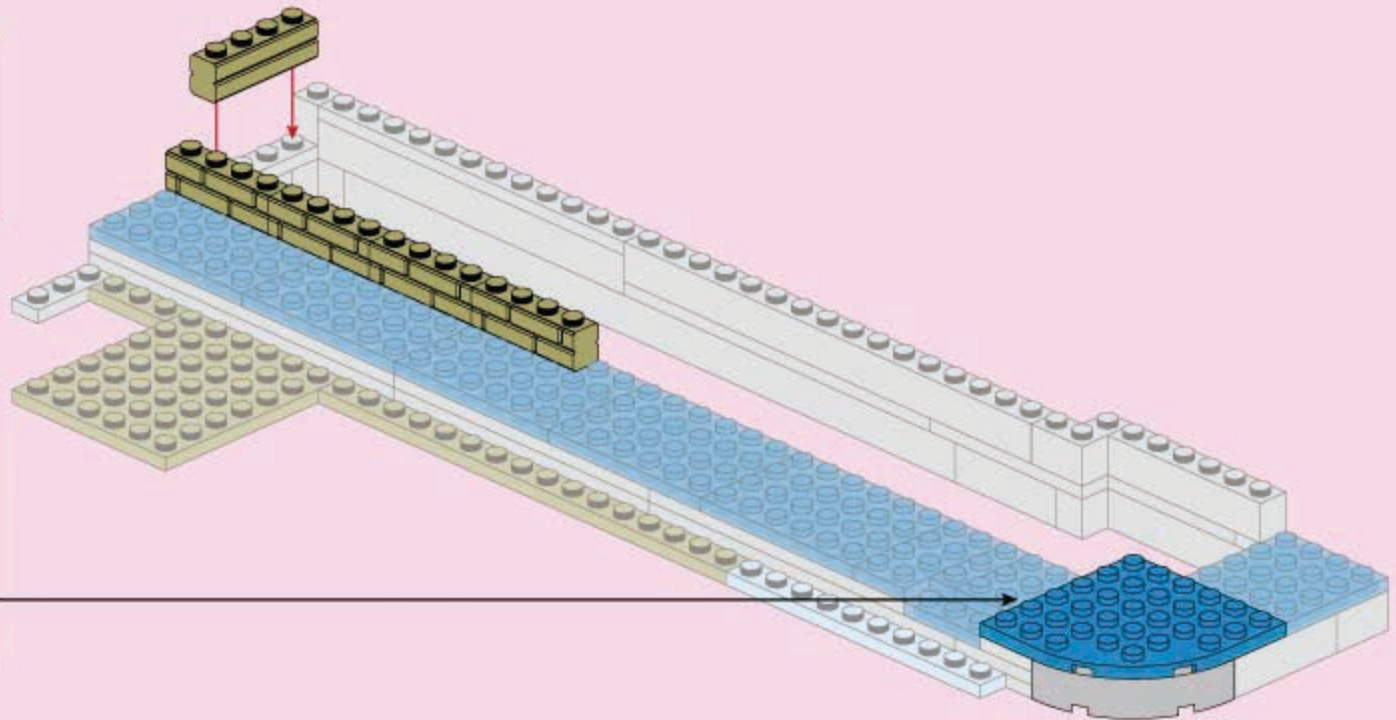
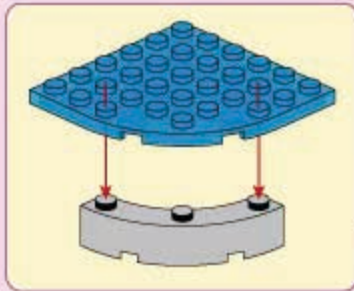
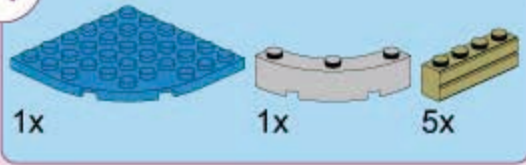

18

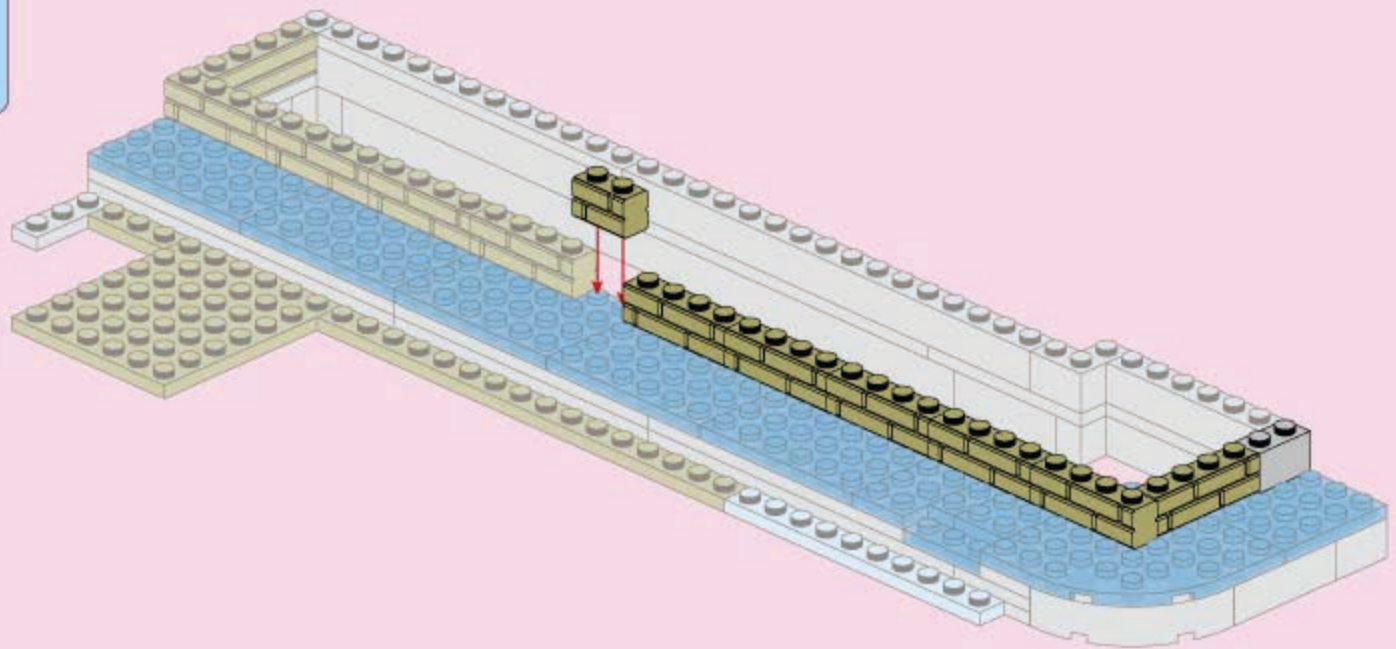

19

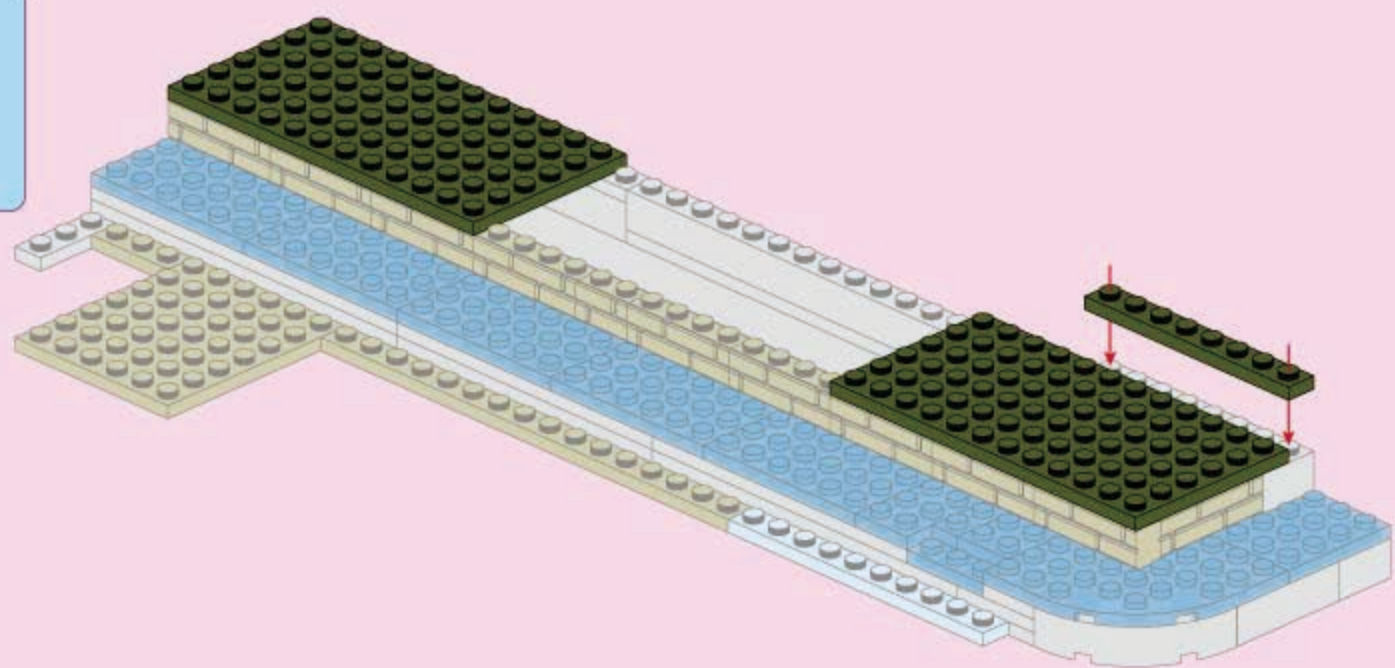
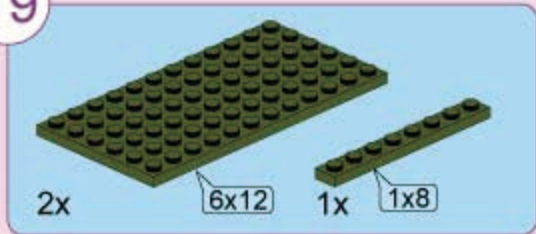

20

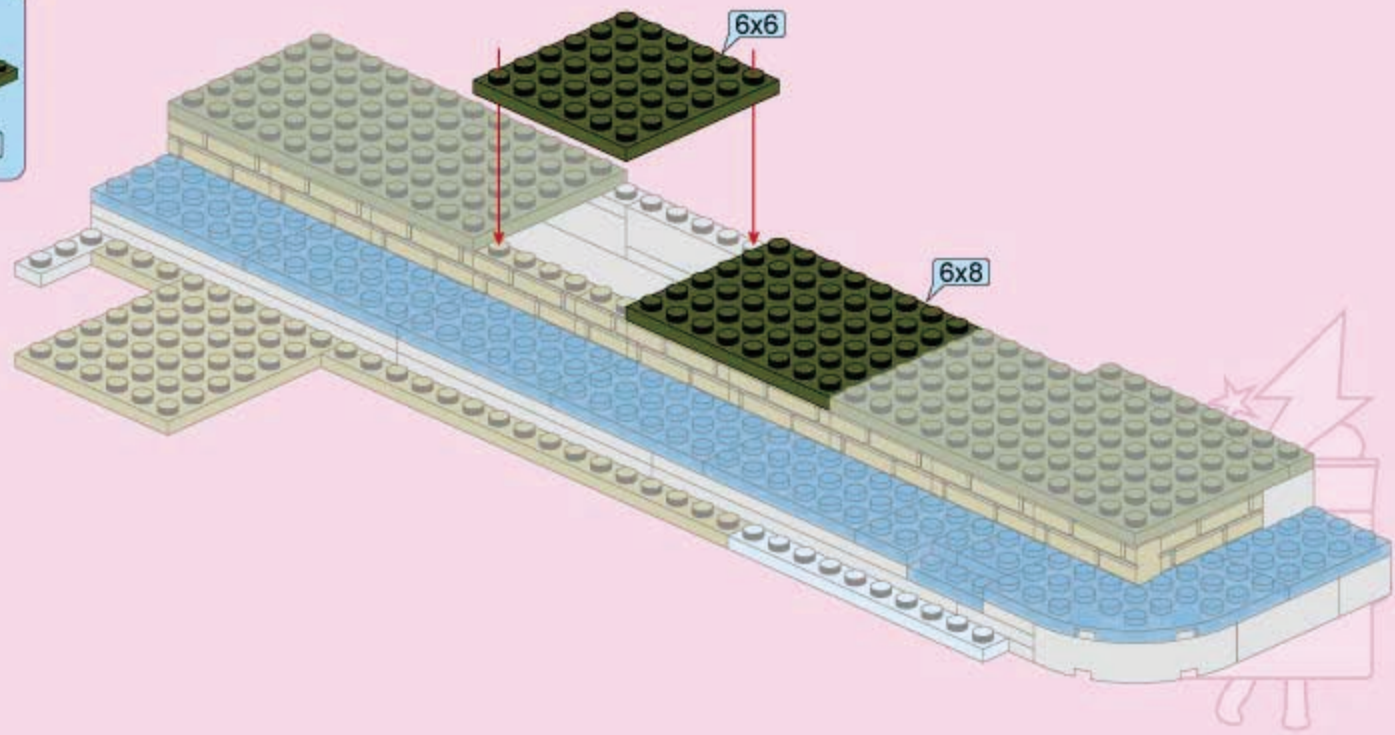
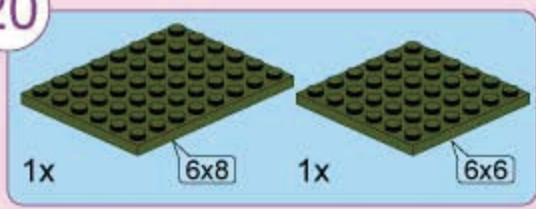

21

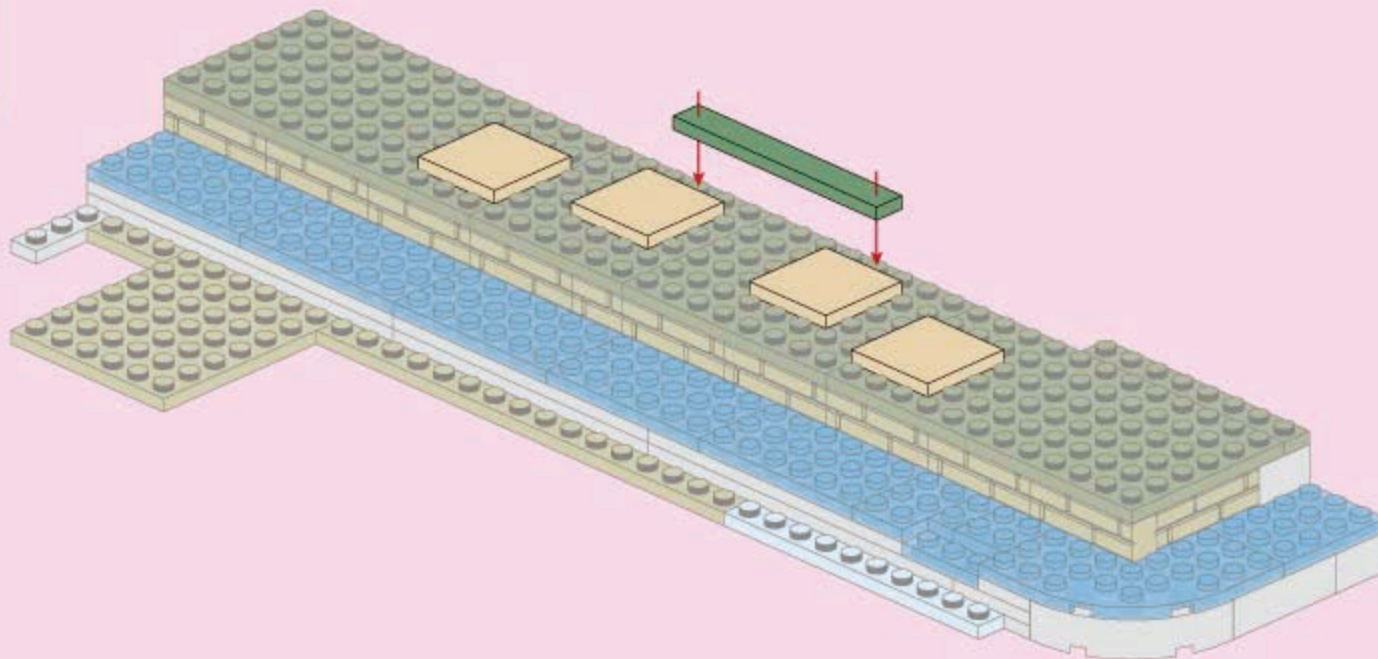
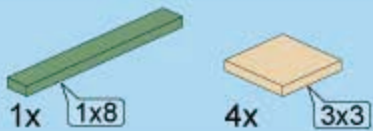

22

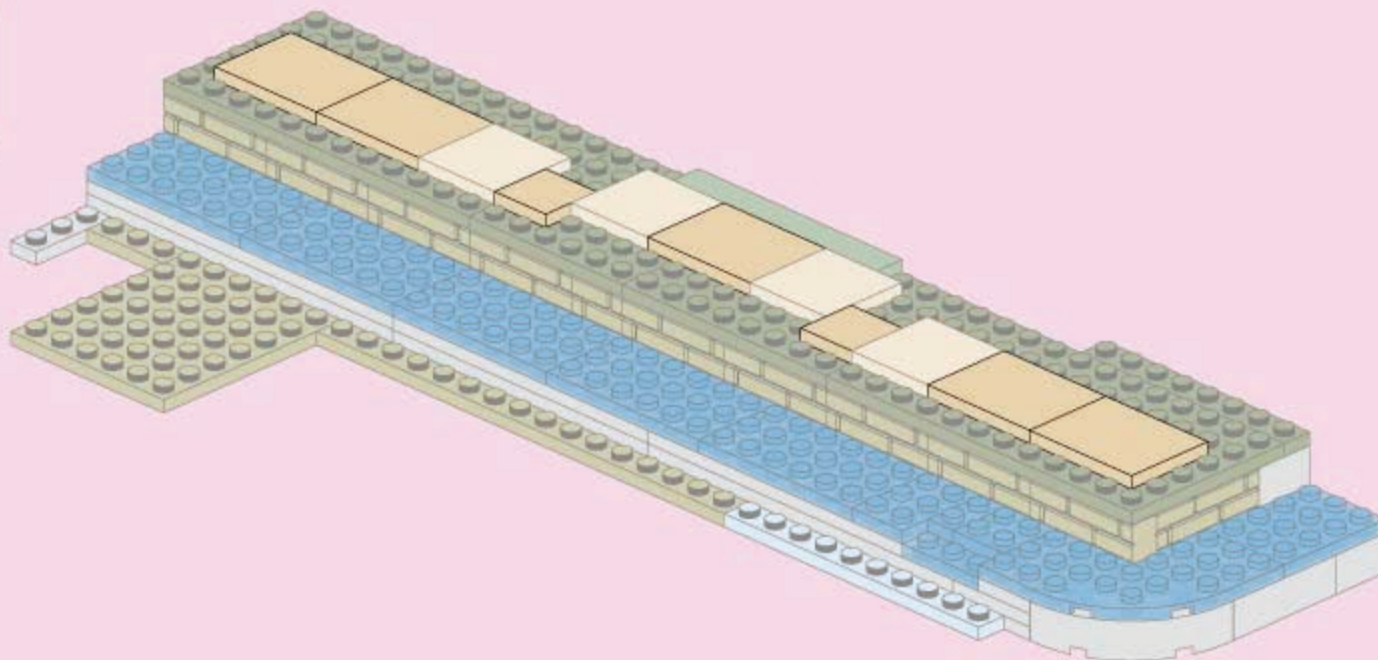

23

4x 1x6 1x 1x3 2x 1x

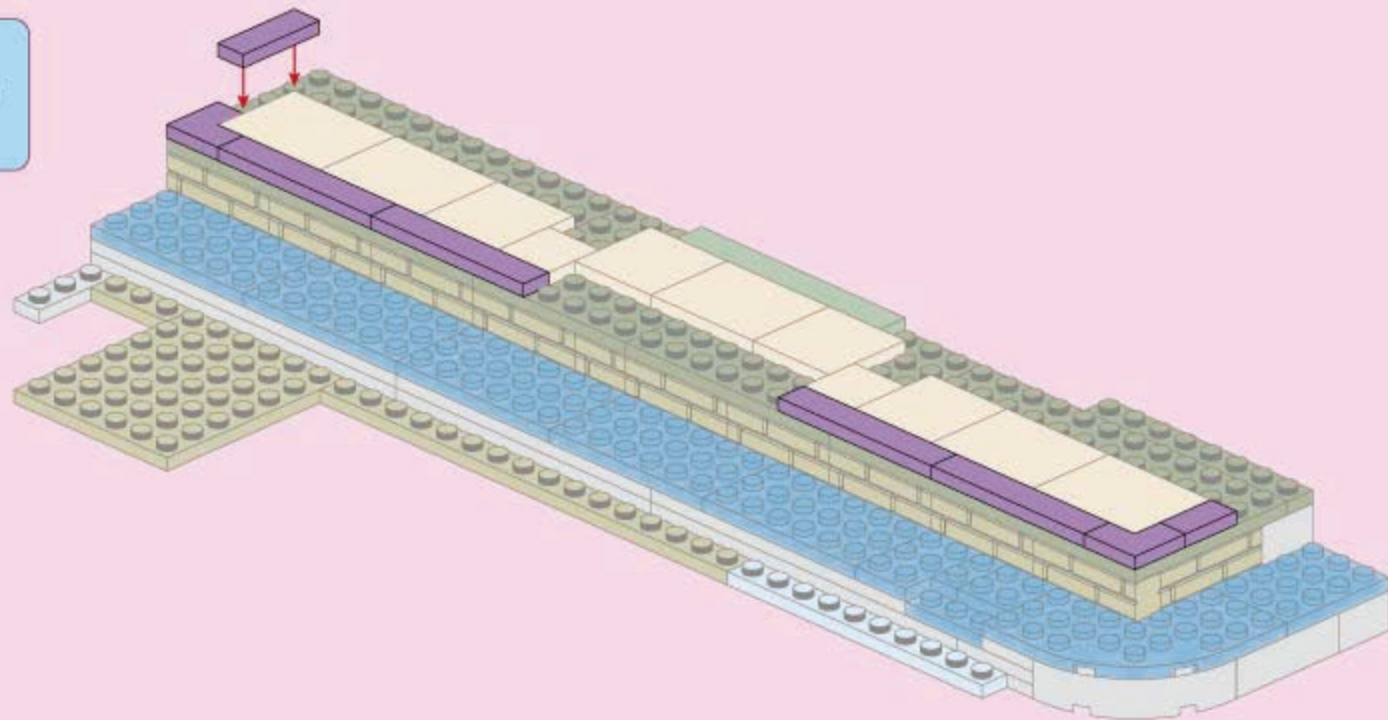

24

5x 1x6 1x

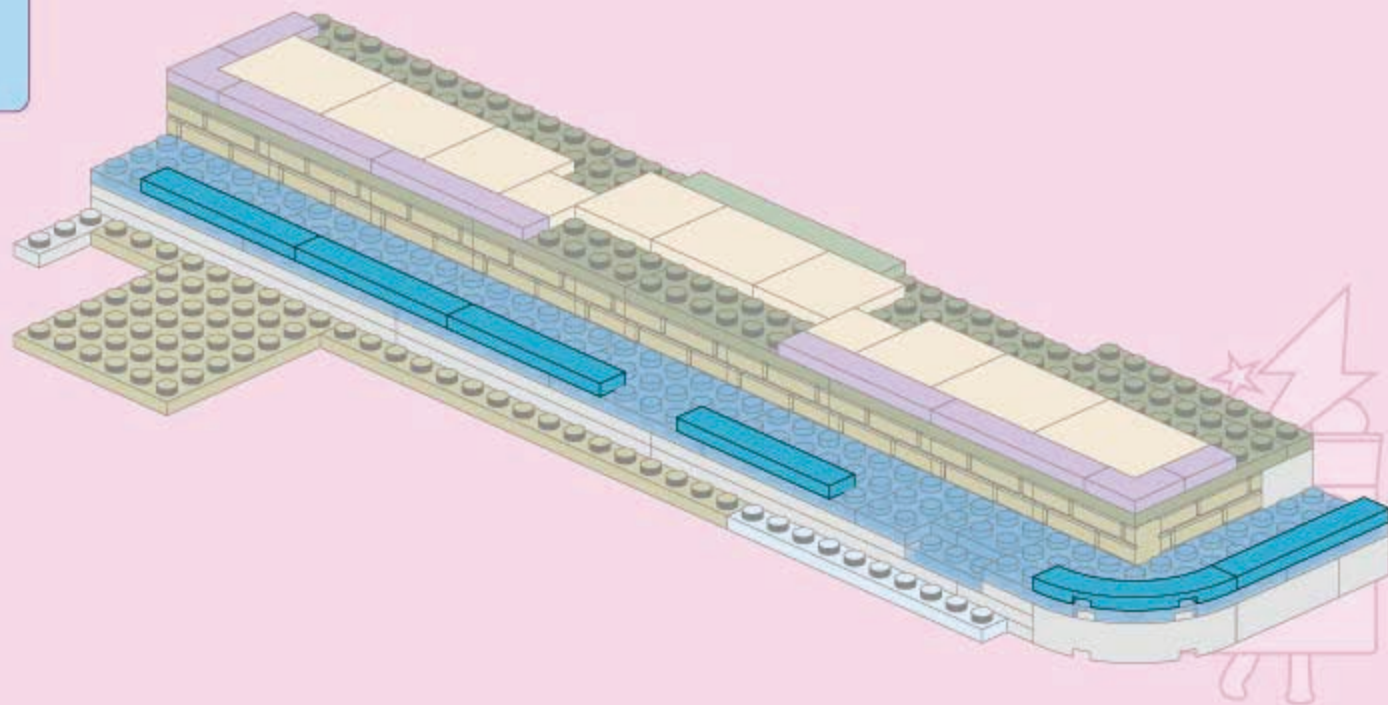

25

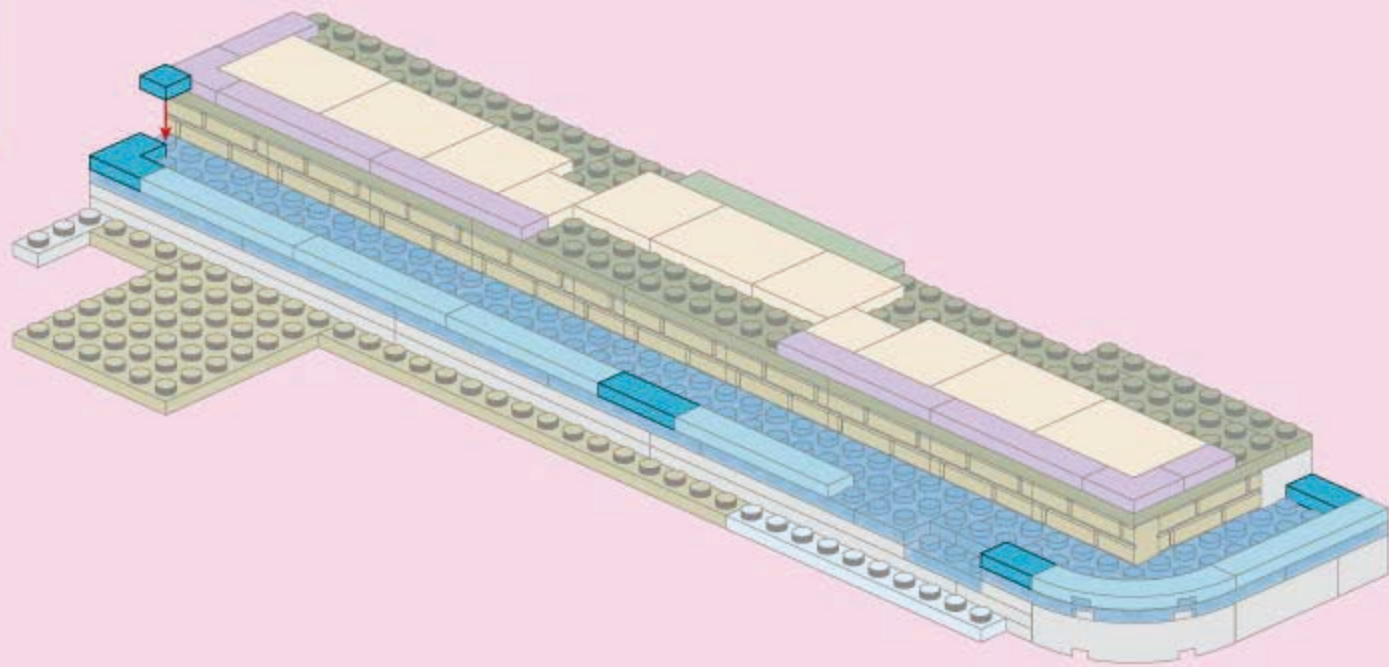
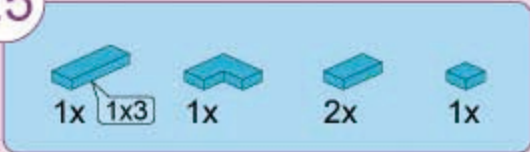

26

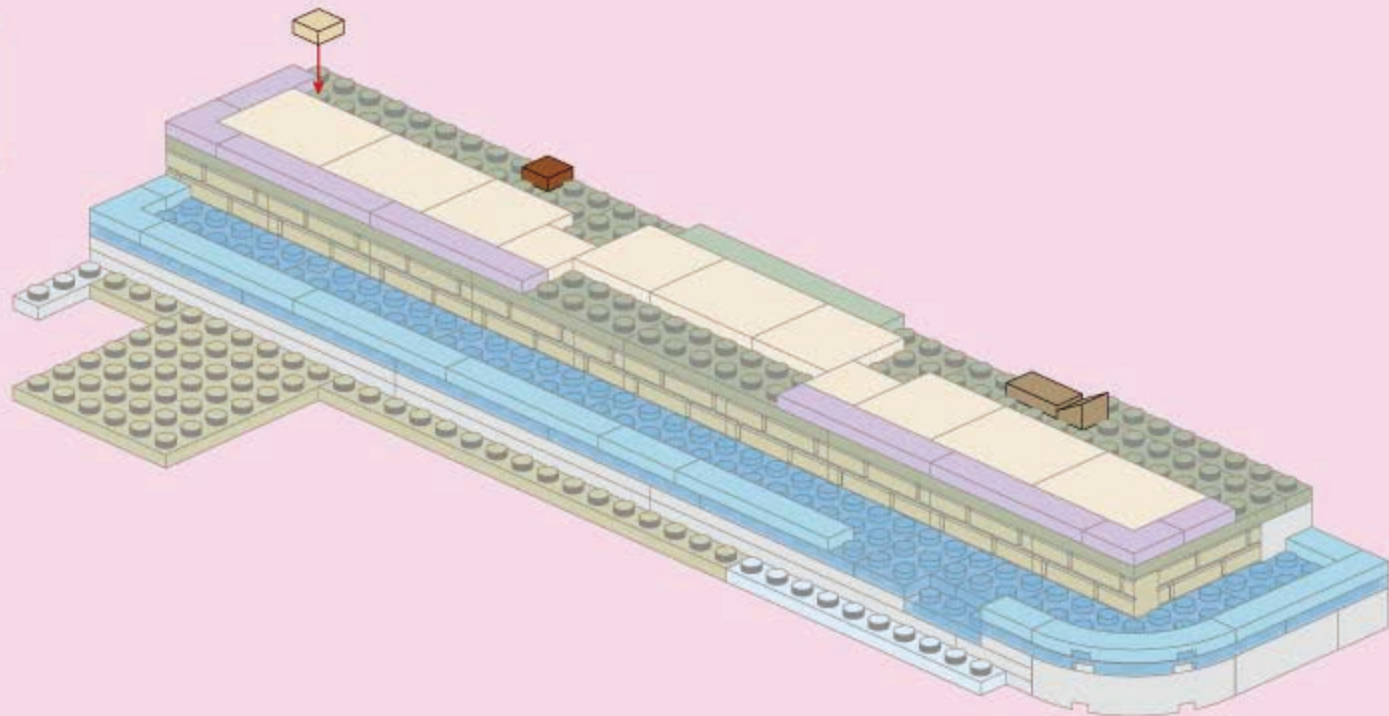

27

2x

2x

3x

1x

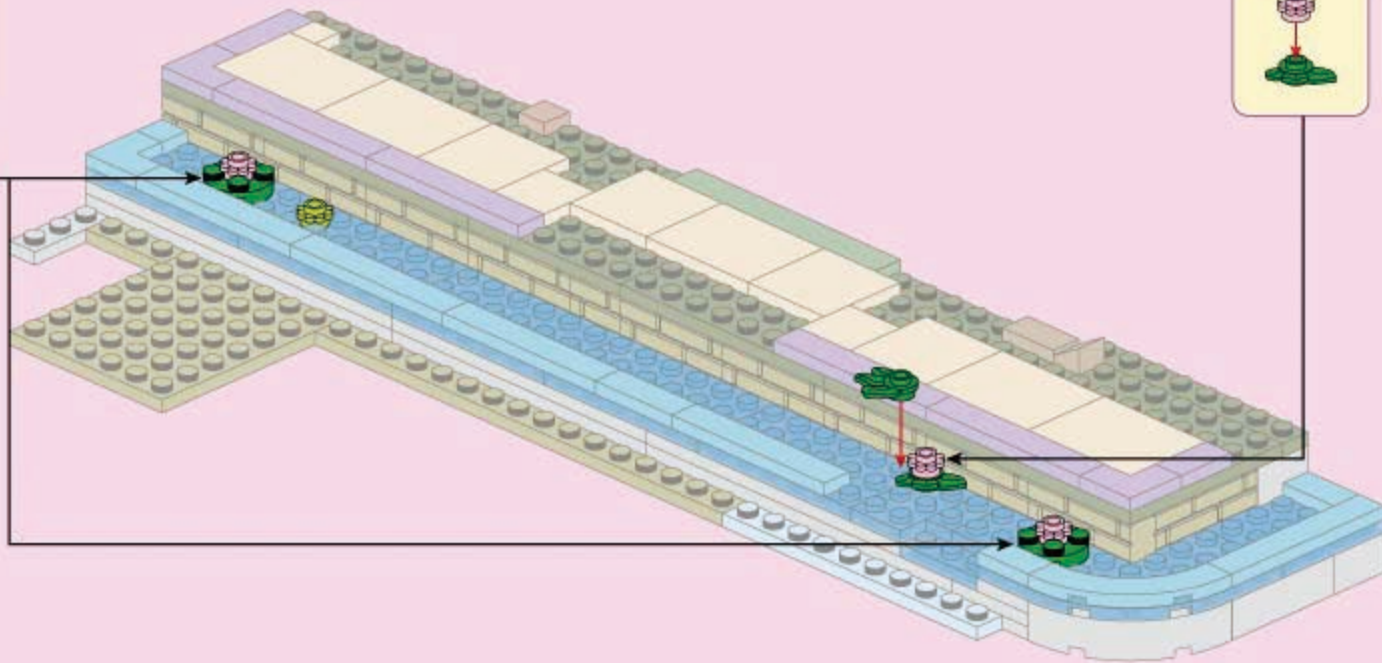

28

1x

3x

1x

2x3

1x

1x

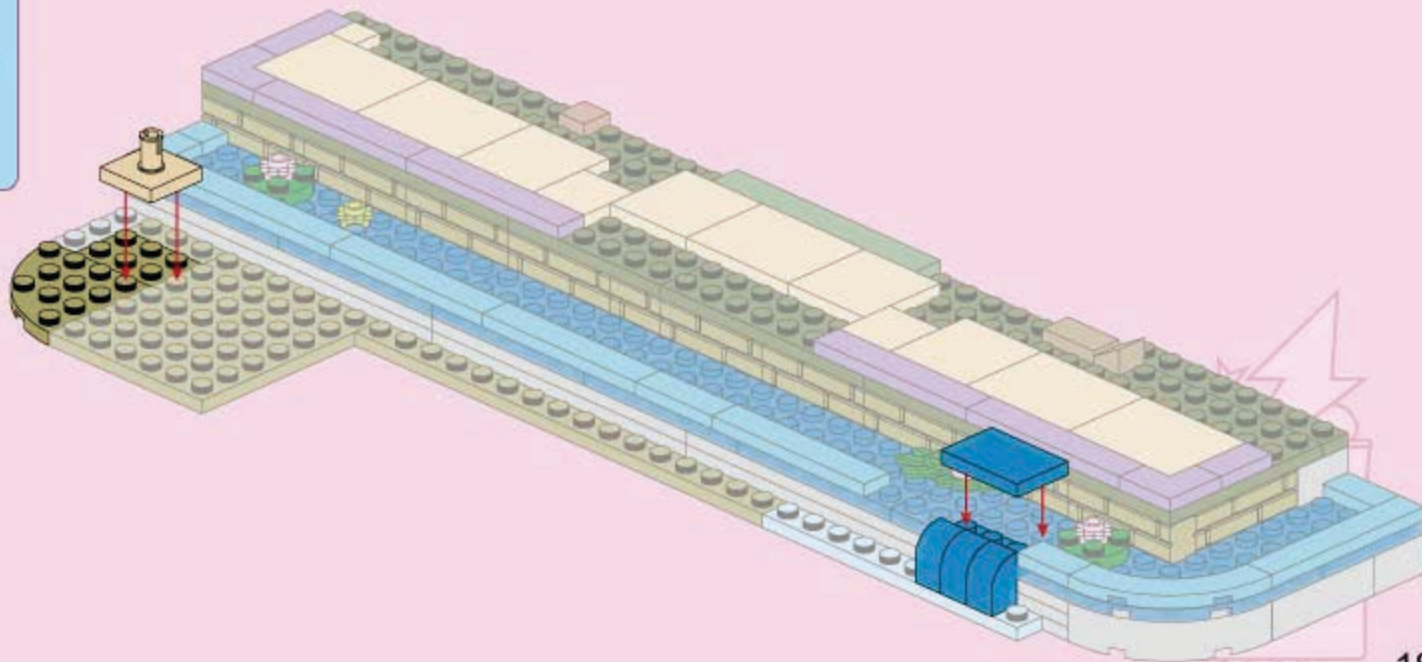
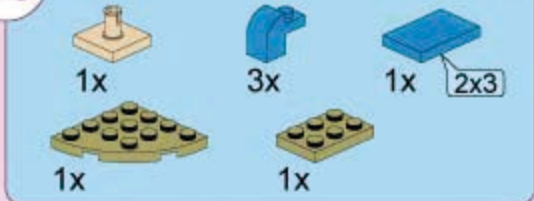

29

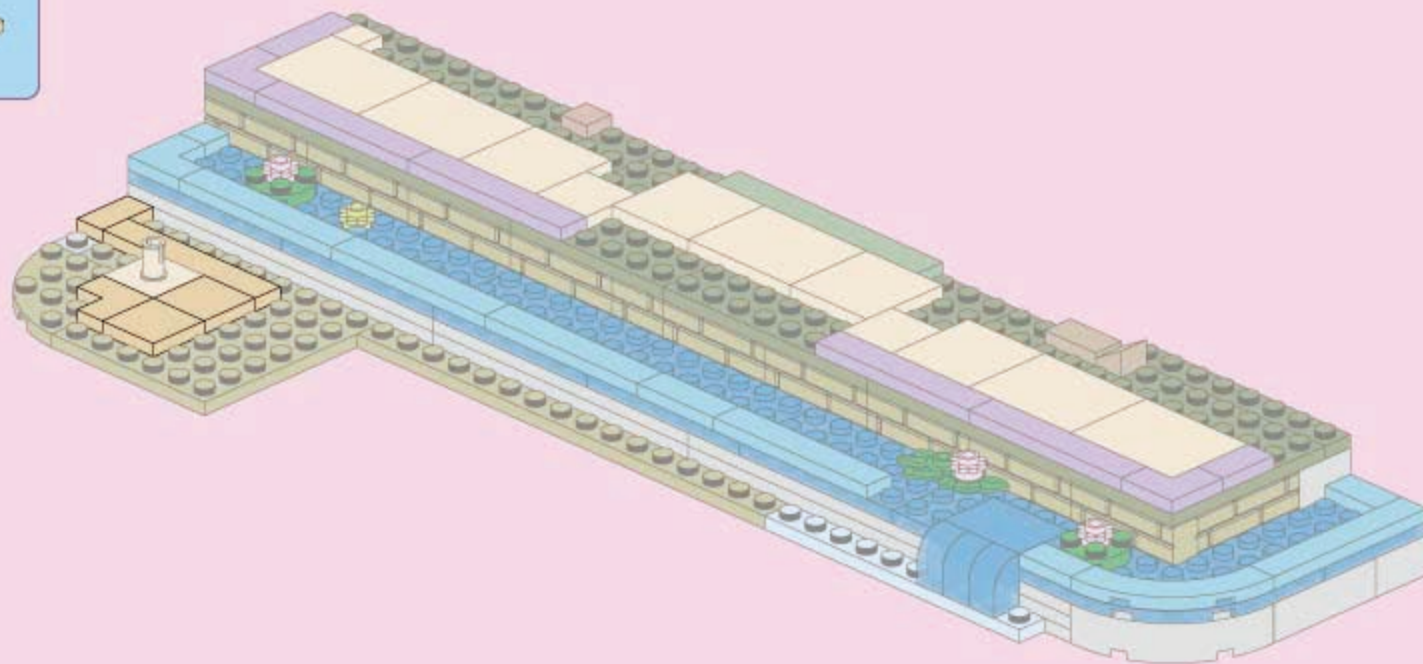
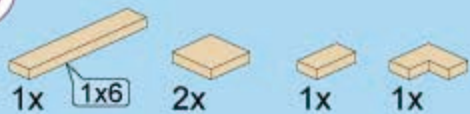

30

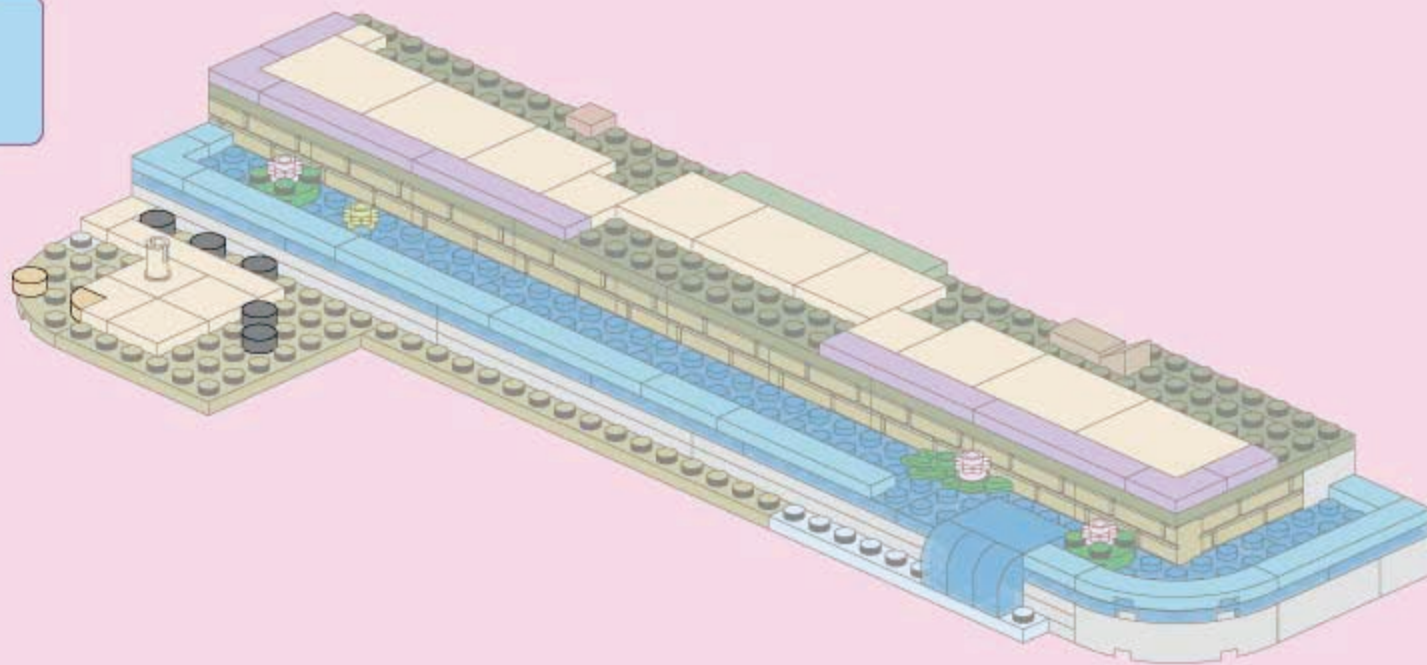

31

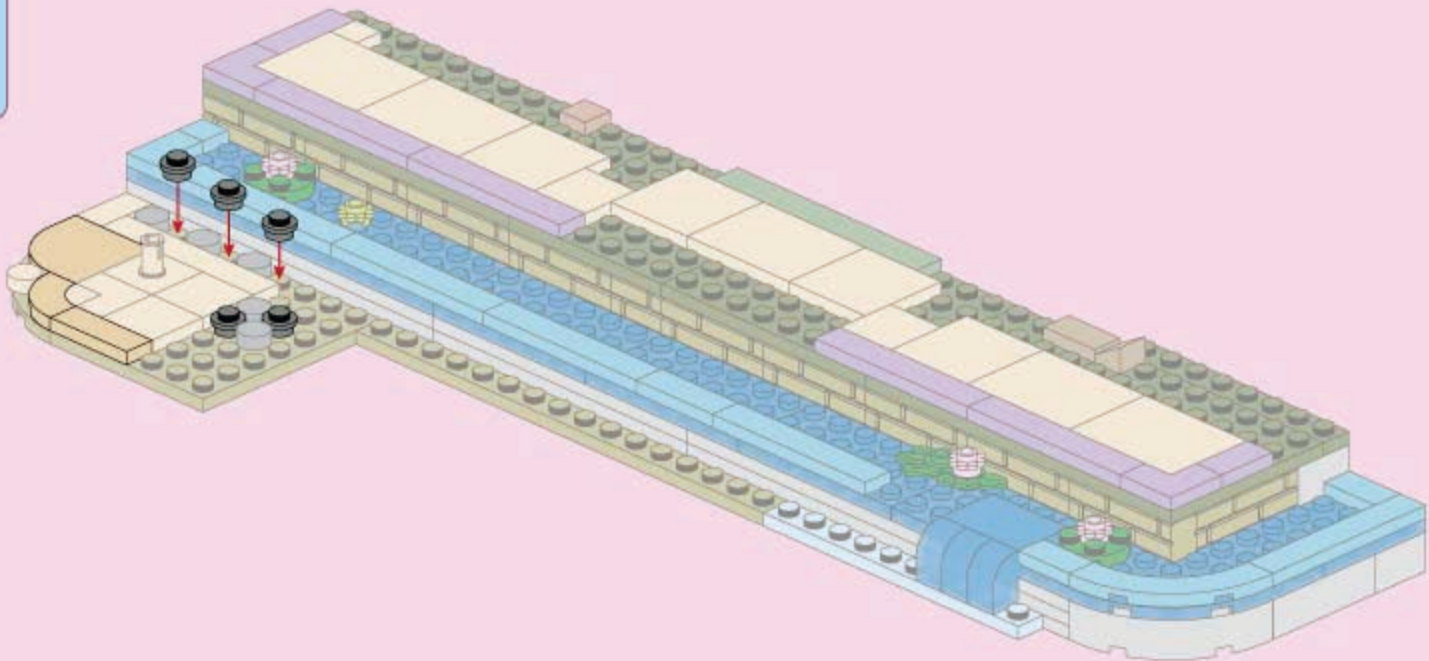
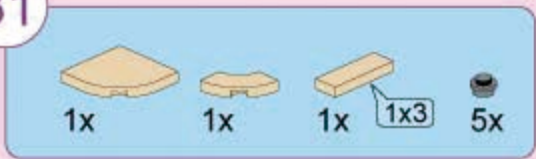

32

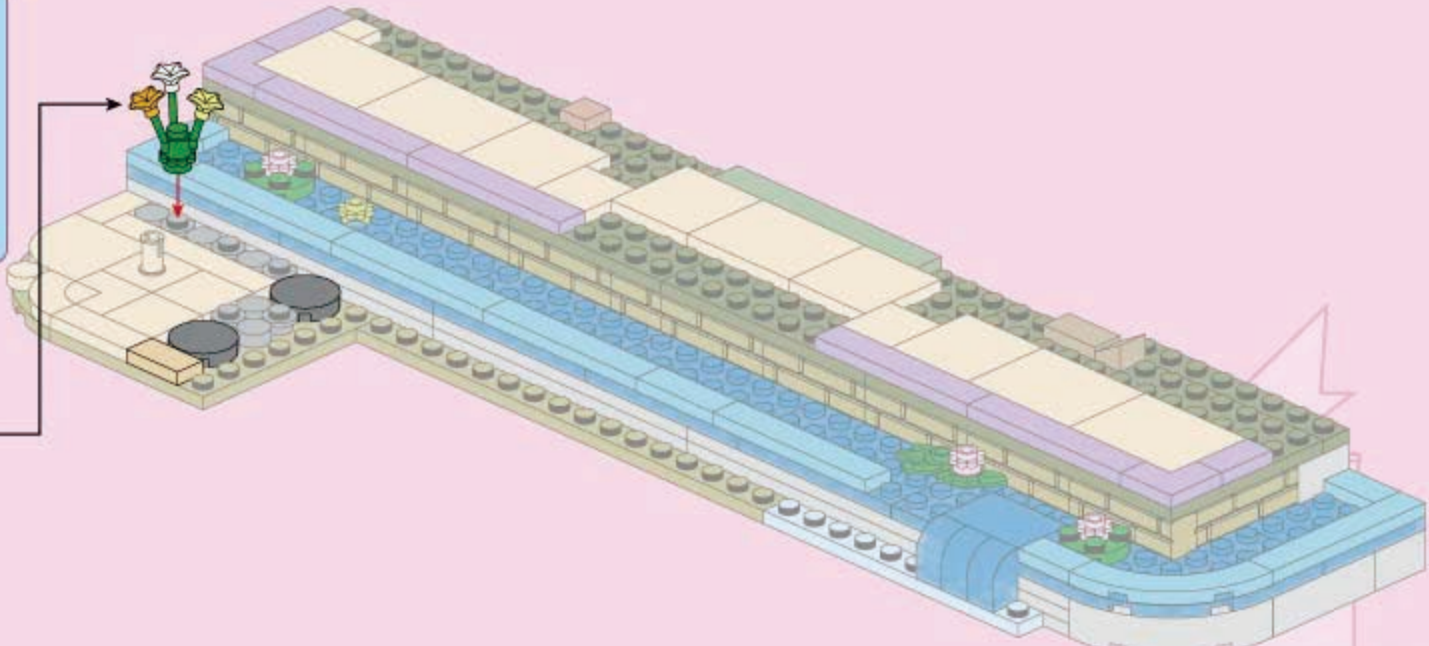
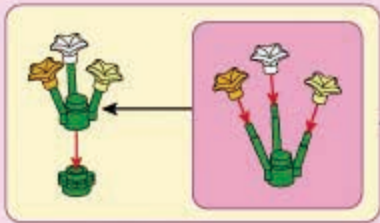

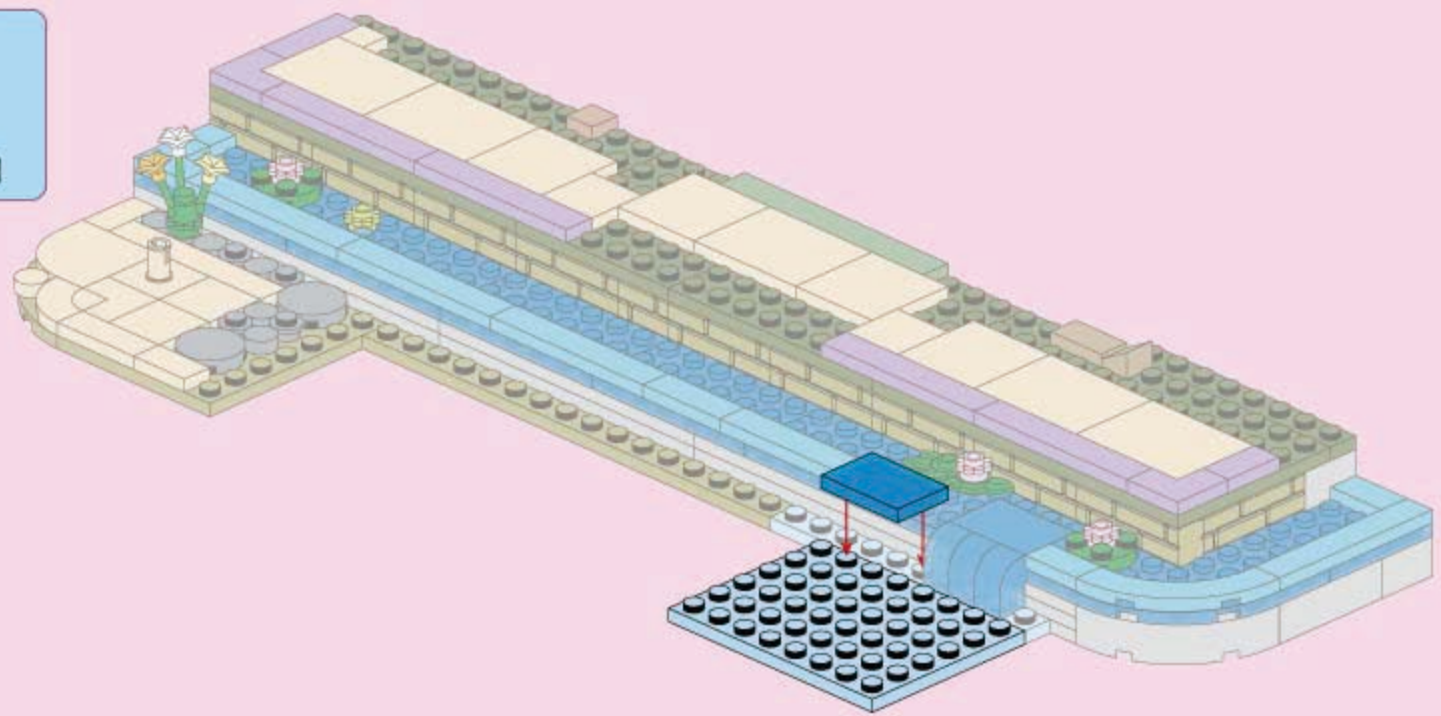
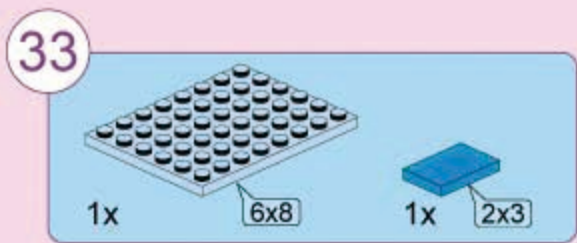
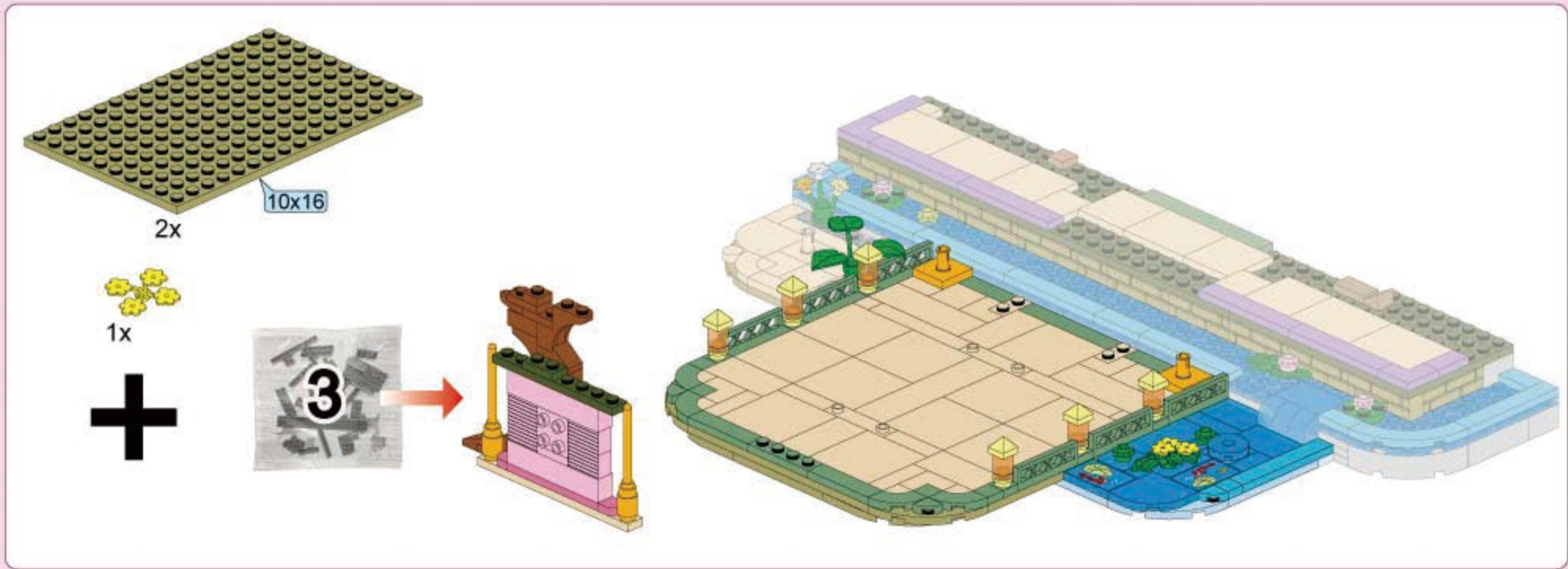

34

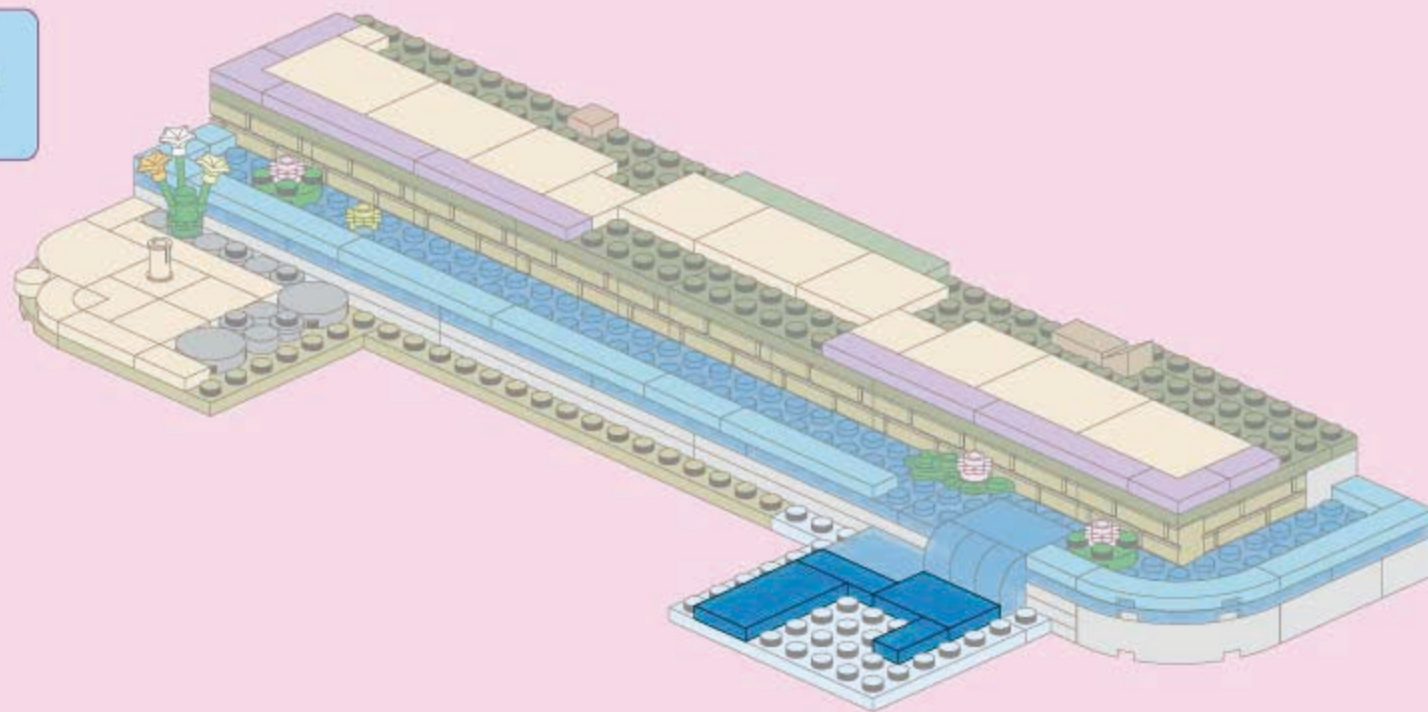
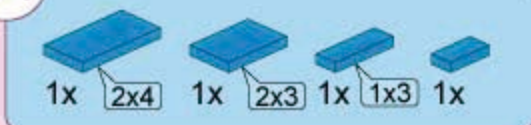

35

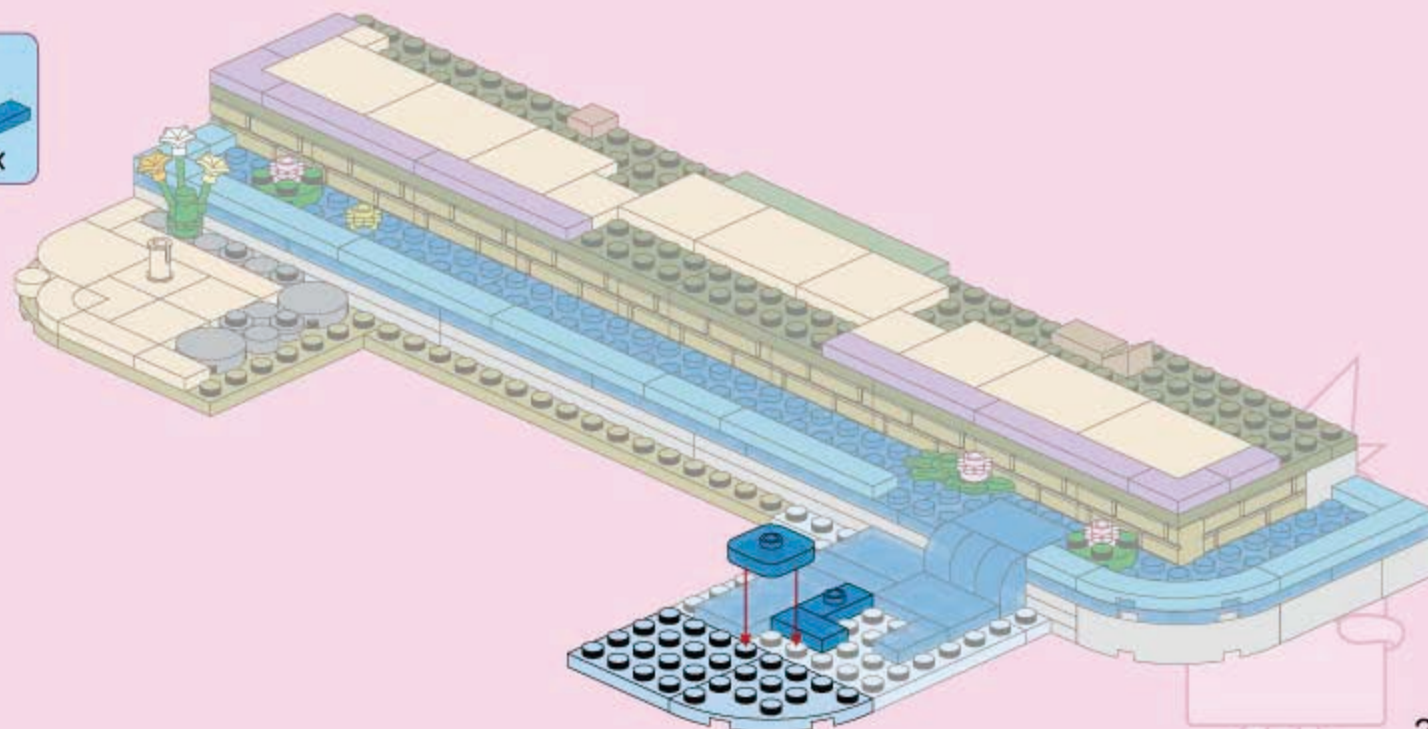

36

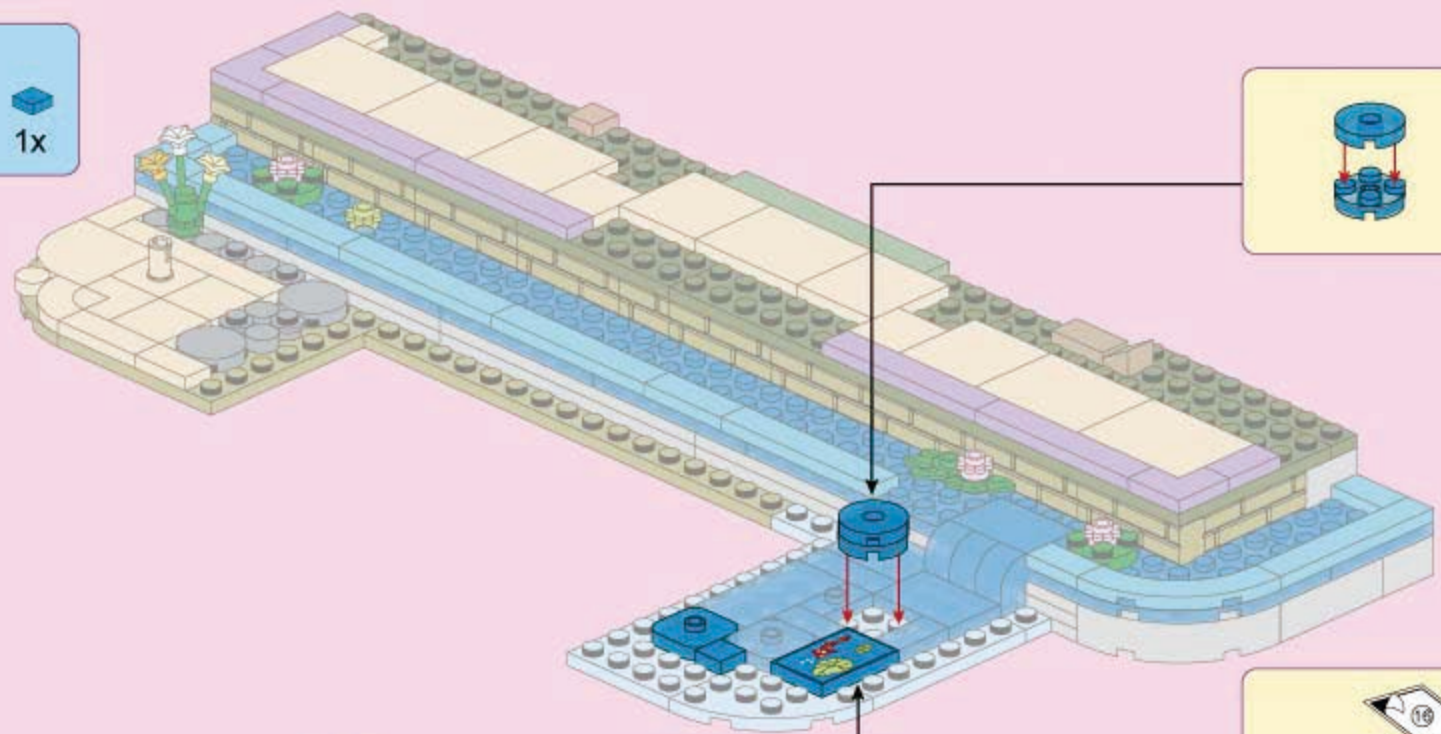

37

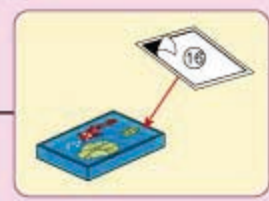
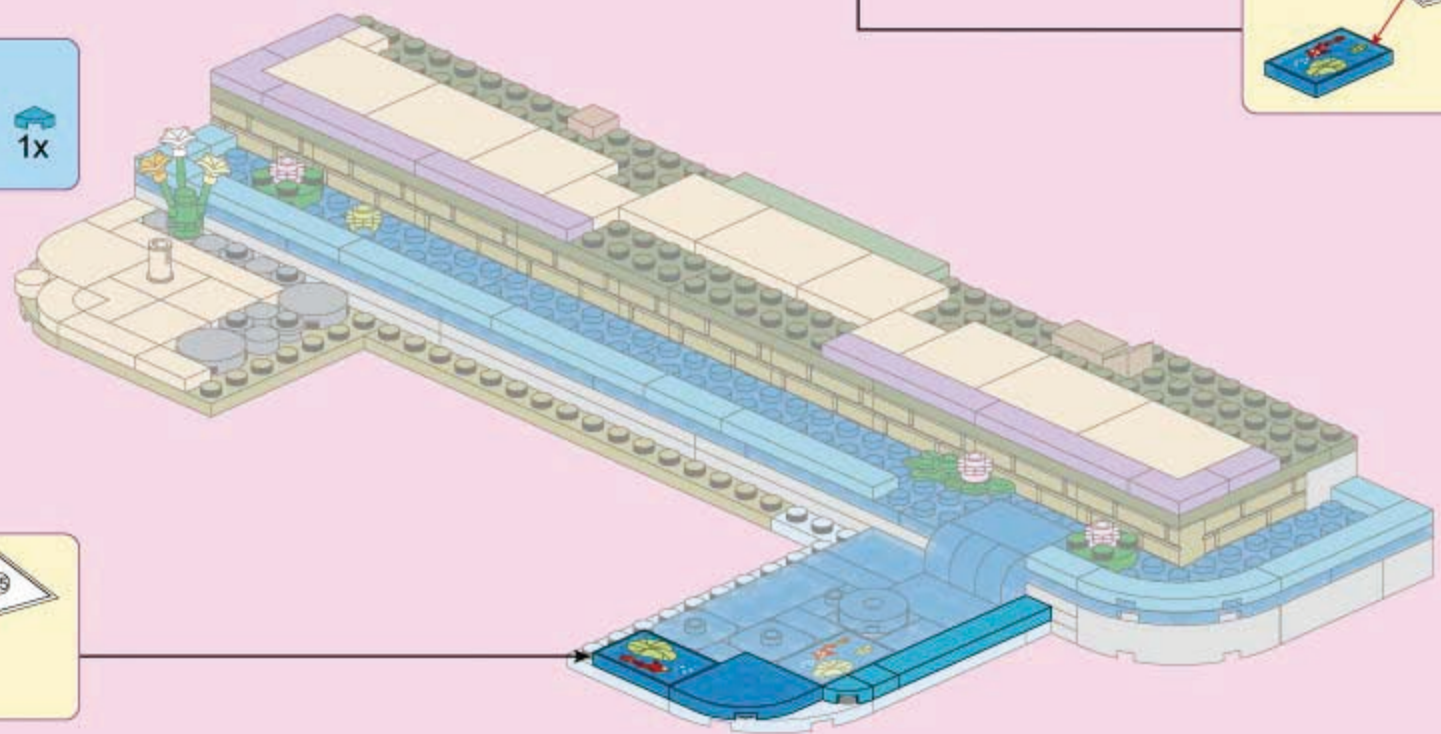
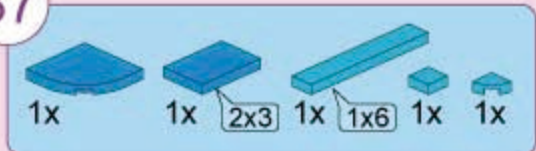

38



1x



1x



2x

1



2

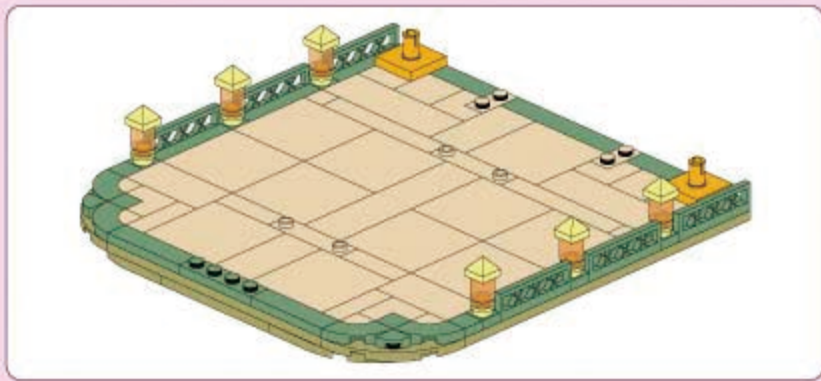
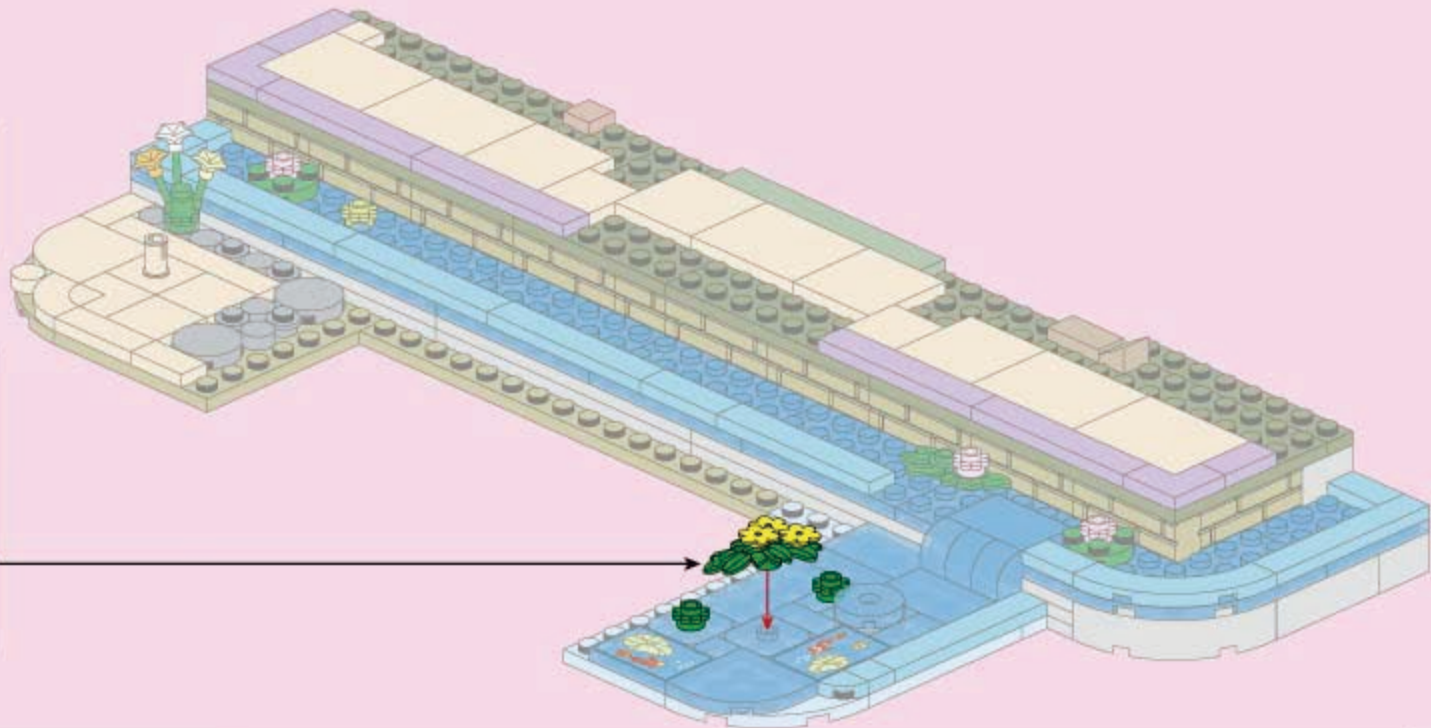

39



1x

1x12

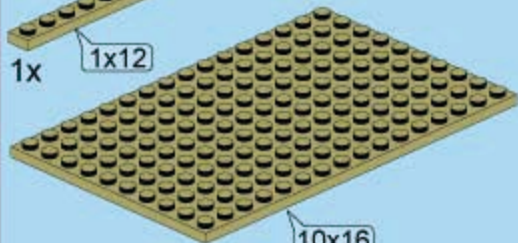

2x

10x16

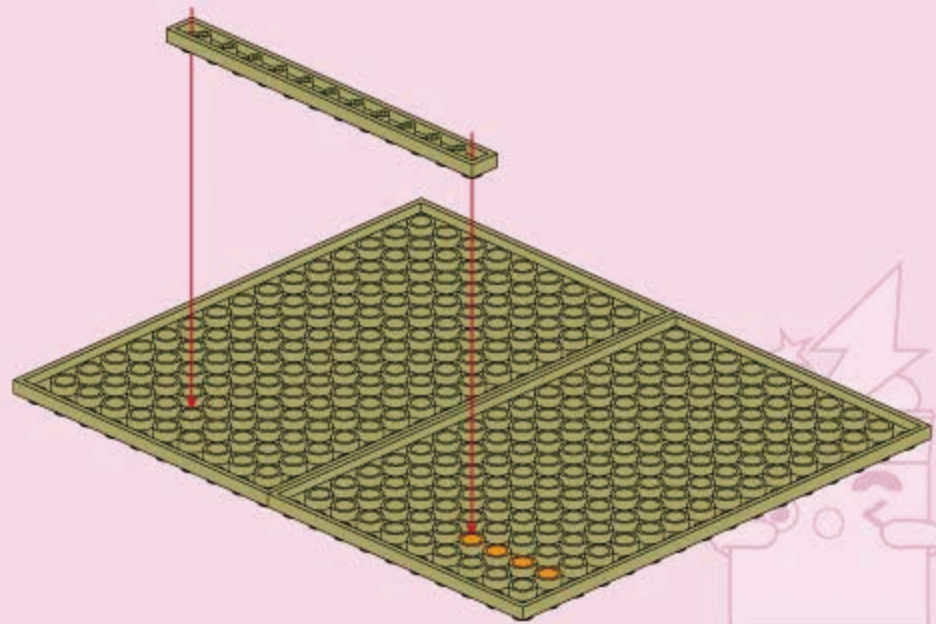

40

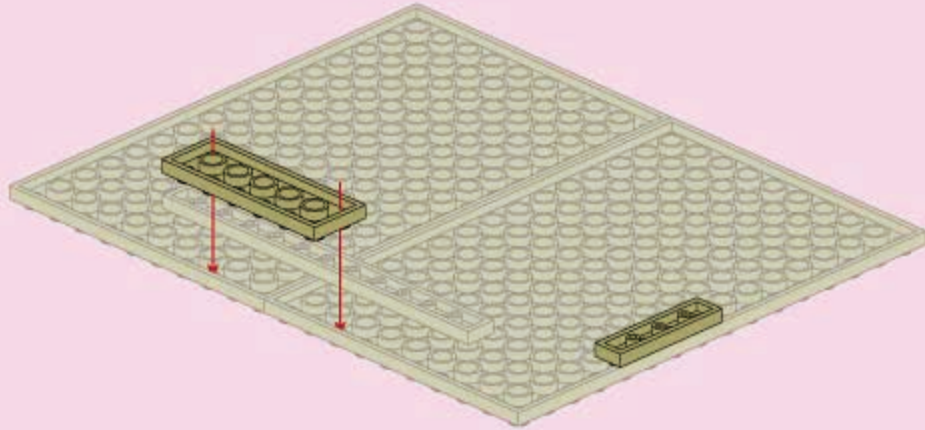

41

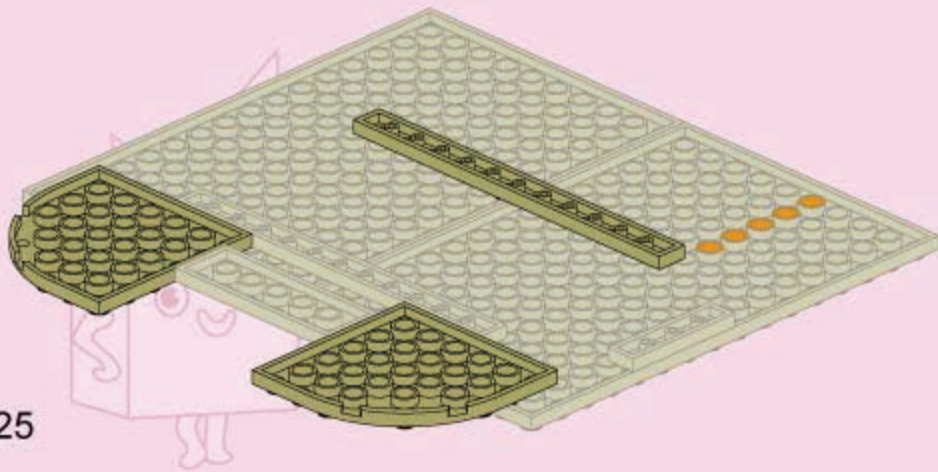
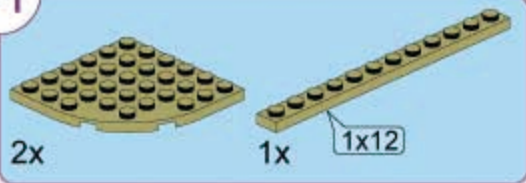

42

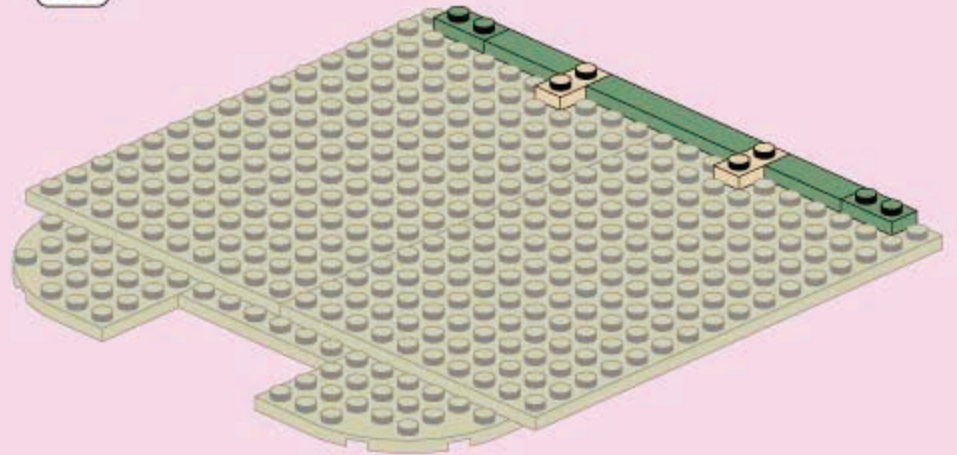
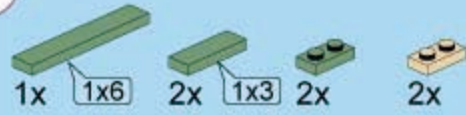

43

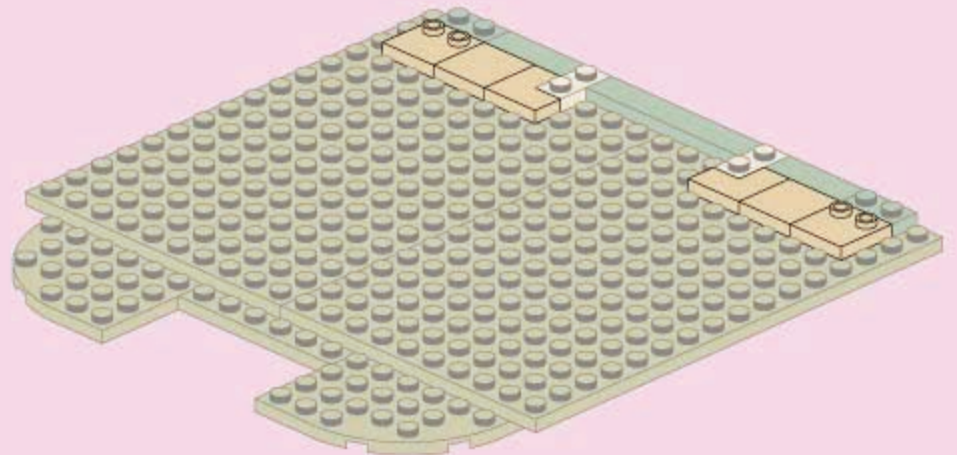

44

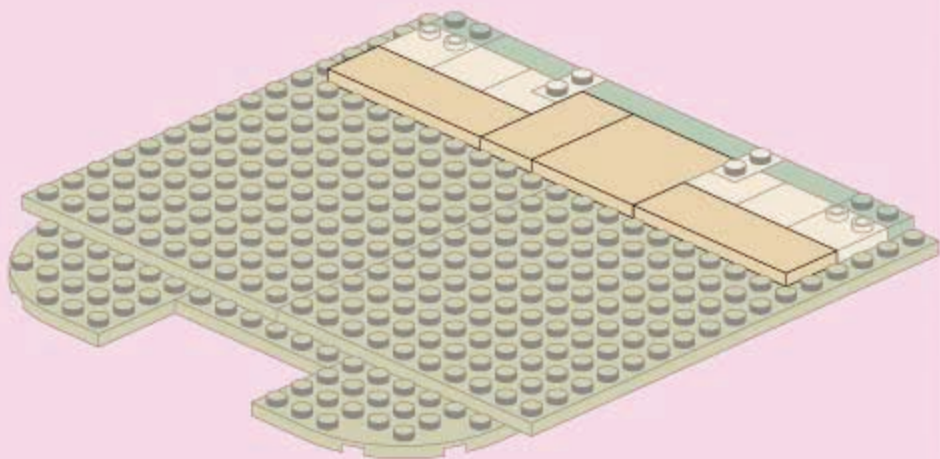
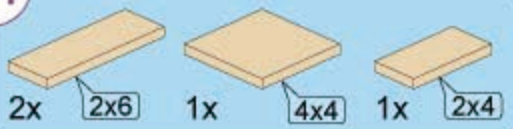

45

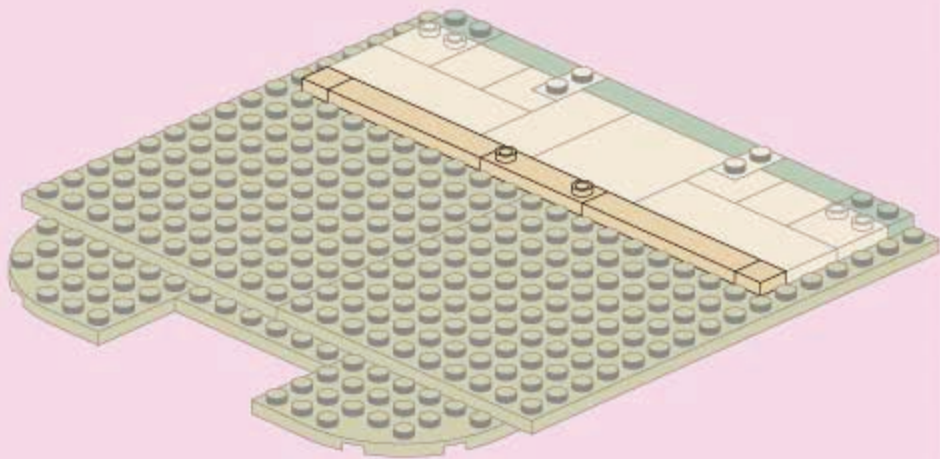

46

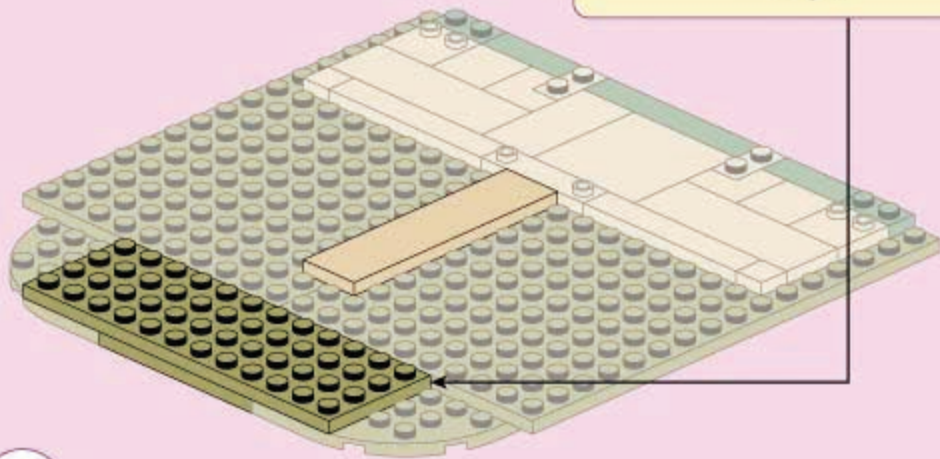
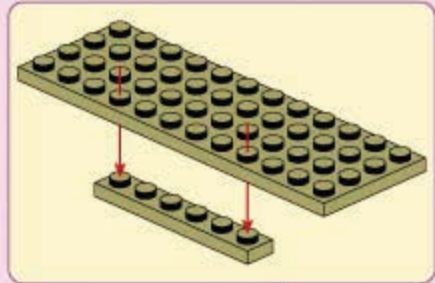
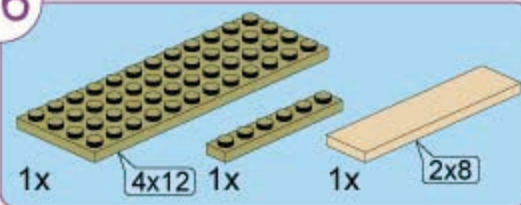

47

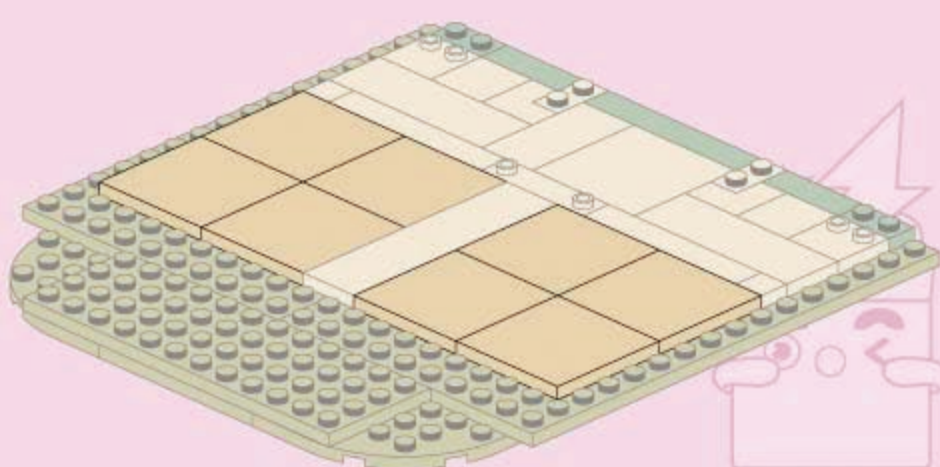
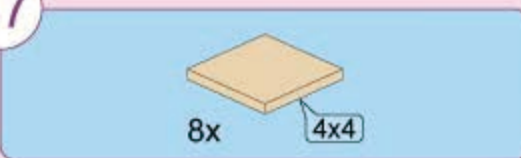

48

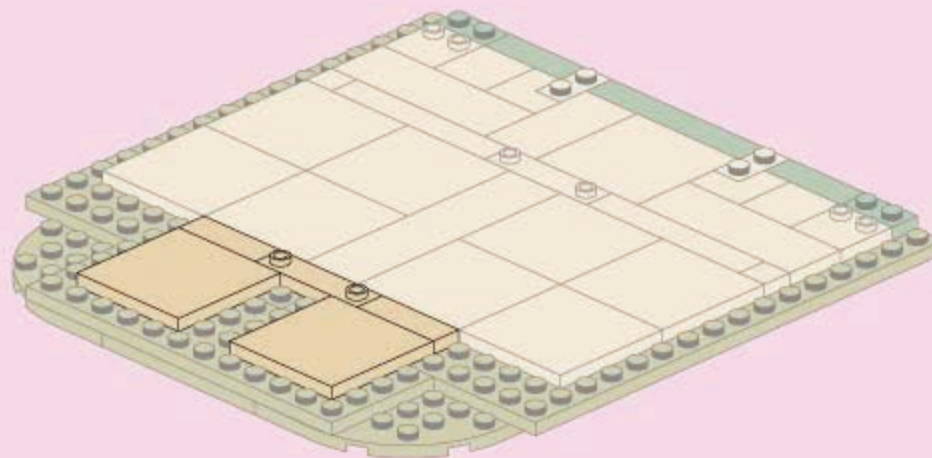
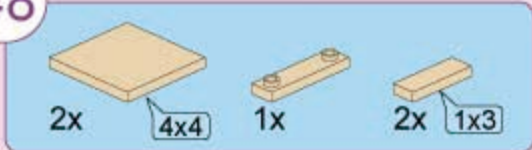

49

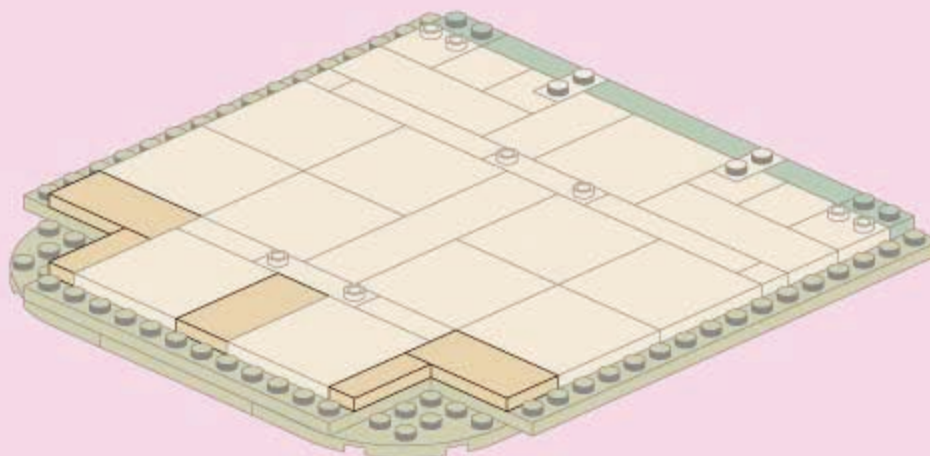

50

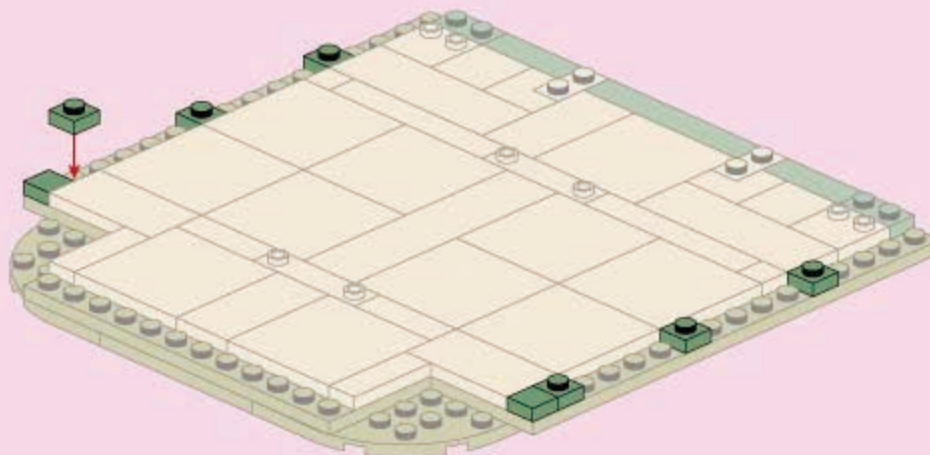
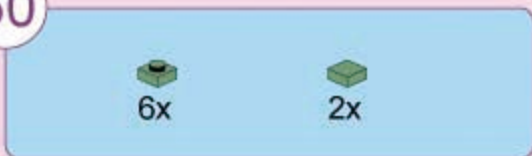

51



6x

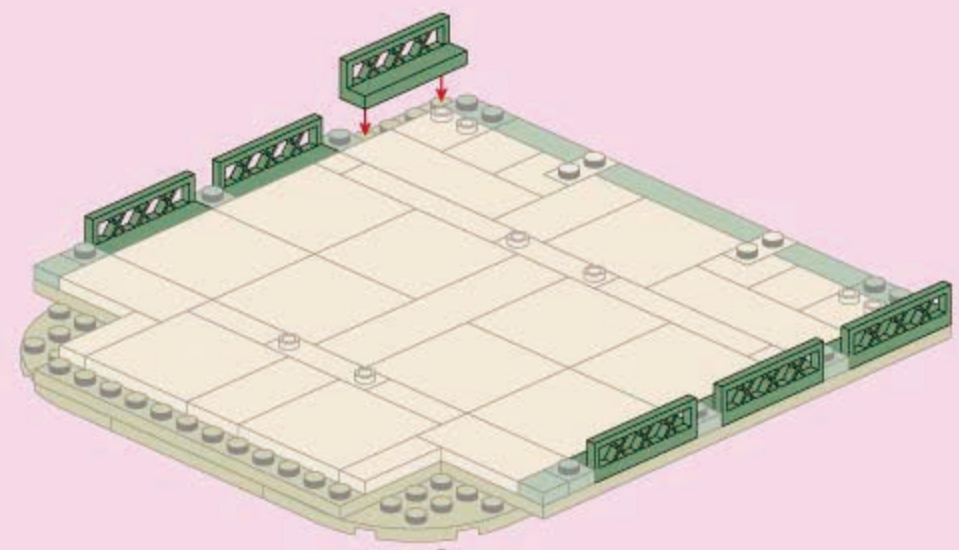

52



2x

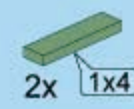

2x

1x4

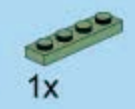

1x

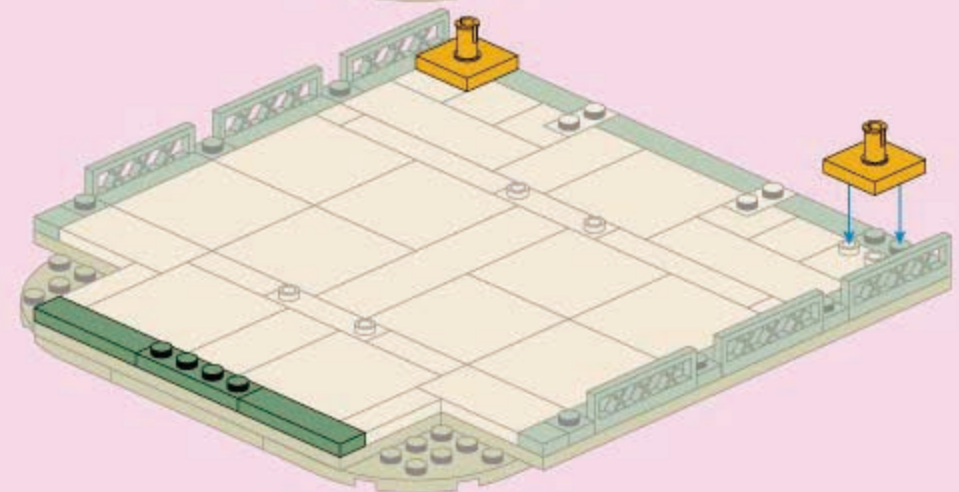

53



2x



2x



4x



4x



2x



2x

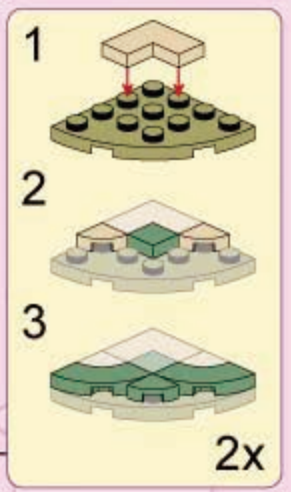
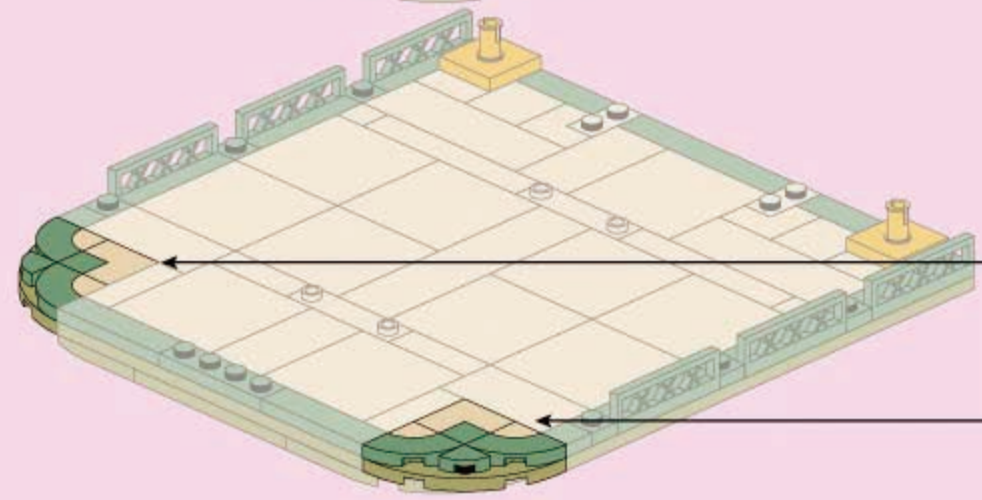

2x

54

6x 6x 6x

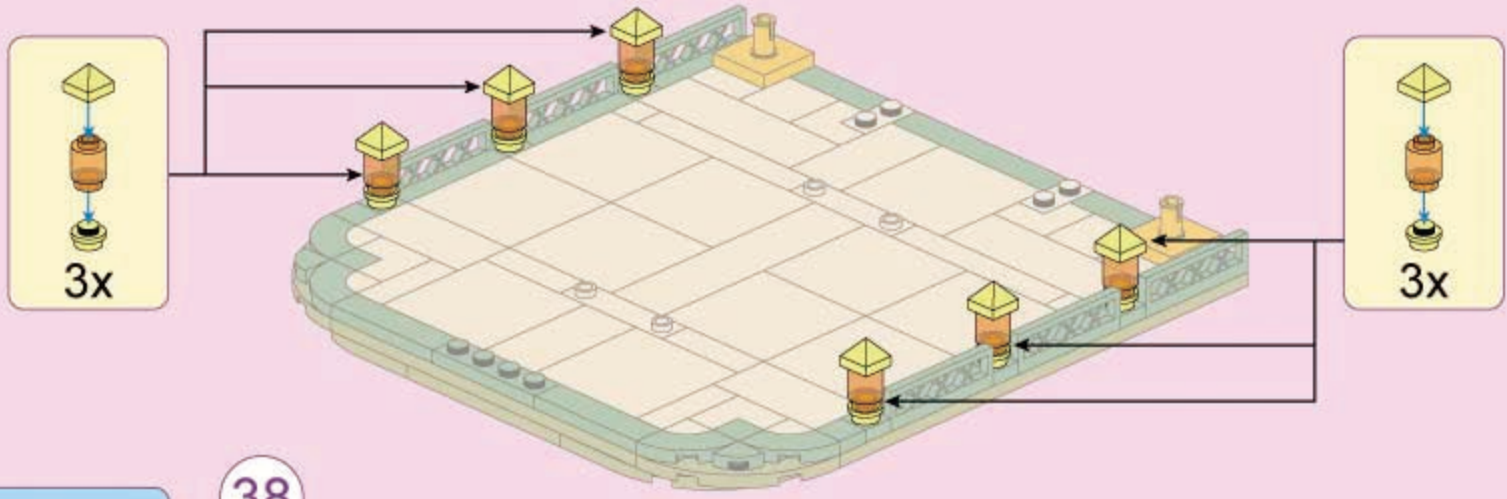

55

1x

38

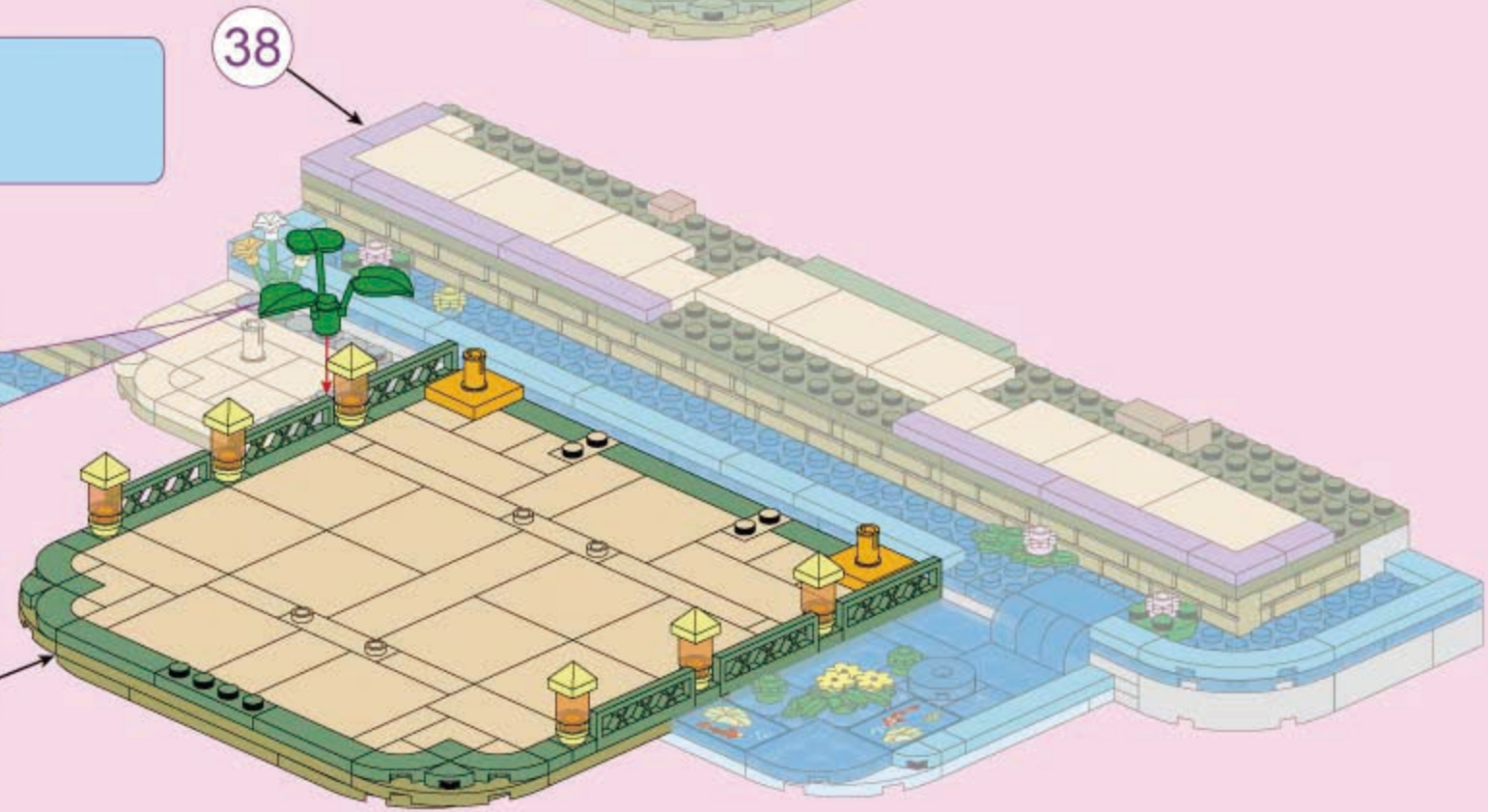

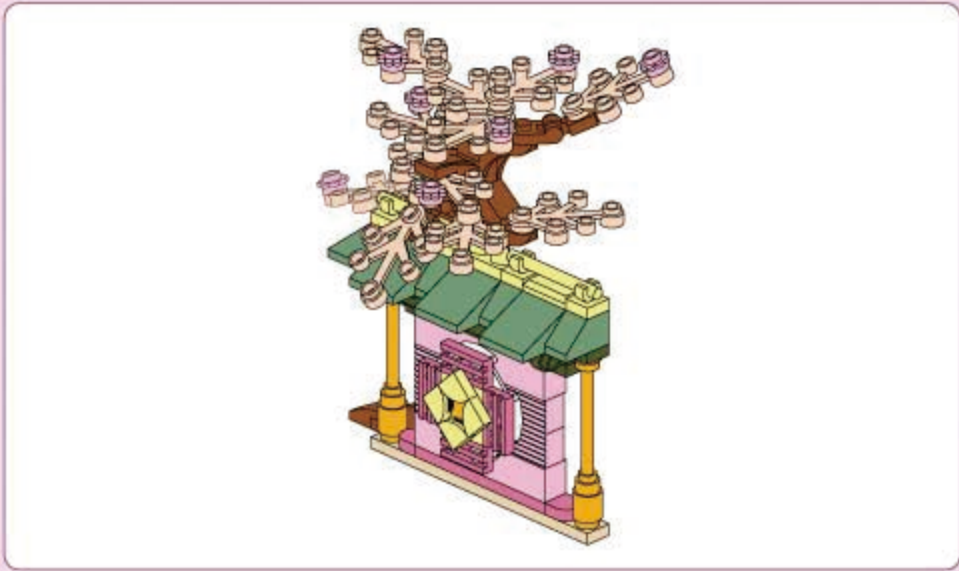

56

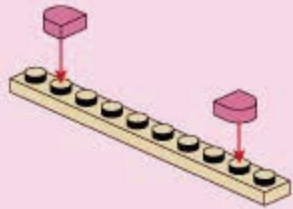
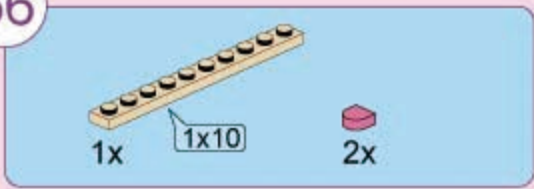

57

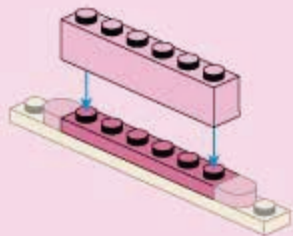
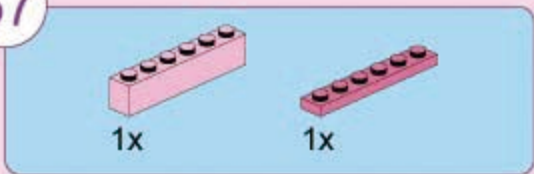

58

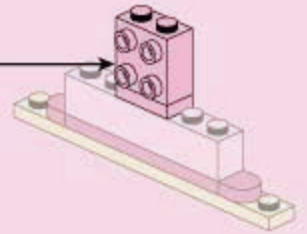
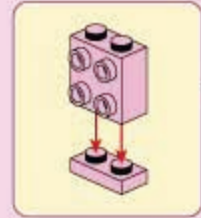
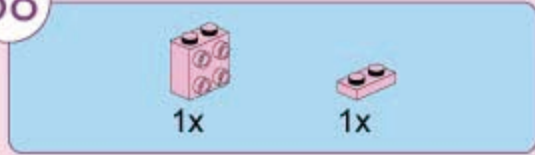

59

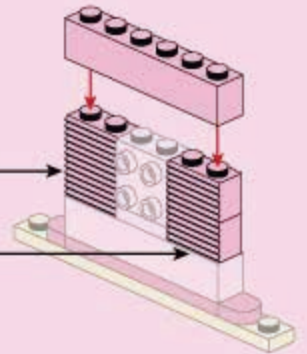
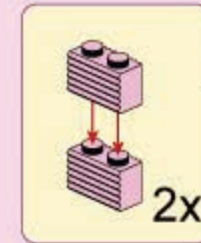
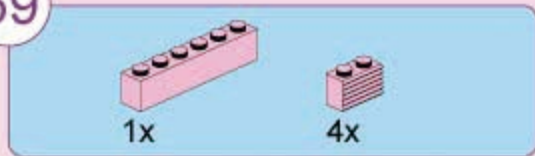

60

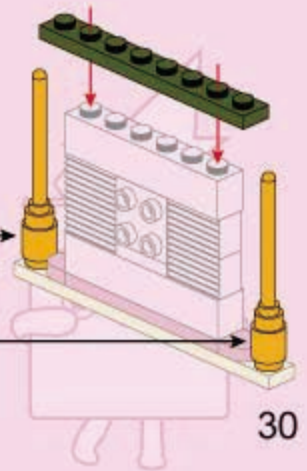
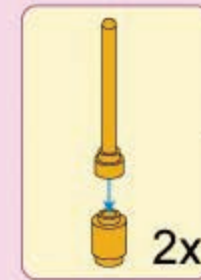
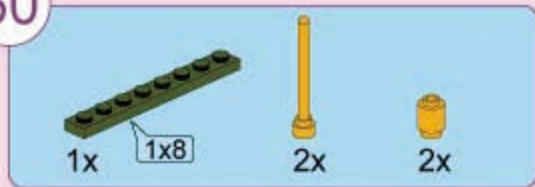

61

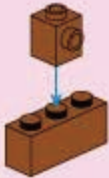
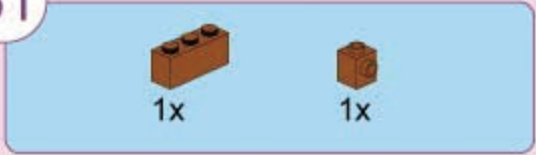

62

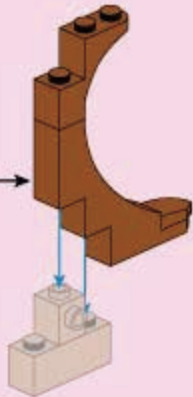
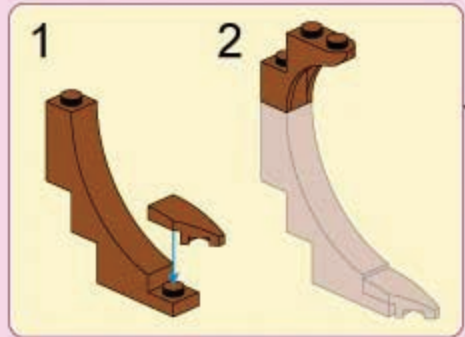
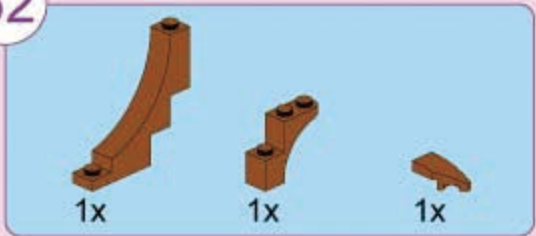

63

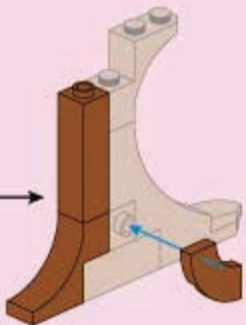
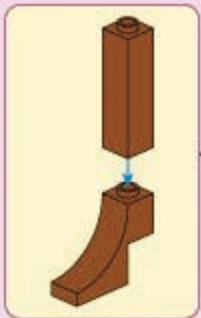
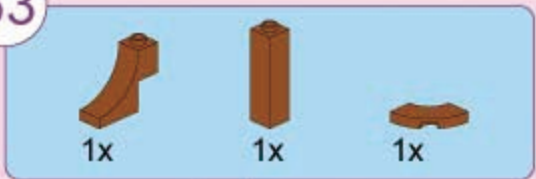

64



65

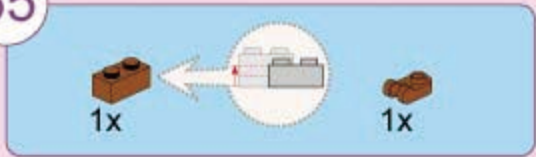

66



67



1x



1x



68



67

60

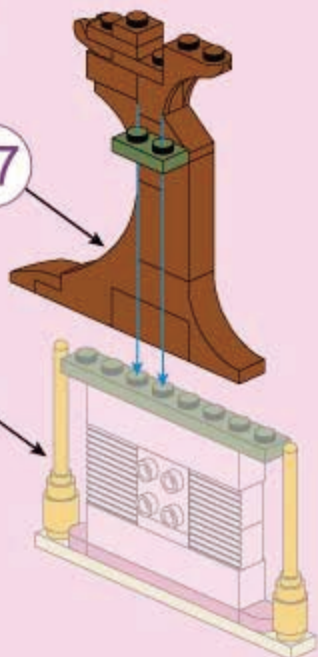

4

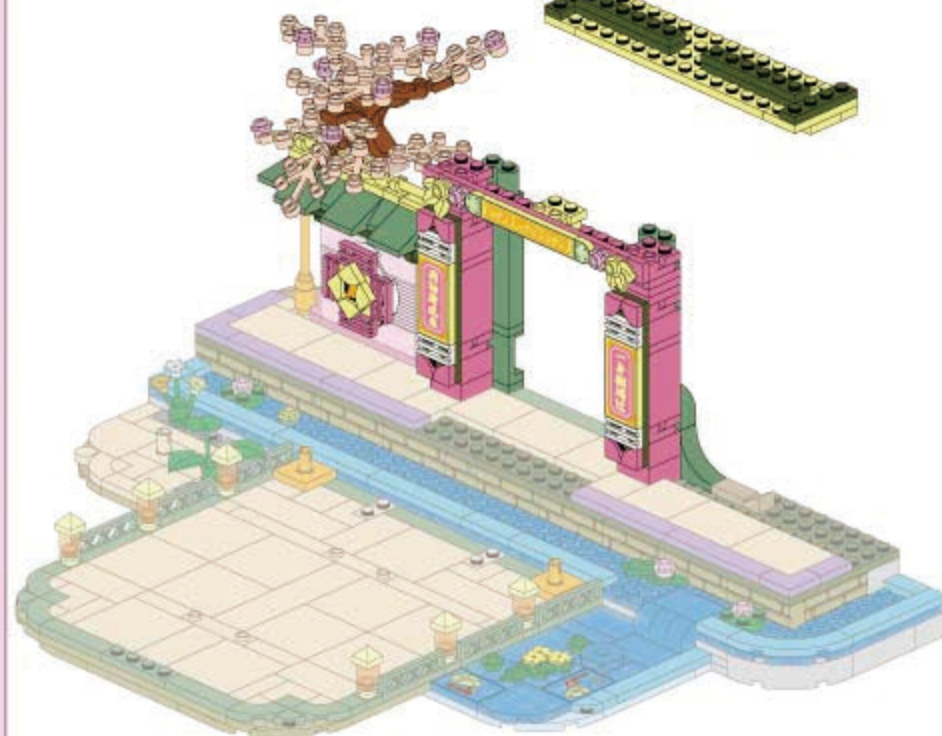

69

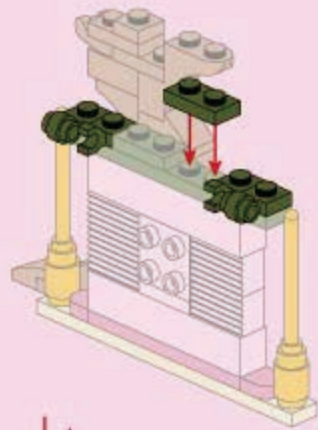

70

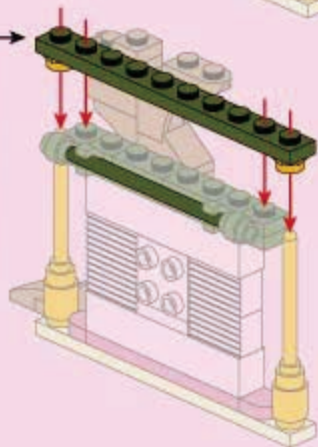
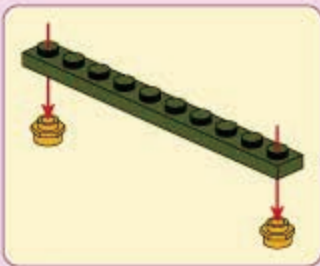
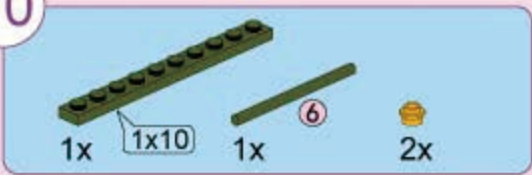

71

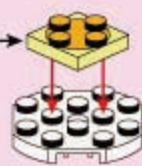
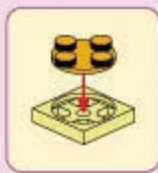

72

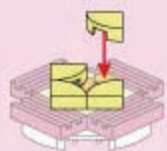

73

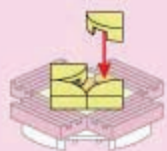

74

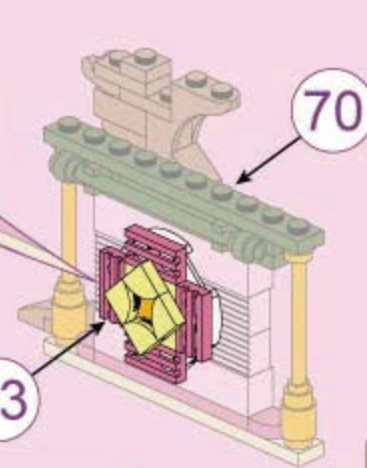
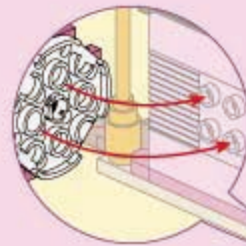

75

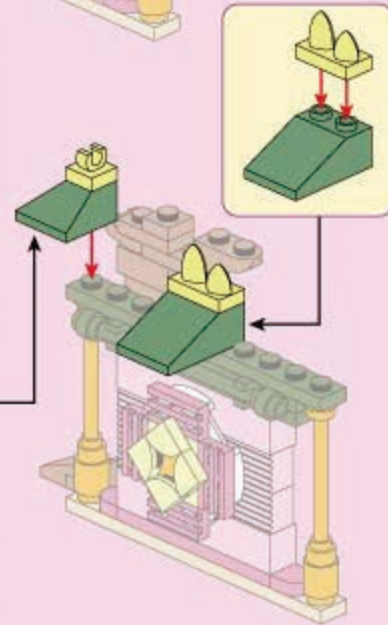
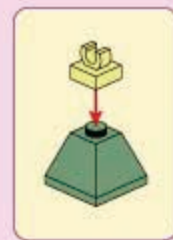

76

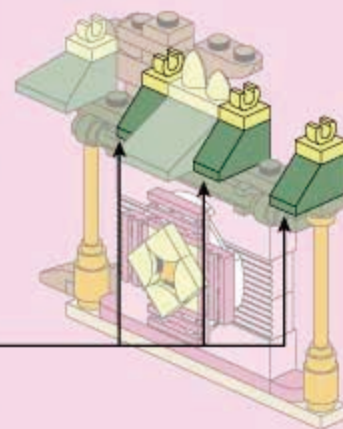

77

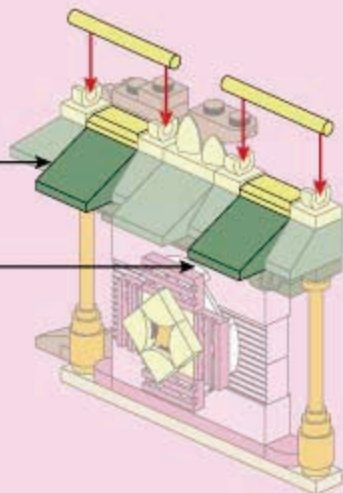
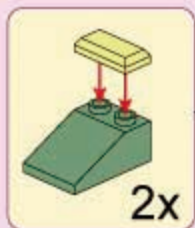

78

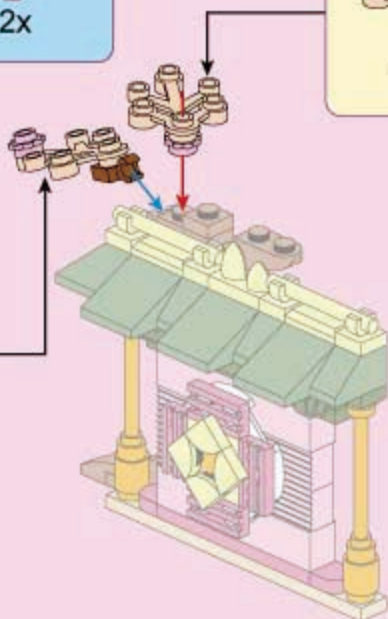
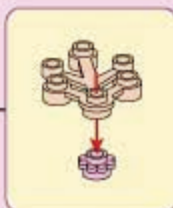
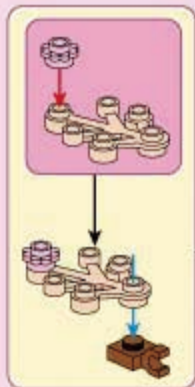

79

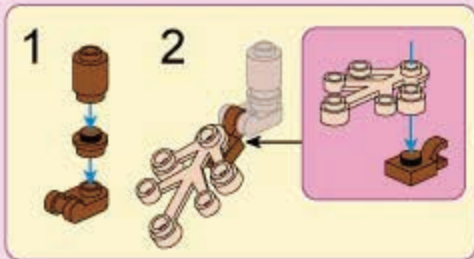

80



81



1x



1x



82



2x



1x



1x

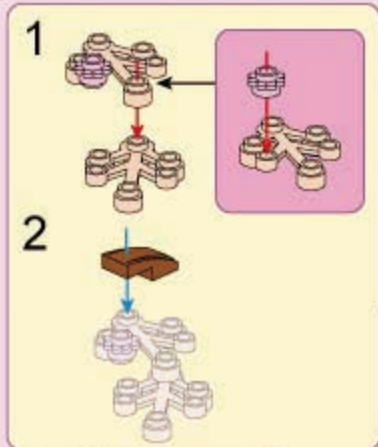

83



1x



1x



1x

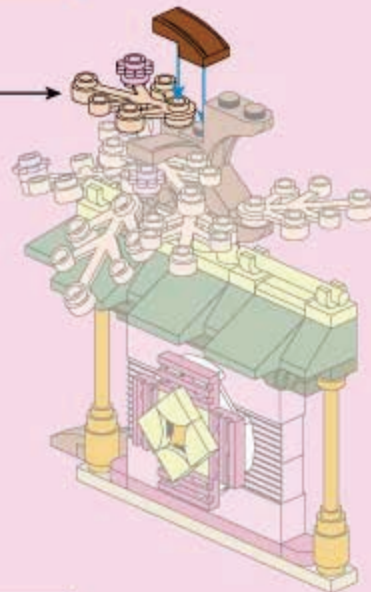

84



1x



1x



1x



1x

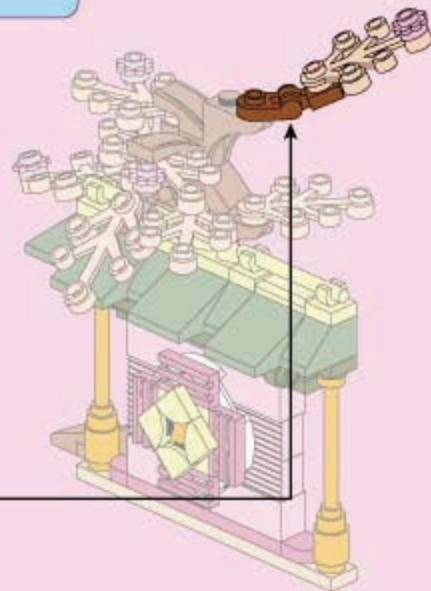
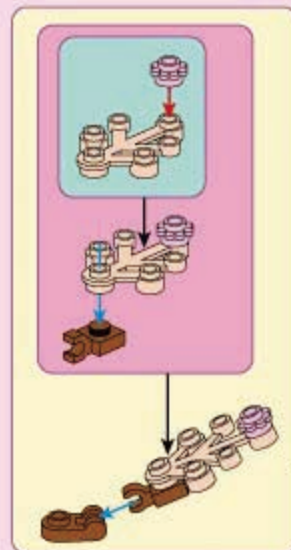

85



4x



3x

1

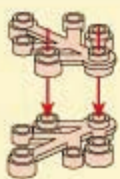

2

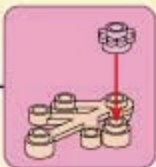
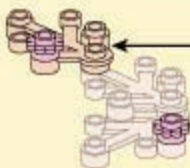

3

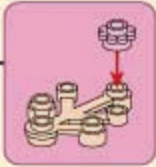
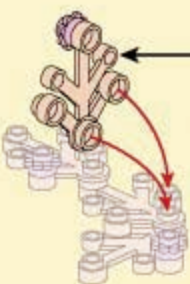

86

85



55

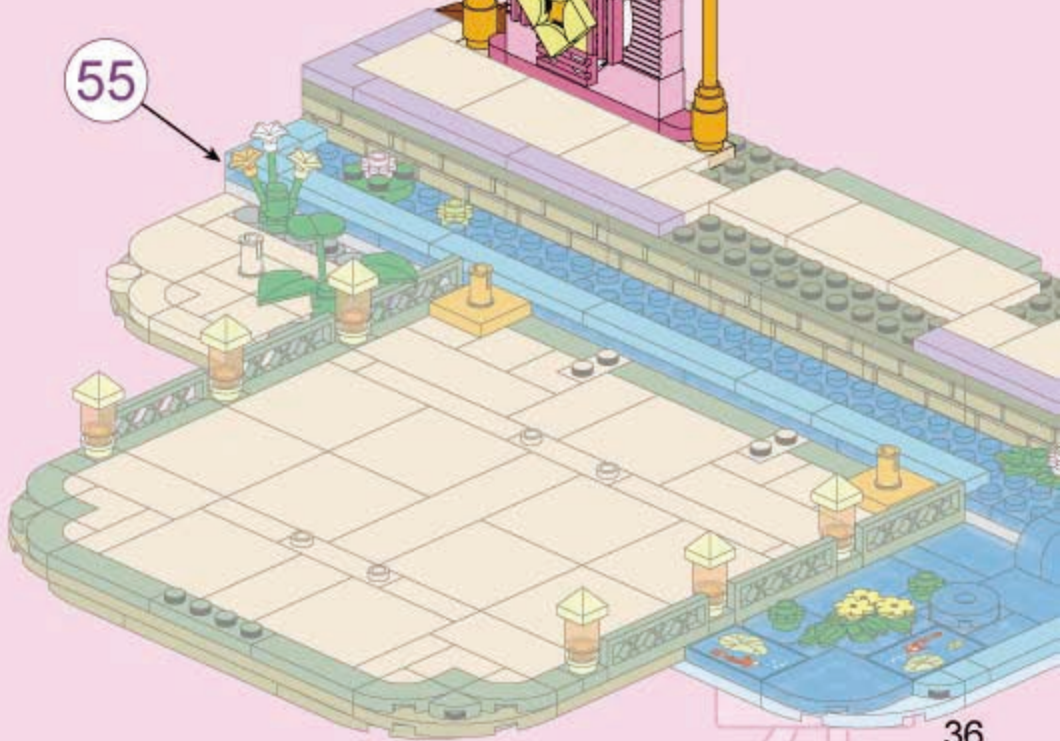

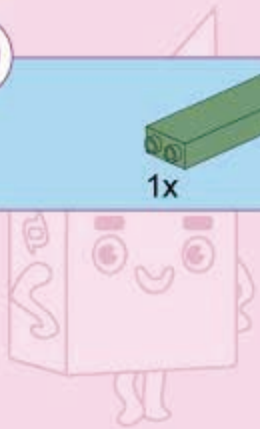
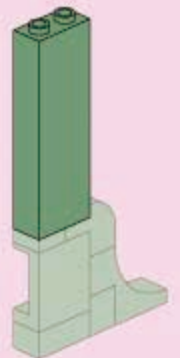
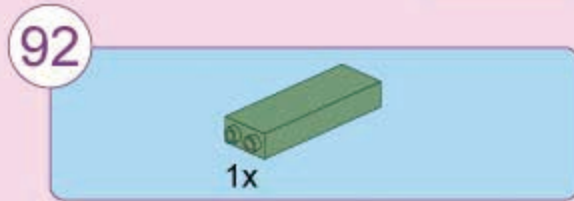
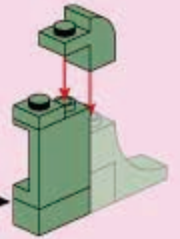
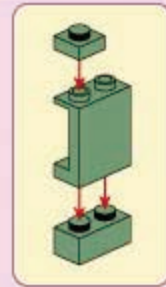
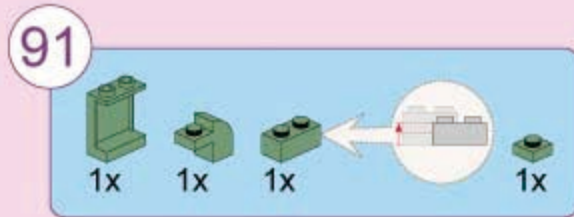
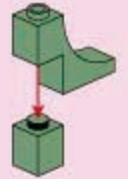
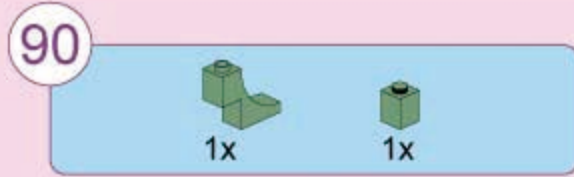
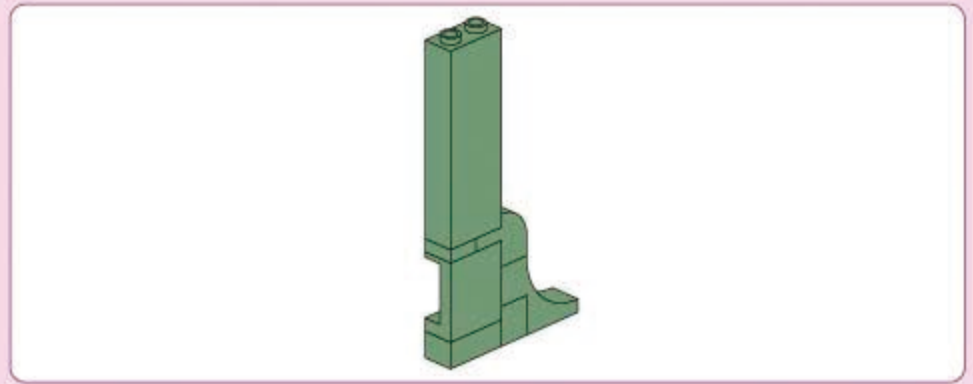
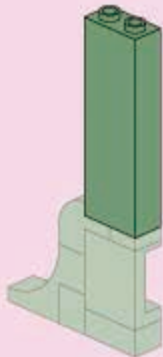
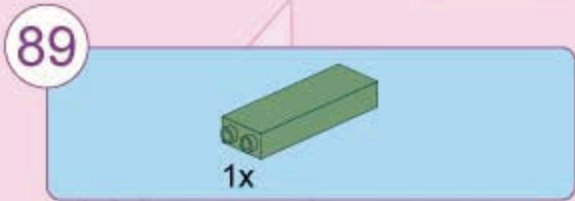
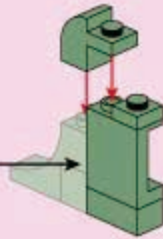
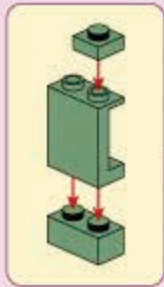
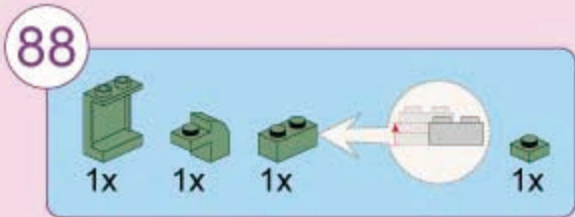
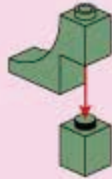
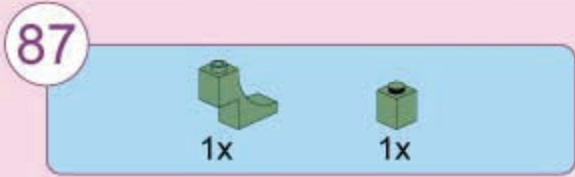
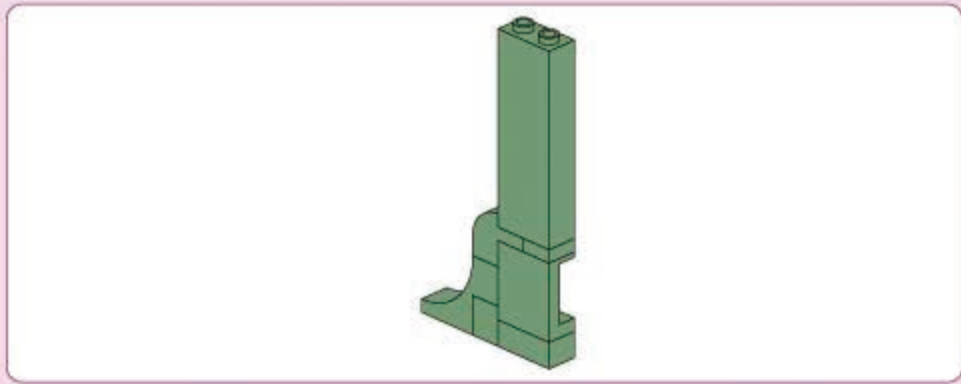

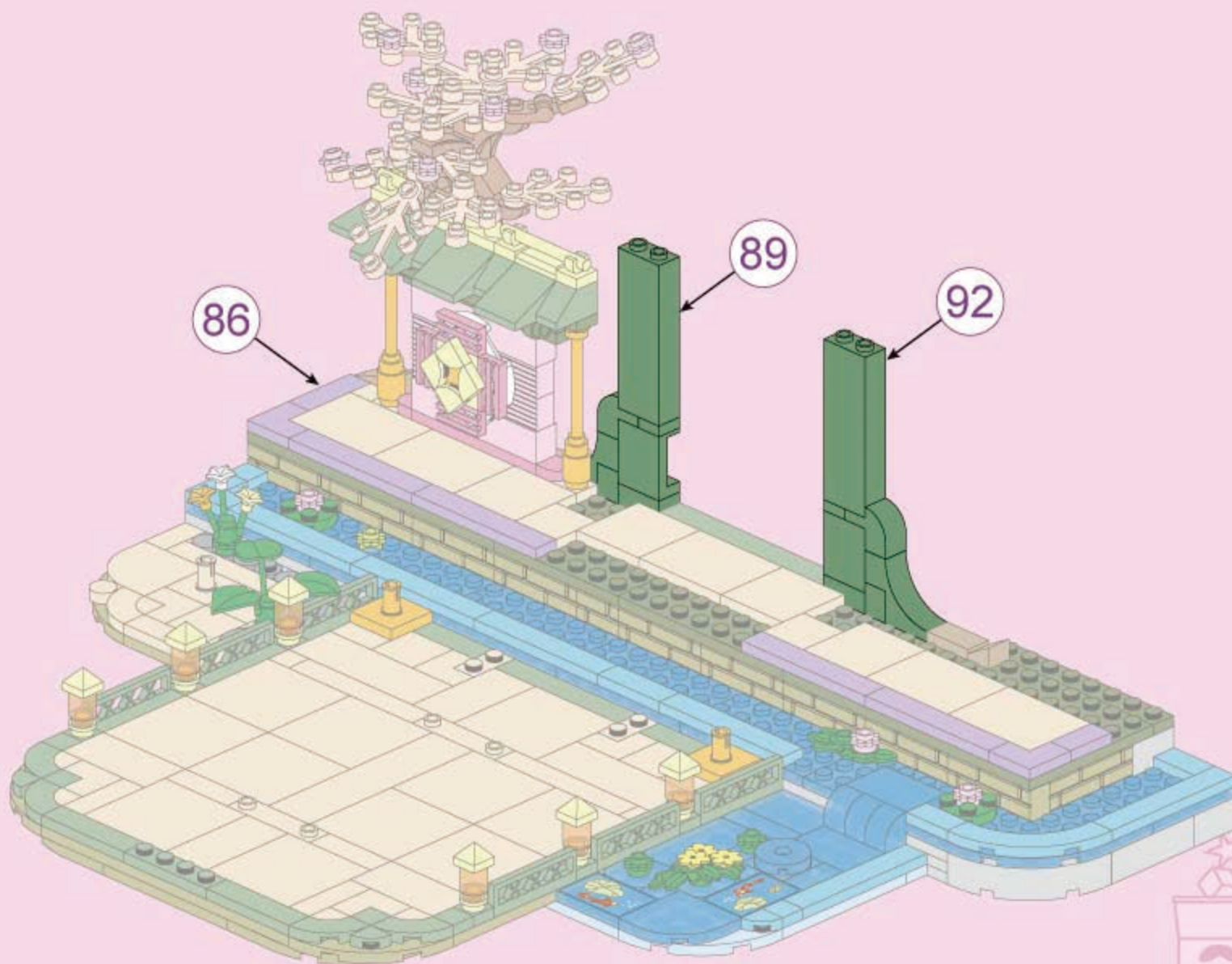

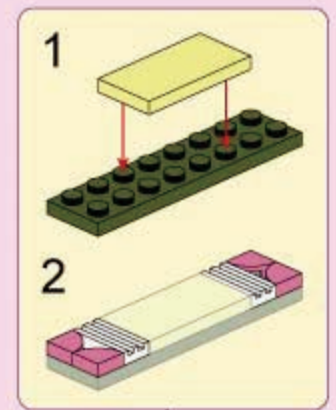
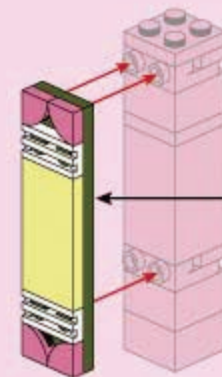
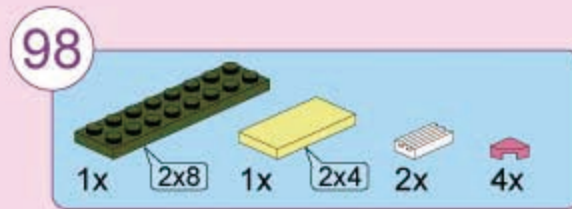
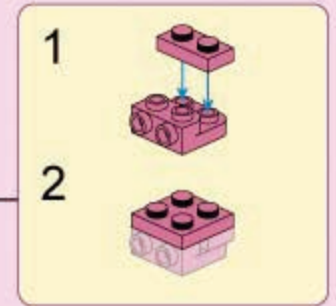
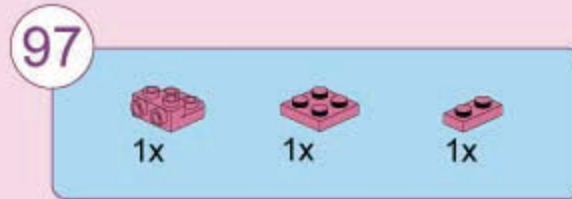
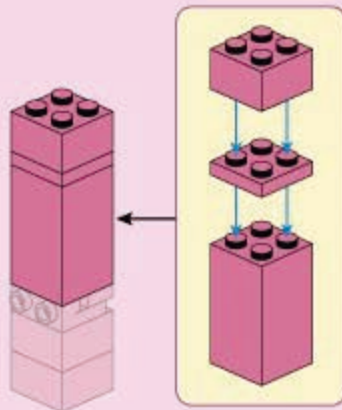
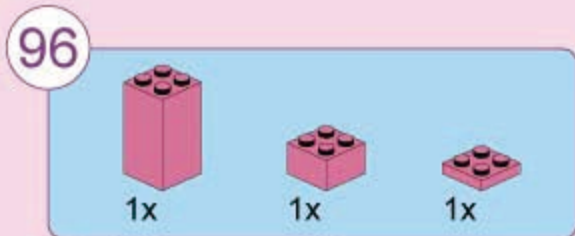
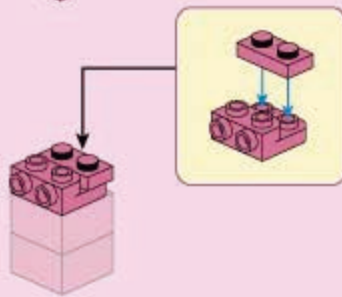
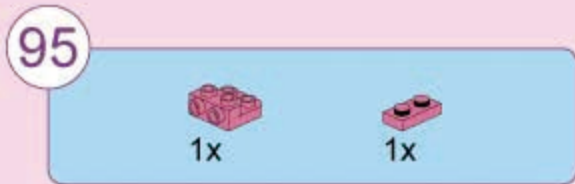
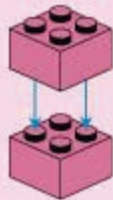
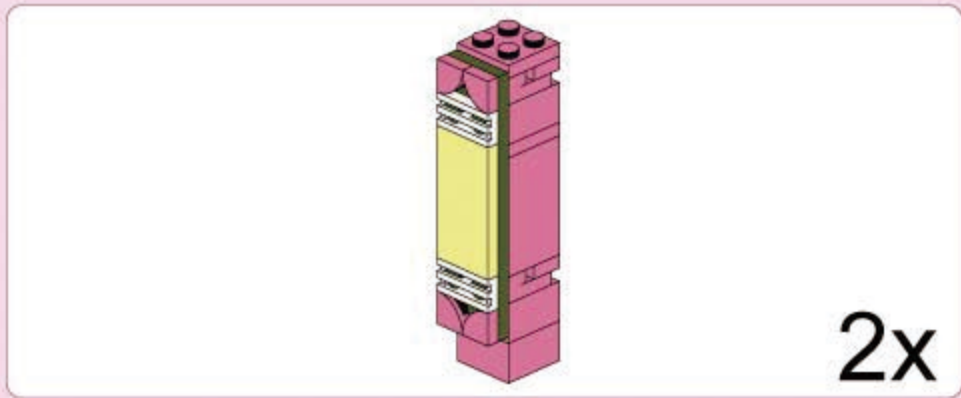

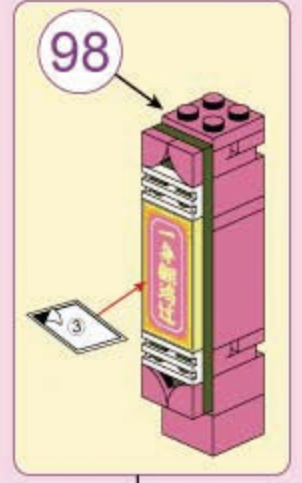
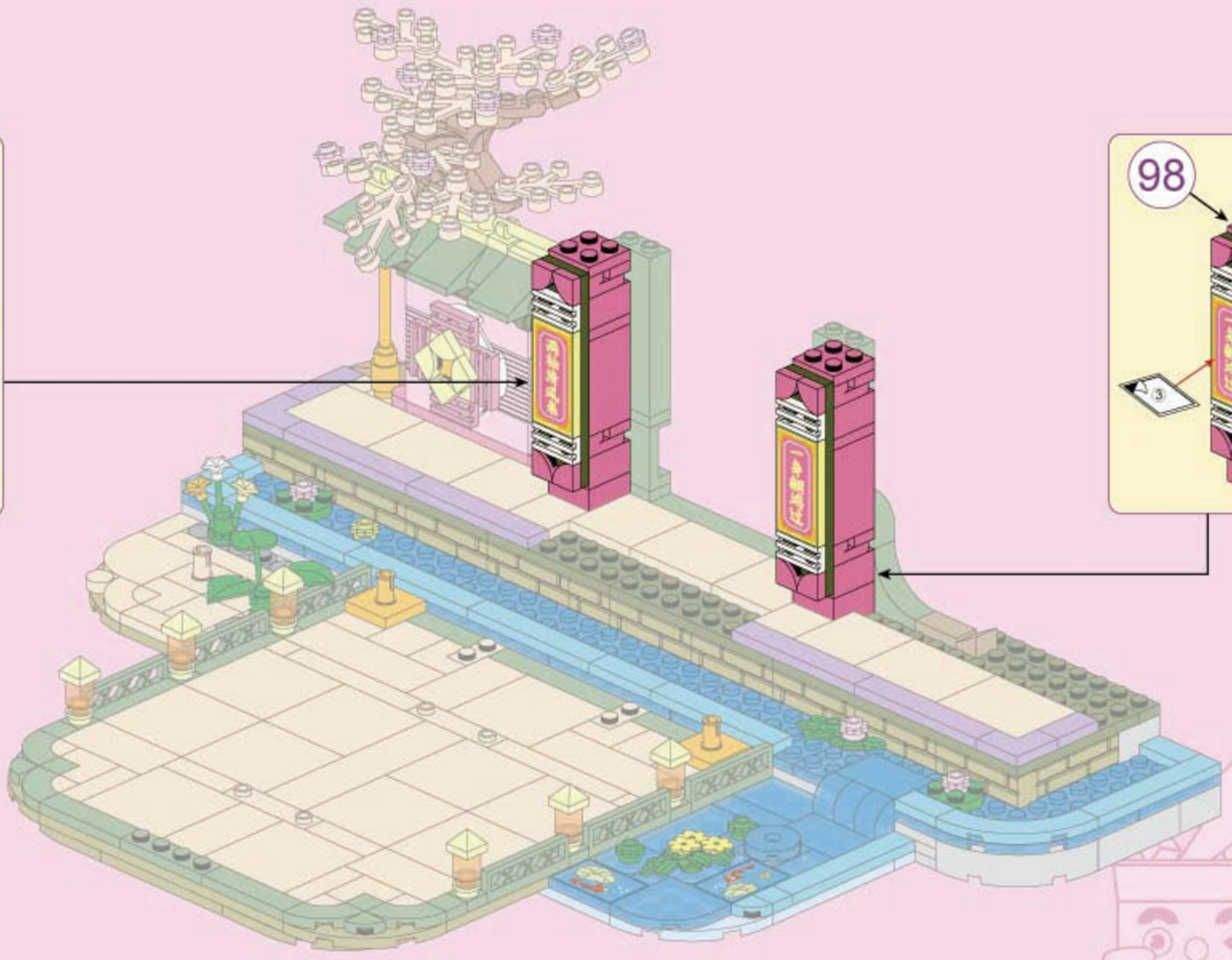
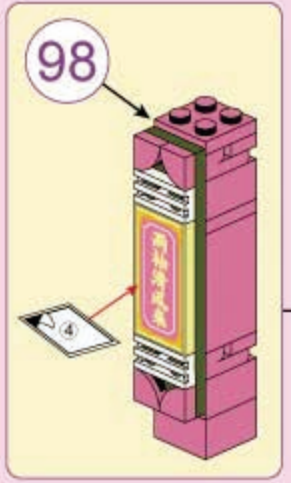

100



2x



2x



2x

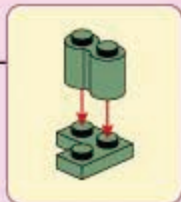
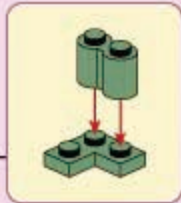
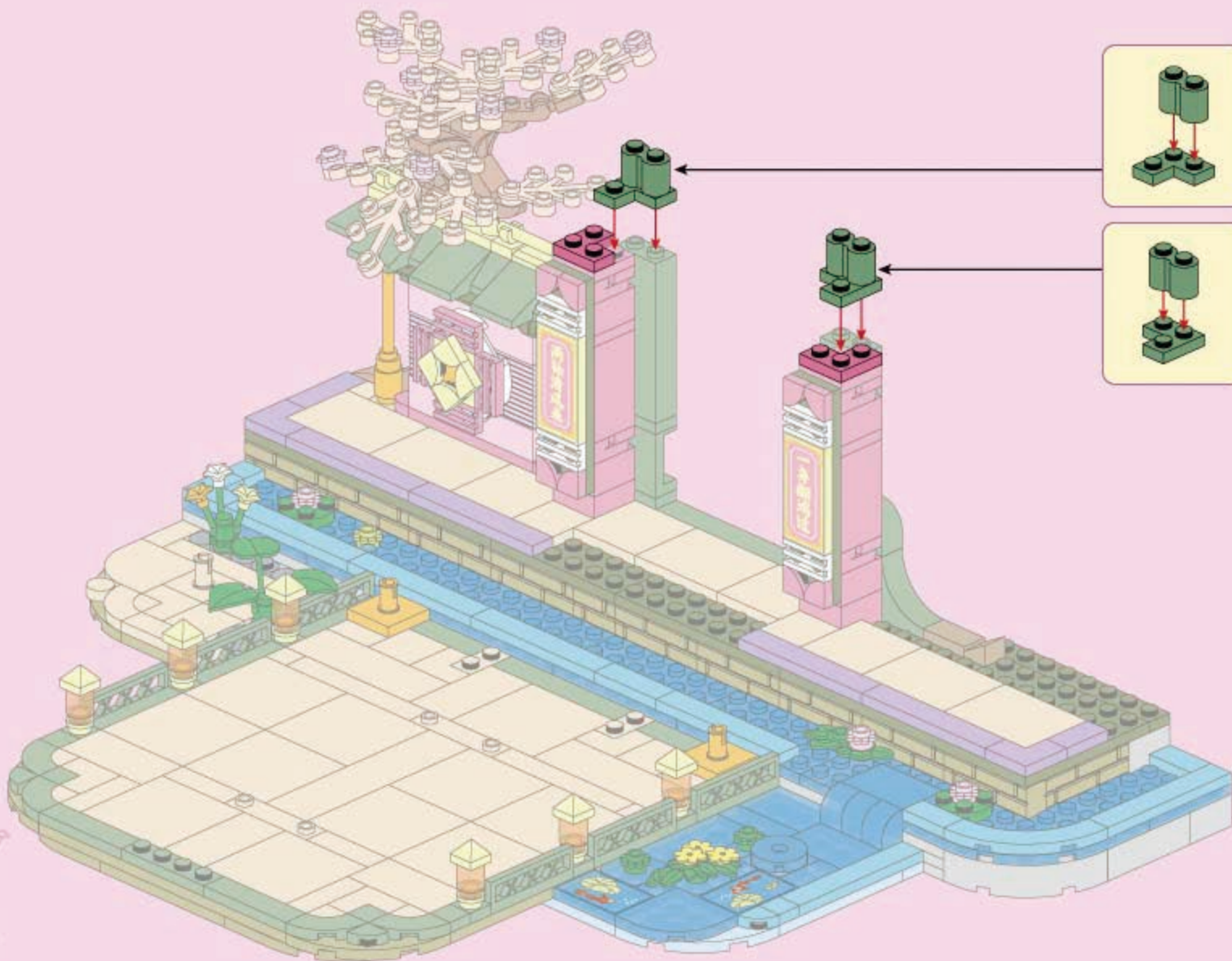

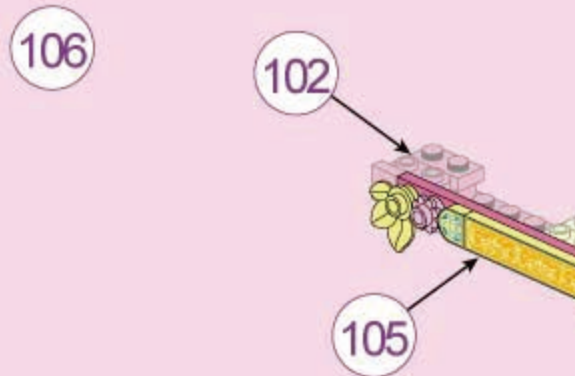
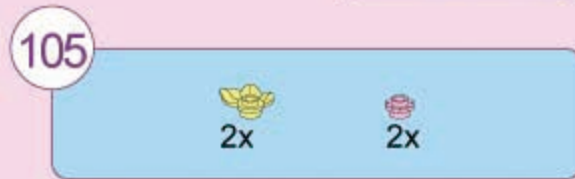
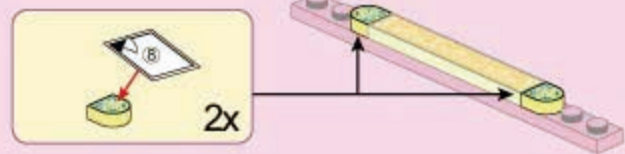
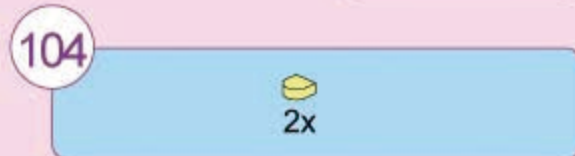
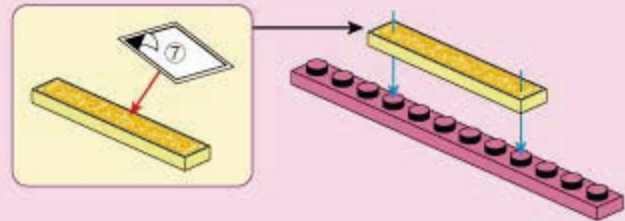
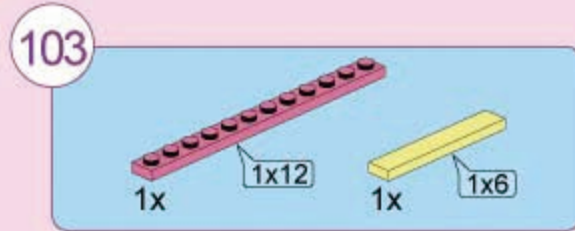
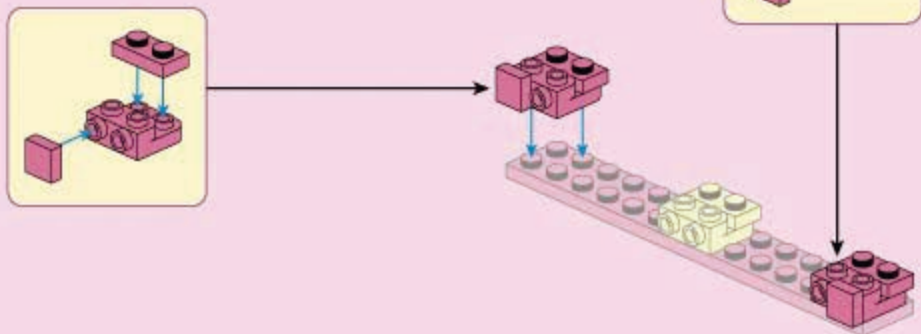
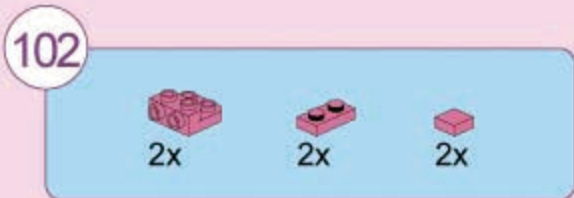
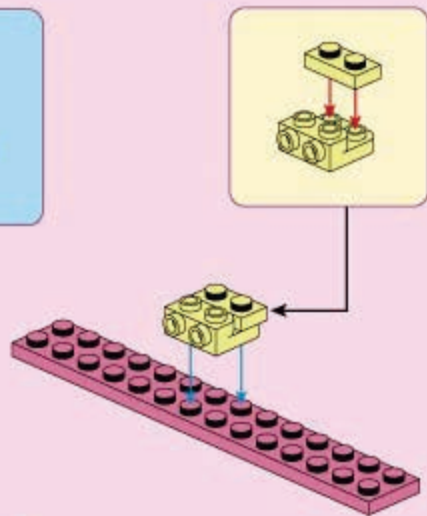
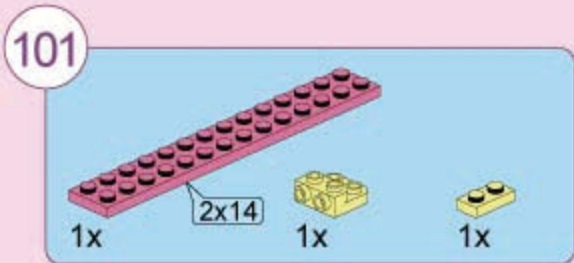
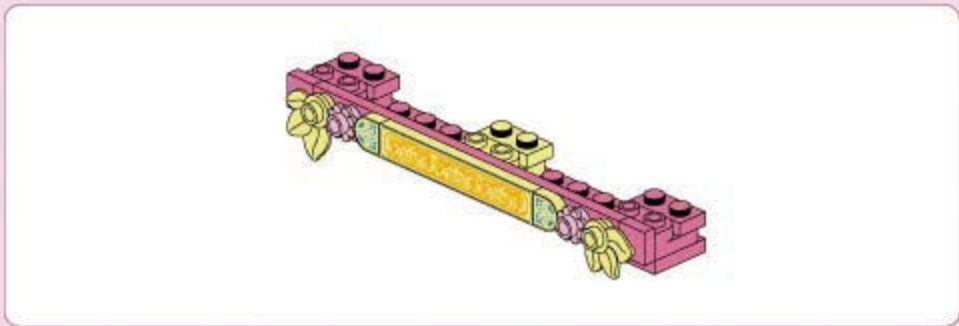

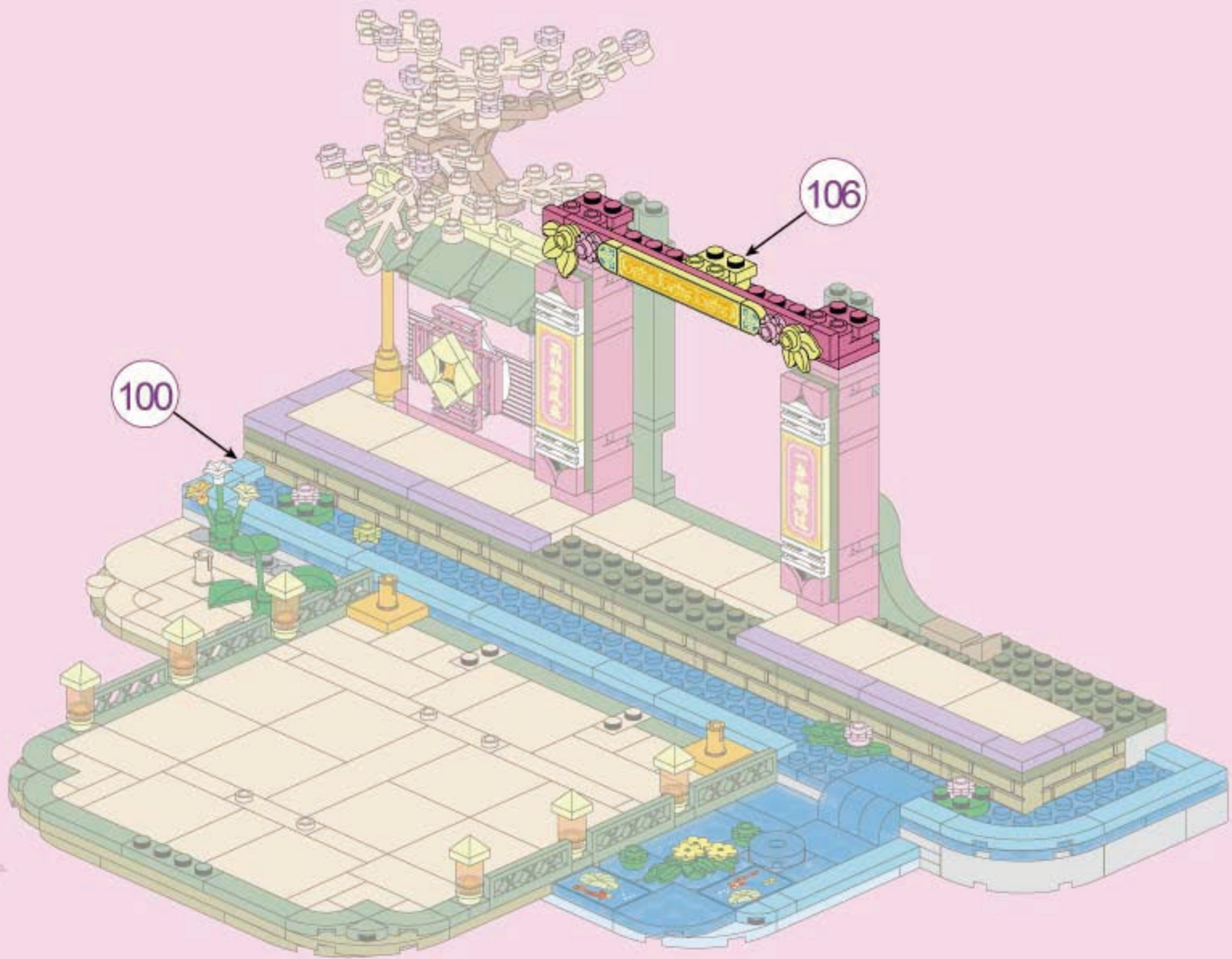



108

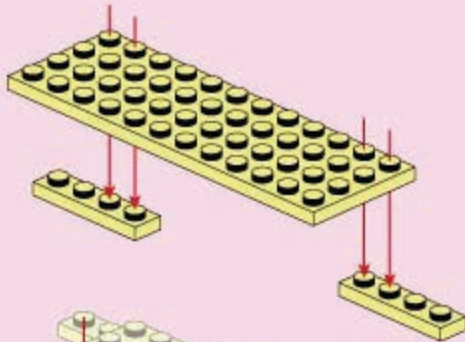
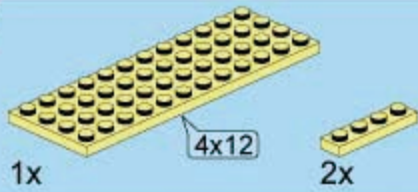

109

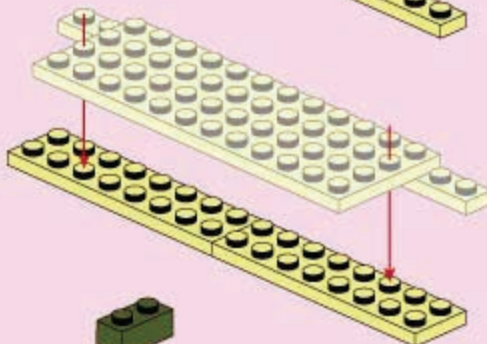
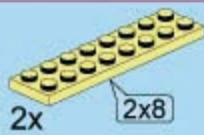

110

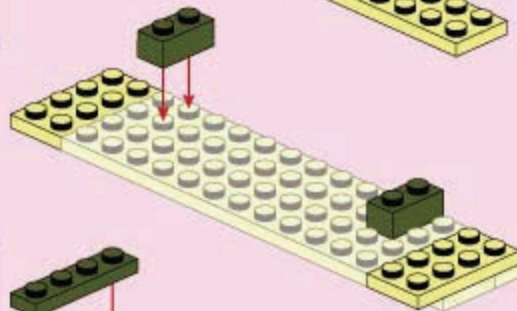

1:1

111

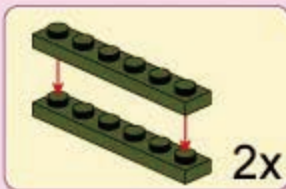
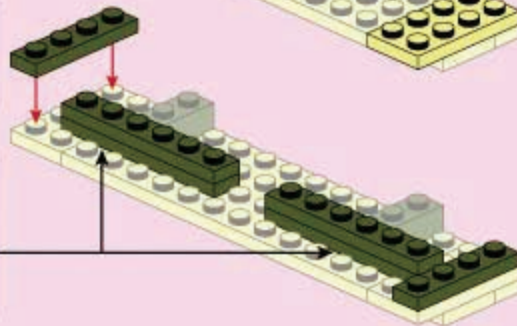

5

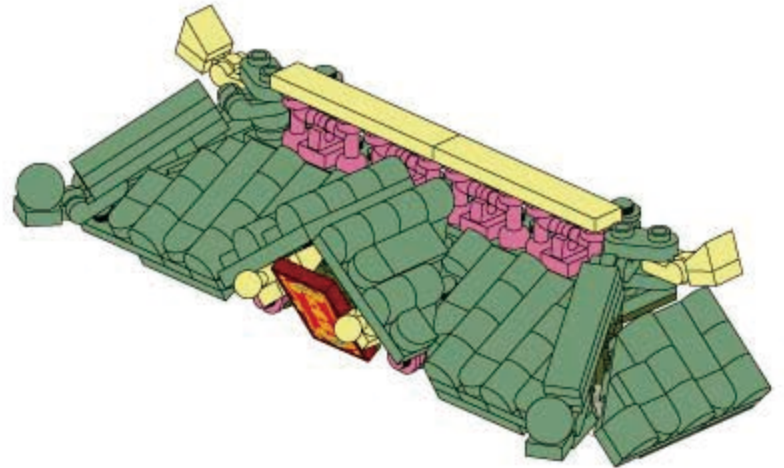

112

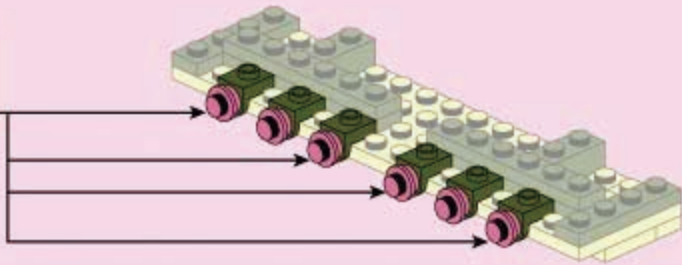
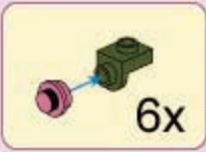

113

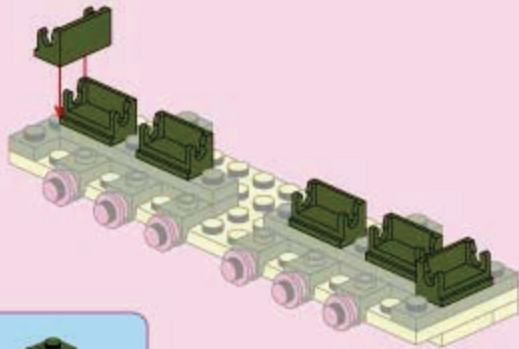

114

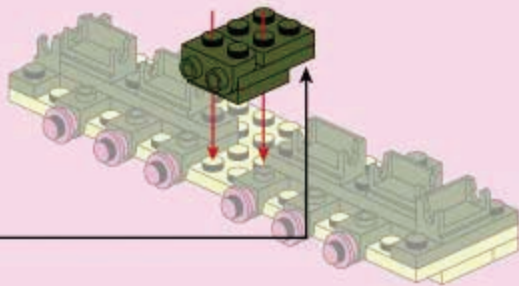
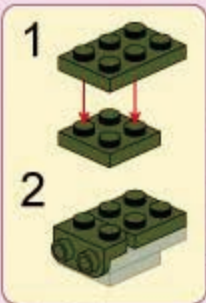

115

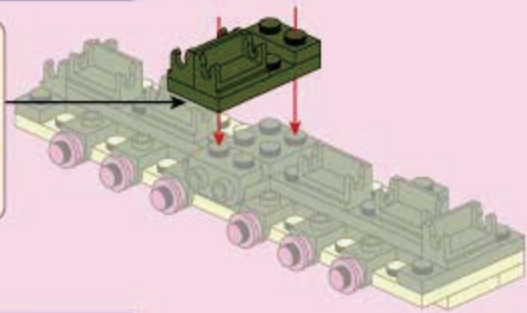
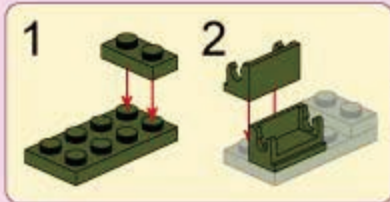

116

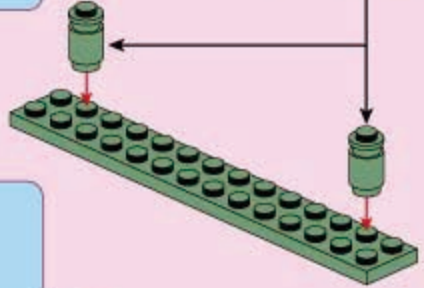
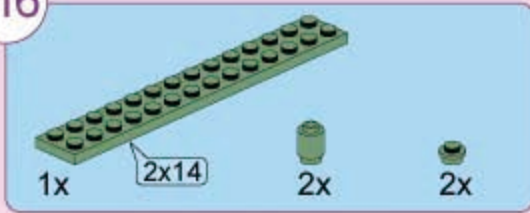

117

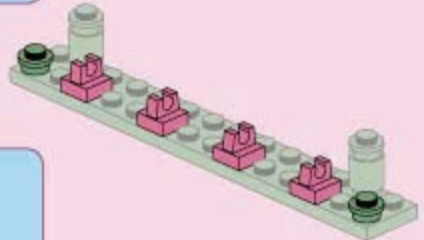
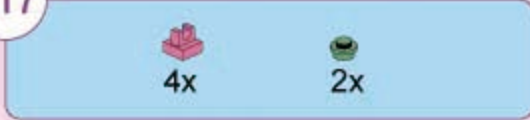

118

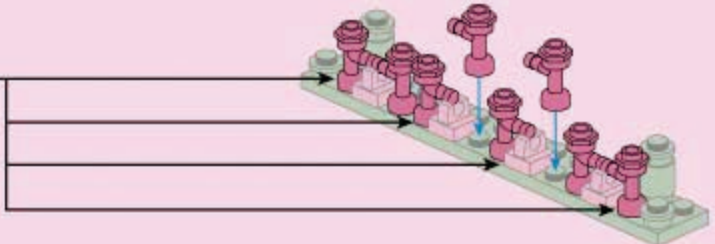

119

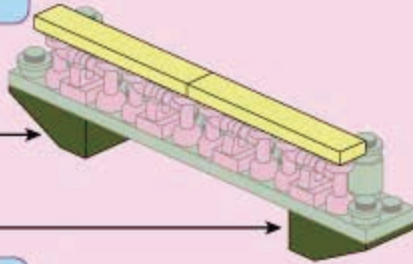

120

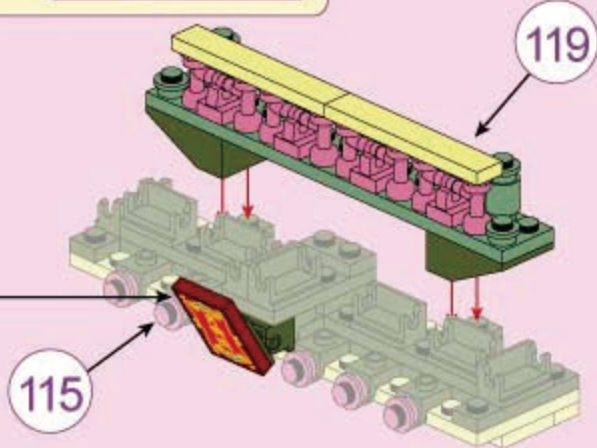
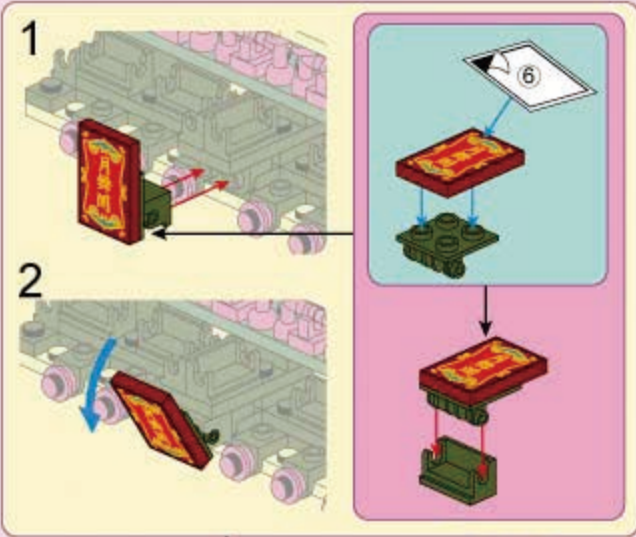

121

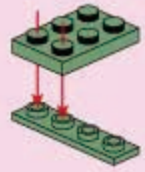

122



123



124

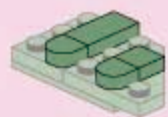

125

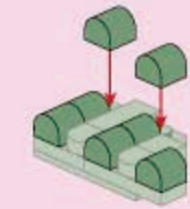
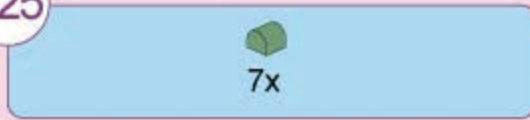

126

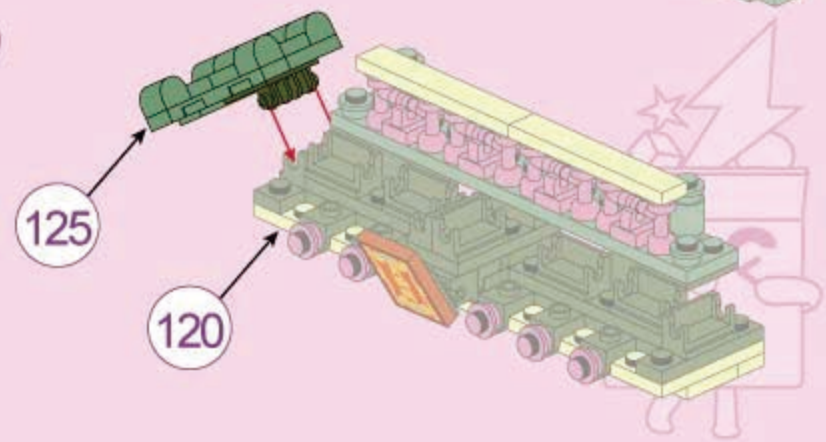

127

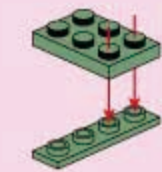

128



129



130

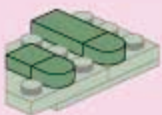

131

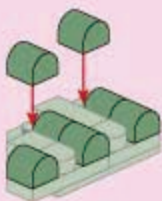
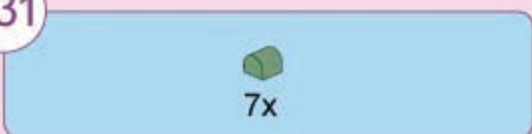

132

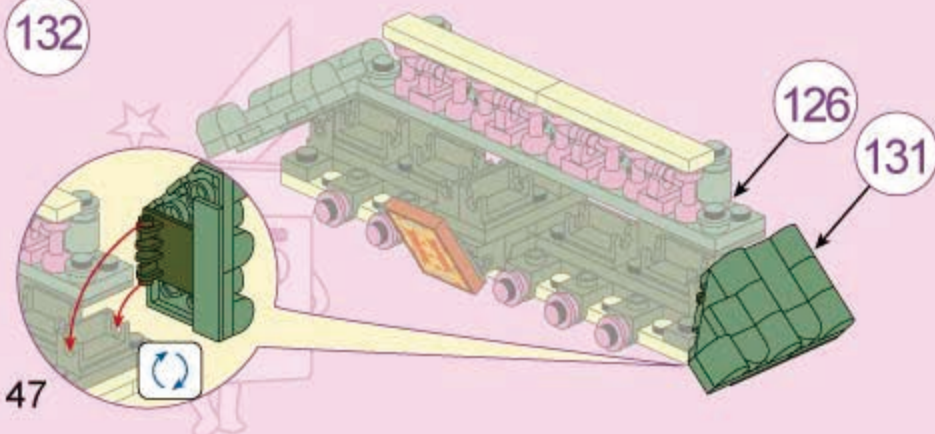

133

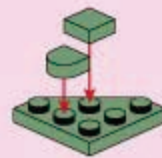

134

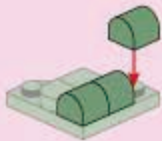

135

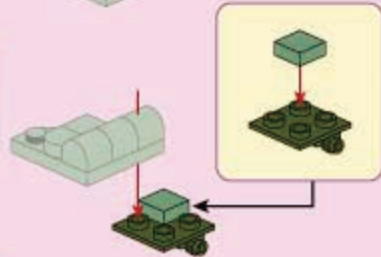
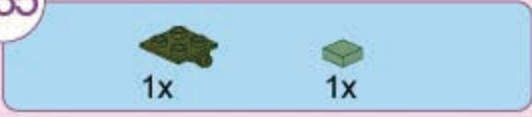

136



137

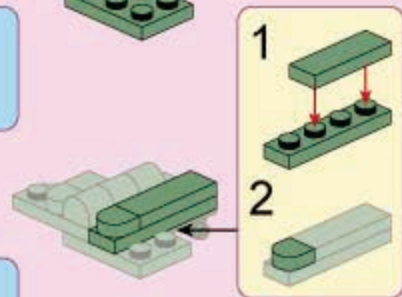
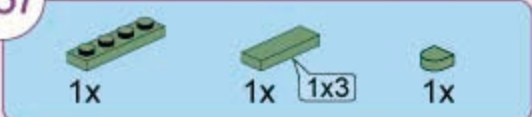

138



139



140
5x



141

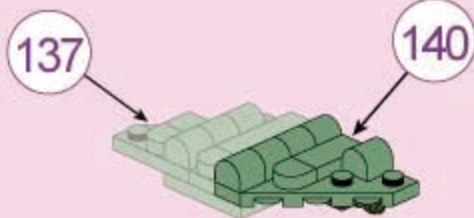

142

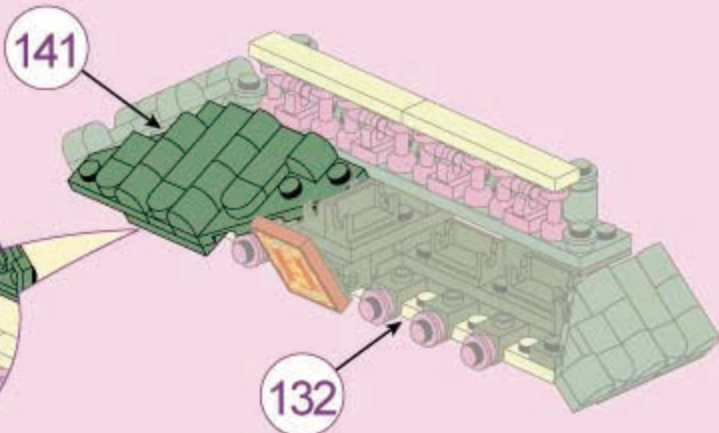

143

1x 1x

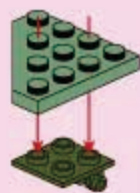

144

1x 1x

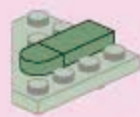

145

5x

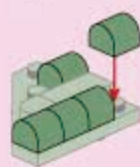

146

1x

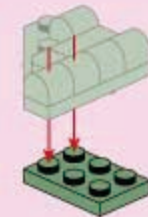

147

1x 1x 1x 1x3 1x 1x

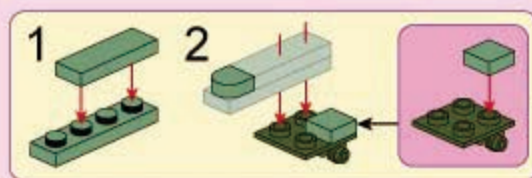

148

1x 3x 1x 1x

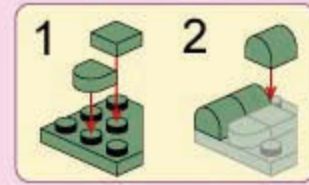

149

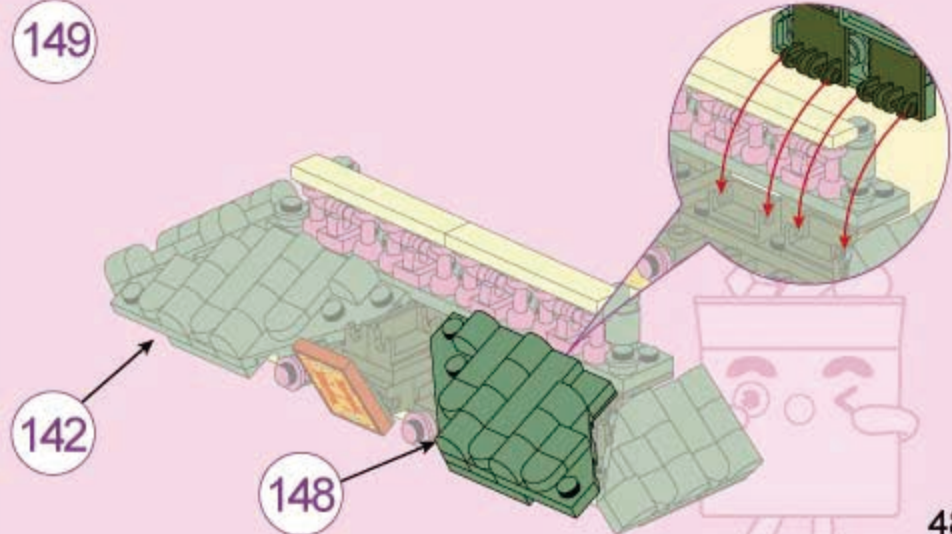

150

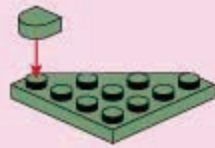

151



152

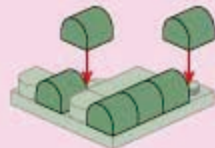

153

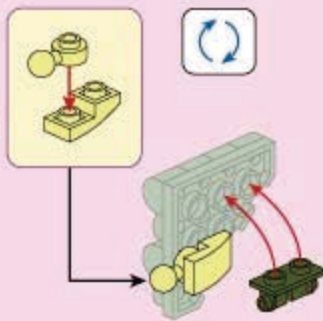

154

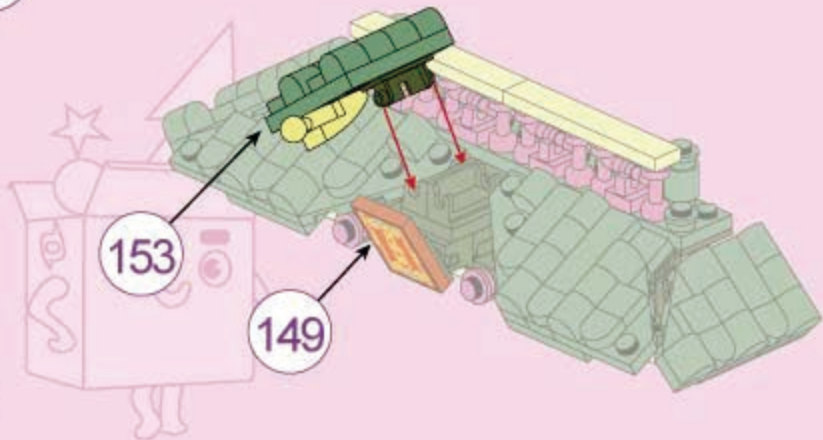

155

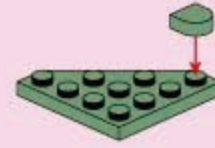

156

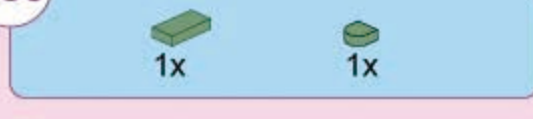

157

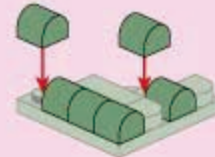
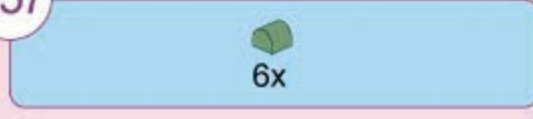

158

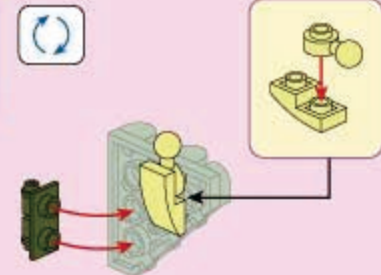

159

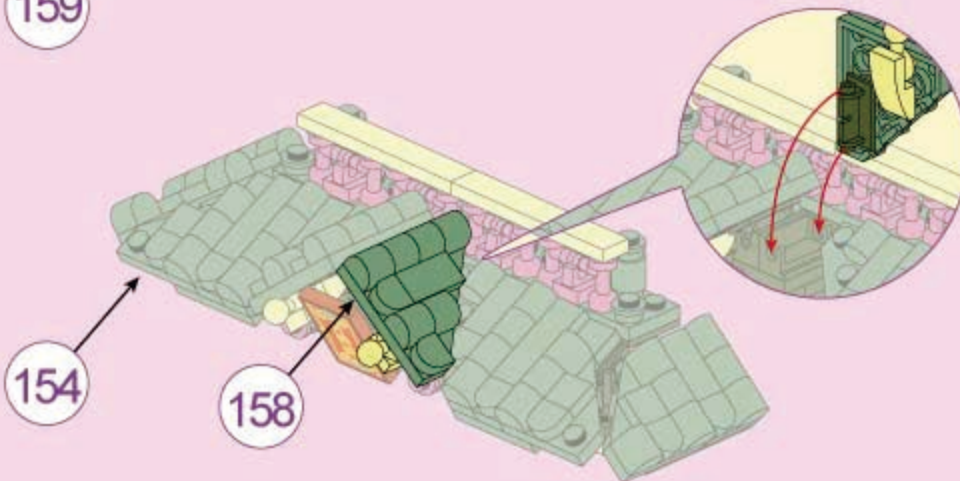

160

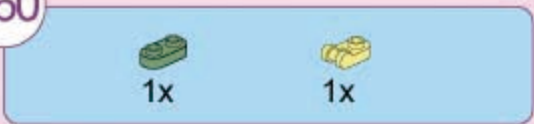

161

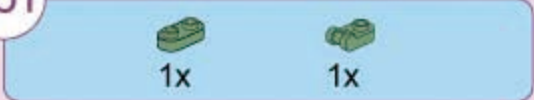

162

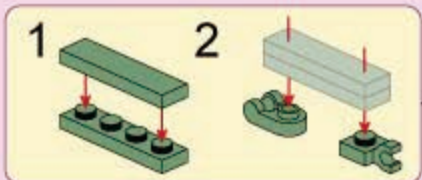

163

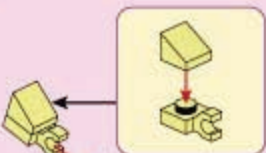
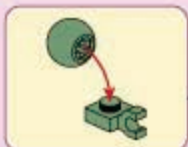

164

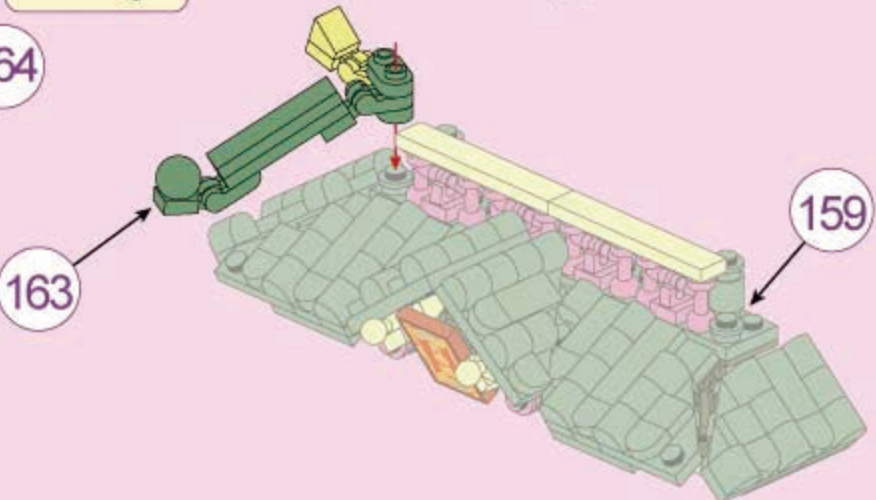

165

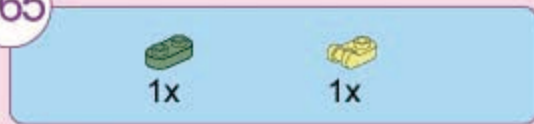

166

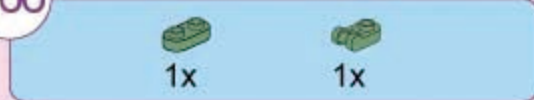

167

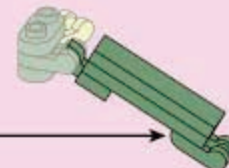
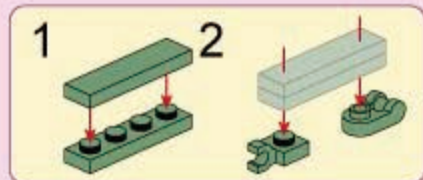
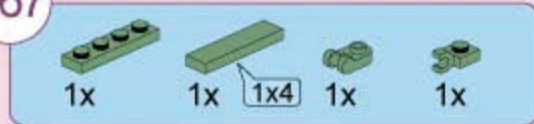

168

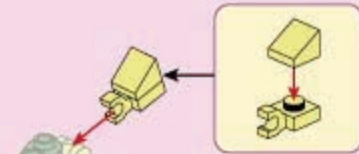
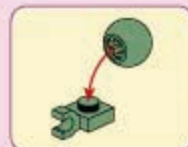

169

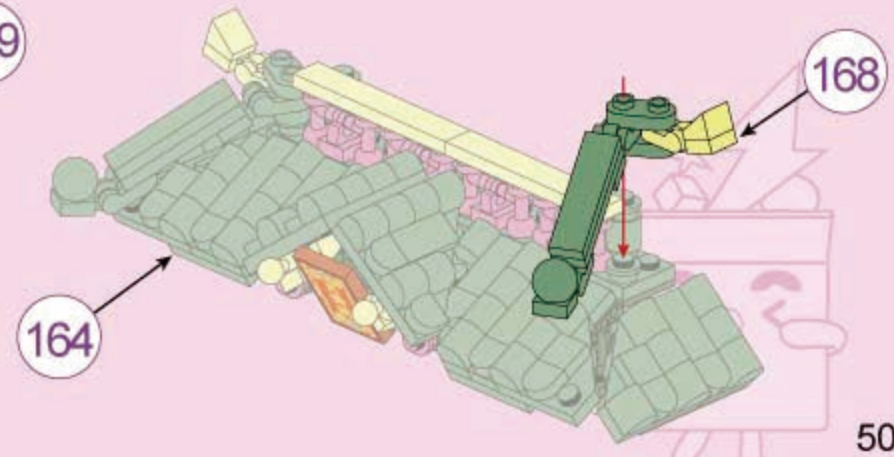



170

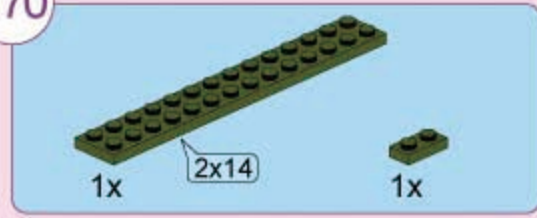

171



172



173

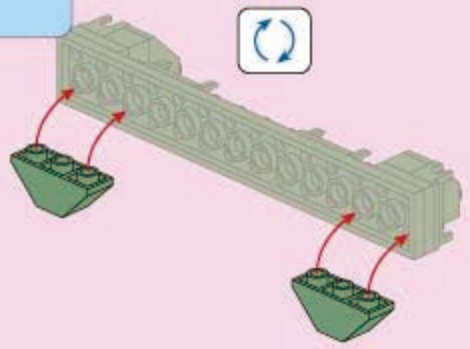
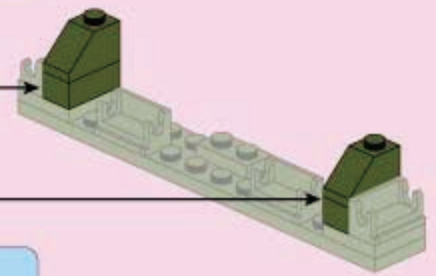
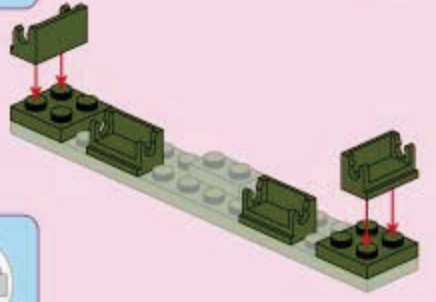
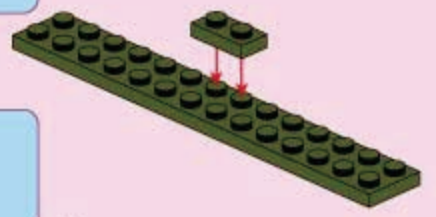

174

2x

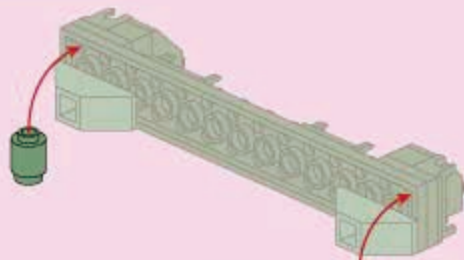

175

174

169

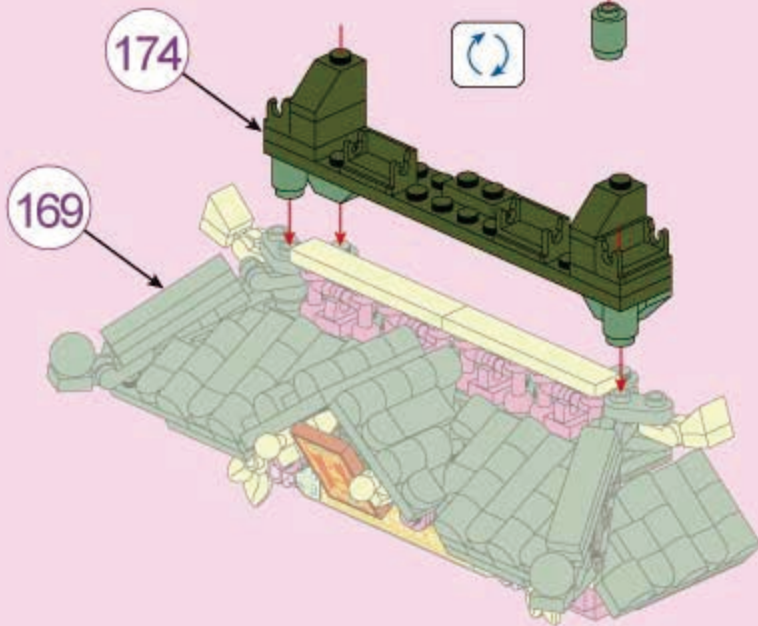

176

1x

1x

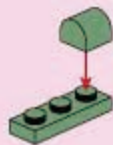

177

2x



178

1x

1x

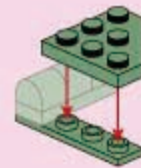

179

1x

2x



180

2x



181

1x



182

181

175

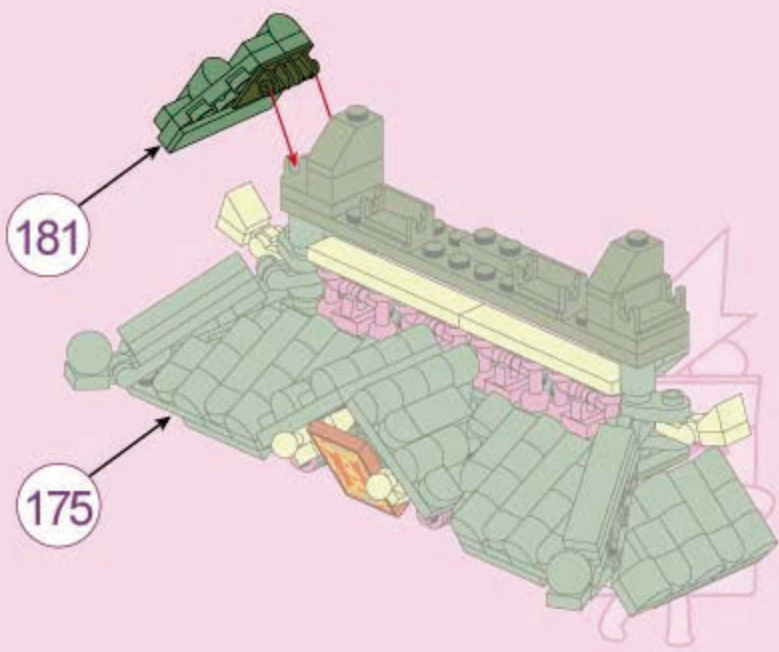

183

1x 1x

184

2x

185

1x 1x

186

1x 2x

187

2x

188

1x

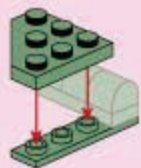
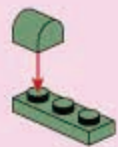

189

188

182

190

1x 4x10 1x 2x3

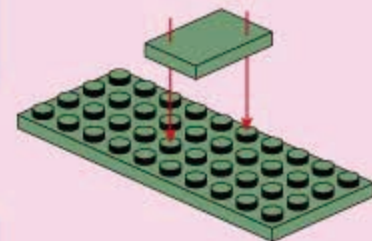

191

4x 1x3 4x 2x

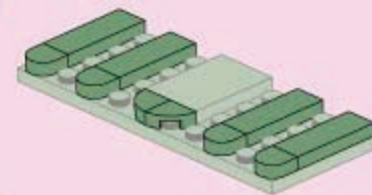

192

16x

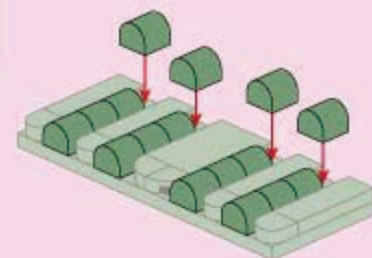

193

1x 1x 2x

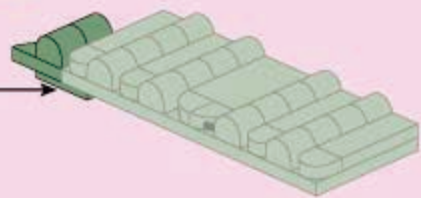
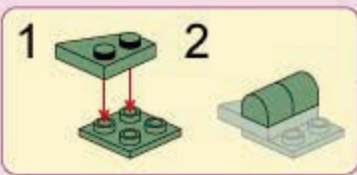

194

1x 1x 2x

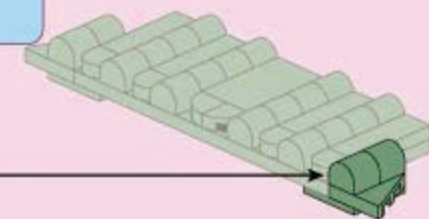
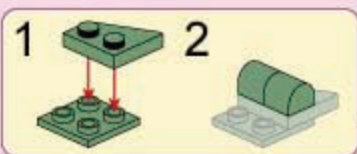

195

2x

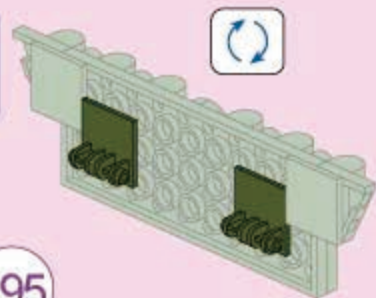

196

195

189



197

2x 1x3 2x 2x 4x 4x

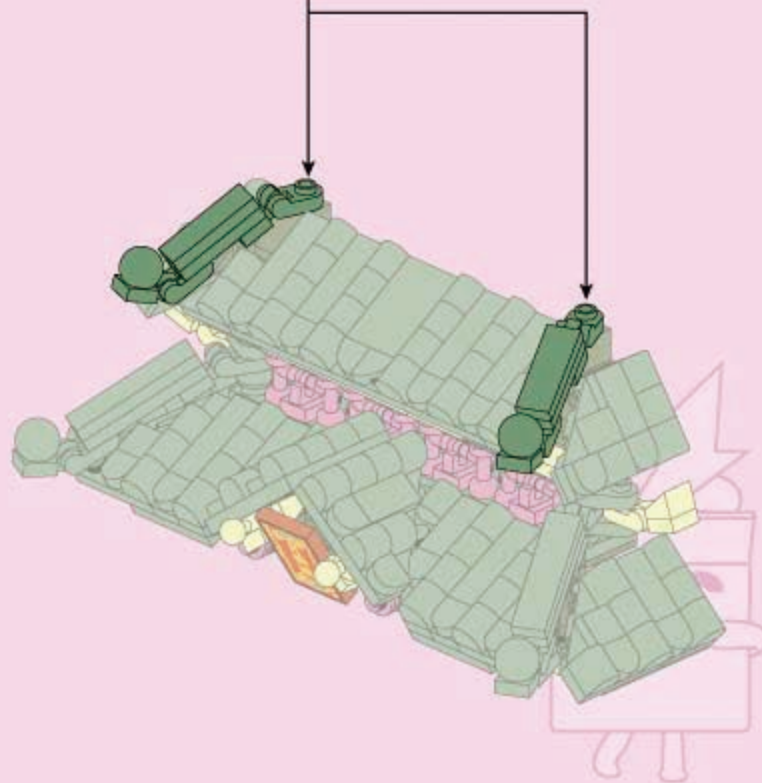
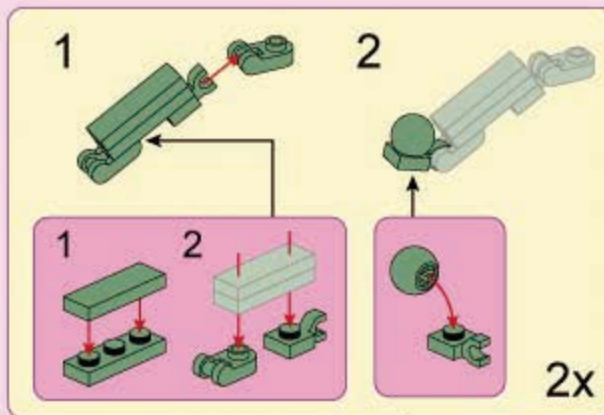

198

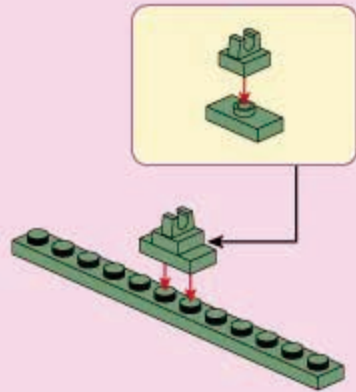
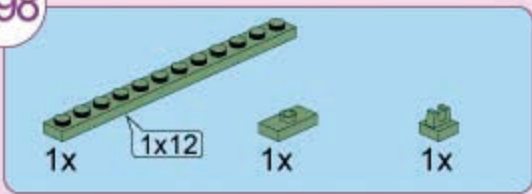

199

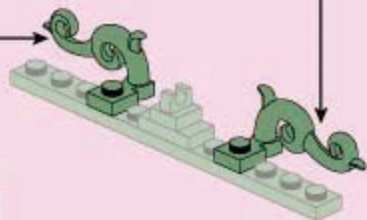
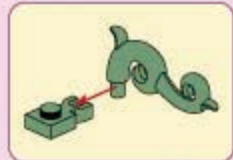

200

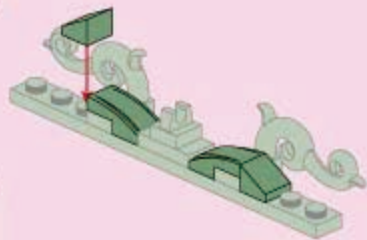
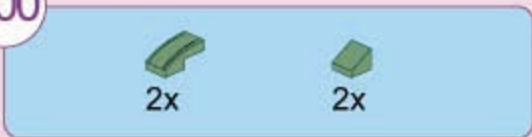

201

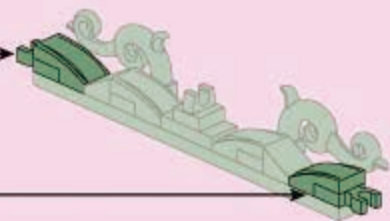
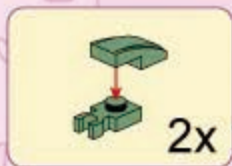

202

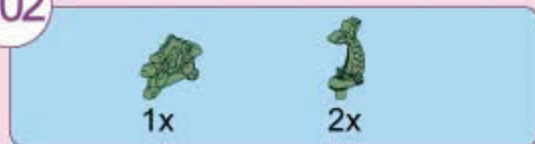

203



204

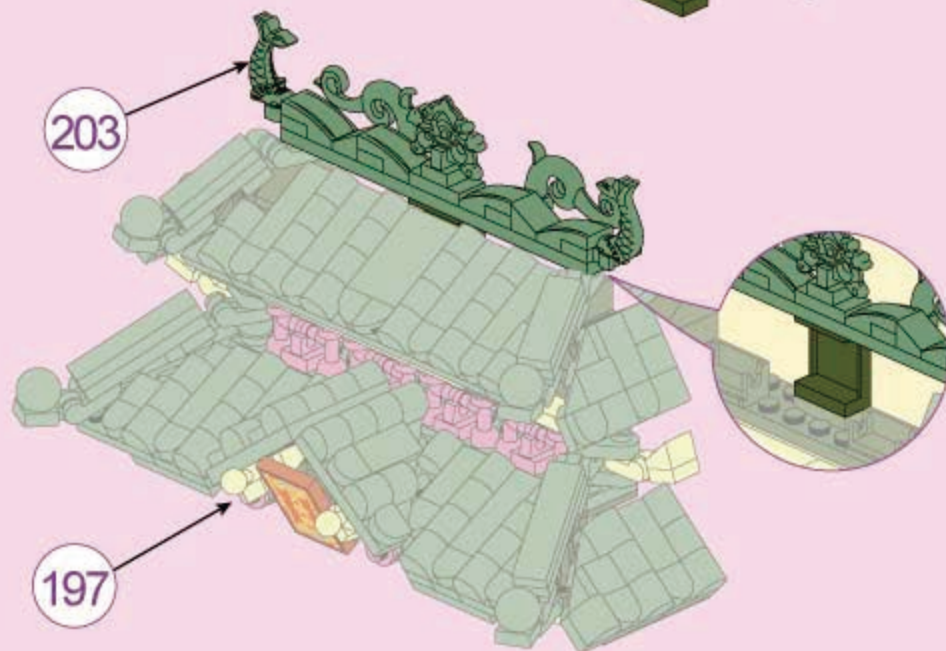





206

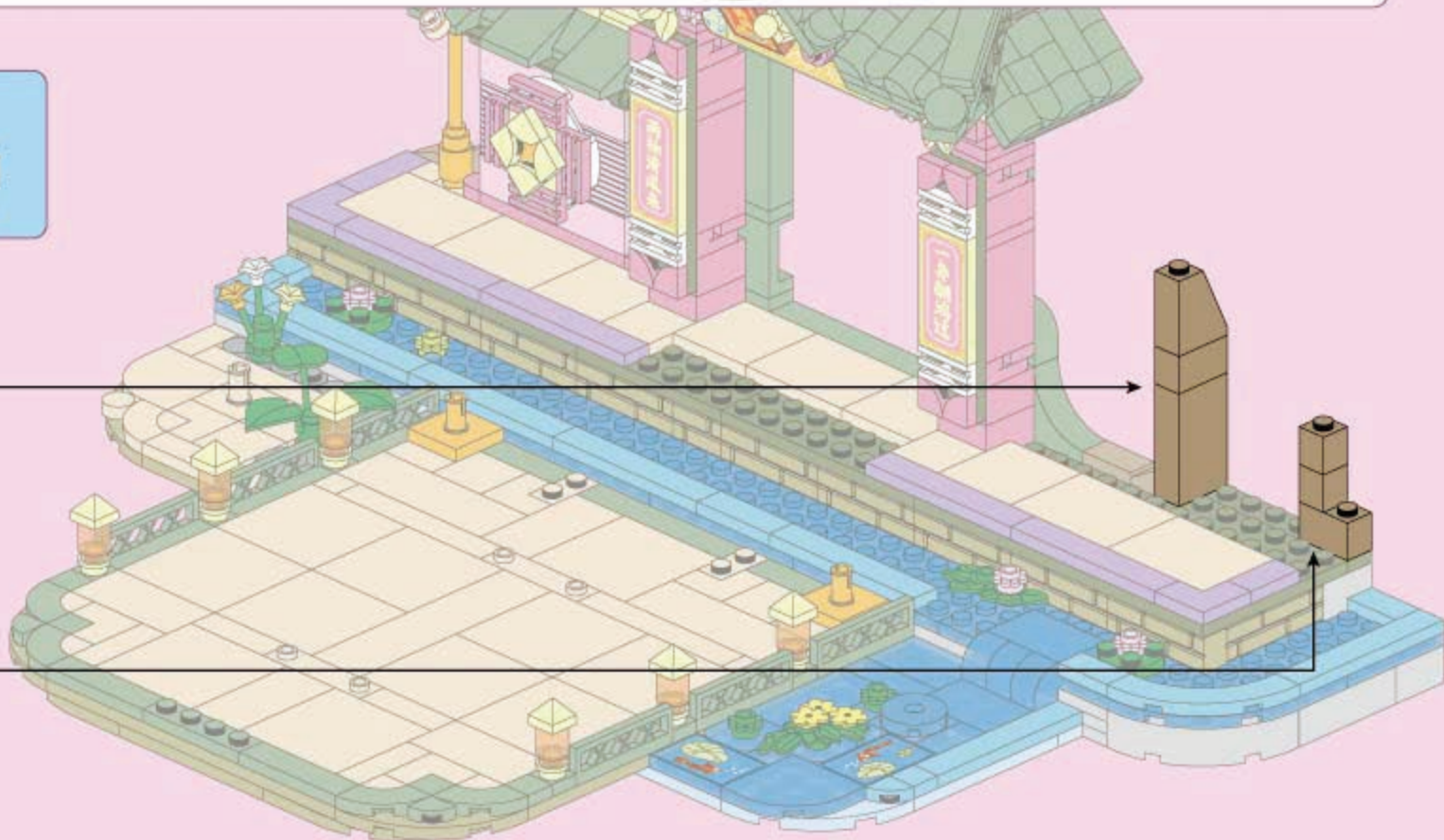
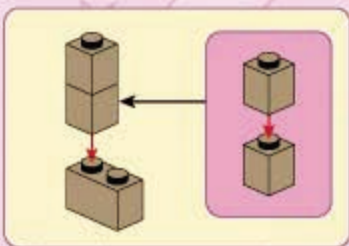
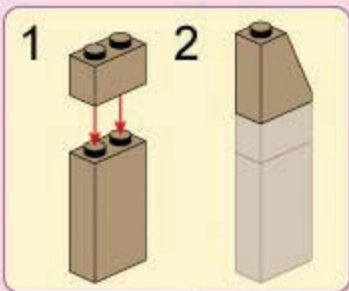
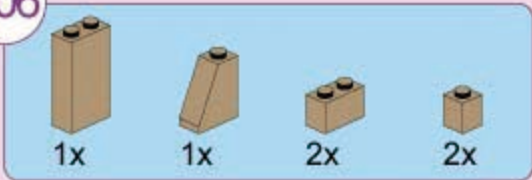

207



1x



1x



1x



1x

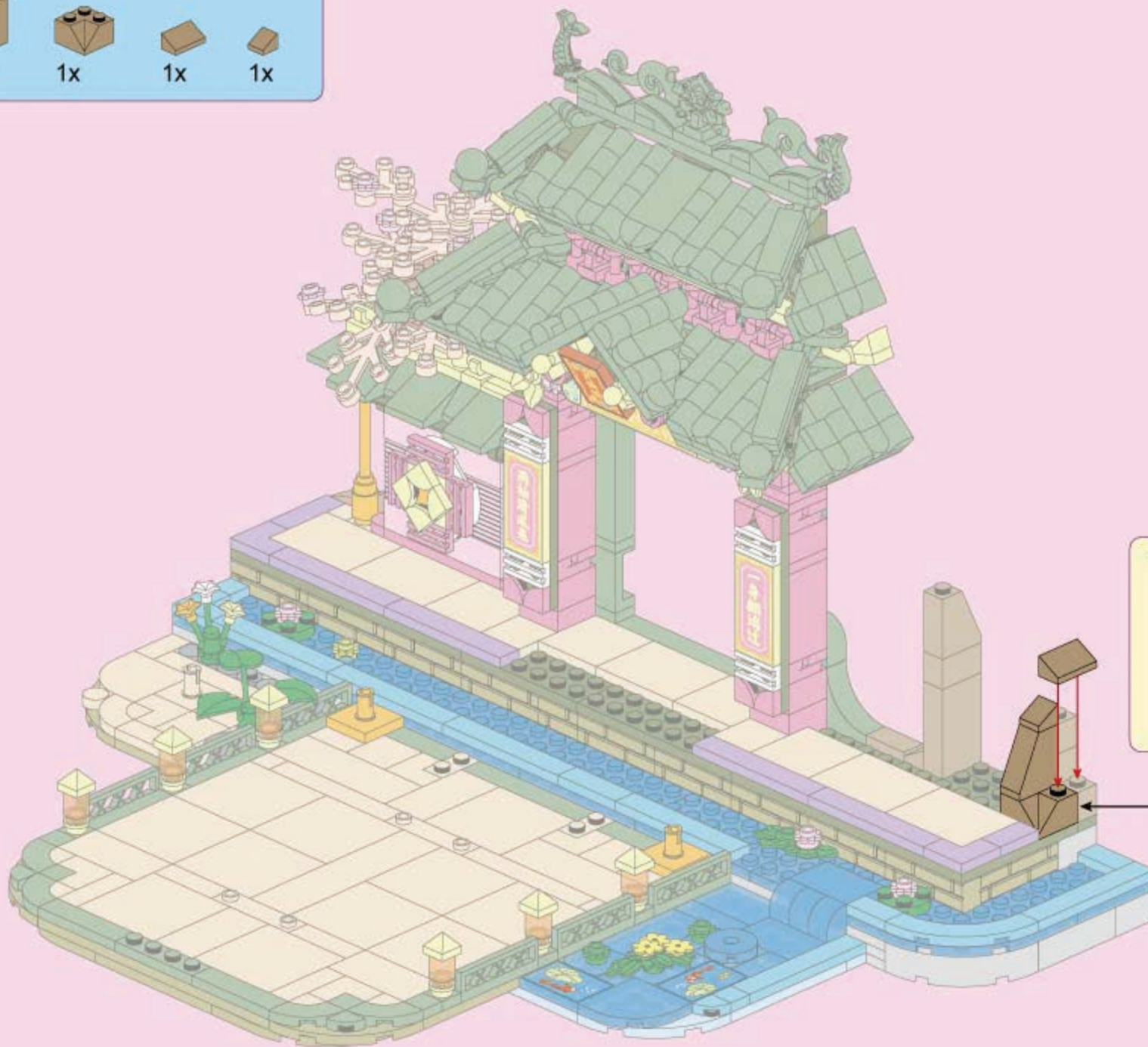

1



2



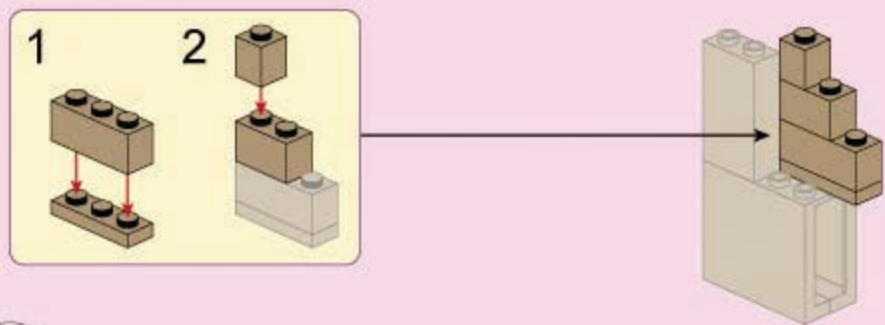
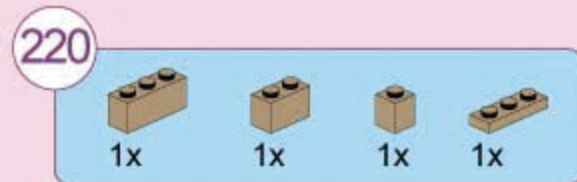
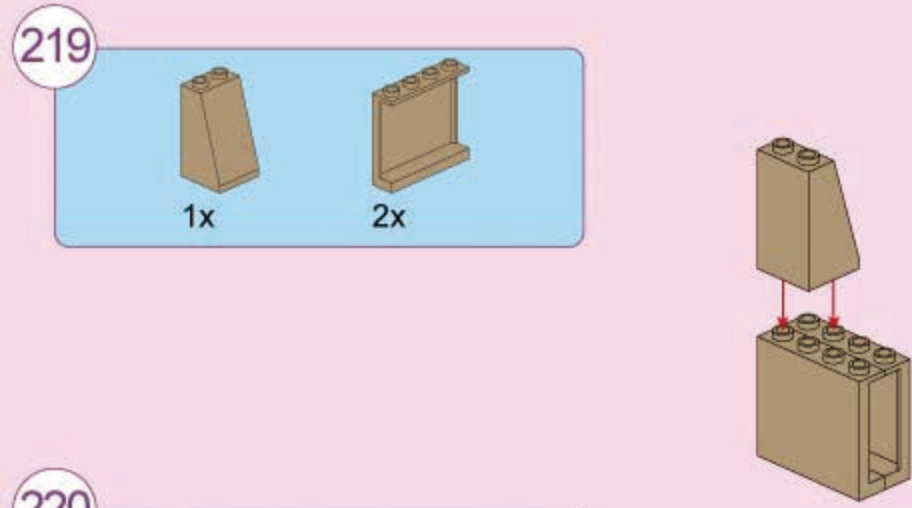
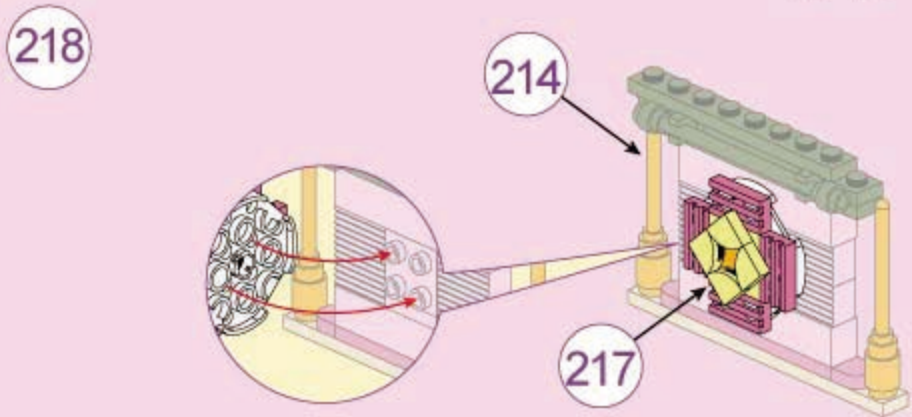
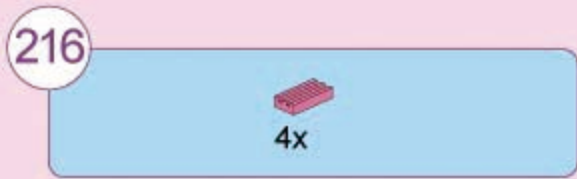
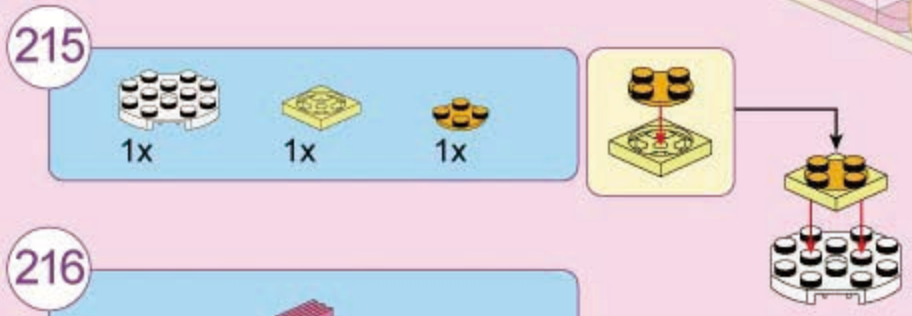
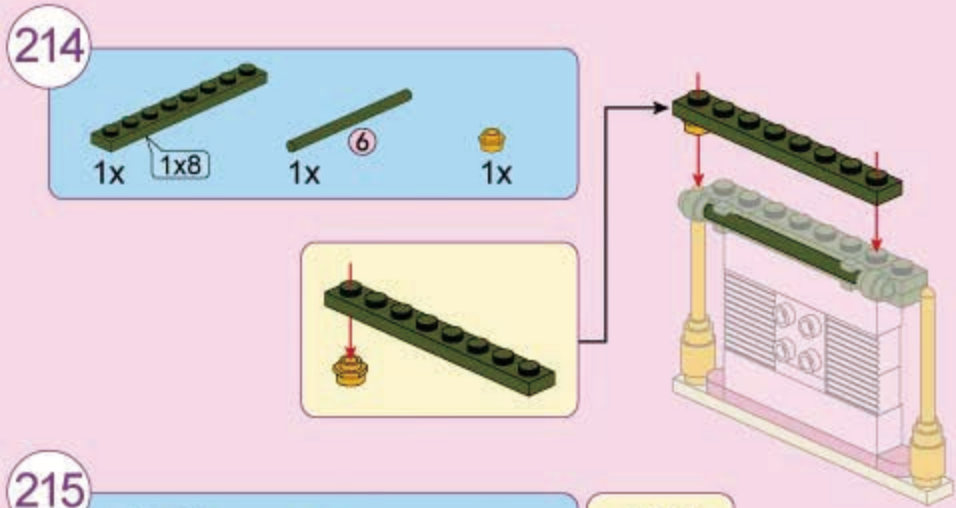

222

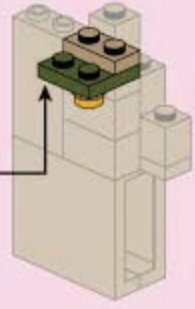
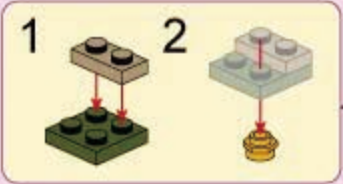

223

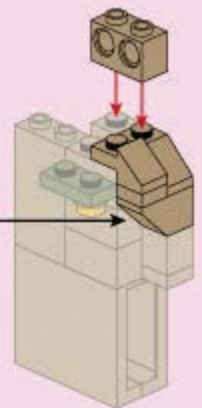
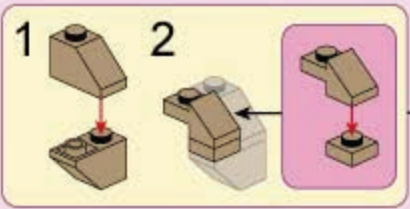
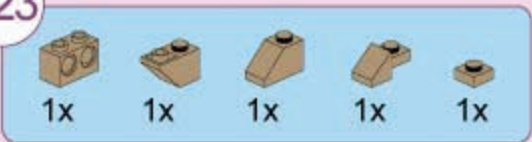

224

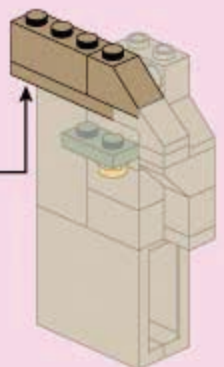
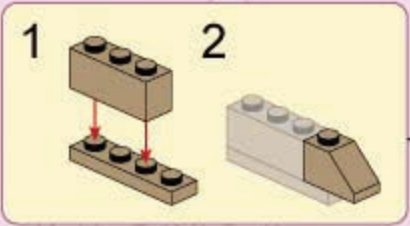

225

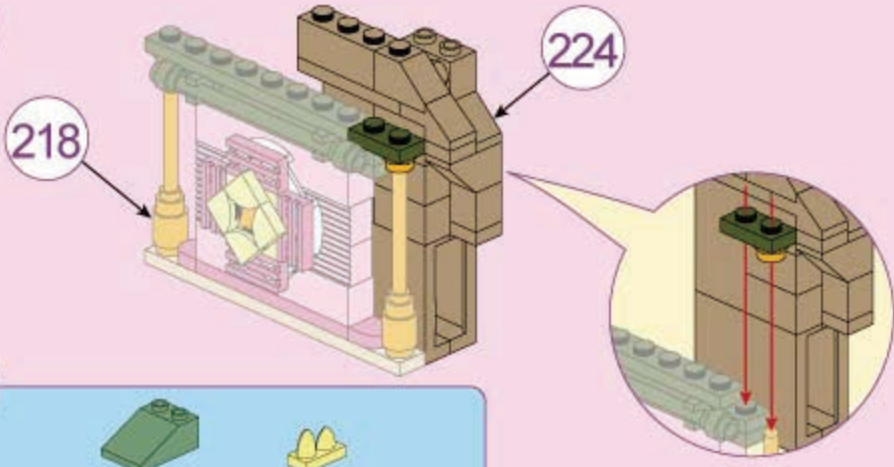

226

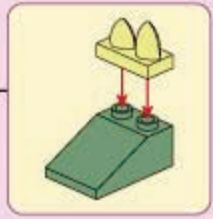
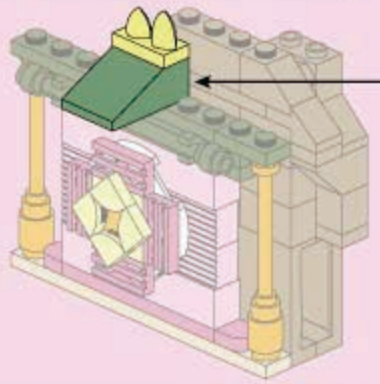

227



228

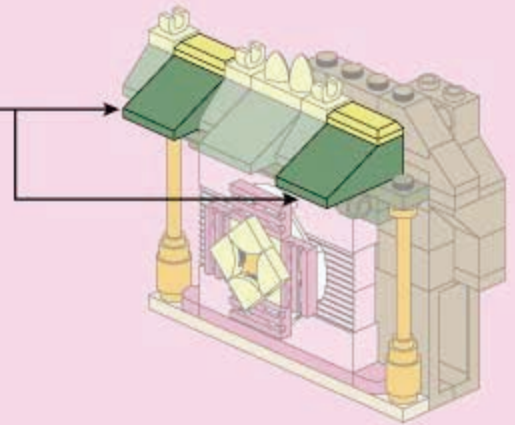
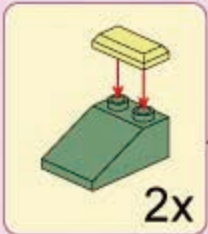

229

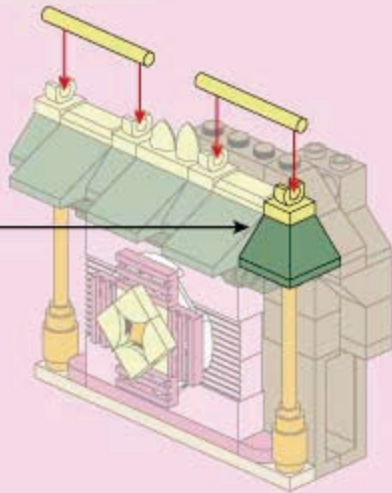

230

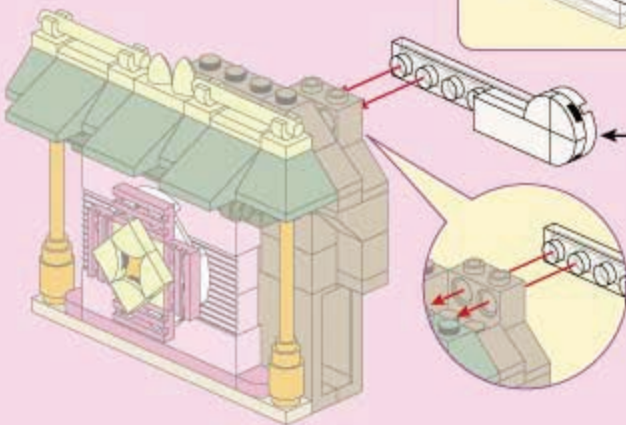
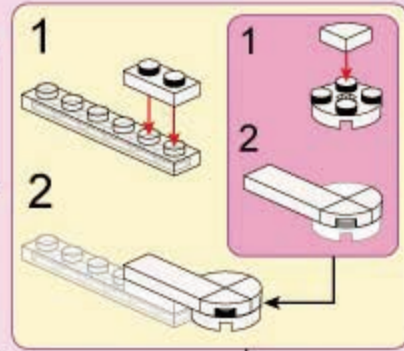

231

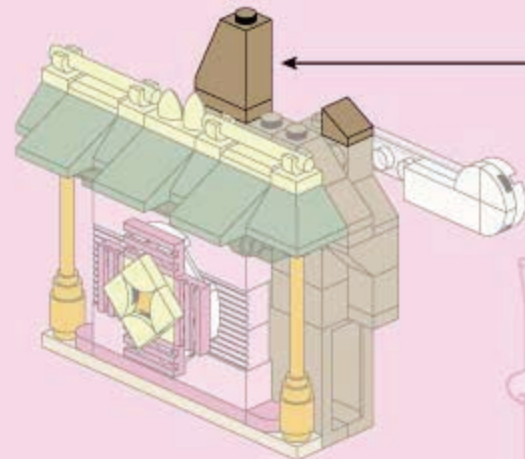
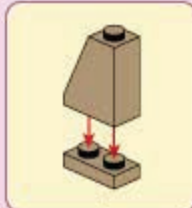

232

- 1x [1x 2-hole grey brick]
- 1x [1x 2-hole grey brick]
- 1x [1x 2-hole grey brick]
- 1x [1x 2-hole grey brick]
- 1x [1x 2-hole grey brick]
- 1x [1x 2-hole grey brick]

1

2

3

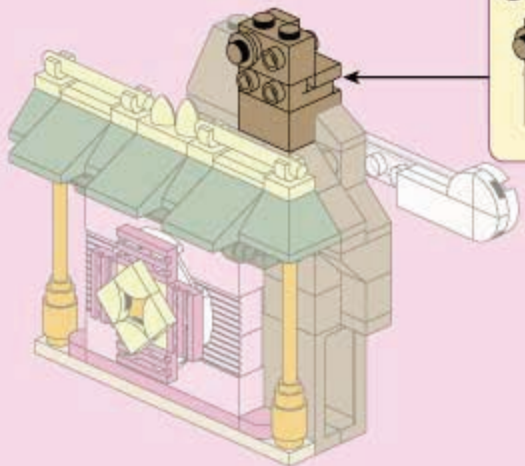

233

- 2x [1x 2-hole grey brick]
- 1x [1x 2-hole grey brick]

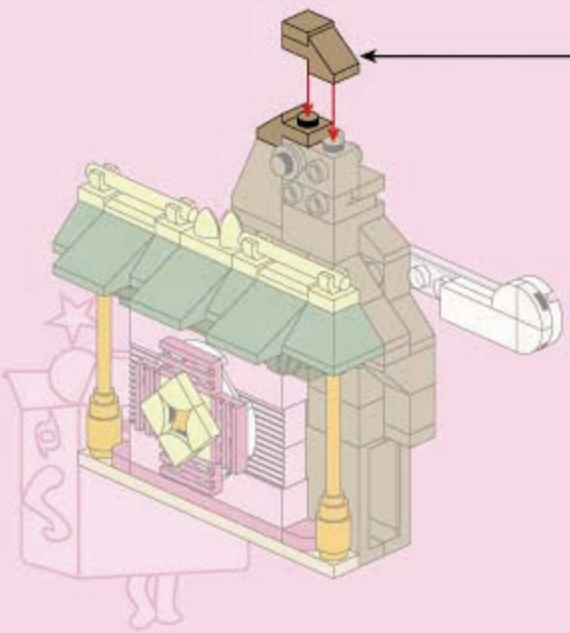

234

- 1x [1x 2-hole yellow brick]
- 1x [1x 2-hole yellow brick]
- 1x [1x 2-hole yellow brick]
- 2x [1x 2-hole yellow brick]

1

2

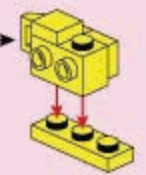

235

- 2x [1x 2-hole yellow brick]
- 1x [1x 2-hole yellow brick]

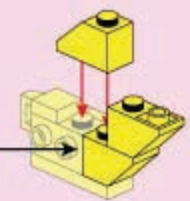

236

- 2x [1x 2-hole yellow brick]

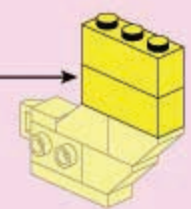

237

- 1x [1x 2-hole yellow brick]
- 2x [1x 2-hole yellow brick]
- 1x [1x 2-hole yellow brick]
- 1x [1x 2-hole yellow brick]

1

2

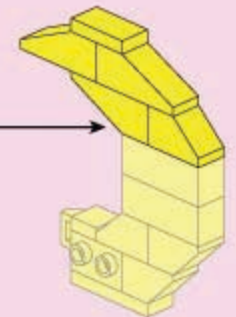

238

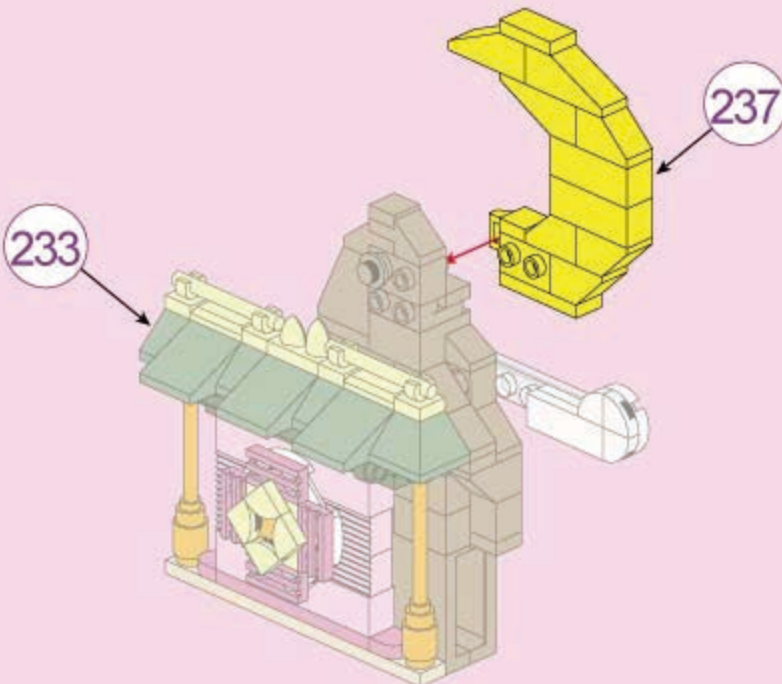

239

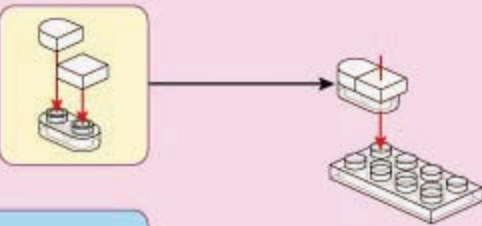

240

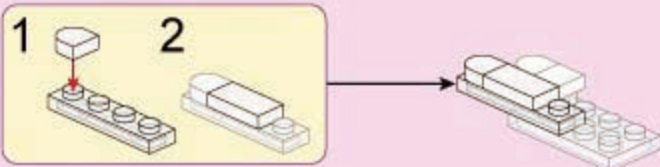

241

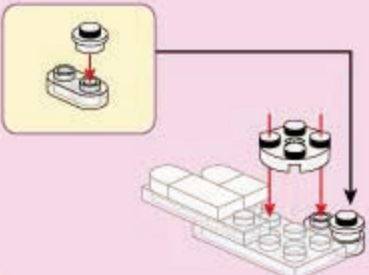

242



243

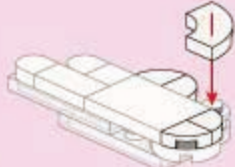

244

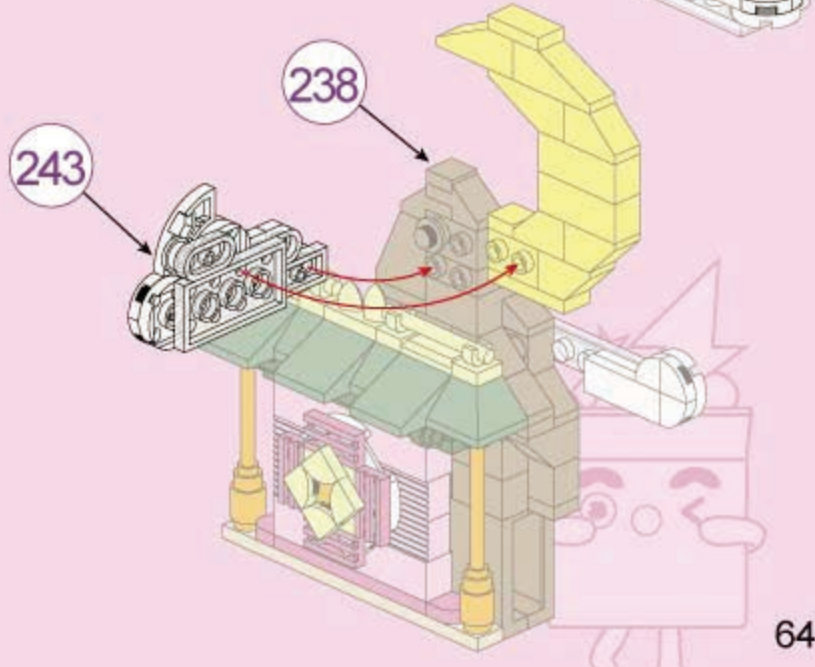



207

244



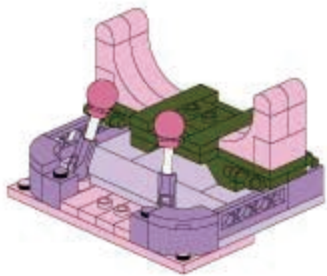

246

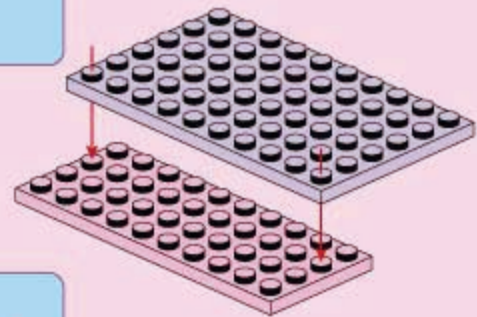
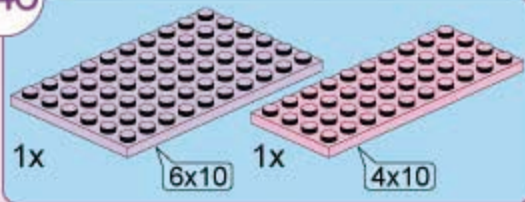

247

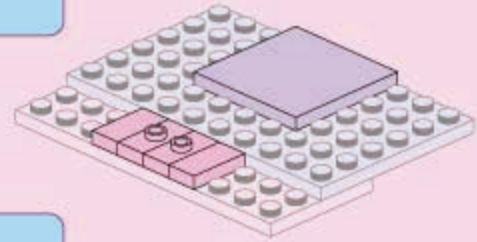
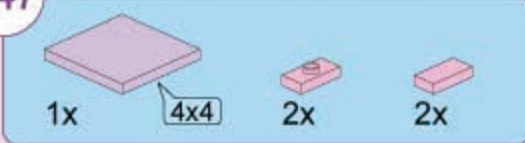

248

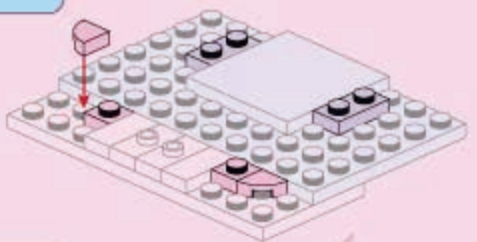

249

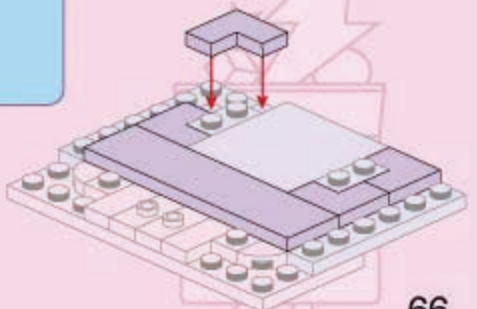
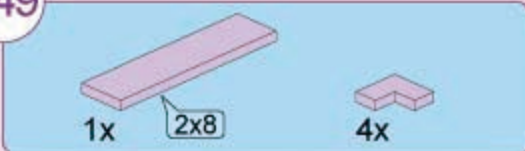

250

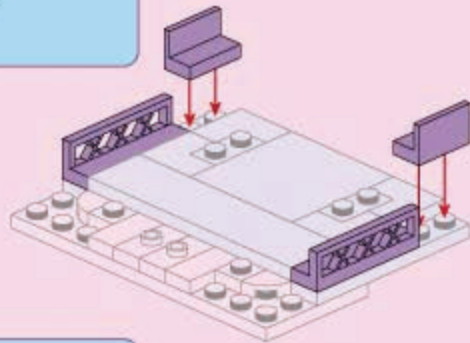

251

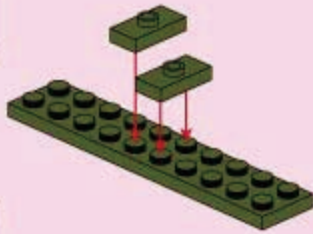
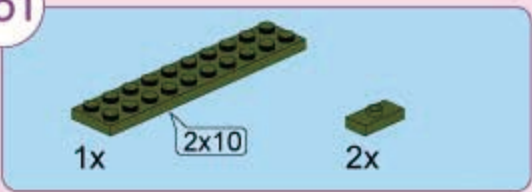

252

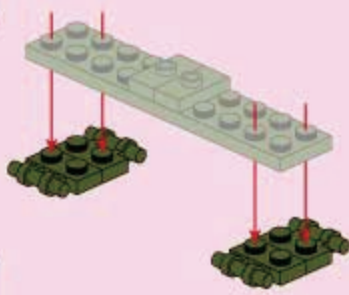

253

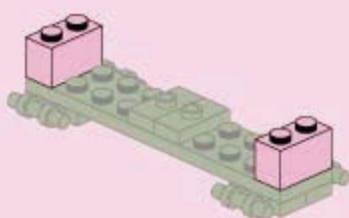

254

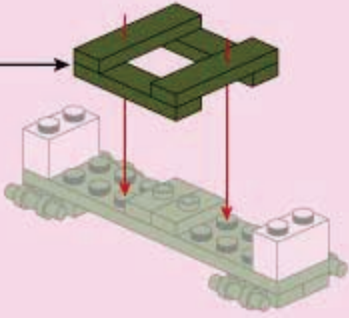
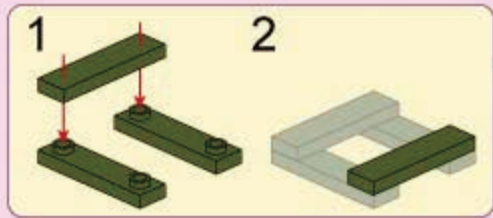

255

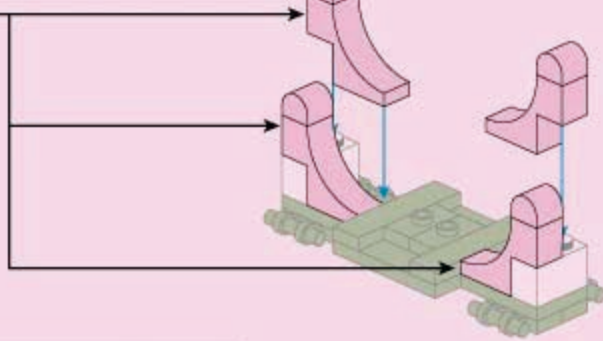
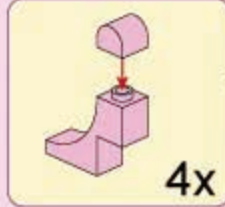

256

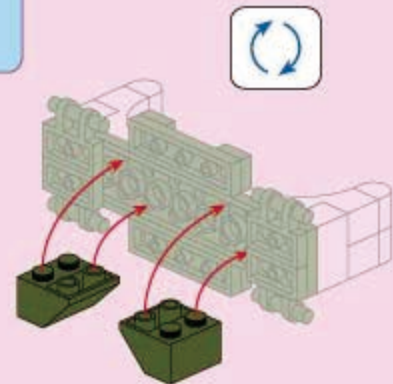

257

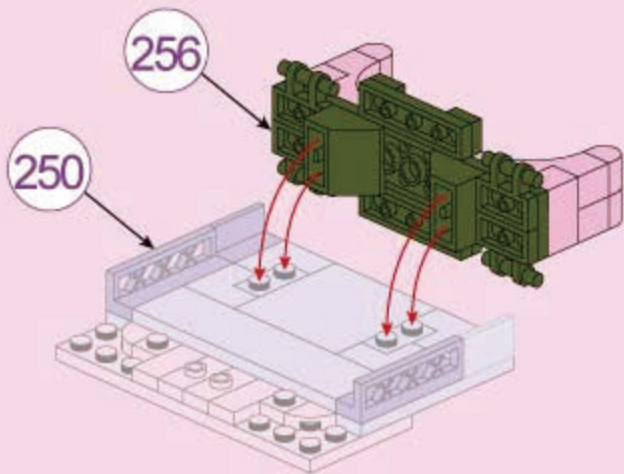

258

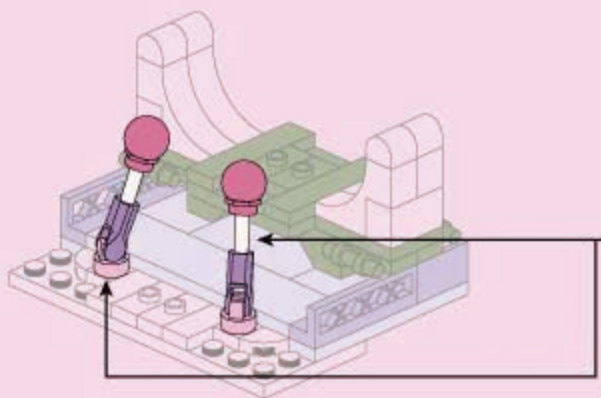

259

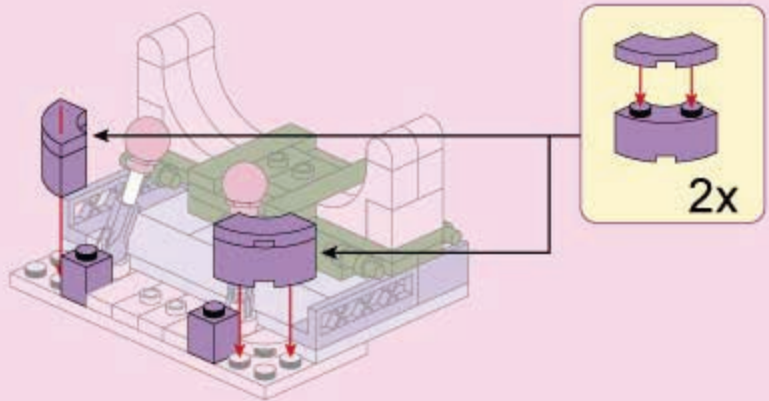

260

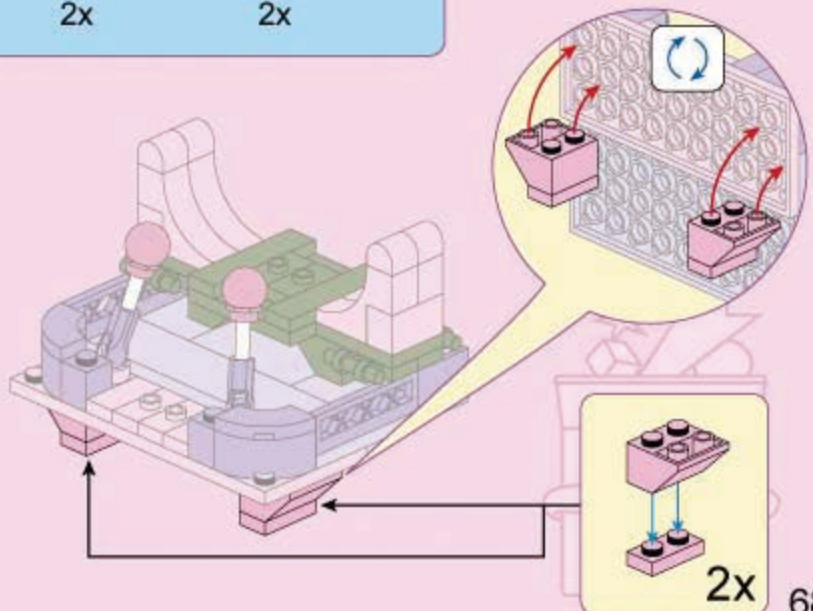



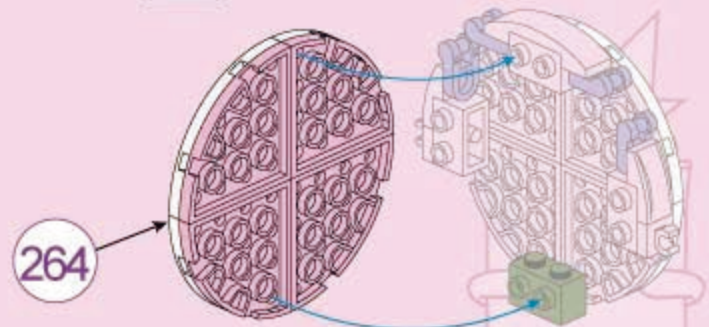
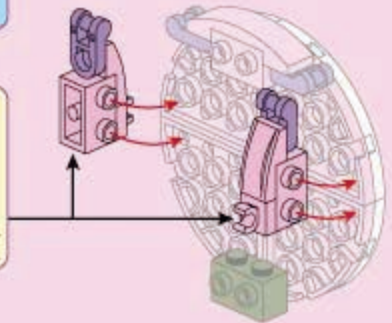
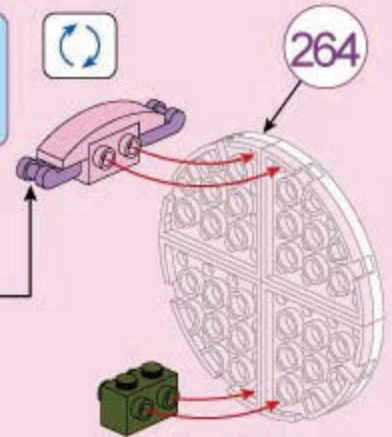
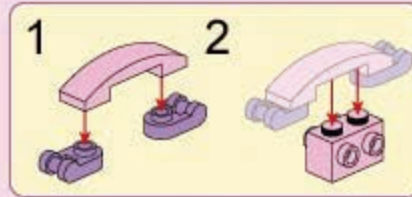
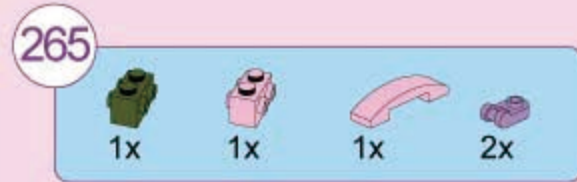
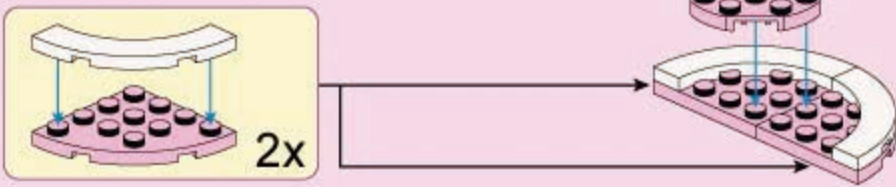
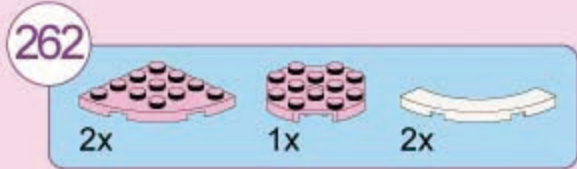
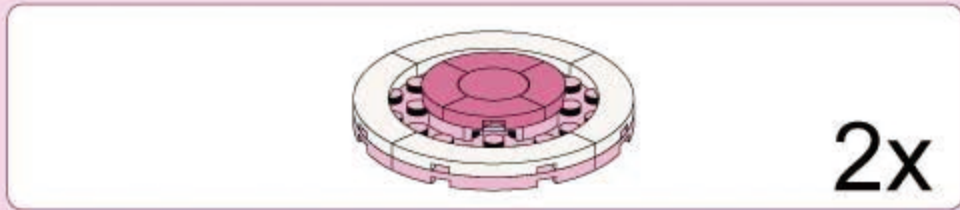

268

2x

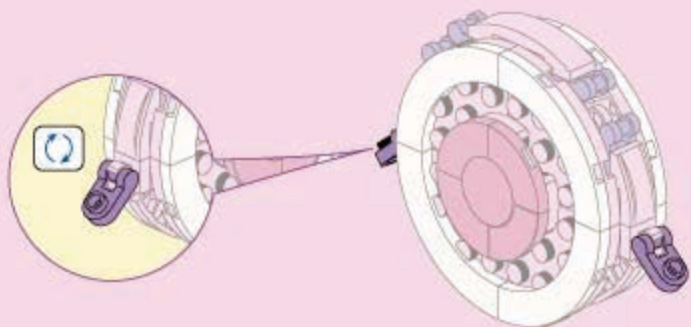

269

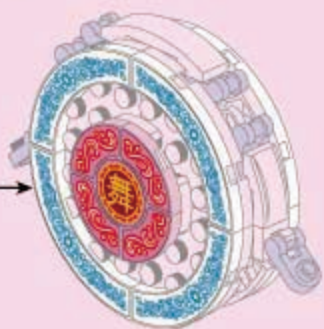

270





271

1x 1x 1x

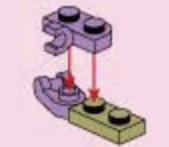

272

1x 1x

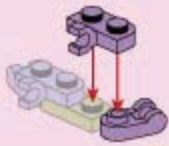

273

1x 2x

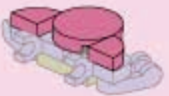

274

1x 1x 1x

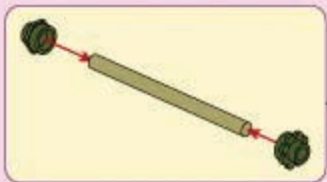

275

1x 1x 1x 2x 1x

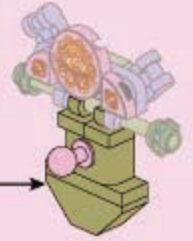

276

2x 4x 2x 2x

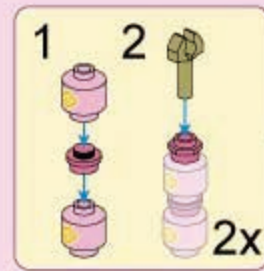

277

1x 1x 1x





279

- 2x
- 2x
- 2x
- 2x
- 2x
- 2x
- 2x
- 2x
- 2x



- -
 -
- 2x



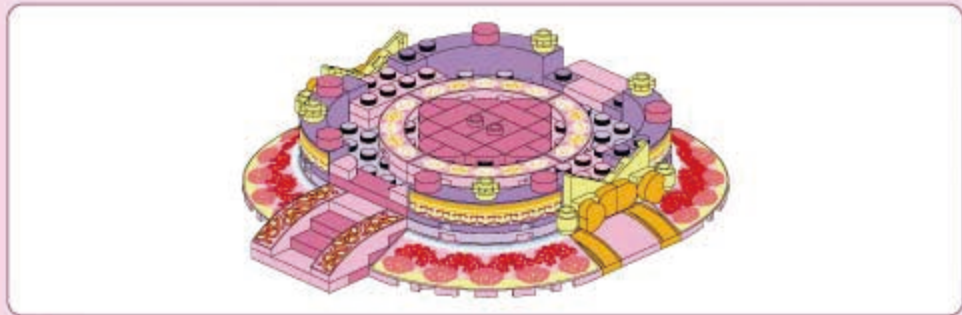

280

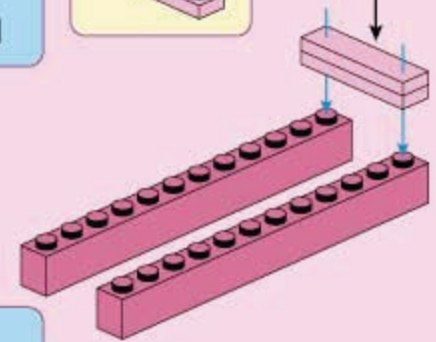
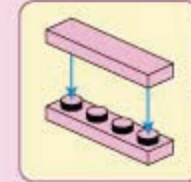
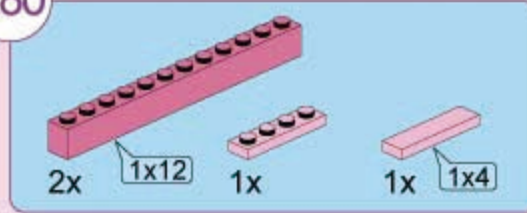

281

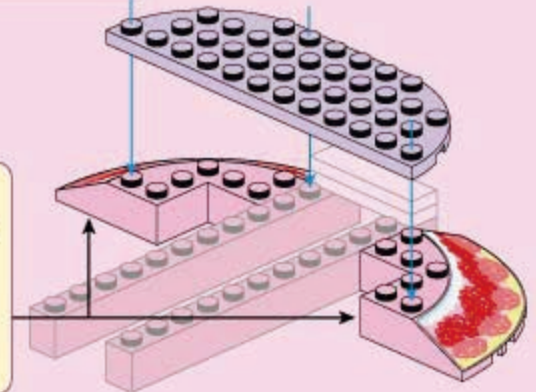
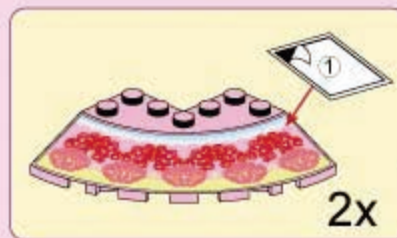
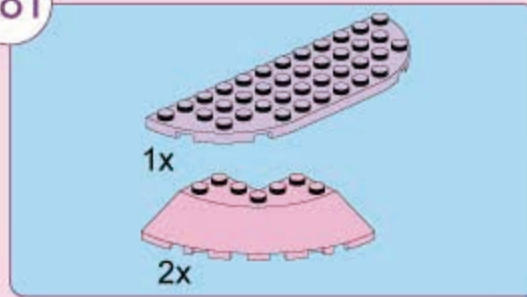

282

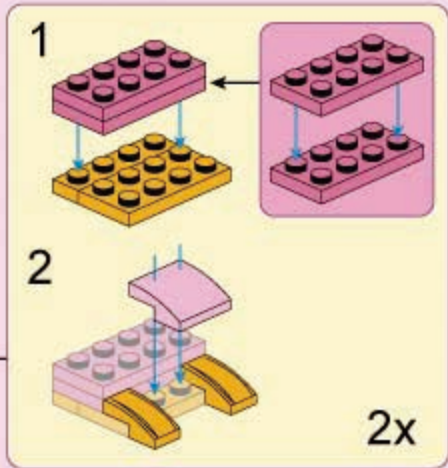
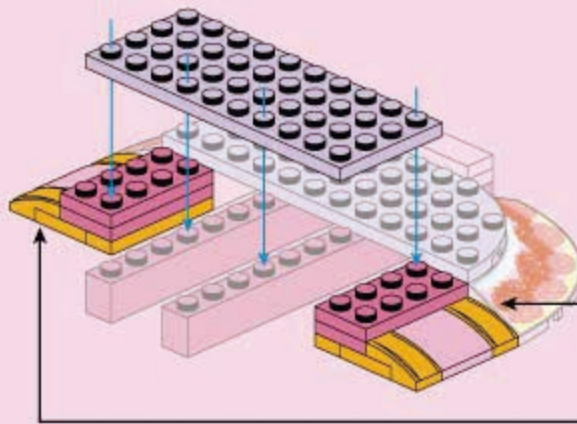
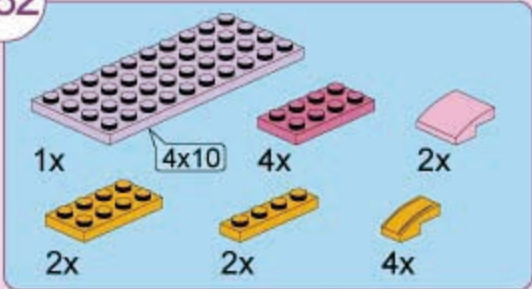

283

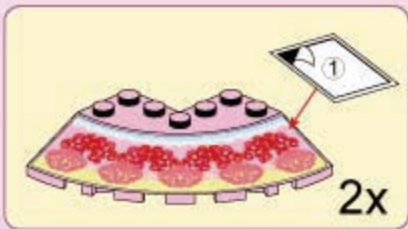
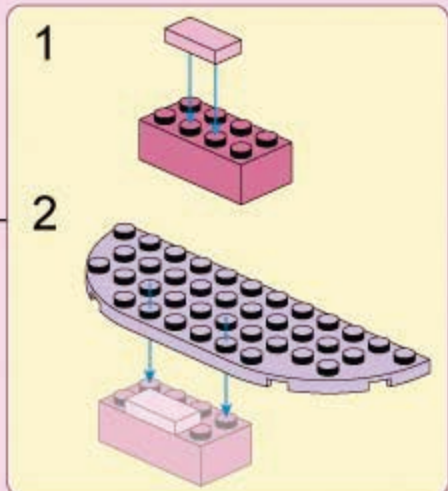
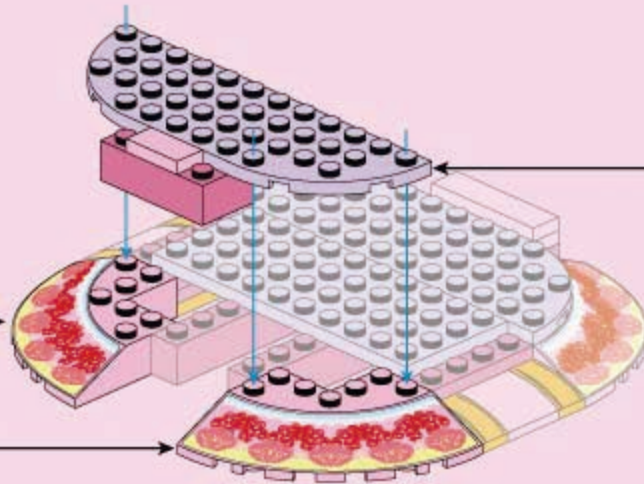
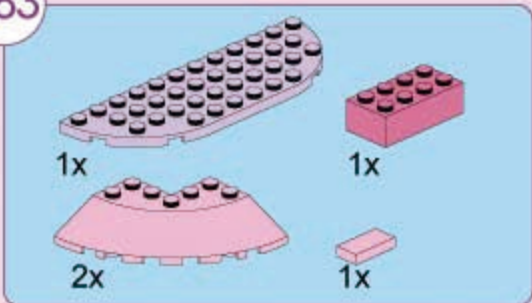

284

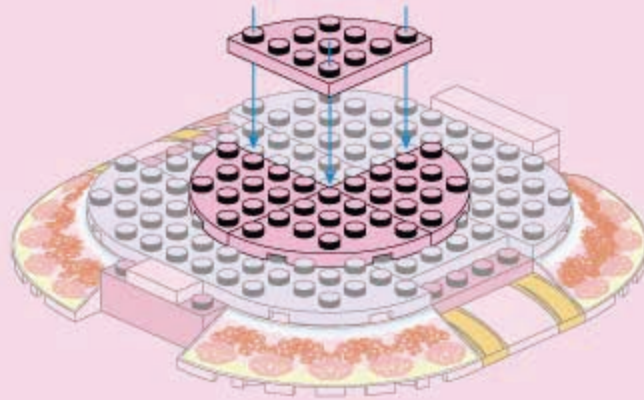

285

2x

4x

1x

2x

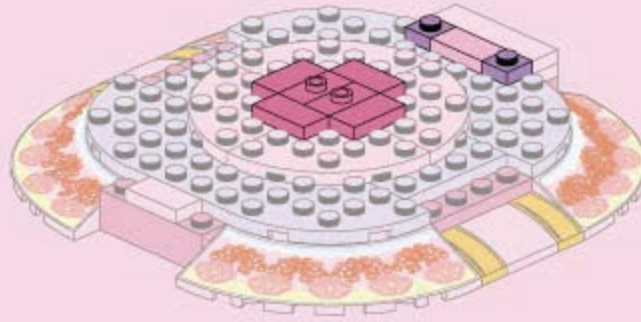

286

12x

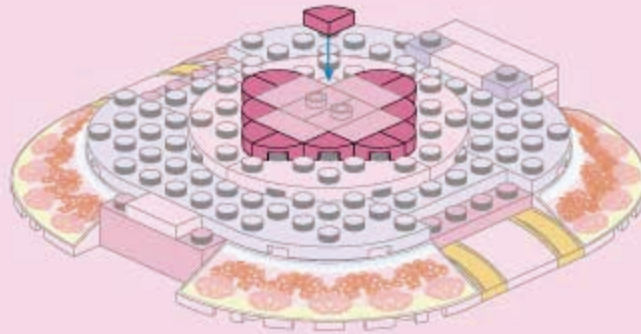

287

4x

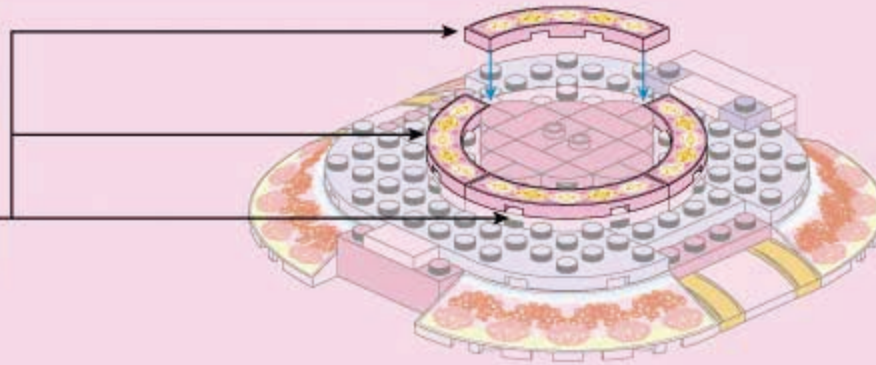
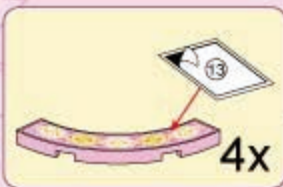

288

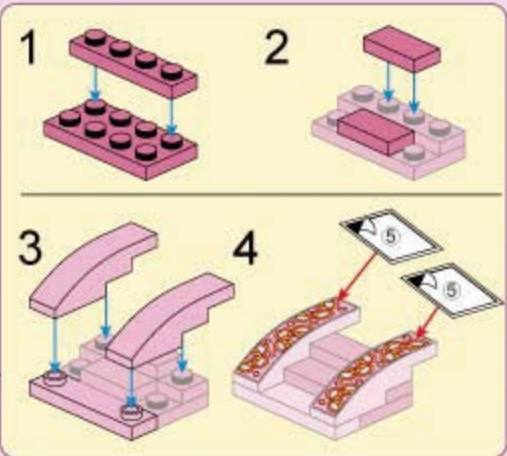
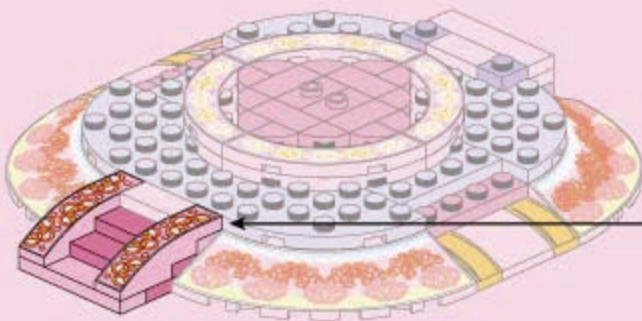
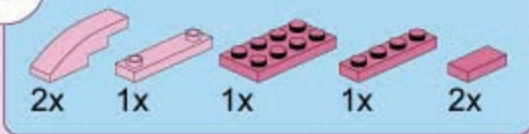

289

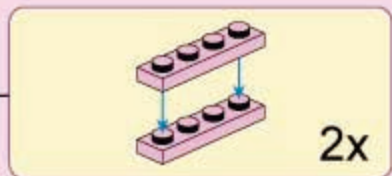
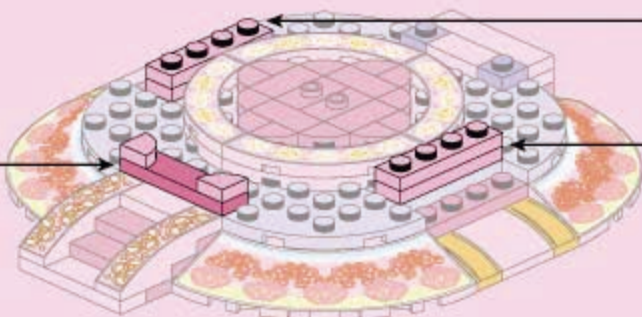
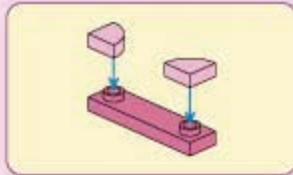
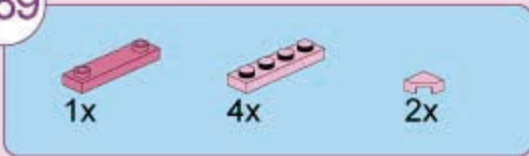

290

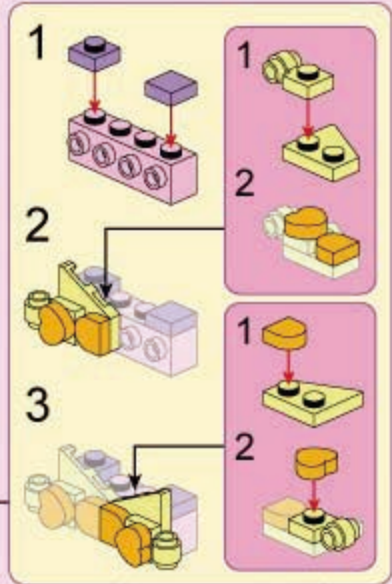
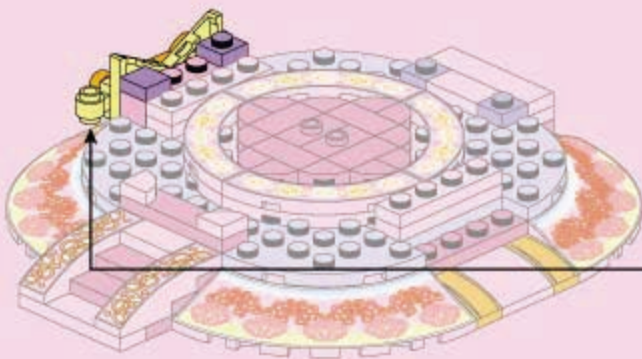
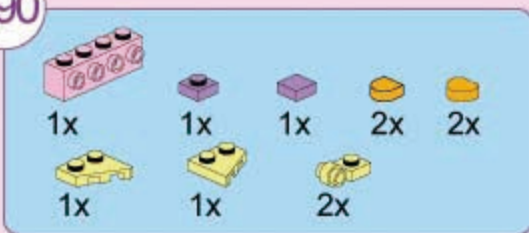

291



4x

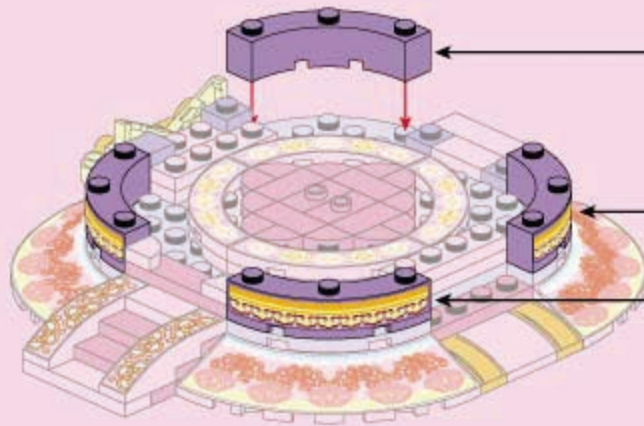
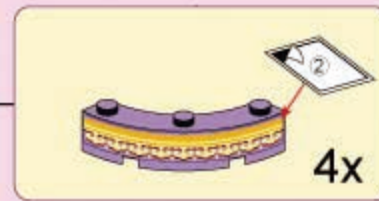

292



1x



1x



1x



2x



2x



1x



1x



2x

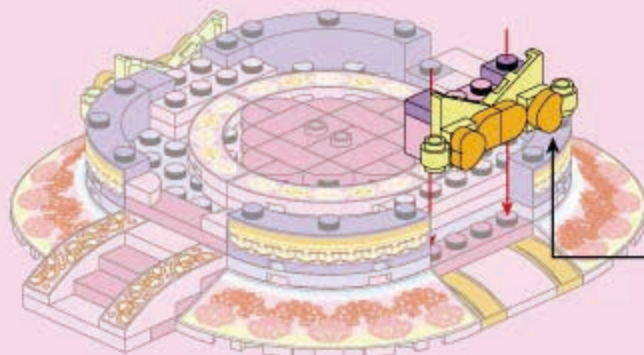
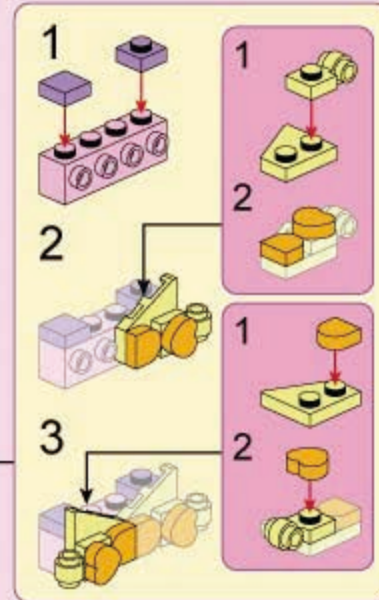

293



4x



6x

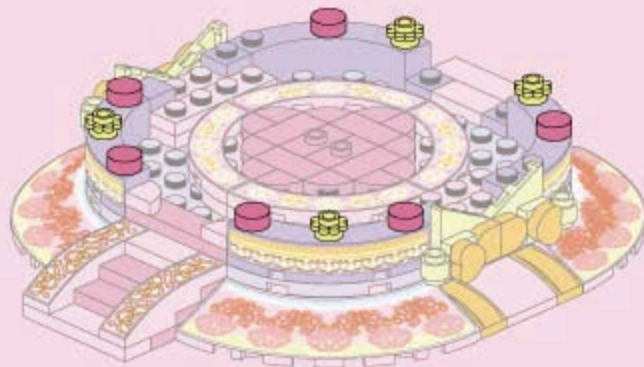





2x



2x



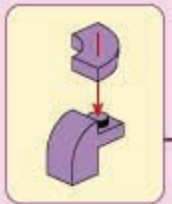

2x



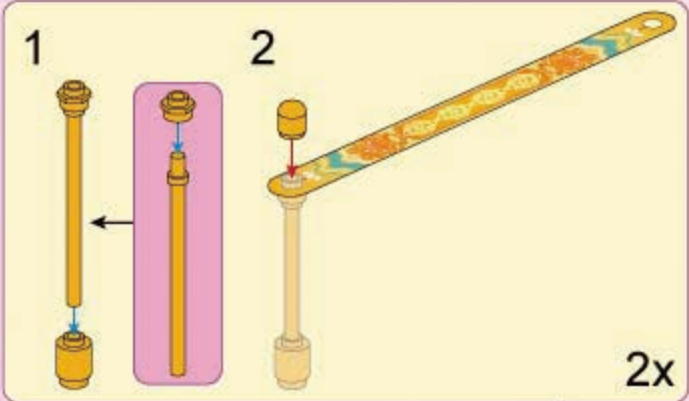

296



297

4x  2x 

 2x



| | | |
|----|----|----|
| | | |
| 2x | 2x | 4x |
| | | |
| 4x | 2x | 4x |





- 1
- 2
- 3
- 4
- 5

2x





299

1x  1x 



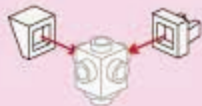

300

1x  1x 



301

1x  1x 



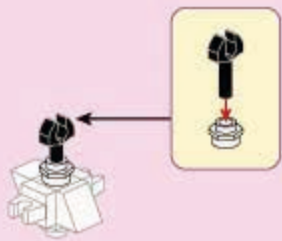

302

1x  1x 



303

1x  1x  1x 

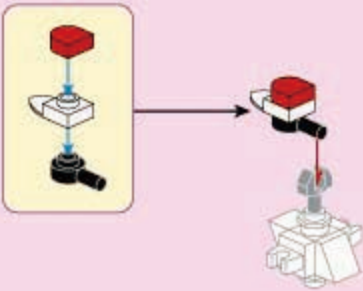

304

2x 

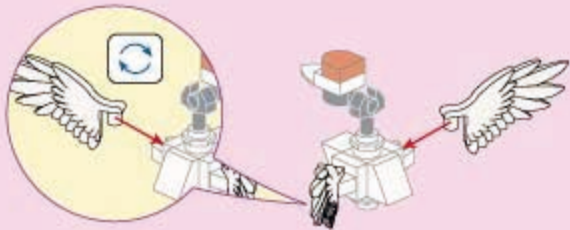

305

1x  ³







33018

九州 芳华录

琴棋书画

收集

九州芳华录系列

品味 **琴** **棋** **书** **画**

成为诗意女孩



33018
花月水舞楼

舞

绣

33017
四艺阁阁



33016-1 初春抚琴



33016-2 仲夏弈棋



33016-3 晚秋引书



33016-4 隆冬作画