



MODEL POWER

LEGO

52004

年龄: 8+

片数: 528



扫码关注公众号，
输入“52004”
观看玩法视频。

功能
玩法



10 安全泡沫弹

安全气动装置

图片仅供参考，请以实物为准。

95式步枪

中程武器，战略突击

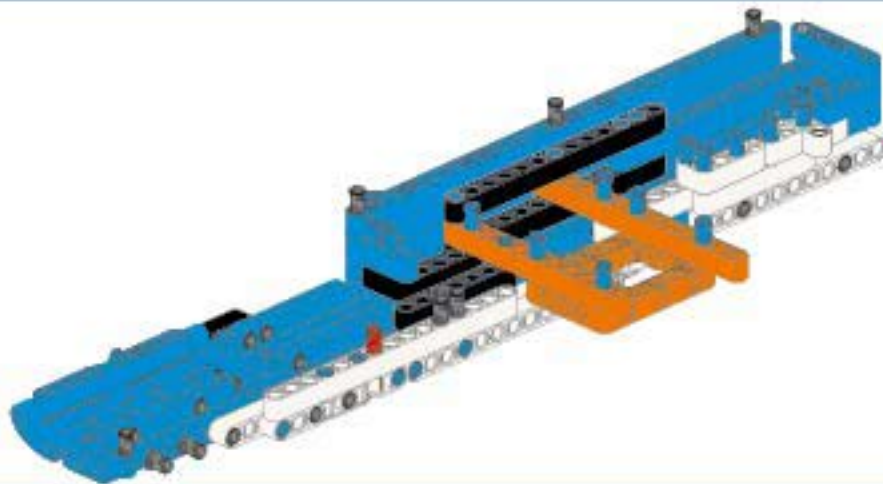

拆件器使用方法，仅为示例

Usage of Brick Separator, Just for the sample

1



2



3



4

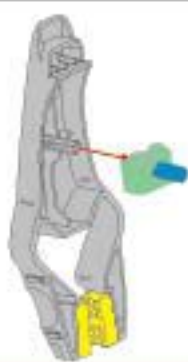

1



1x

3x

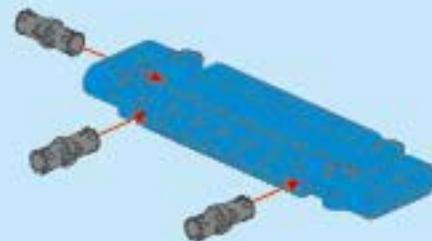

2



1x

1x

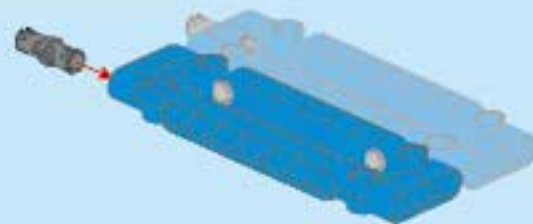

3

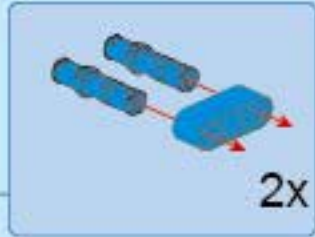
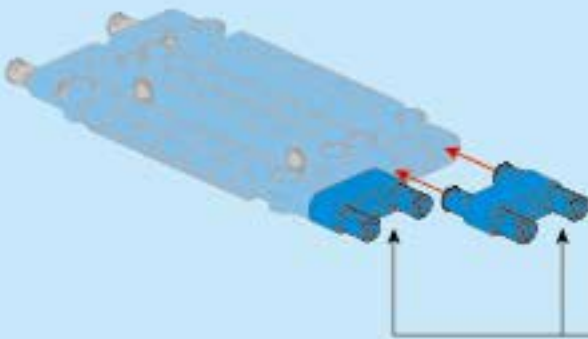

4

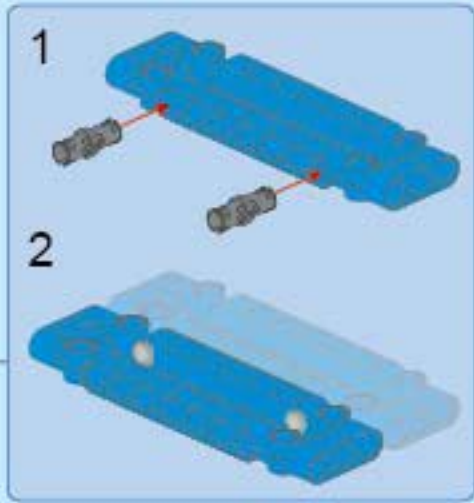
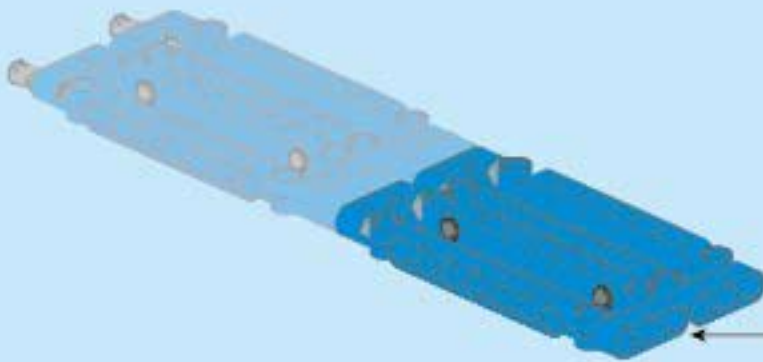

5

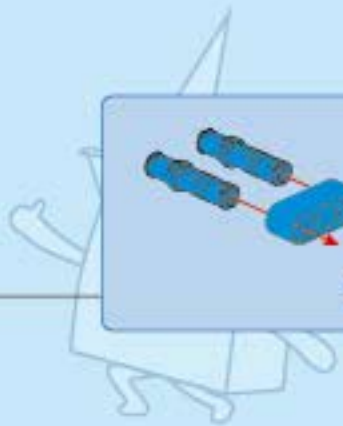
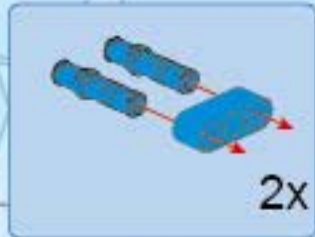
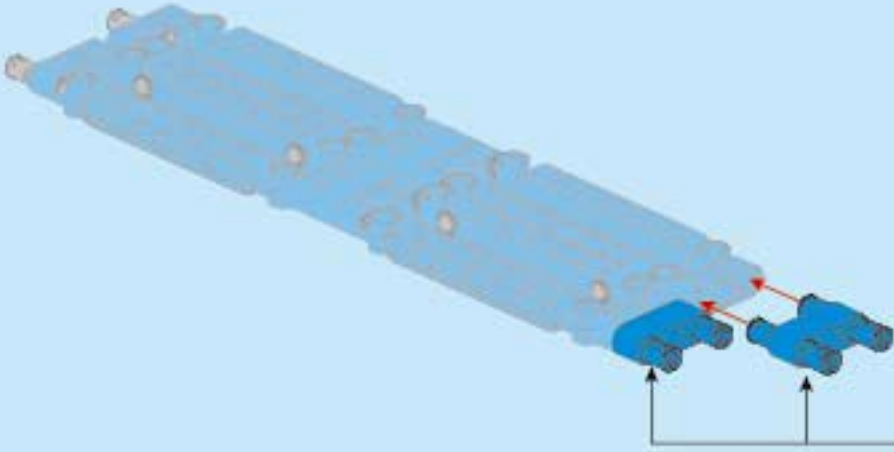

6

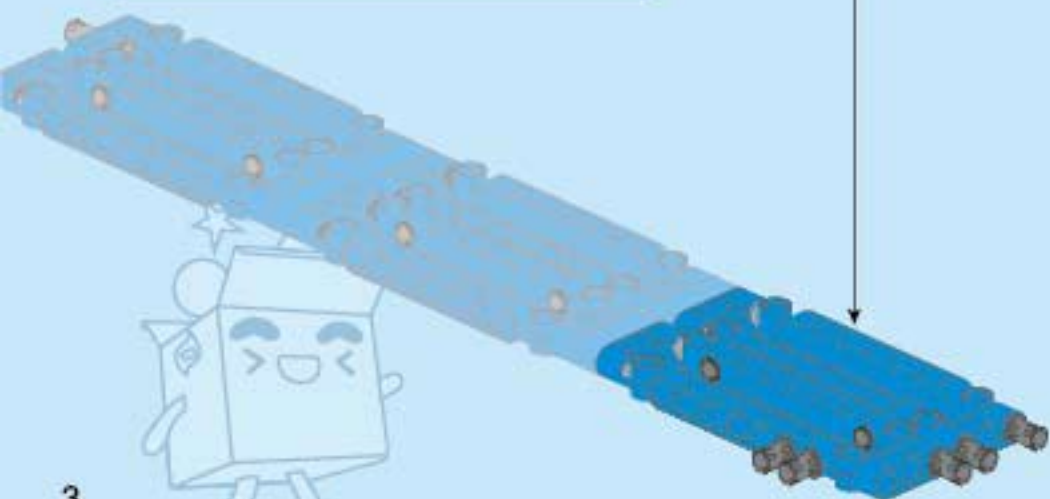
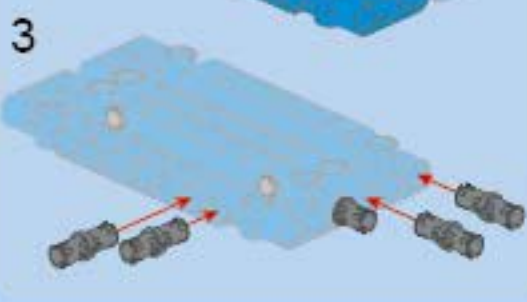
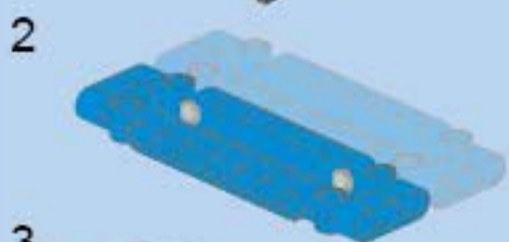
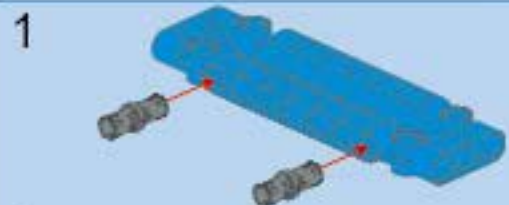

3



7

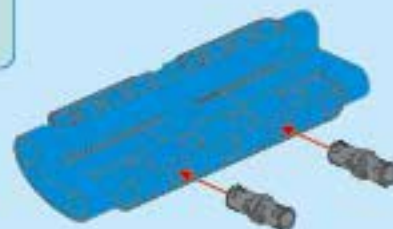

8

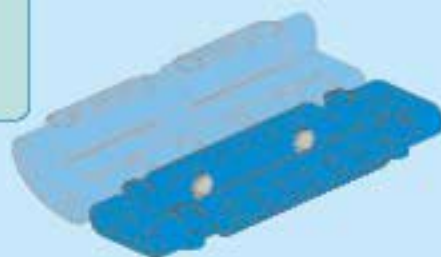

9

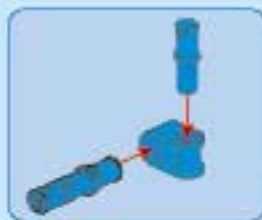

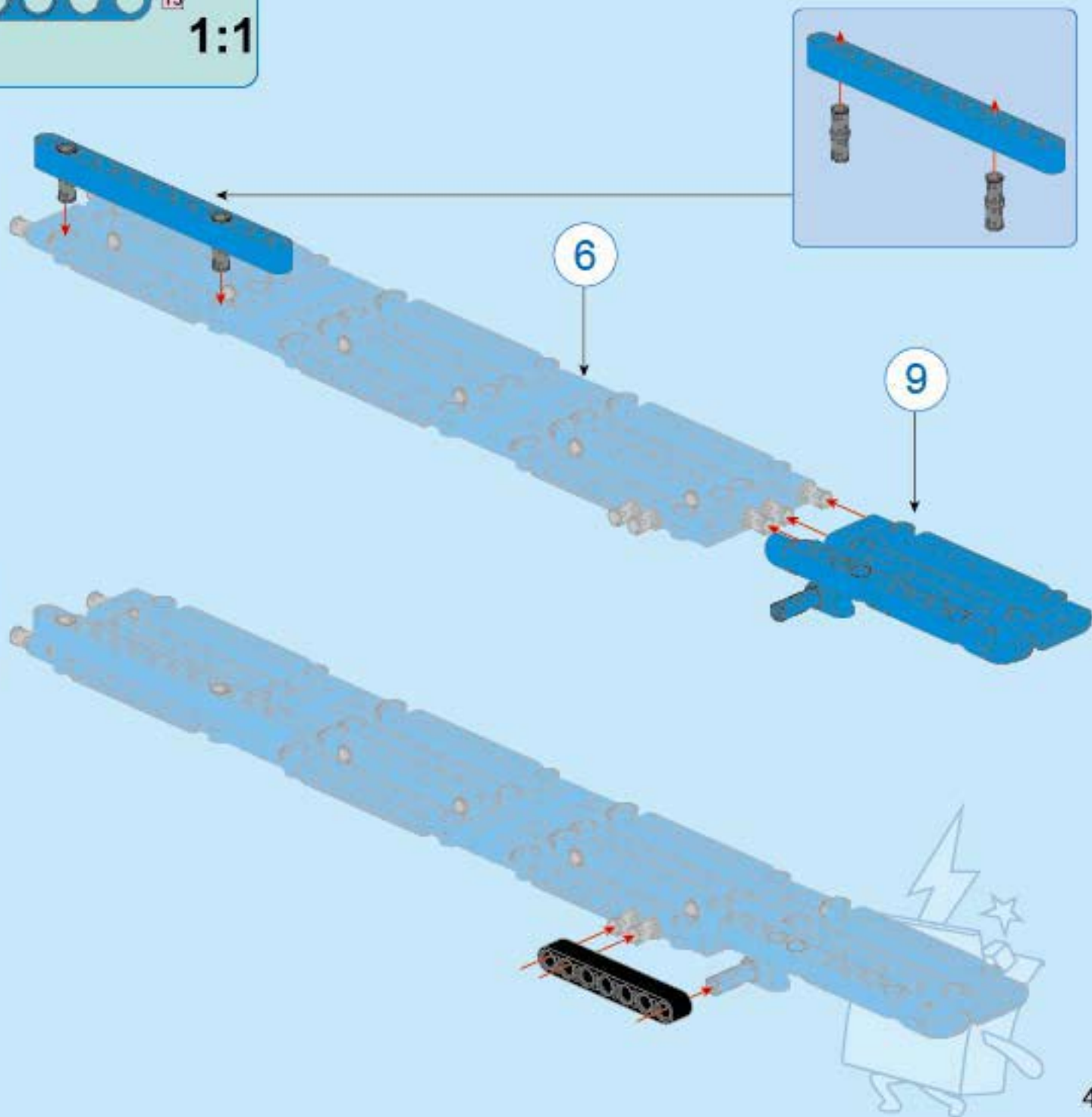
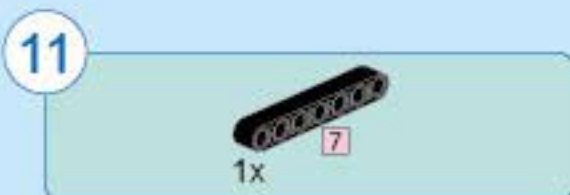
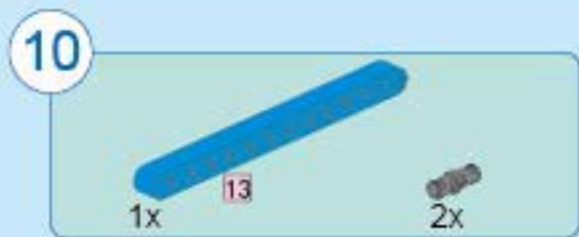

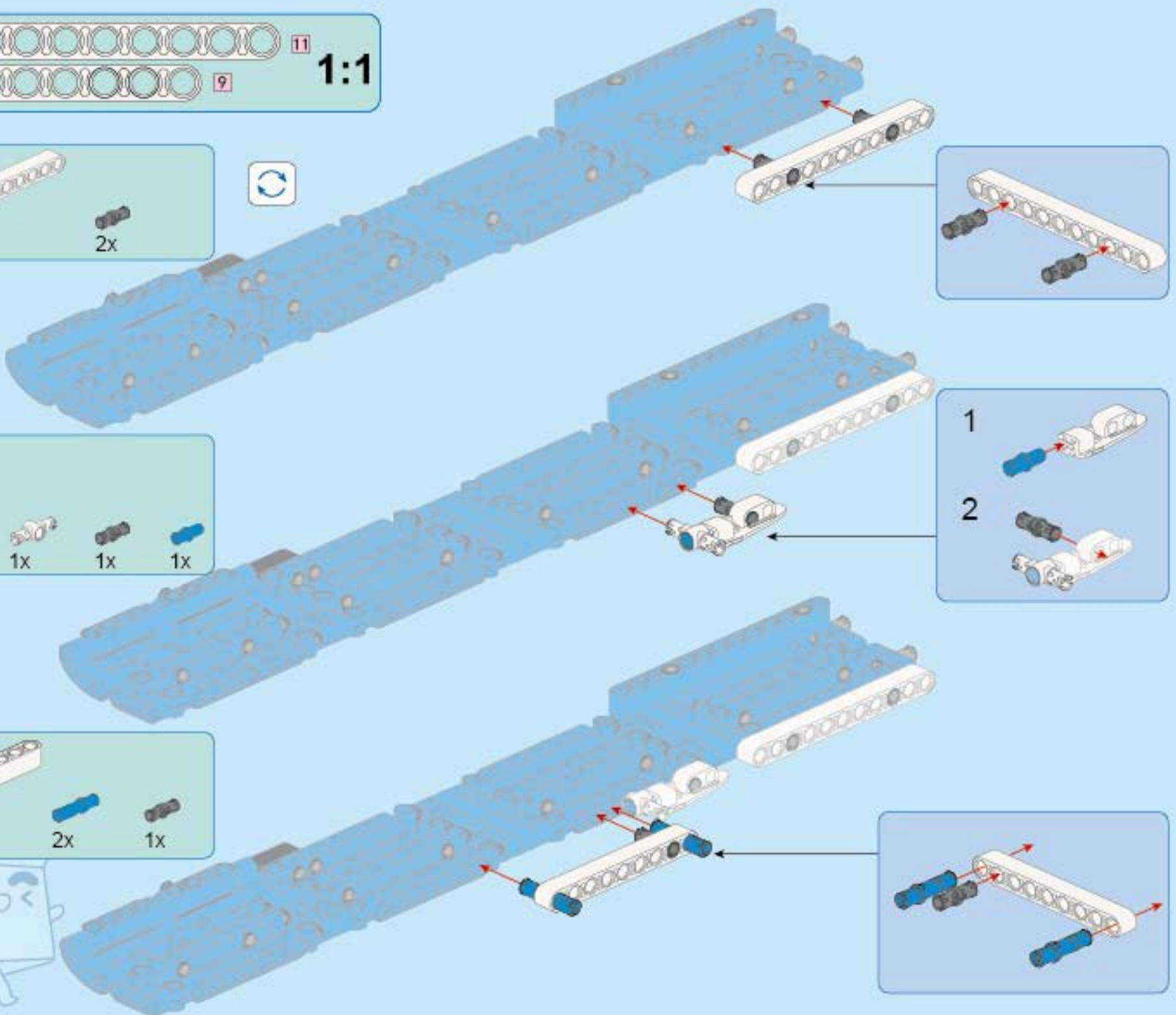
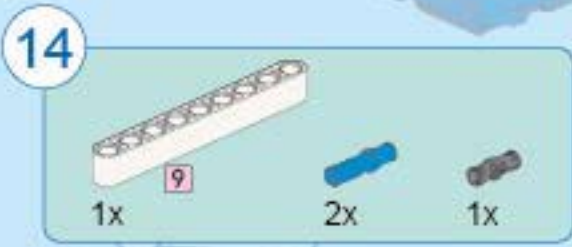
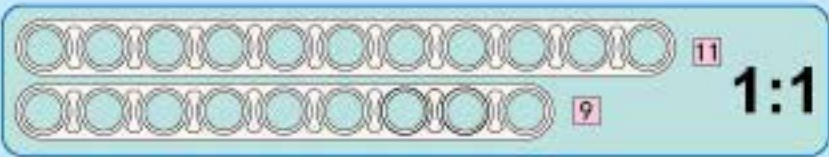



15

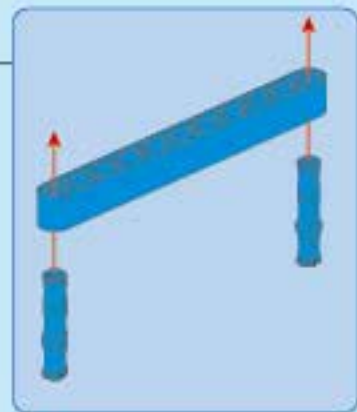
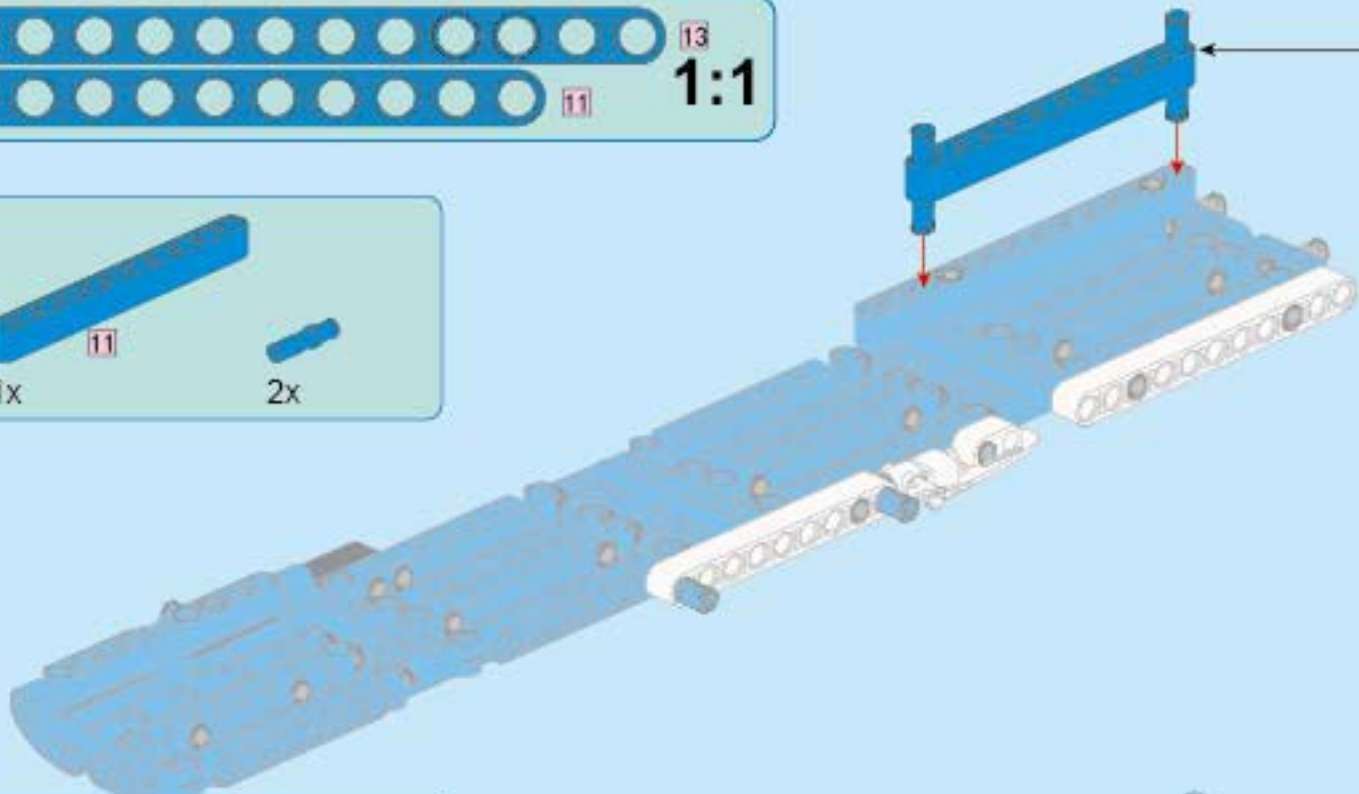
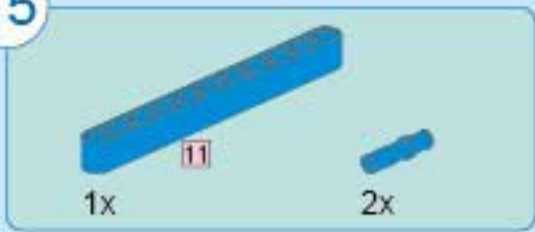

16

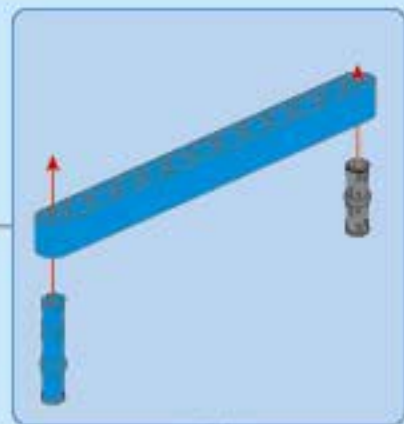
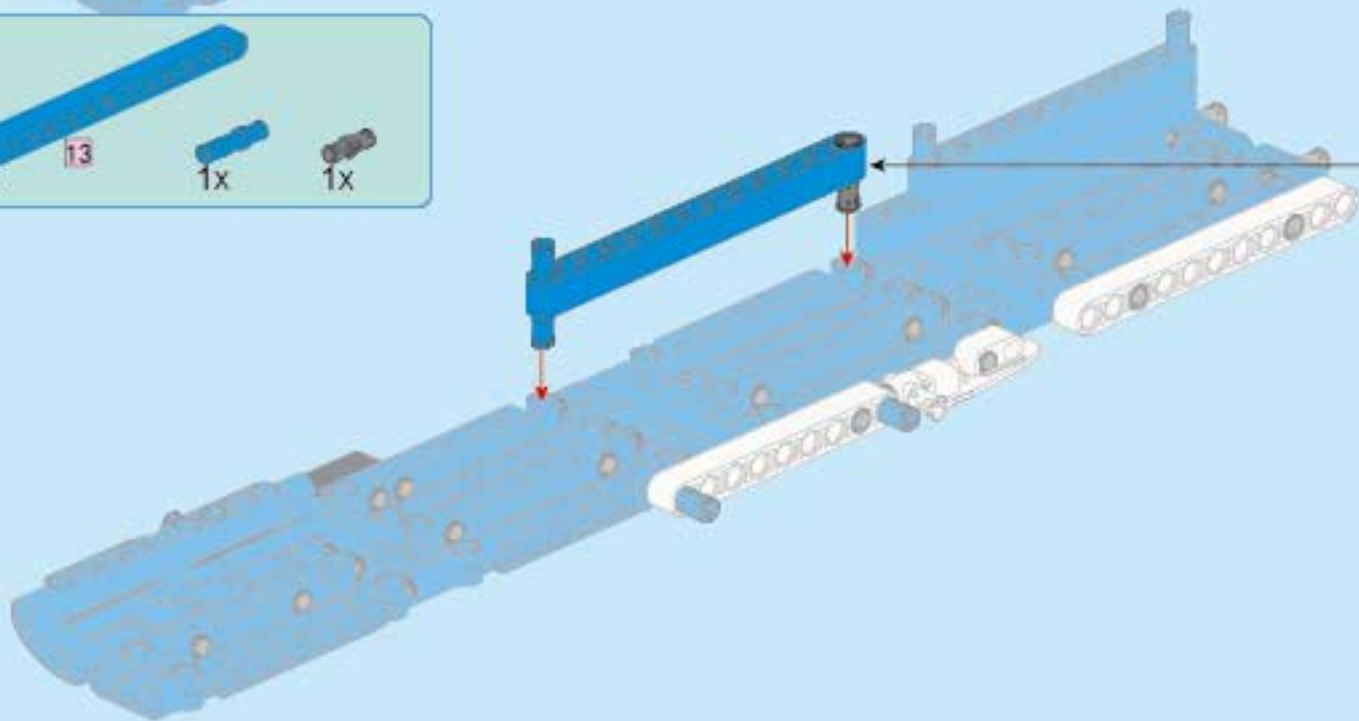
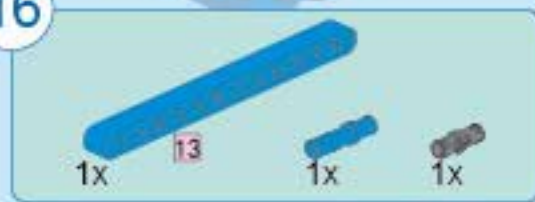

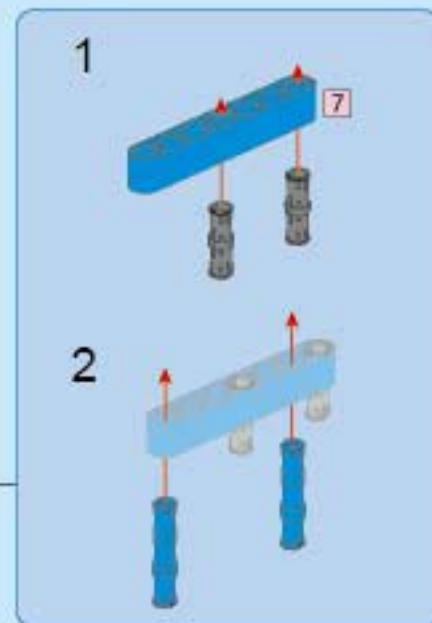
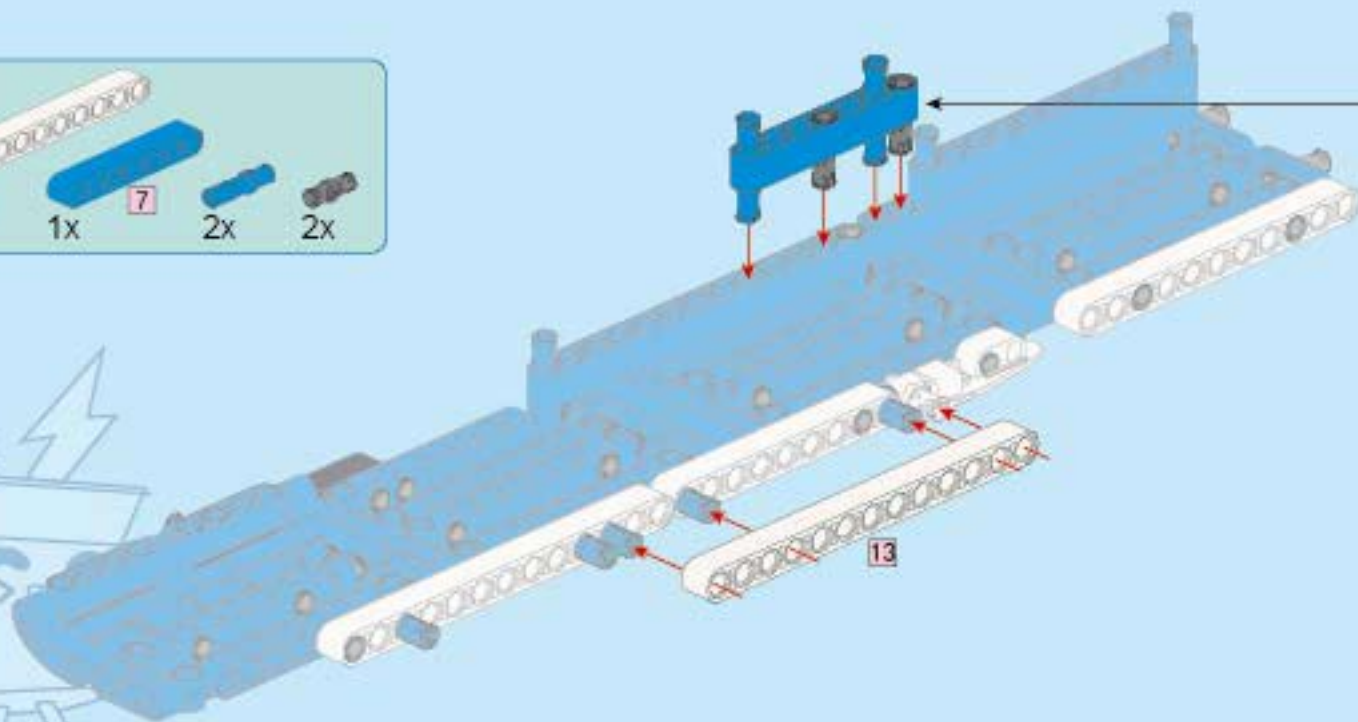
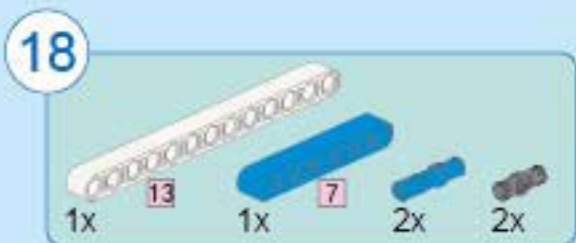
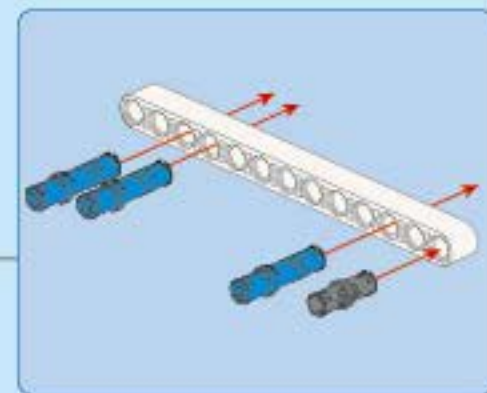
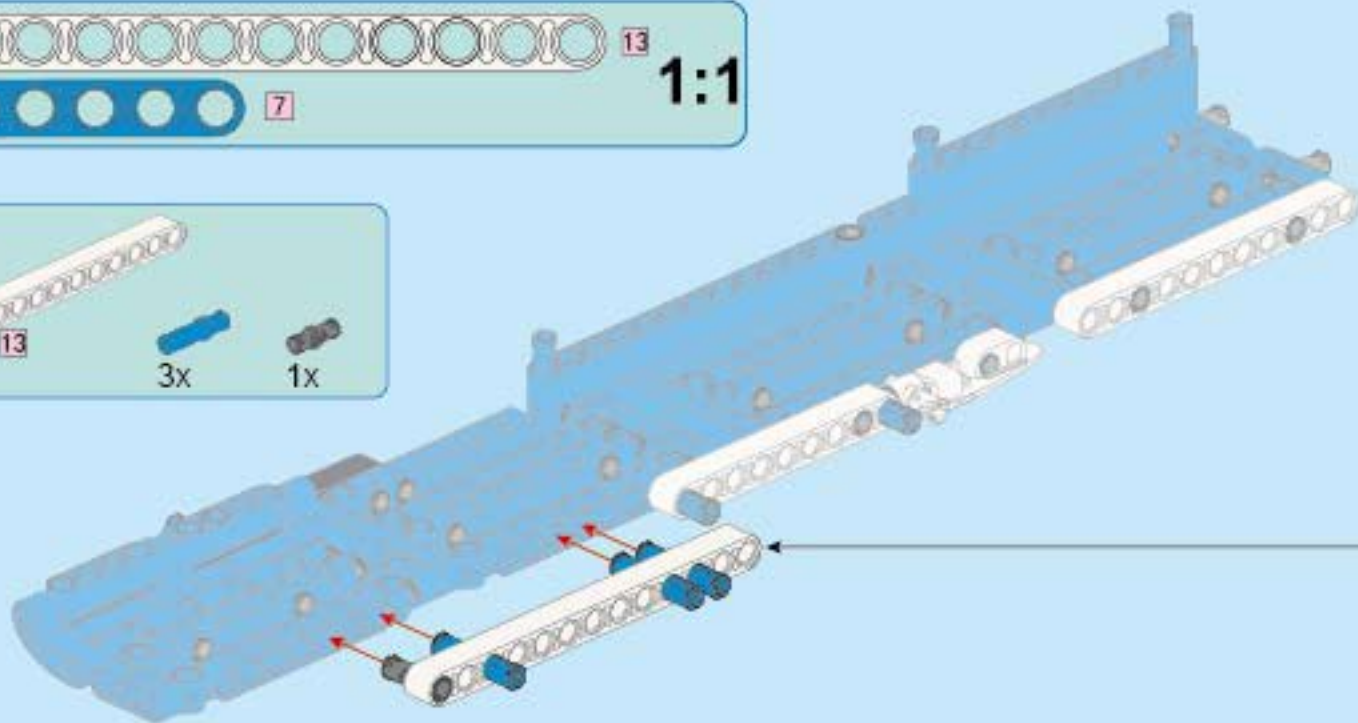



19

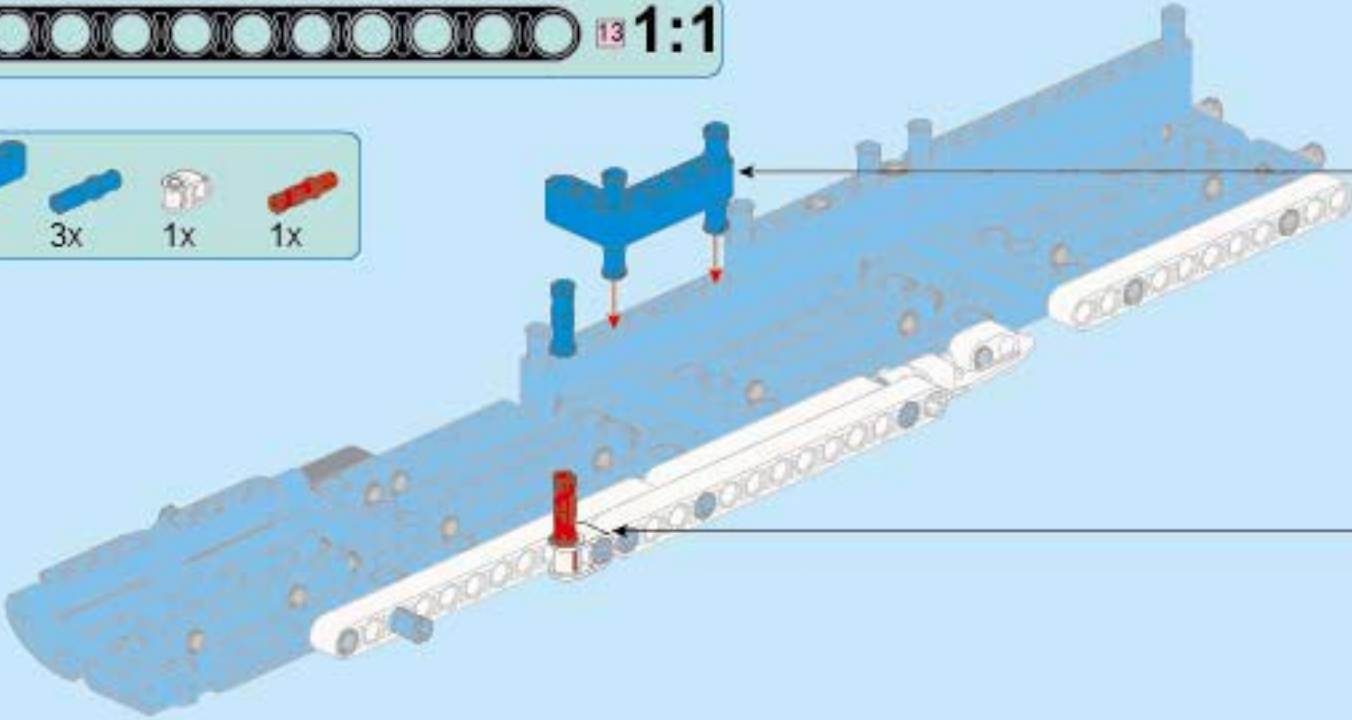

20

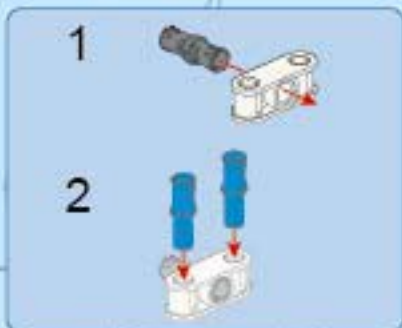
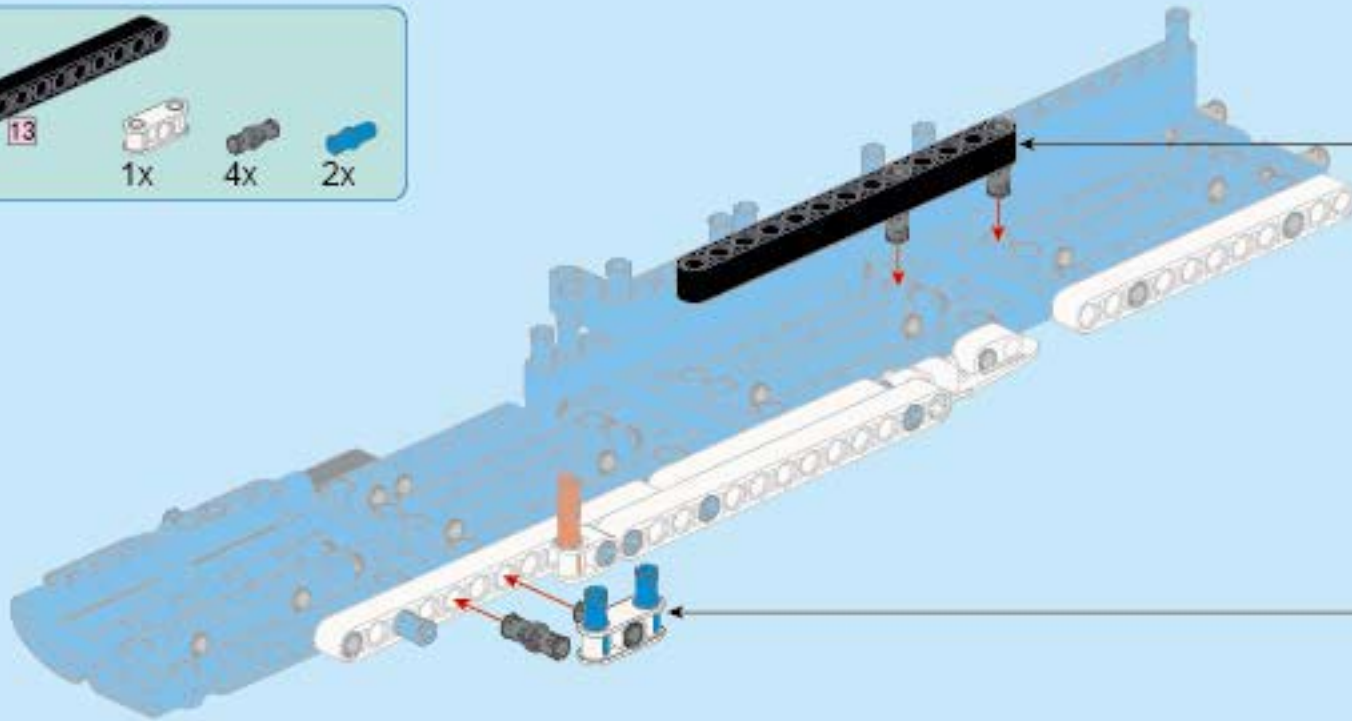

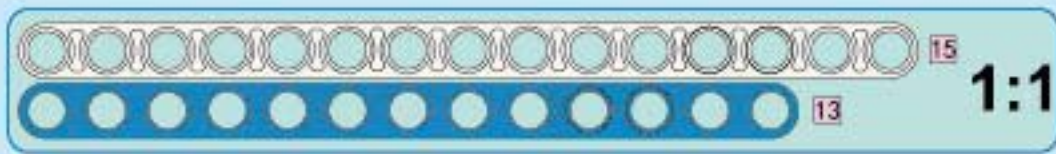

21

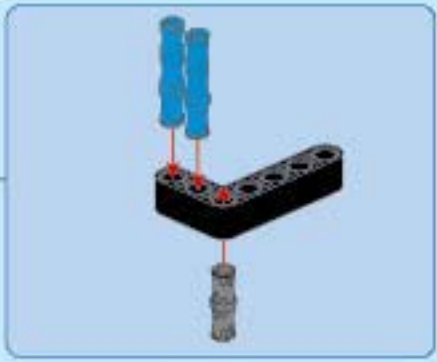
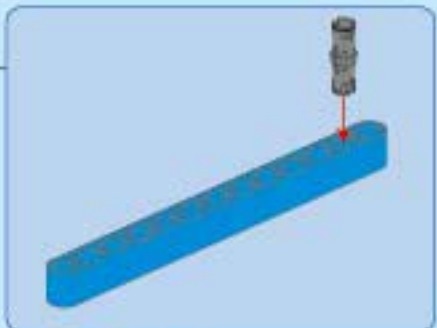
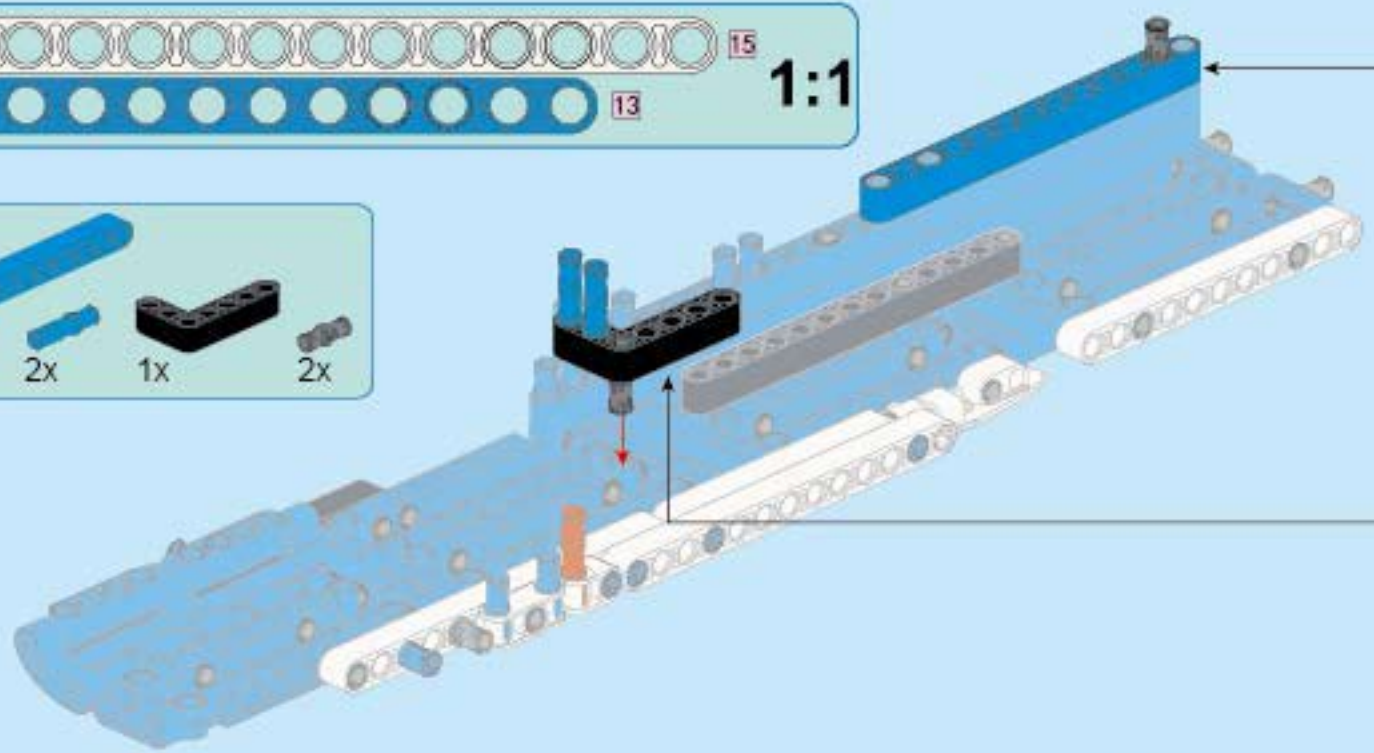
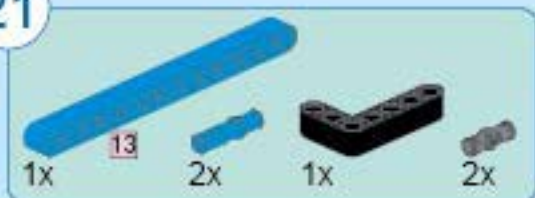

22

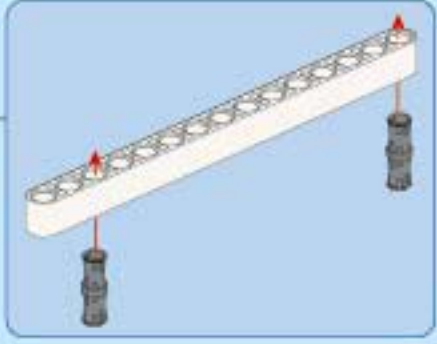
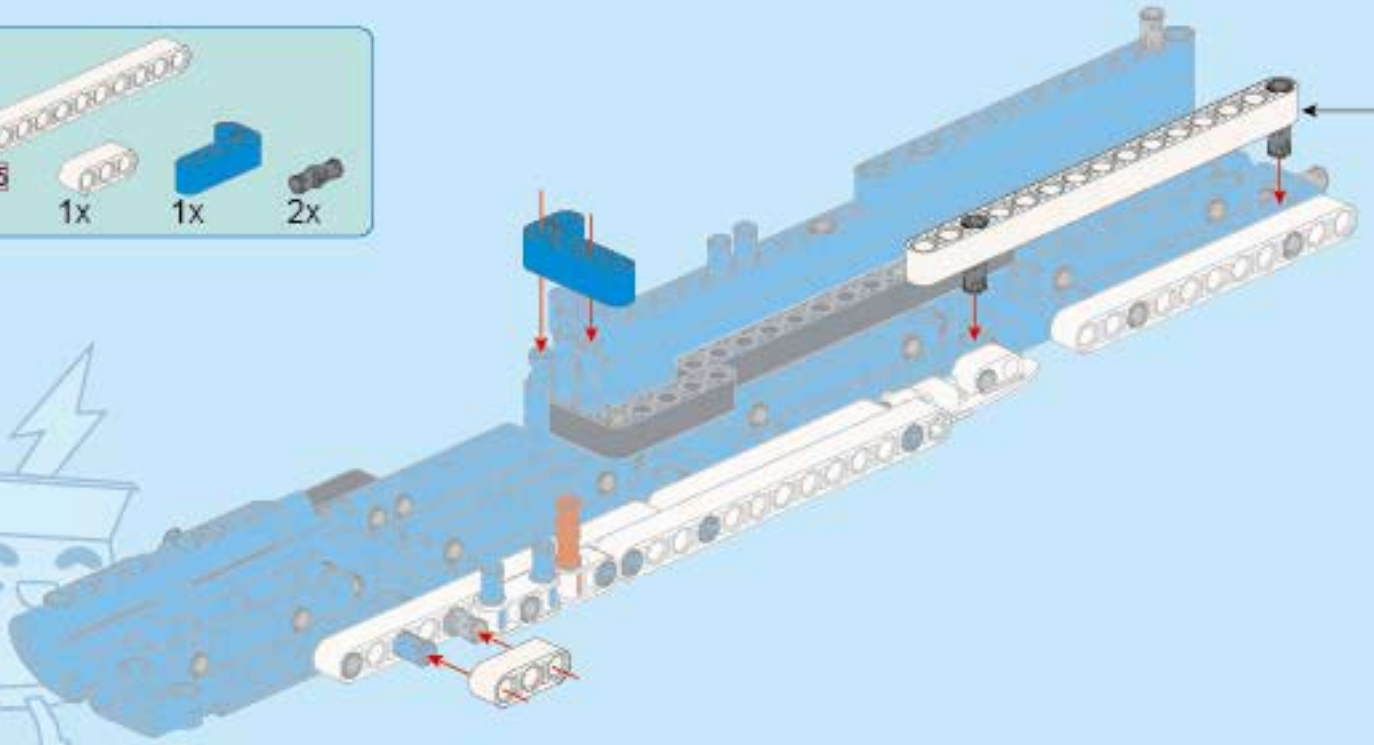
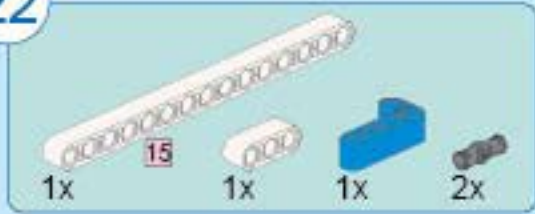

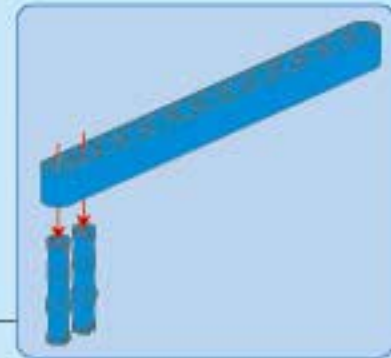
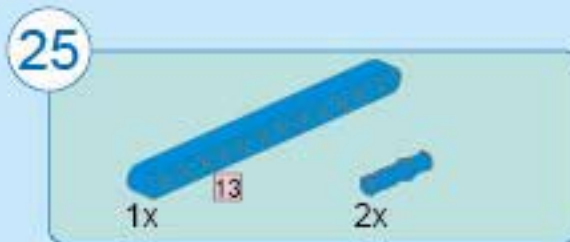
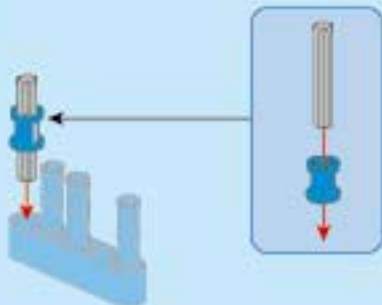
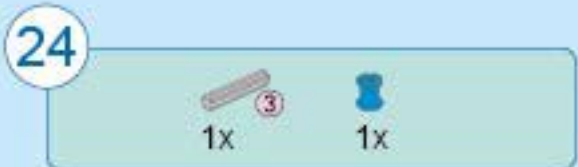
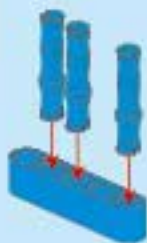
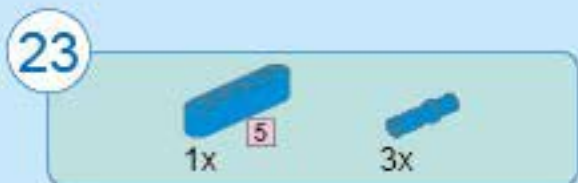
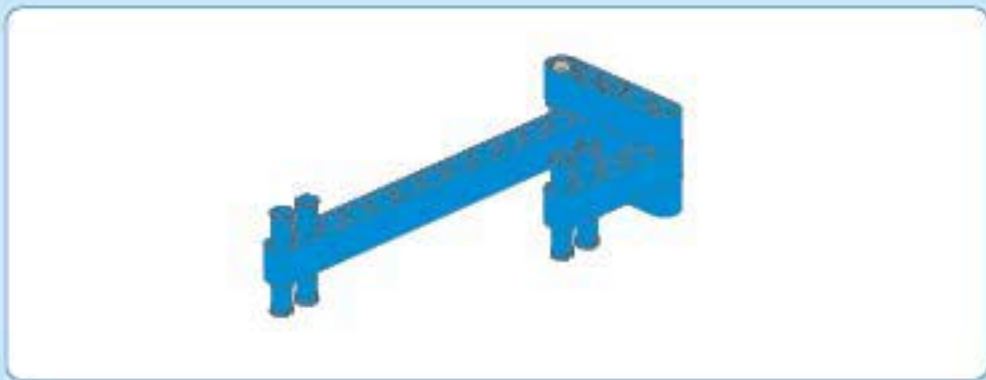

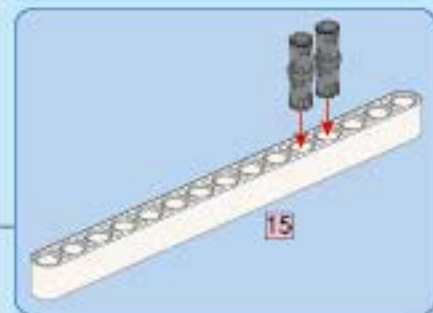
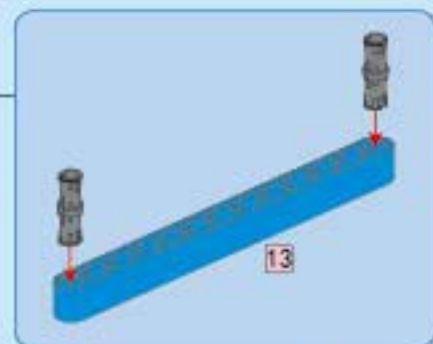
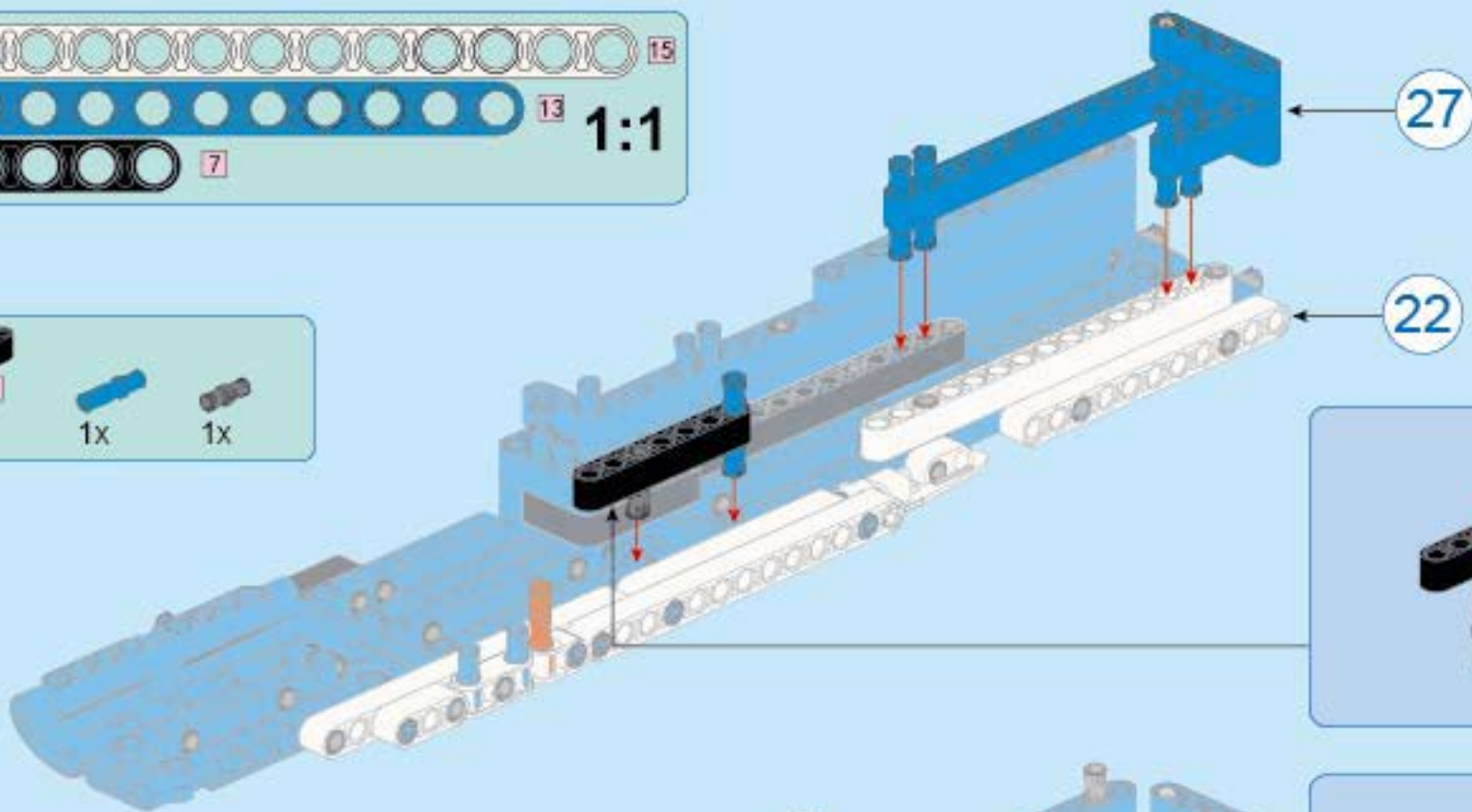
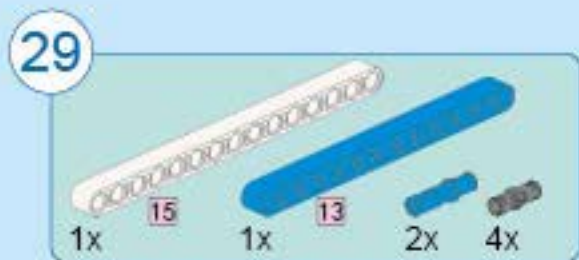
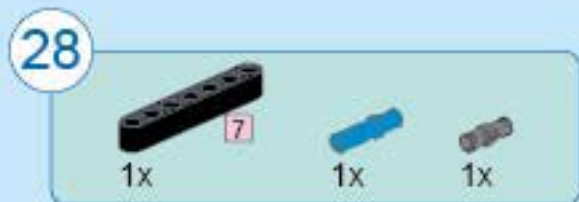
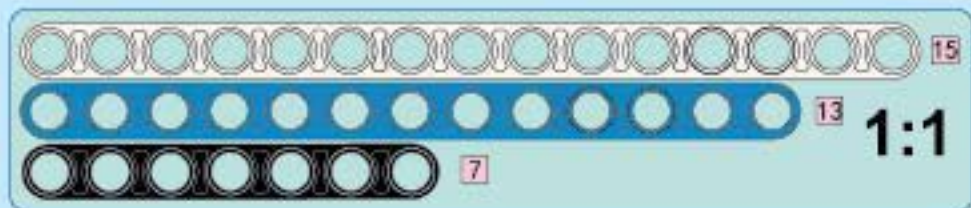

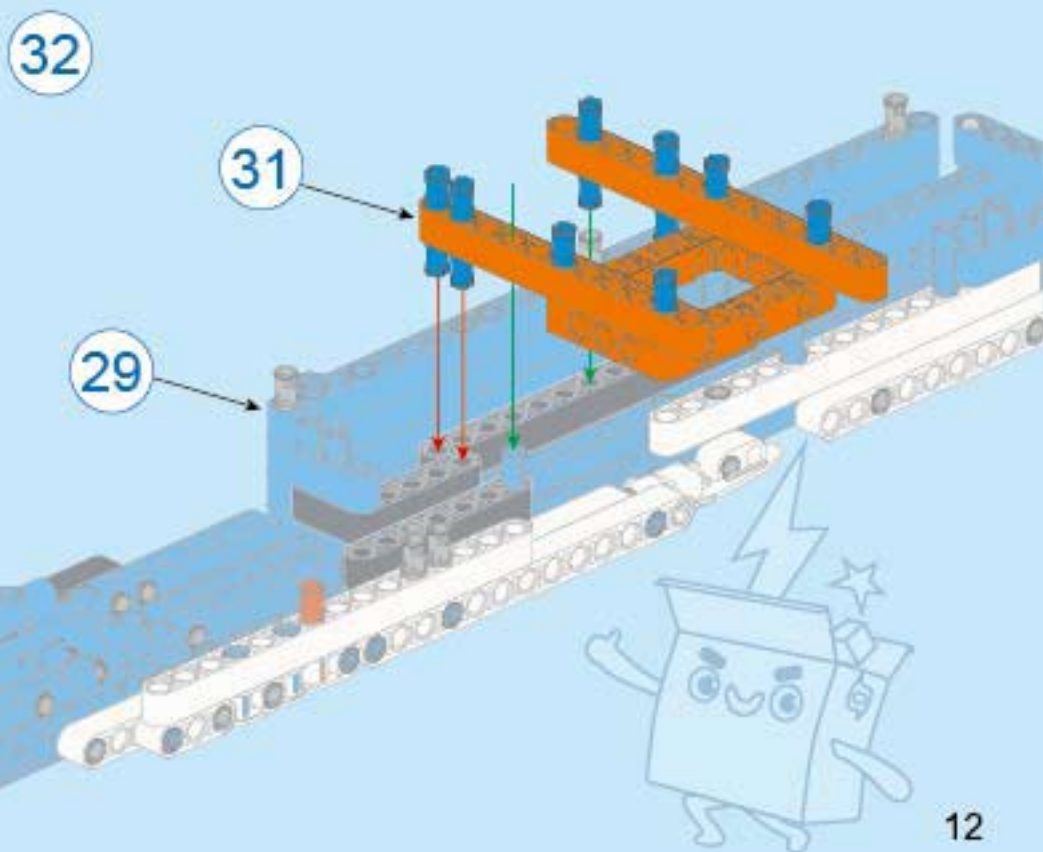
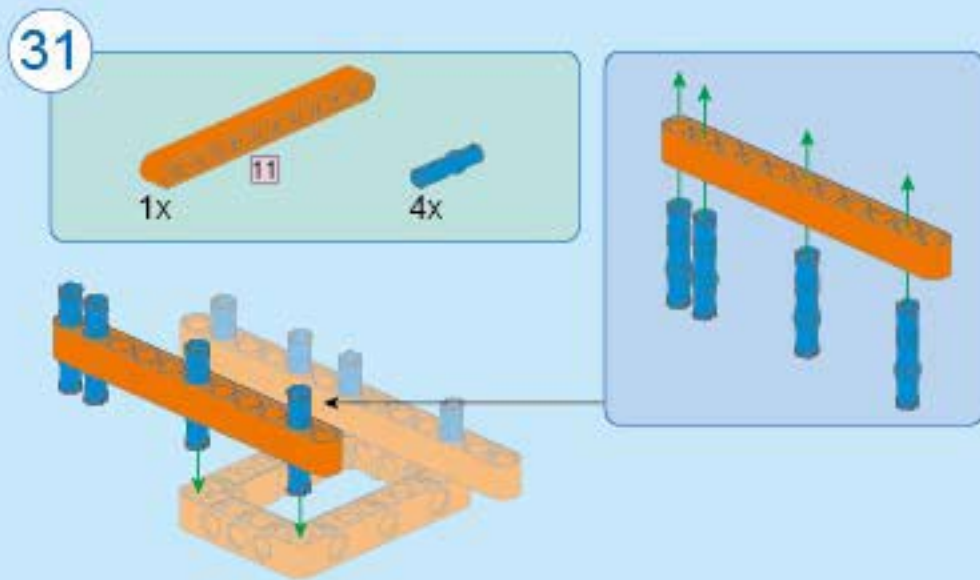
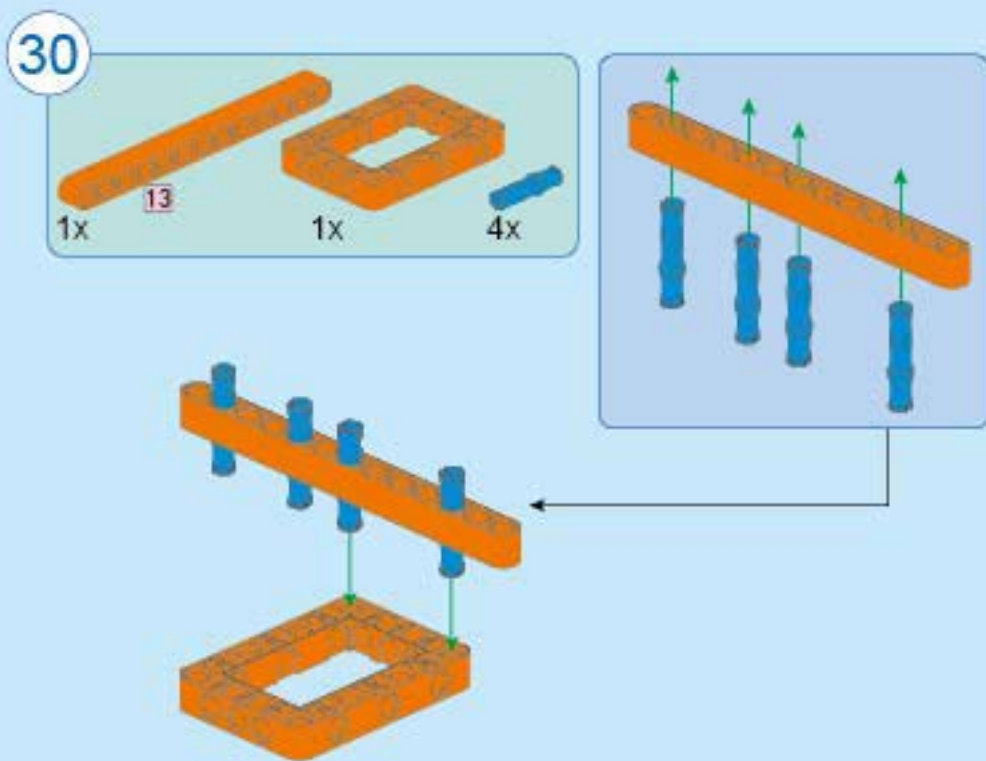
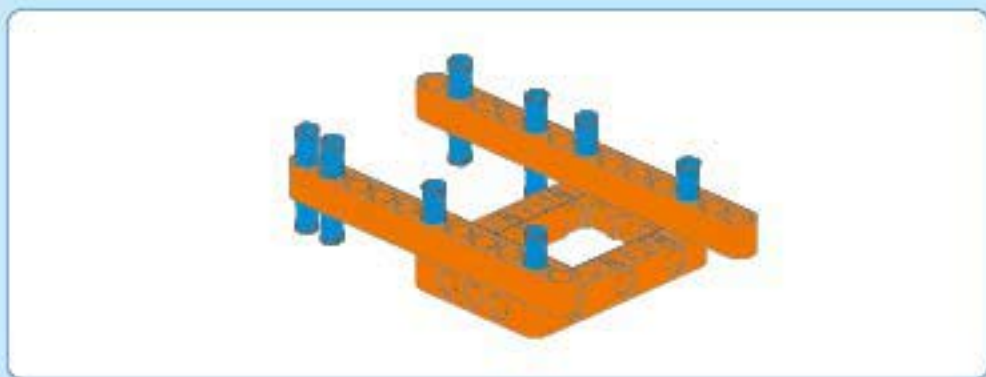

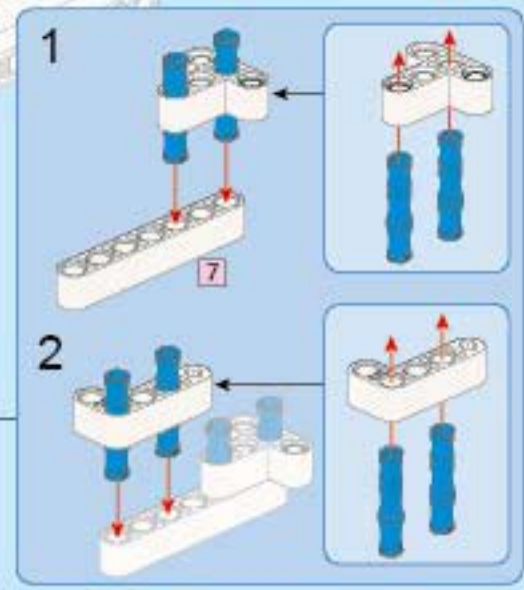
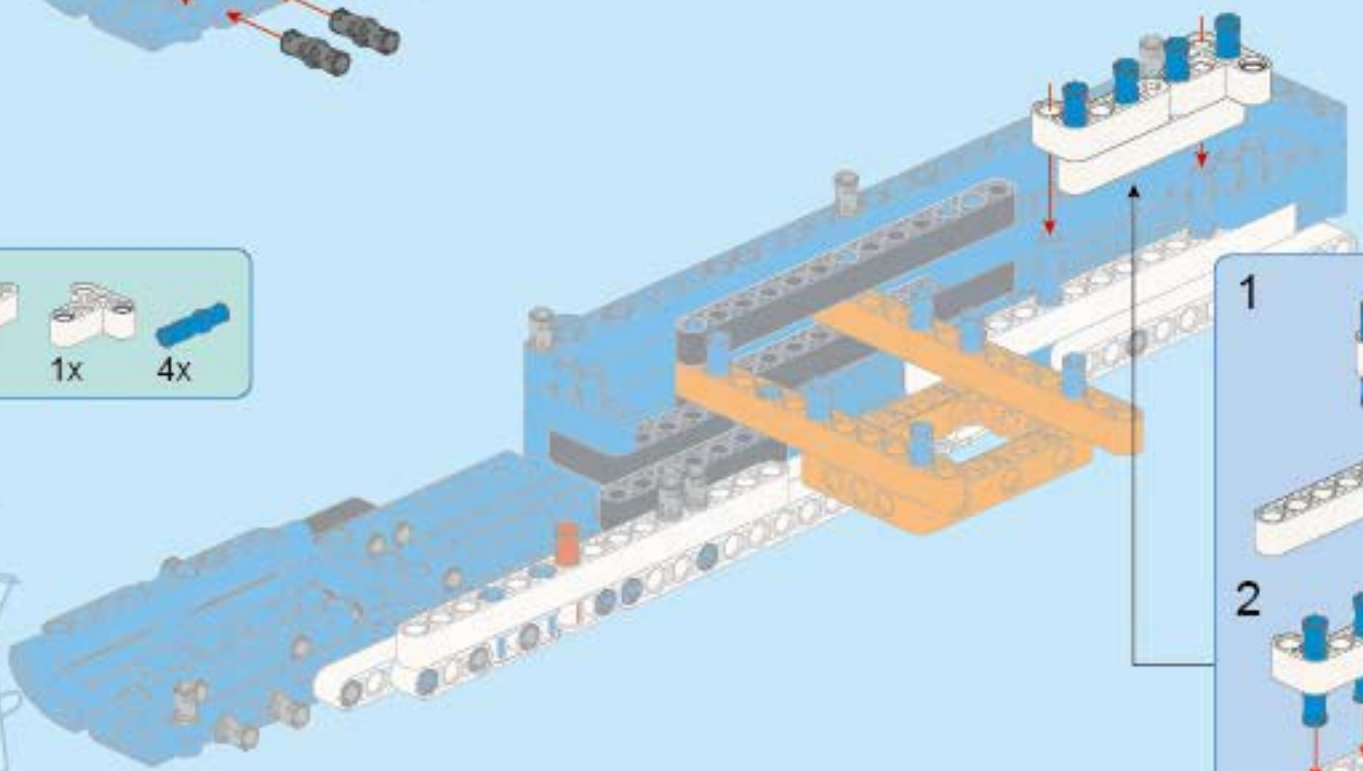
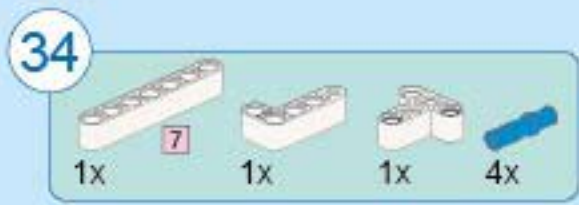
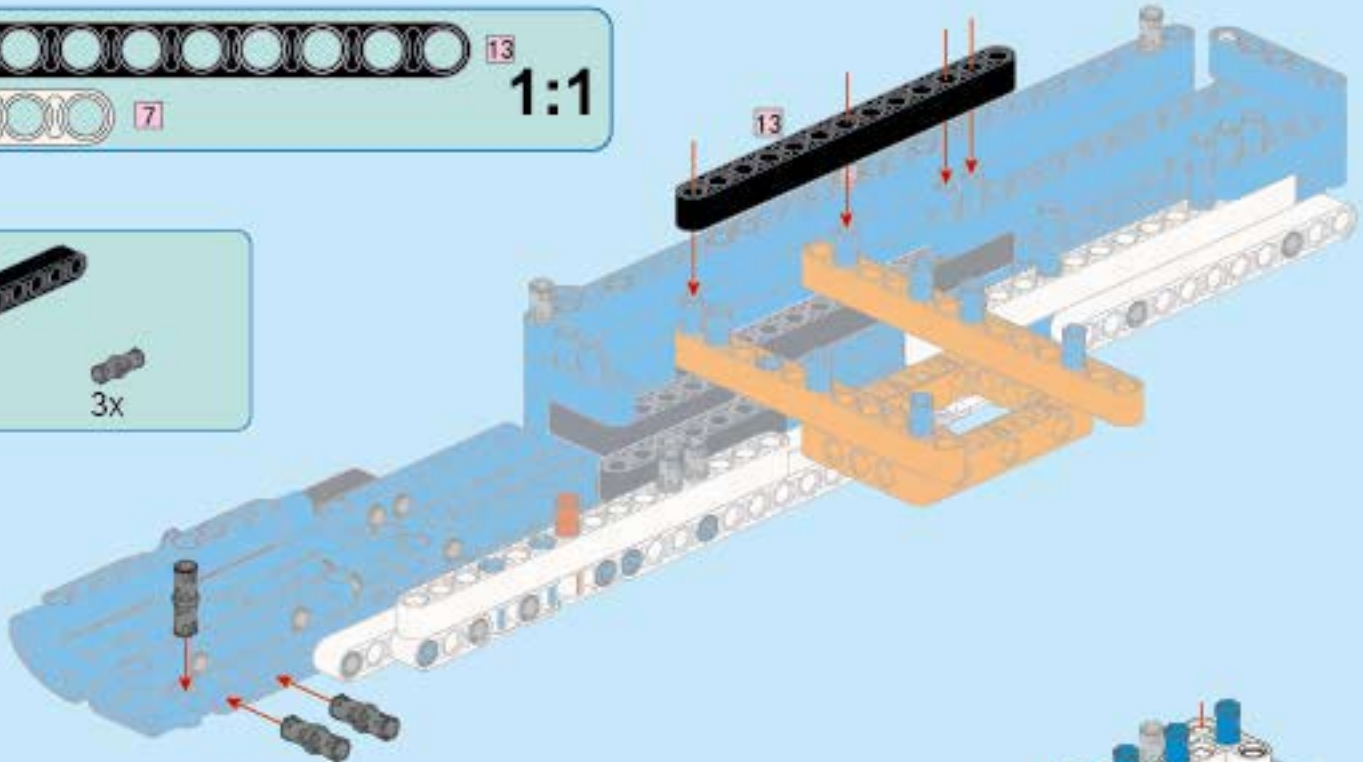
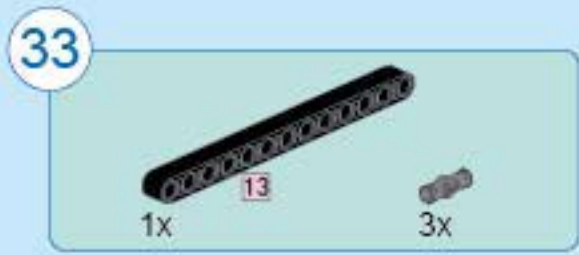
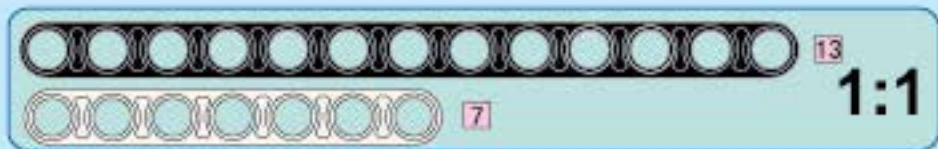

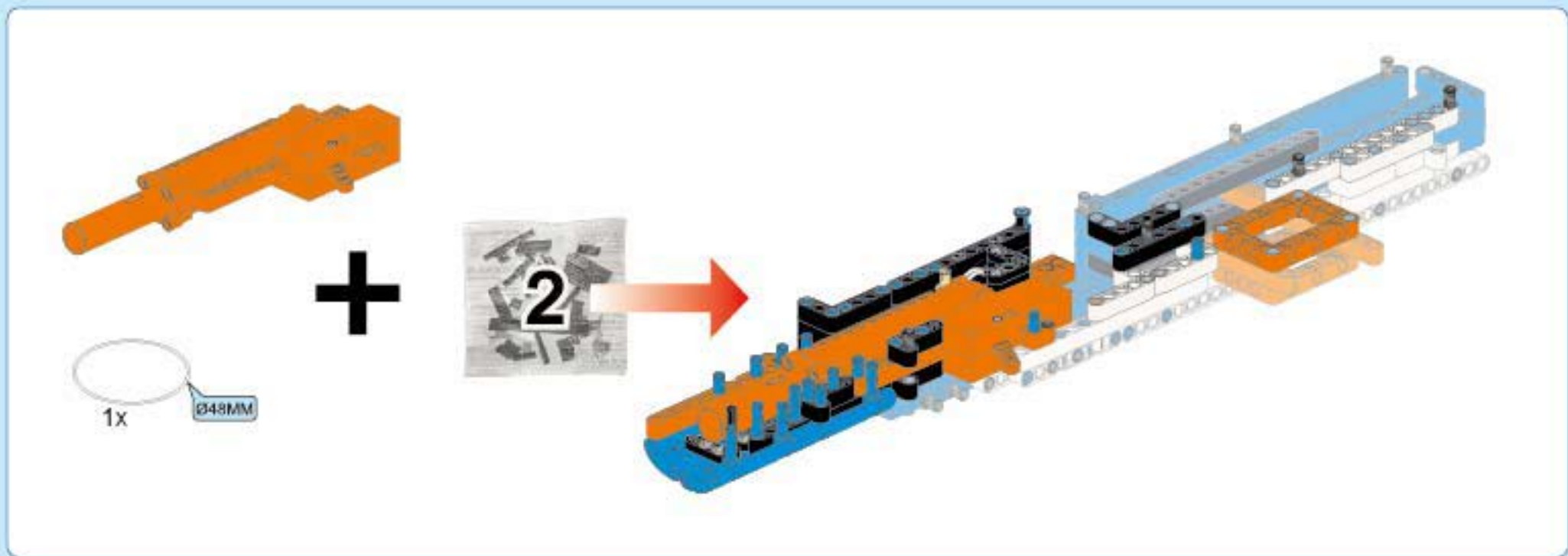

35

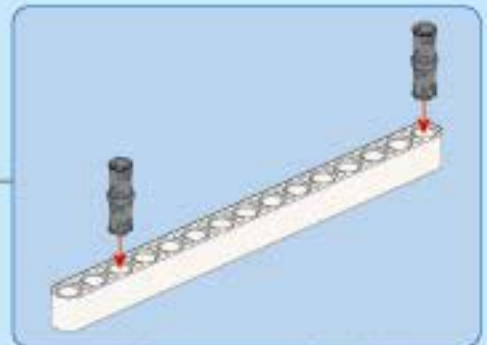
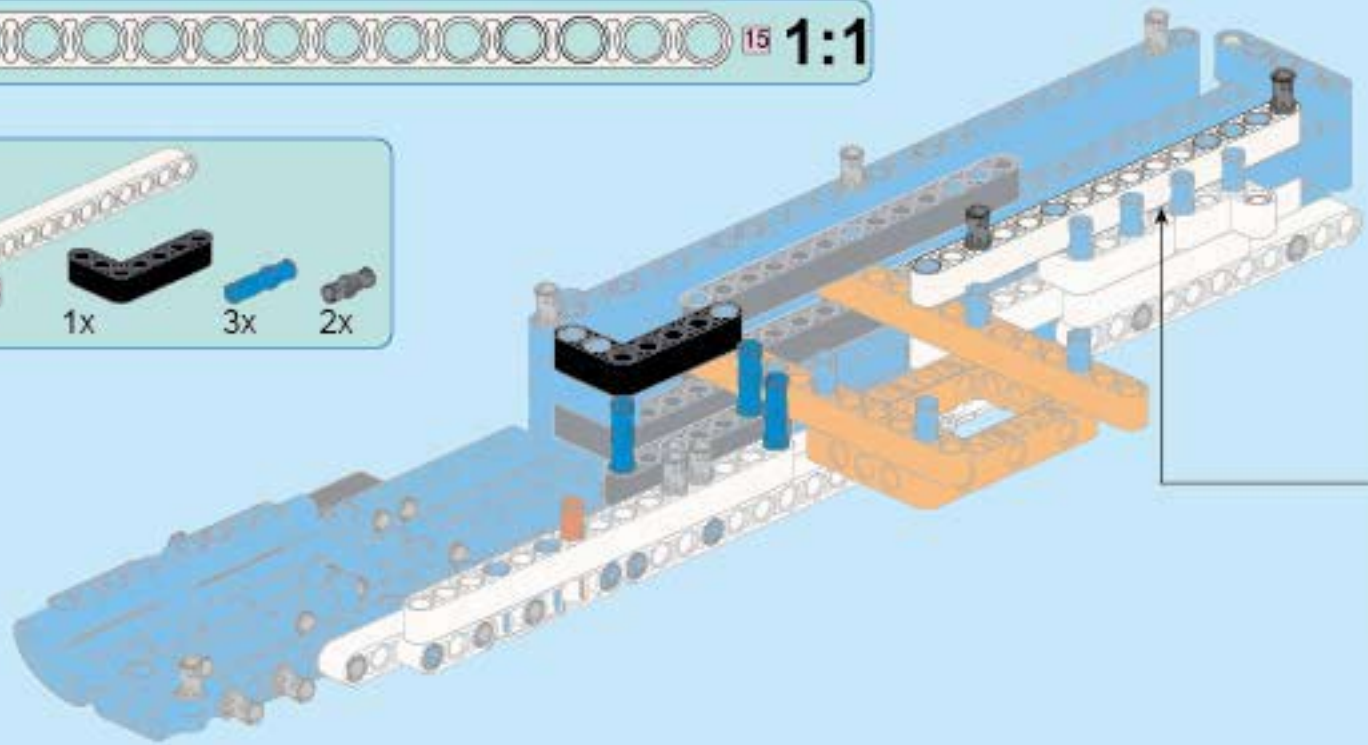
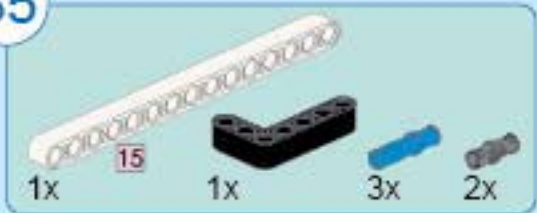

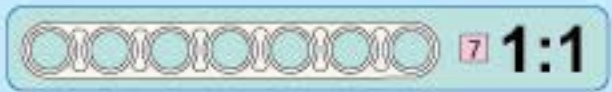

36

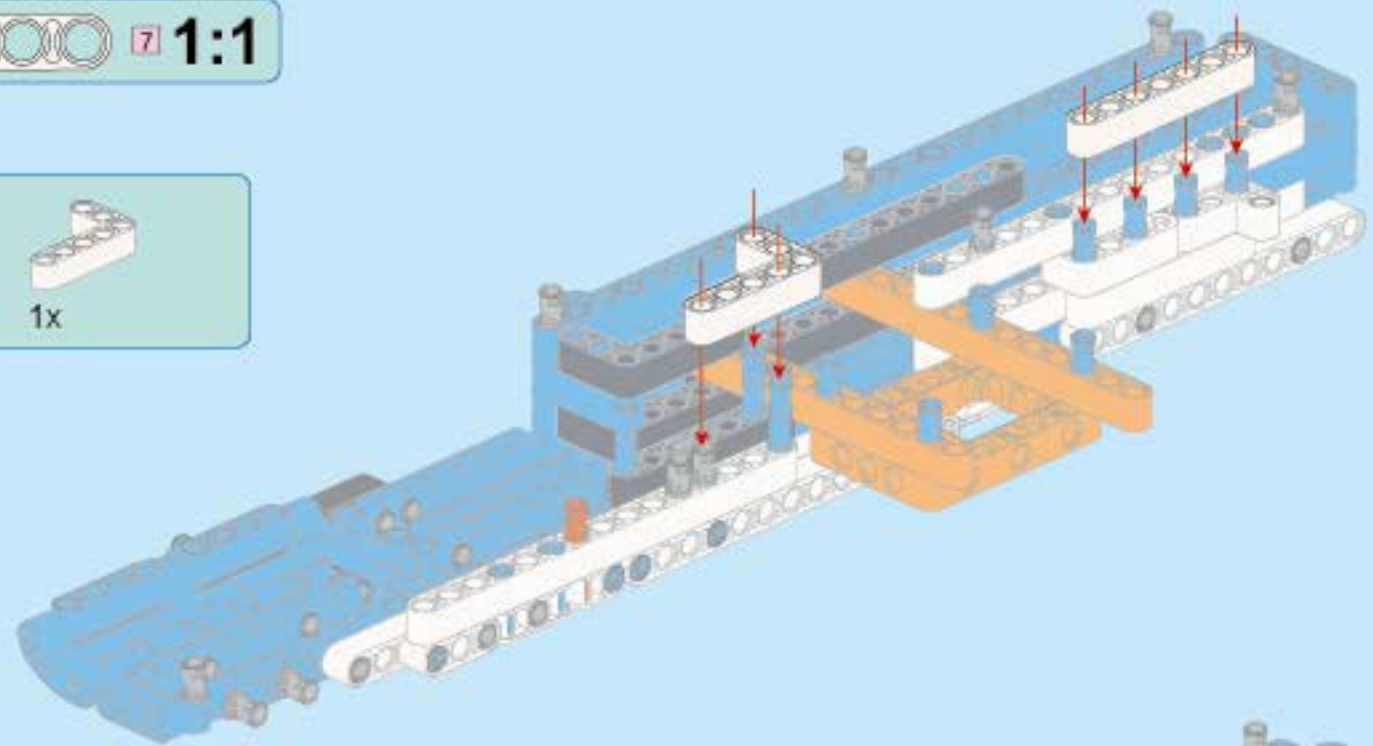
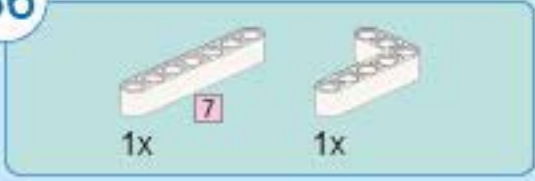

37

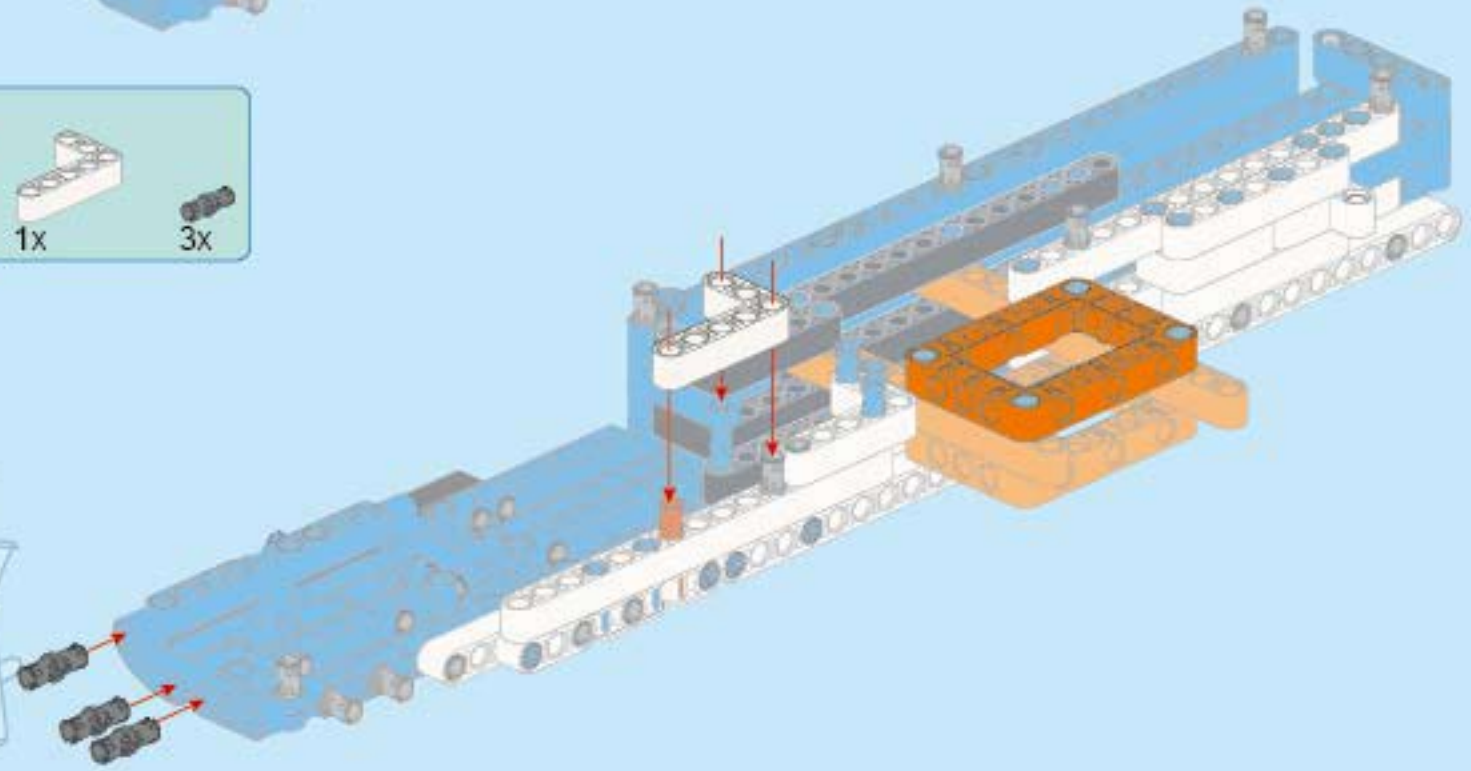
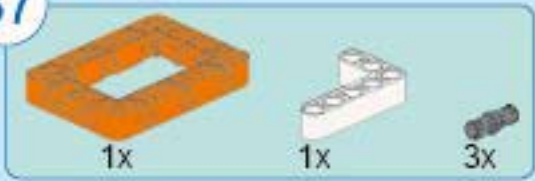

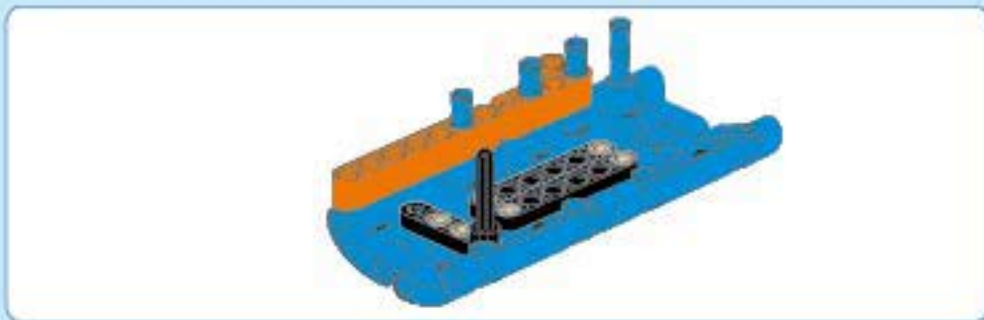

38

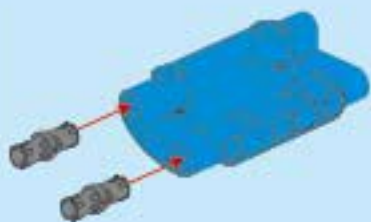

39

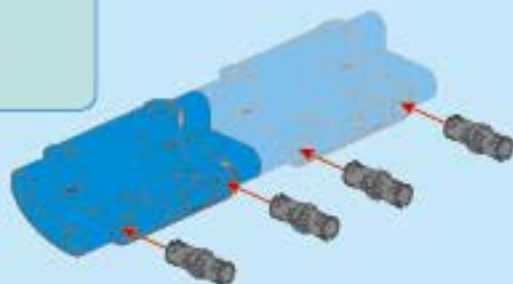

40

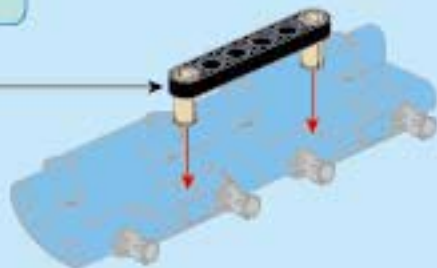

41

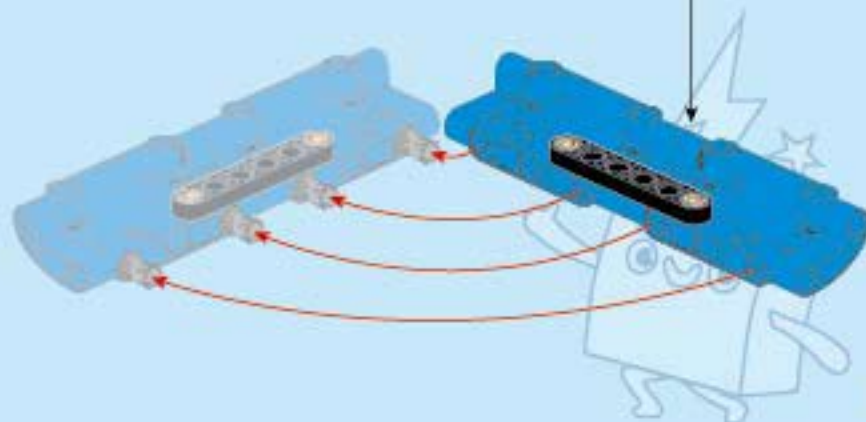
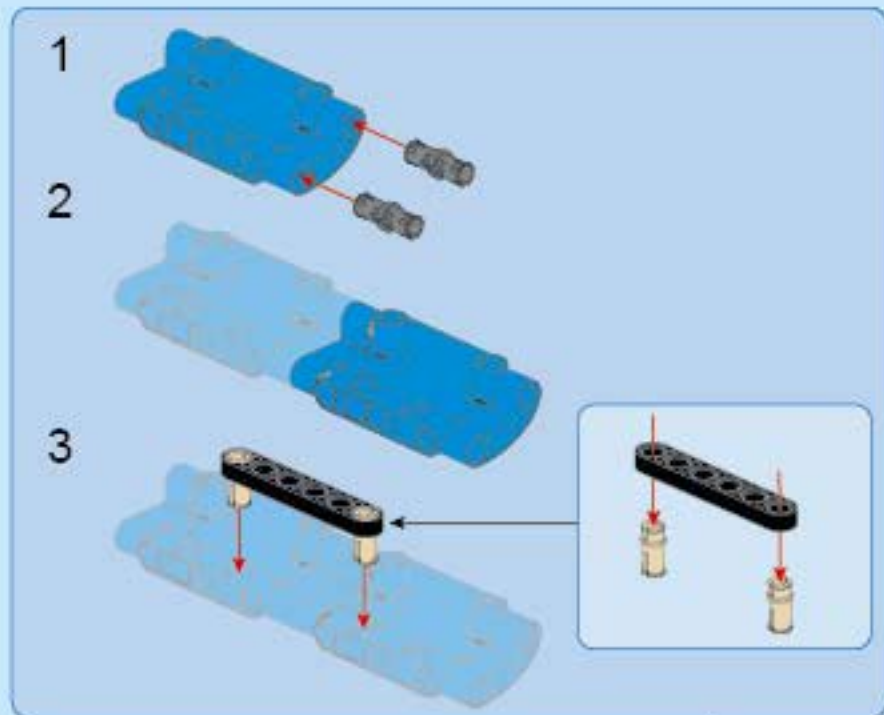
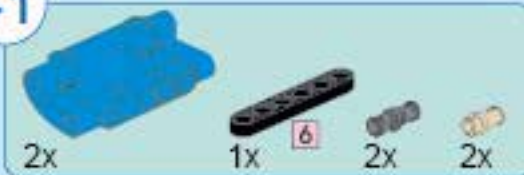



42

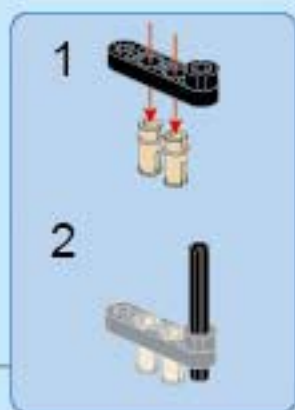
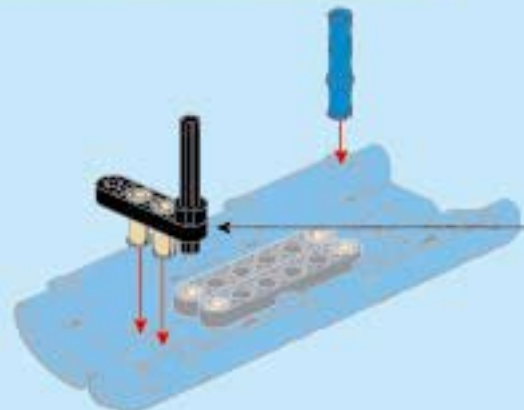

43

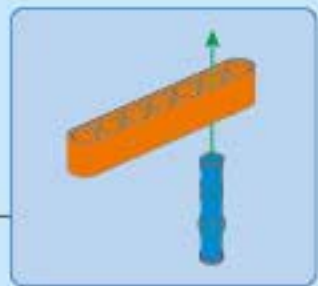
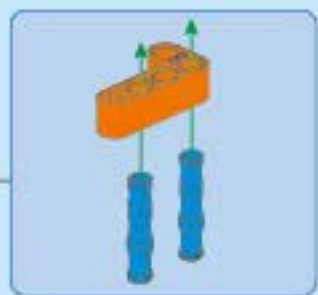
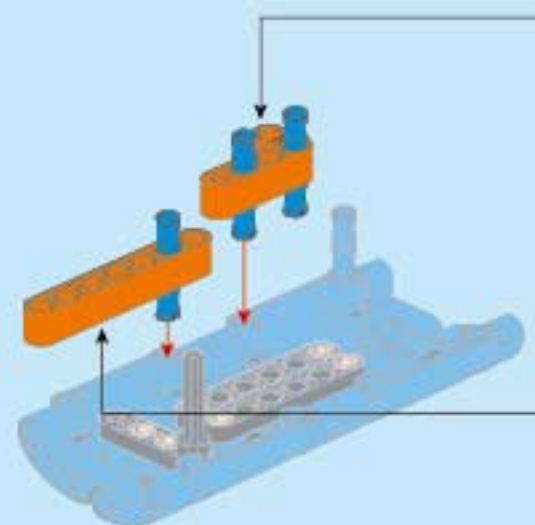
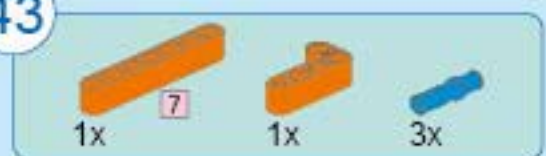

44

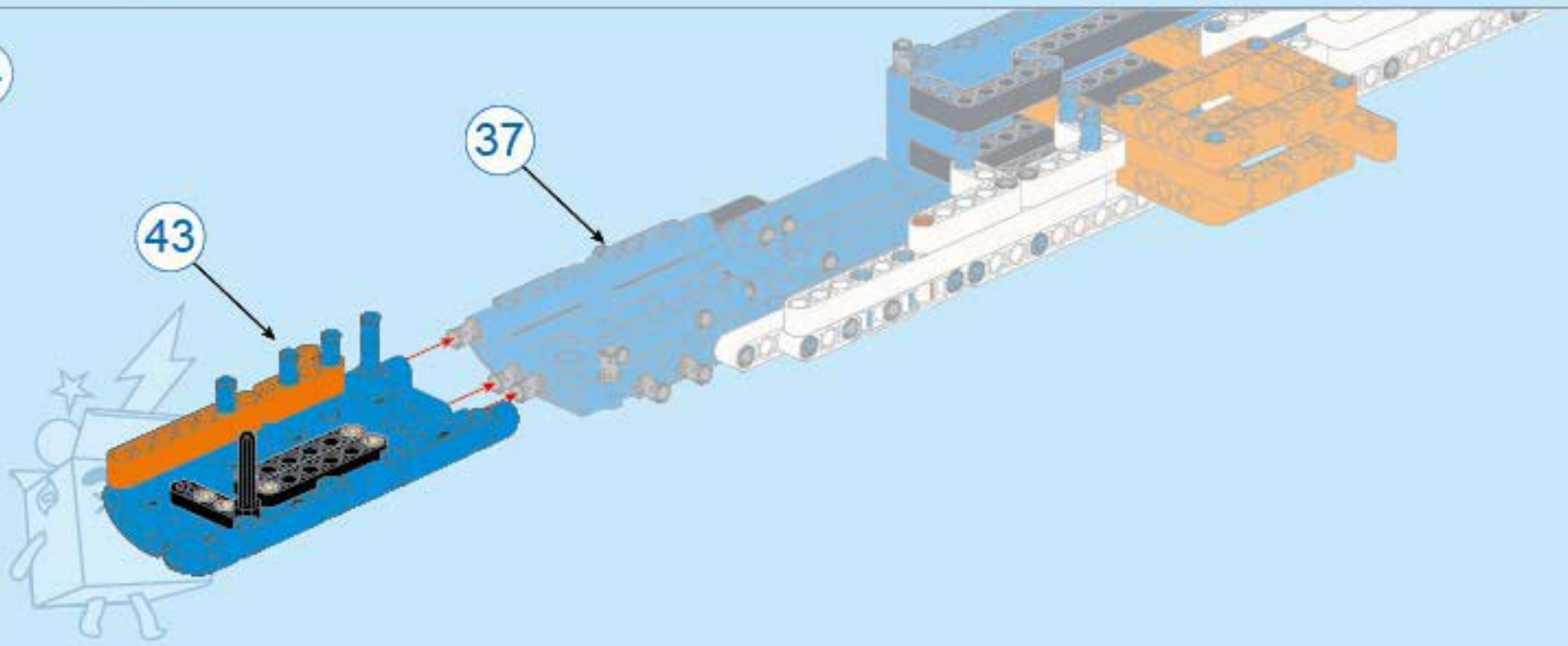



45

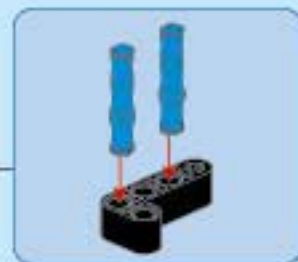
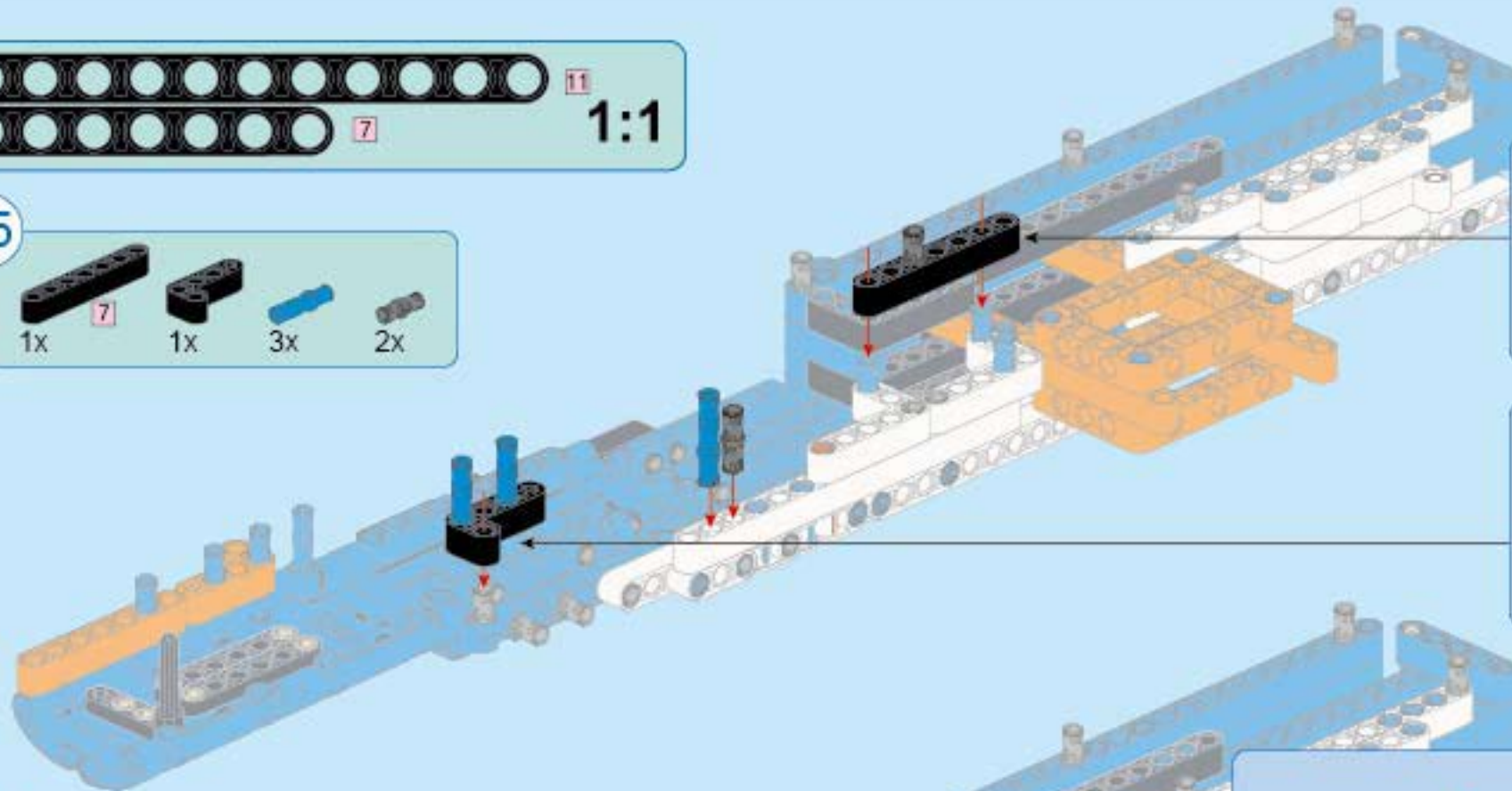

46

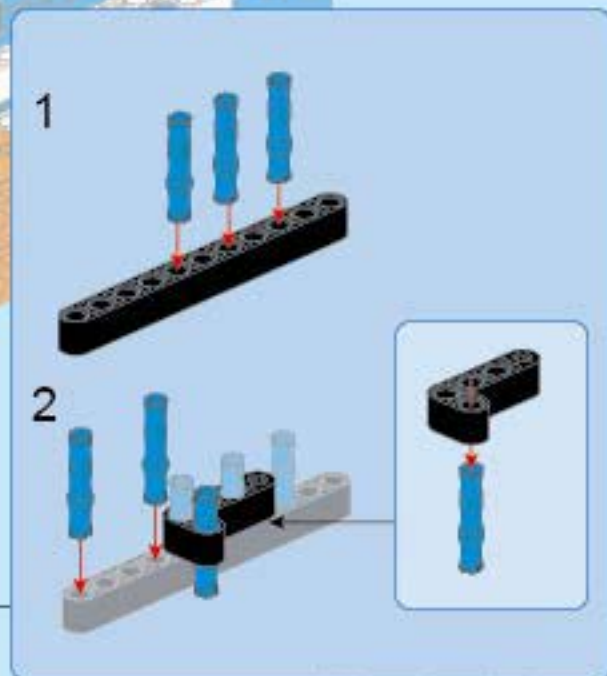
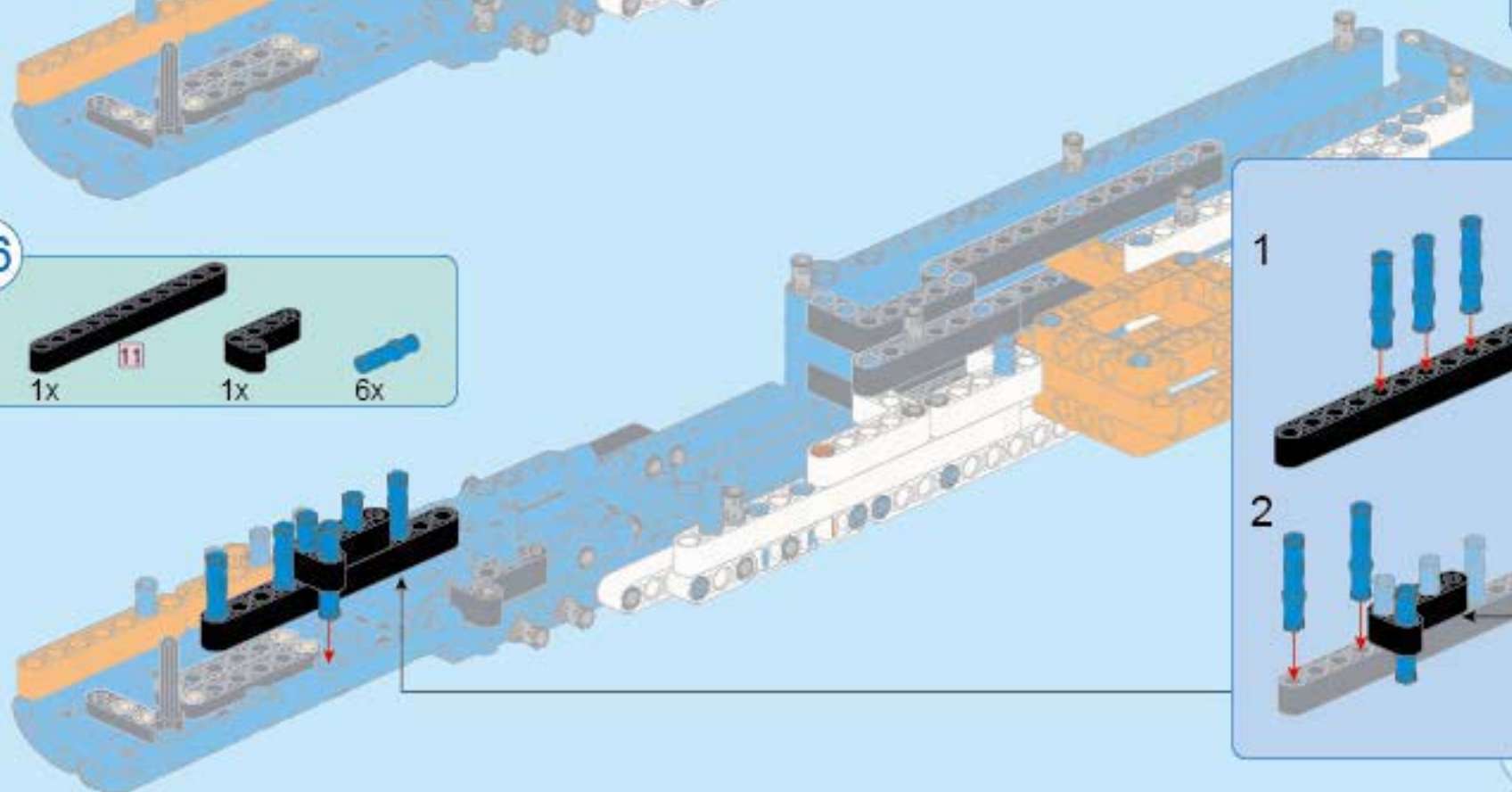
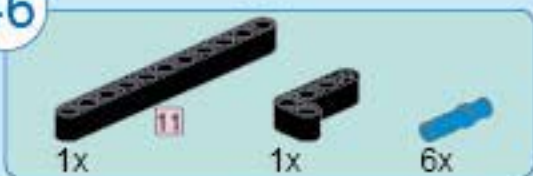

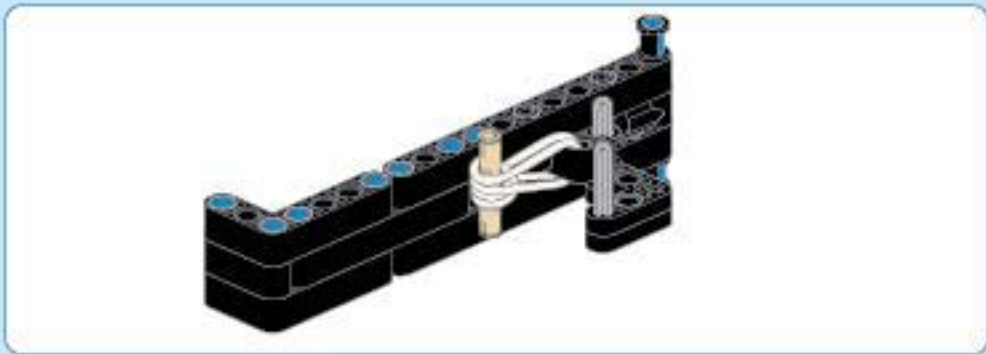

47

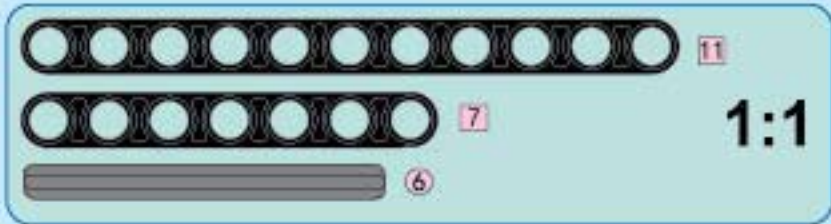
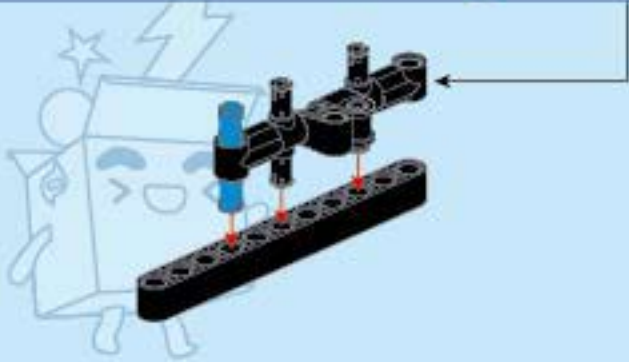
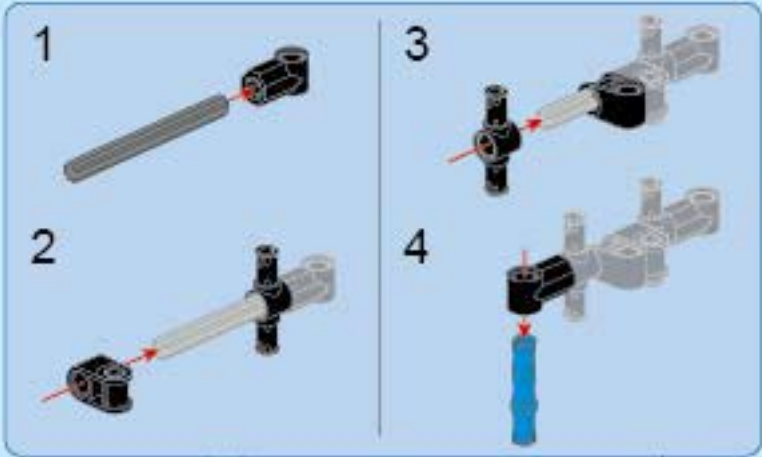
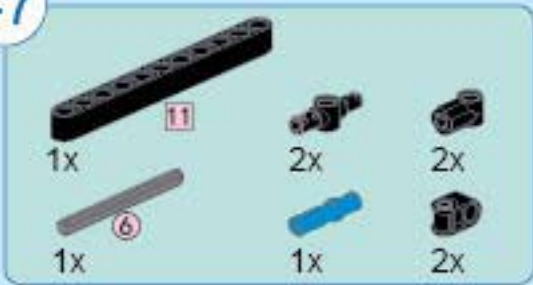

48

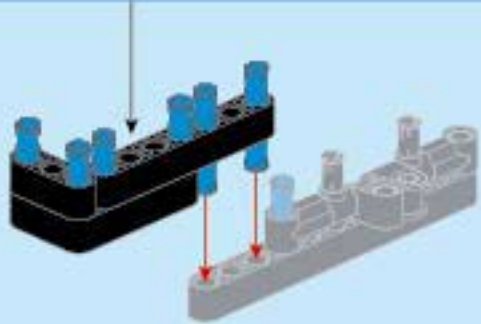
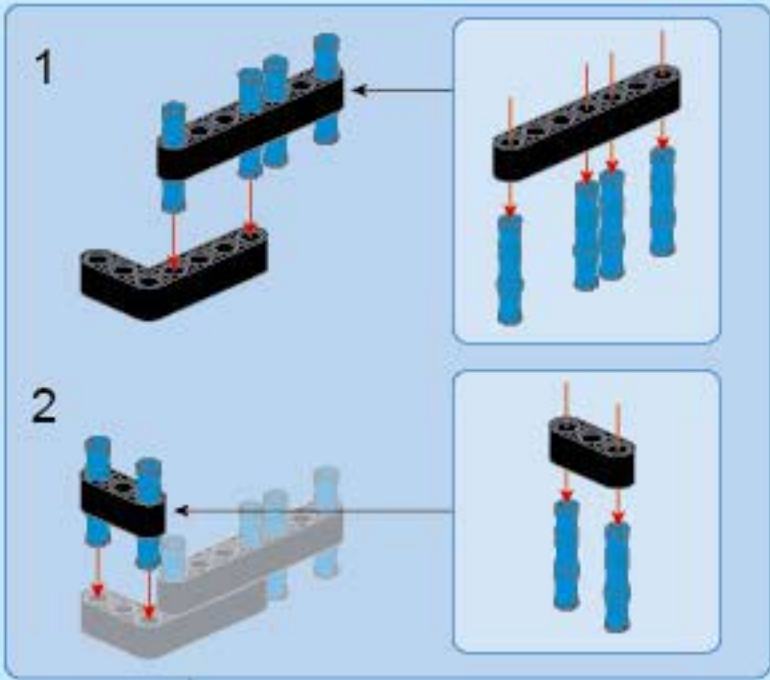

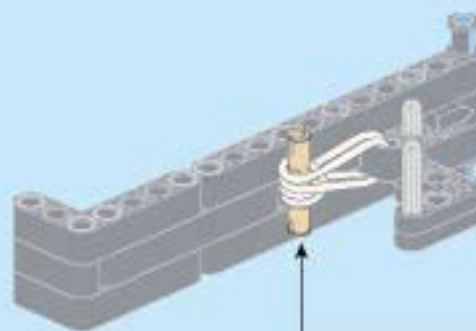
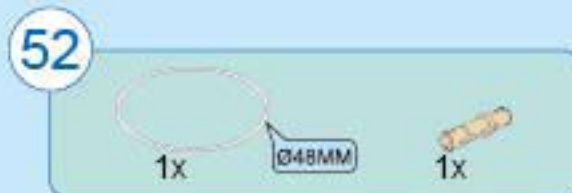
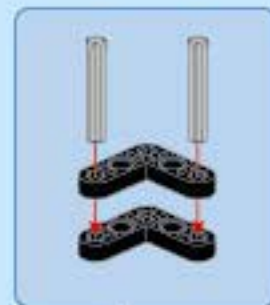
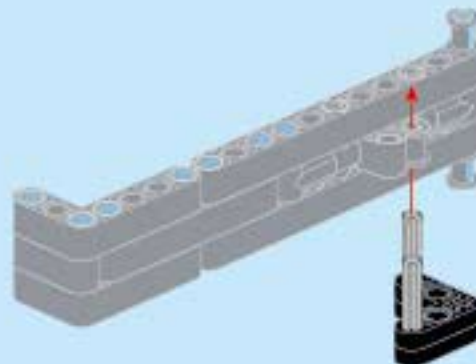
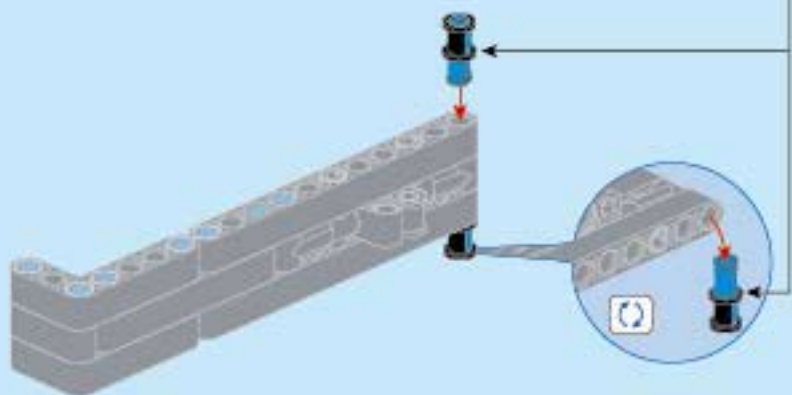
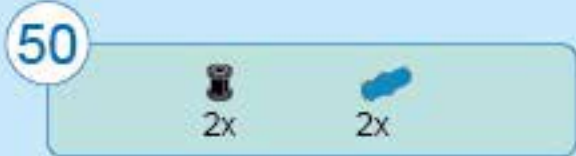
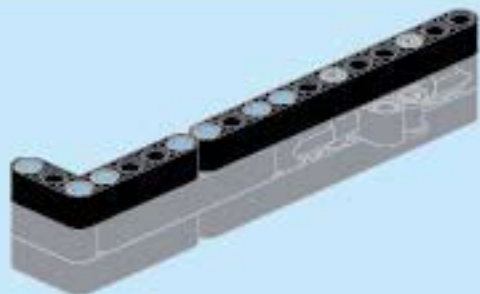
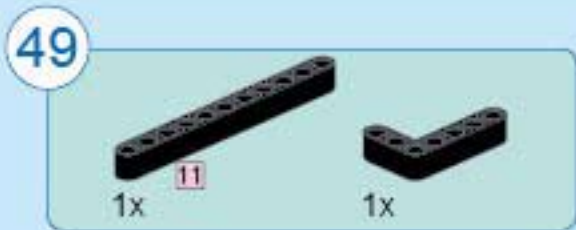

53

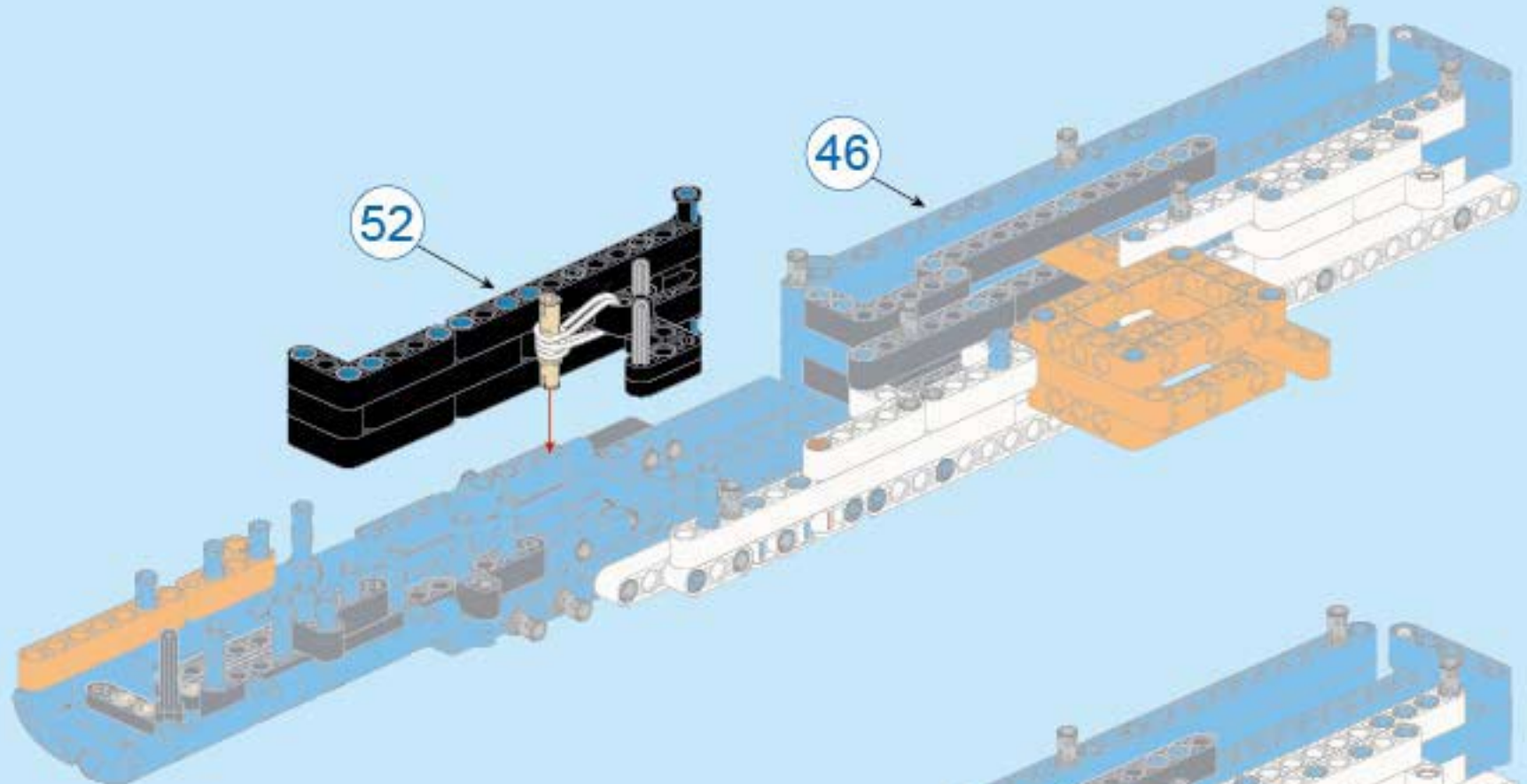

54

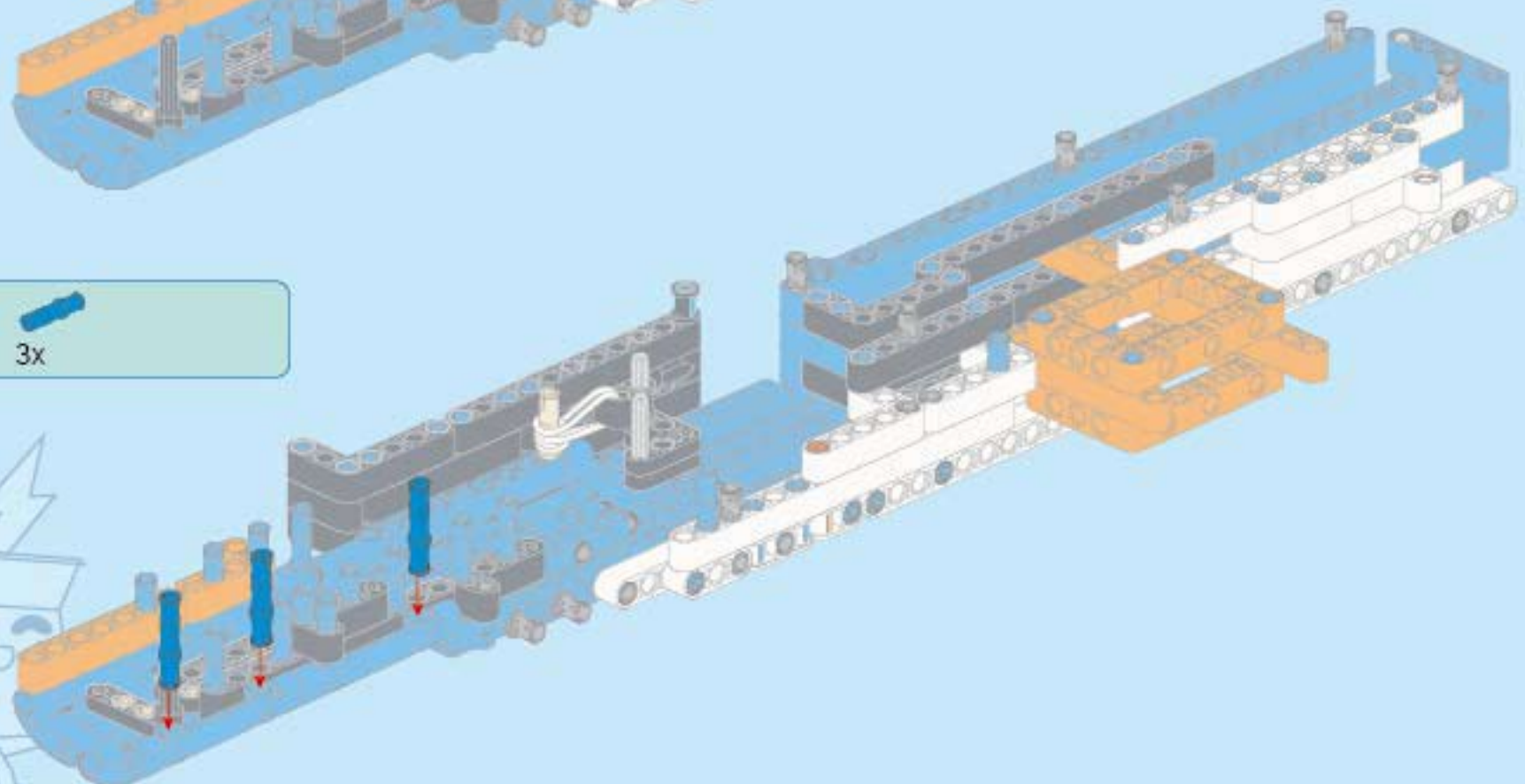
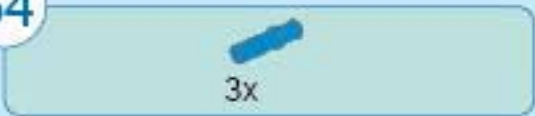

55

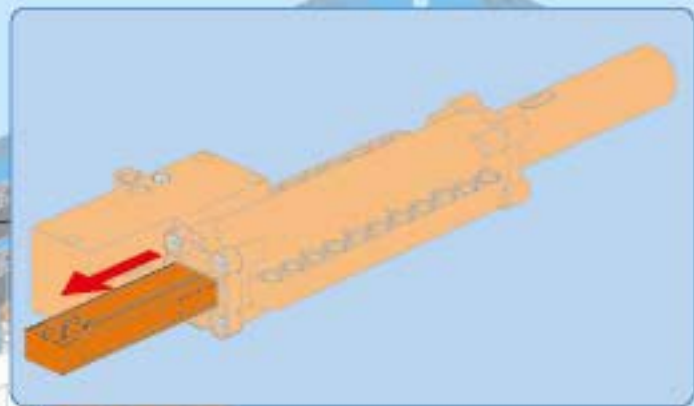
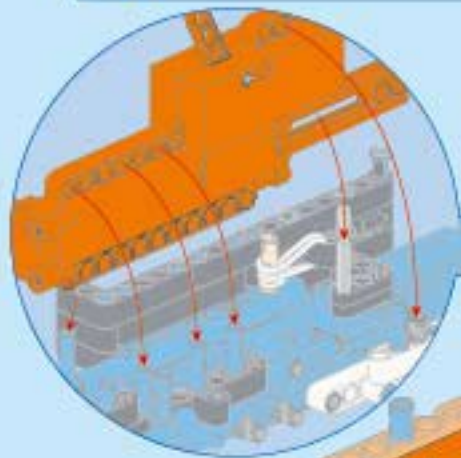
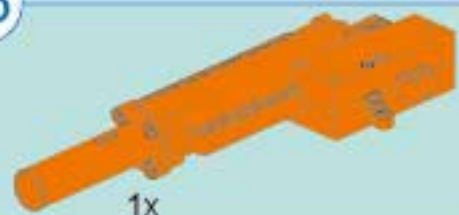

56

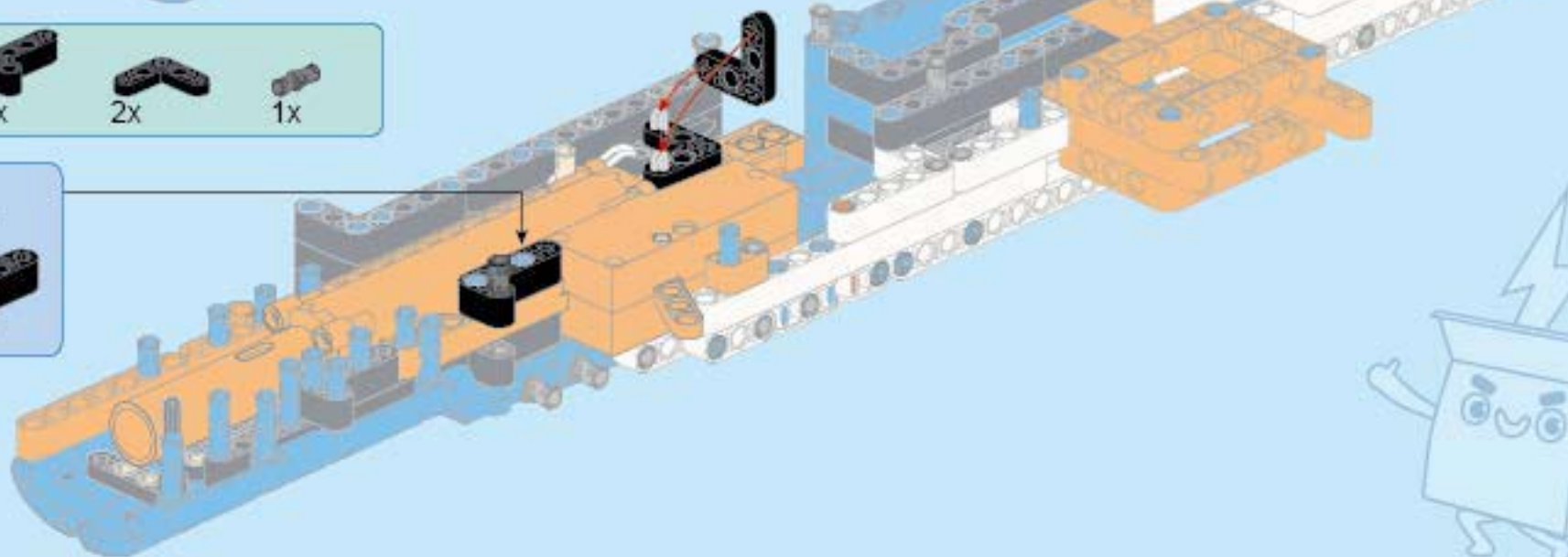

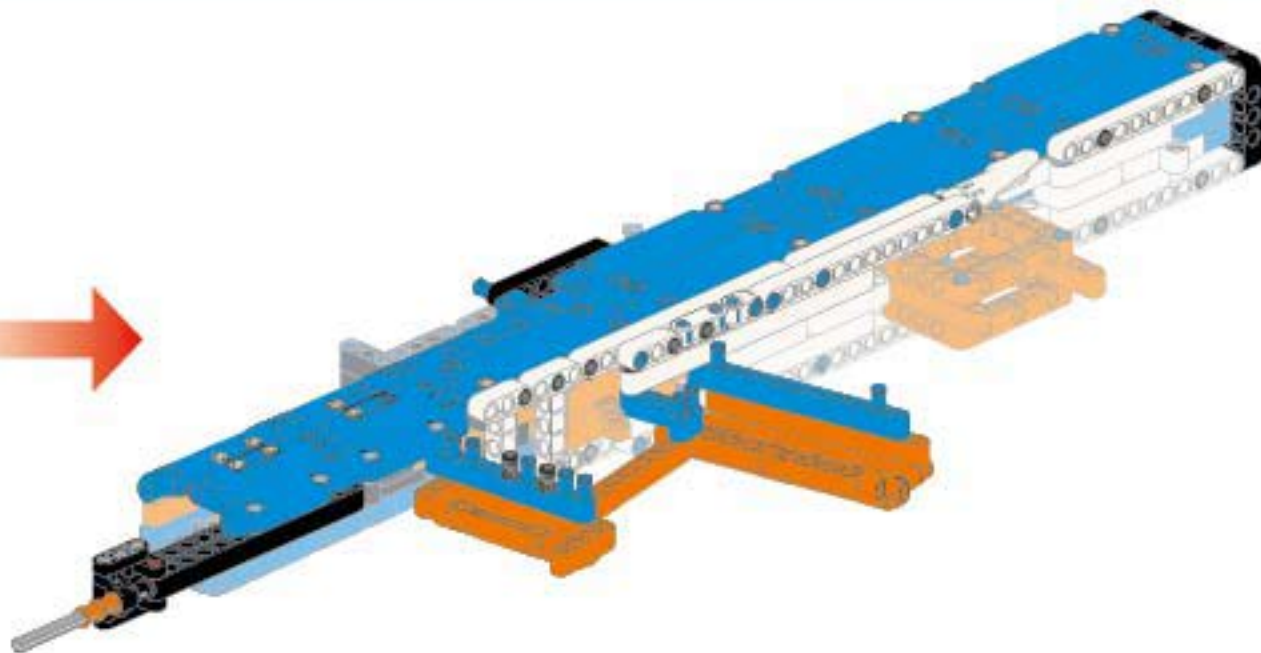

1x  ⑧ 1:1



57



58



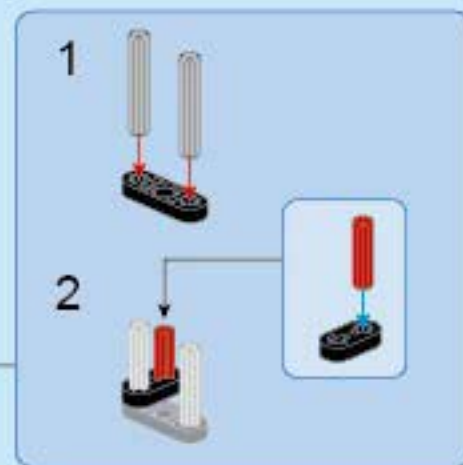
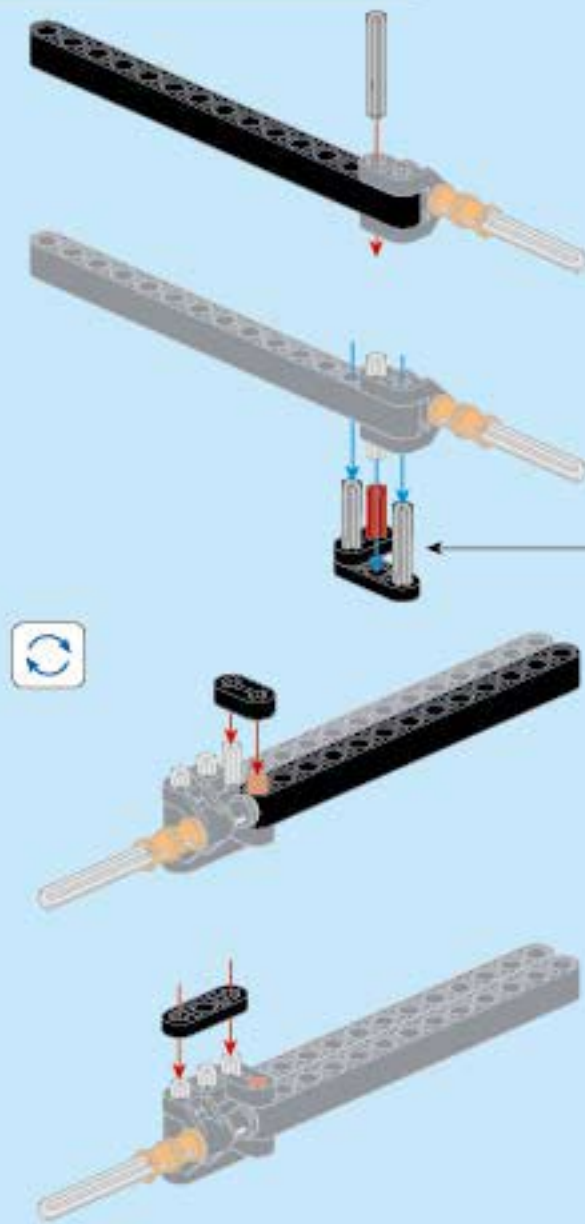
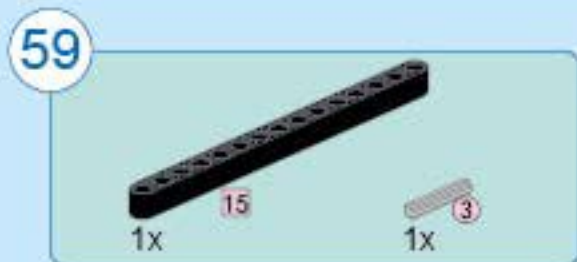
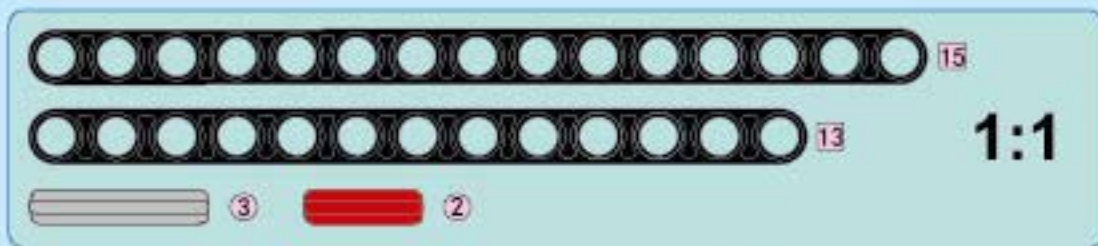

63



1x

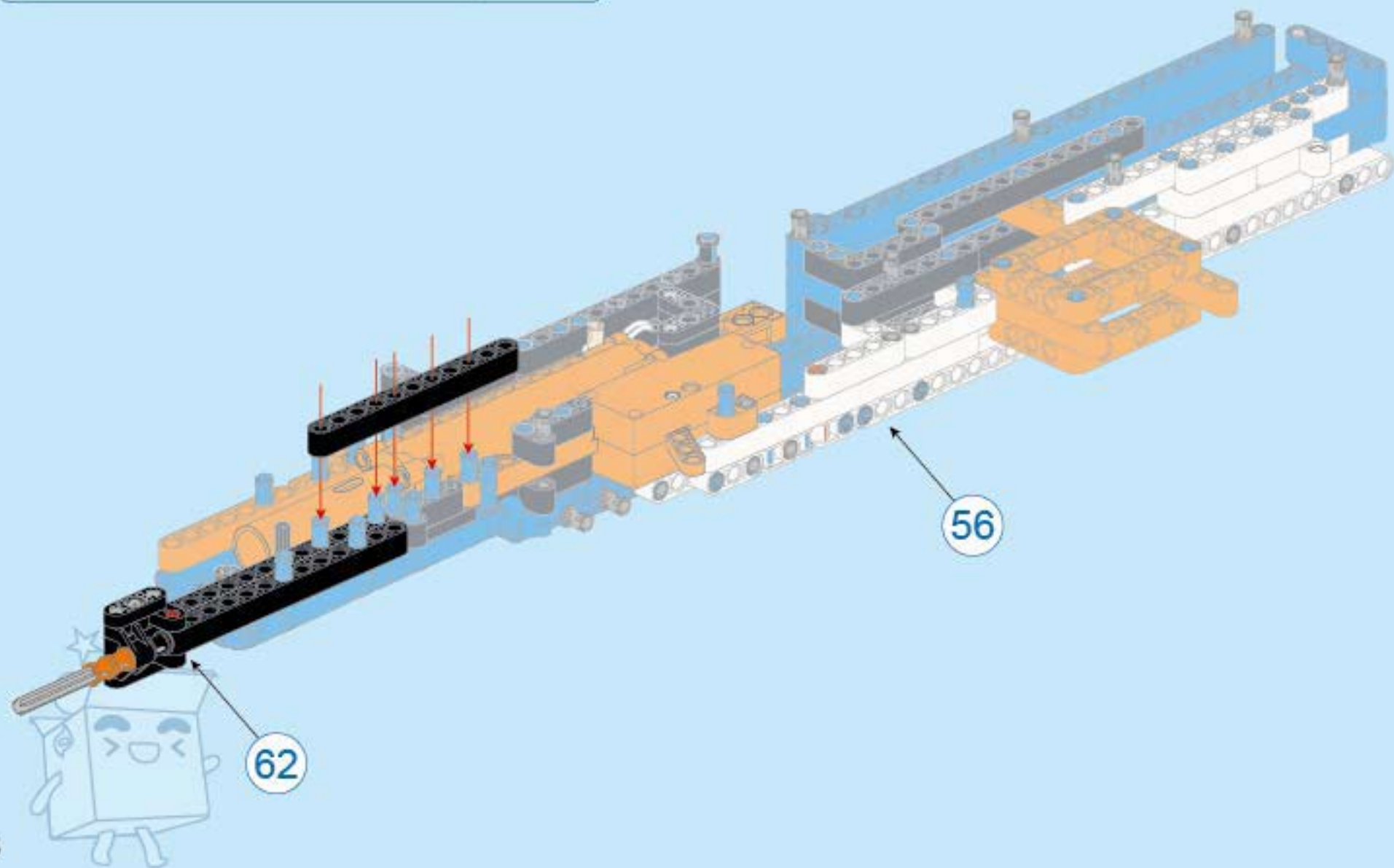

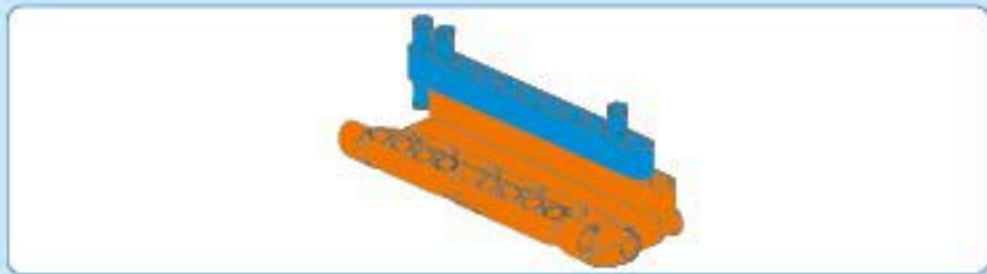

64

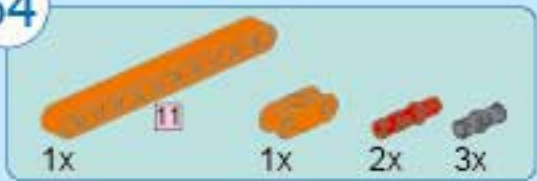

65

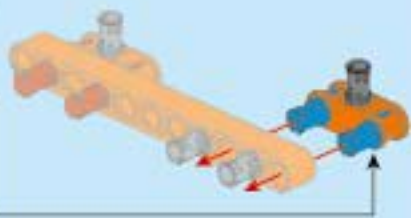
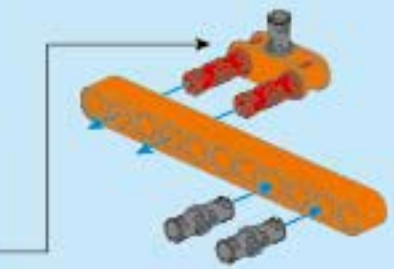
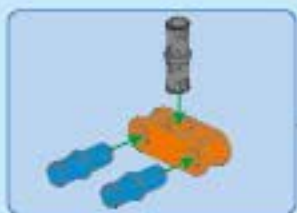
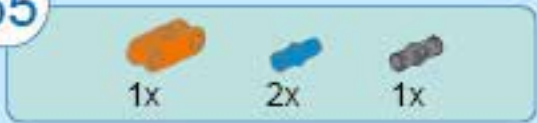

66

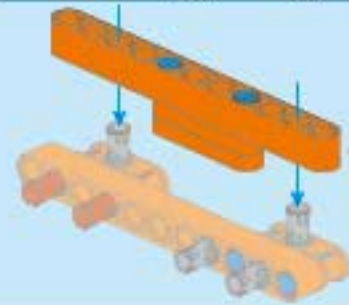
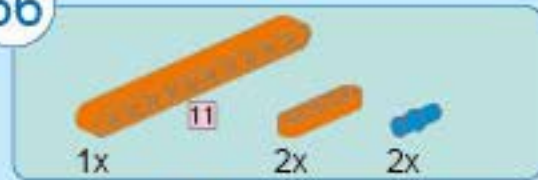

67

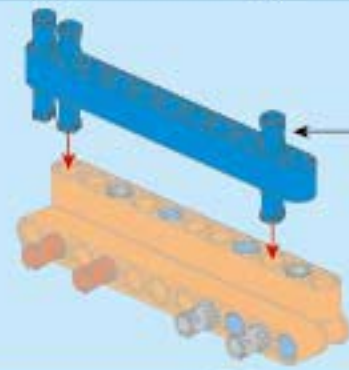

68

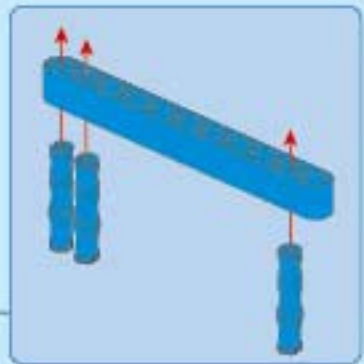
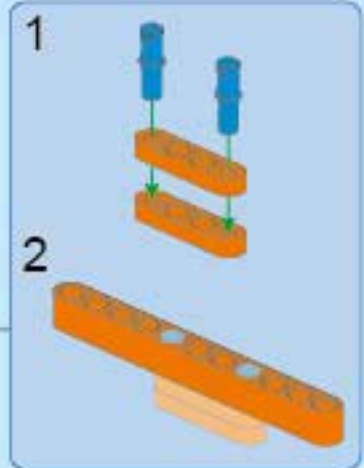
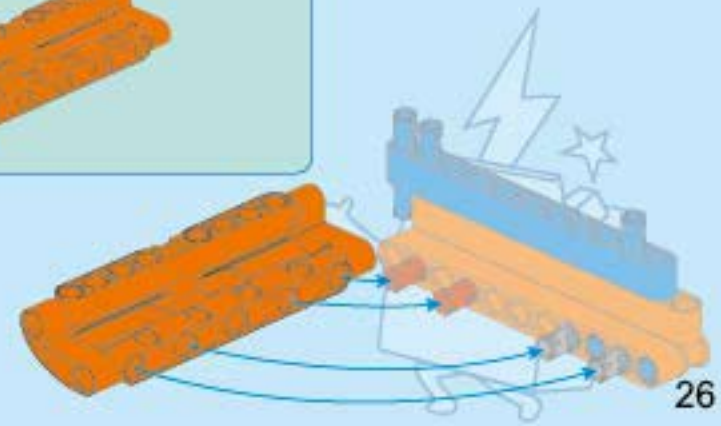
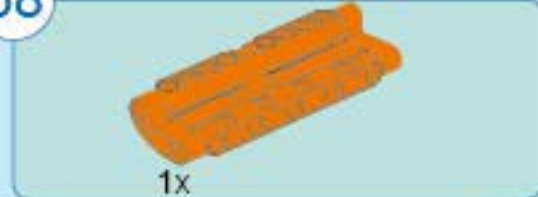

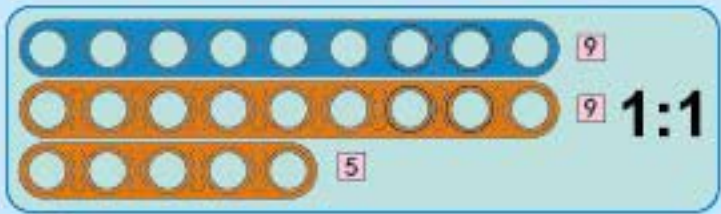
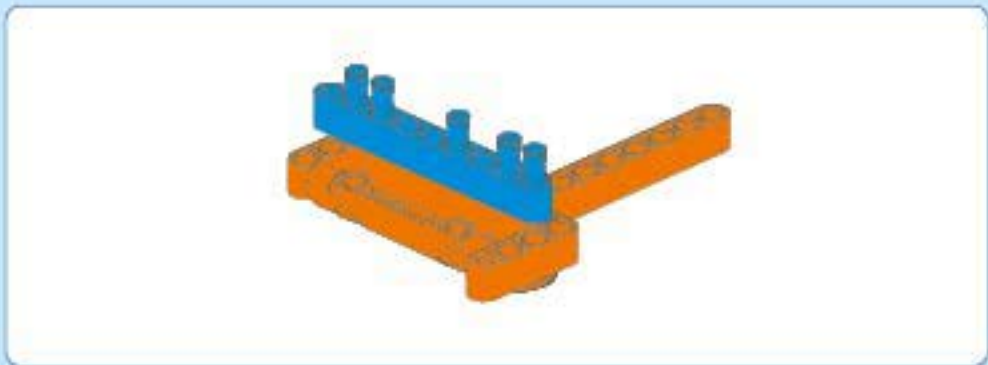

69

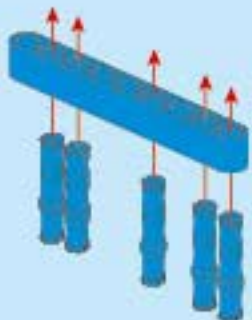
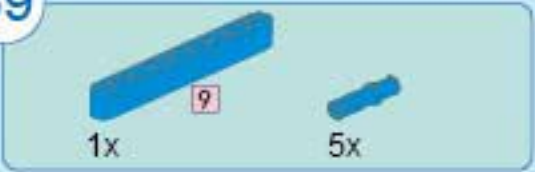

70

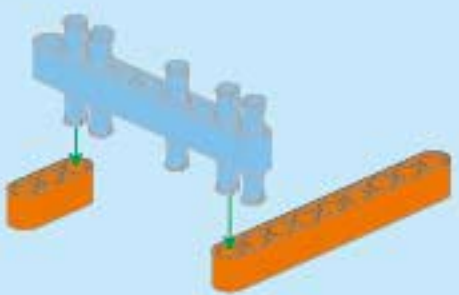
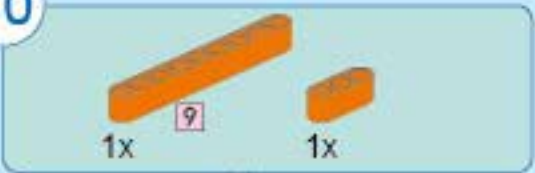

71

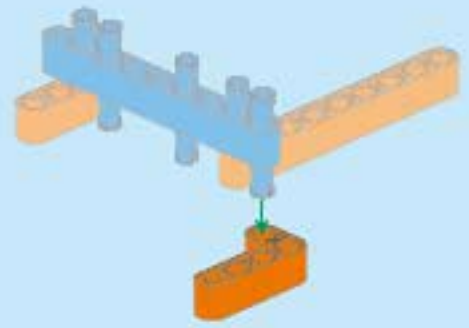

72

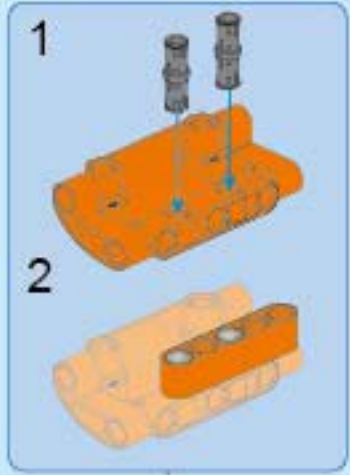
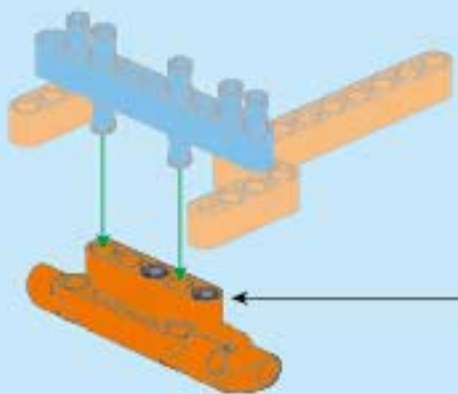
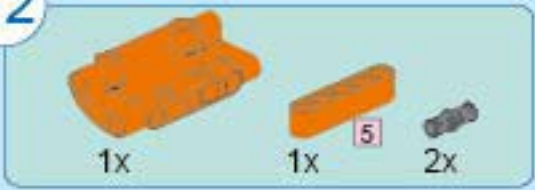

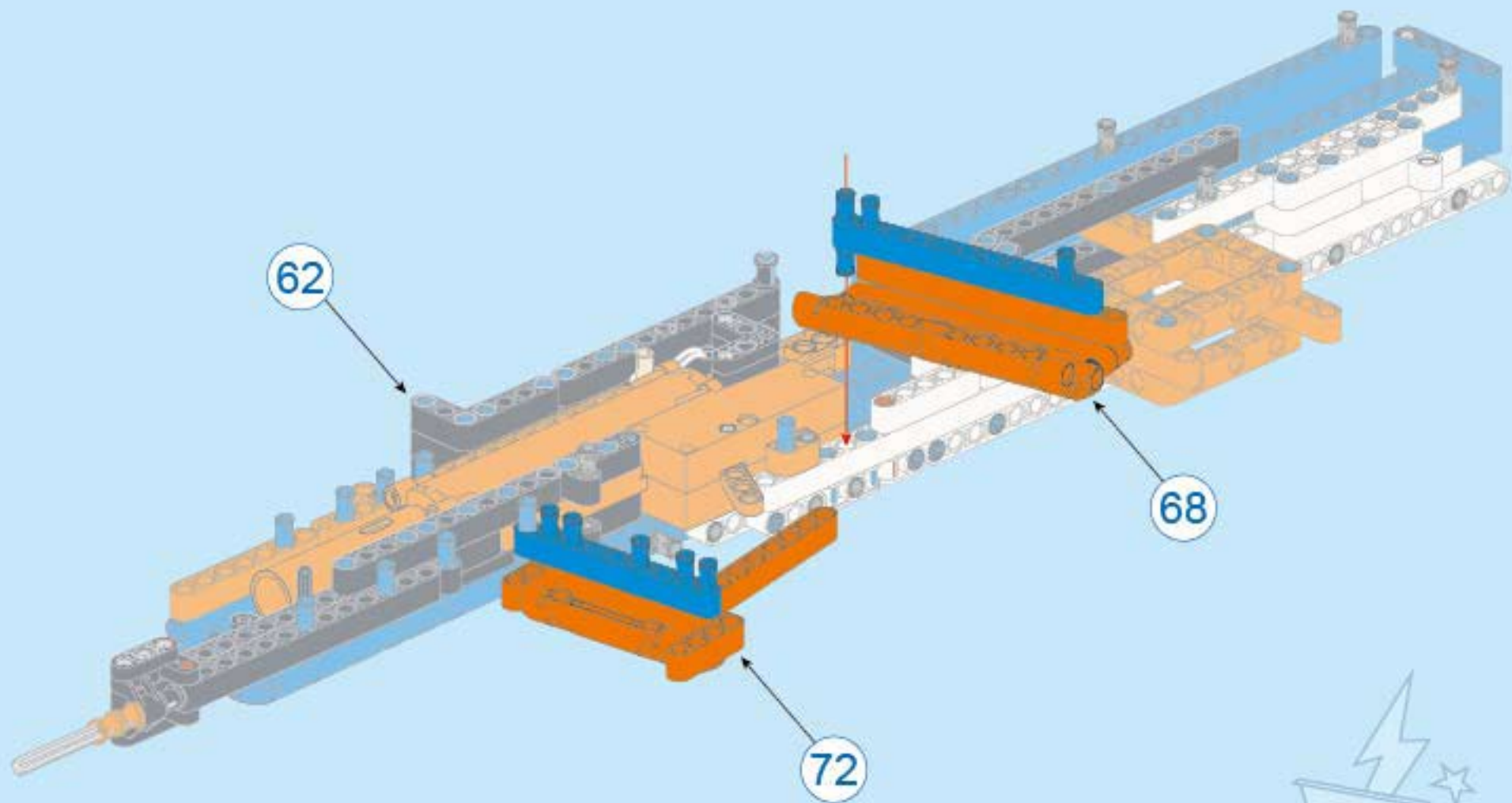

74



1x



2x



1x

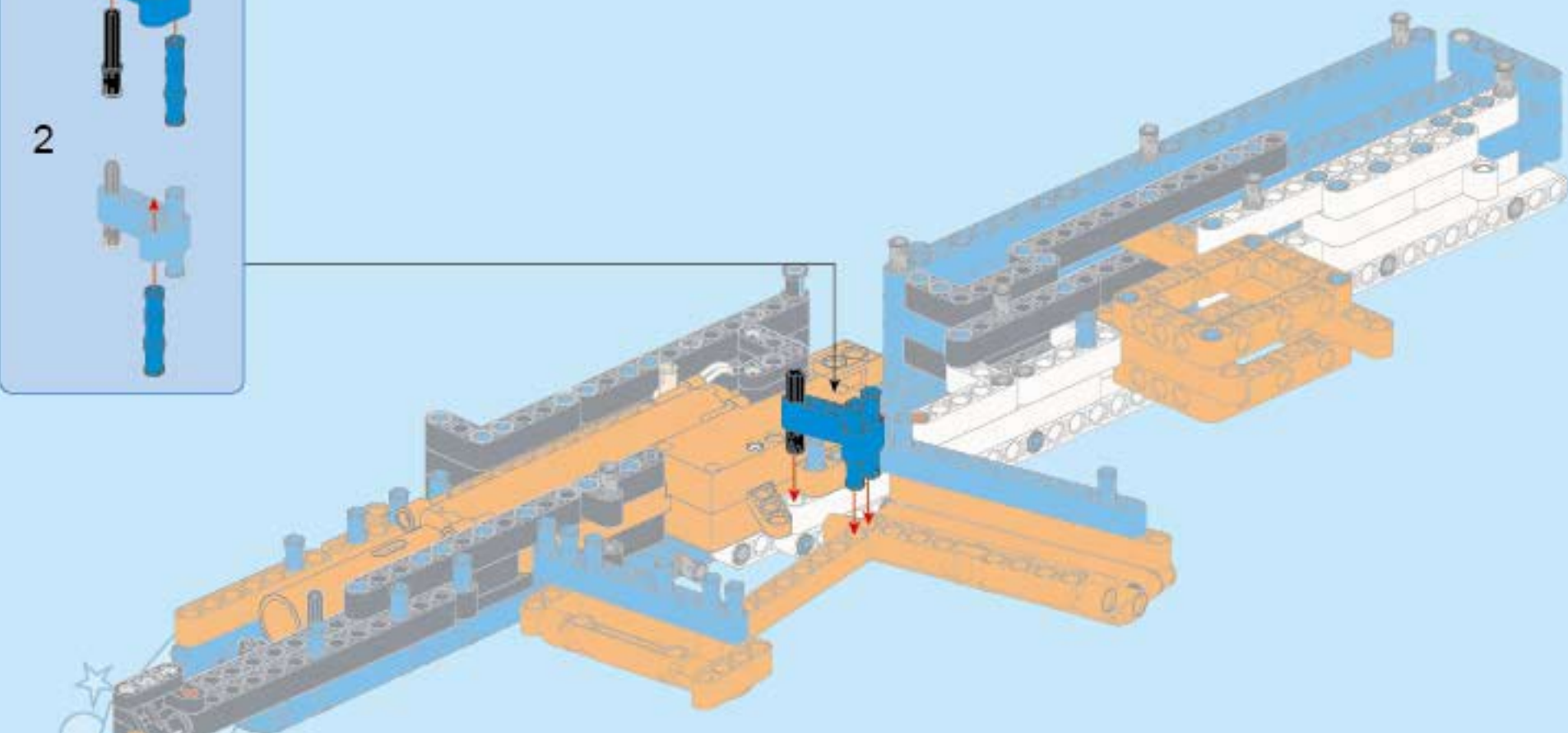
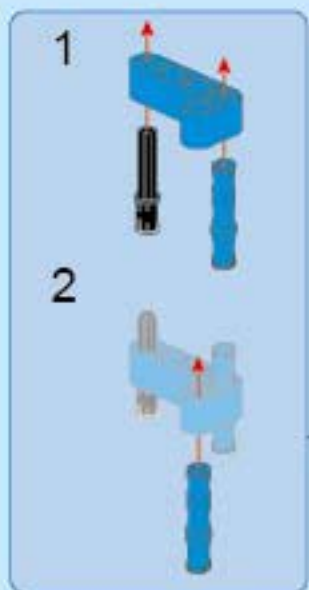

75

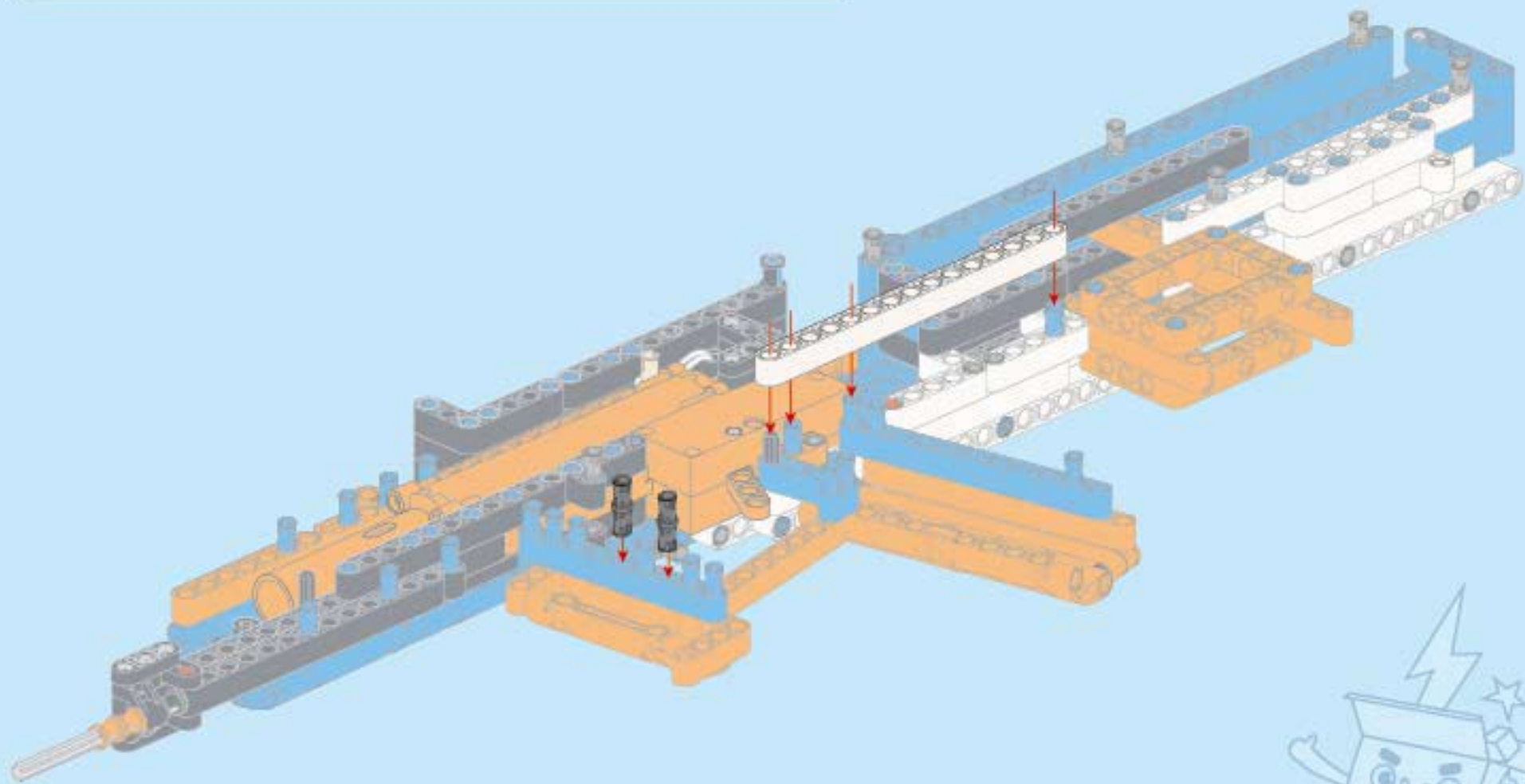

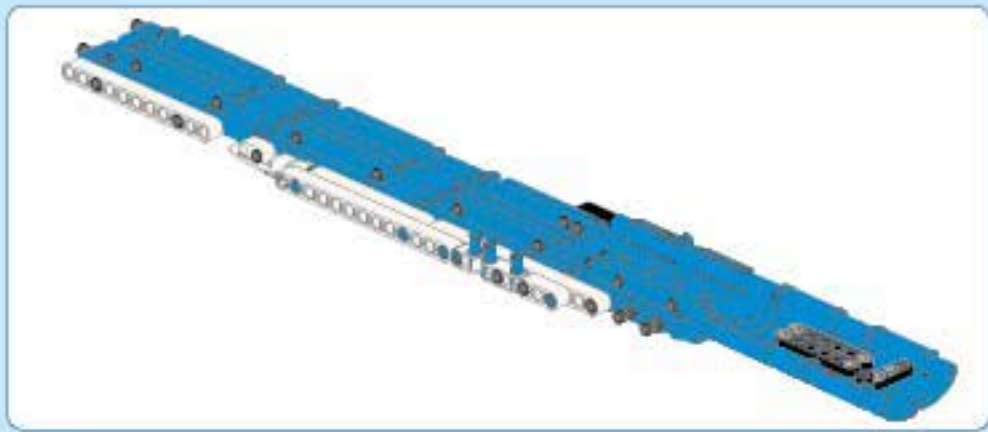

76

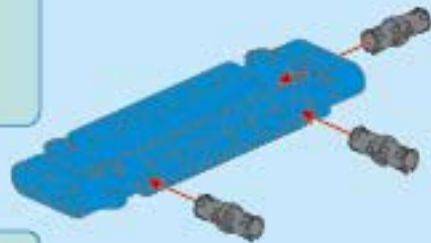

77



78

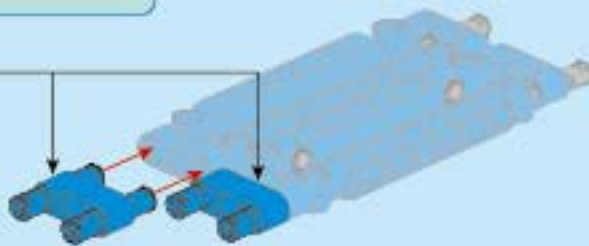
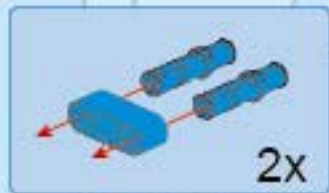

31

79

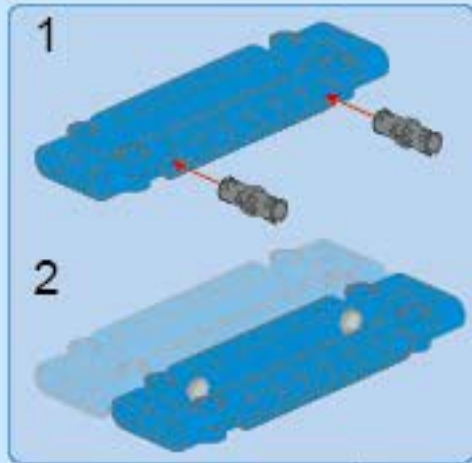

80

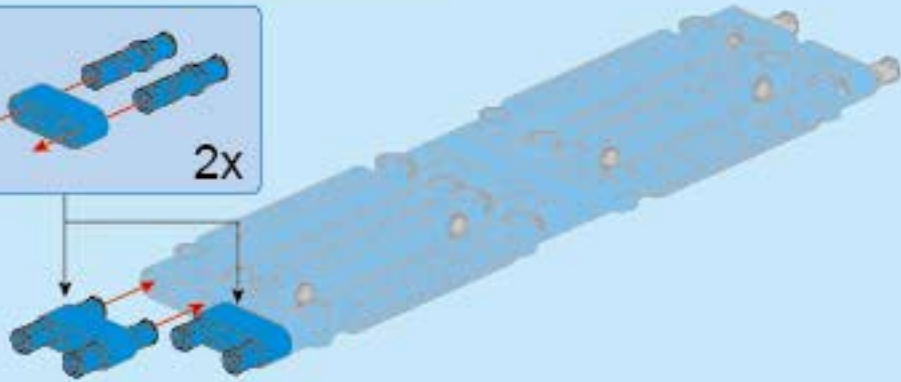
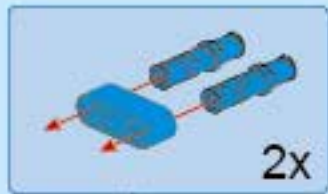

81

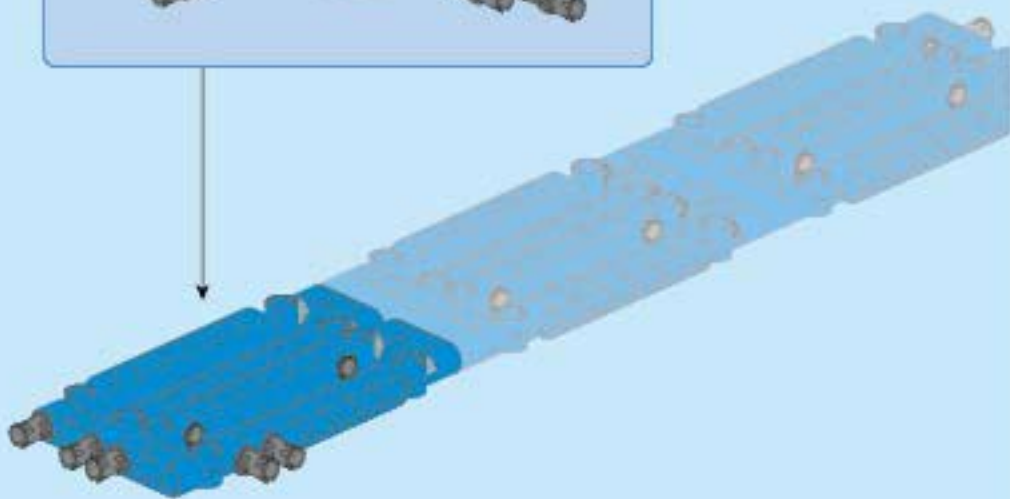
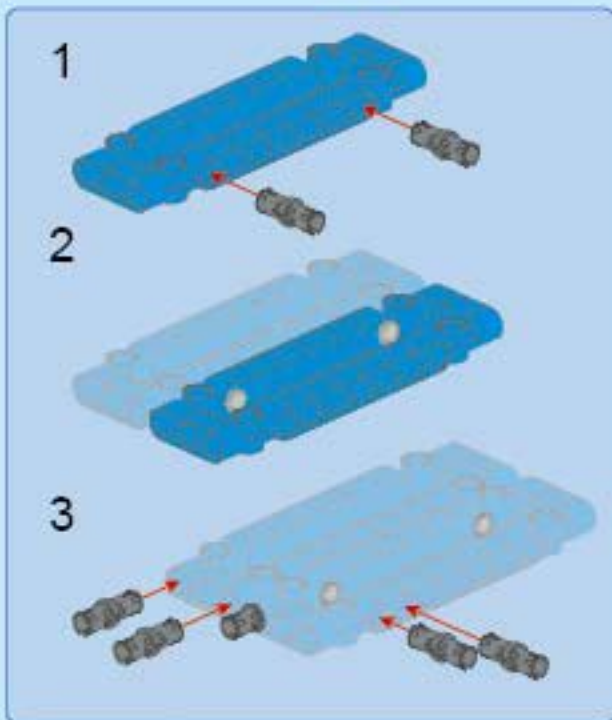

82

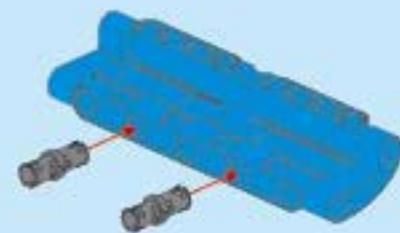
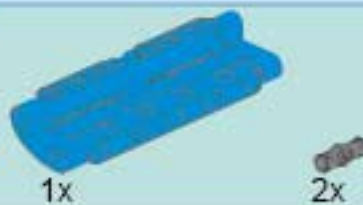

83

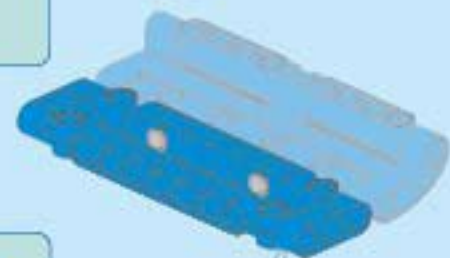

84

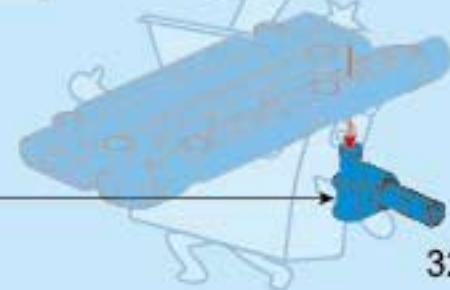
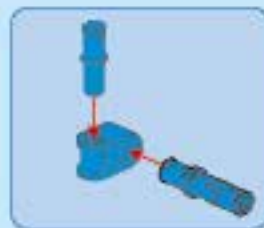



85



86

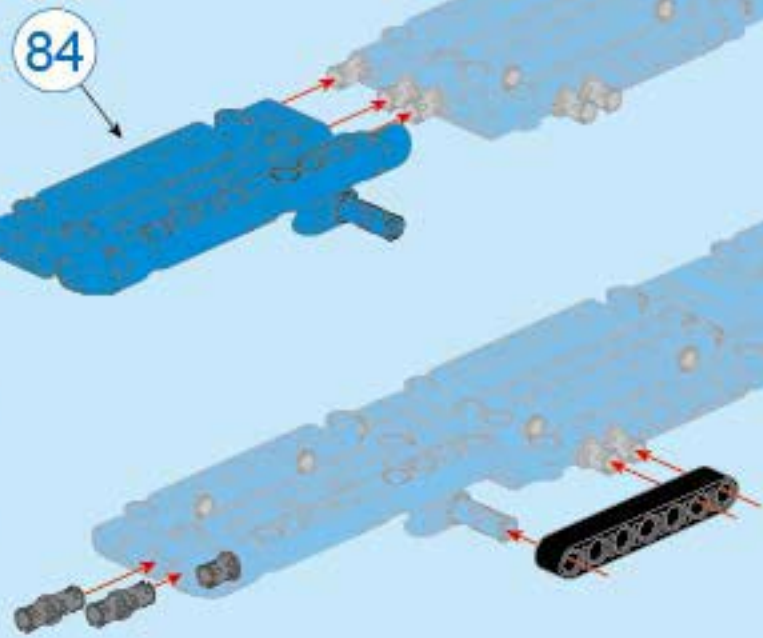

87

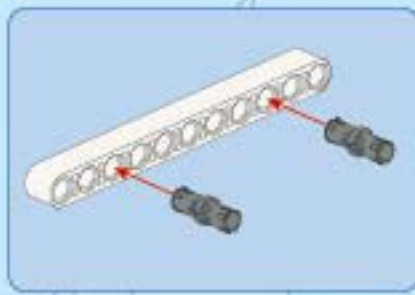

9 1:1

88

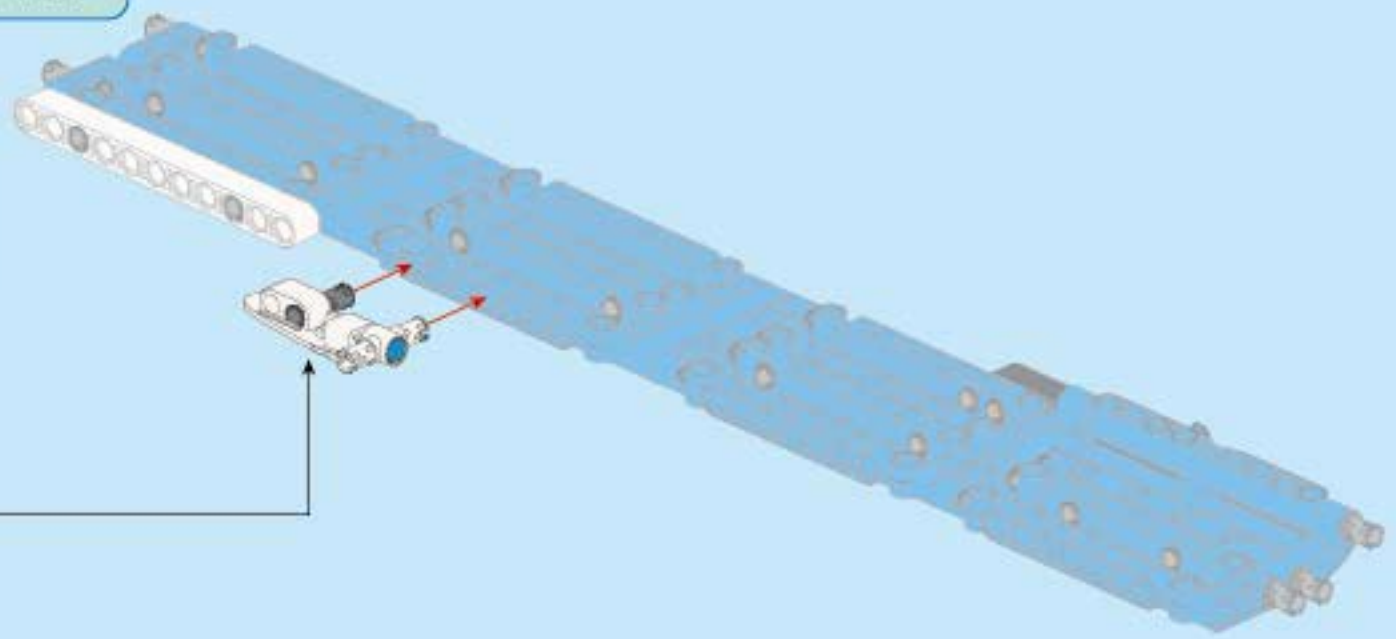
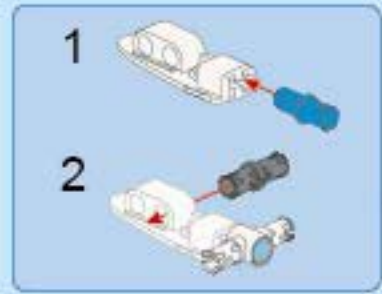

89

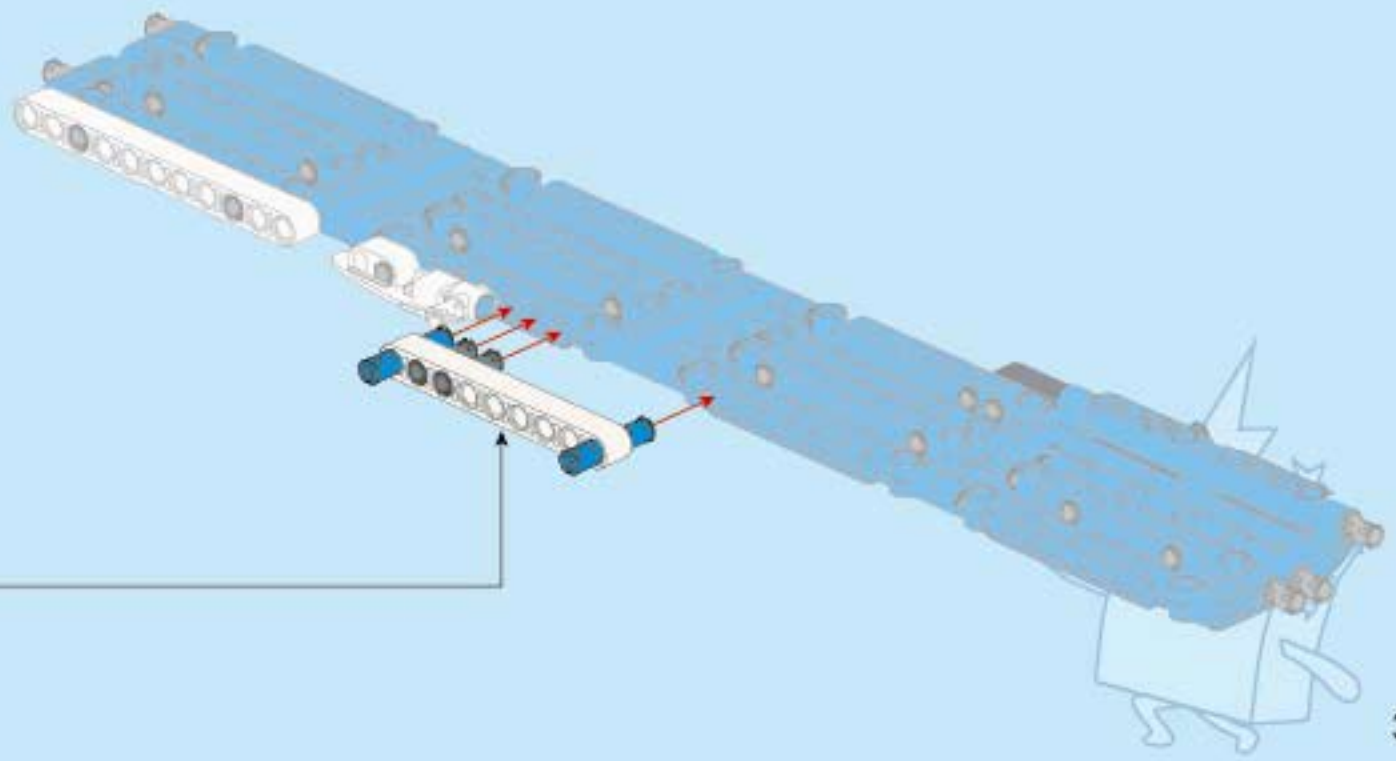
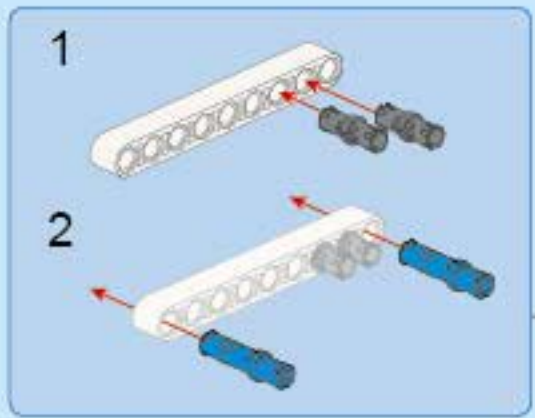
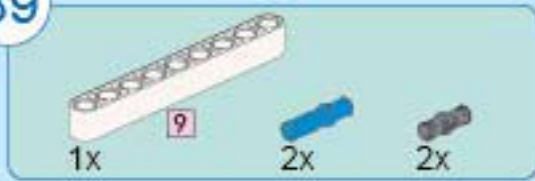



90

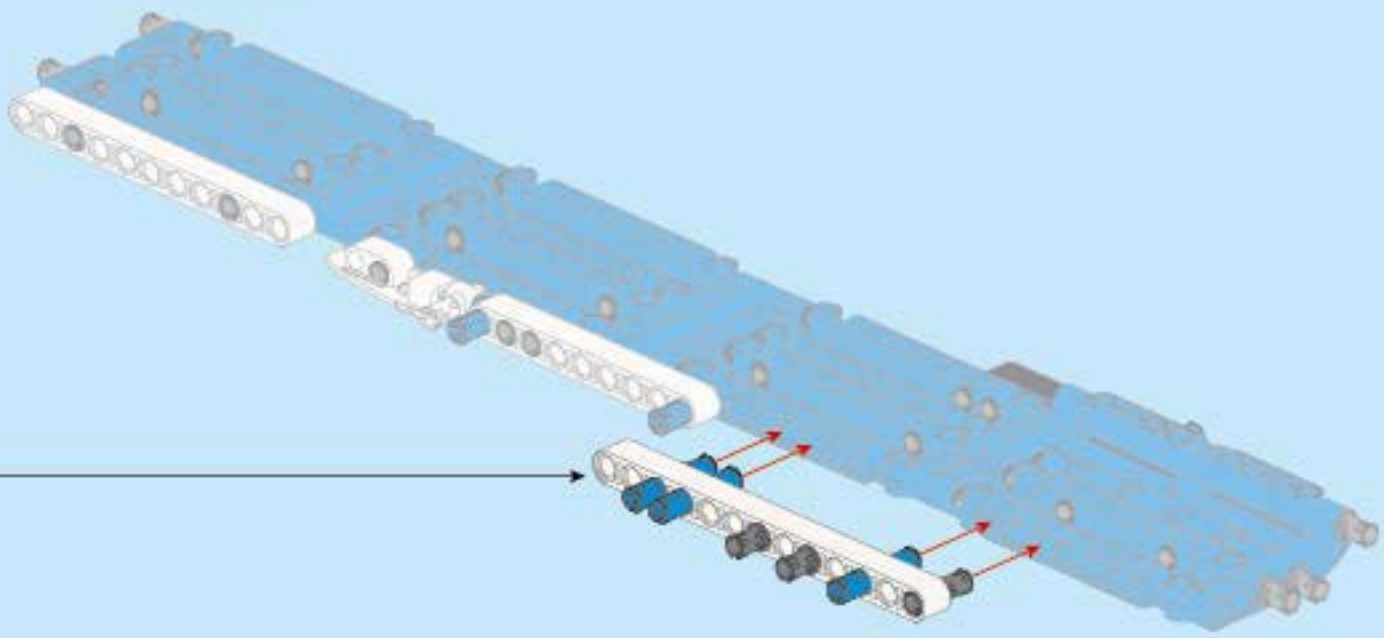
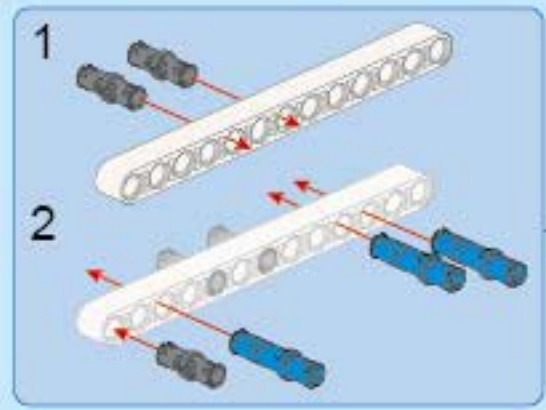
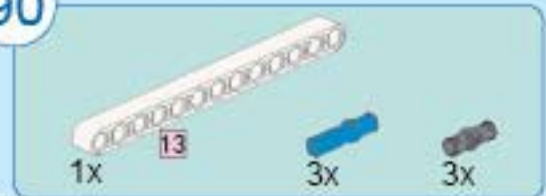

91

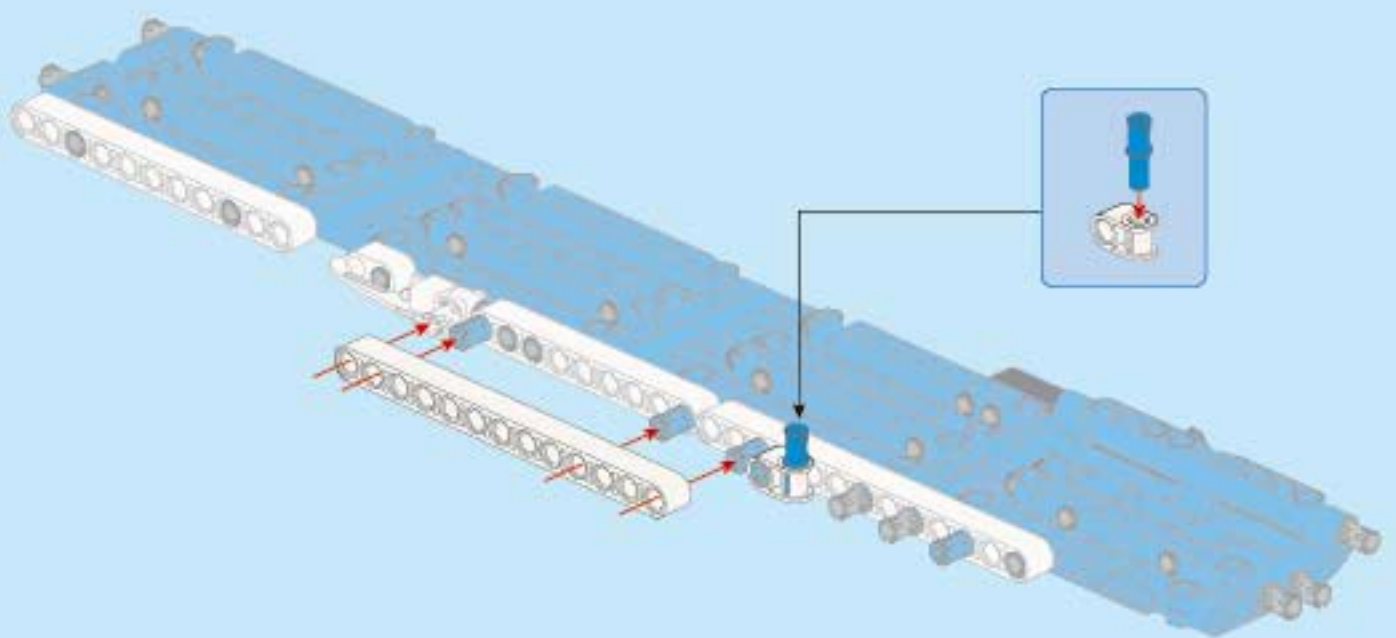



92

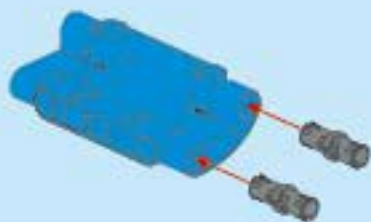

93

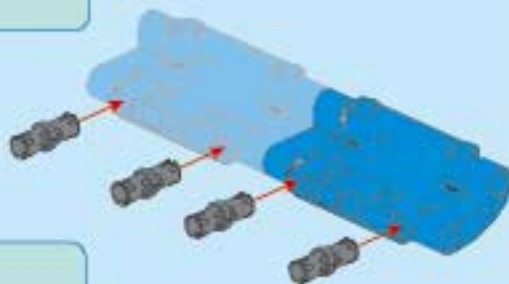

94

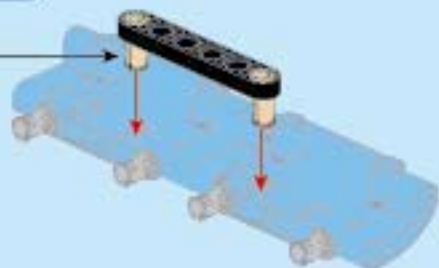

6 1:1

95

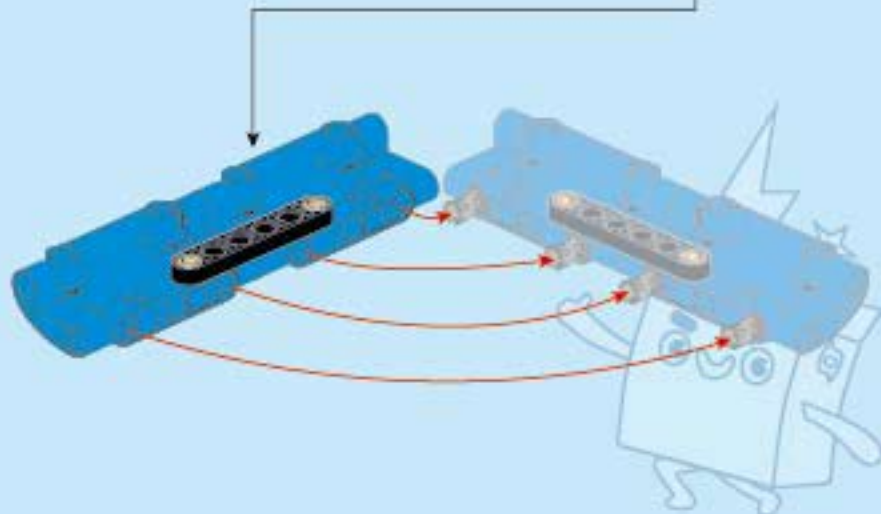
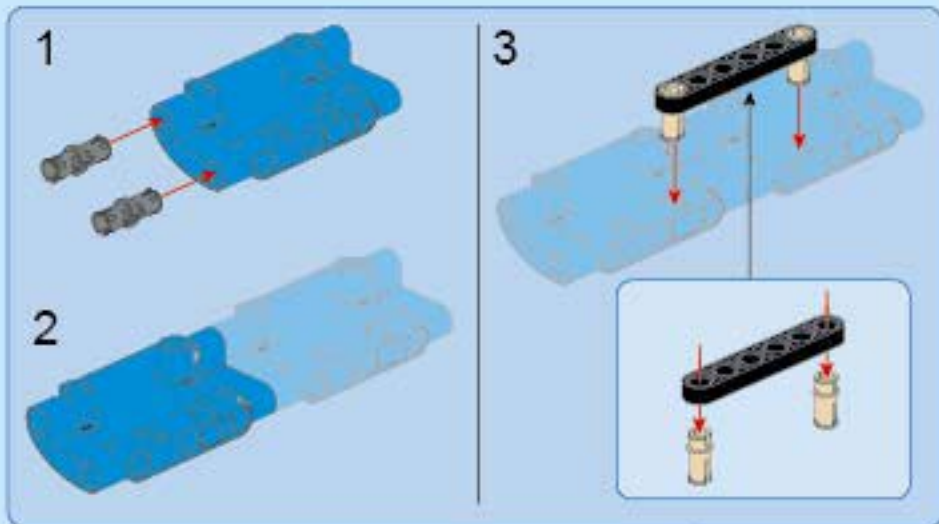

96

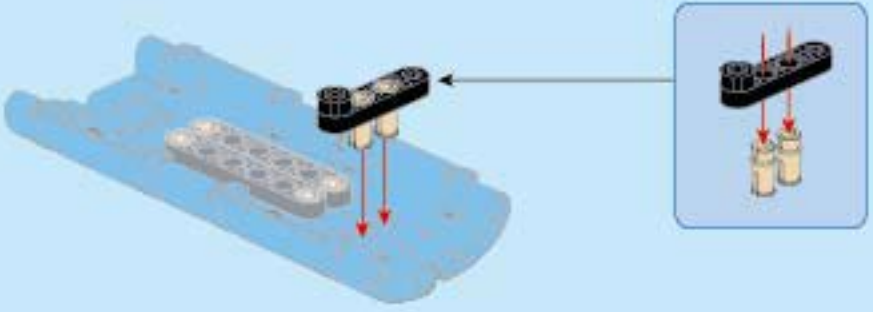

97

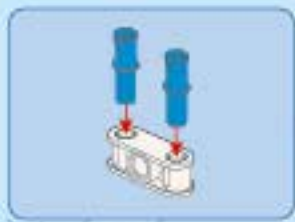
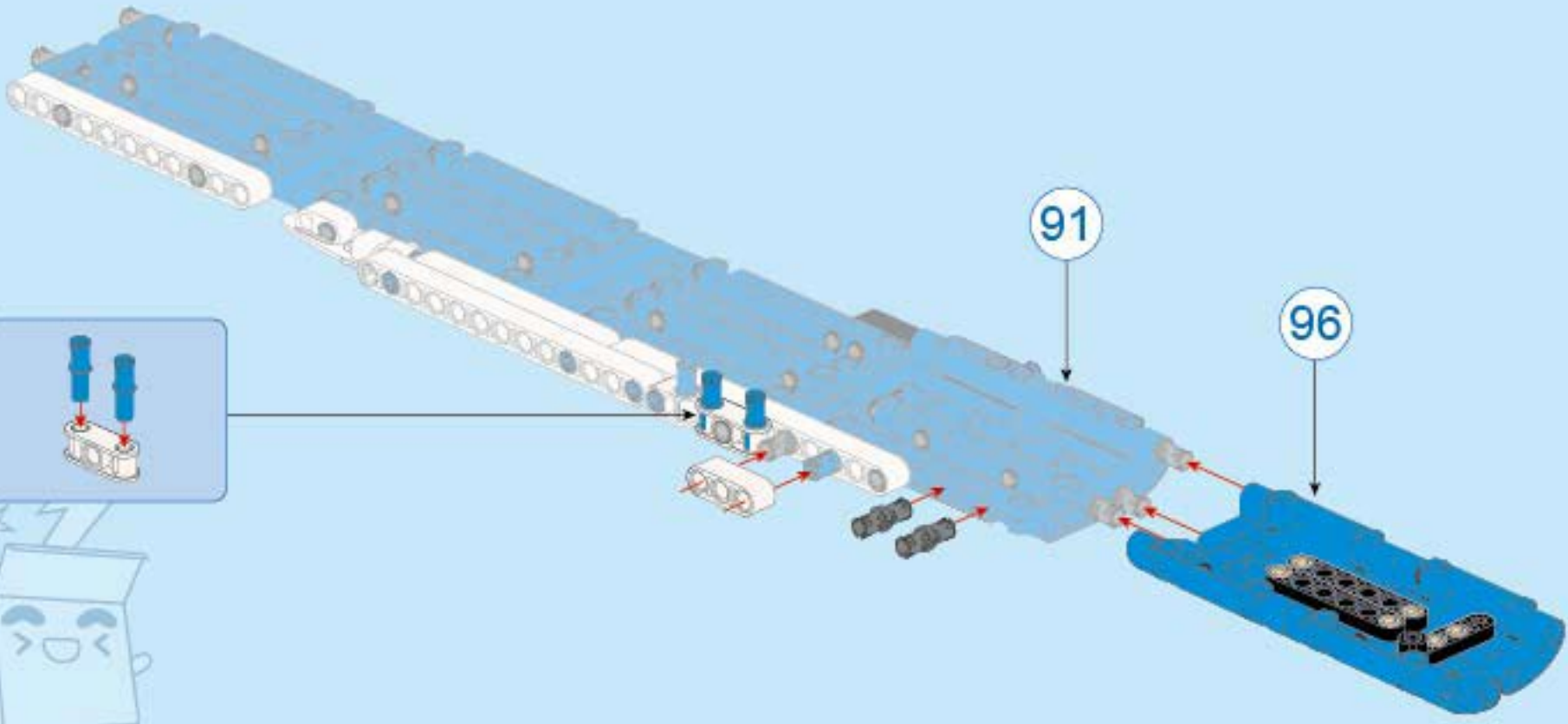

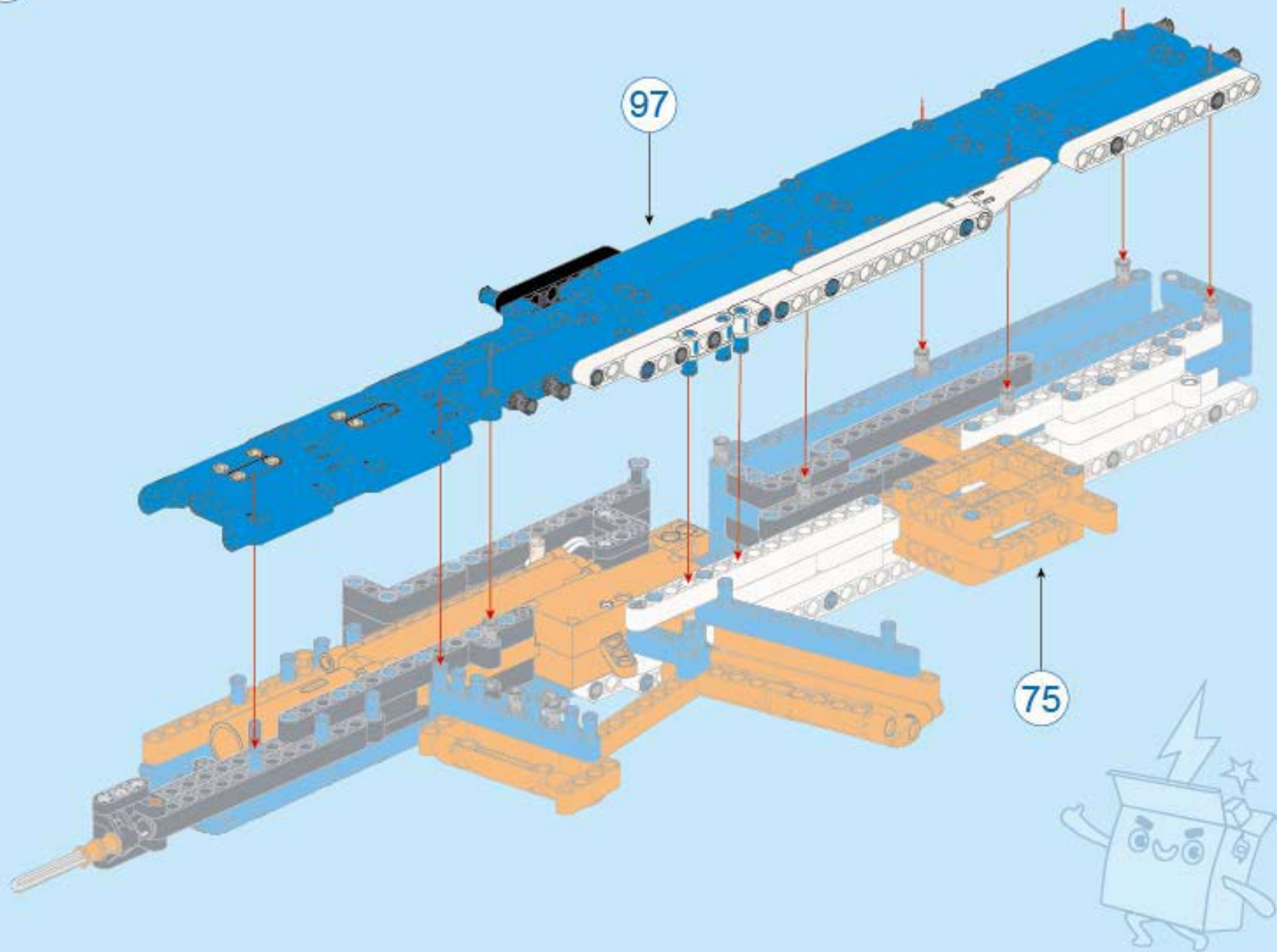

99

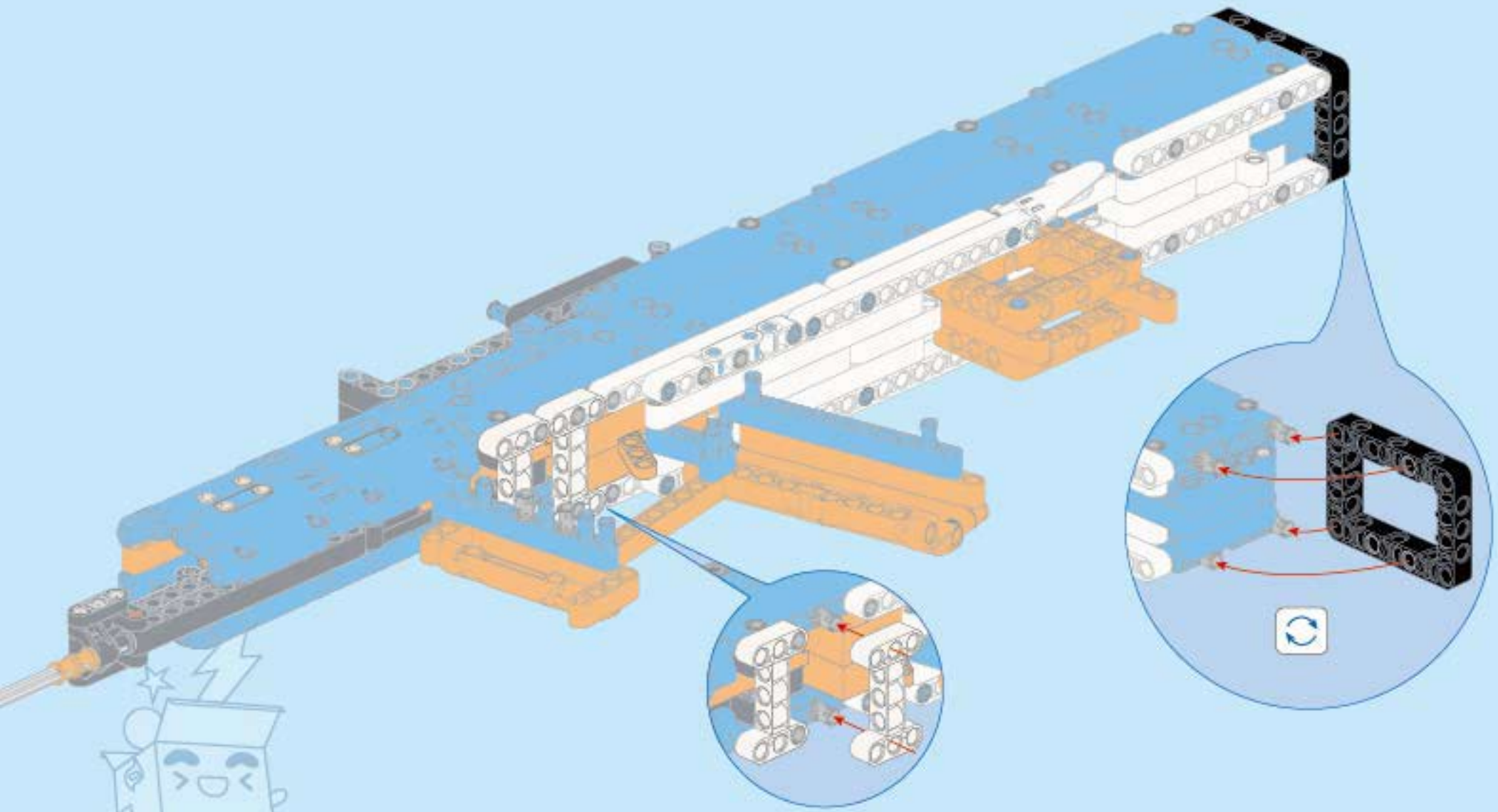

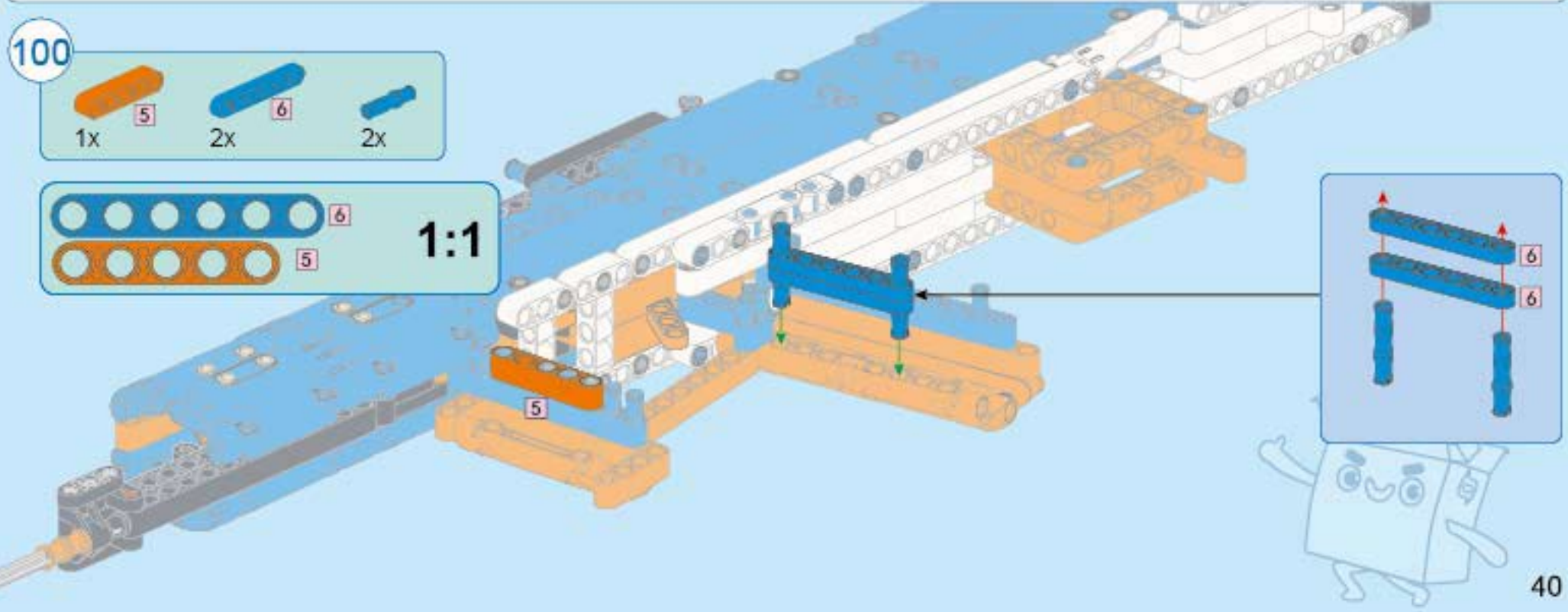
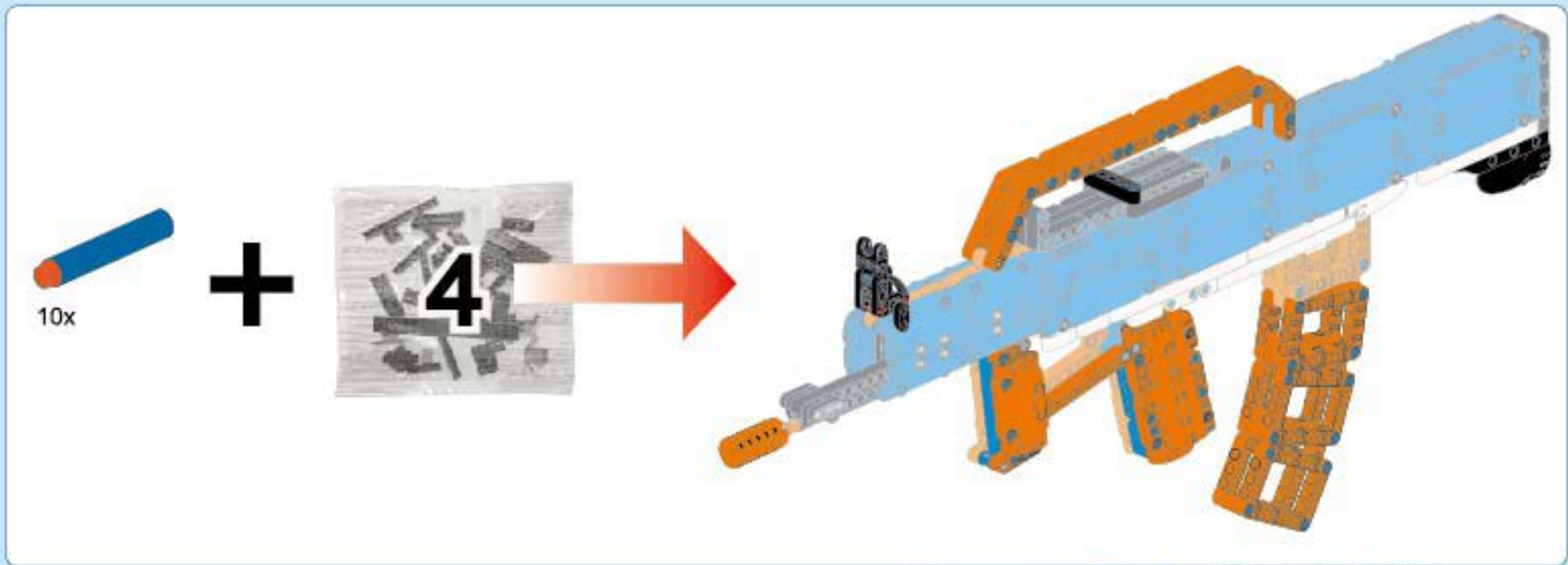

101



1x



1x



7x



2x

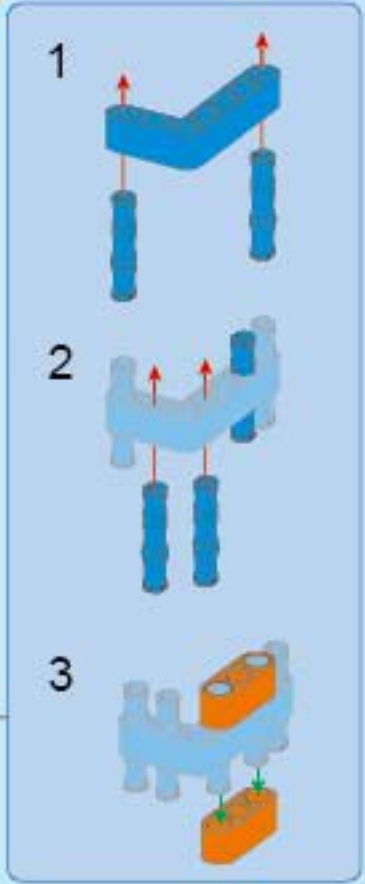
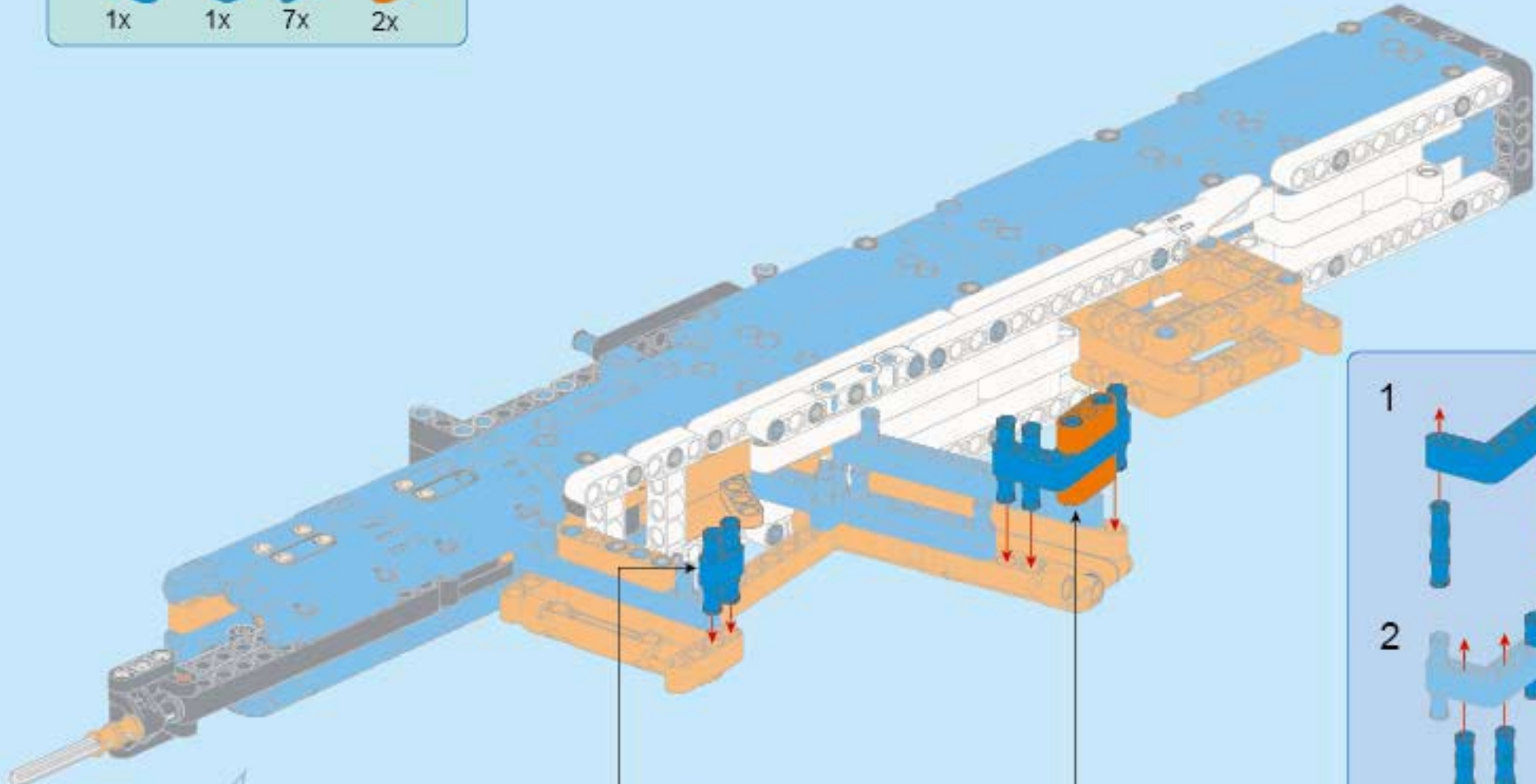

102

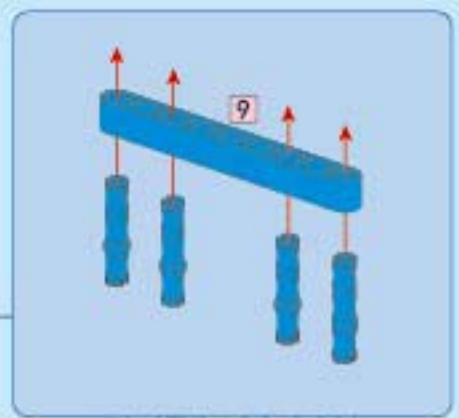
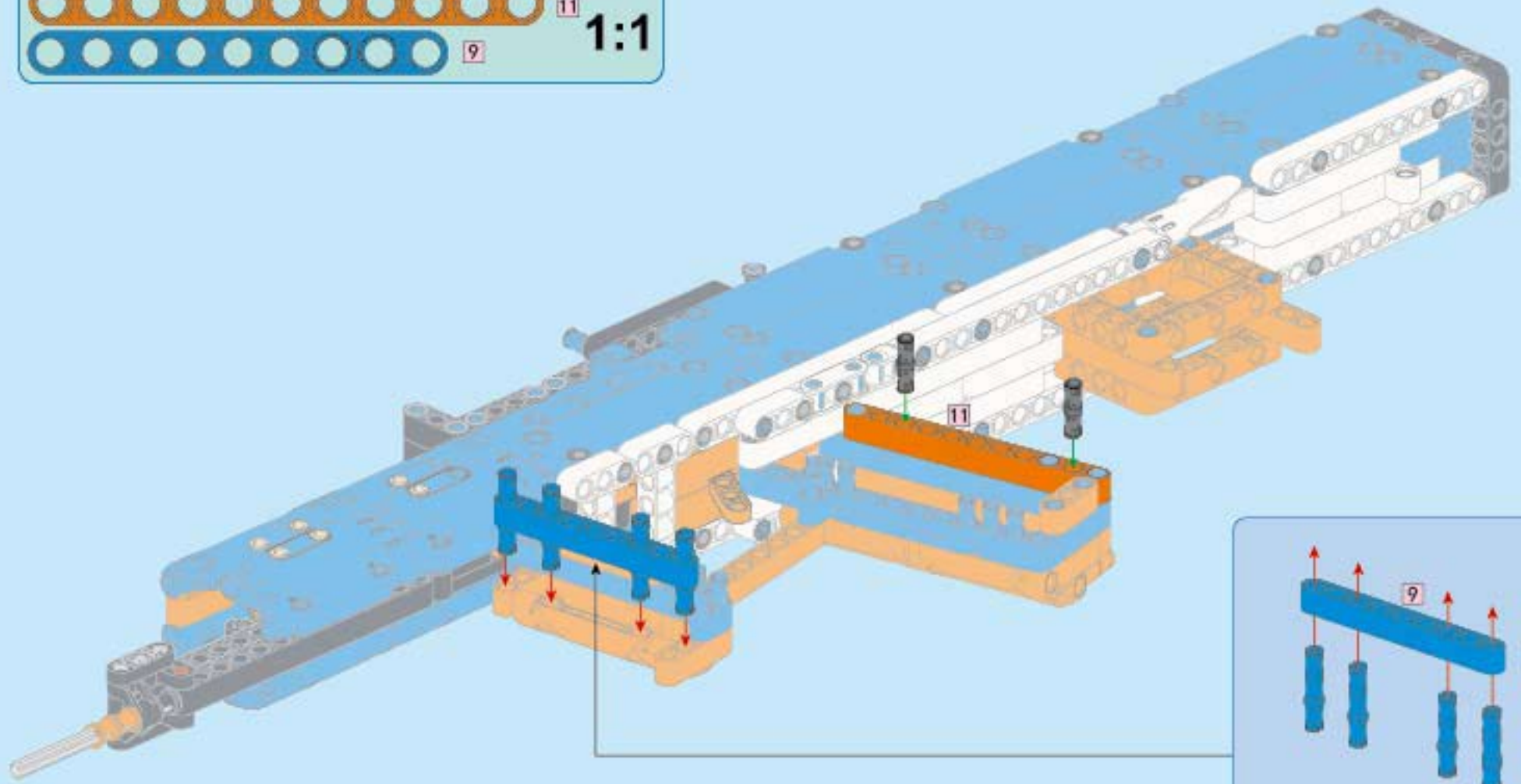
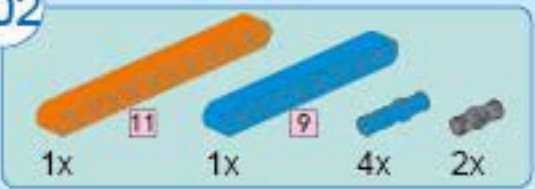

103

1x 2x 1x ③ 1x 2x

③ 1:1

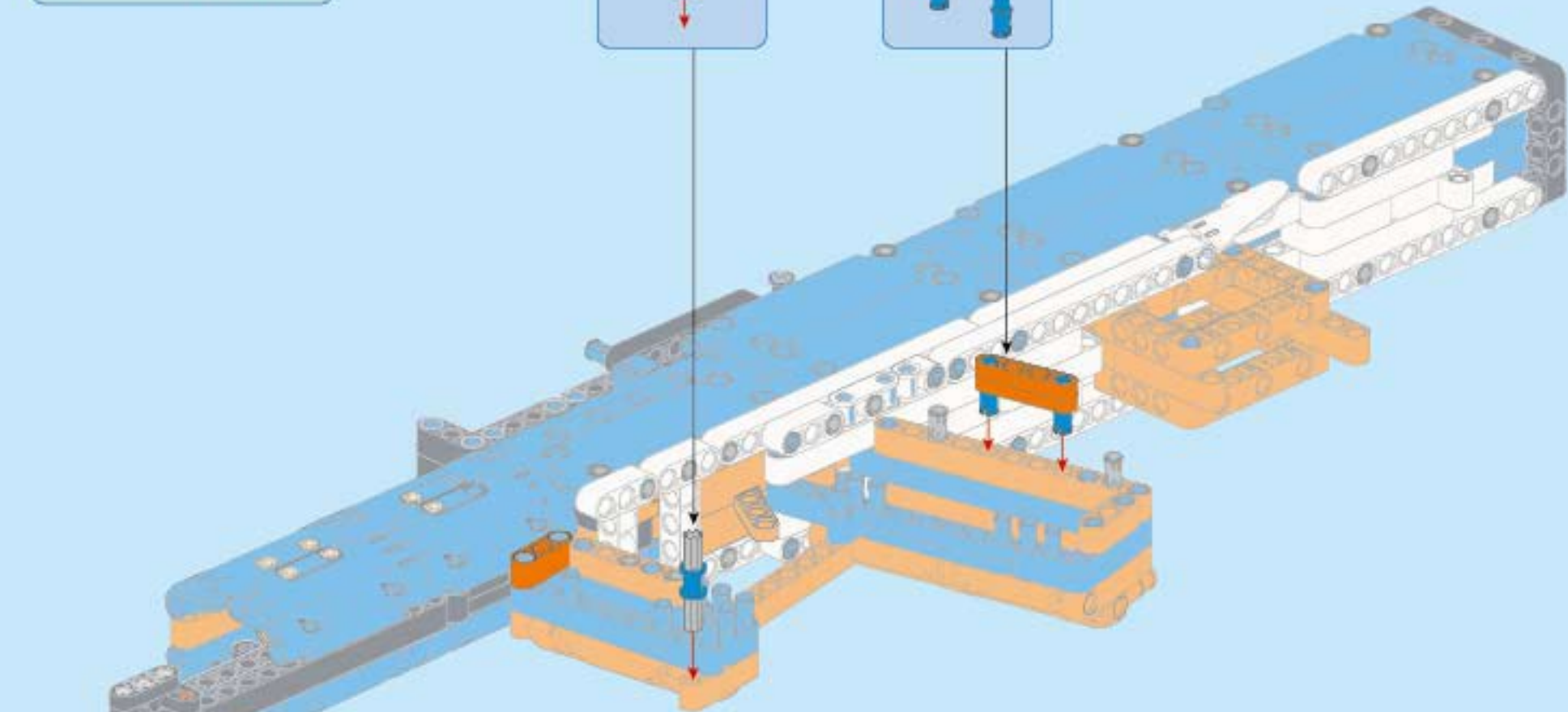
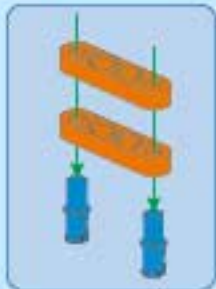
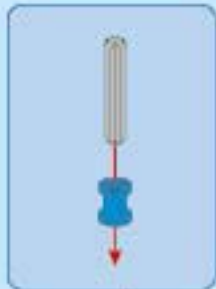



104

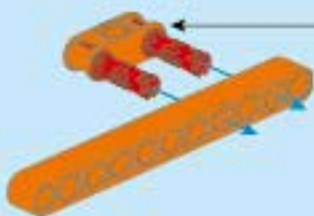
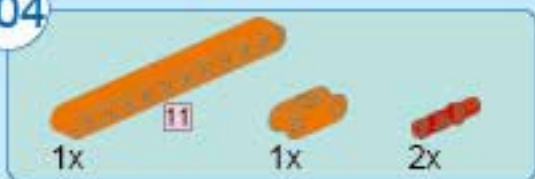

105

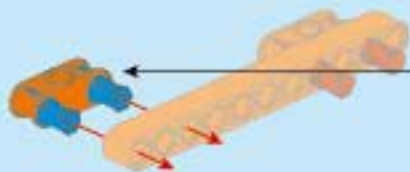
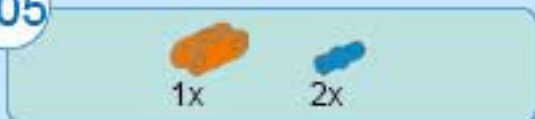

106

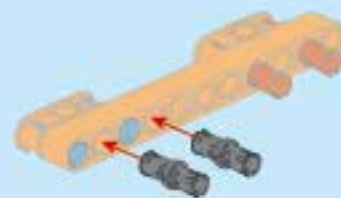
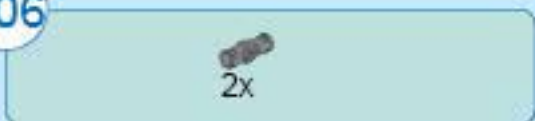

107

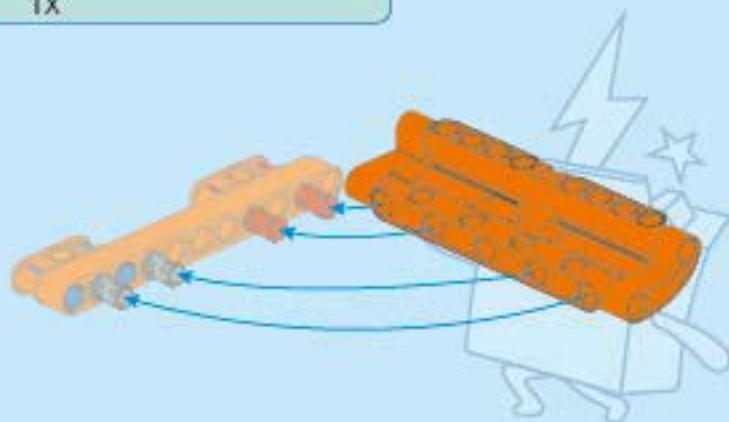
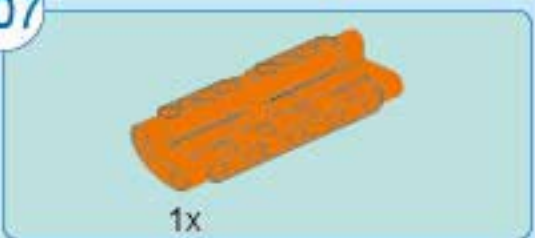

108

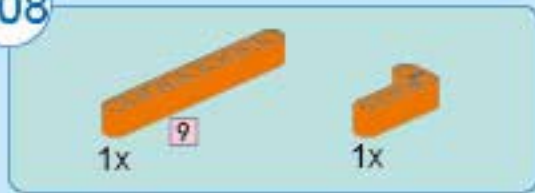

103

107





109

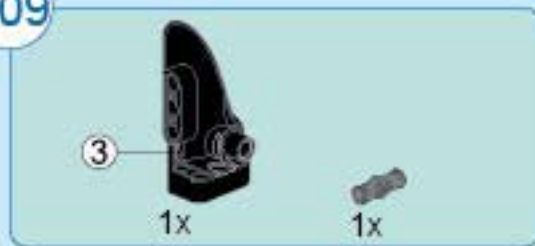

110

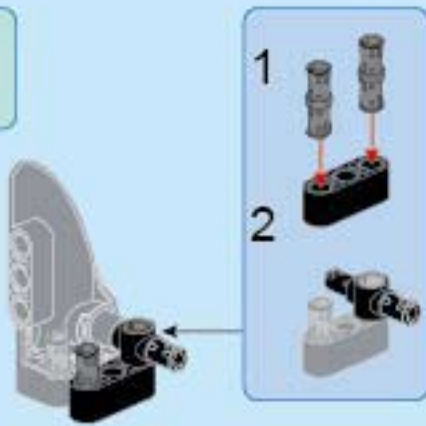

111

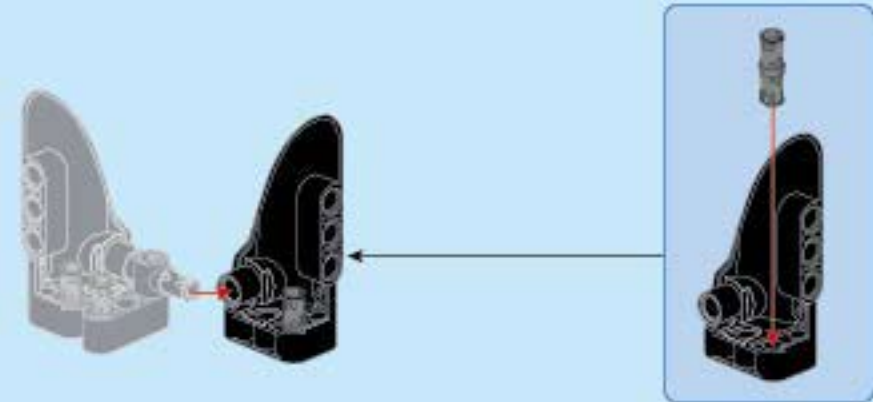
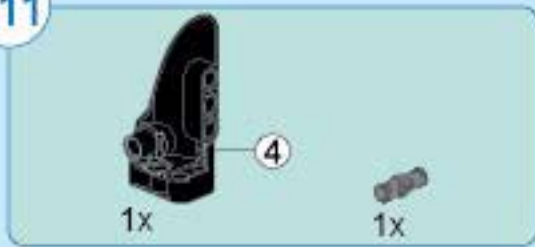

112

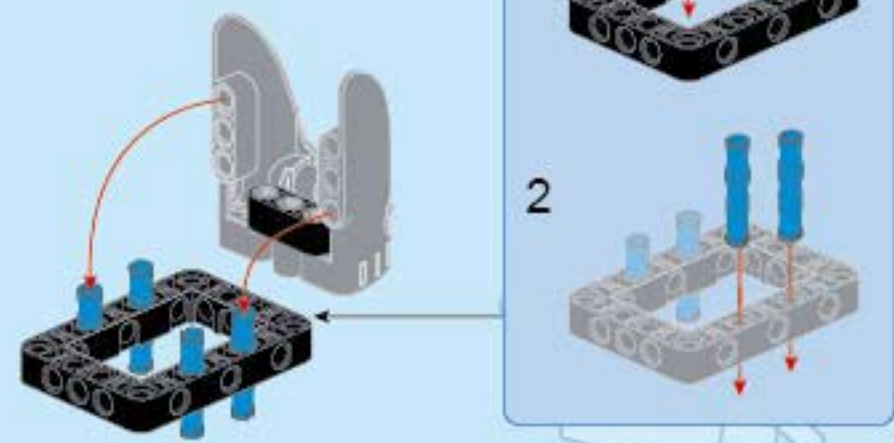
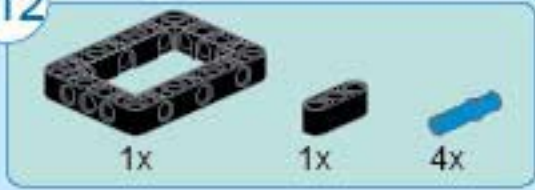

113

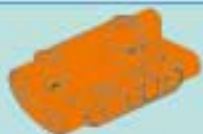

1x

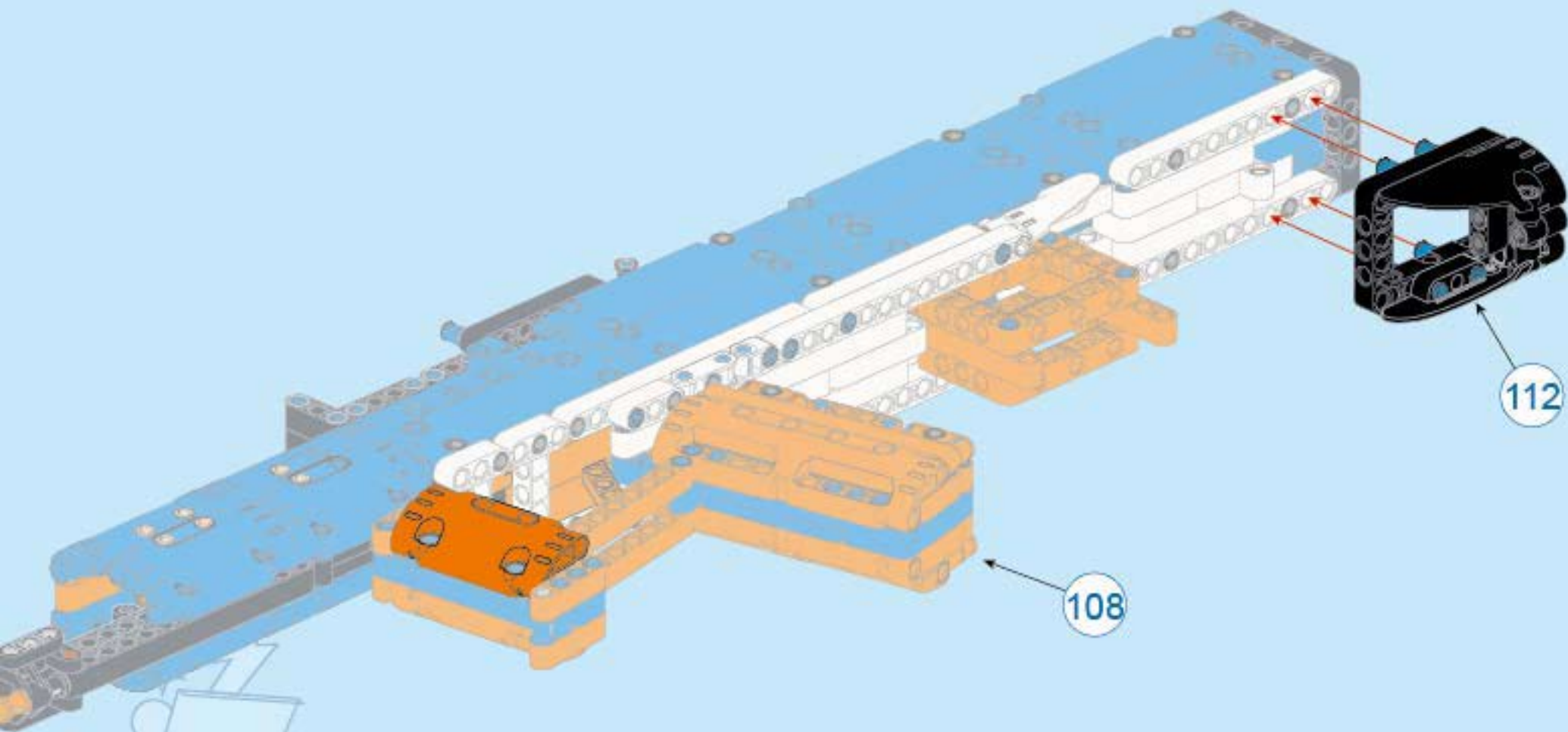

112

108



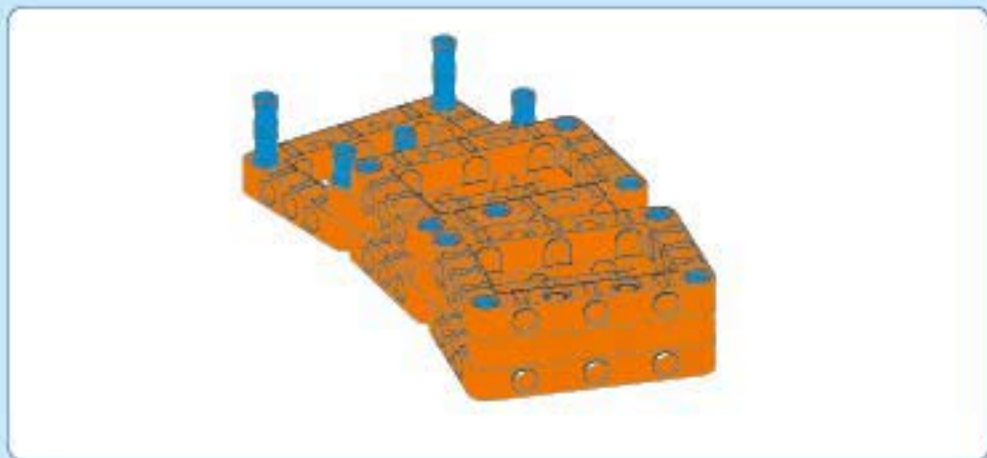

114

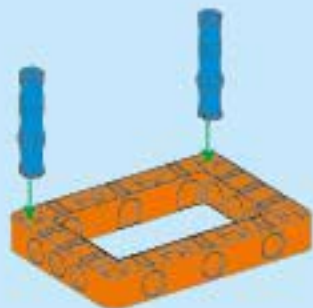
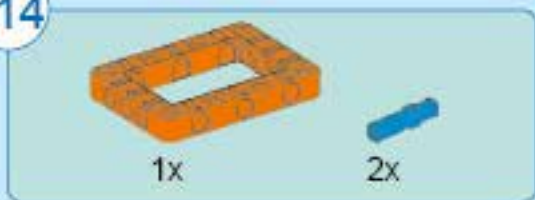

115

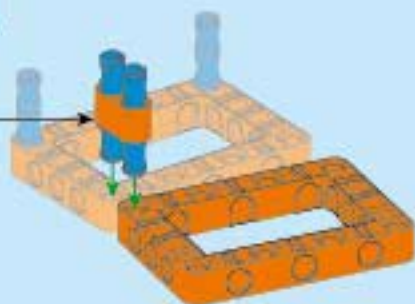
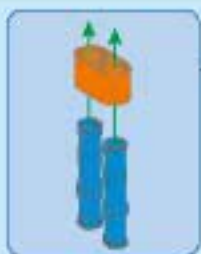
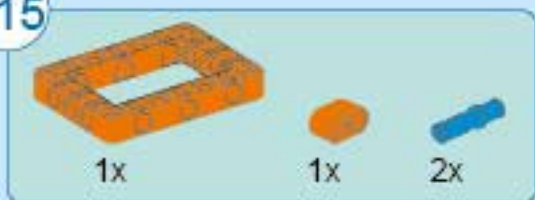

116

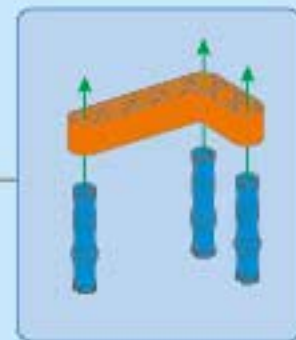
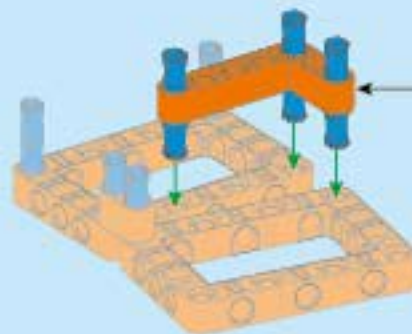

117

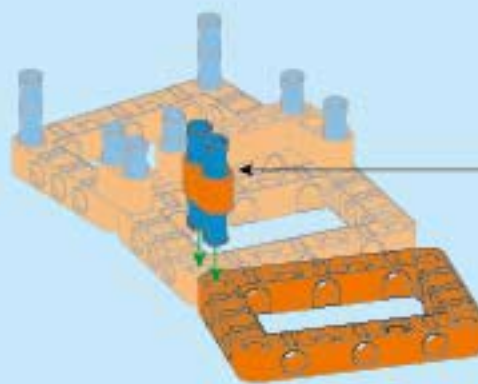
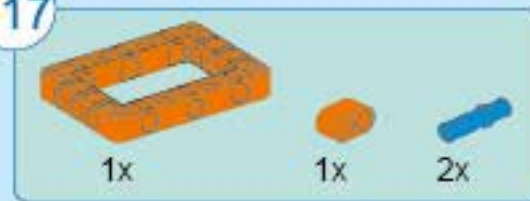

118

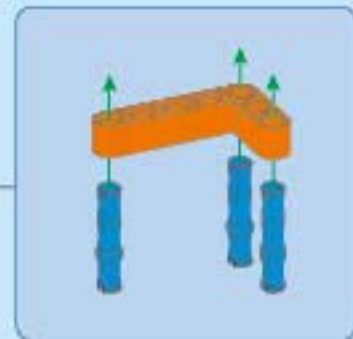
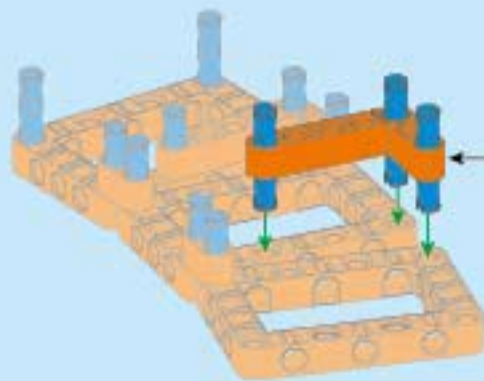

119

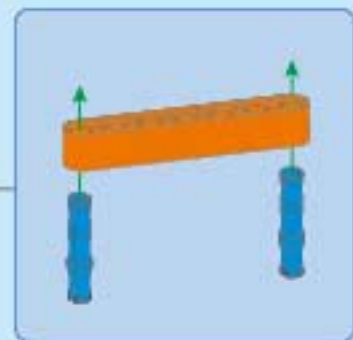
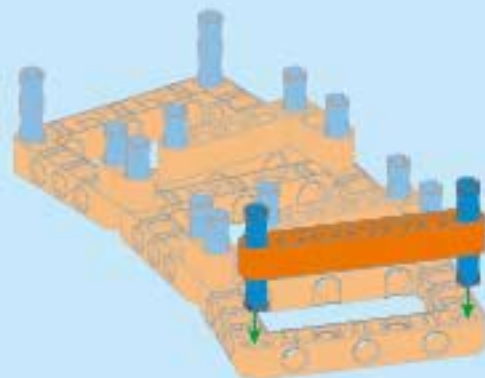
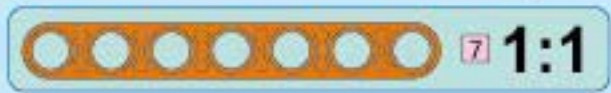

120

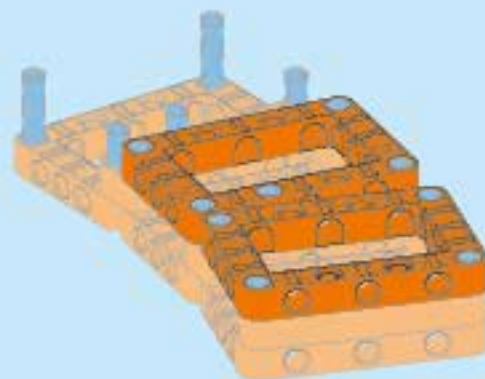
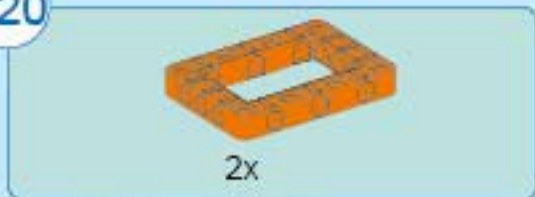

121



1x



113

120



122



1x



5x



1x



5

1:1

1



2

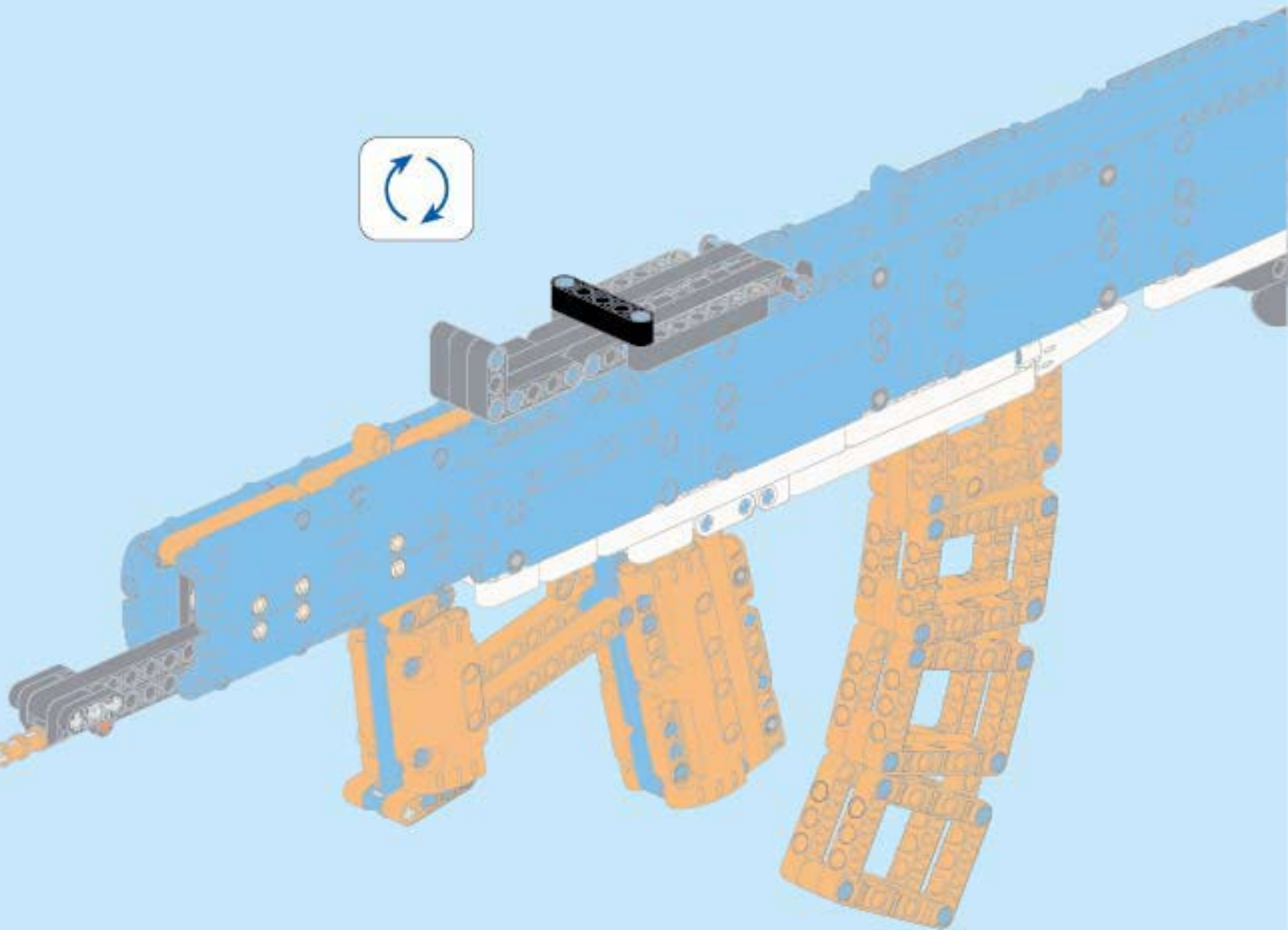

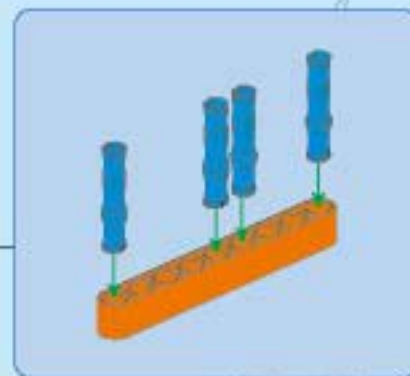
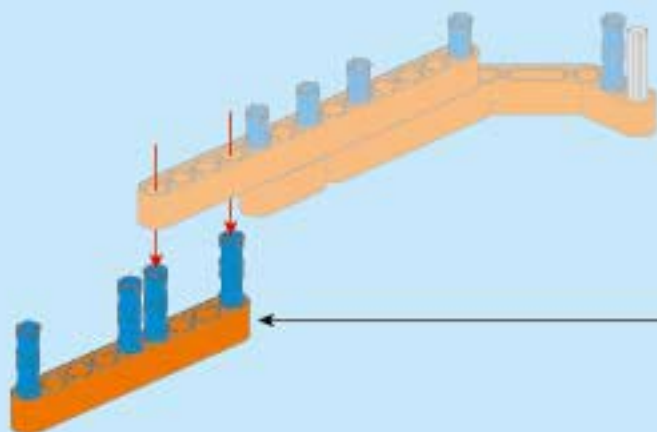
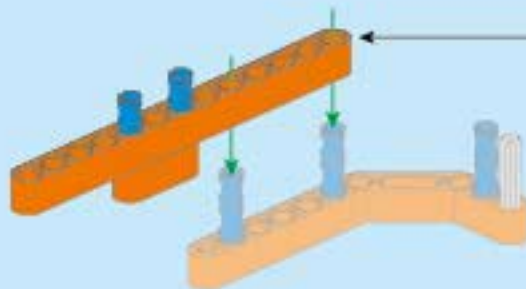
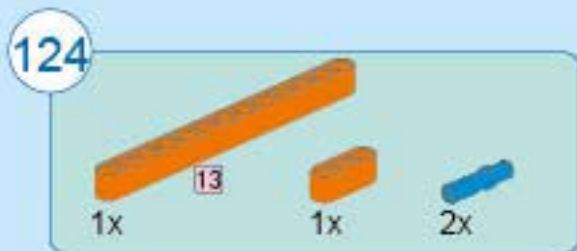
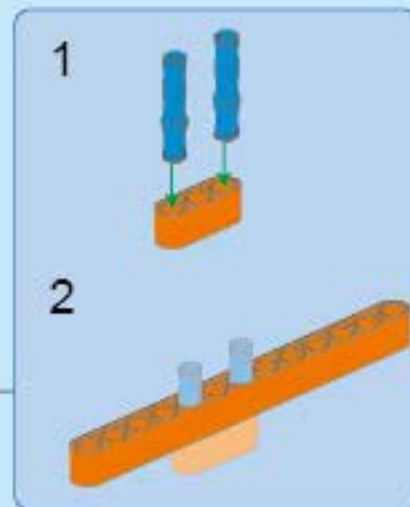
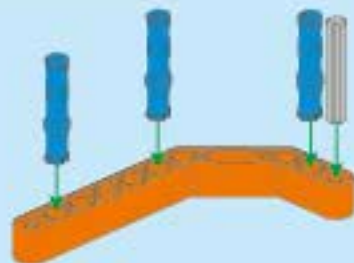
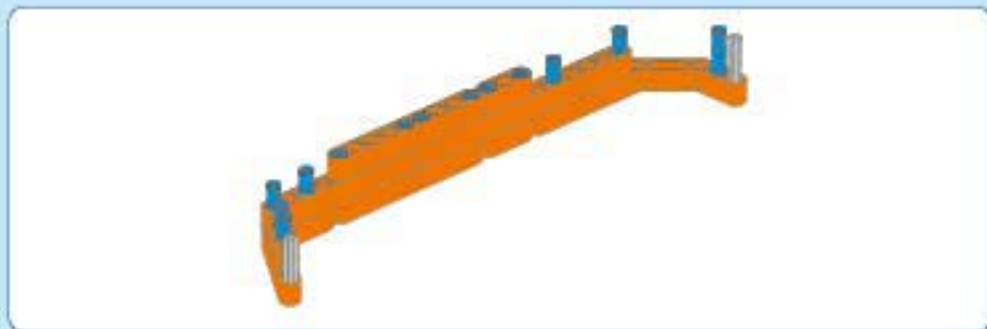



126

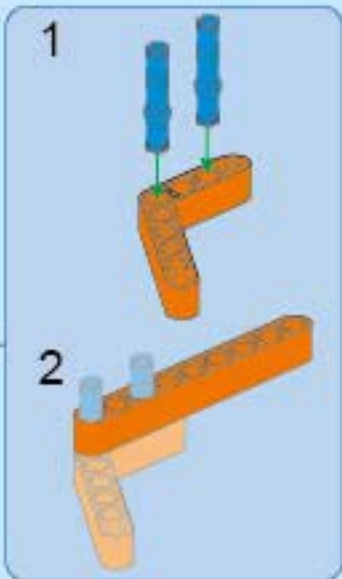
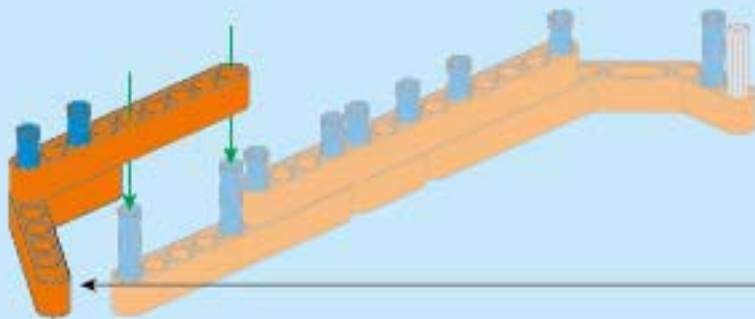
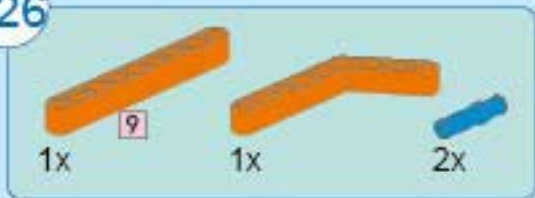

127

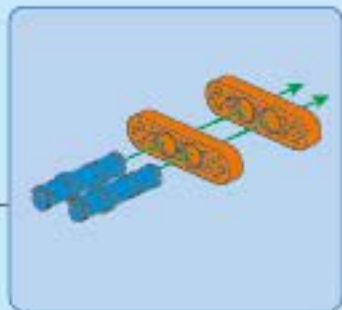
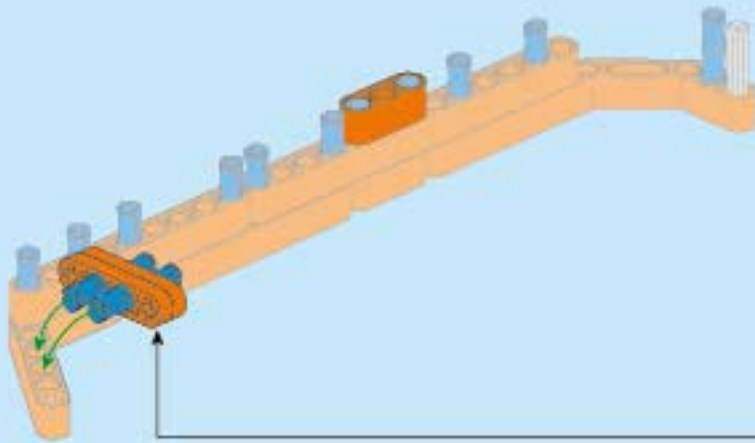

128

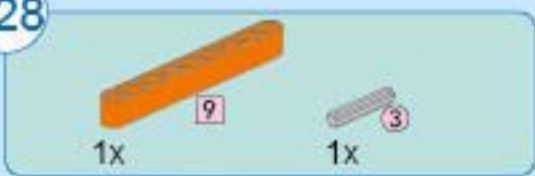

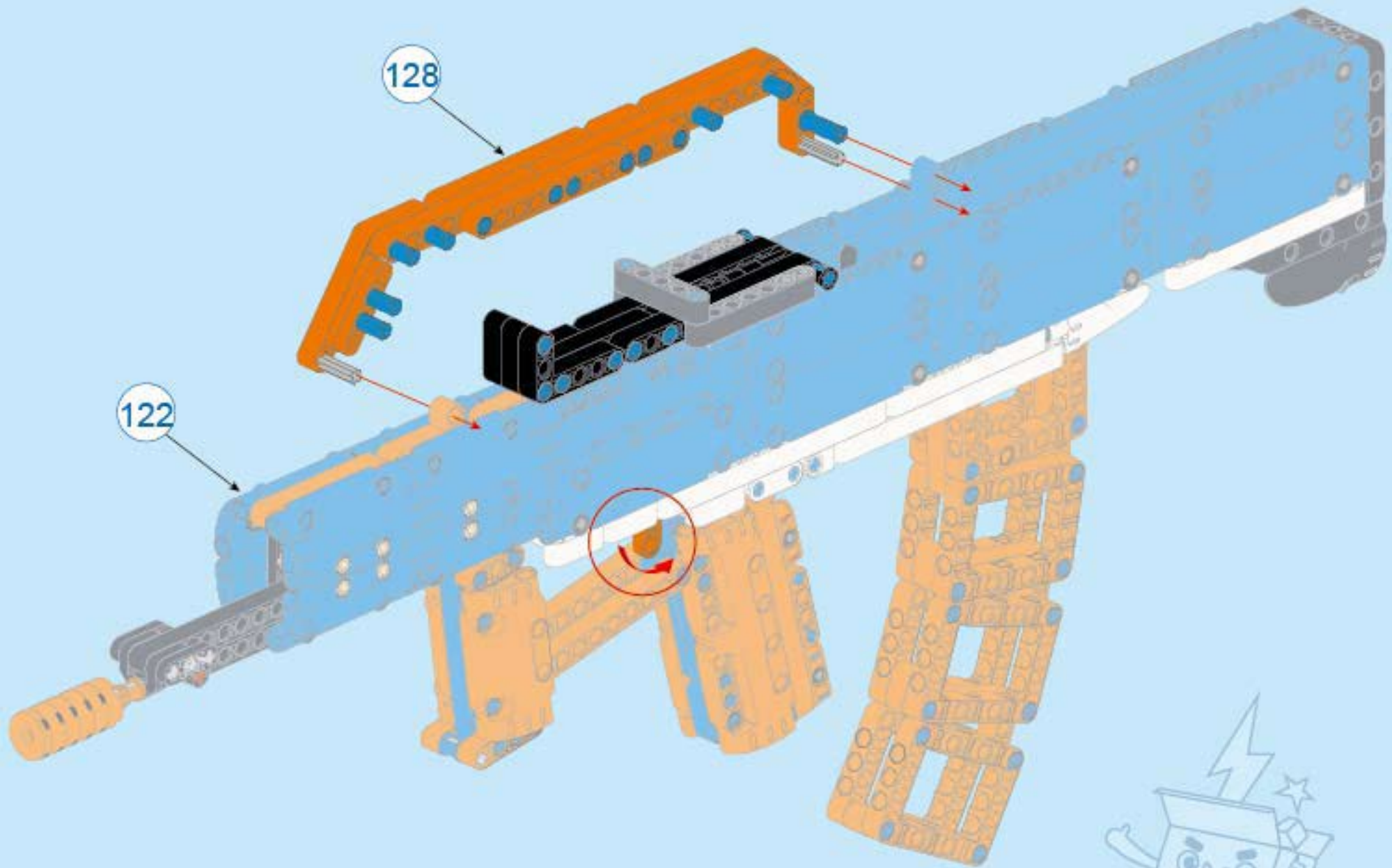



2x ④ 1:1
2x ②

130



131

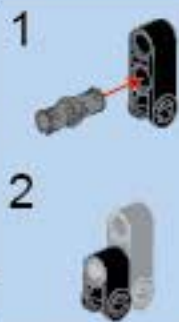

132

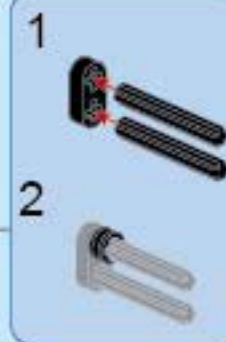

133

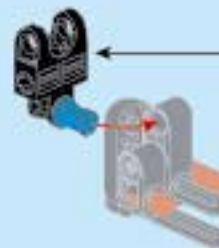

134



135

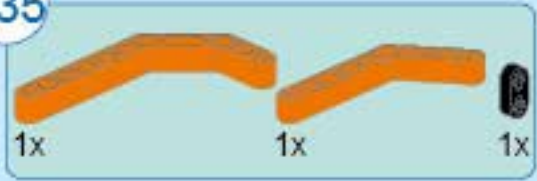

1

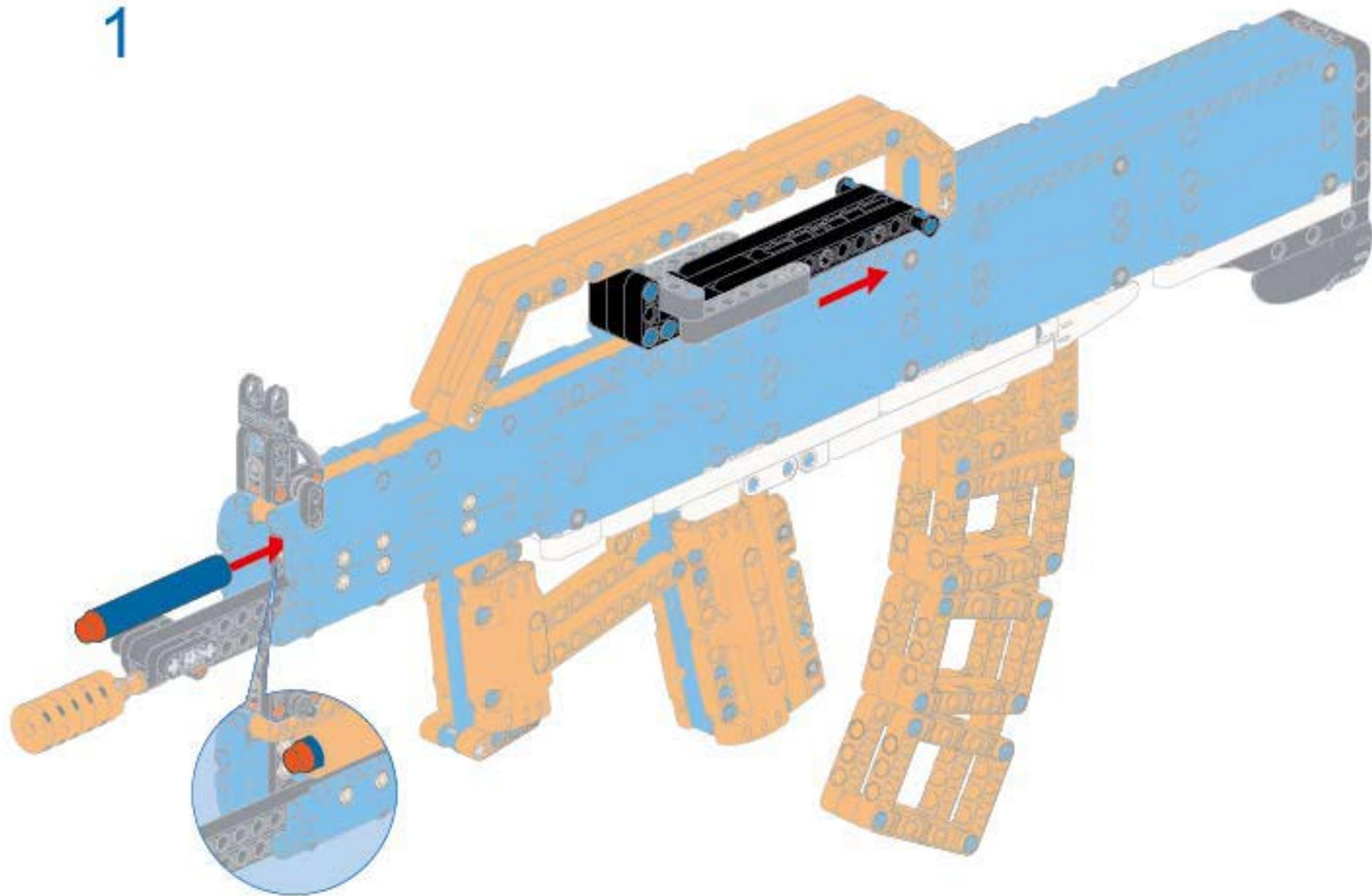

2

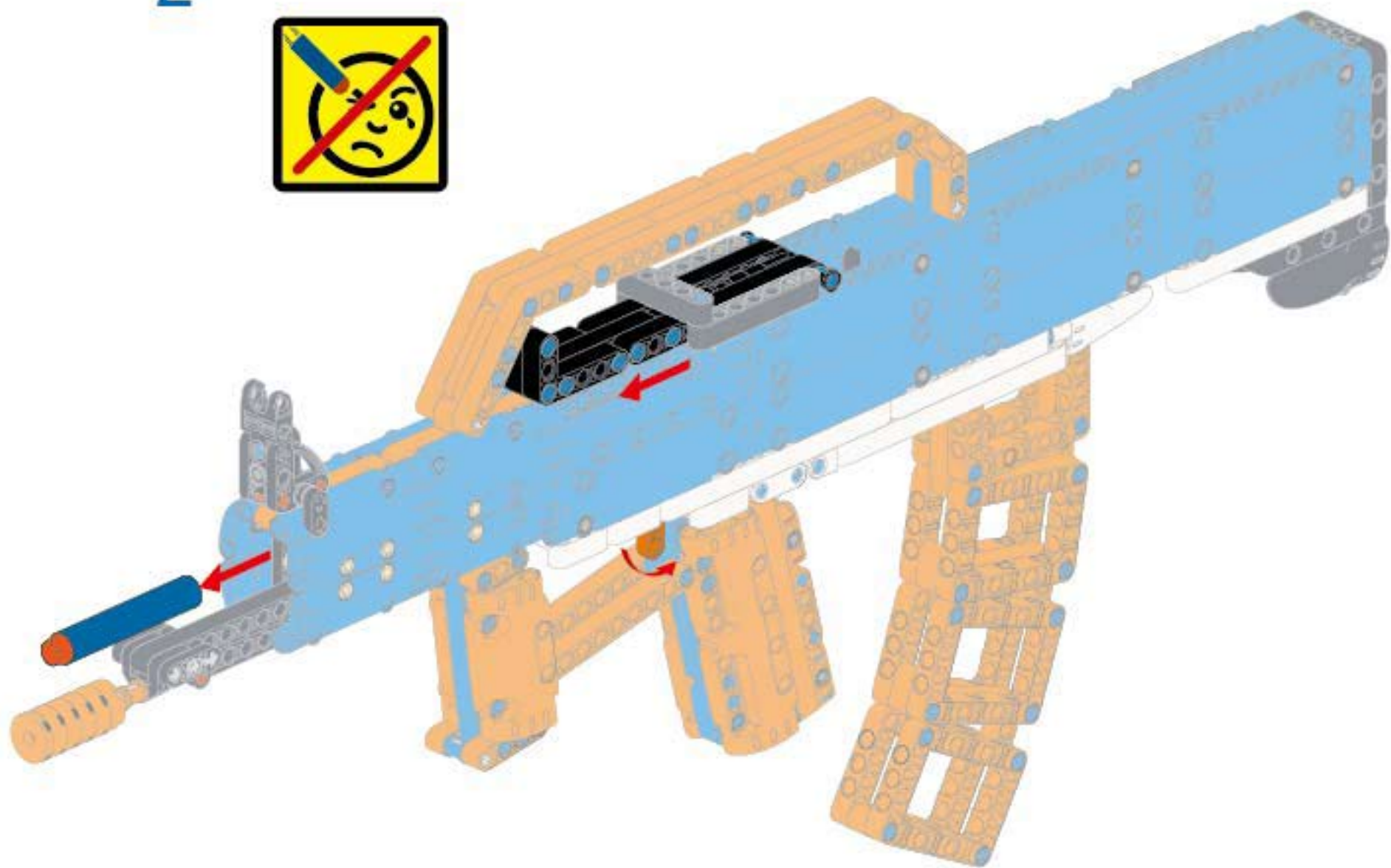



**MODEL
POWER**

模动力™

The logo features the words 'MODEL' and 'POWER' in a bold, italicized, metallic font with a blue glow. Below the main text is a horizontal bar containing the Chinese characters '模动力' followed by a trademark symbol. The background is a gradient from orange to blue with a technical grid pattern.