



52003

年龄: 8+

片数: 398

MODEL
POWER
LEGO
LEGO



扫码关注公众号,
输入“52003”
观看玩法视频。

功能
玩法



1x10 安全泡沫弹

安全气动装置

UZI冲锋枪
近距离冲锋, 激情对战

图片仅供参考, 请以实物为准。

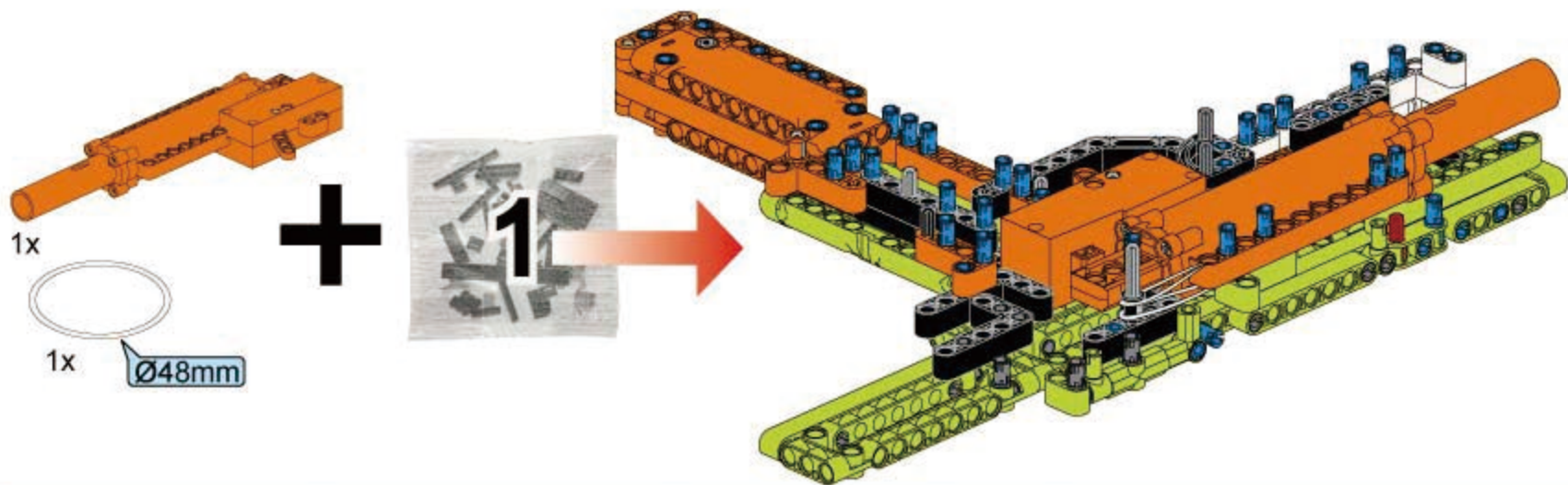

拆件器使用方法，仅为示例

Usage of Brick Separator, Just for the sample

1



2



3



4



1

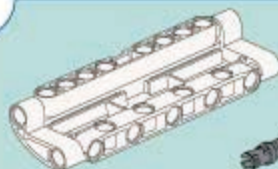

1x

2x

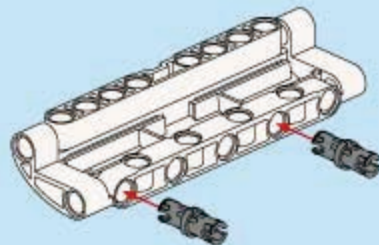

2

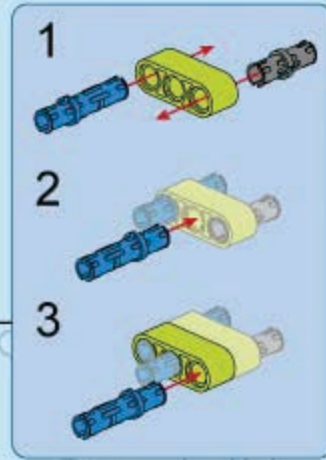
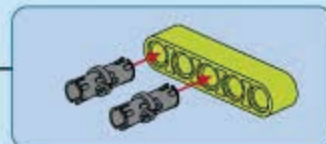
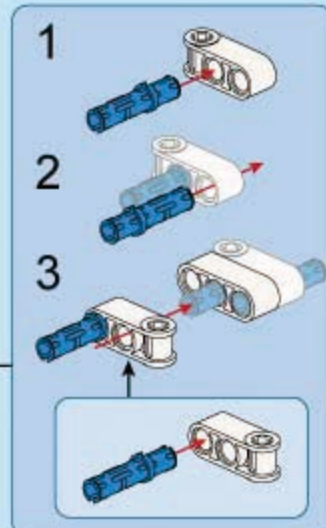
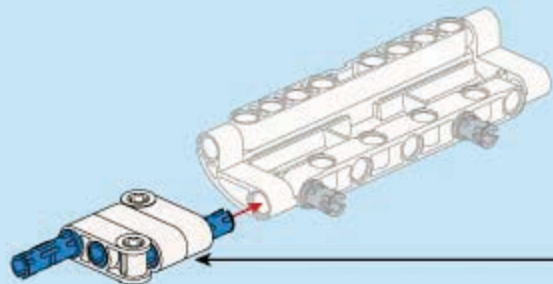

3

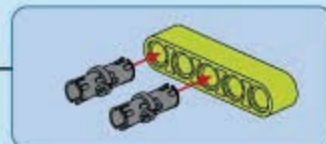
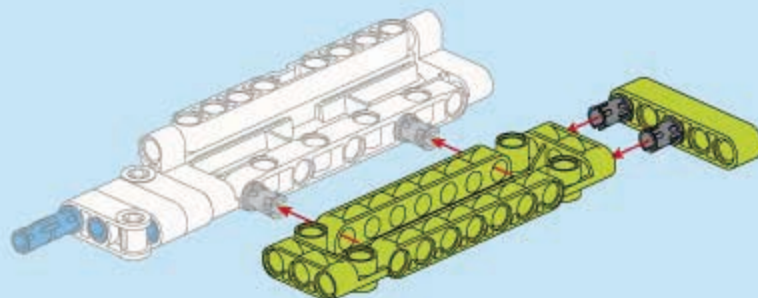
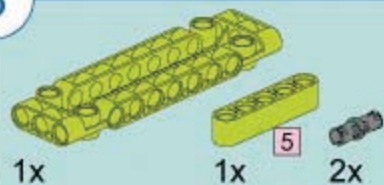

4

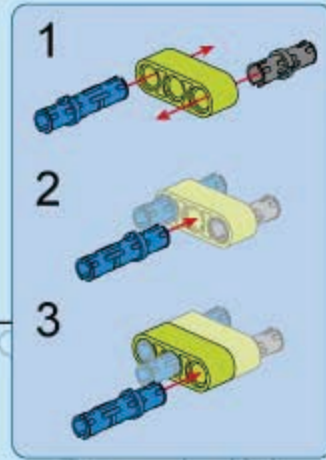
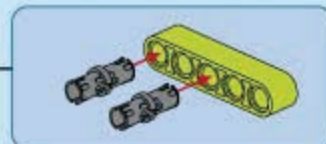
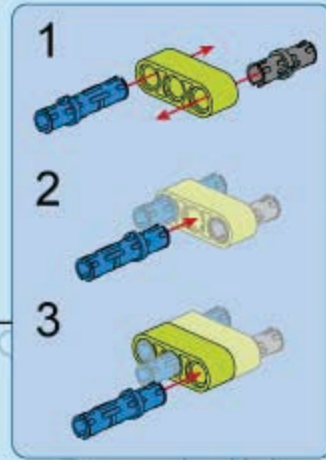
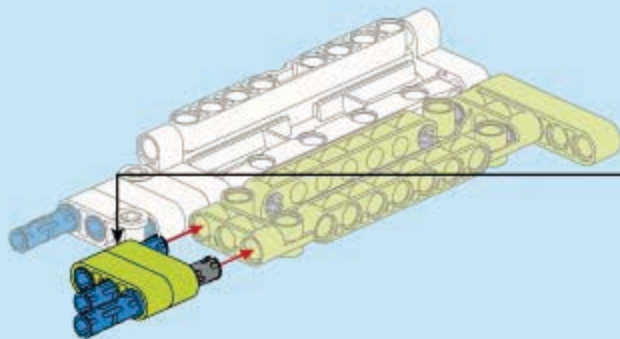

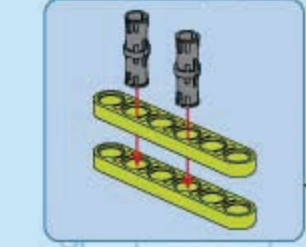
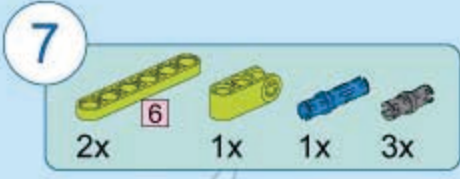
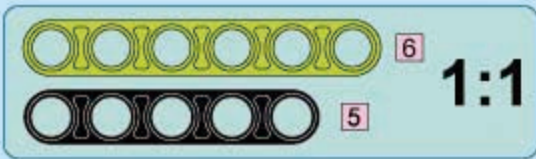

3

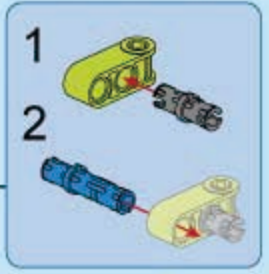
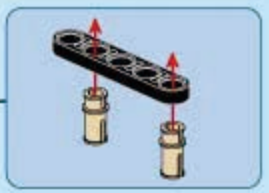
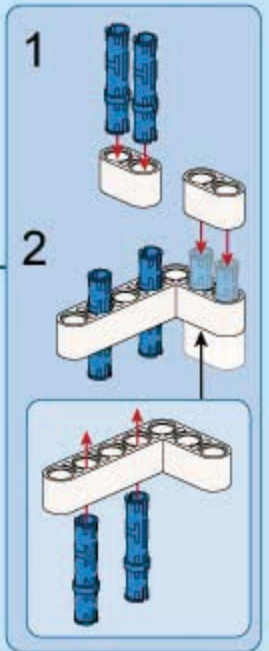
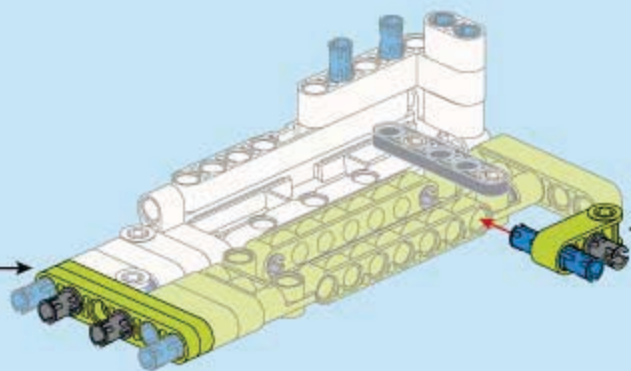
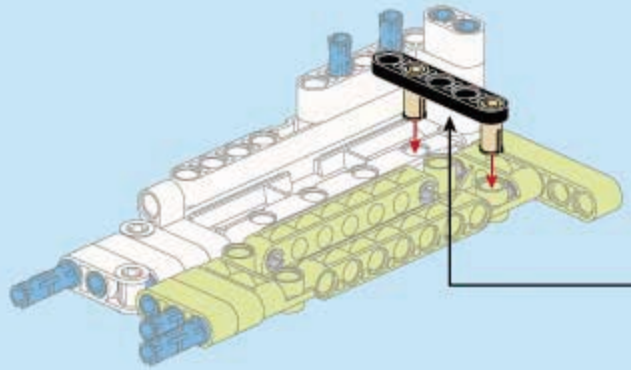
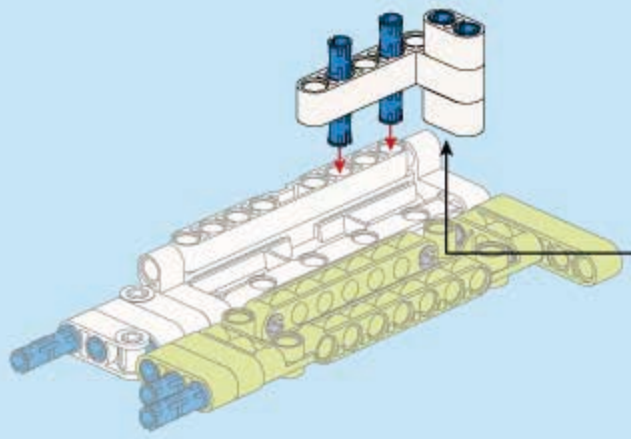

8

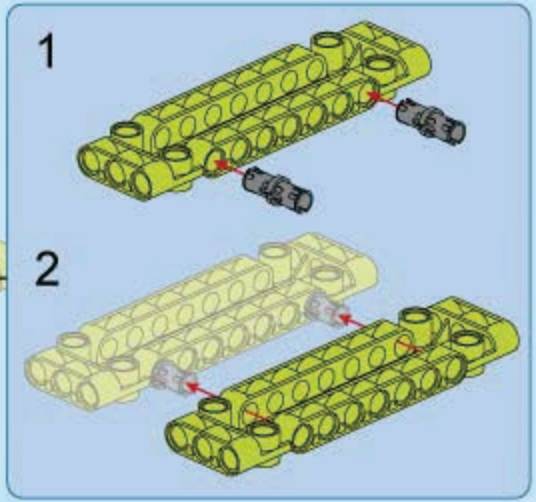
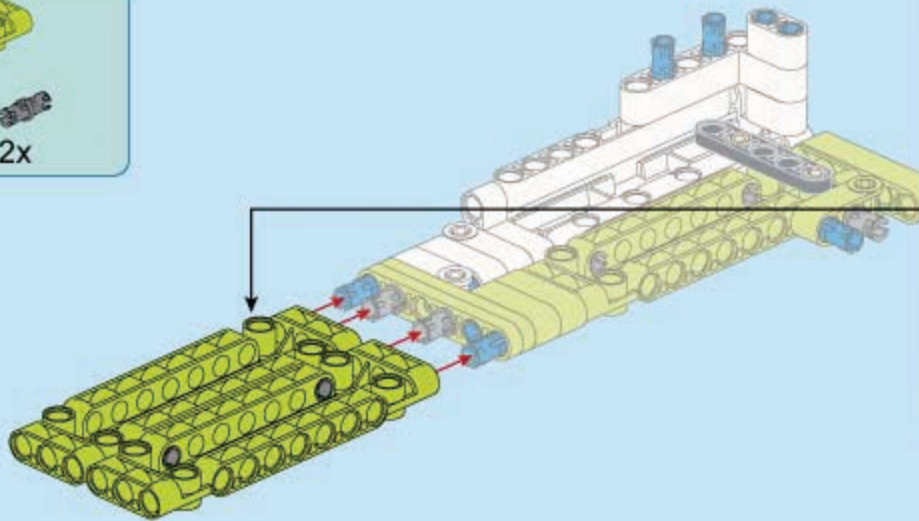
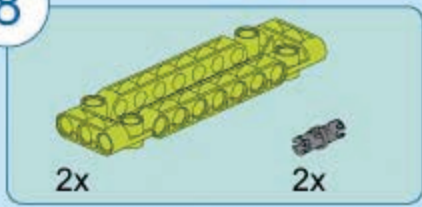

9

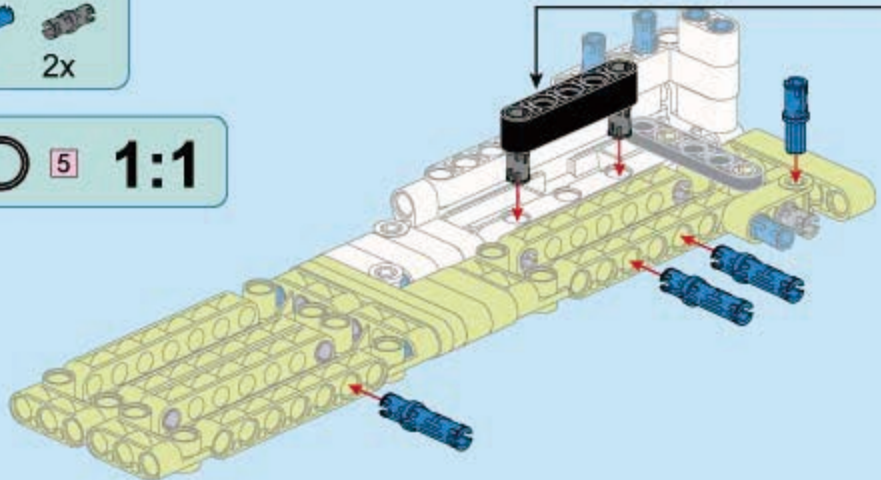

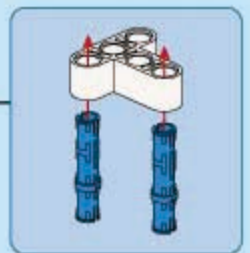
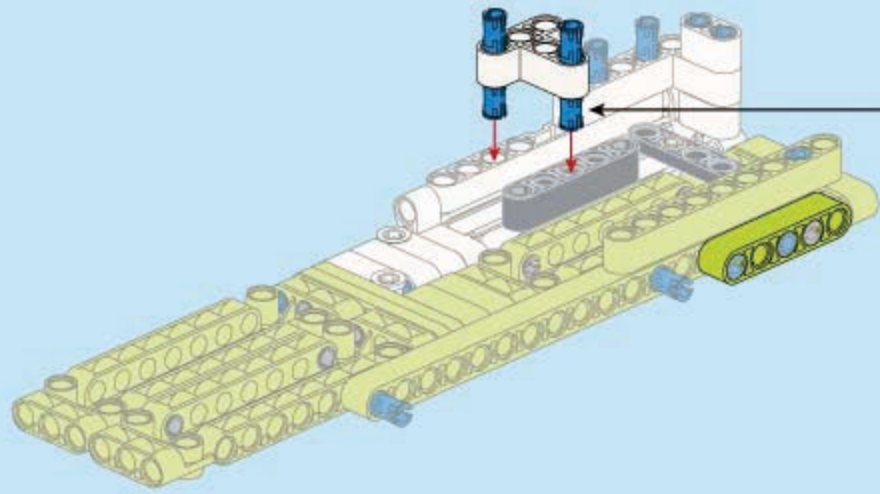
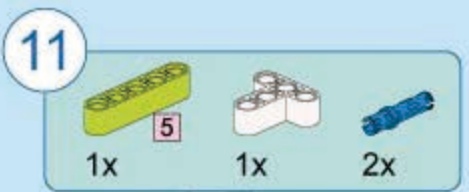
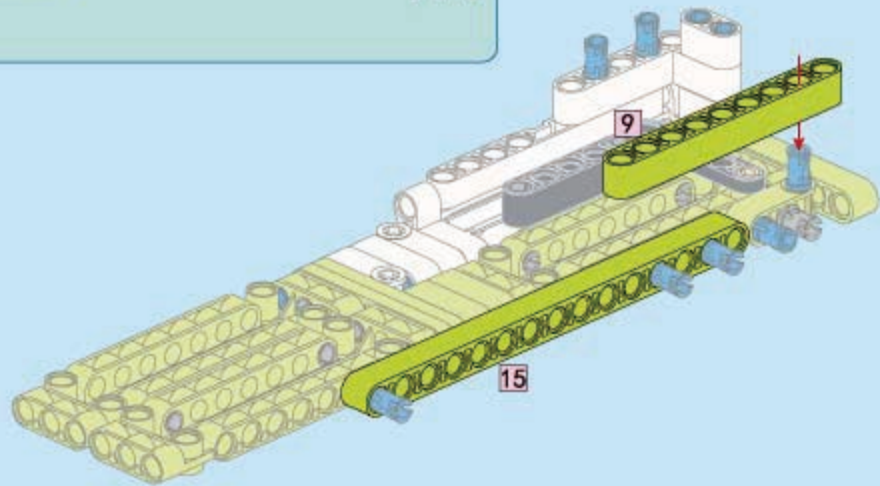
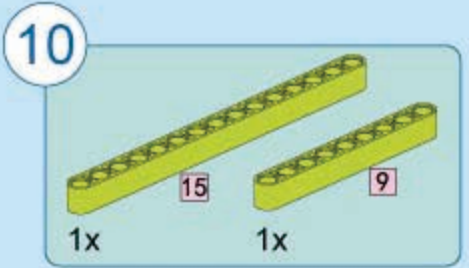
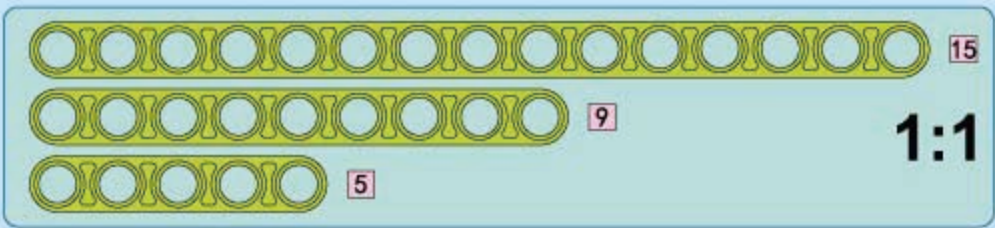

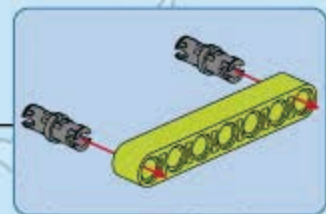
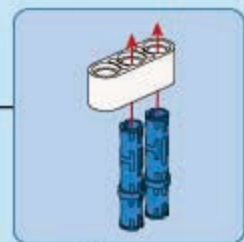
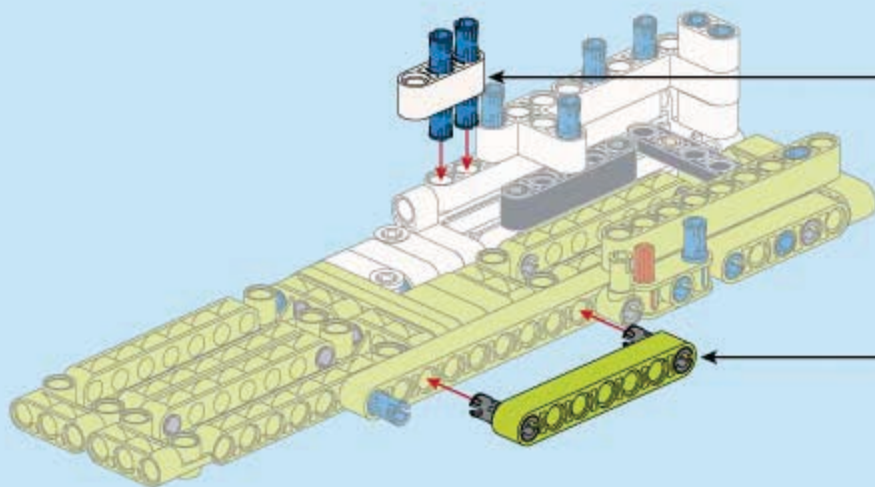
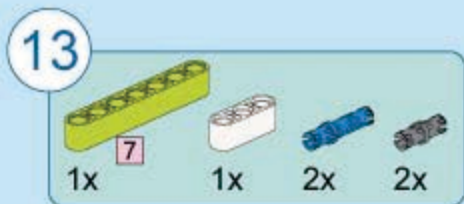
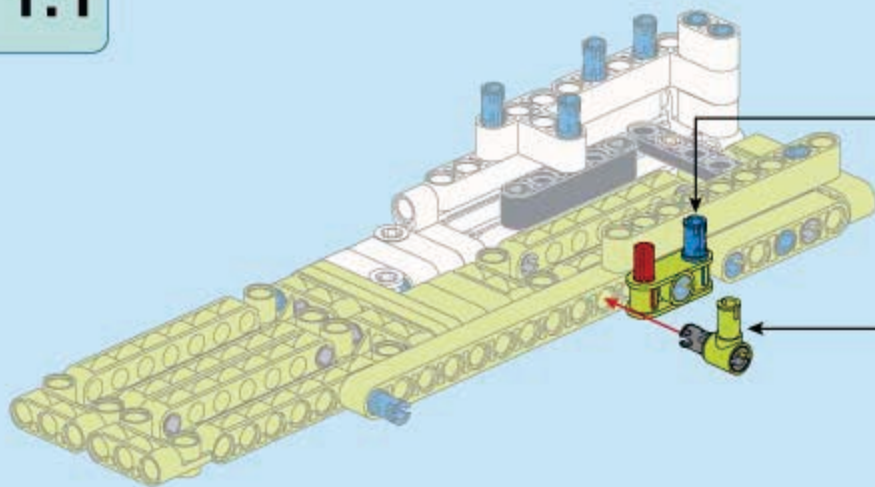
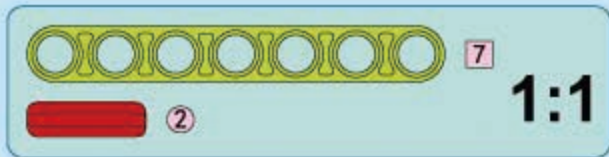

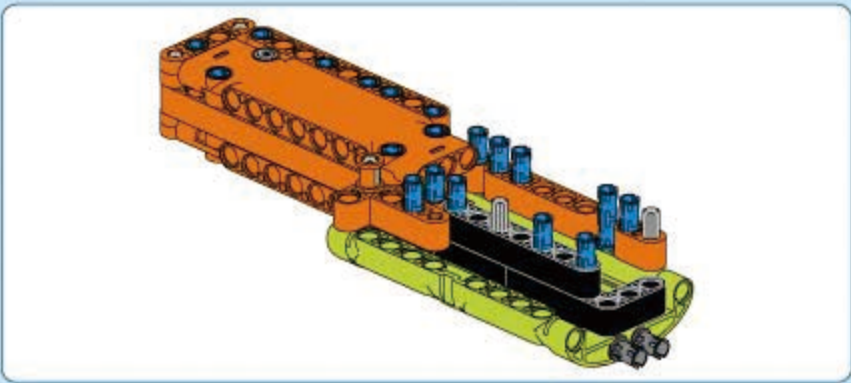

14

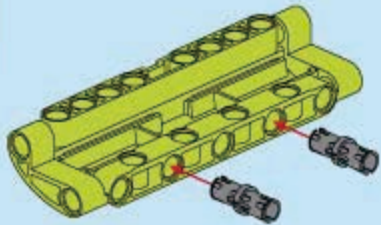
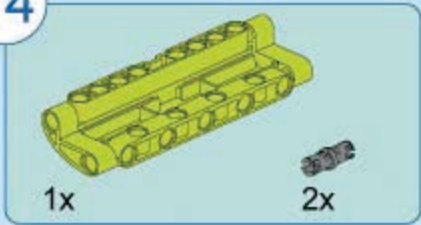

15

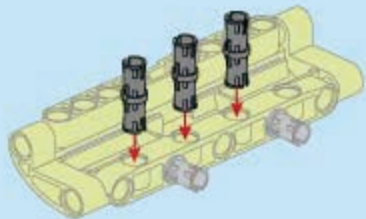

16

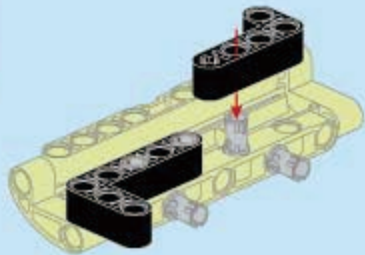

17

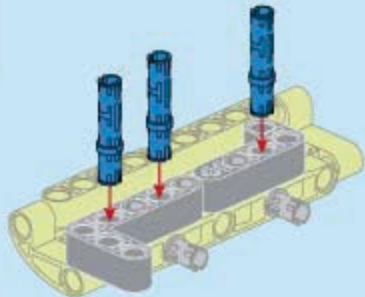

18

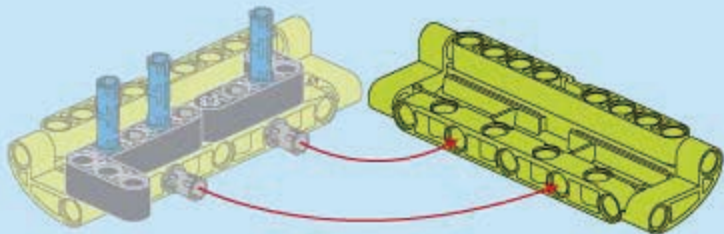
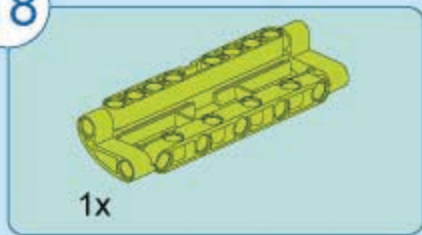

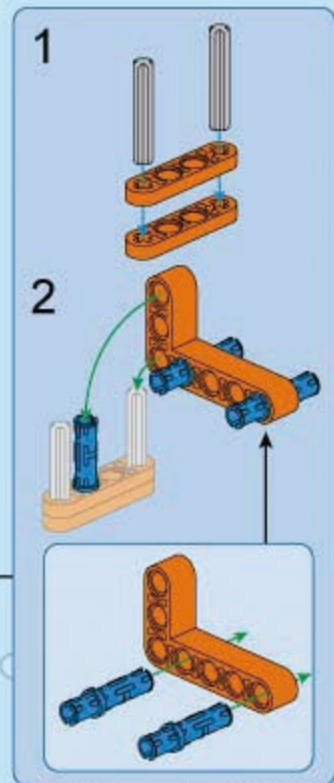
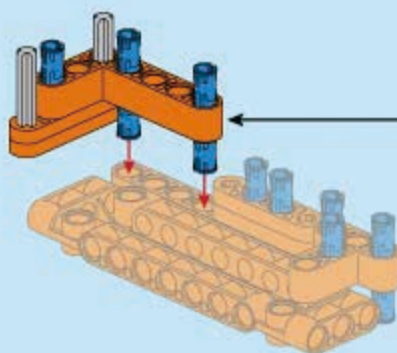
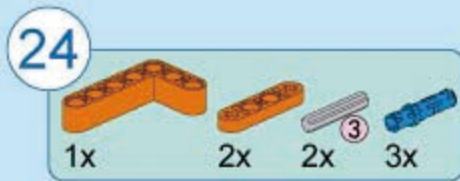
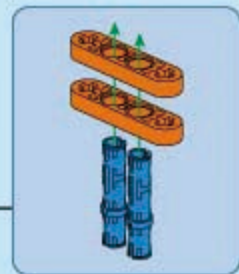
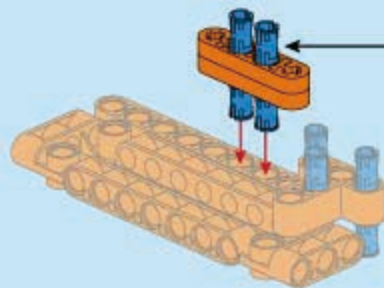
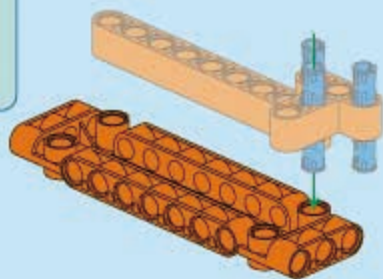
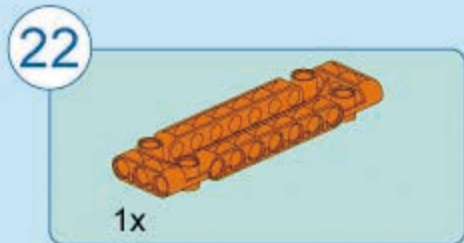
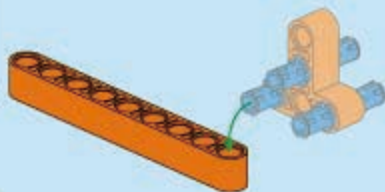
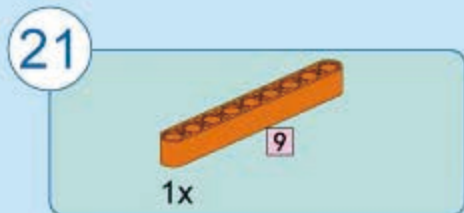
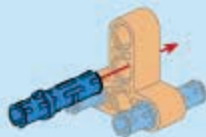
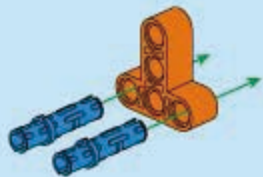
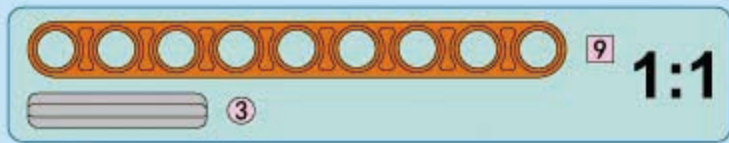

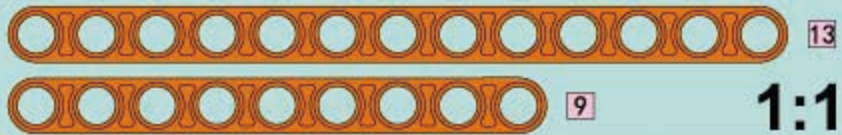

25



1x

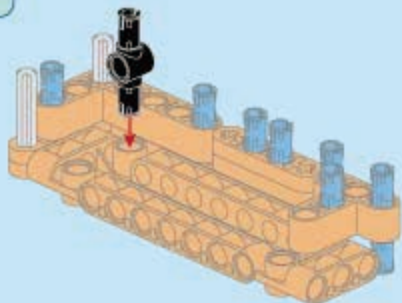

26



1x

3x

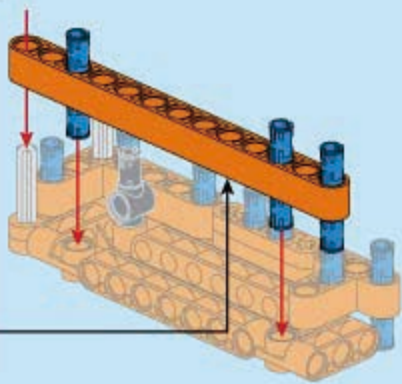
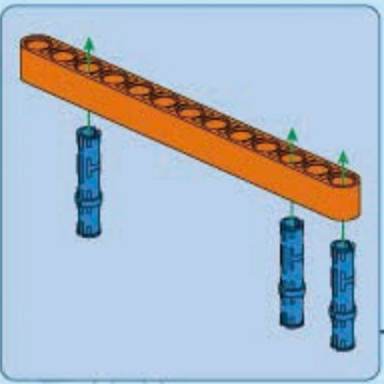

27



1x



2x

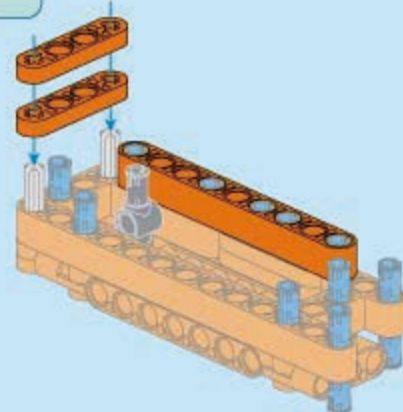

28



1x

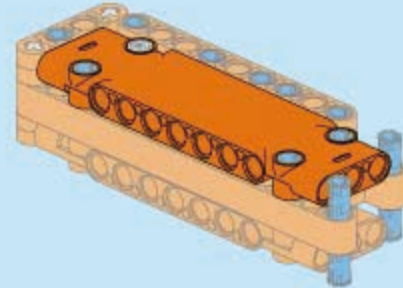

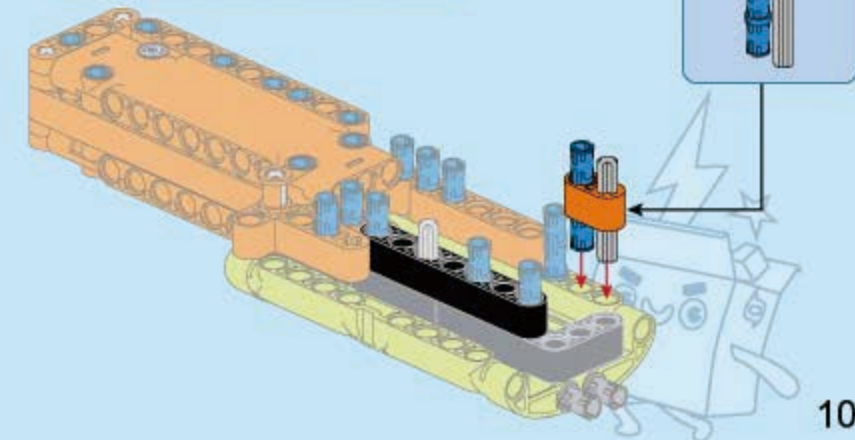
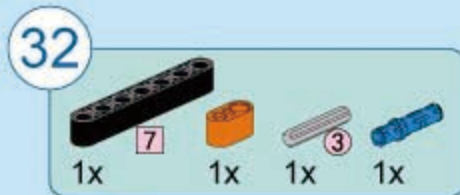
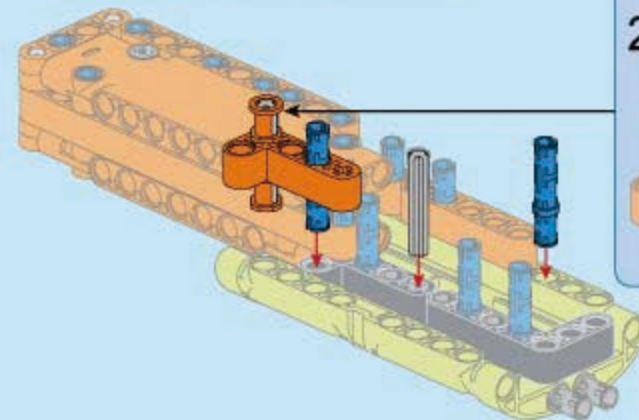
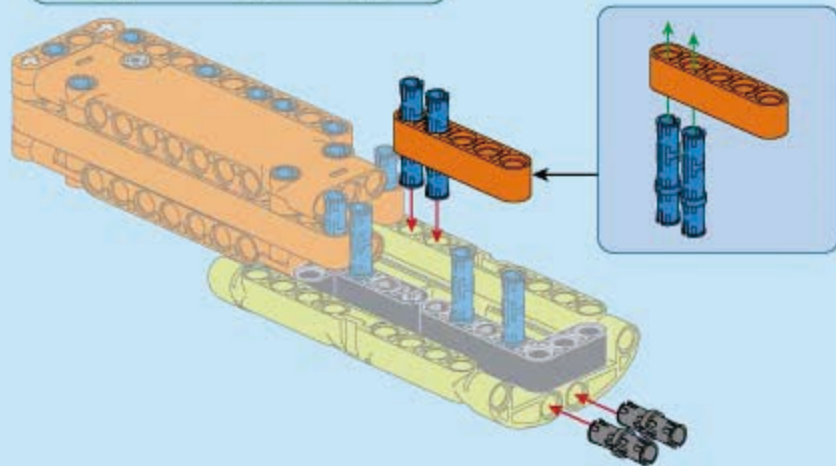
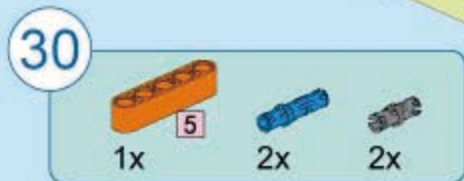
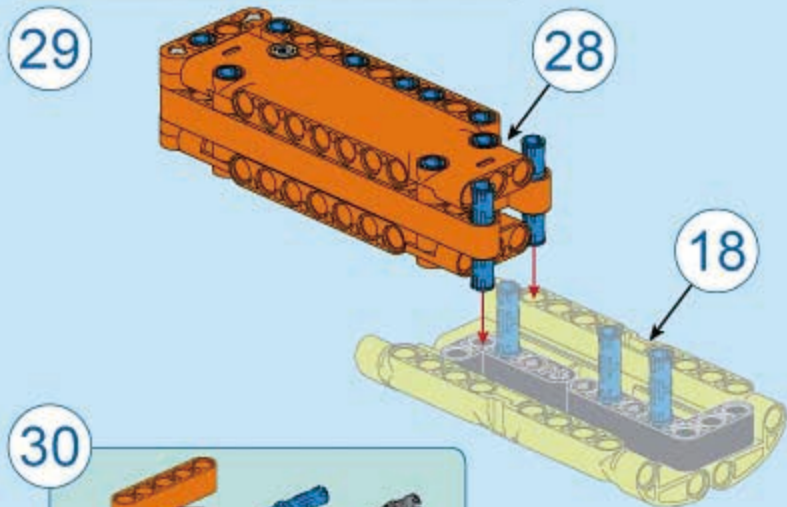
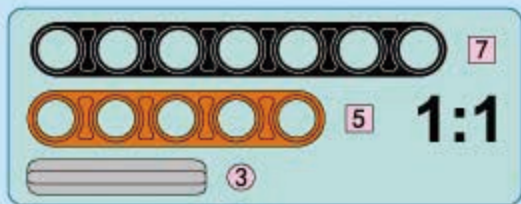

33

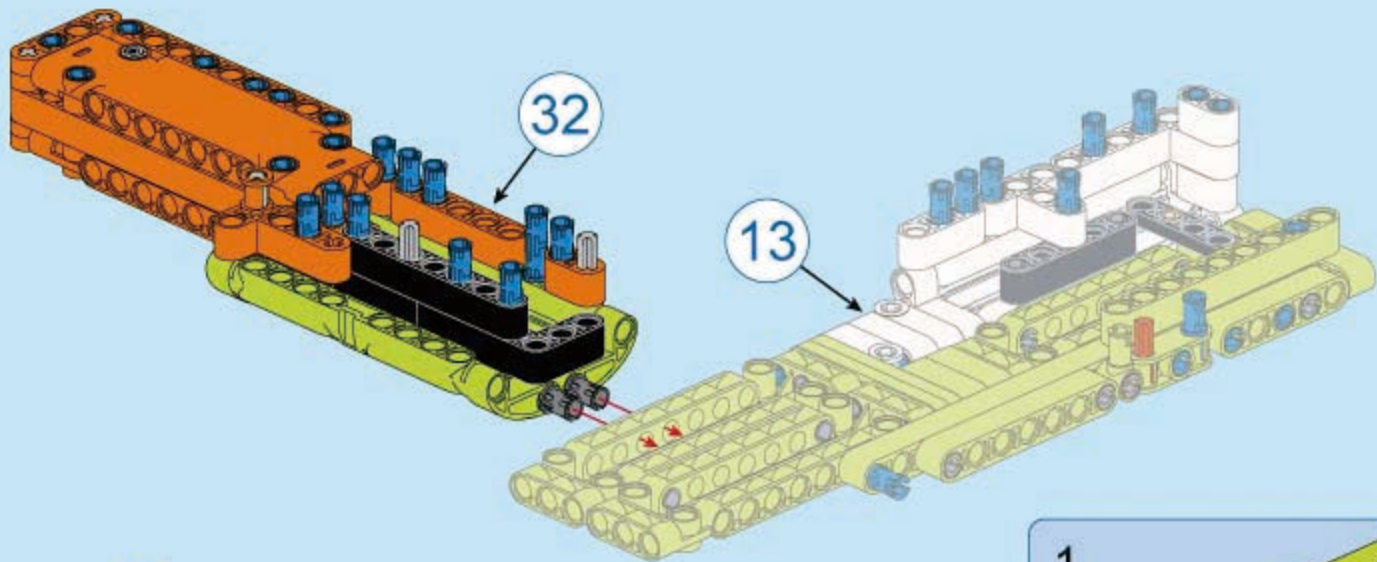

32

13

34

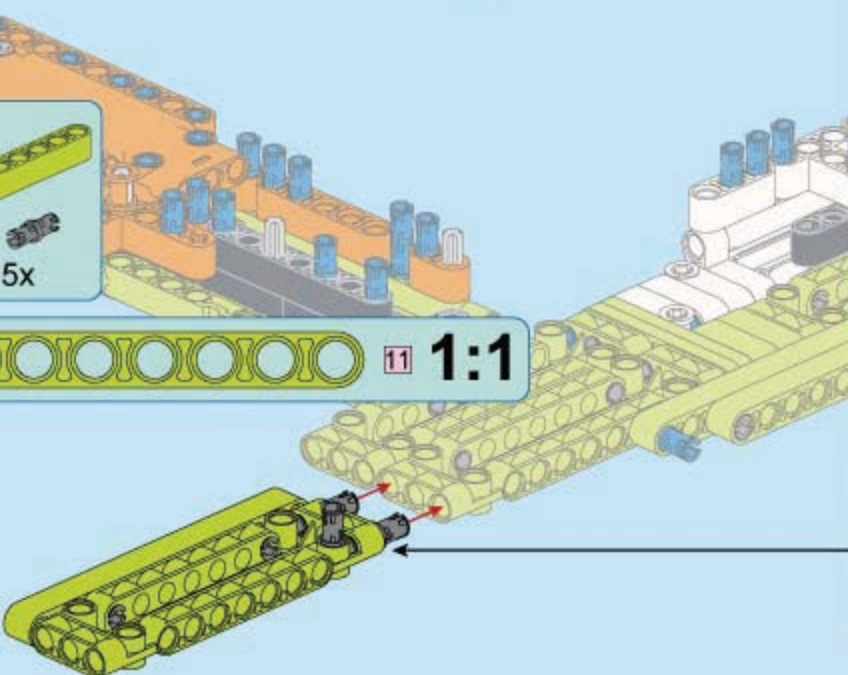
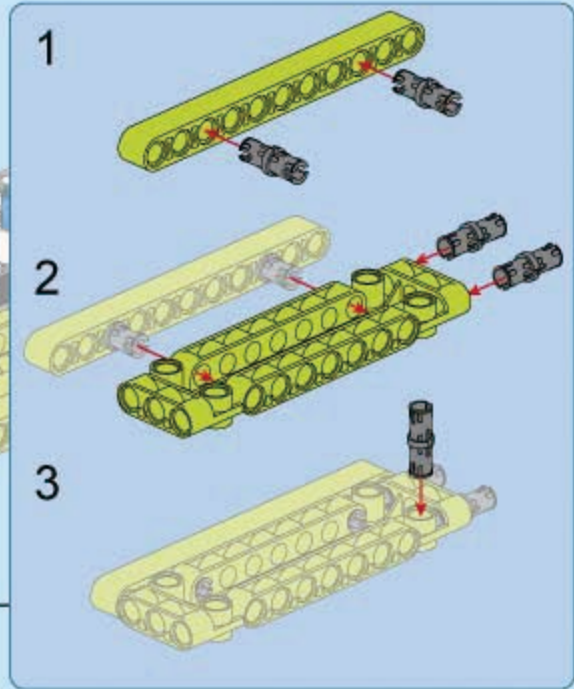
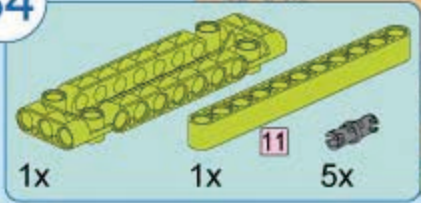

35

1x

2x

2x

1x

1:1

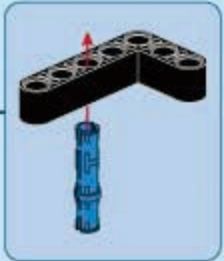
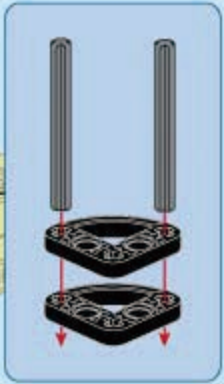
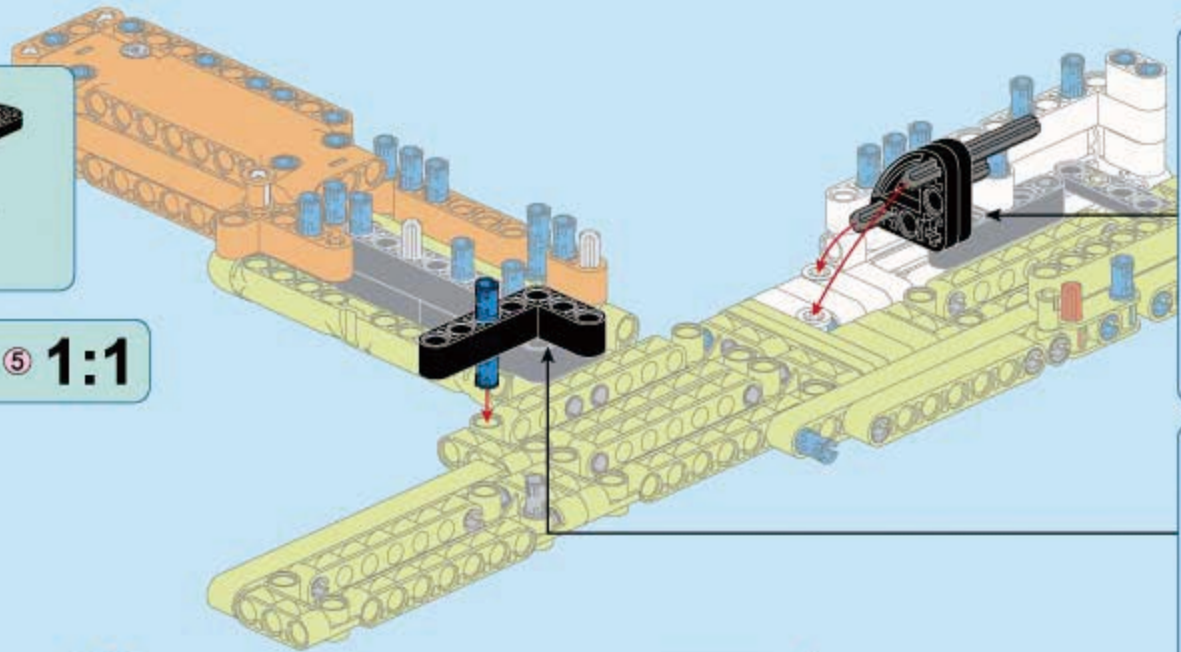

36

1x

1x

3x

1x

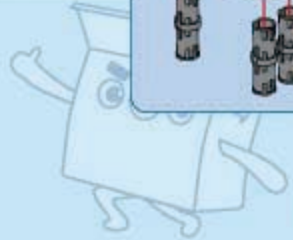
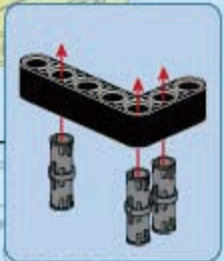
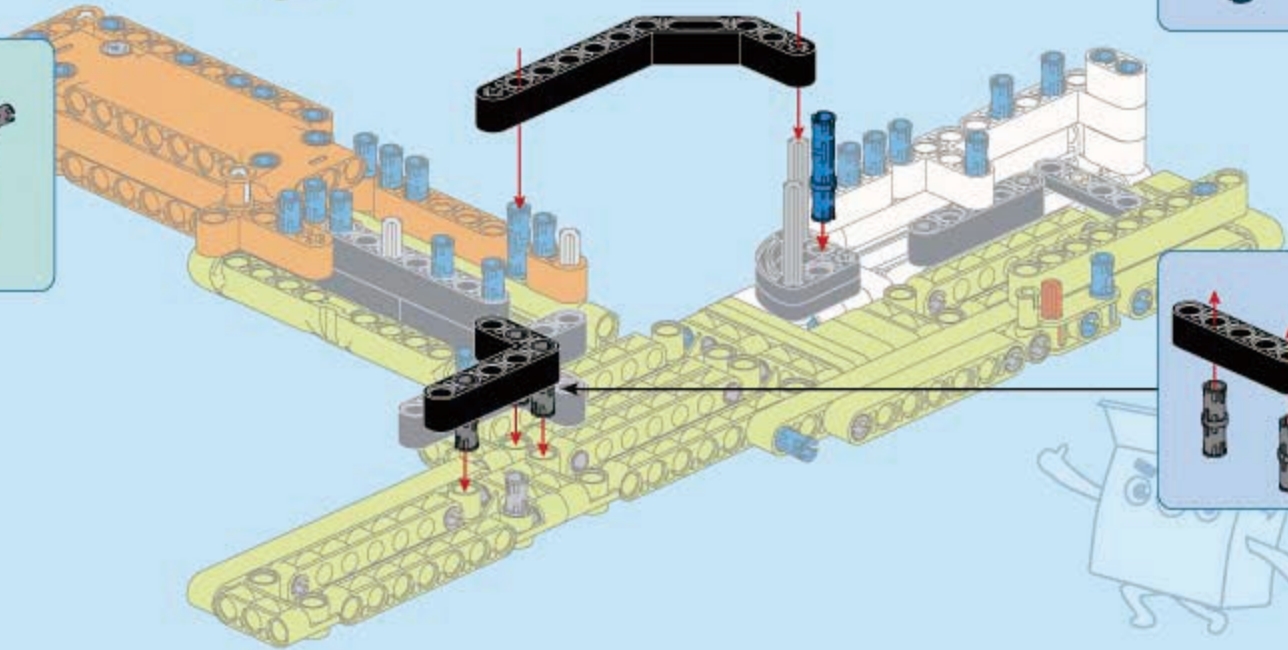

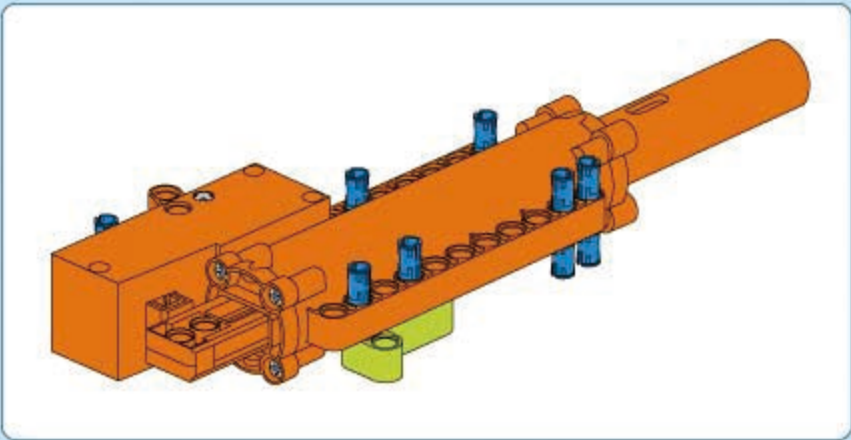

37

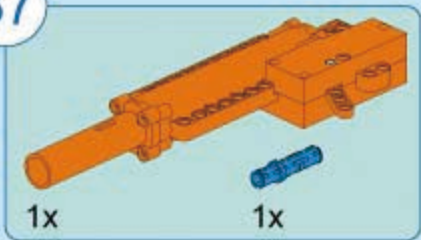

1x

1x

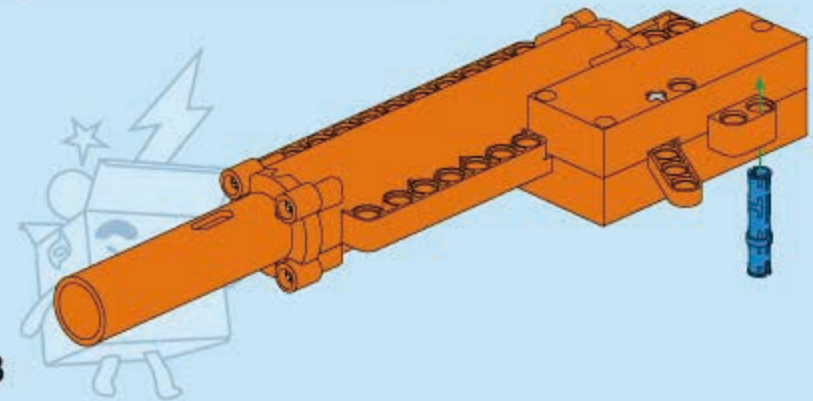

13

38



2x

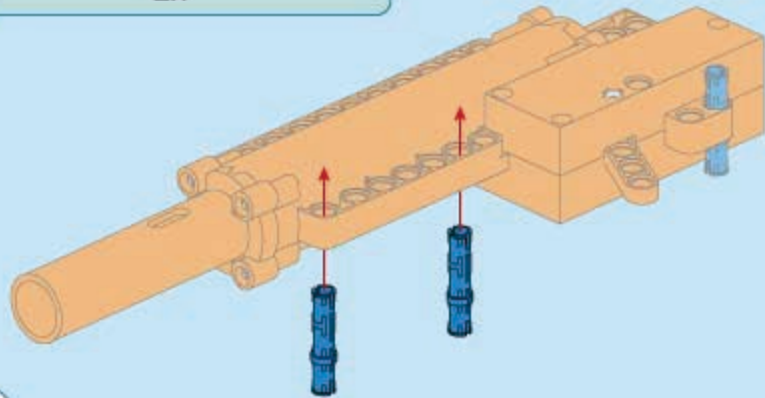

39



1x

4x

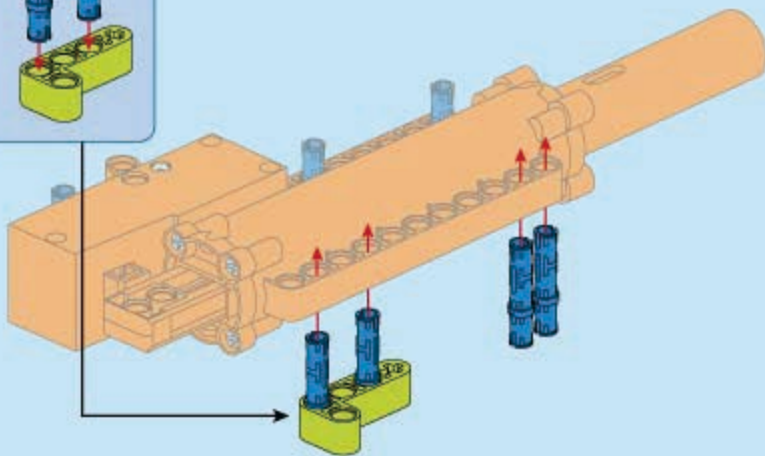
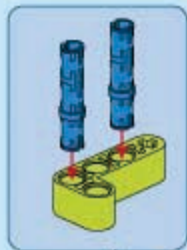

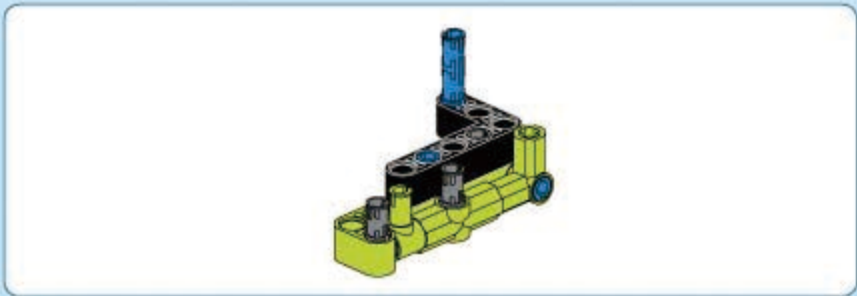

40



41

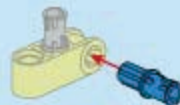

42

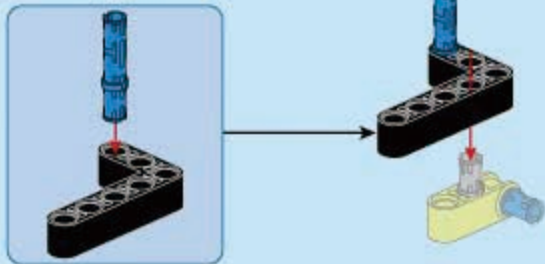

43

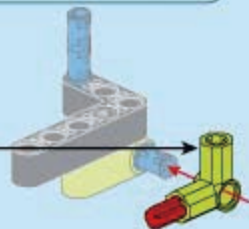
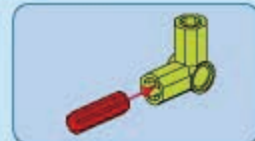

44

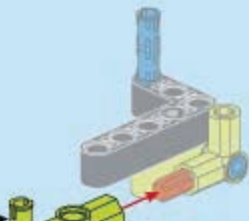
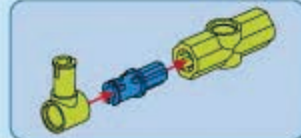

45

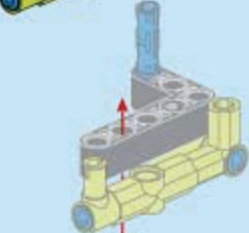
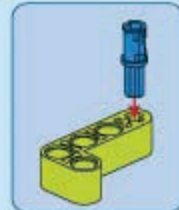
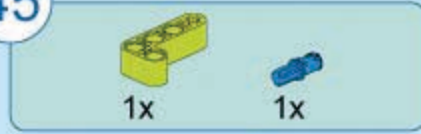

46

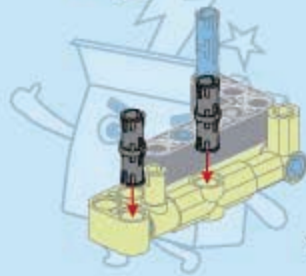

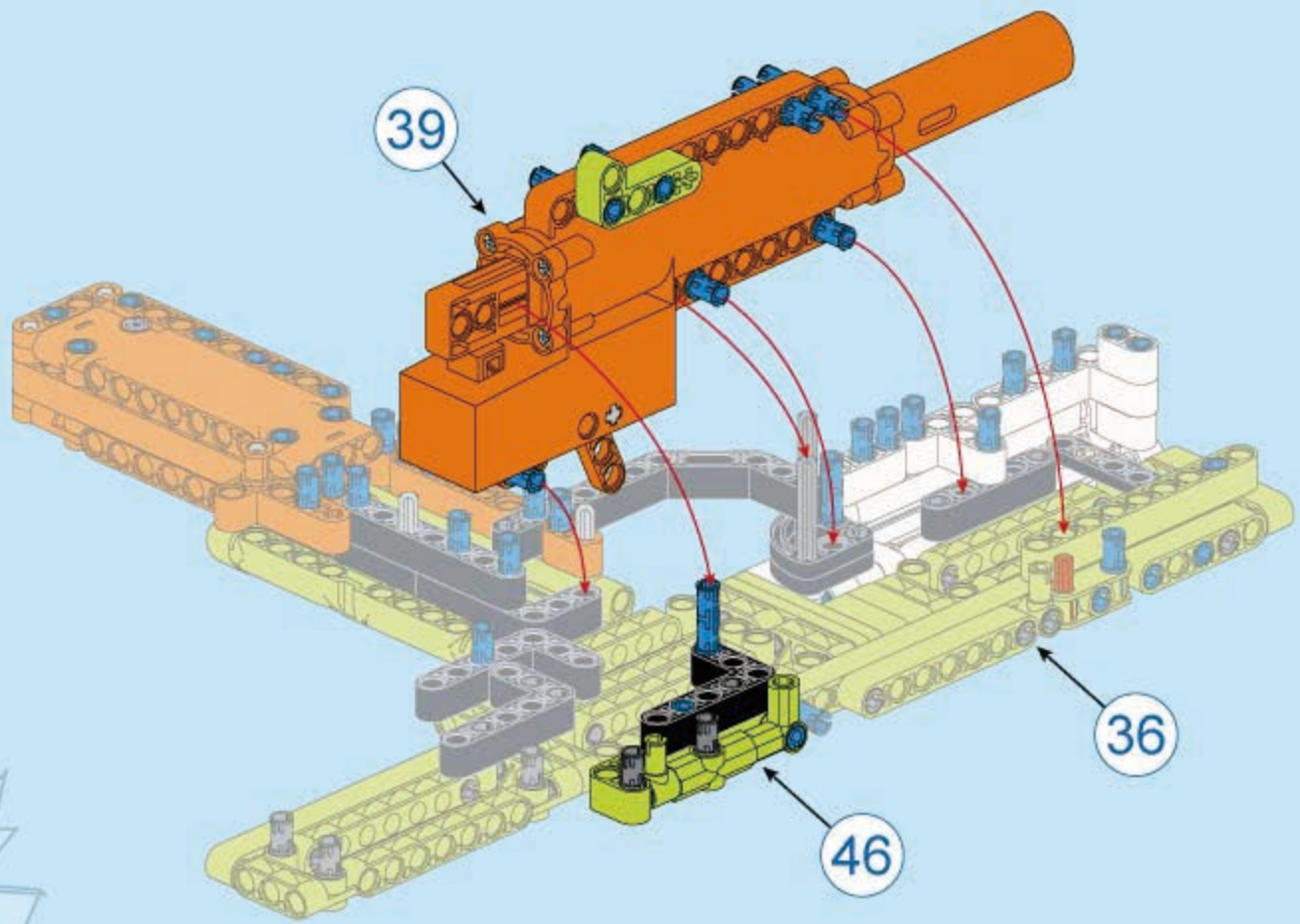



48

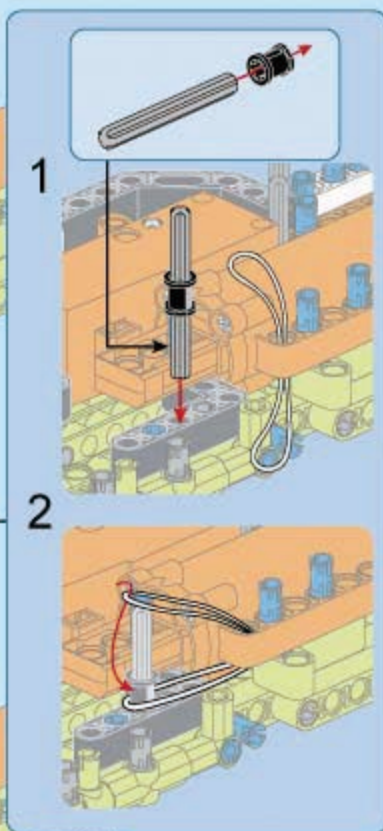
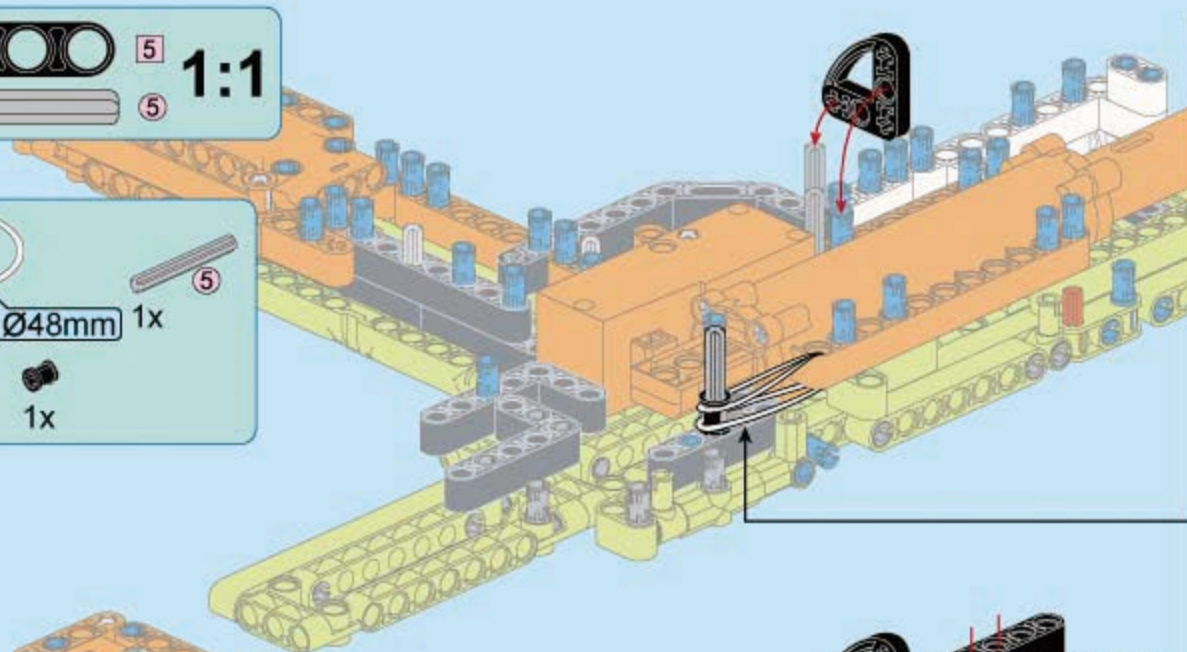

49

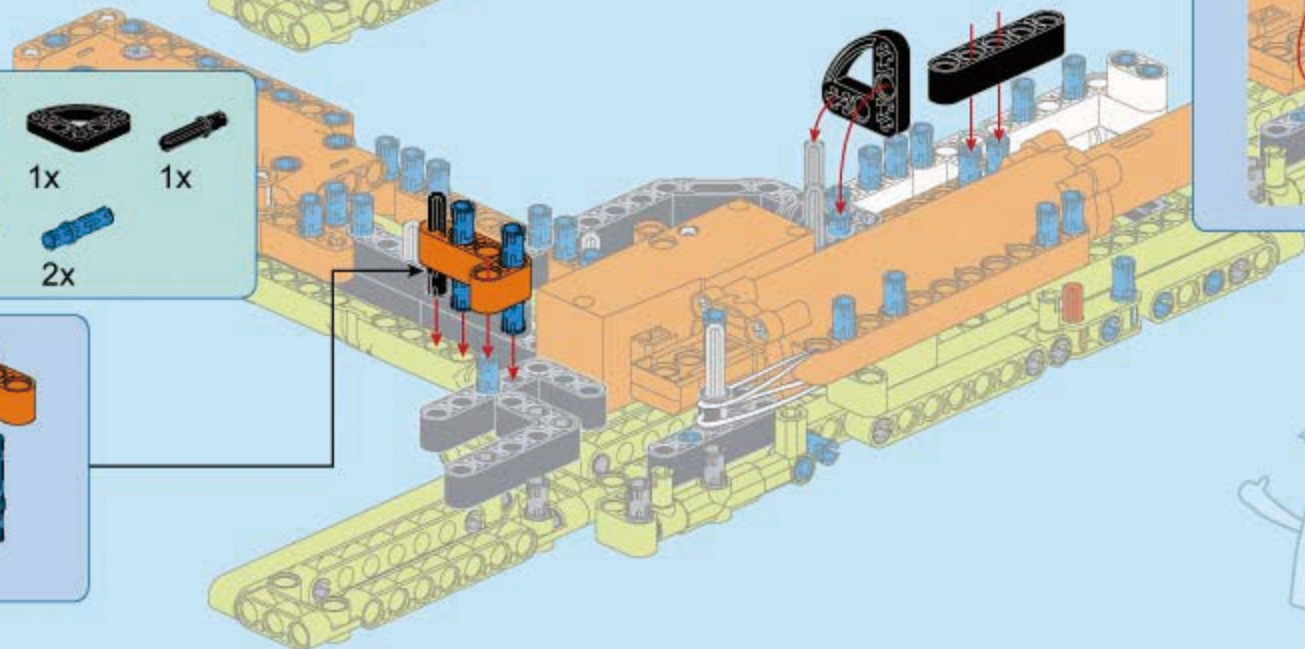
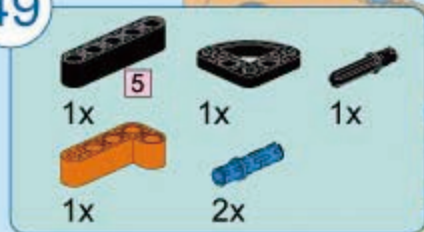

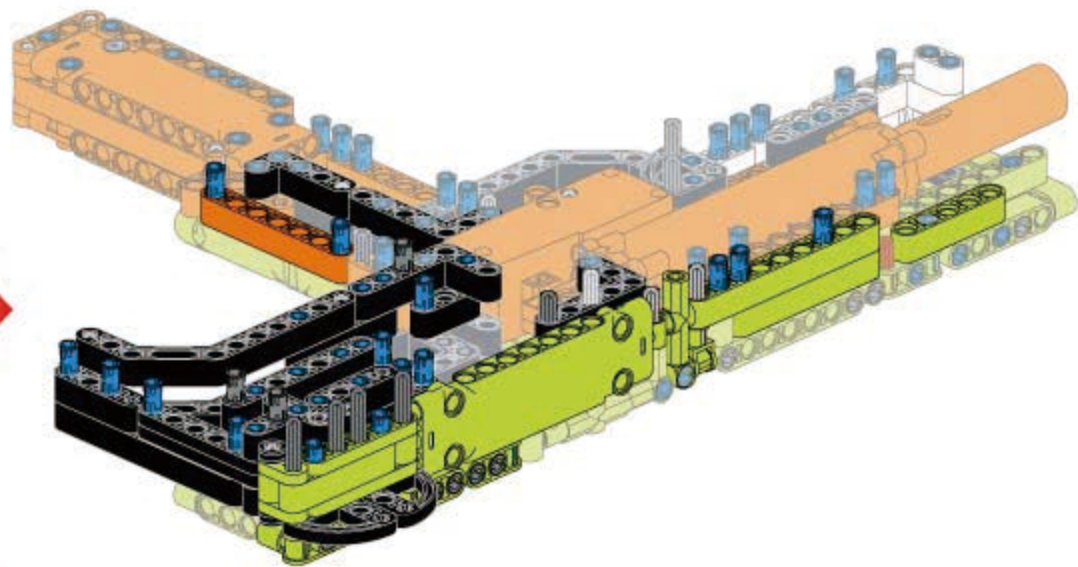

50



1x



1x



1x



1x



5 1:1

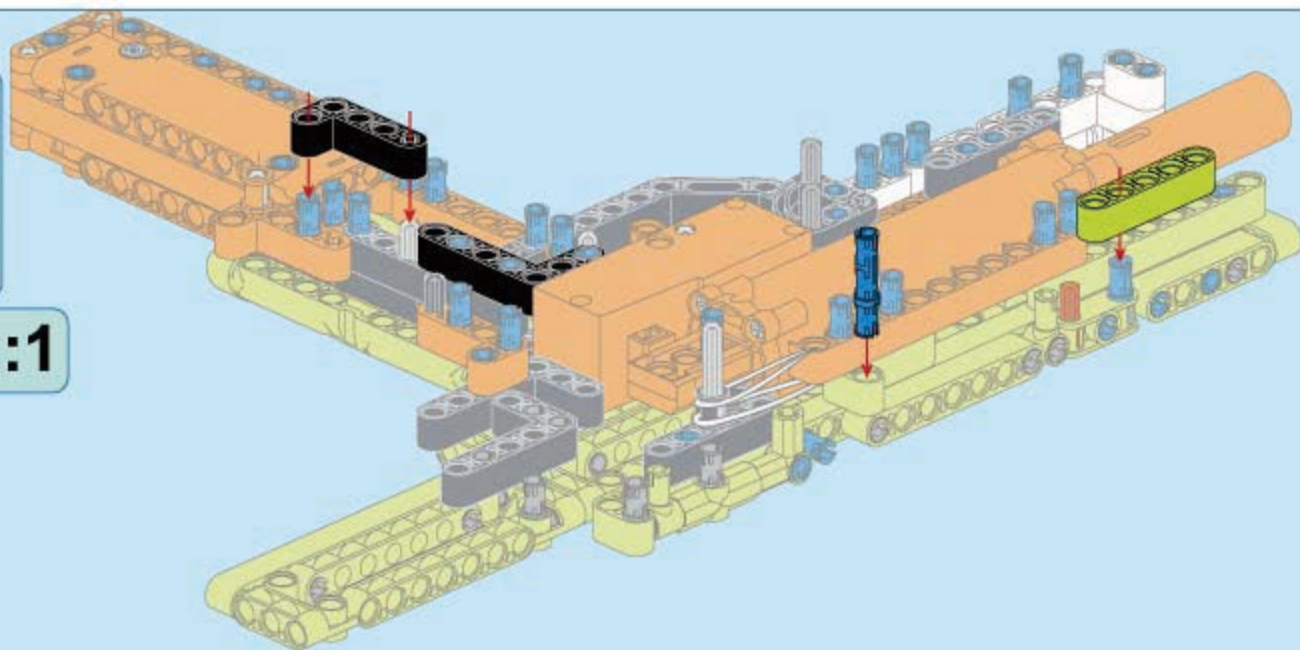

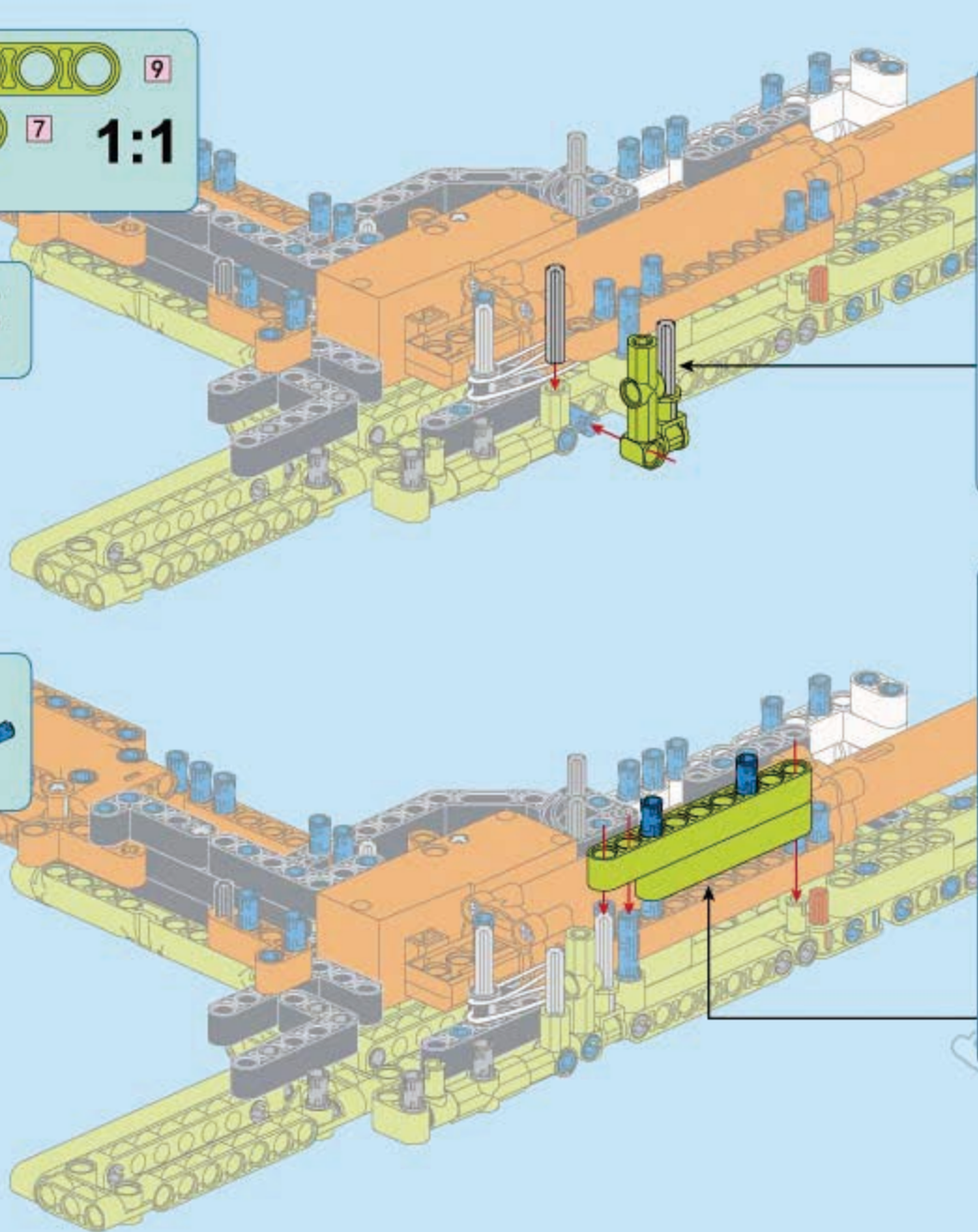
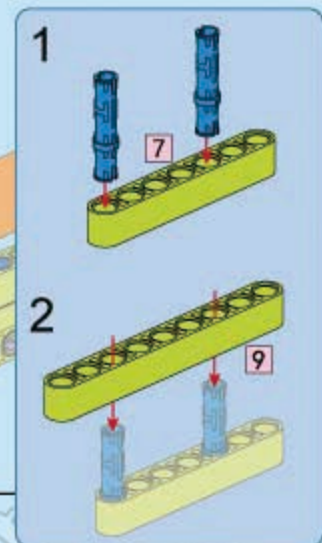
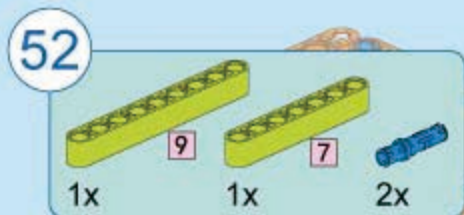
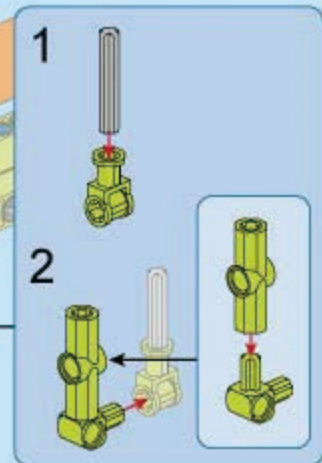
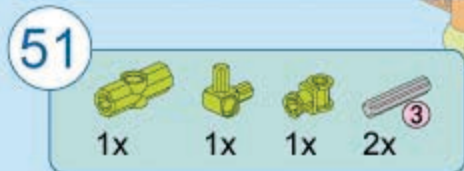
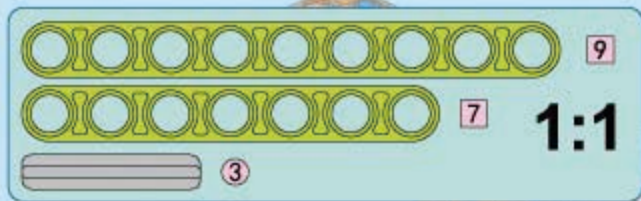



53

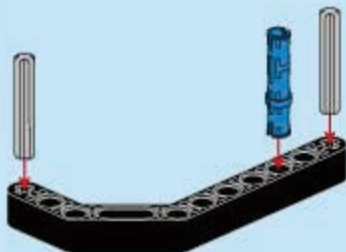

54

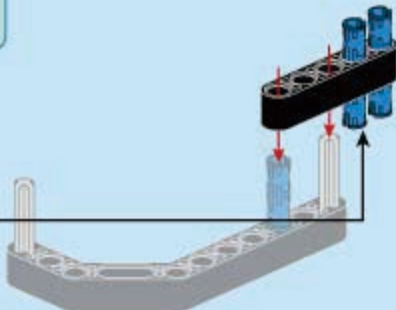
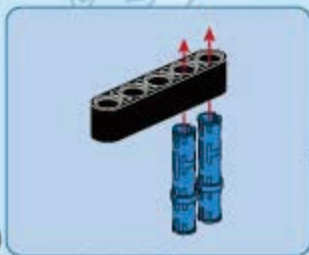

55

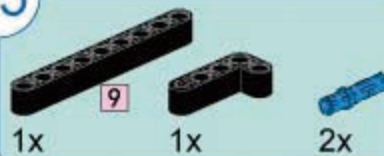

1

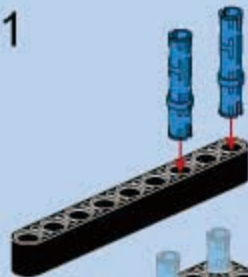

2

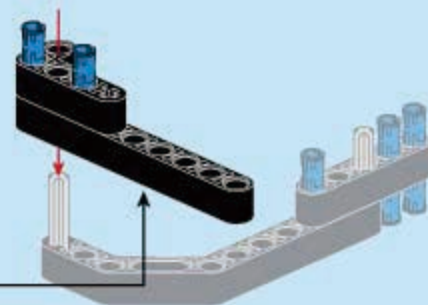
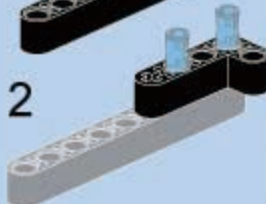

56

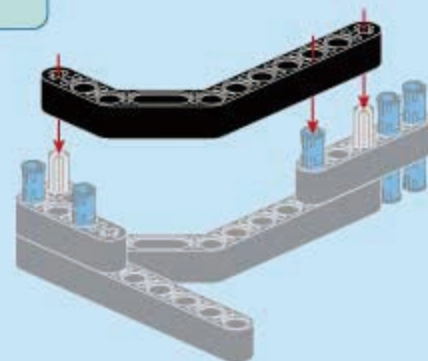

57

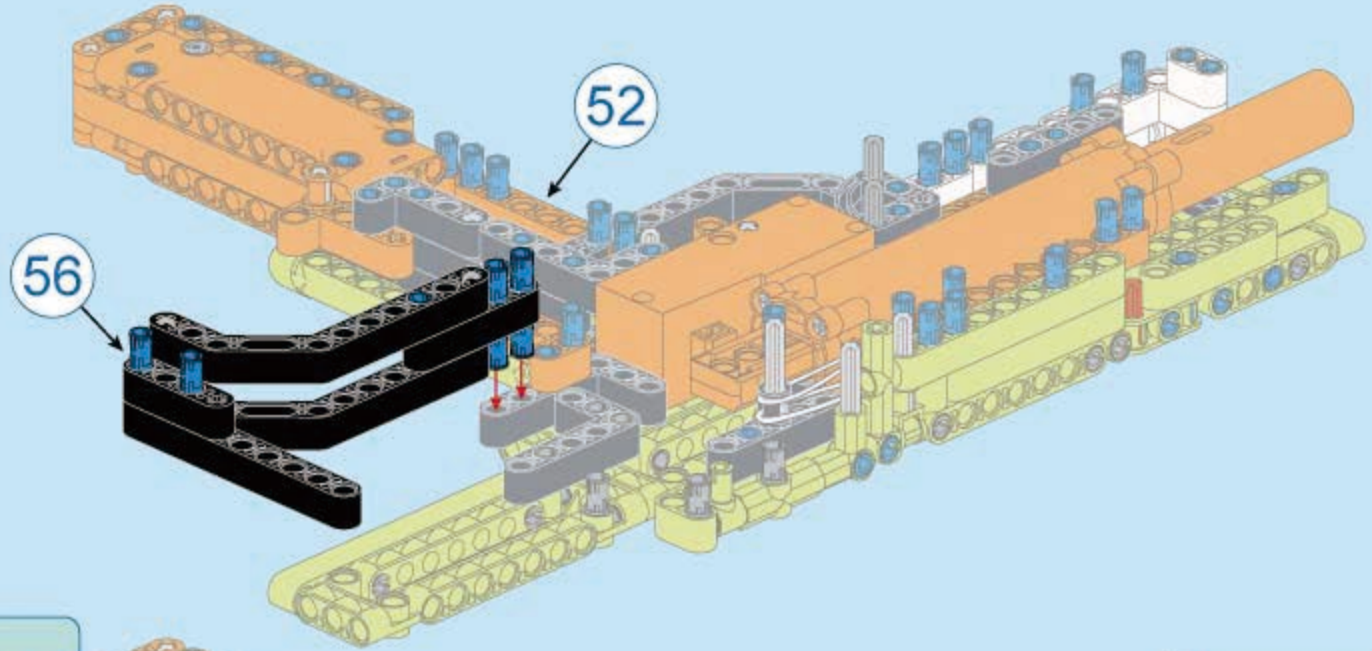

58

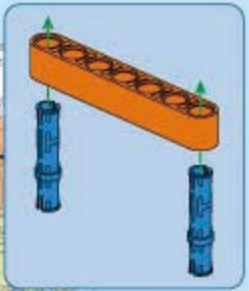
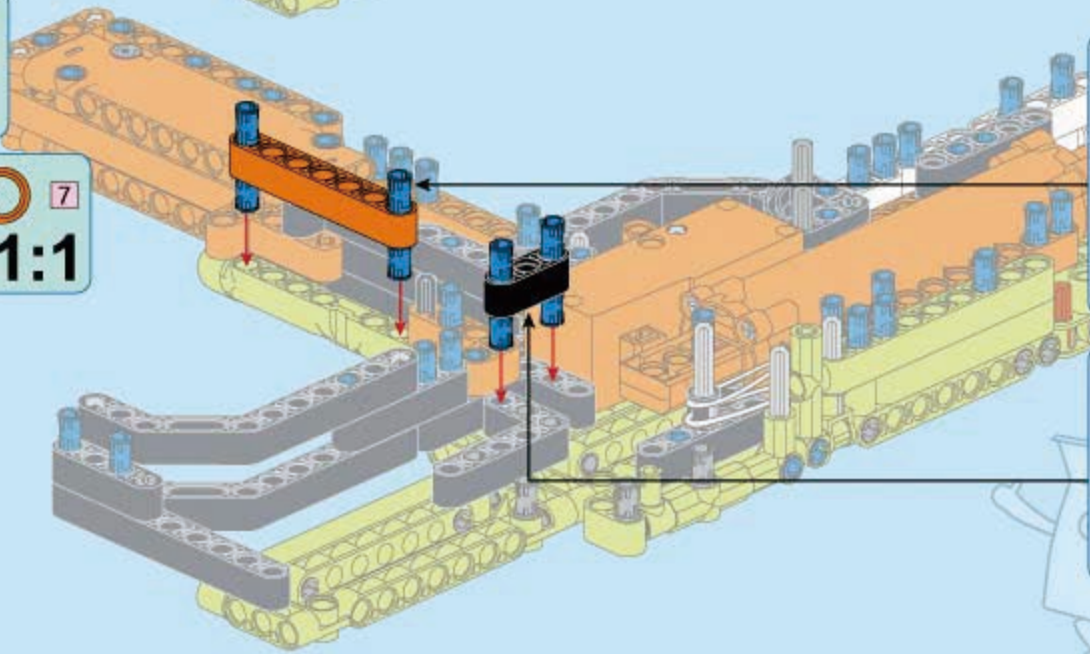
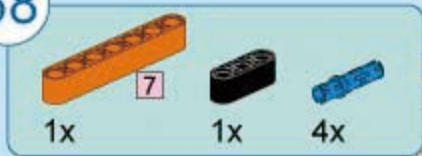

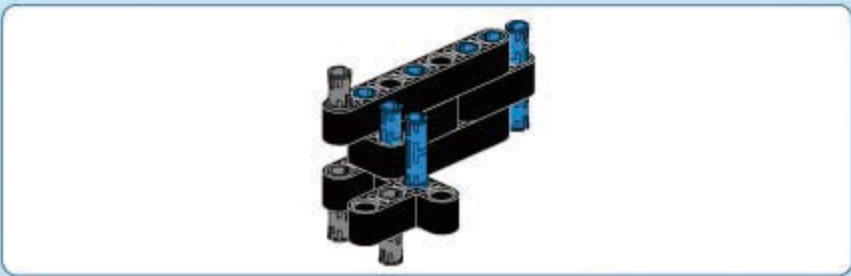

 **7** 1:1

59

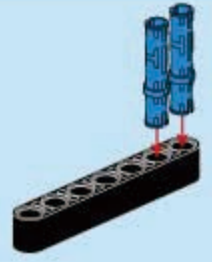

60

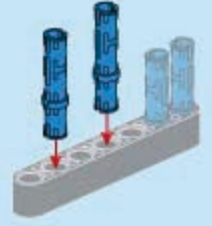

61

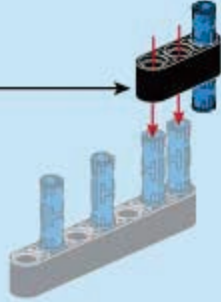

62

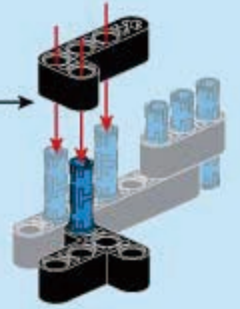
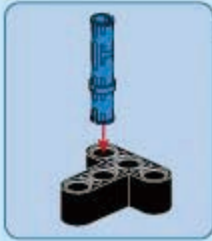

63

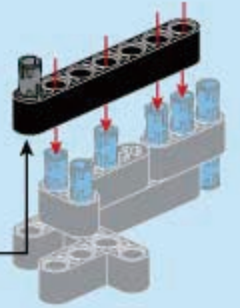

64

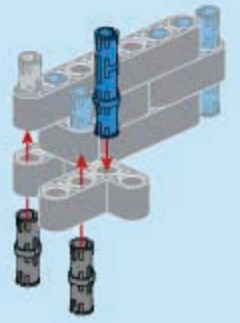

65

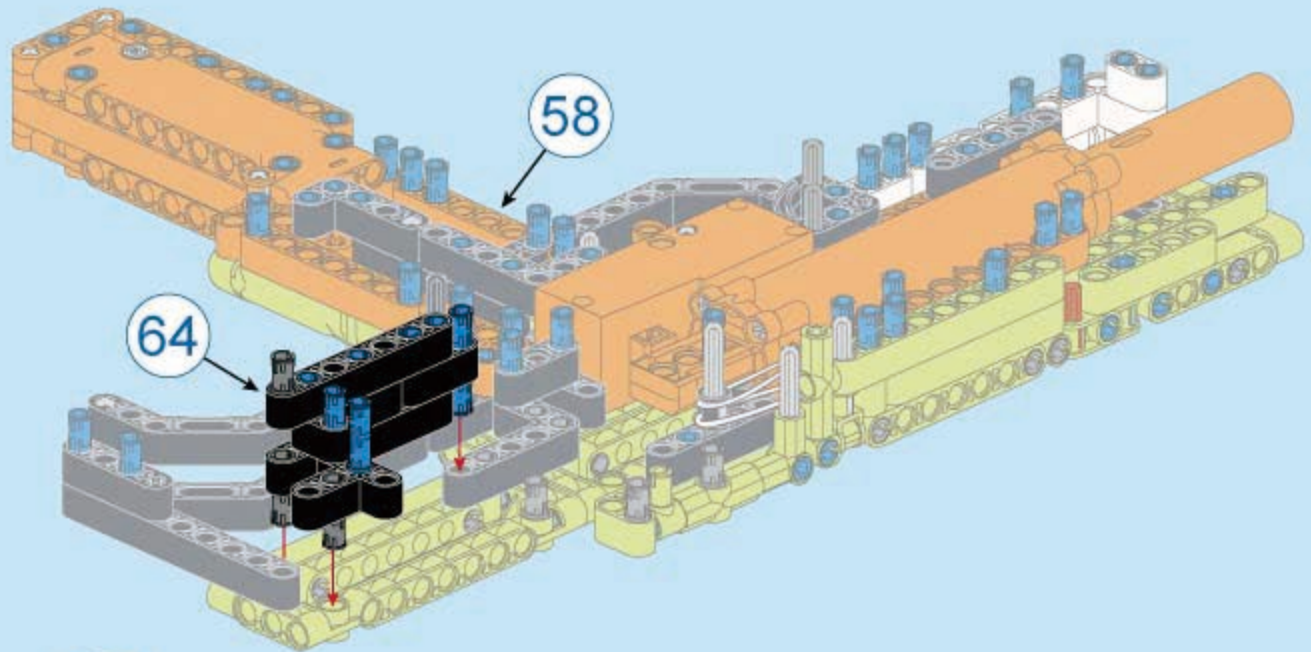

66

- 1x
- 2x
- 3x
- 1x

1:1

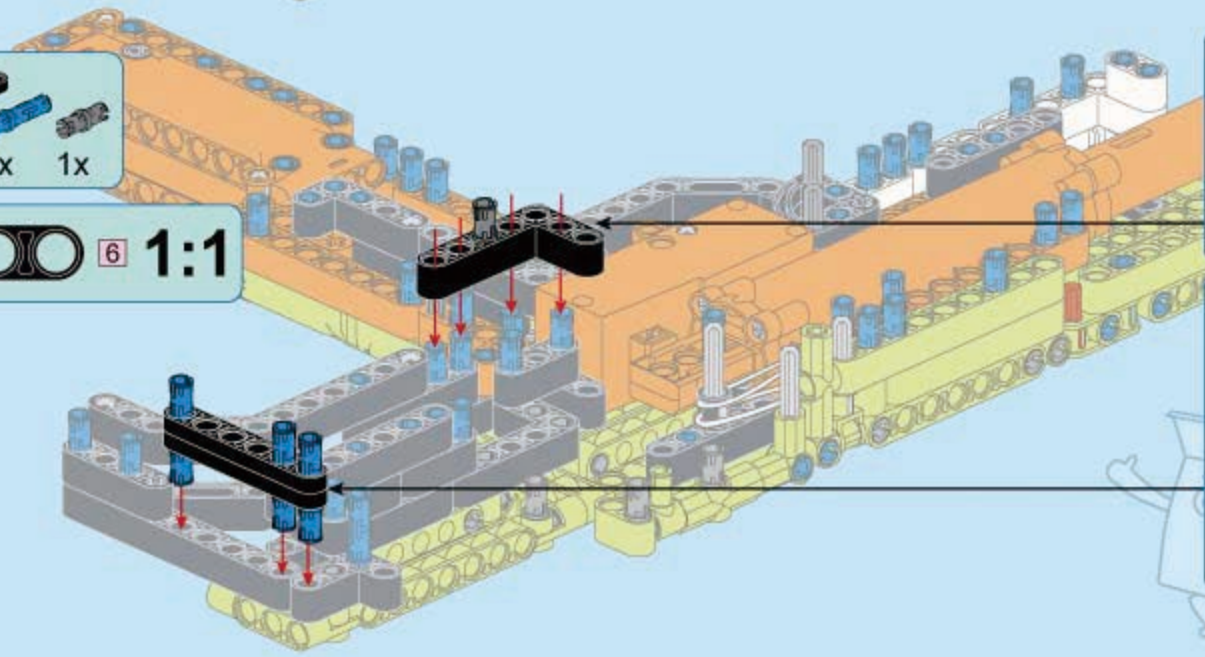

67

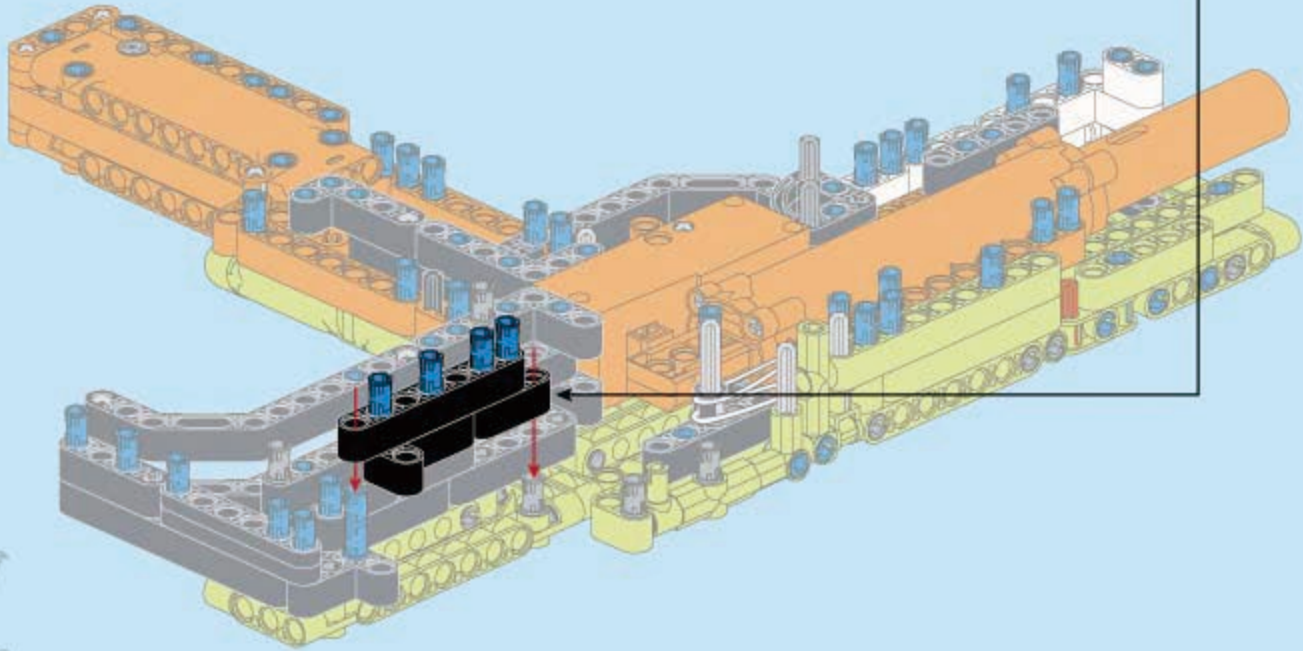
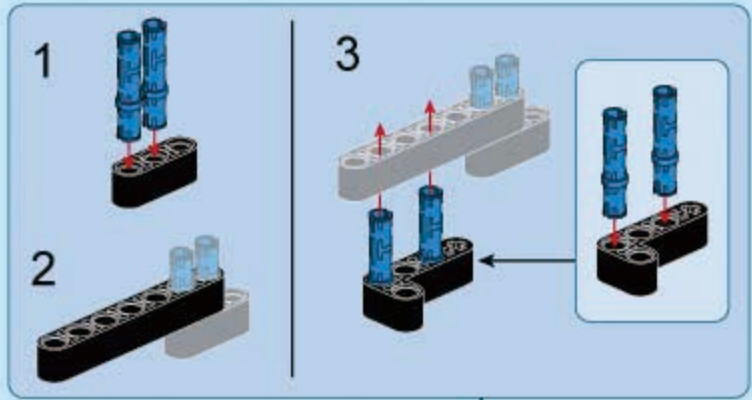

68

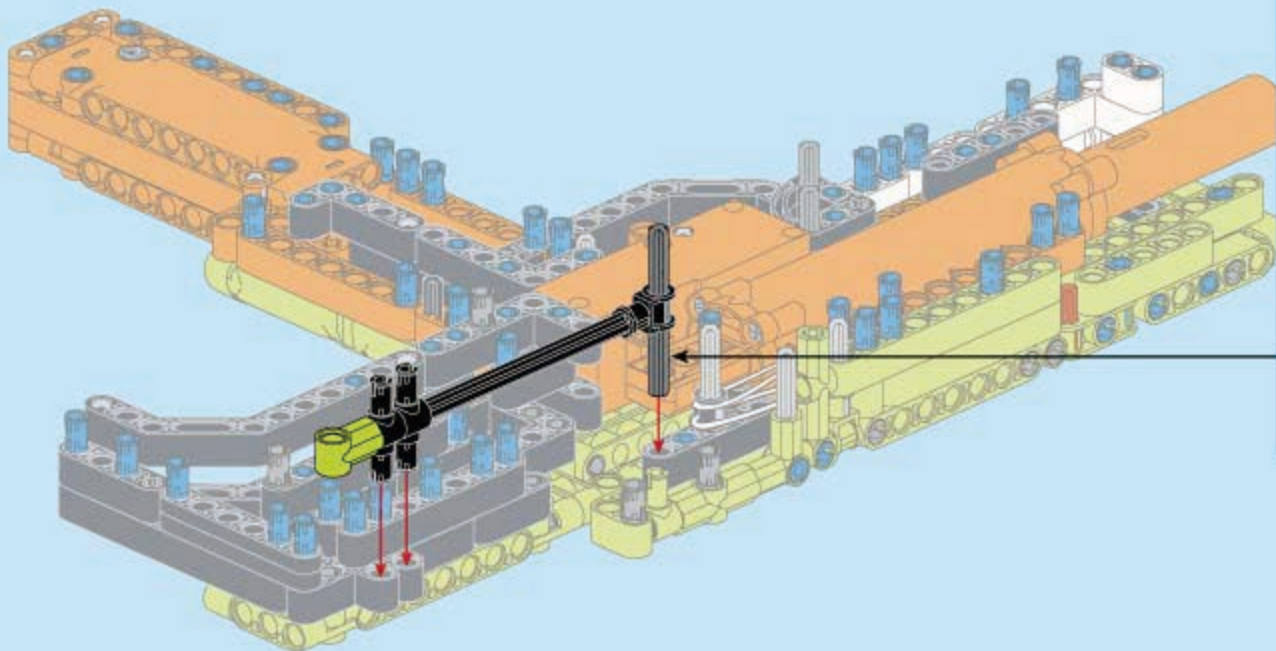

69



1x



1x



1x



1x

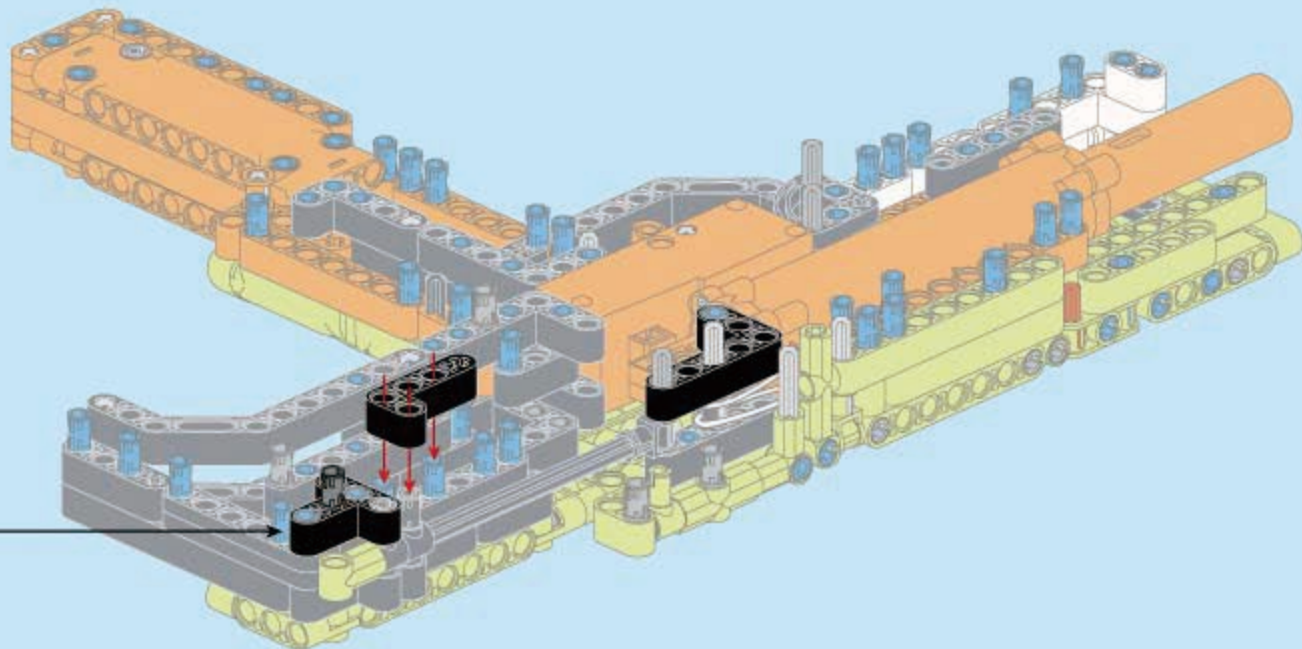

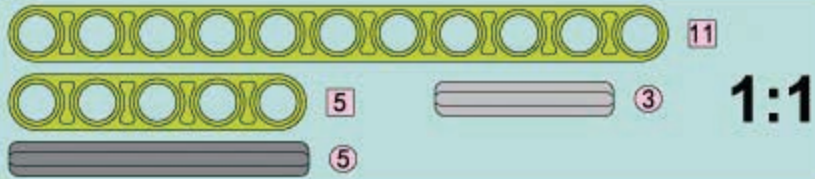
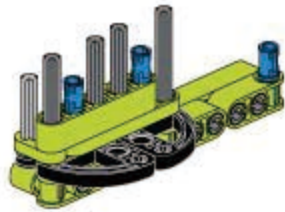

70

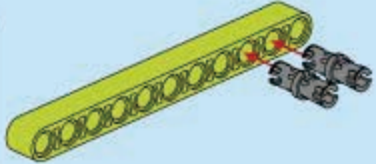
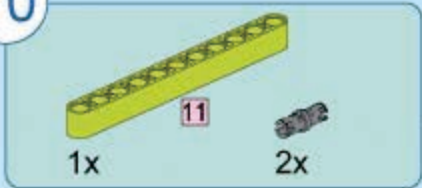

71

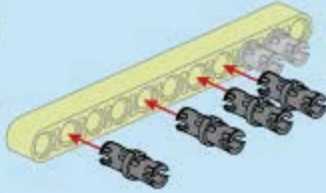

72

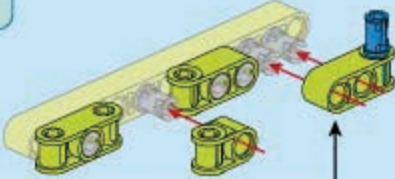

73

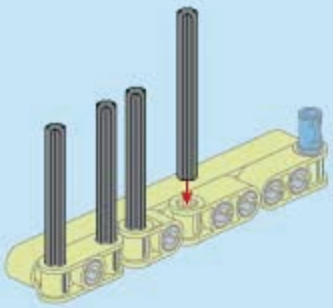

74

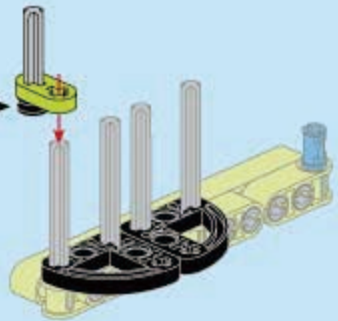

75

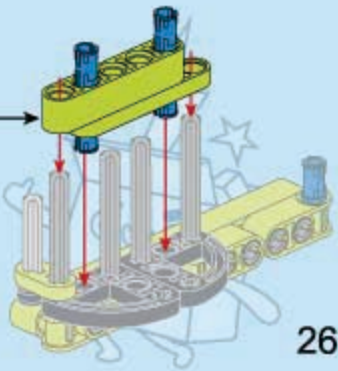
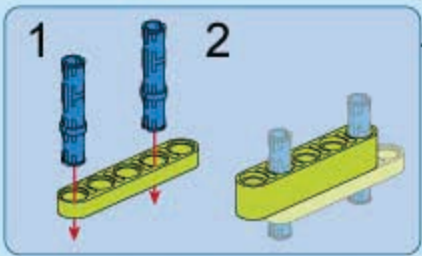
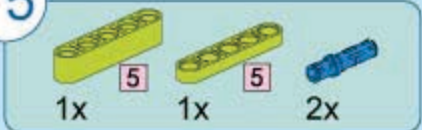

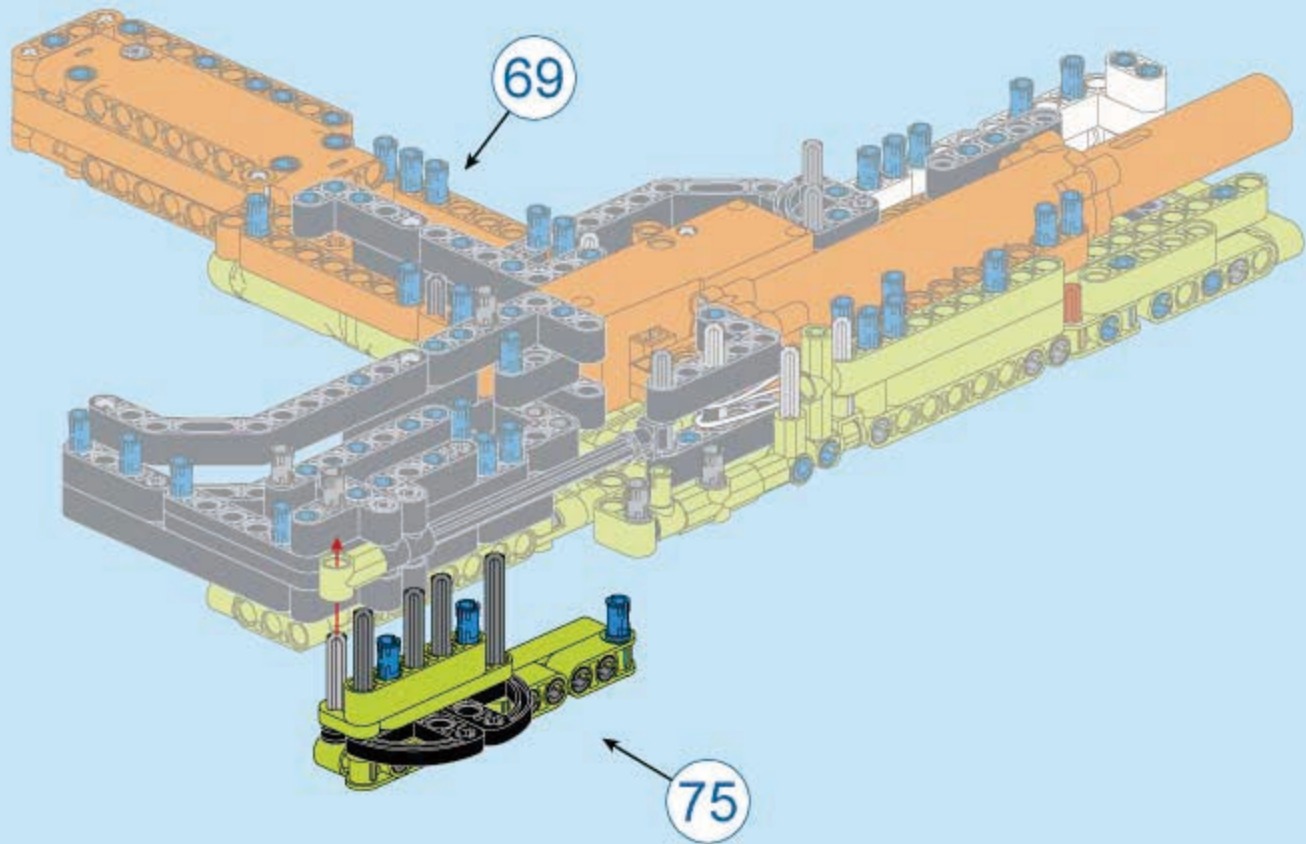

77

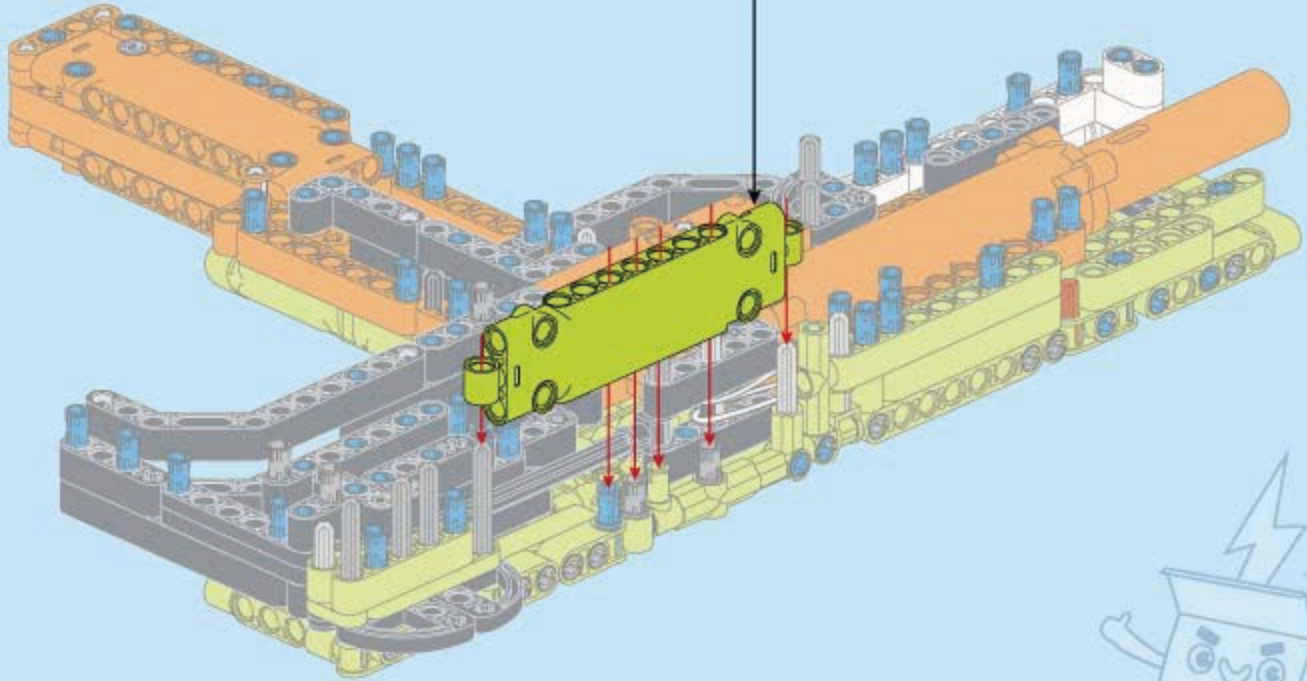
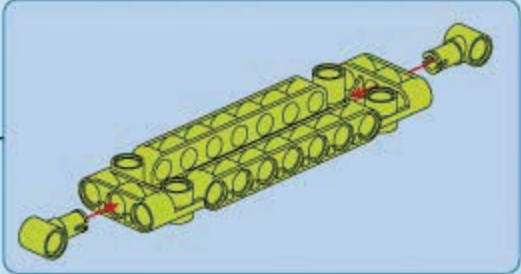
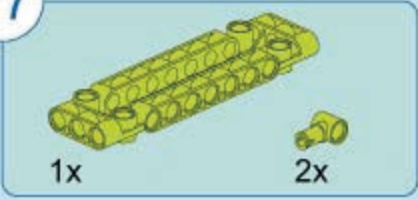

78



1x



1x



1x



5

1:1

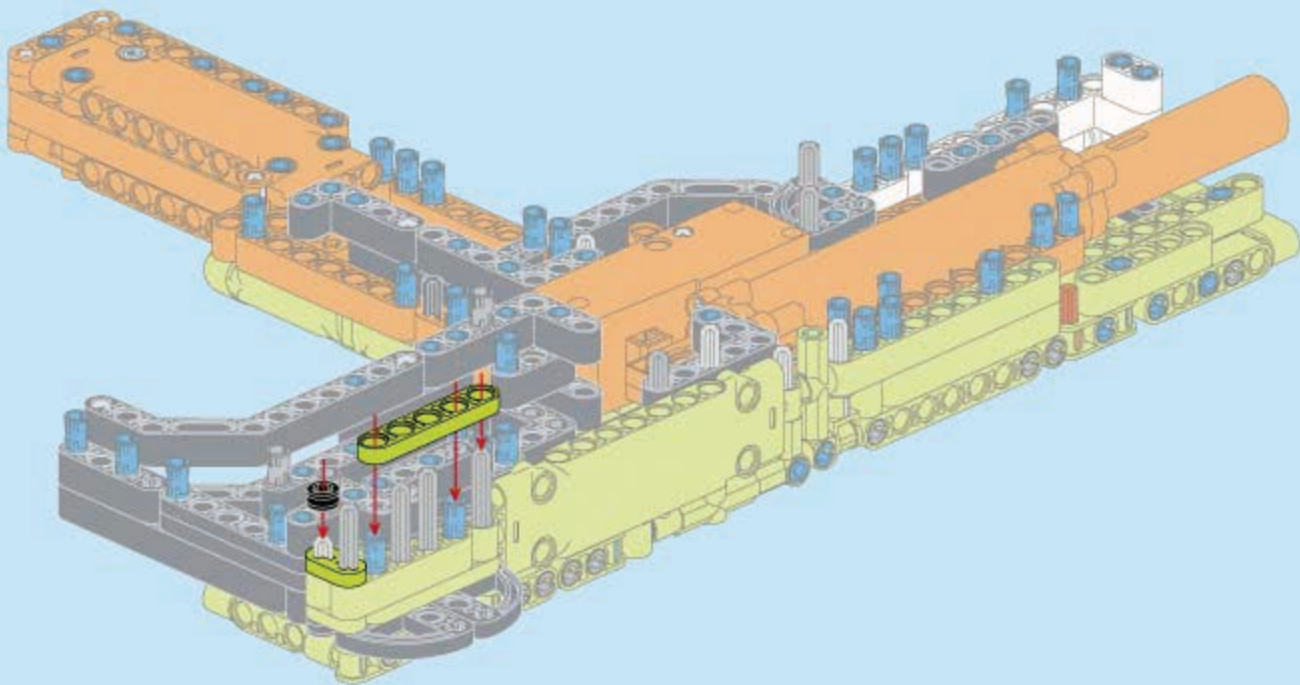

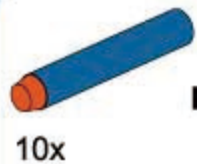

3

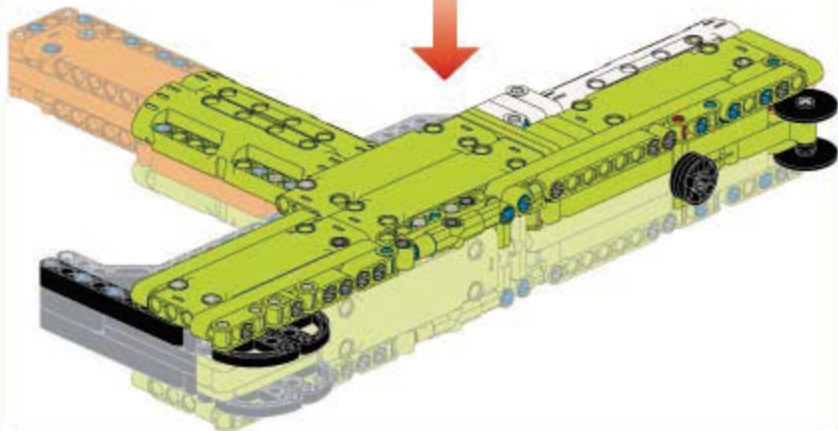

3

1:1



2

79



1x



2x



1x

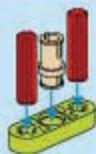

80



1x



81



1x



1x



82



2x



2x



1x

3



1



2



83



2x



1x

3

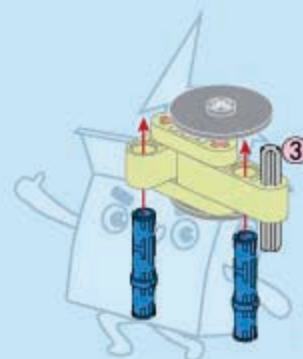

84

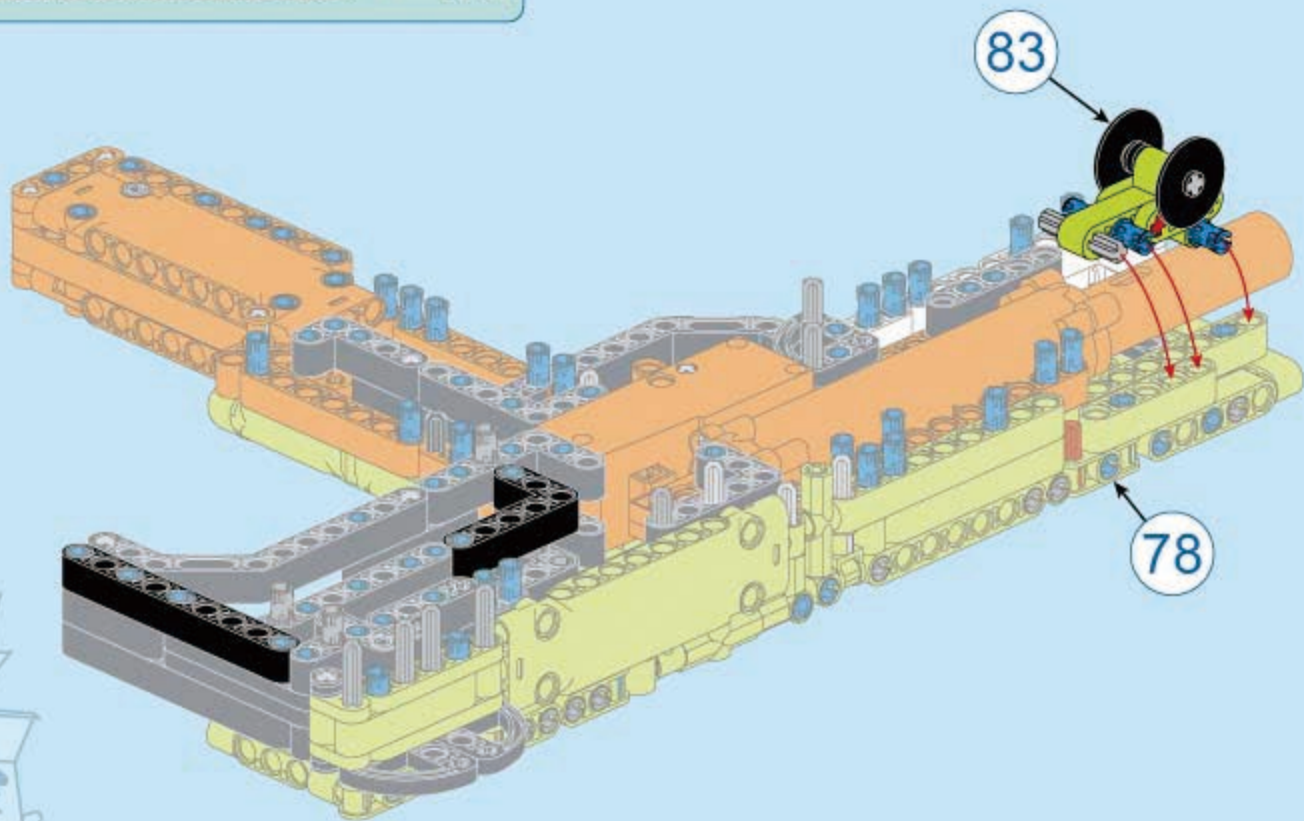
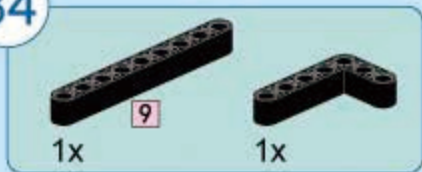

85

- 1x
- 1x
- 1x
- 2x
- 1x

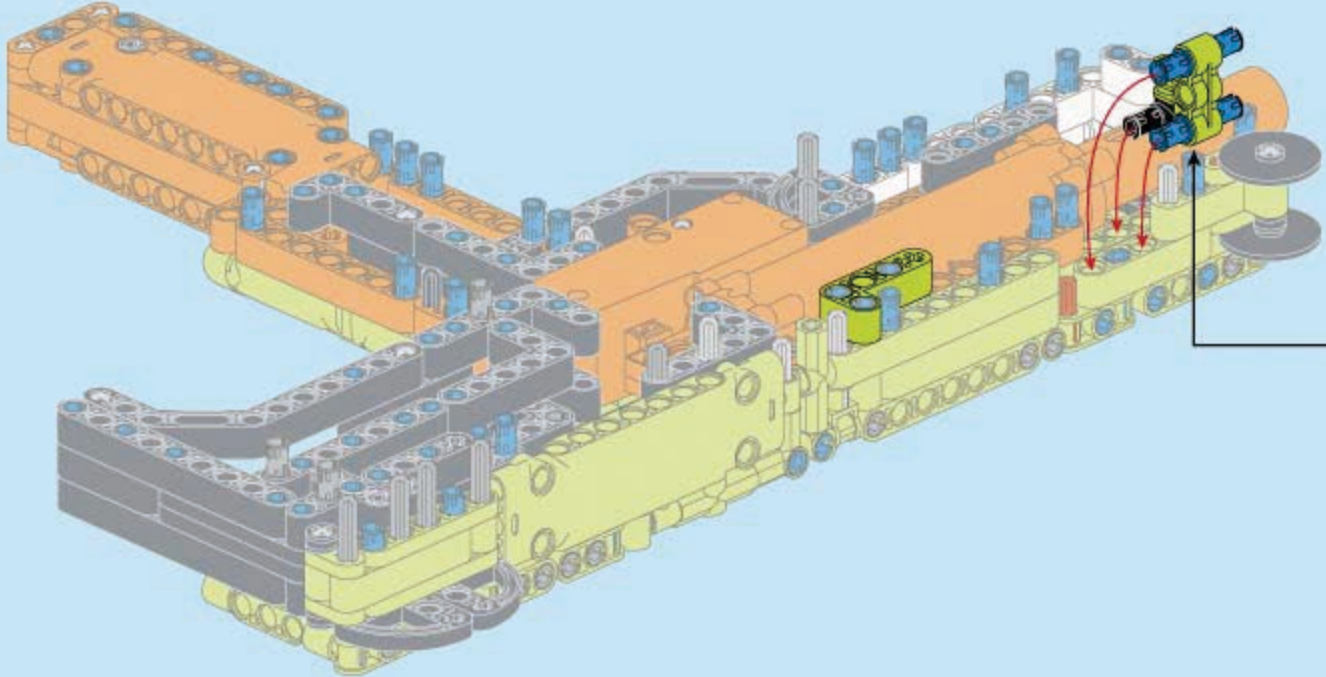

-
-
-



86

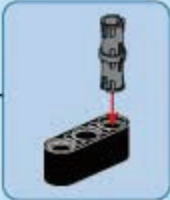
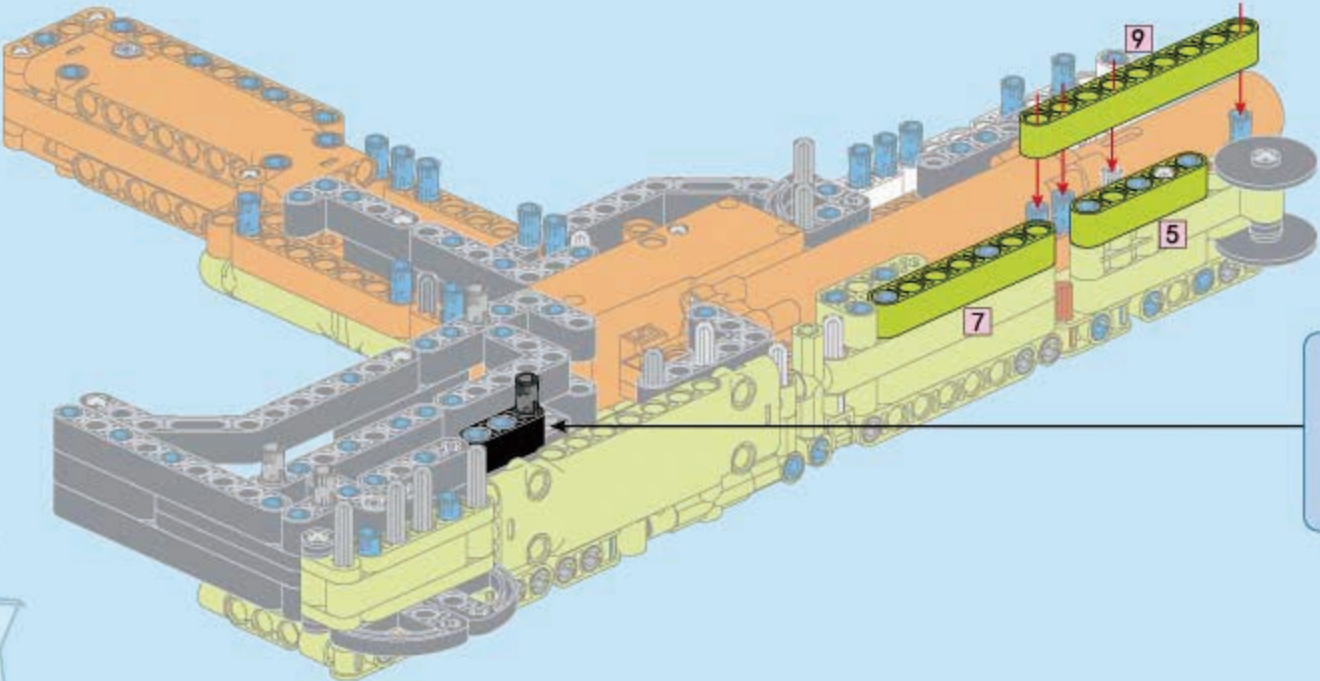
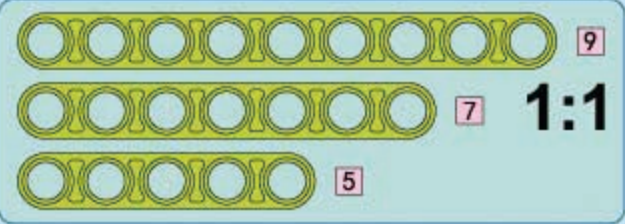
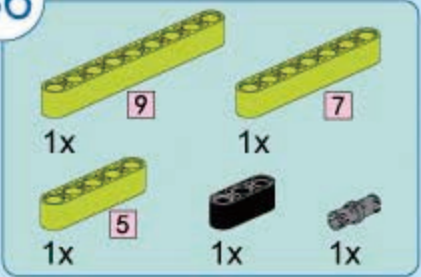

87



2x



1x



1x



1x

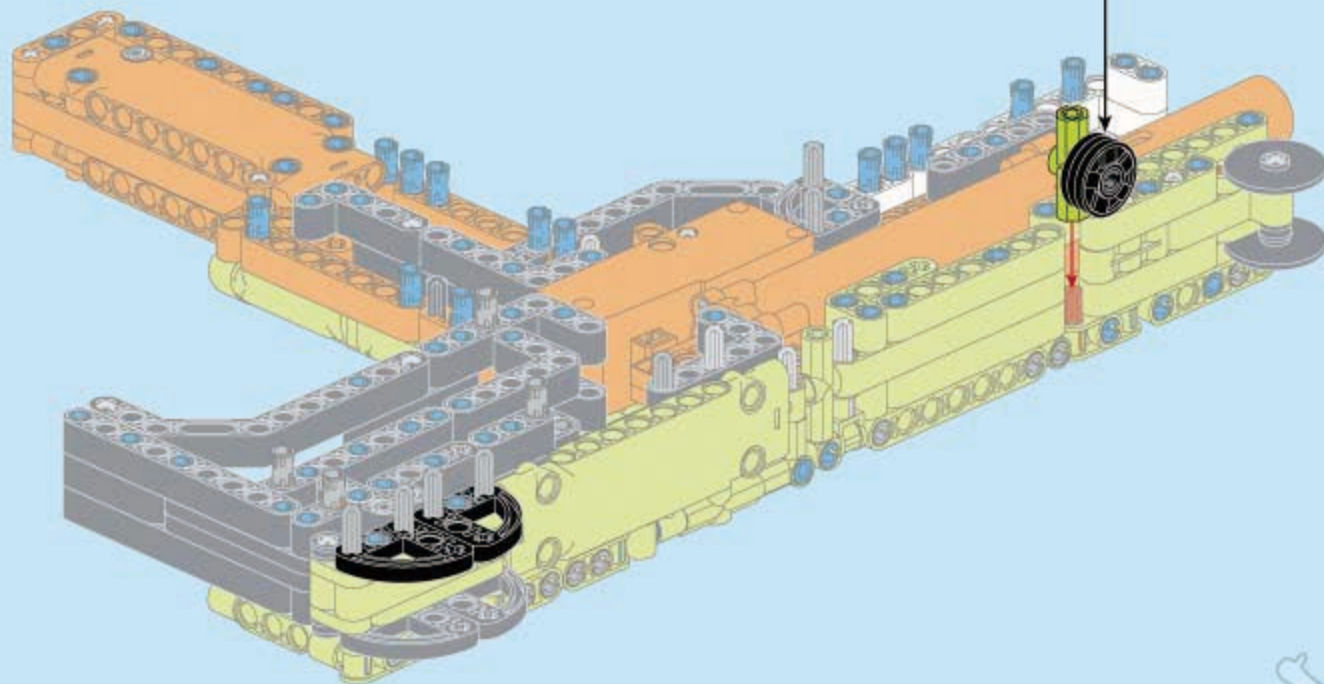

1

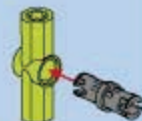

2



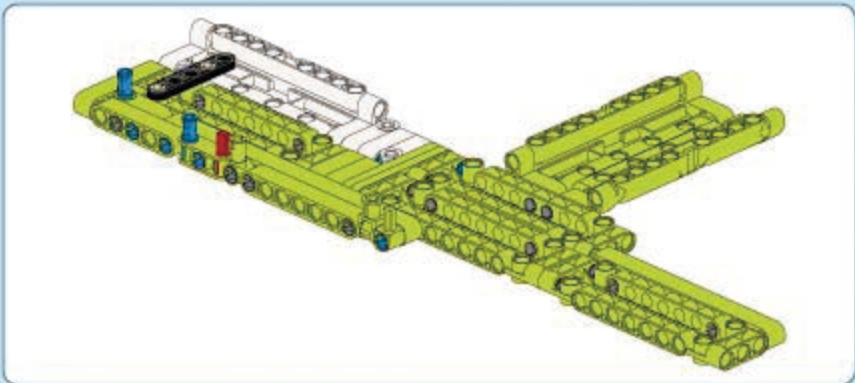

88

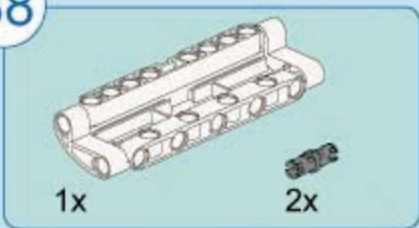

89



90

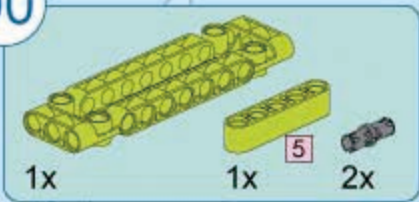

35

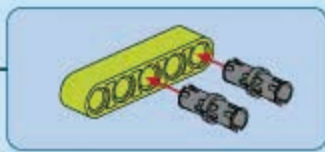
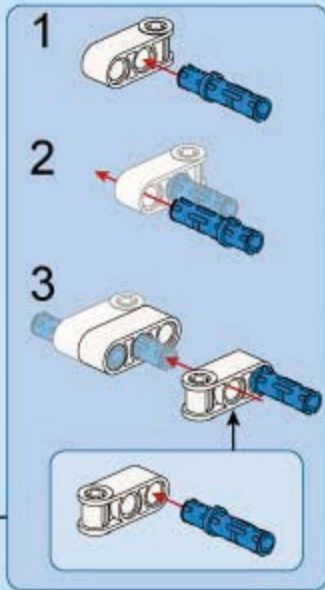
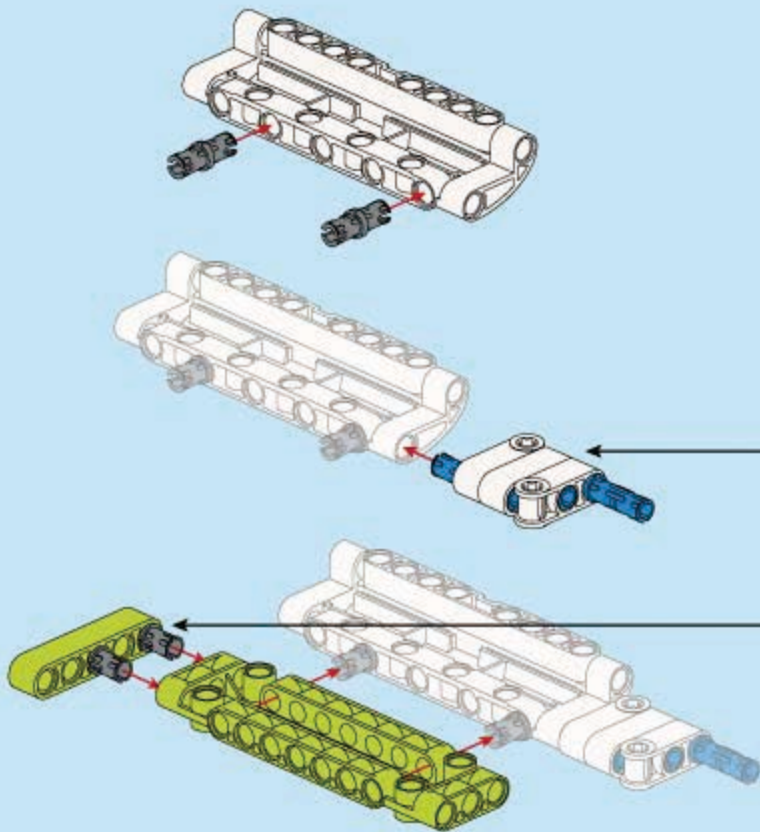

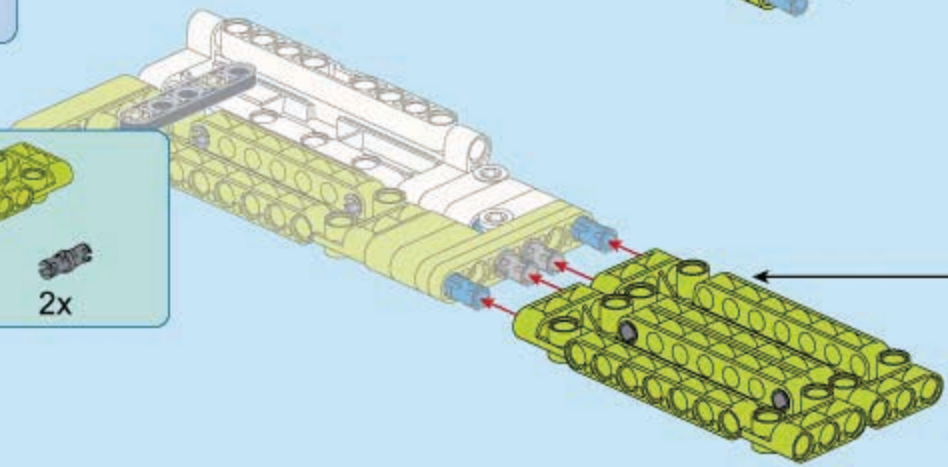
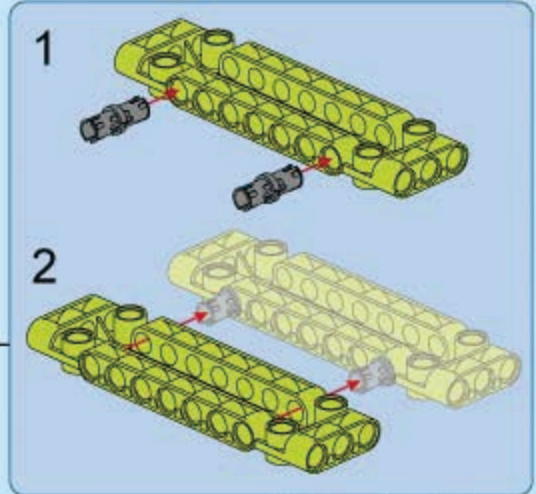
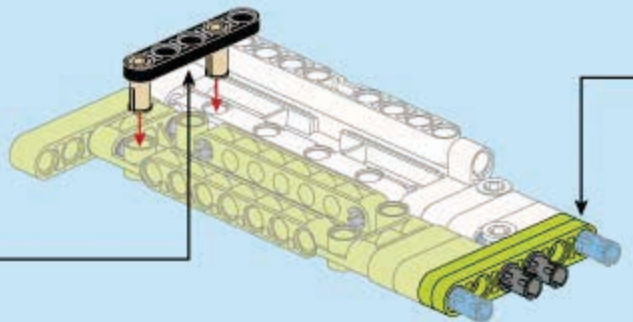
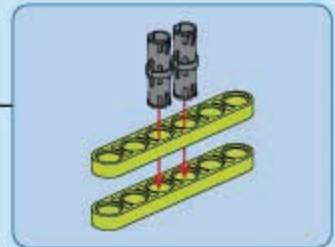
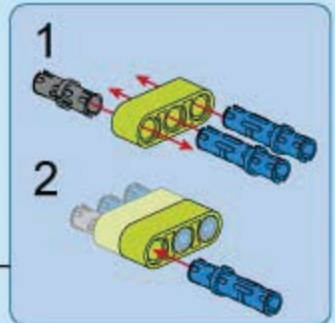
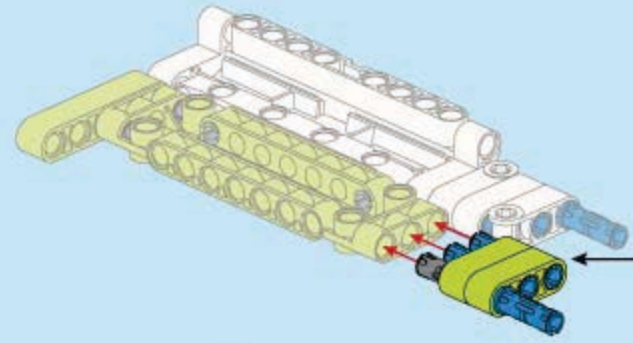
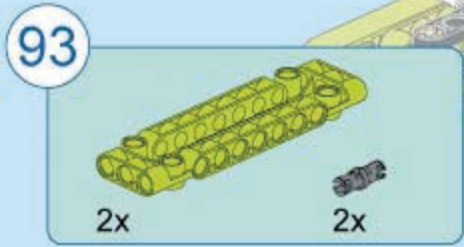
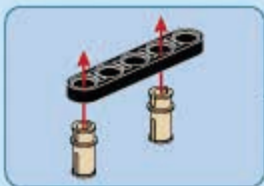
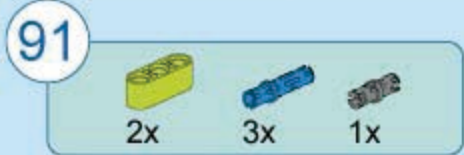
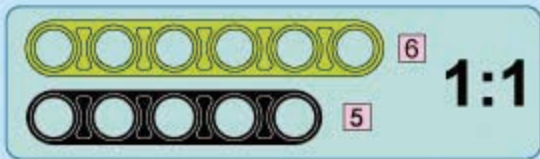



15 1:1

94



4x

95



15

1x



1x



1x



1x

96



5x

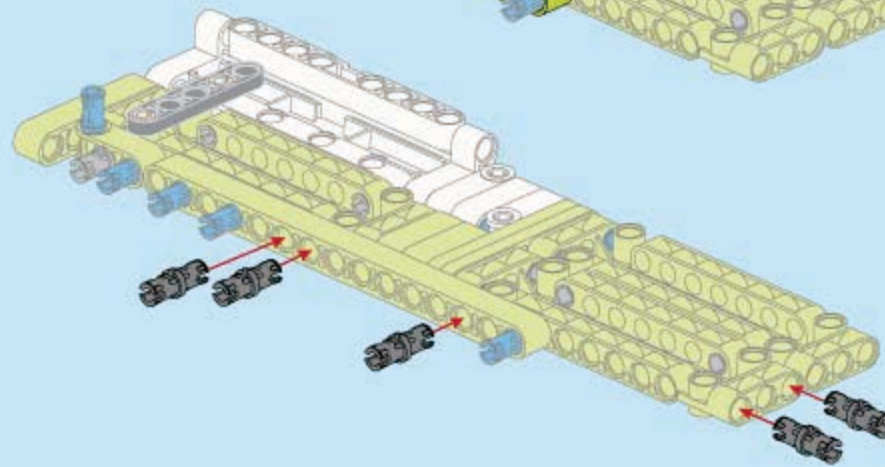
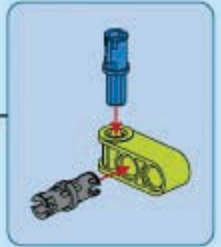
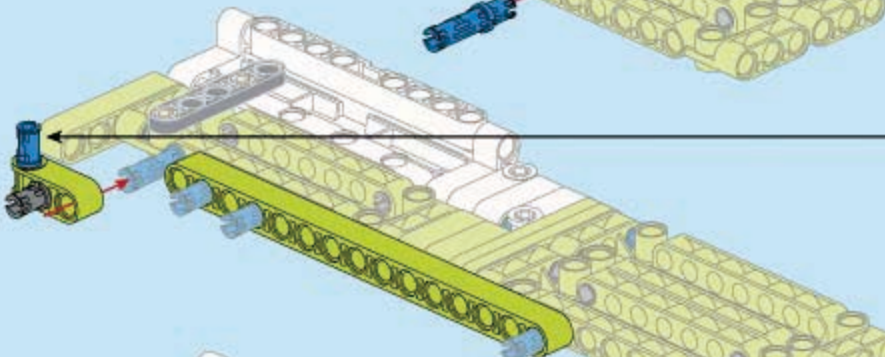
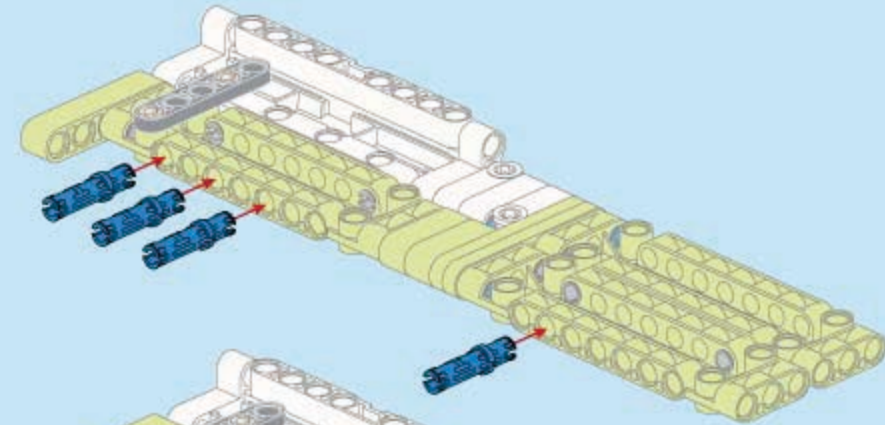

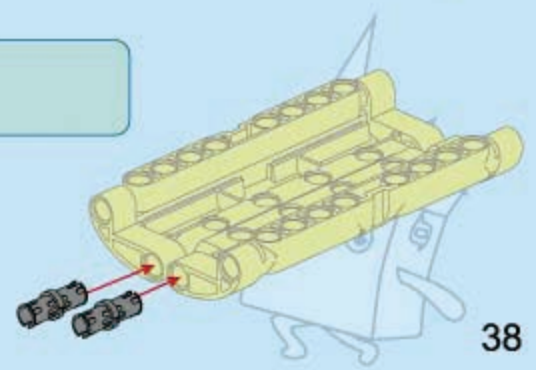
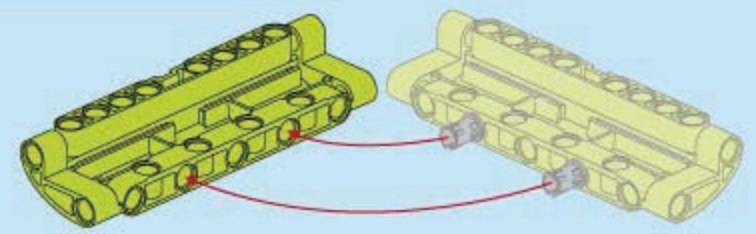
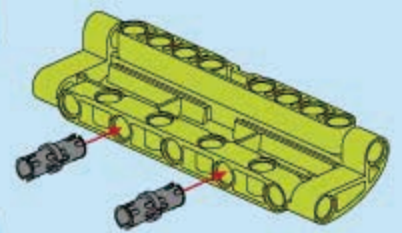
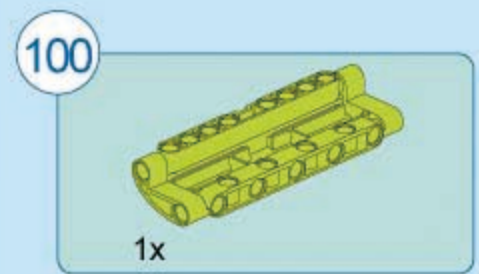
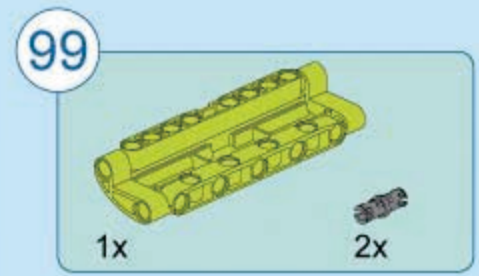
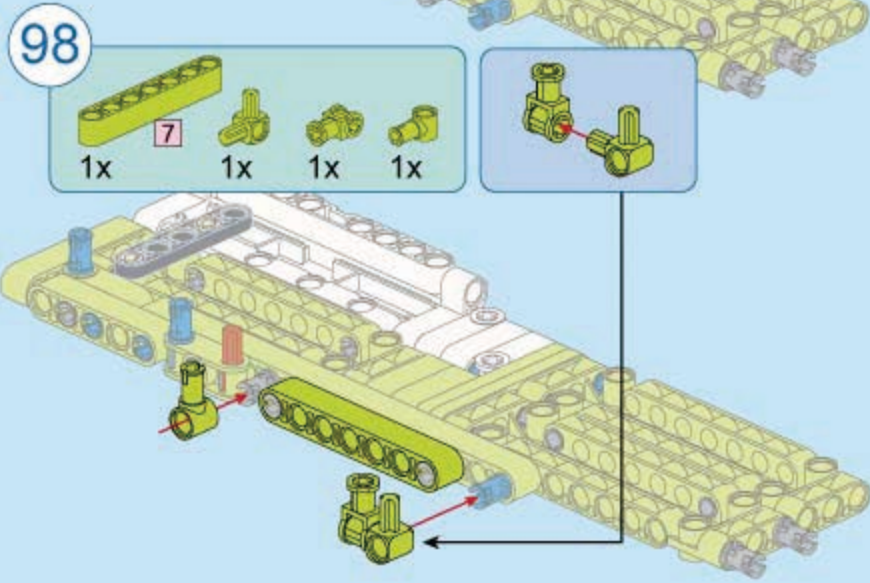
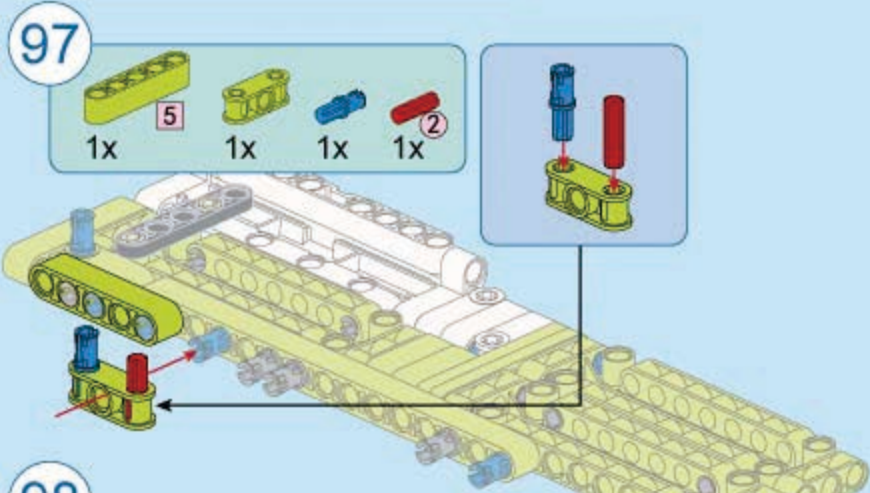
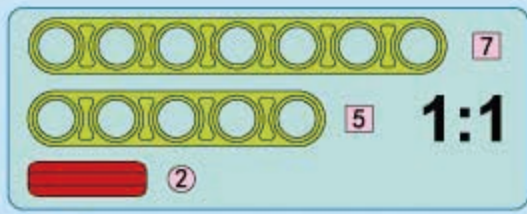

102

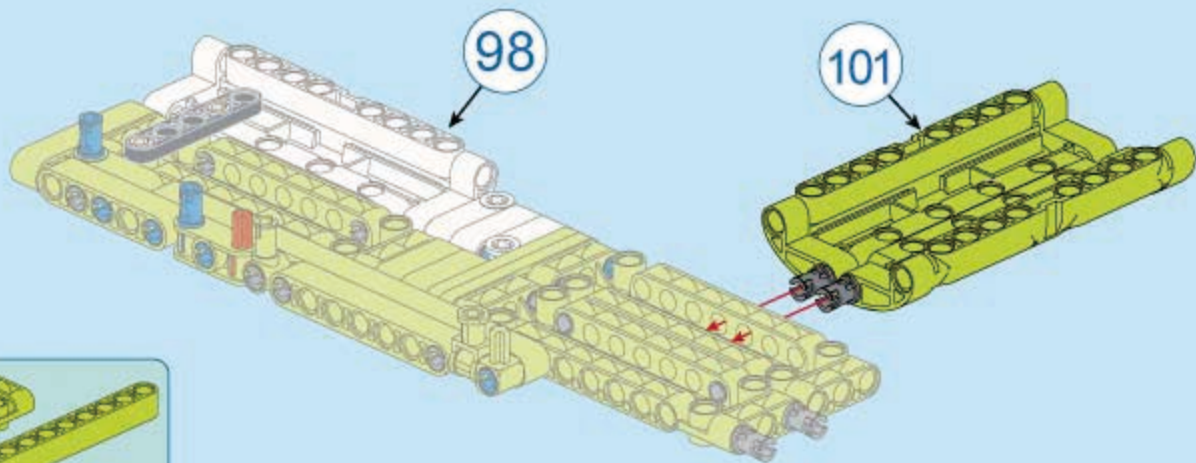

103

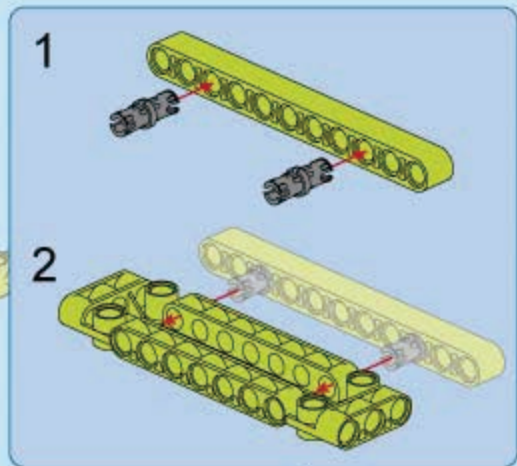
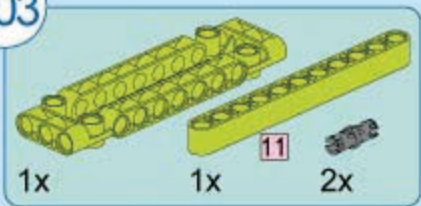

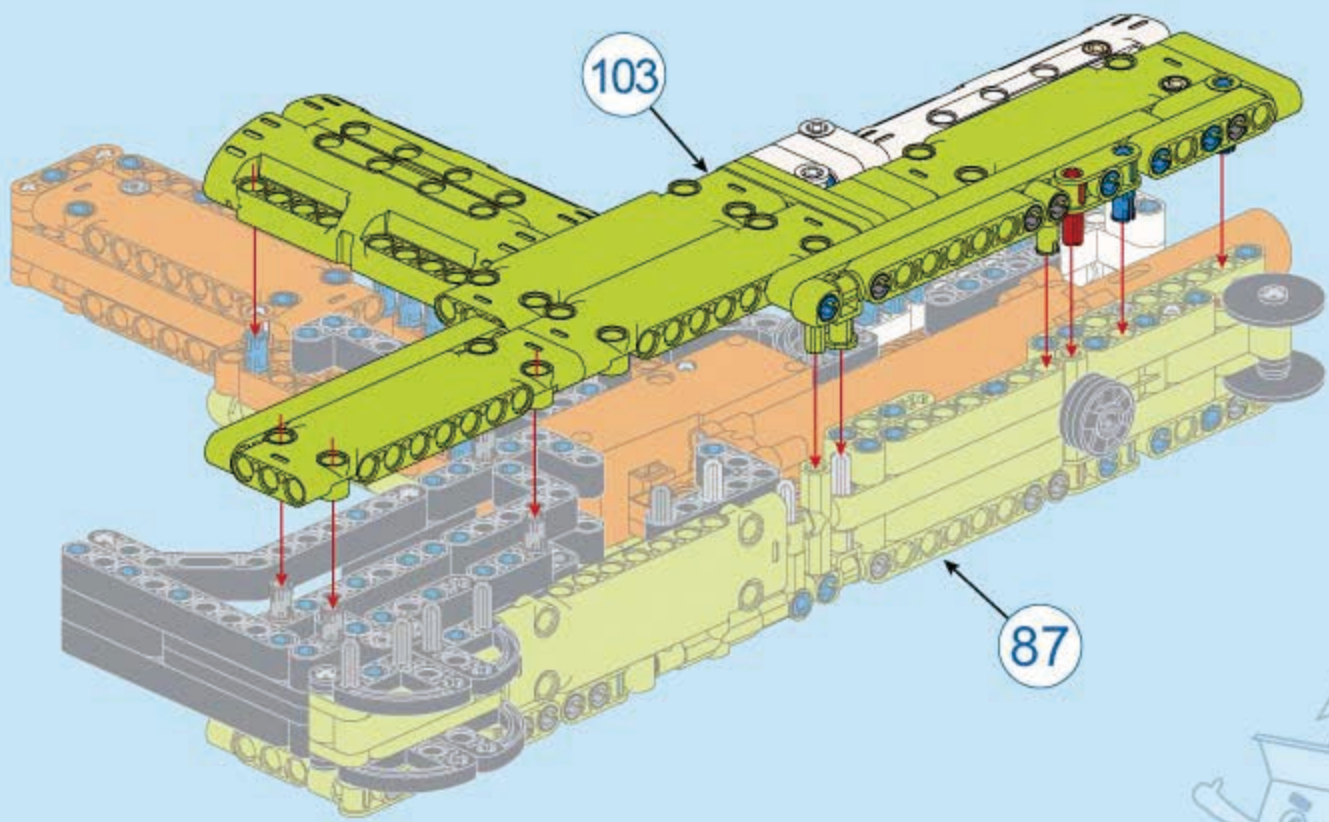

105



1x



1x



1x

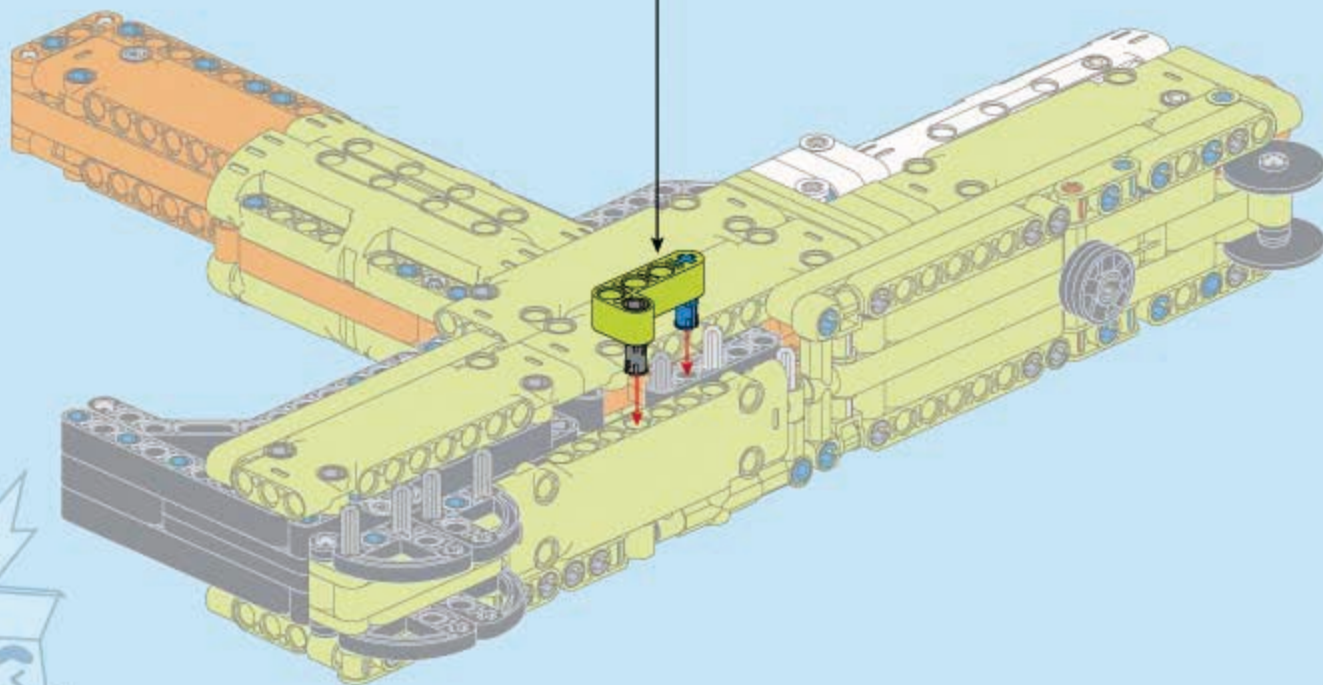
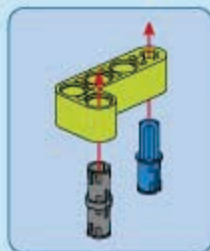

106

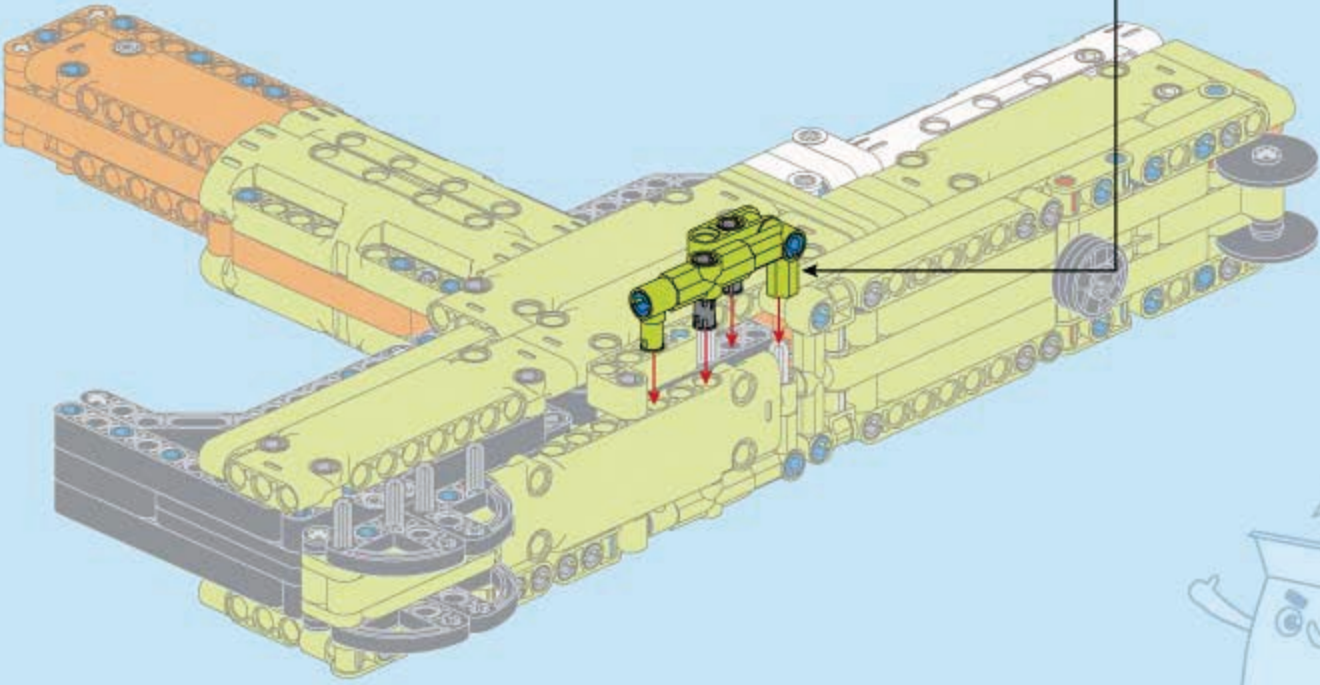
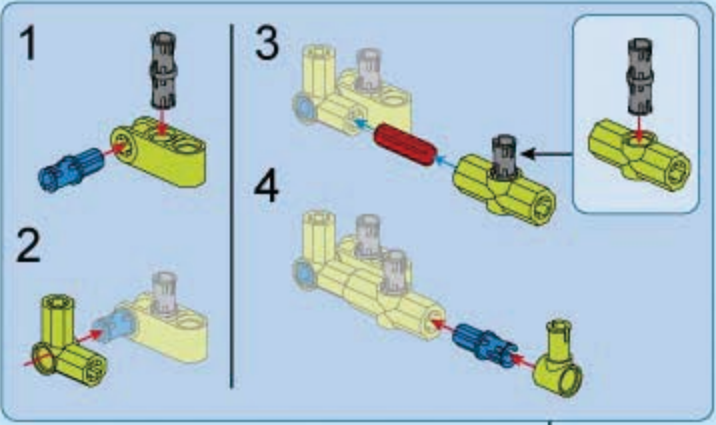
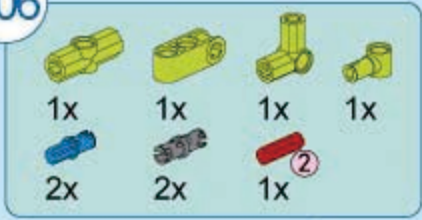

- 1x
- 1x
- 2x
- 1x
- 1x
- 6x

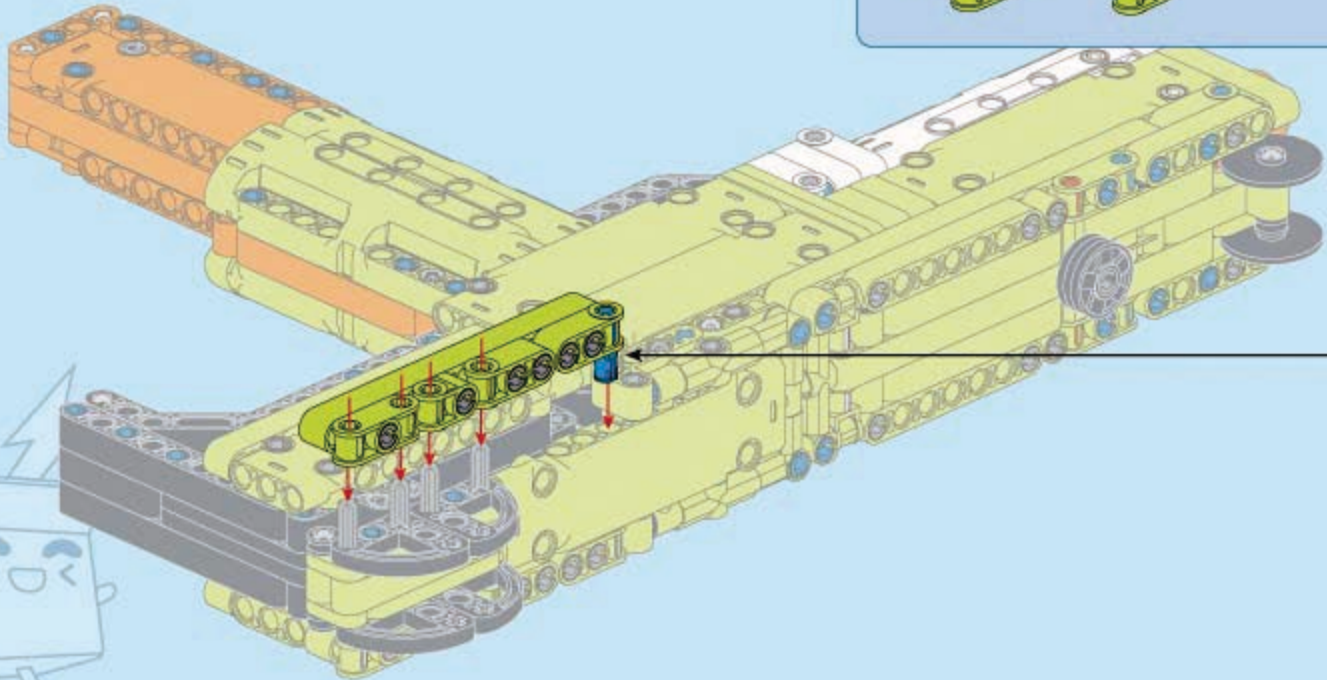
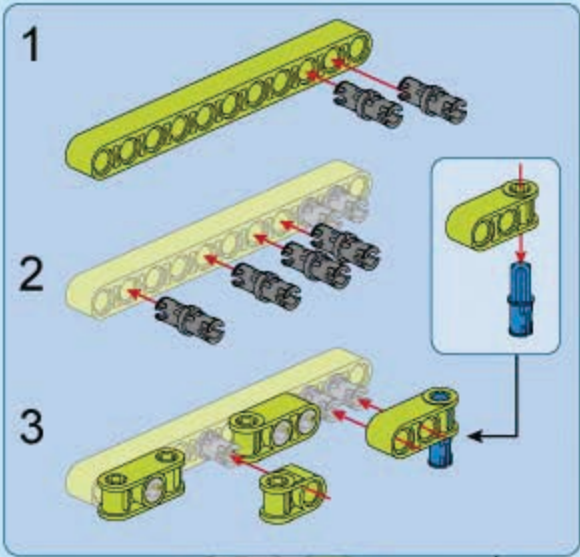

1

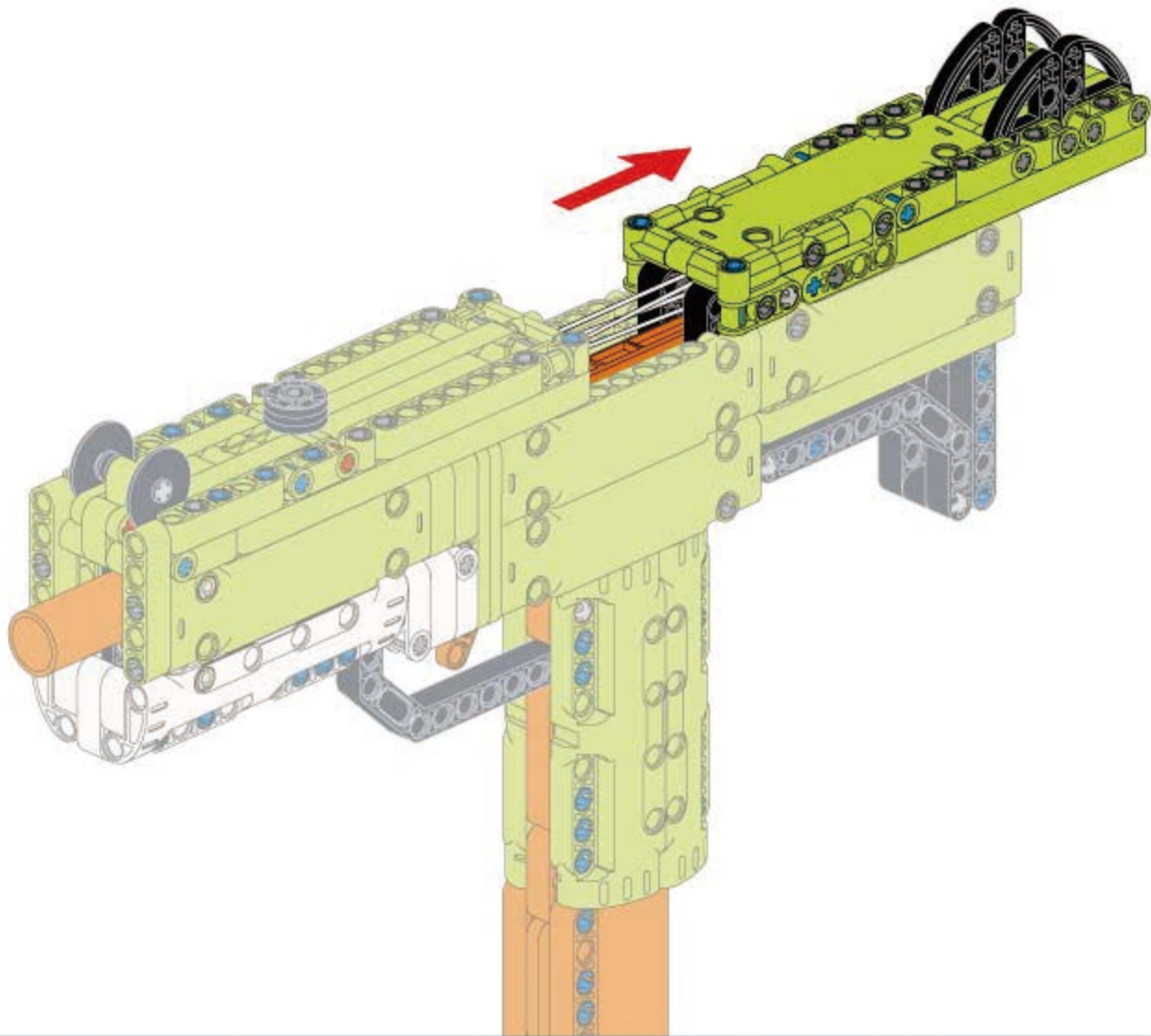

2

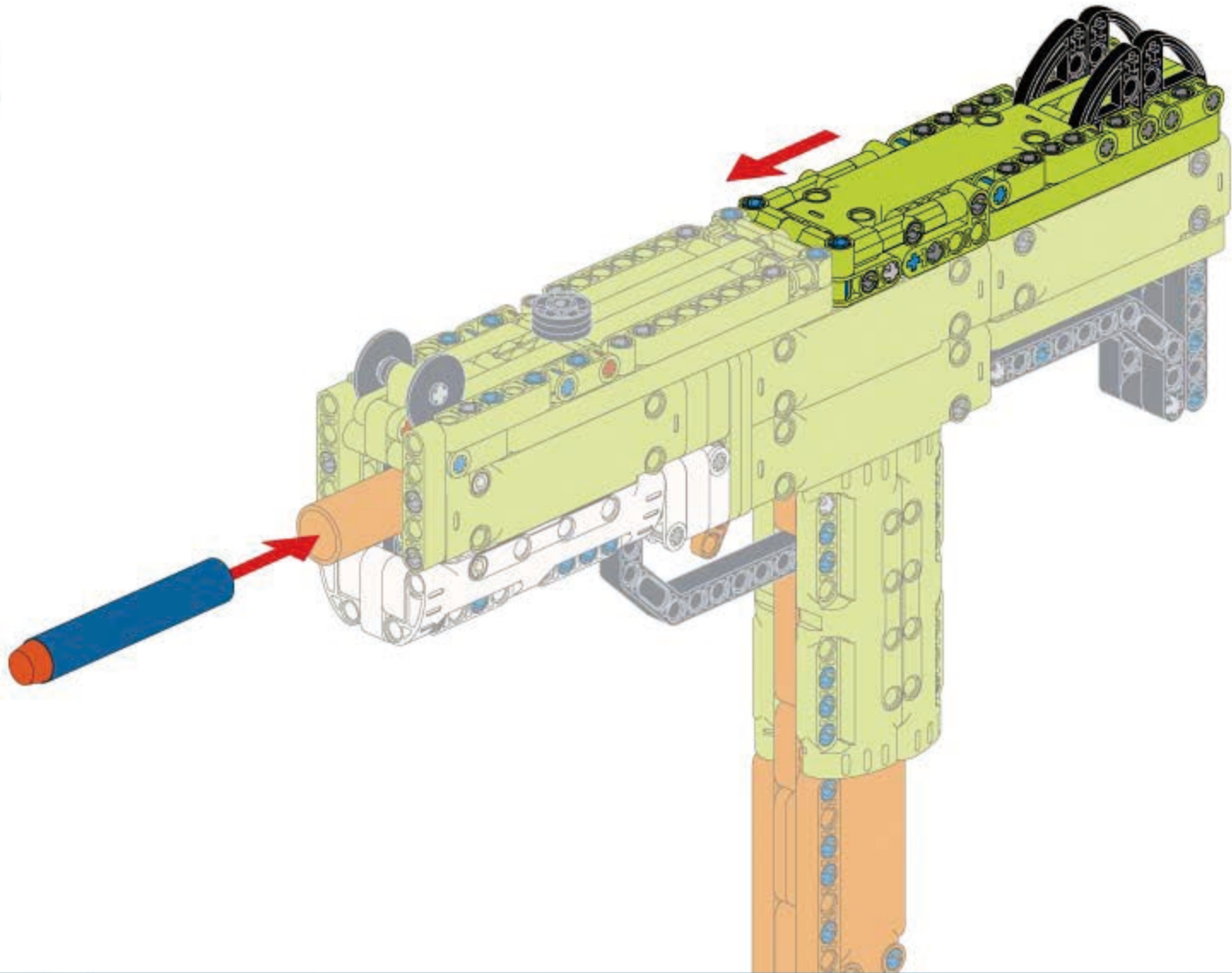

3

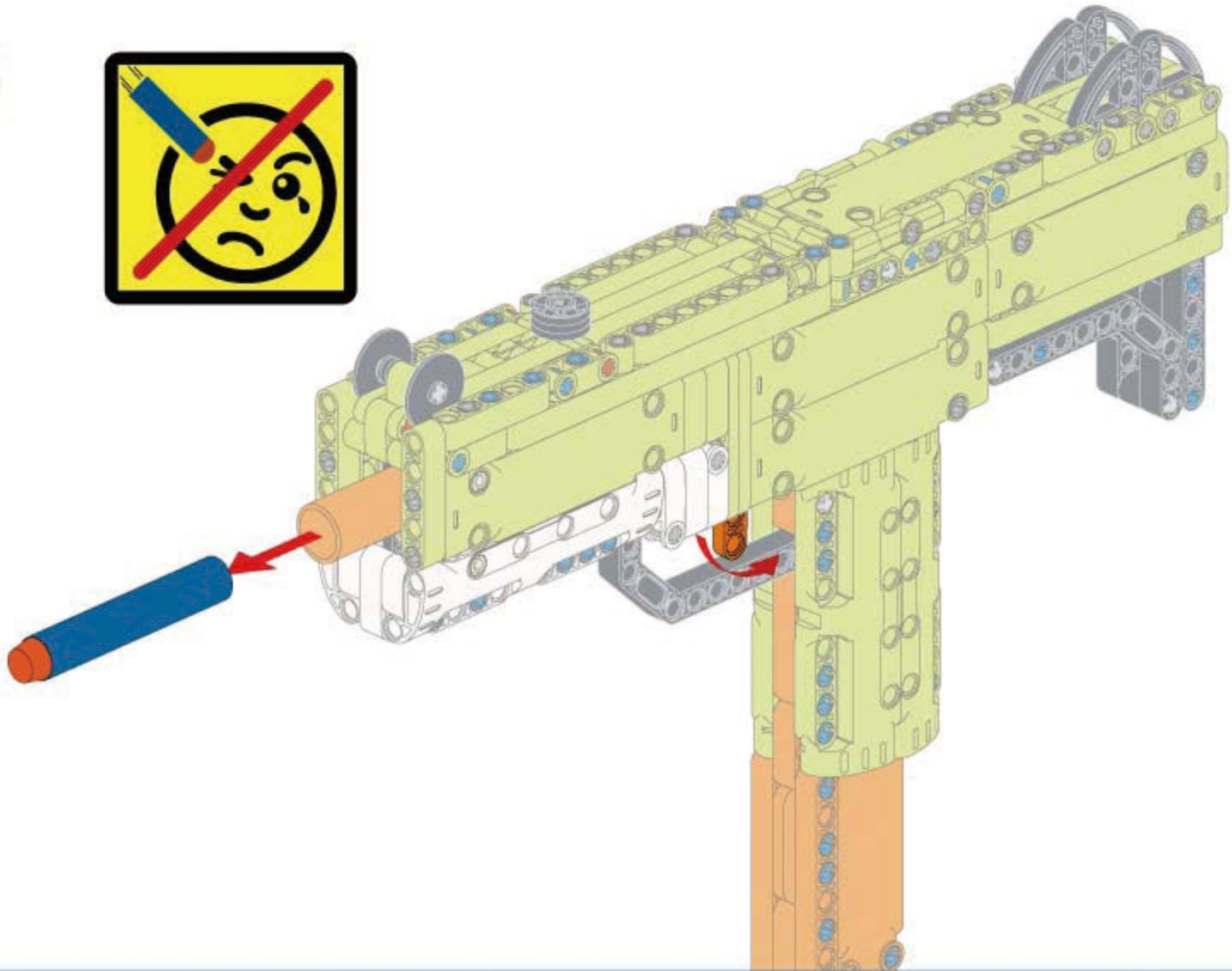

MODEL POWER

模型动力