

Keep Play

国玩系列



添置发光砖
灯光映衬精细内景



青砖小瓦马头墙，回廊挂落花格窗。
梦里水乡芳绿野，玉涵伯乐憩茶轩。

新中式街景

New Chinese Style Streetscape

K18002 栖云小筑

图片仅供参考，请以实物为准。

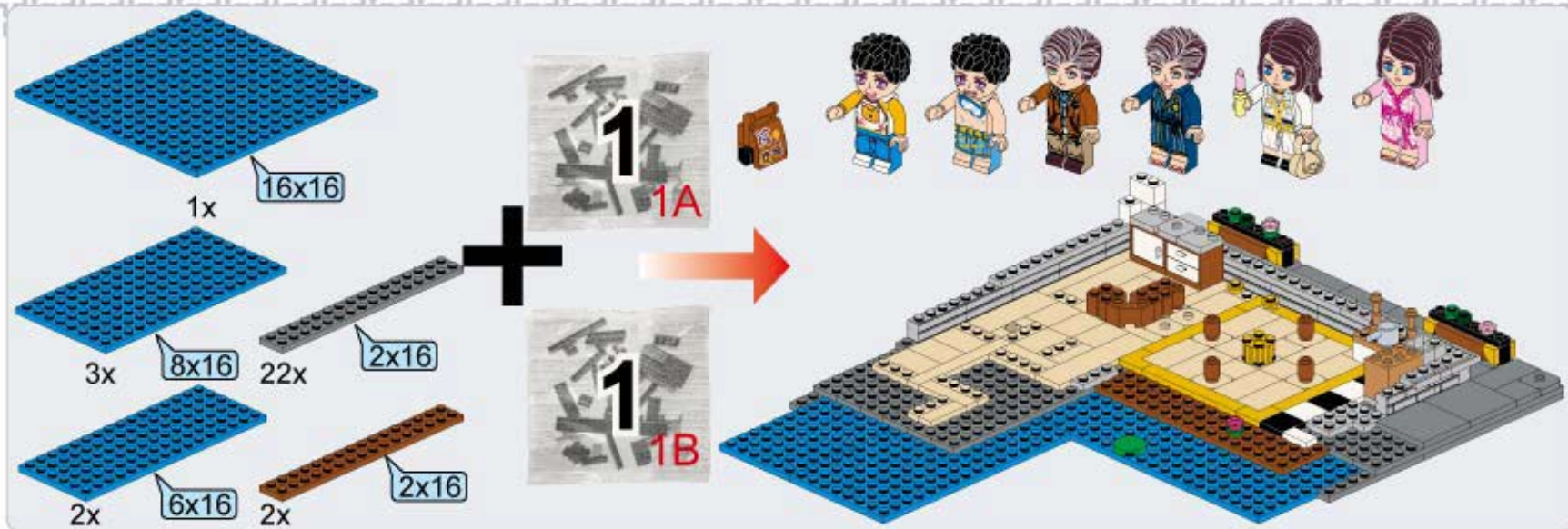

拆件器使用方法，仅为示例

Usage of Brick Separator, Just for the sample

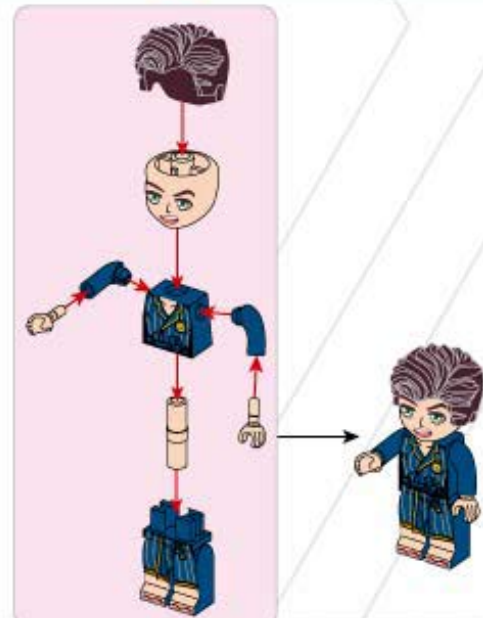
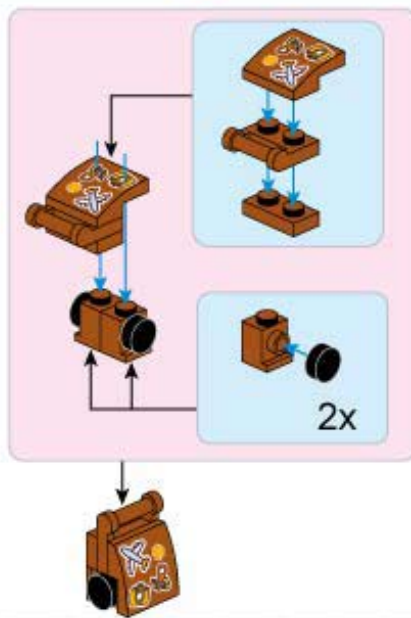
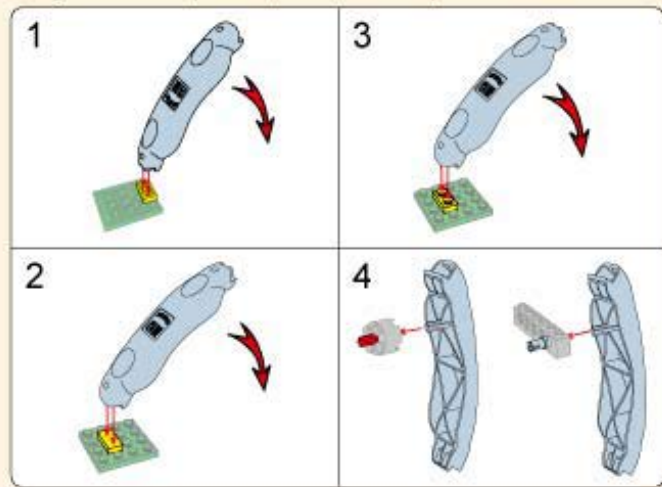

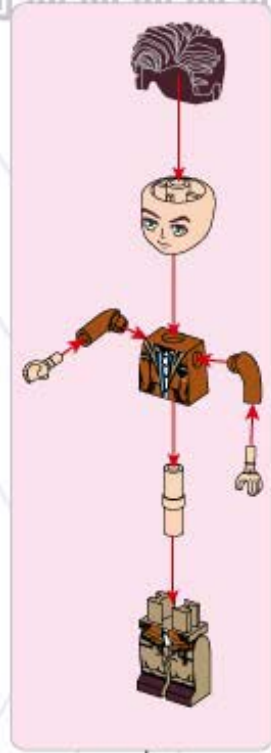
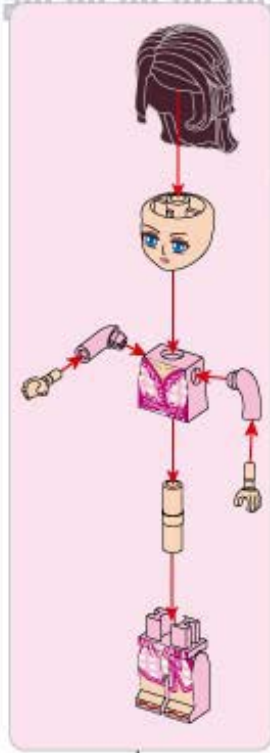
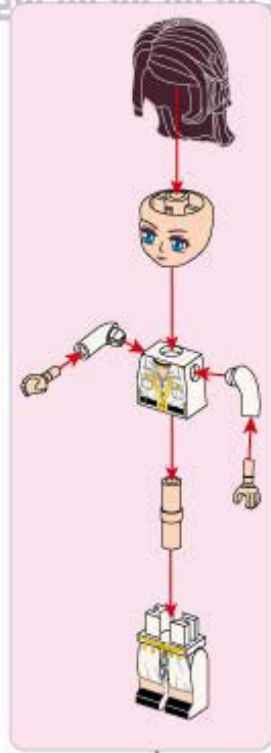
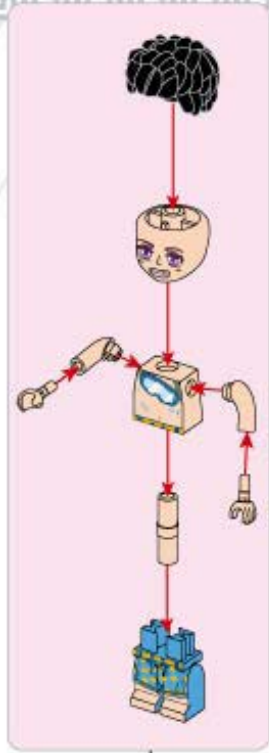
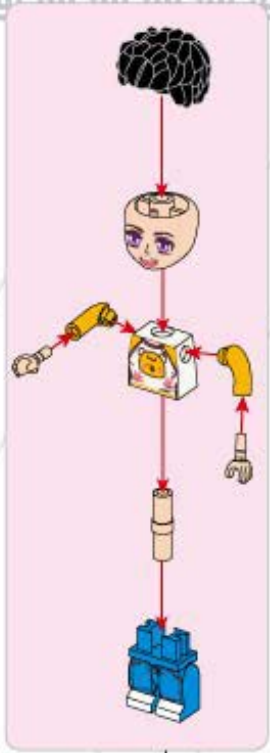

1

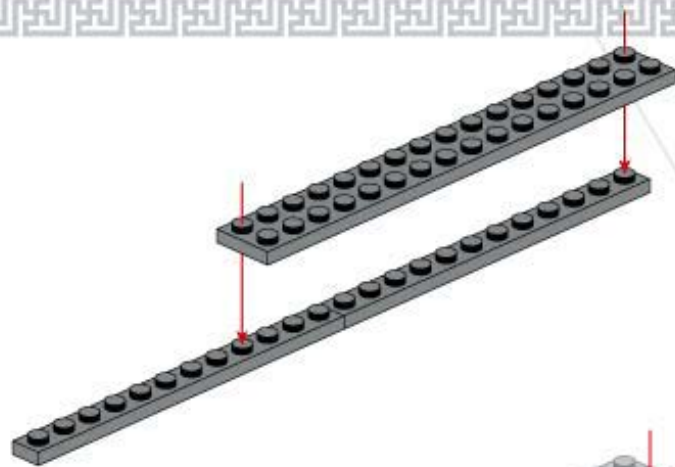
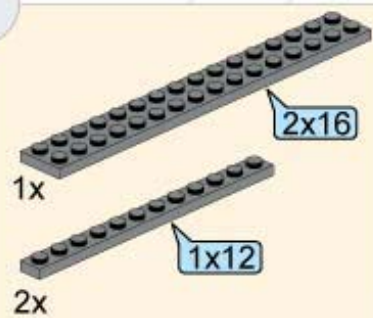

2

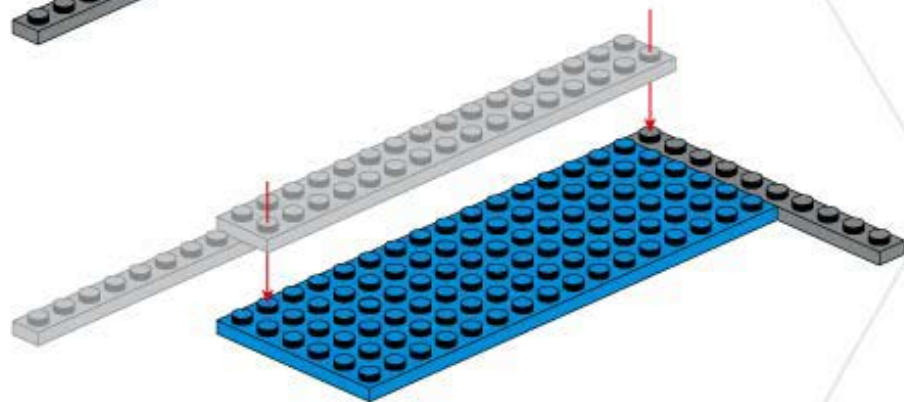
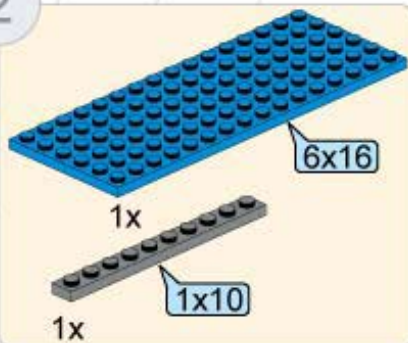

3

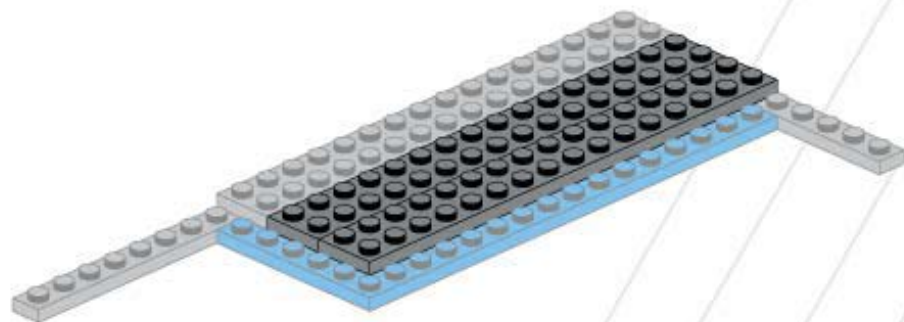
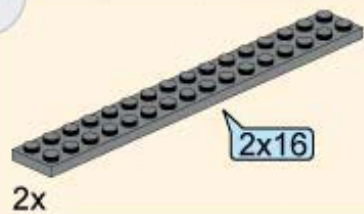

3

4

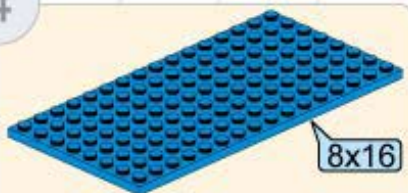

1x

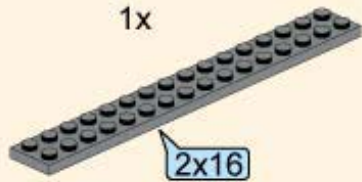

1x

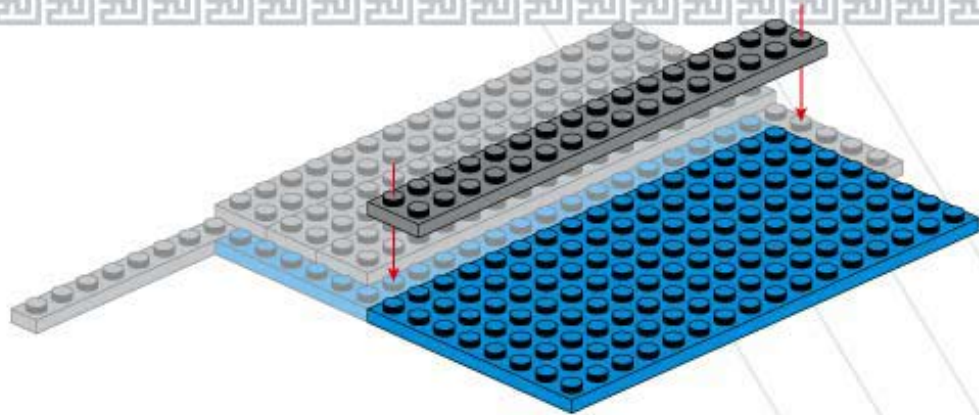

5

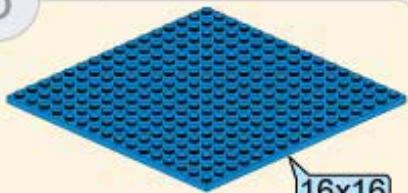

1x

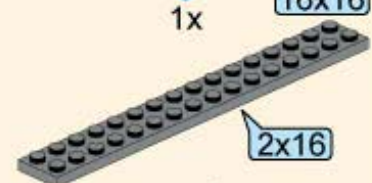

1x

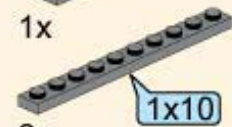

2x

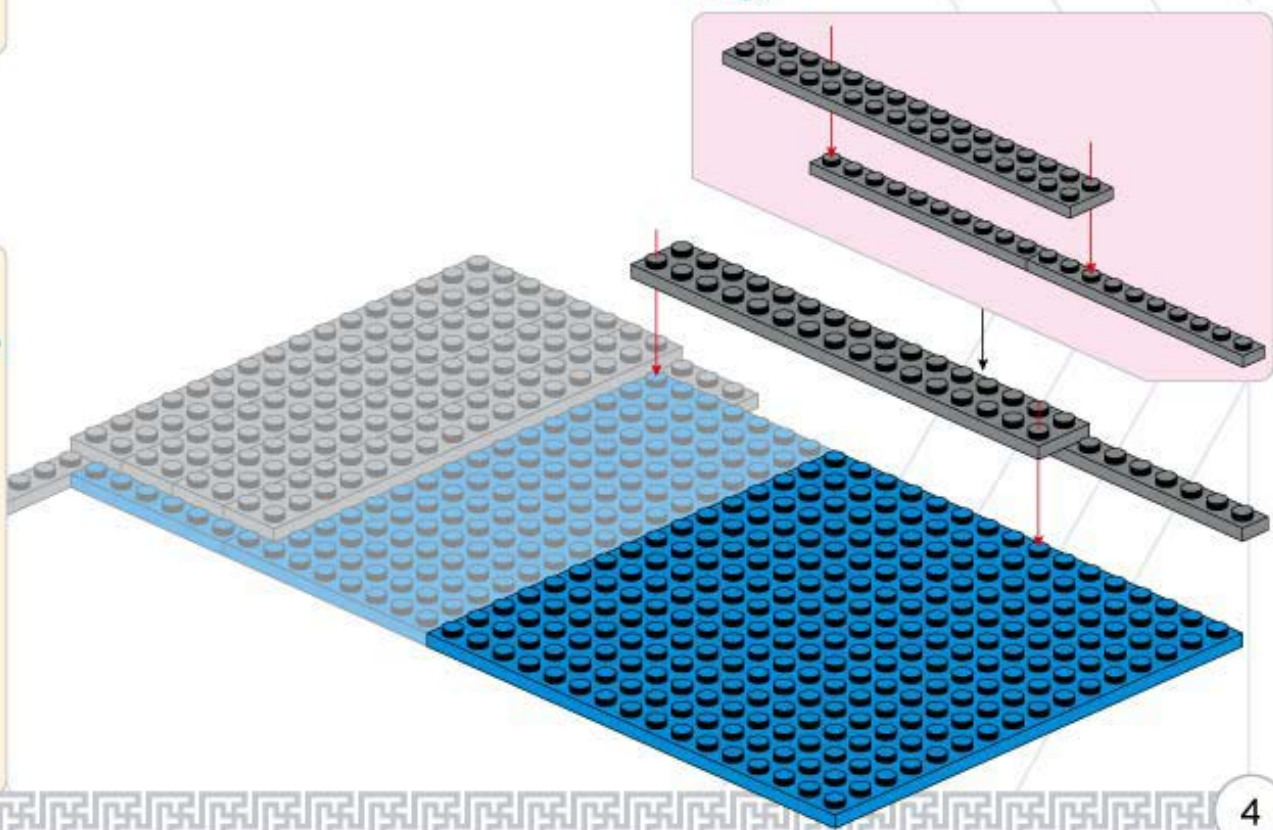

6

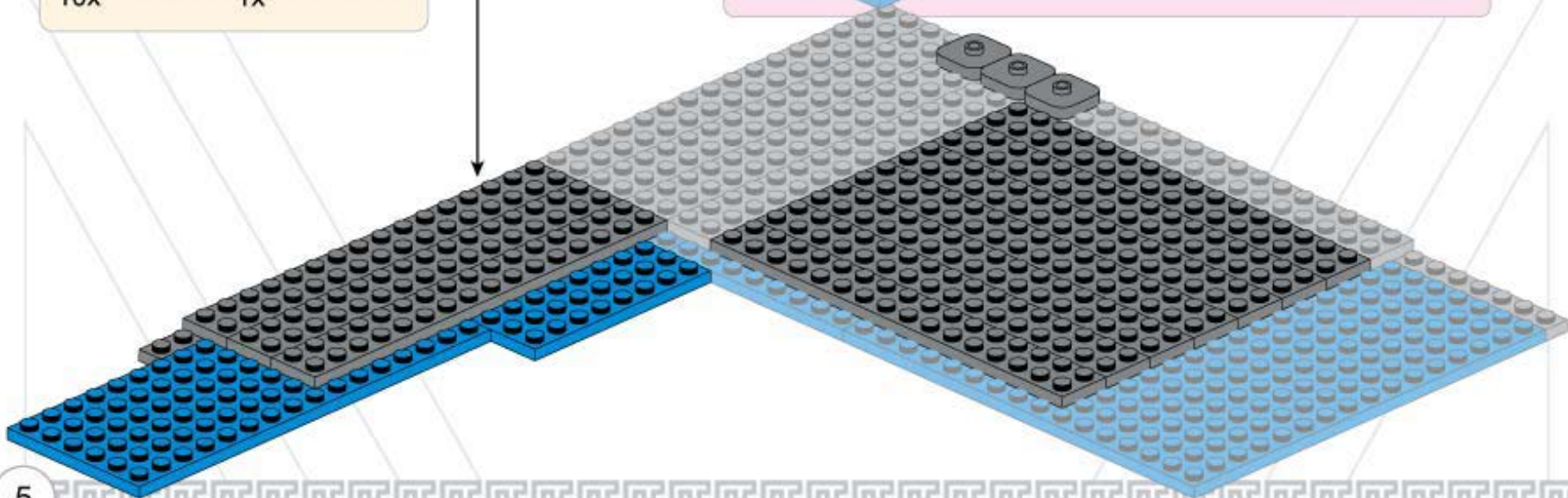
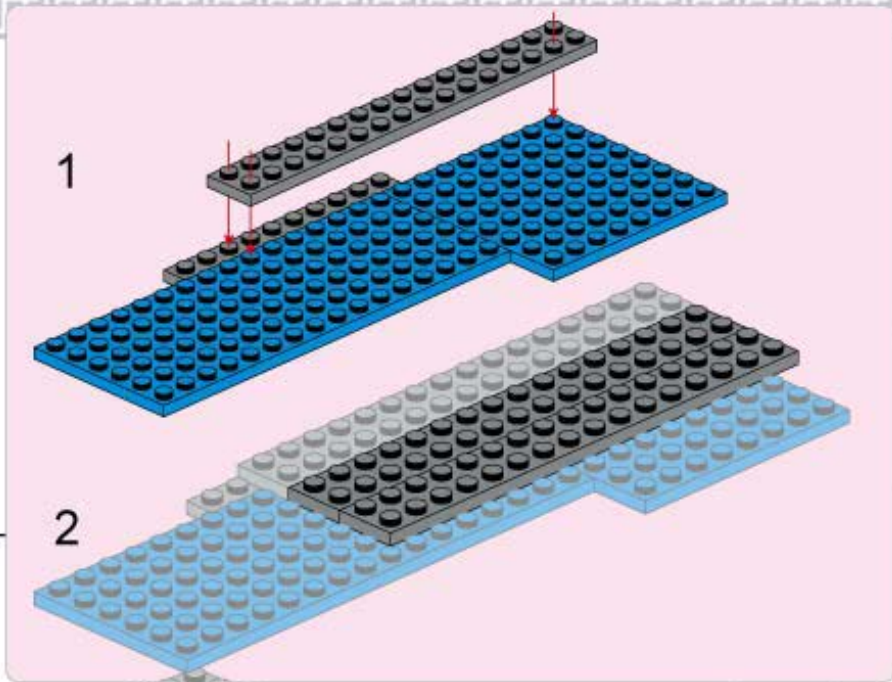
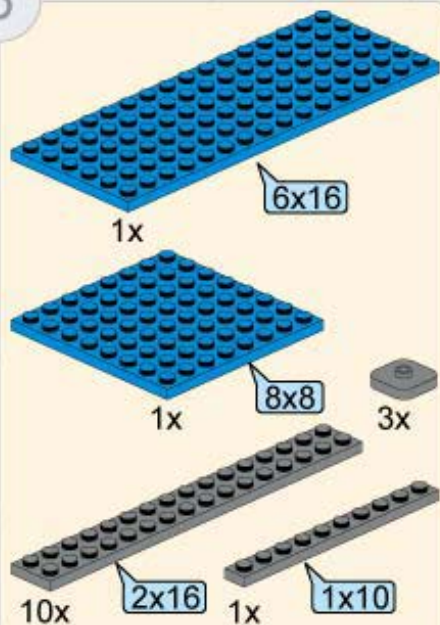

5

7

- 1x 1x12
- 1x 1x8
- 2x 1x12
- 4x 4x4
- 1x 1x8
- 1x 1x1
- 3x 1x3

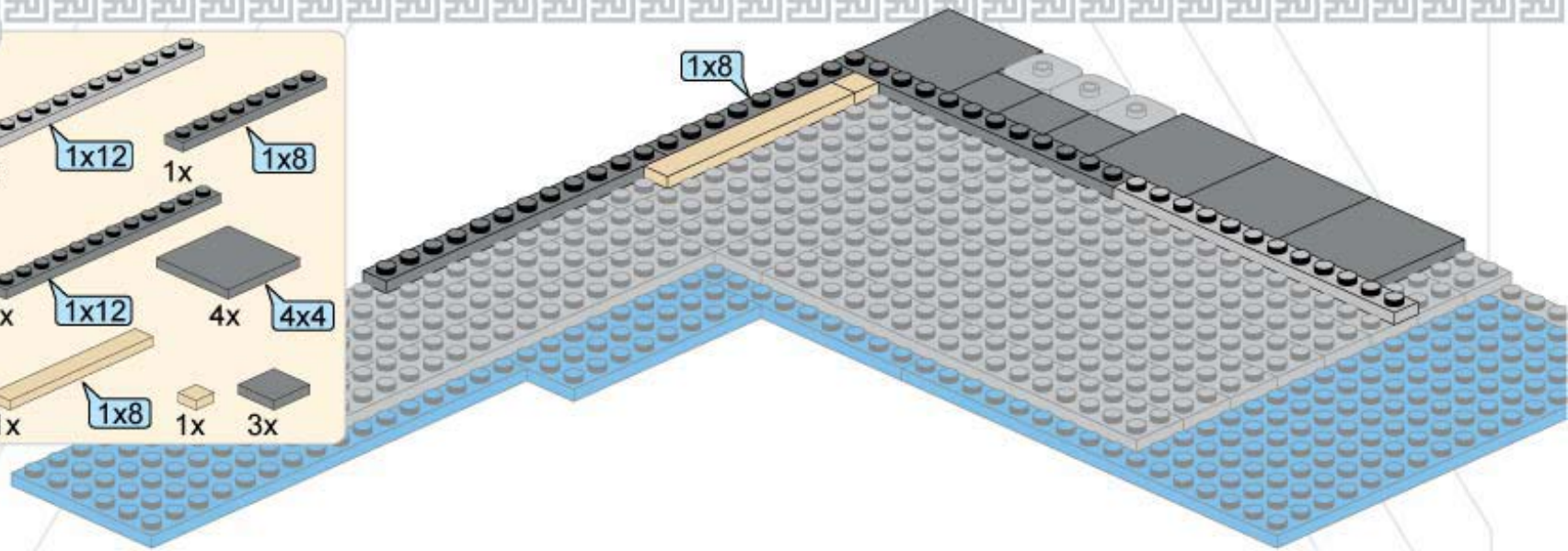

8

- 1x 1x12
- 2x 2x6
- 2x 1x1
- 1x 2x4
- 1x 1x1
- 1x 1x1
- 1x 1x3

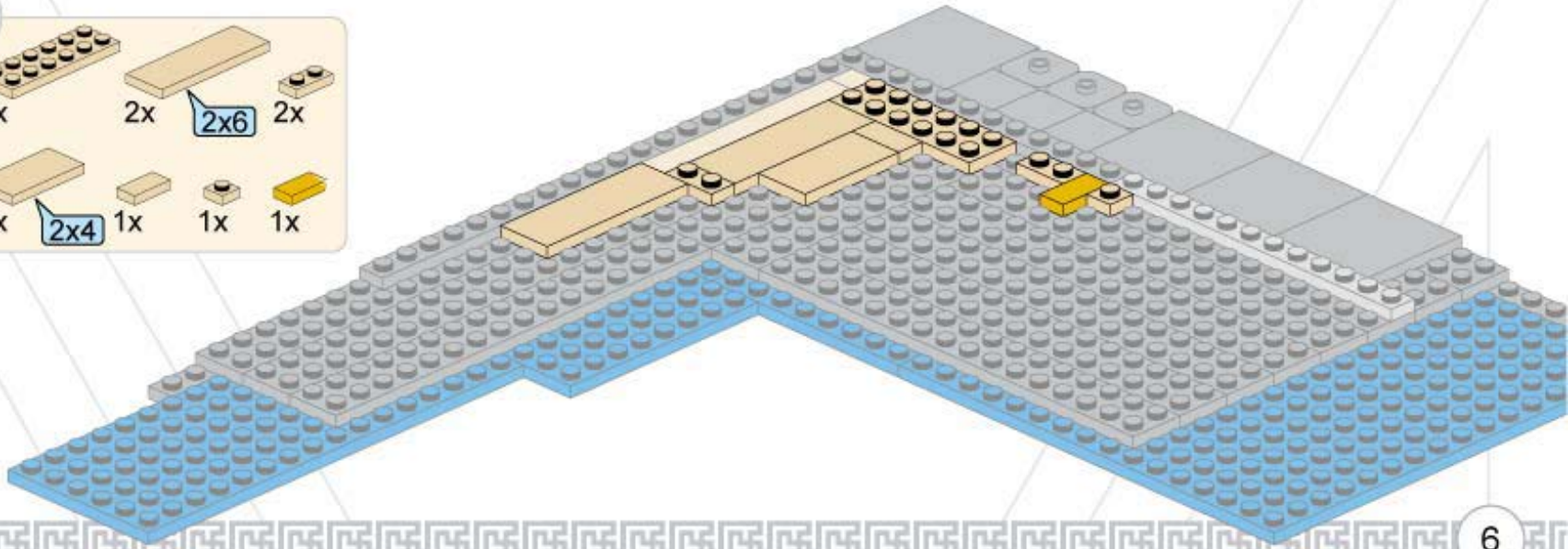

9

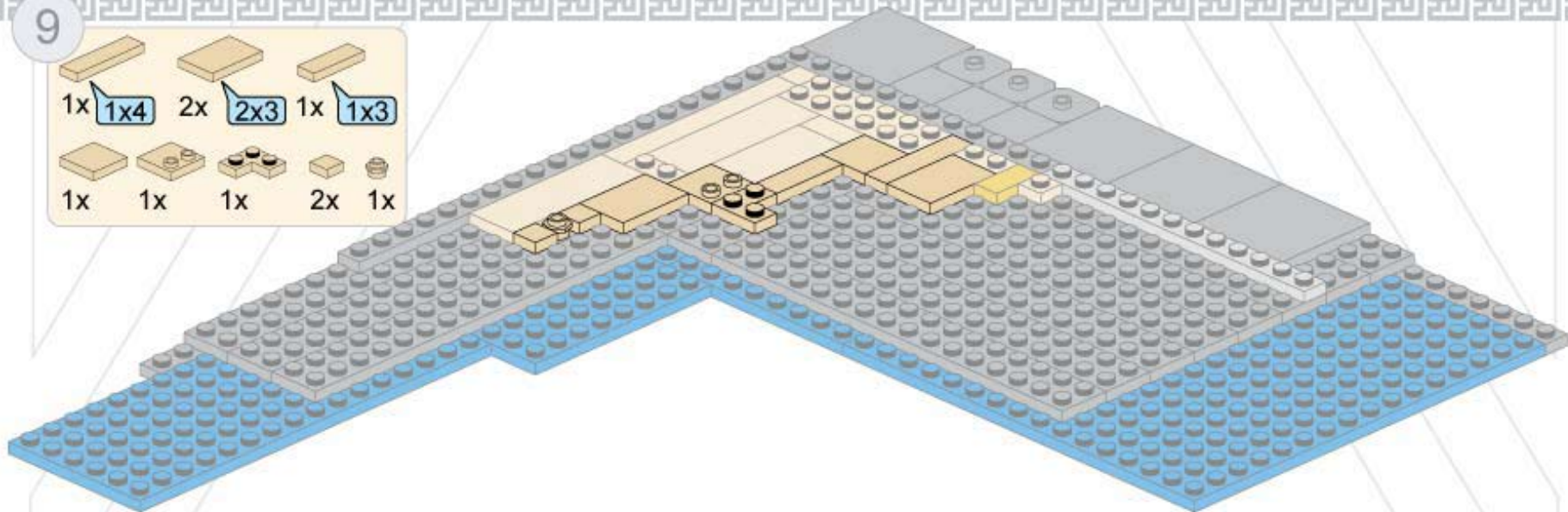
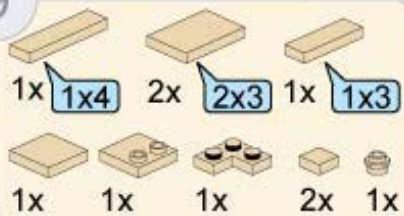



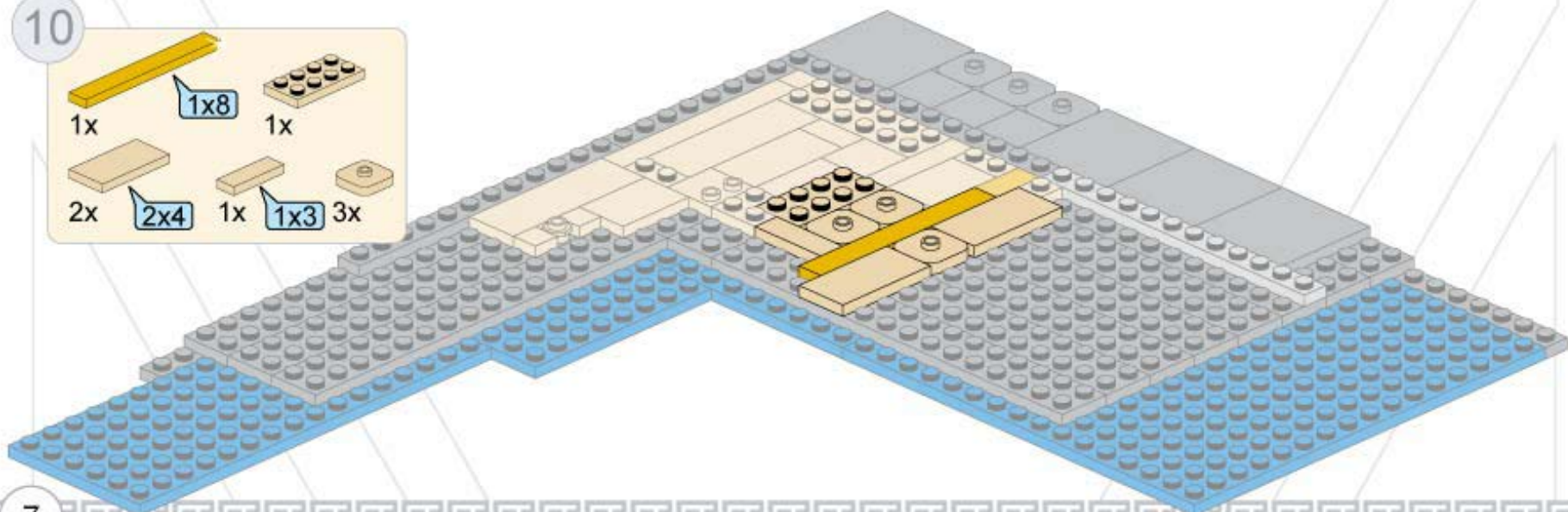
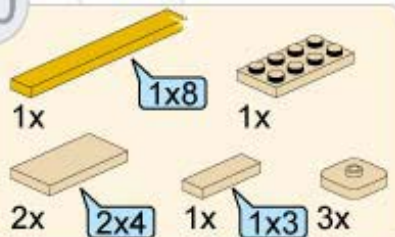







10







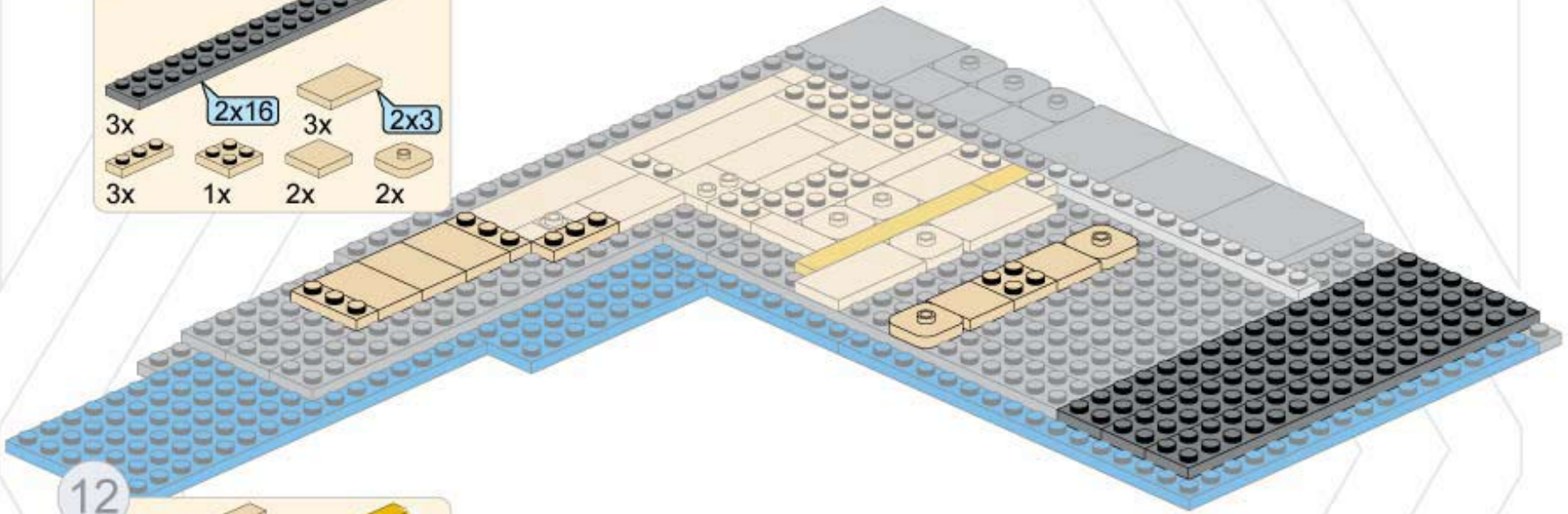

7

11

- 3x 
- 3x 
- 3x 
- 1x 
- 2x 
- 2x 
- 3x 
- 1x 
- 2x 
- 2x 



12

- 1x 
- 1x 
- 4x 
- 2x 
- 1x 
- 3x 
- 3x 

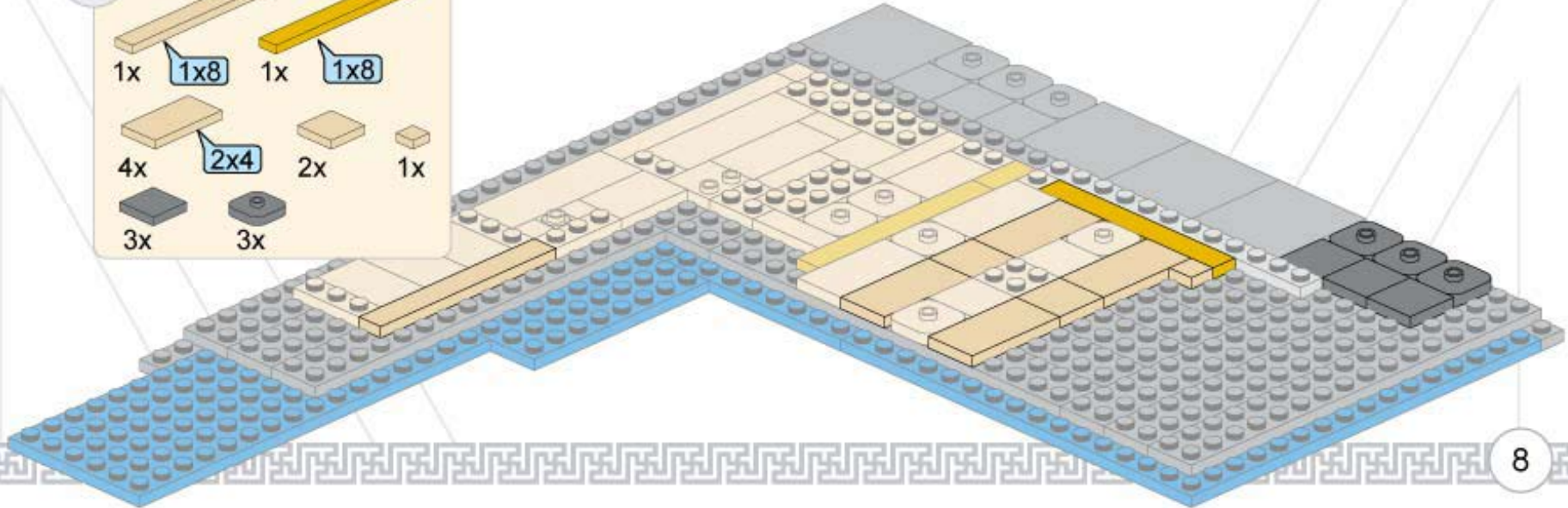

13

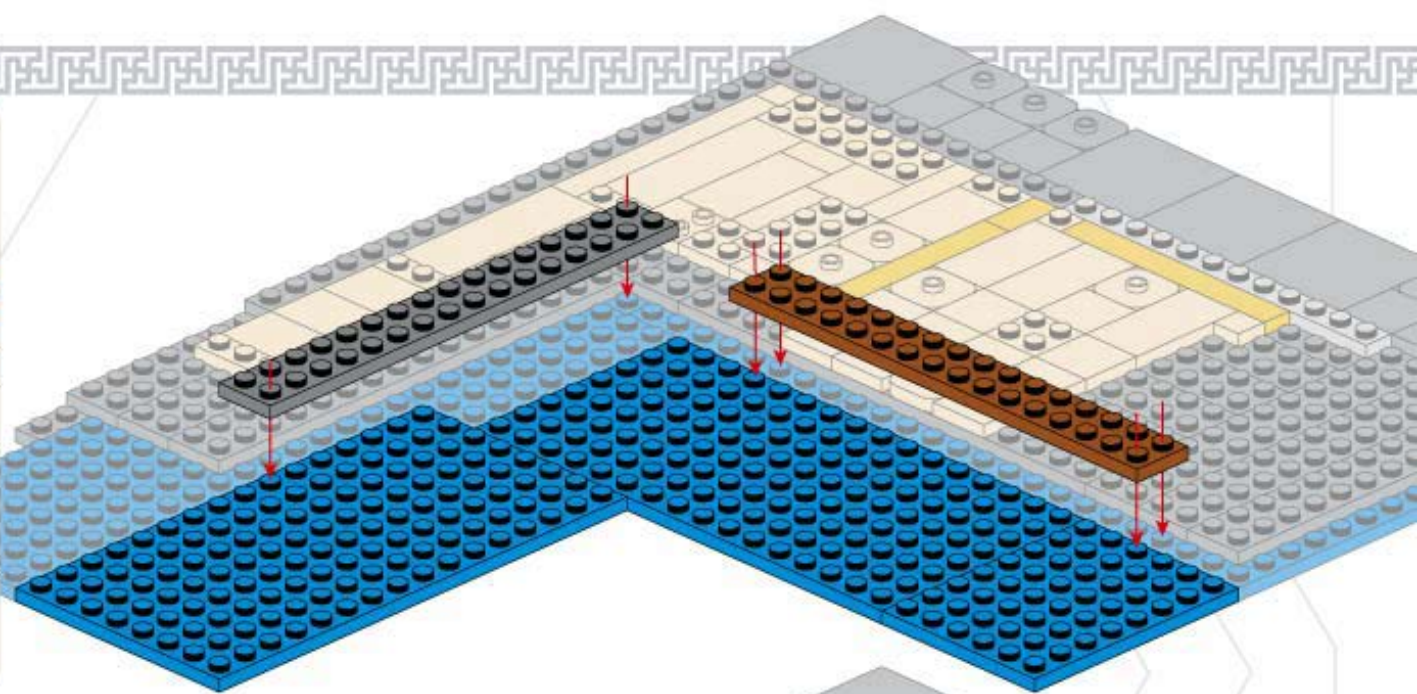
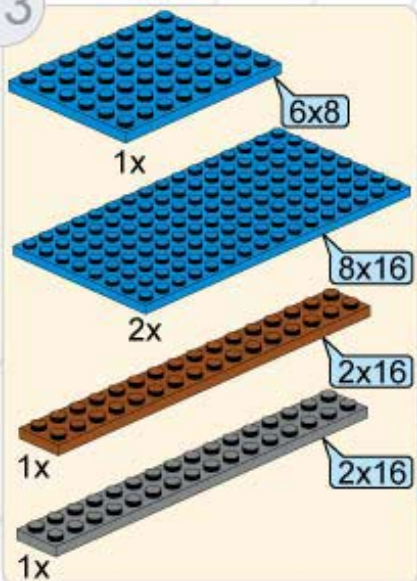

14

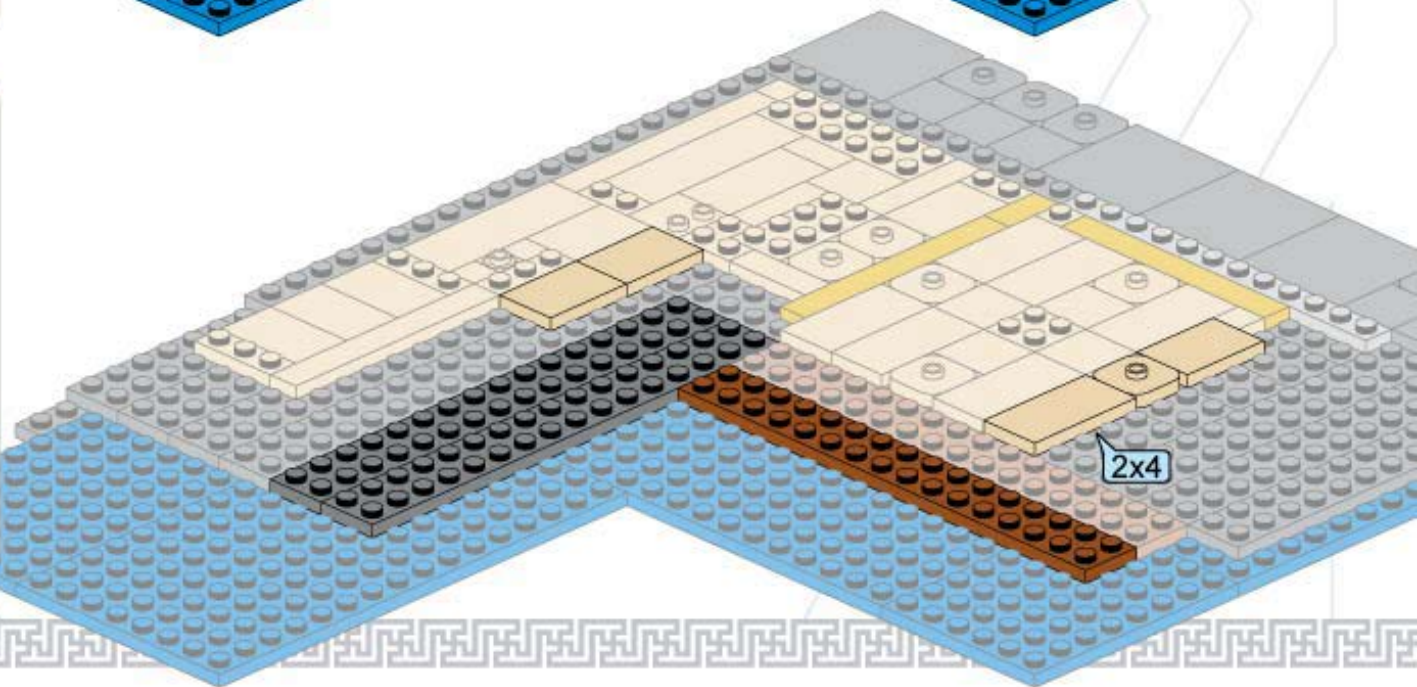
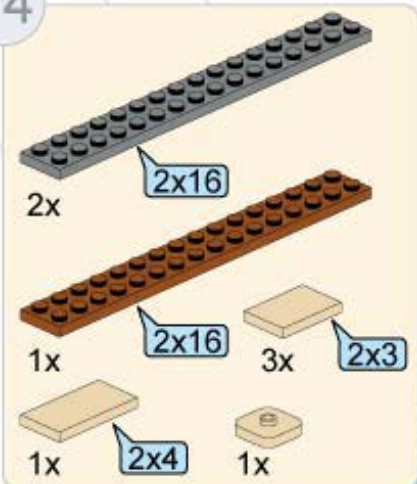

9

15

2x 1x8 2x 1x

1x 1x 2x 1x4

1x 2x3 1x 1x3 1x

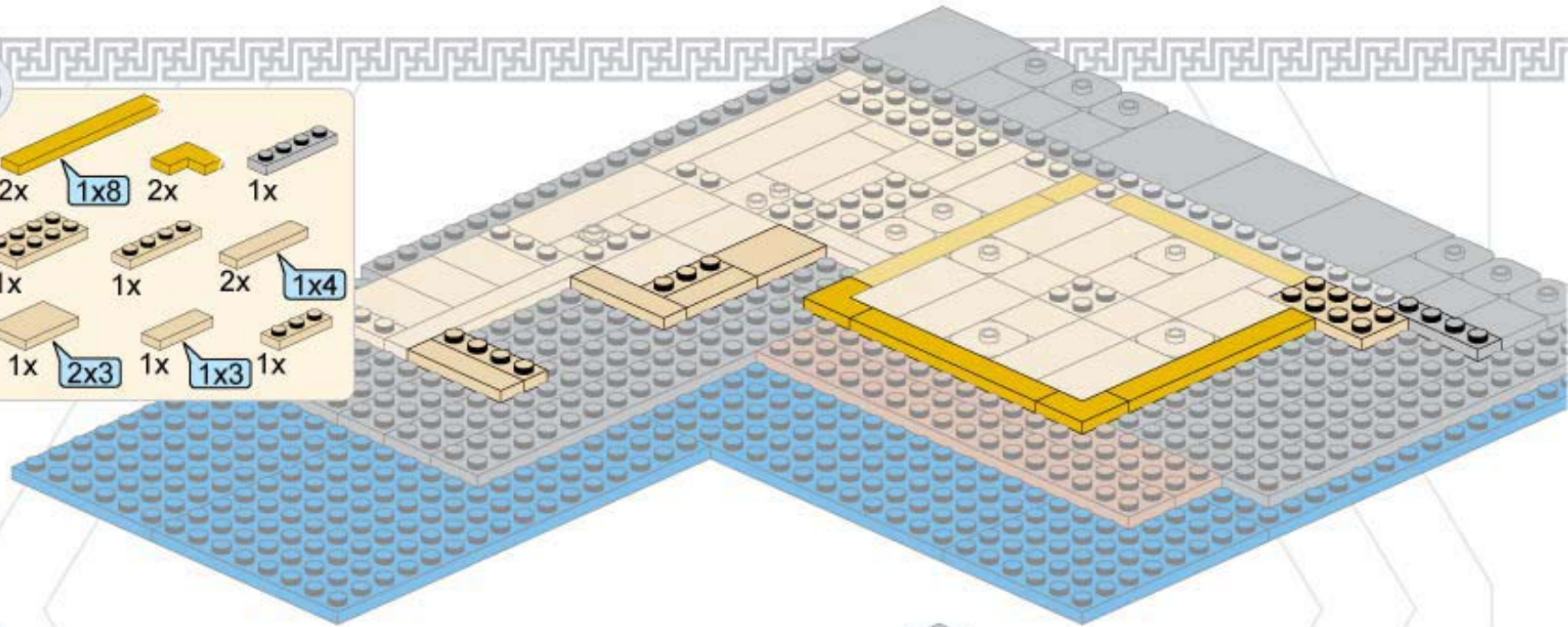

16

1x 2x8 1x 1x3

1x 1x 1x 1x

2x 3x

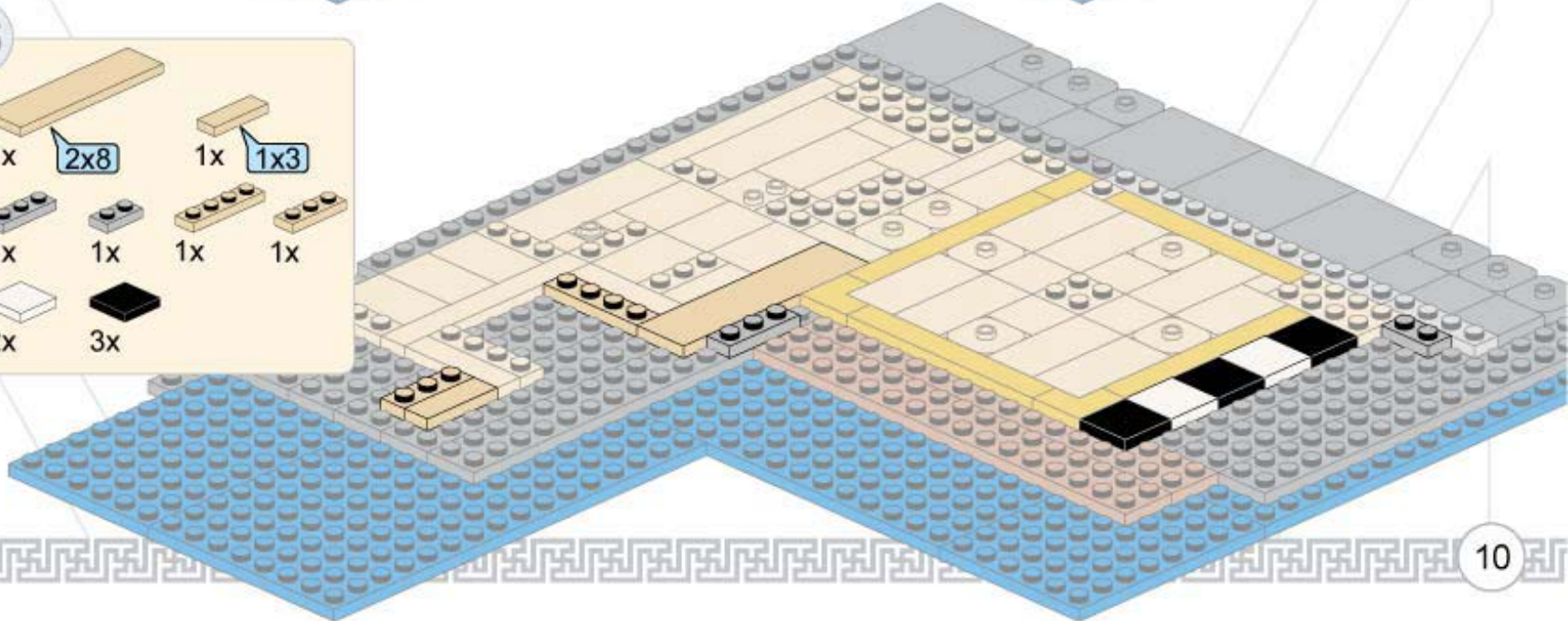

17

- 1x 2x16
- 1x 1x12 1x 1x8
- 1x 1x8 2x 1x
- 1x 1x 5x 2x 1x

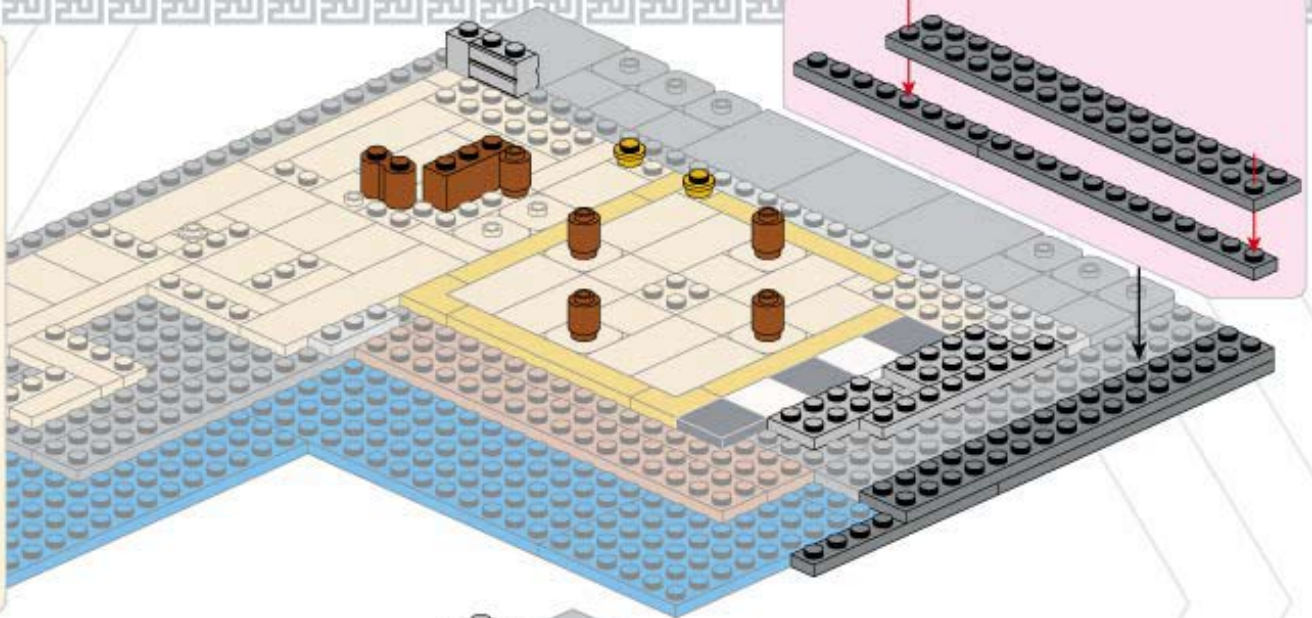

18

- 2x 4x4 1x 2x4
- 11x 1x 1x 1x
- 1x 1x 2x

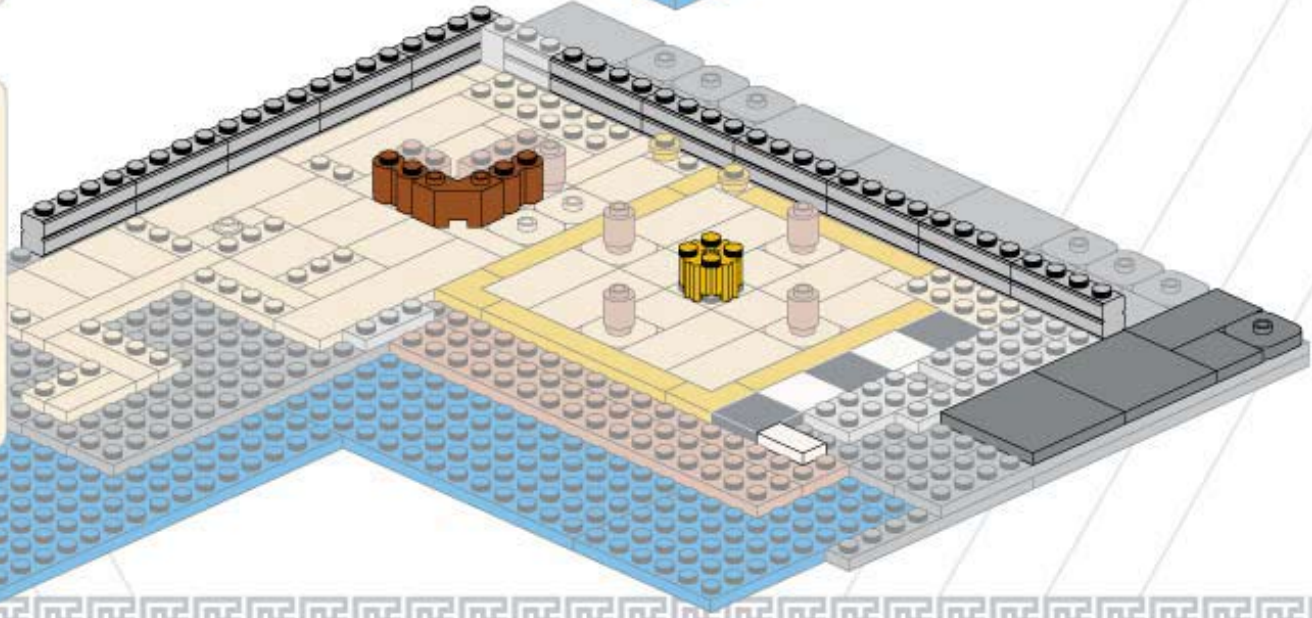

19

- 1x 1x12
- 3x 1x6
- 1x 1x3
- 1x 1x4
- 1x 1x6
- 2x 1x3
- 6x 1x2
- 4x 1x4
- 8x 1x2

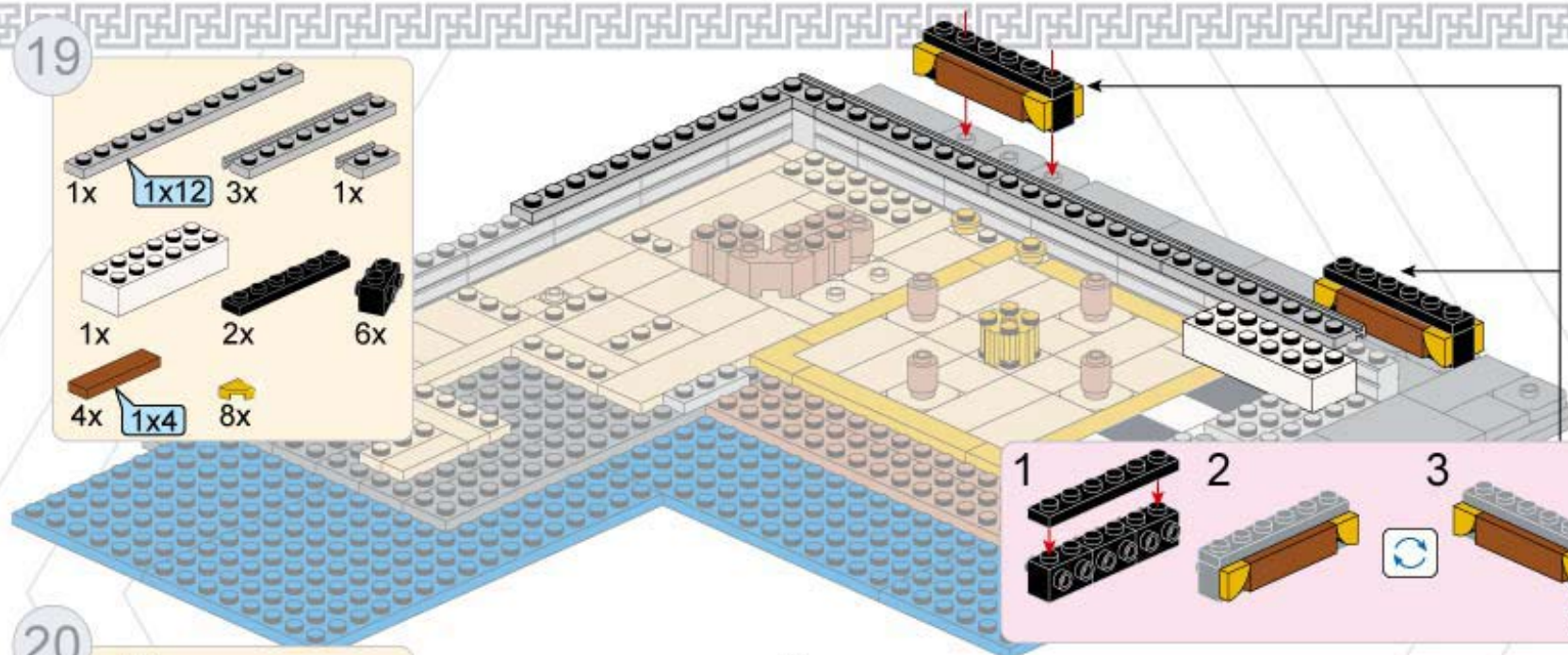

20

- 1x 1x3
- 1x 1x2
- 1x 1x1
- 1x 1x2
- 1x 1x4
- 2x 1x2
- 3x 1x1
- 2x 1x1
- 2x 1x1

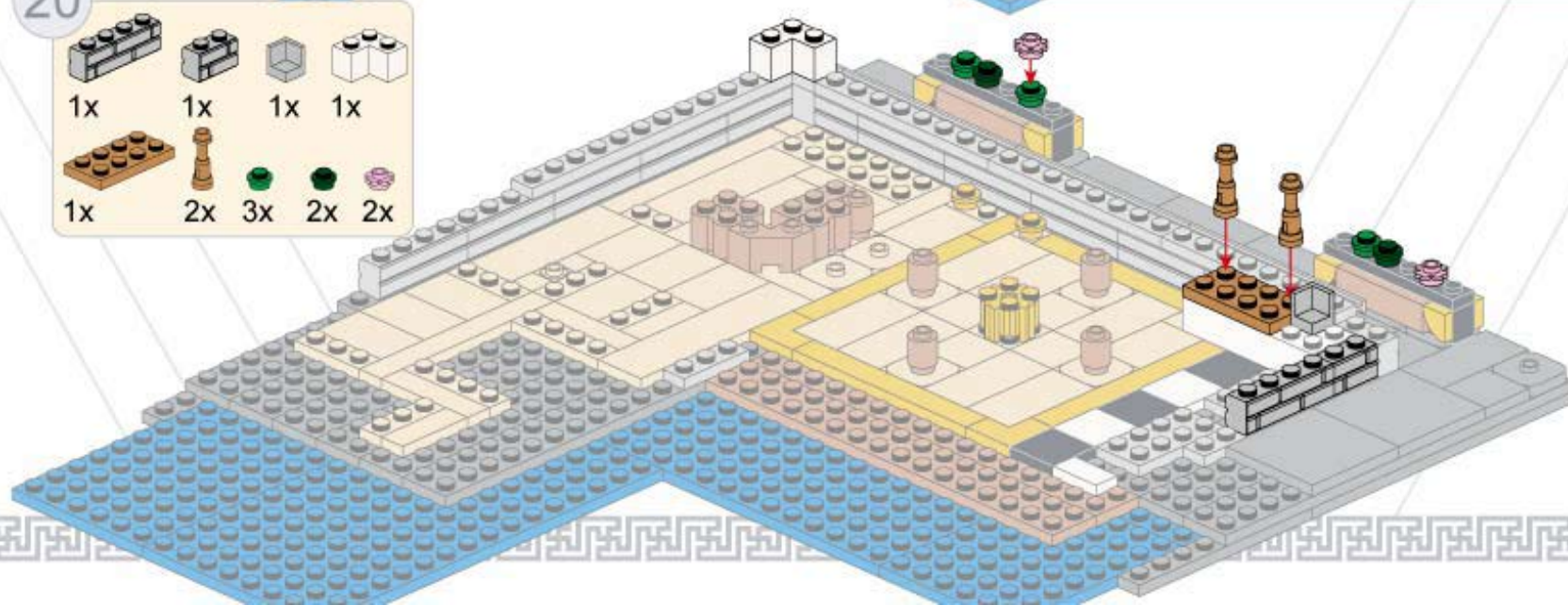

21

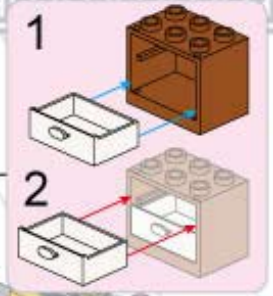
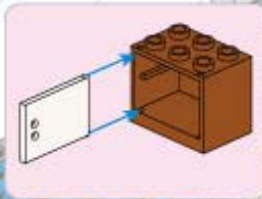
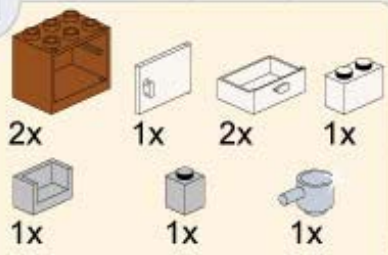

22

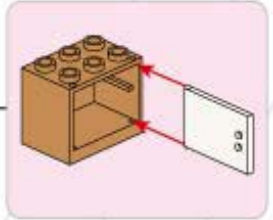
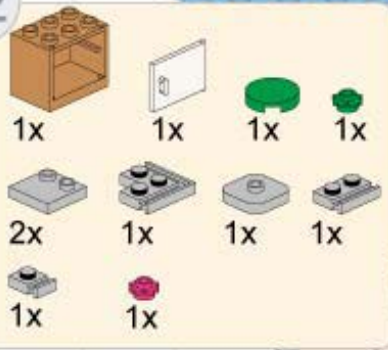

13

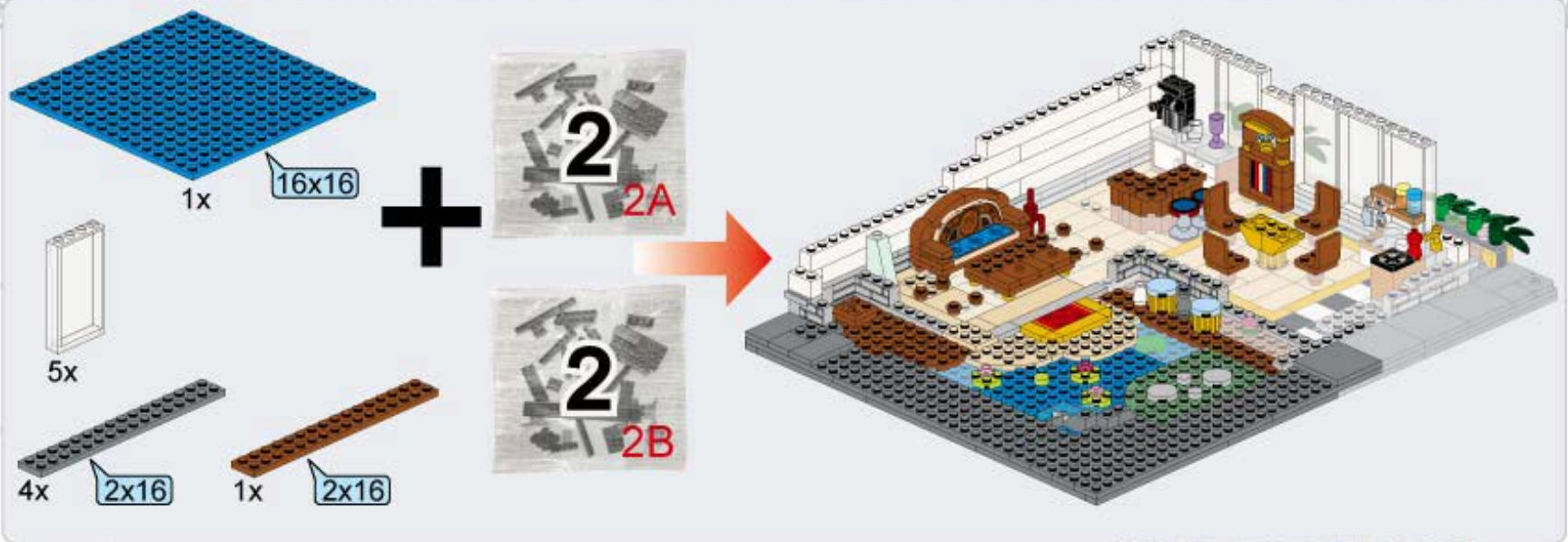

23

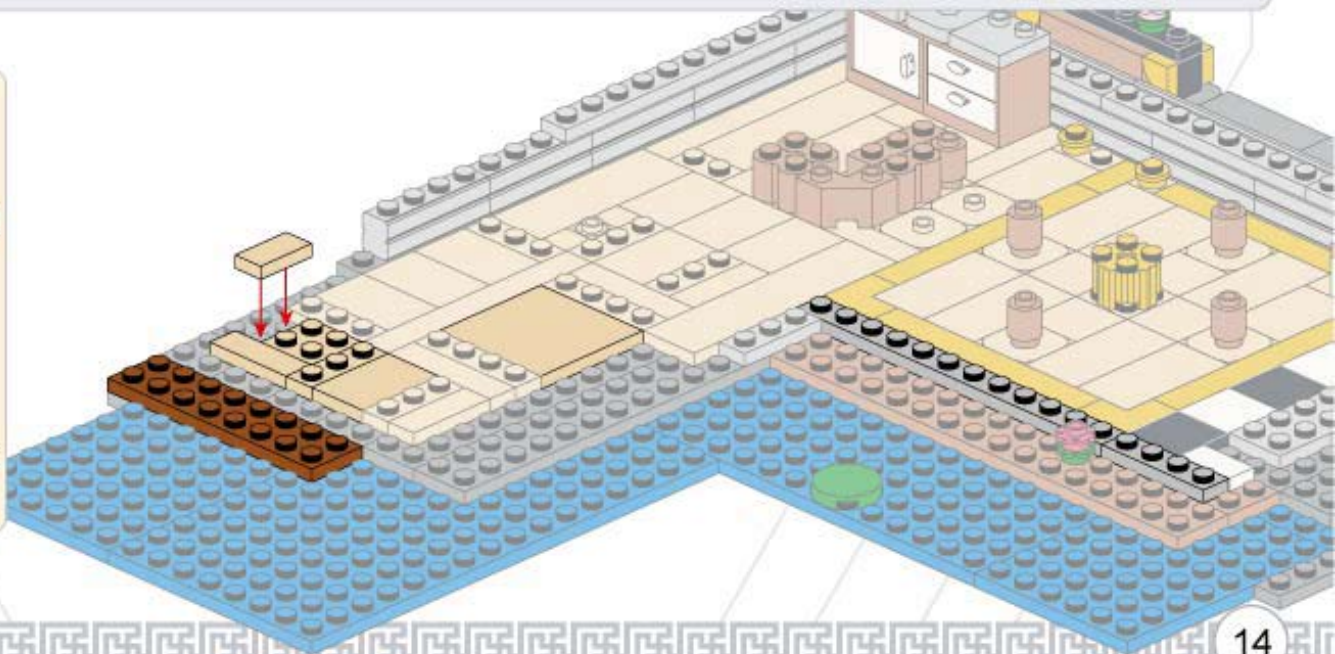
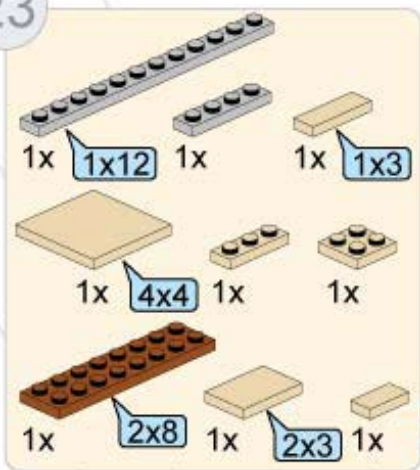

24

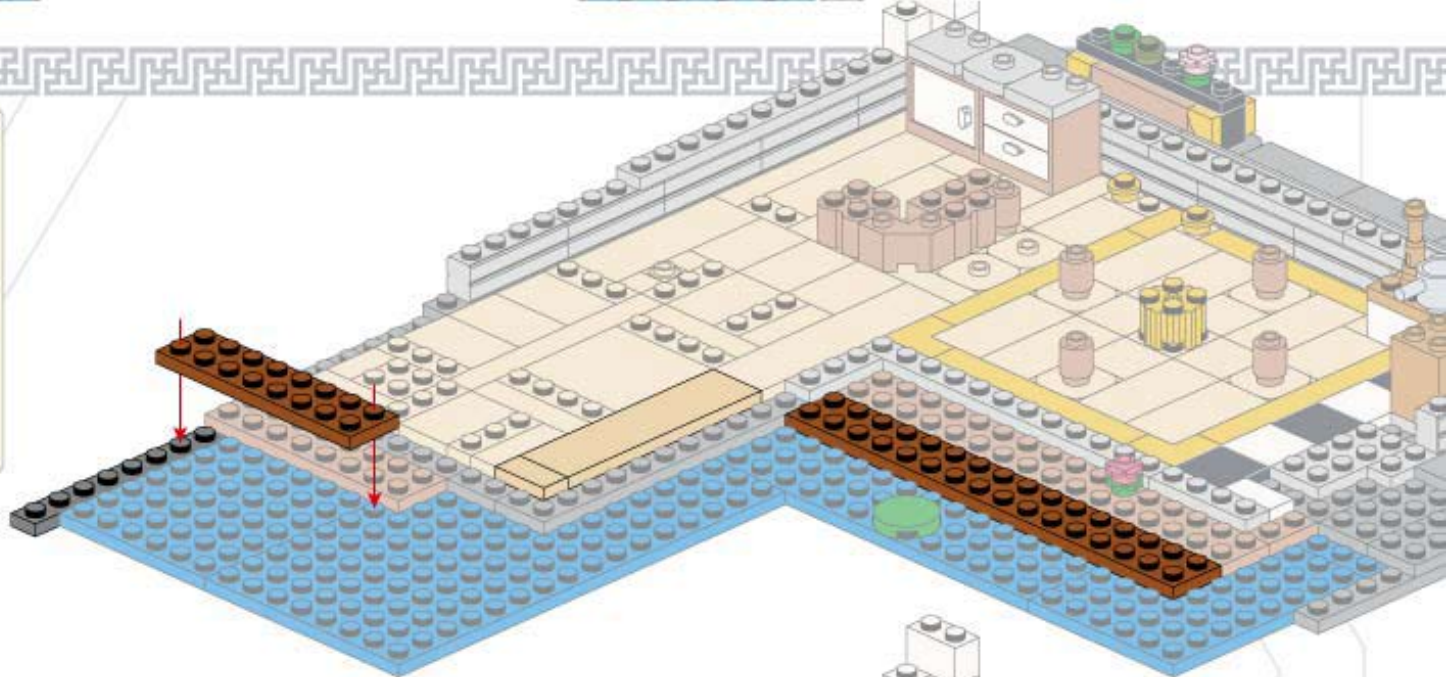
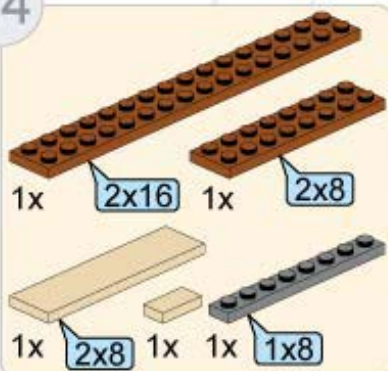

25

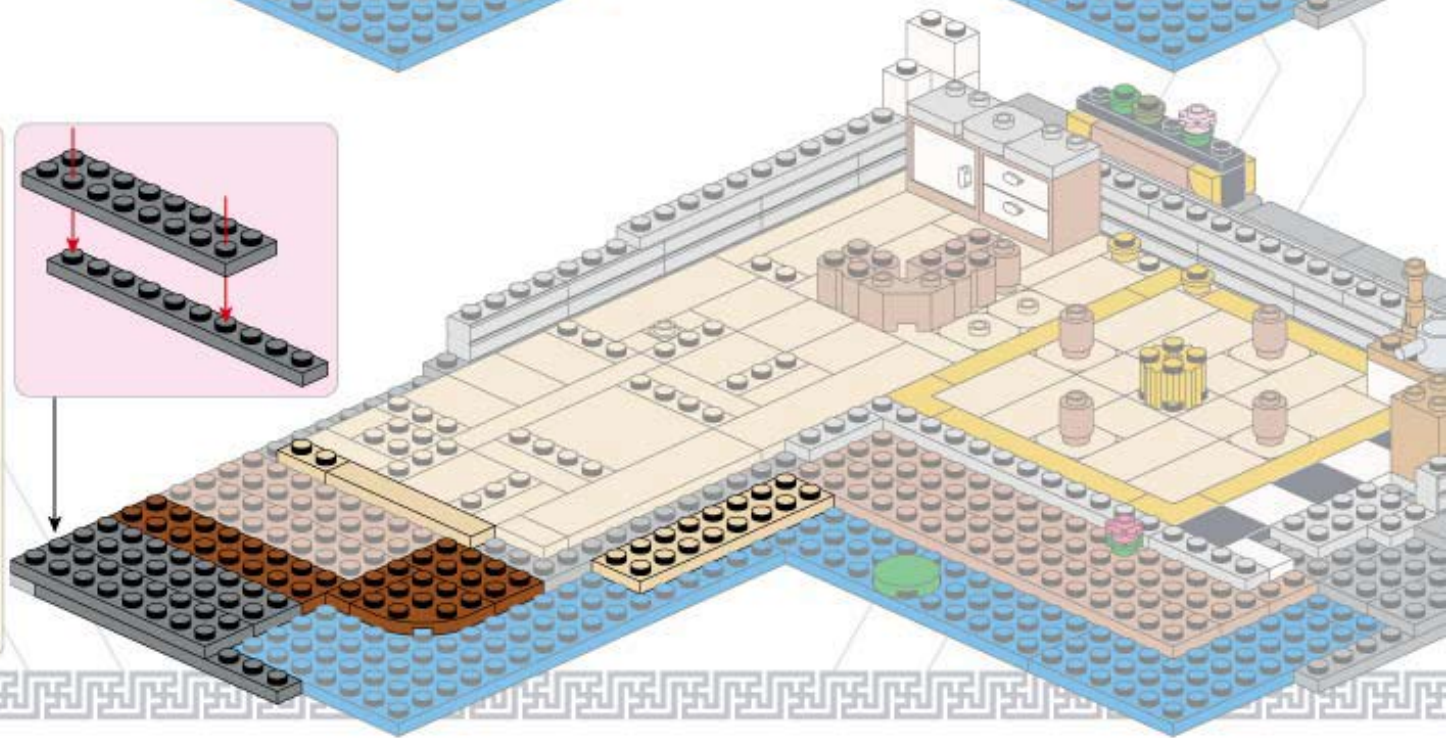
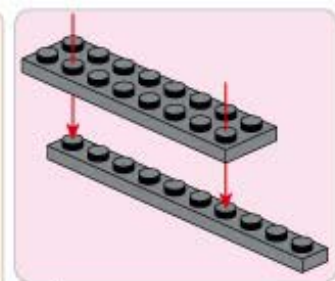
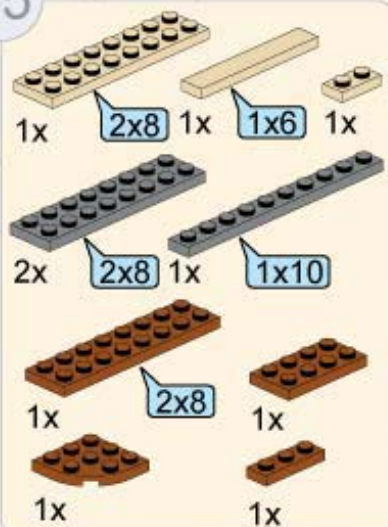

15

26

- 1x 1x12
- 2x 1x8
- 1x 1x8
- 2x 2x2
- 1x 1x2
- 1x 1x1

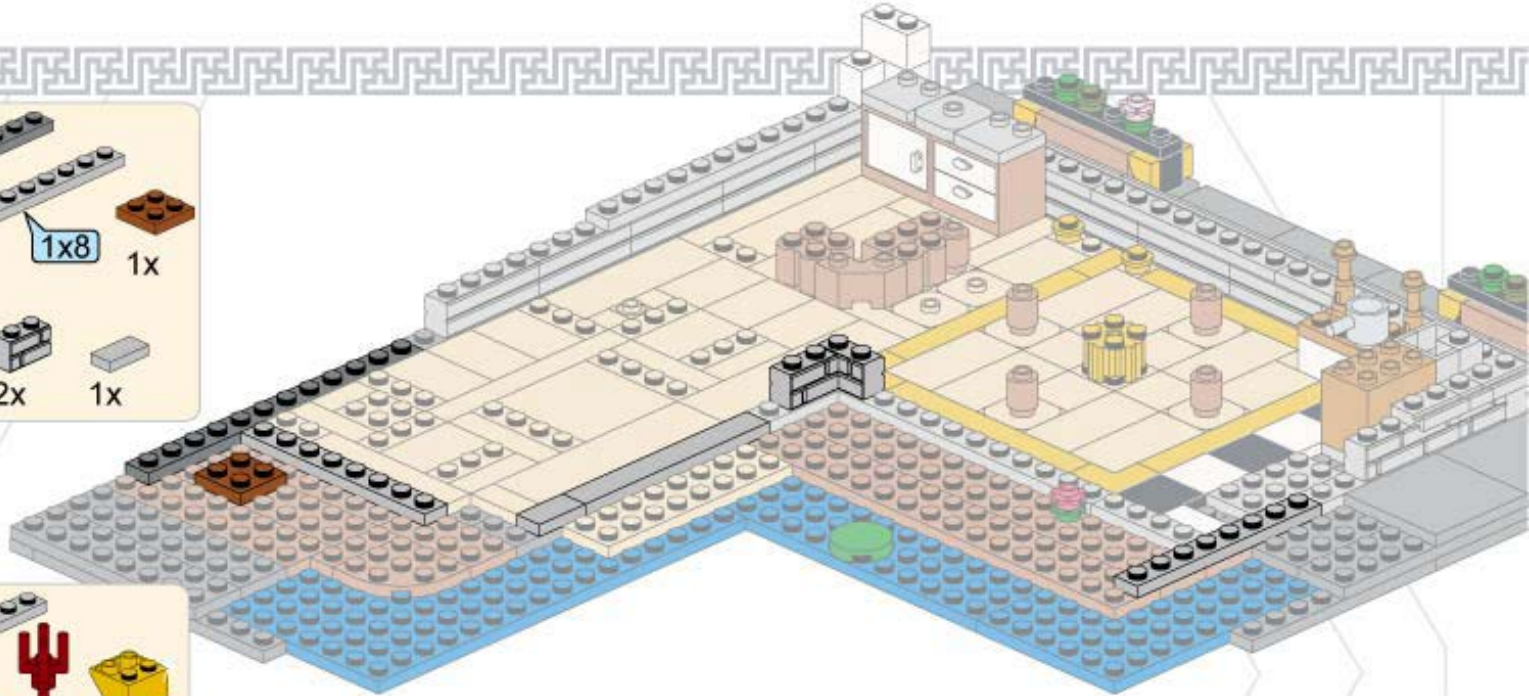

27

- 1x 1x12
- 1x Red 3-pronged Technic connector
- 2x Yellow 2x2 Technic brick with hole
- 3x Grey 1x3 Technic beam
- 1x Grey 1x2 Technic beam
- 3x Green 1x3 Technic plant
- 3x Green 1x3 Technic plant
- 1x Grey 2x4 Technic beam
- 1x Grey 1x2 Technic beam
- 1x Brown 2x2 Technic brick

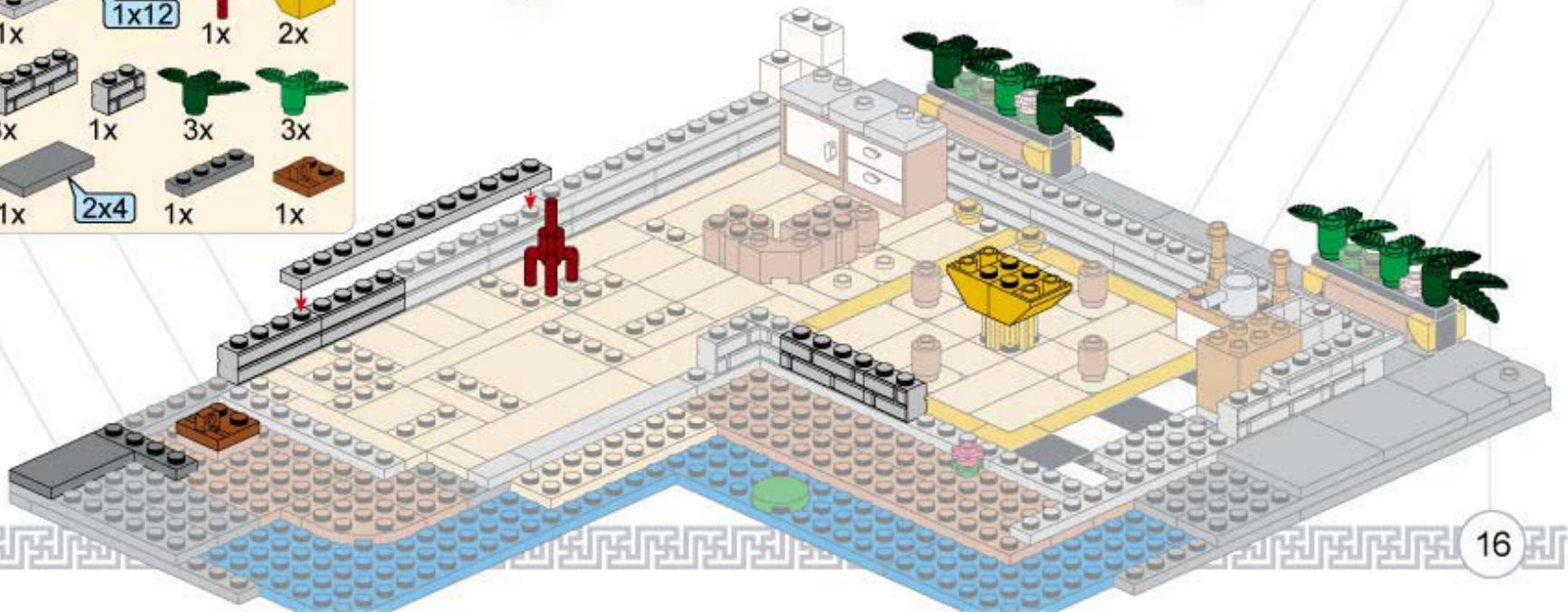

28

- 1x 1x12
- 1x
- 1x
- 2x
- 1x
- 12x
- 4x

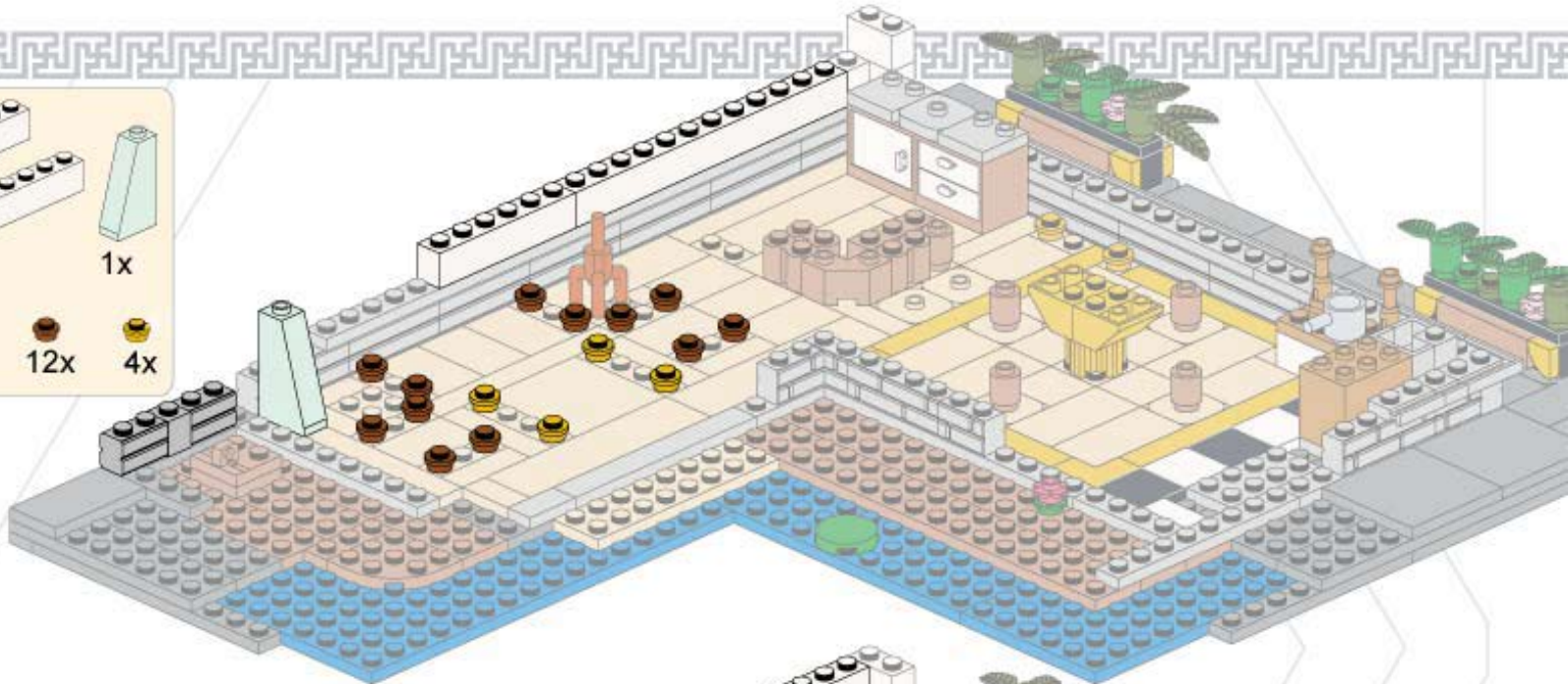

29

- 1x 1x16
- 1x
- 1x
- 1x
- 1x

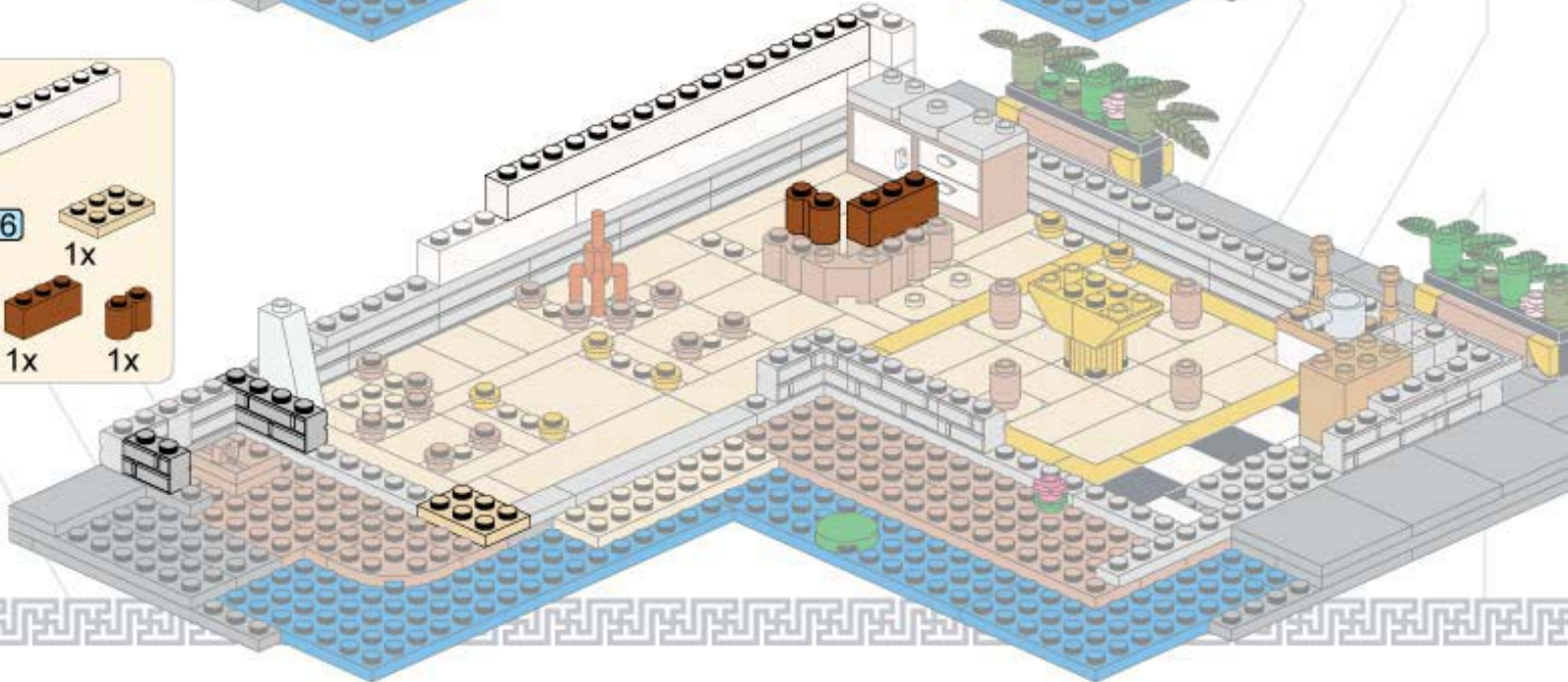

17

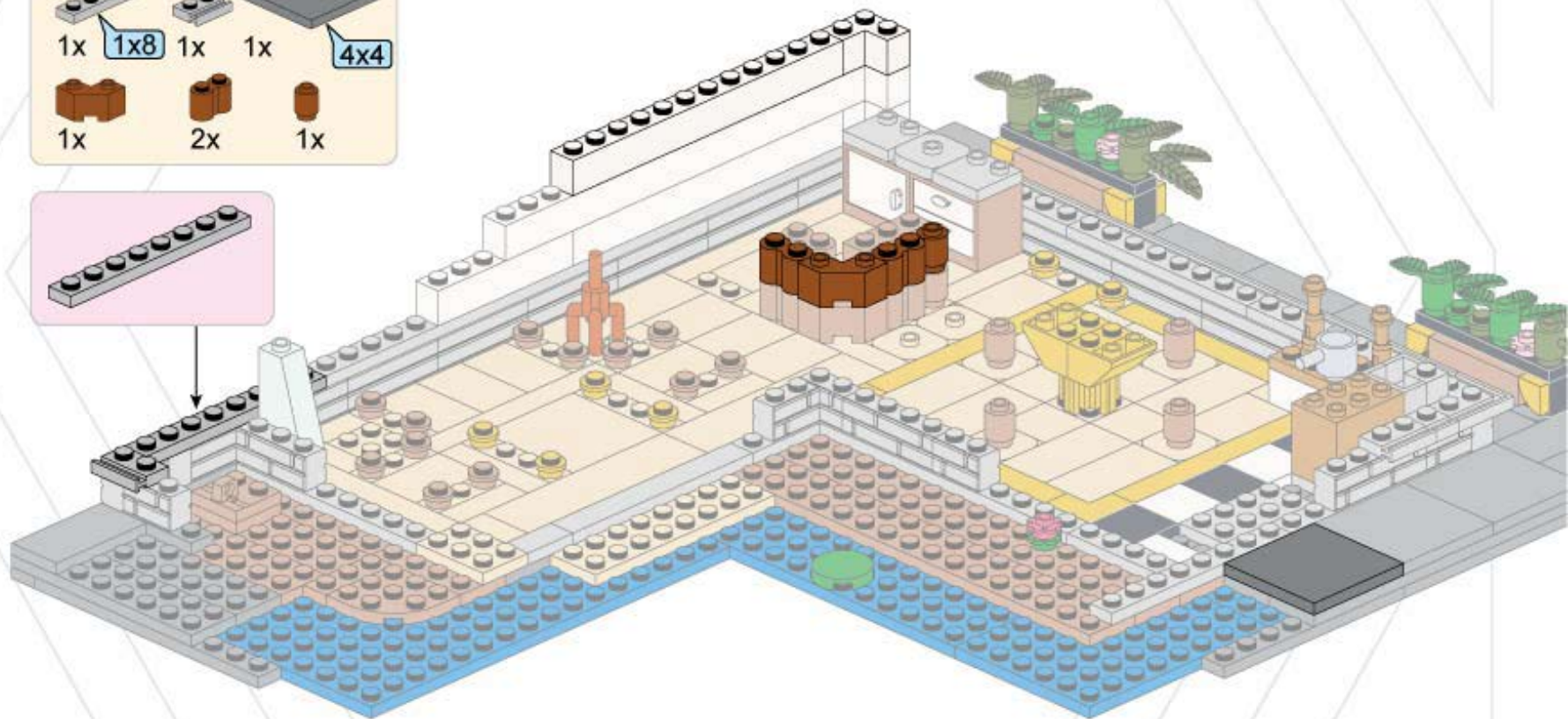
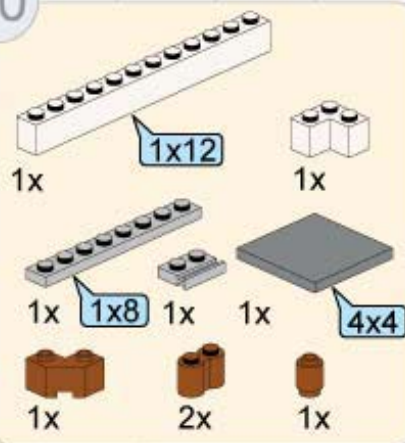





1x 1x12 2x 1x

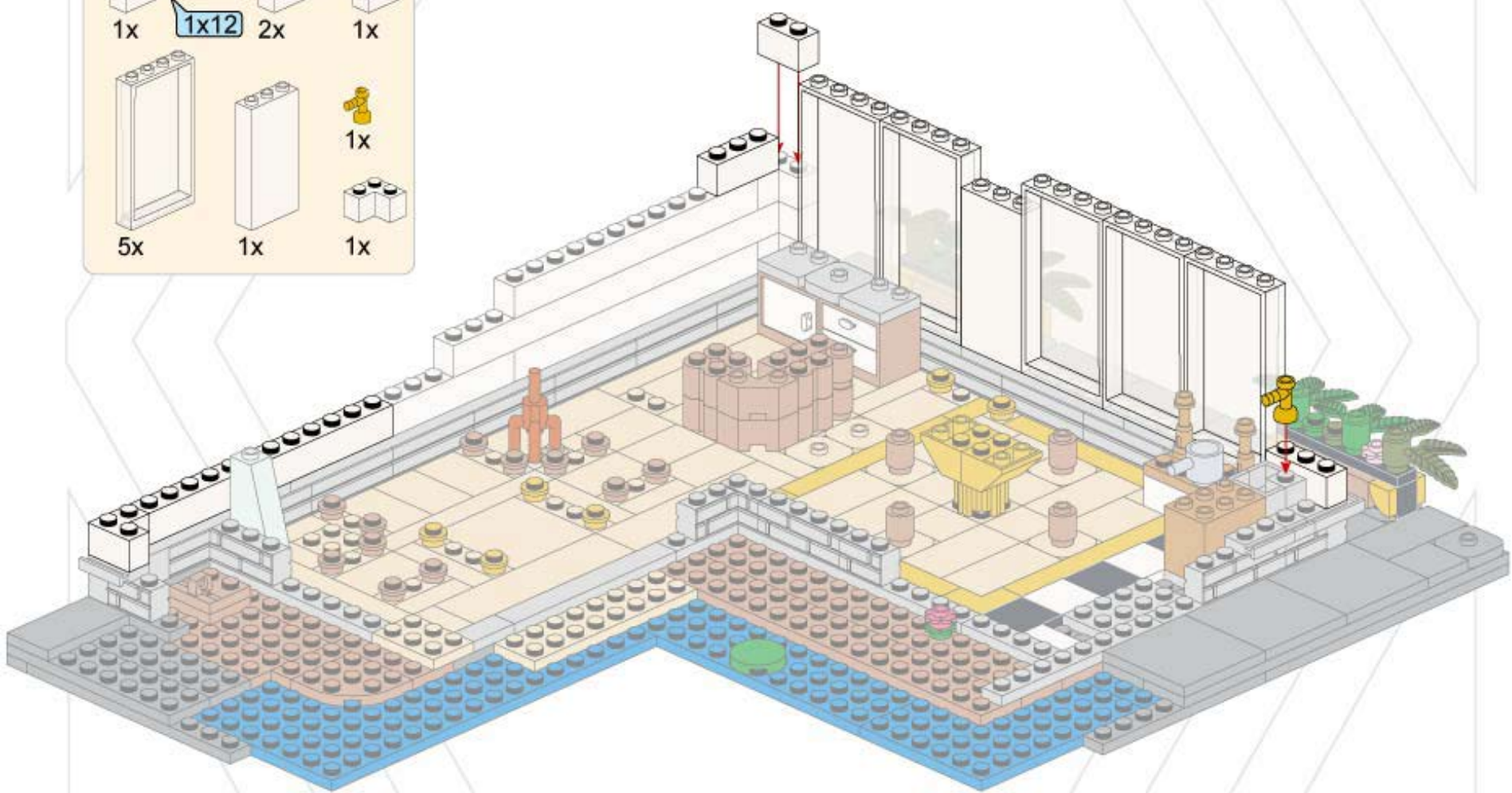

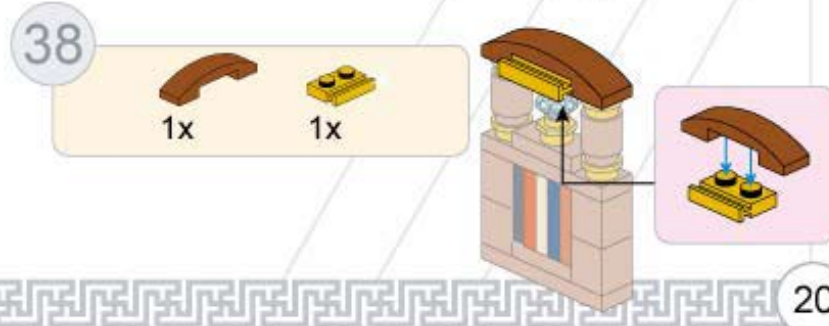
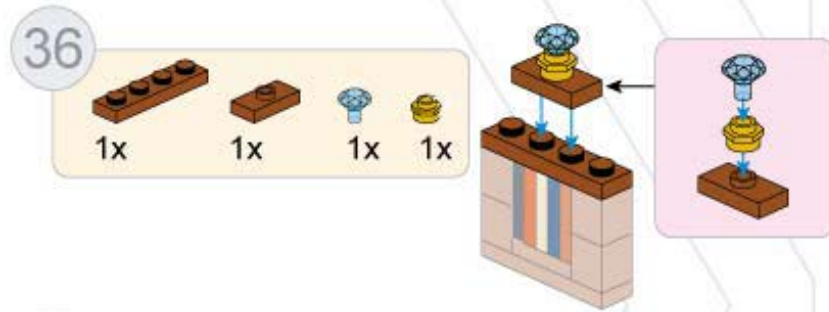
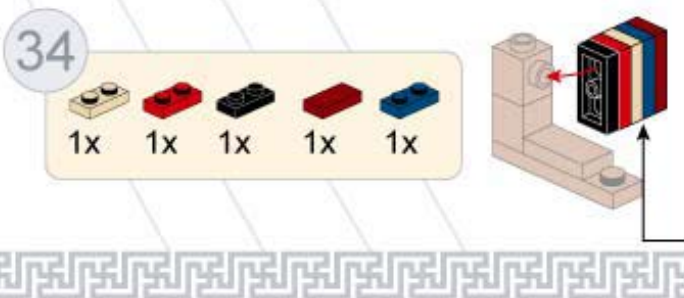
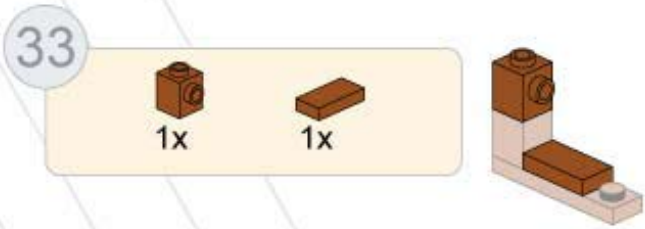
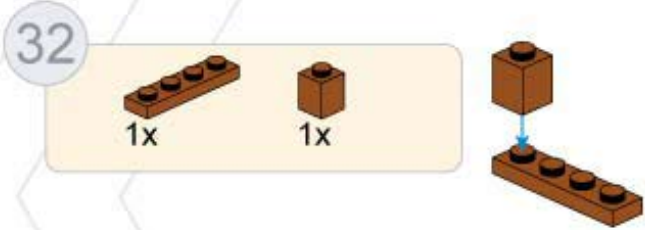

5x 1x 1x



1x







1x  1x  1x 

1x  1x  1x  1x 

1x  1x  1x 

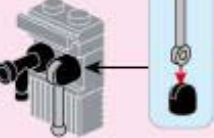
1  2  3 



40

- 1x 16x16 Blue Technic Plate
- 1x 1x8 Light Brown Technic Beam
- 2x 2x8 Light Brown Technic Beam
- 1x 1x4 White Technic Beam
- 1x 1x2 White Technic Beam
- 1x 1x2 Brown Technic Beam
- 1x 1x2 Brown Technic Beam
- 1x 1x2 Brown Technic Beam
- 2x 2x2 Red and Blue Technic Pin
- 2x 1x2 White Technic Pin
- 2x 1x2 White Technic Pin
- 1x 1x2 White Technic Pin
- 1x 1x2 Blue Technic Pin
- 1x 1x2 White Technic Pin
- 1x 1x2 Blue Technic Pin
- 2x 2x2 Red and Blue Technic Pin



2x

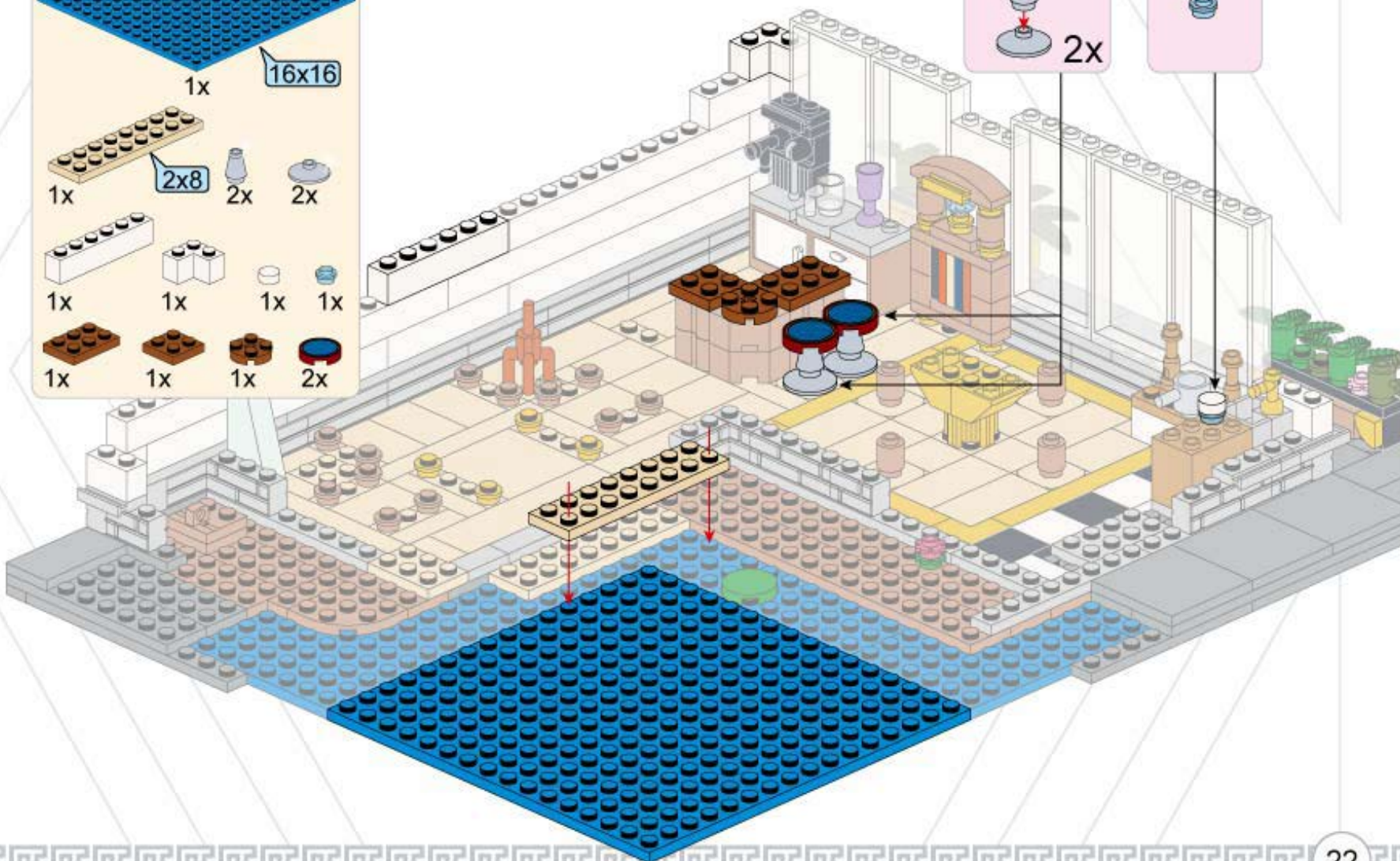

22

- 1x [1x12 white Technic beam]
- 2x [pink flower]
- 1x [red flower]
- 1x [white Technic brick with hole]
- 1x [white Technic brick with hole]
- 1x [white Technic brick with hole]
- 1x [tan Technic plate]
- 1x [tan Technic plate]
- 1x [black Technic plate]
- 1x [grey Technic bush]
- 2x [grey Technic bush]
- 1x [red Technic bush]
- 1x [red Technic bush]
- 3x [yellow Technic bush]
- 2x [blue Technic bush]

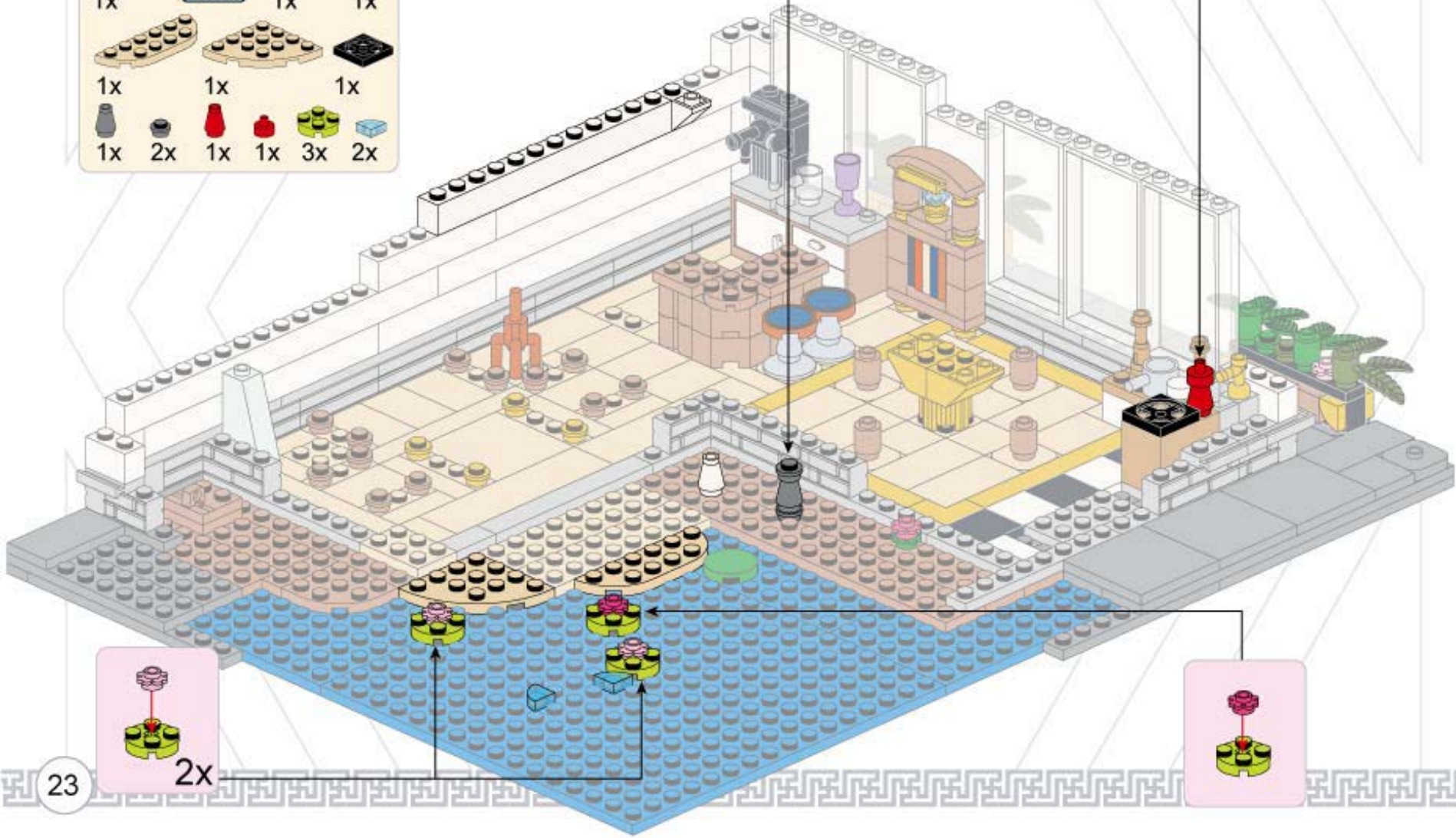
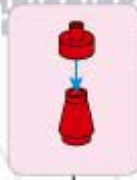
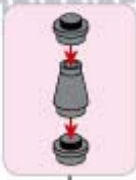

2x



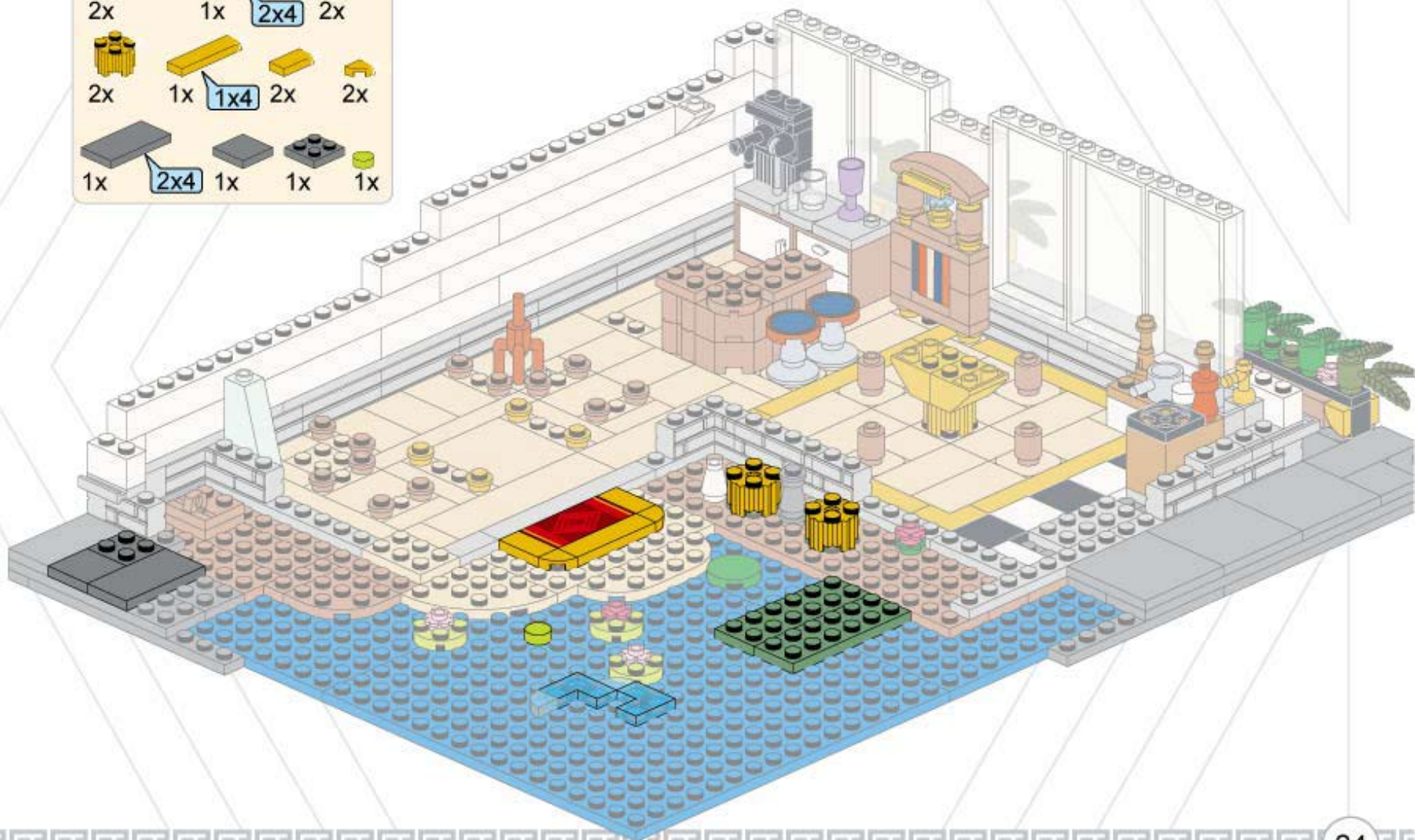
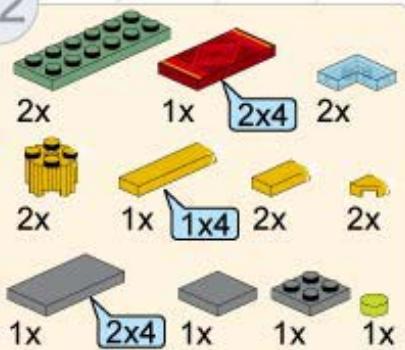

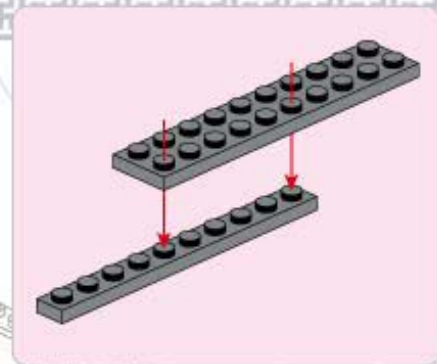
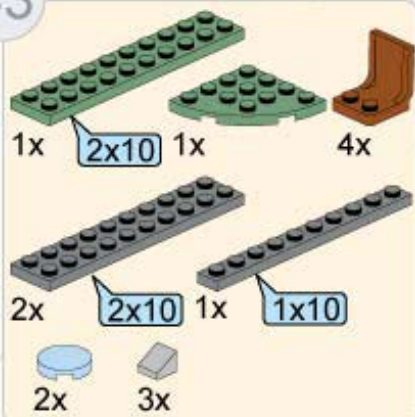

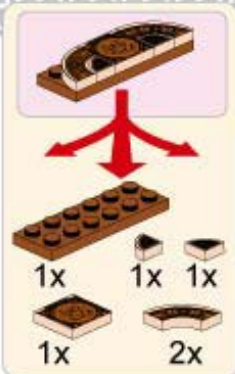

44

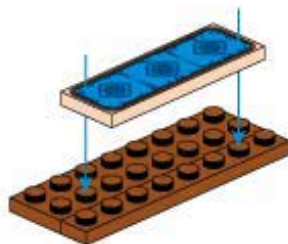
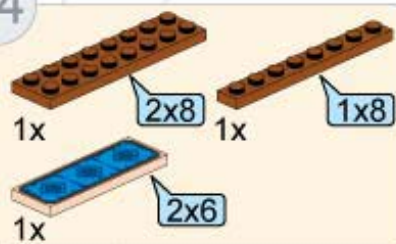

45

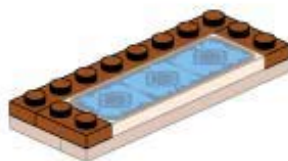

46

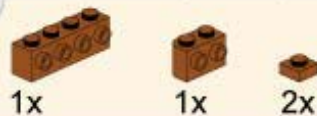

47

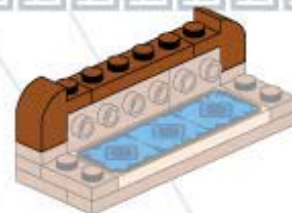

48



49



50

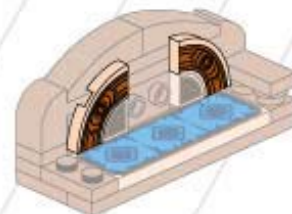

51



52

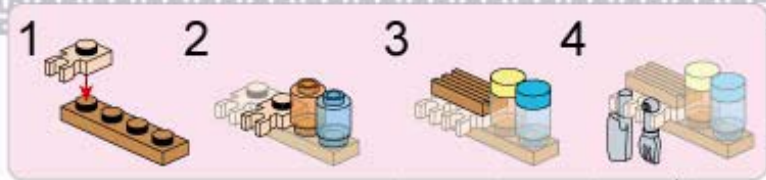
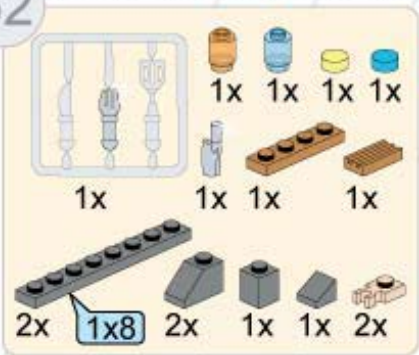

51



27

53

- 2x 2x16
- 2x 2x
- 2x 1x10
- 2x 2x
- 1x 2x
- 1x 4x6
- 1x 2x

- 1
- 2

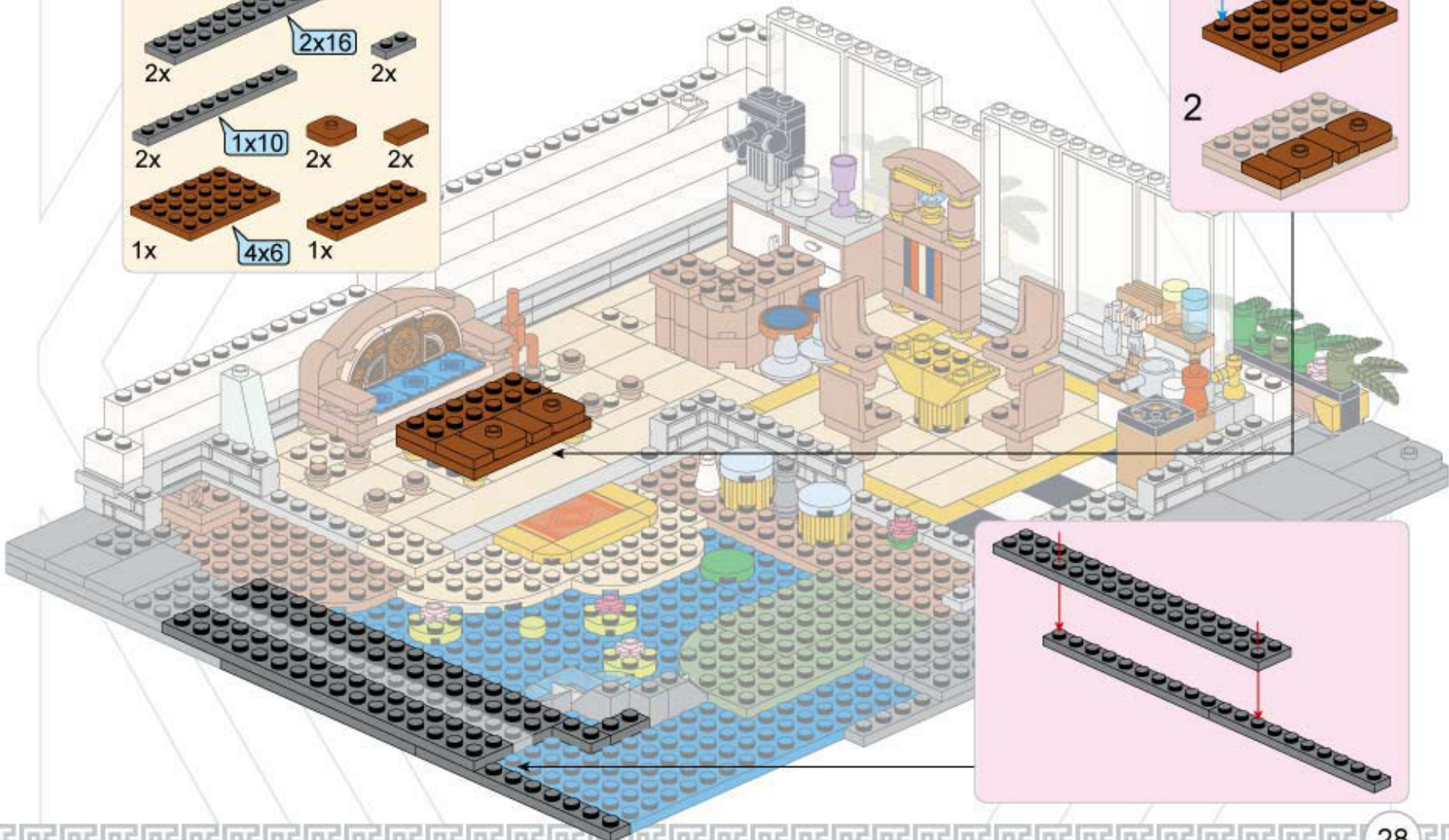
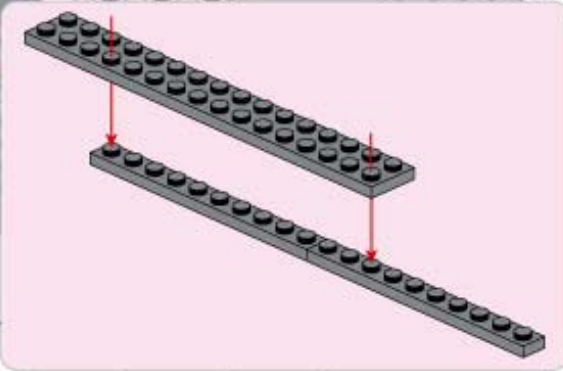

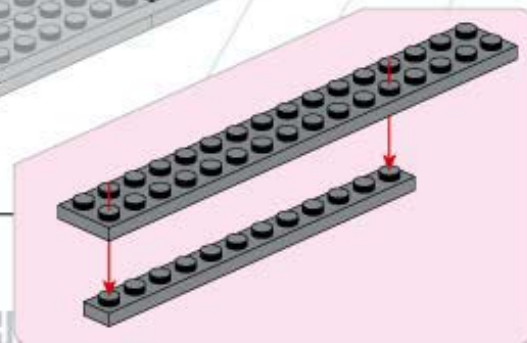
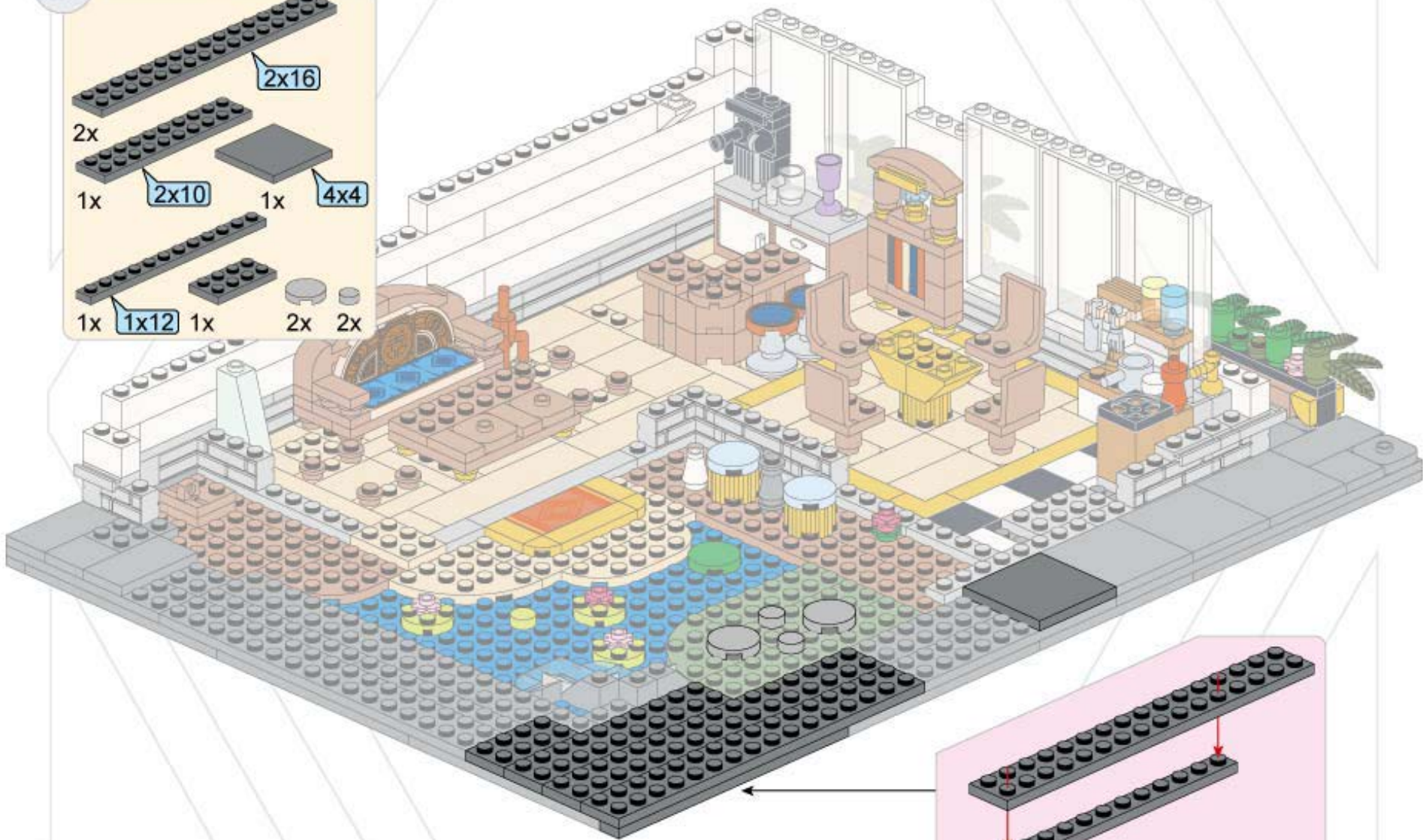
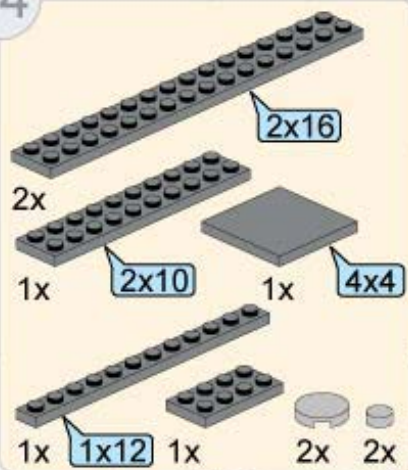



1x



3A



3B



55

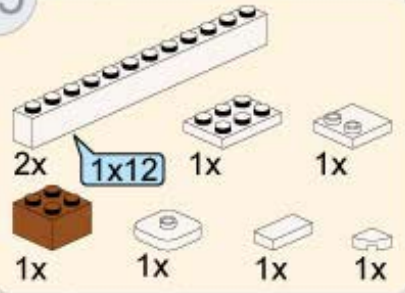

2x

1x12

1x

1x

1x

1x

1x

1x

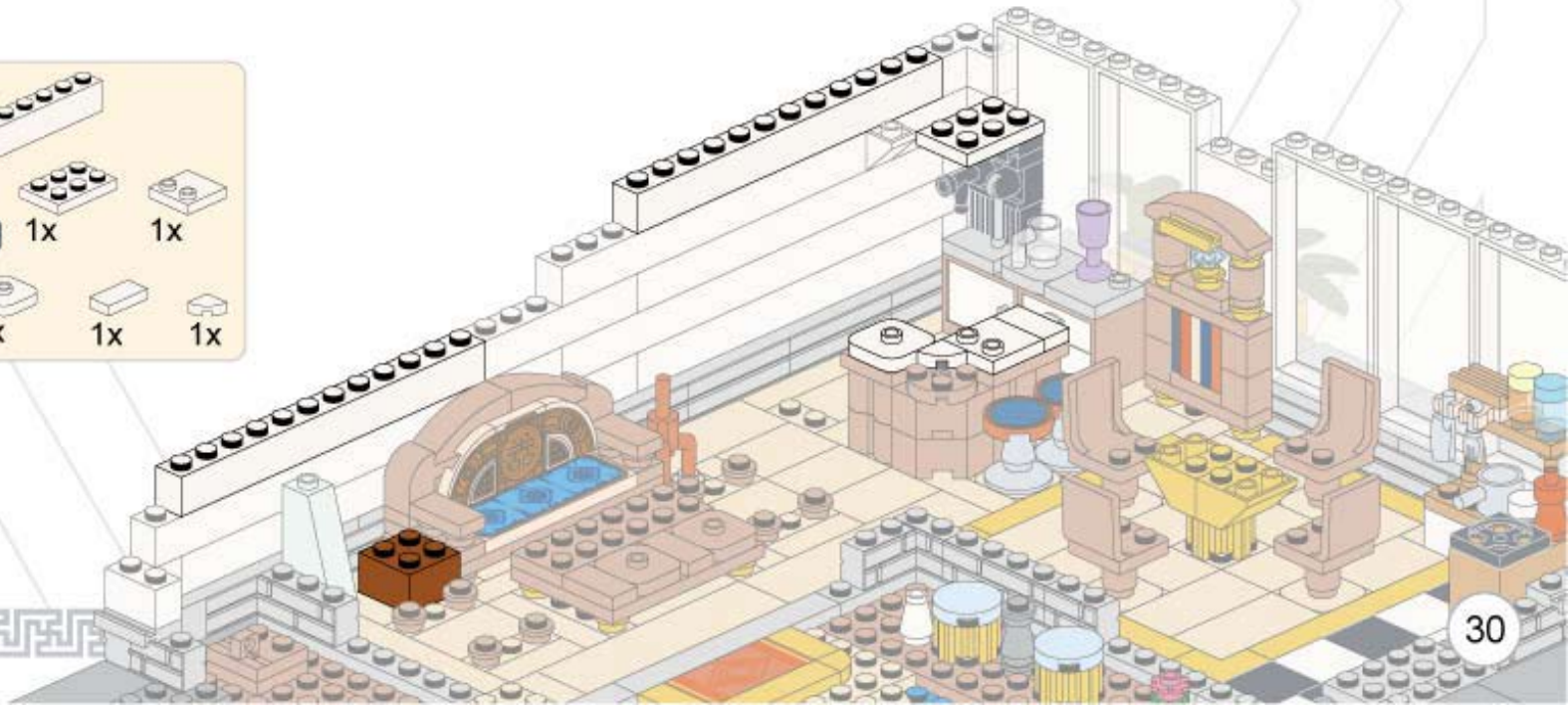

30



56



1x



1x

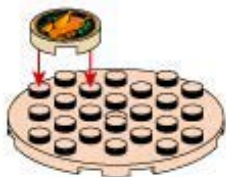

57



1x



1x



1x



58



1x



1x



59



1x



1x



2x



1



2



60



1x



61

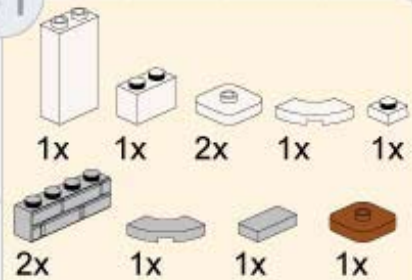

60

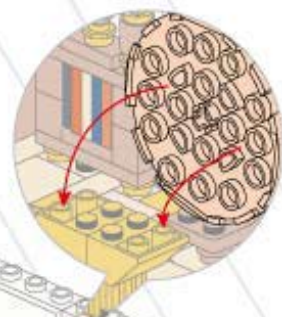

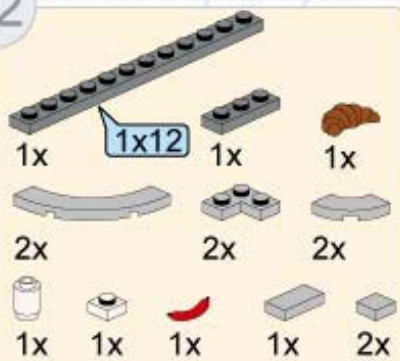

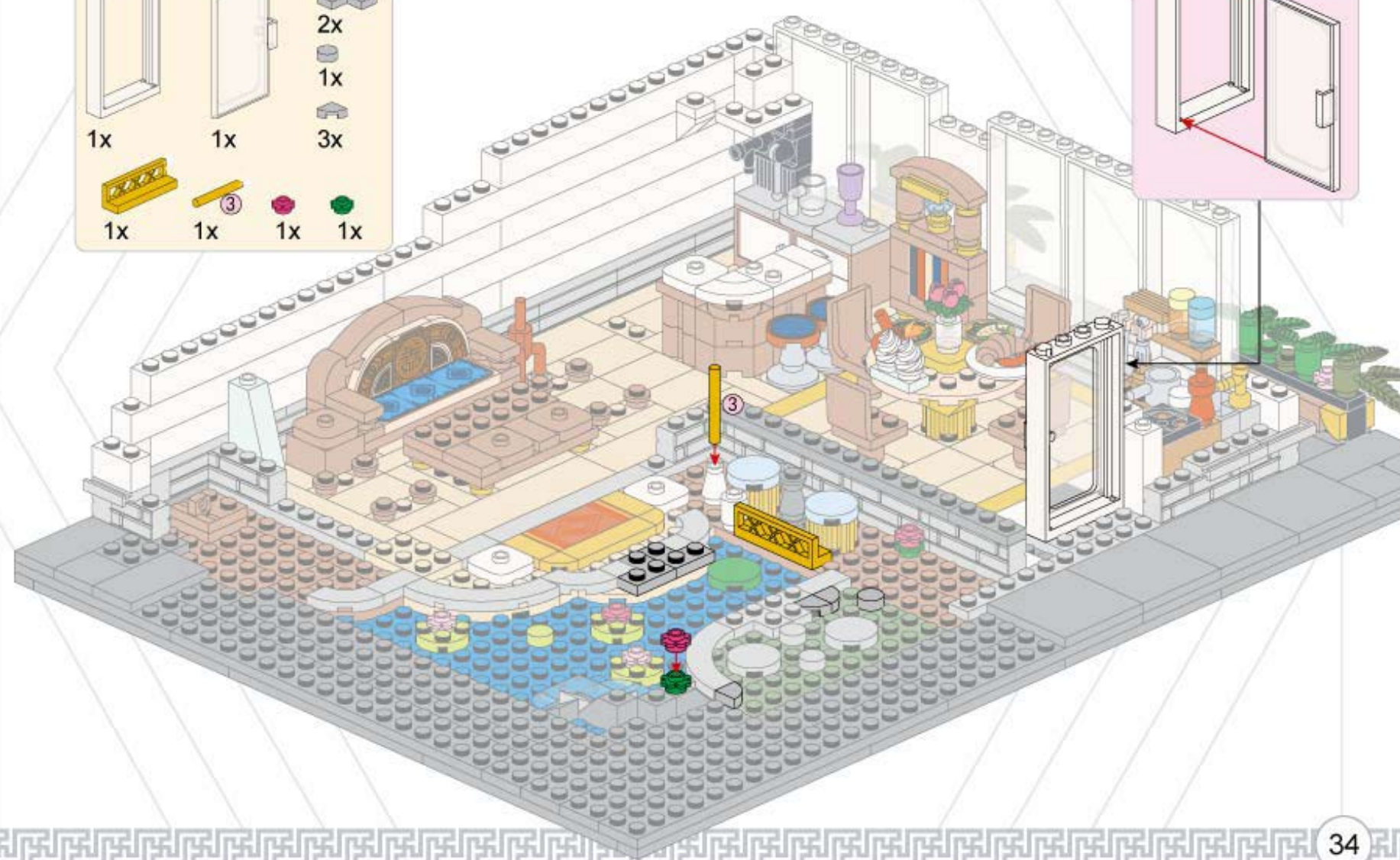
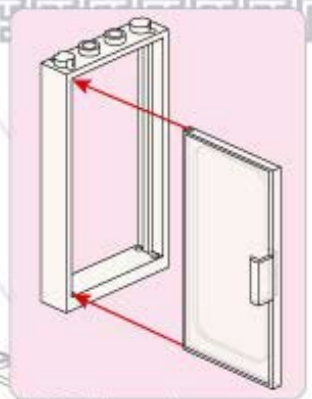

63

- 1x [White window frame]
- 1x [White window pane]
- 2x [Grey 1x2 Technic brick]
- 1x [Grey 1x2 Technic brick with hole]
- 3x [Grey 1x2 Technic brick with hole]
- 1x [Yellow Technic axle]
- 1x [Yellow Technic axle with pin]
- 1x [Red Technic pin]
- 1x [Green Technic pin]



- 1x  2x10
- 1x  1x 
- 1x  1x  1x  1x  1x 
- 1x  1x  1x  1x 
- 2x  1x  1x  1x 

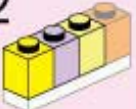

- 1  being placed on top of a white 1x2 Technic Technonut." data-bbox="845 585 915 645"/>
- 2 
- 3 

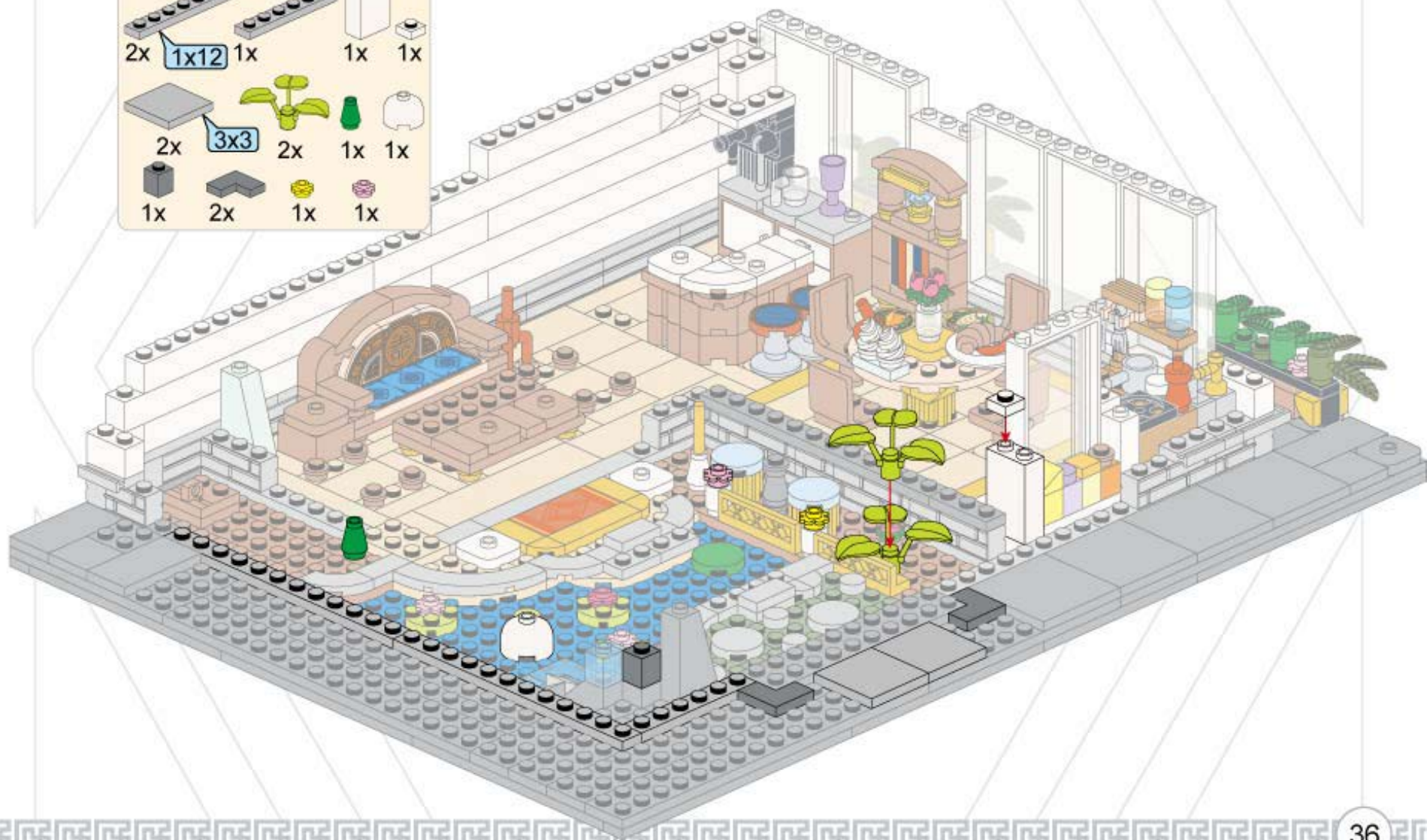
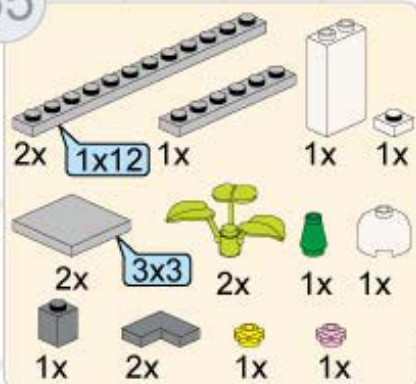

1:1

Parts list for step 66:

- 1x 1x3 Technic brick with holes
- 2x 1x2 Technic brick with holes
- 1x 1x1 Technic brick with hole
- 1x 1x1 Technic brick with hole
- 7x 1x2 Technic brick with holes
- 1x 1x1 Technic brick with hole
- 3x 1x1 Technic brick with hole
- 2x 1x2 Technic brick with holes
- 2x 1x1 Technic brick with hole

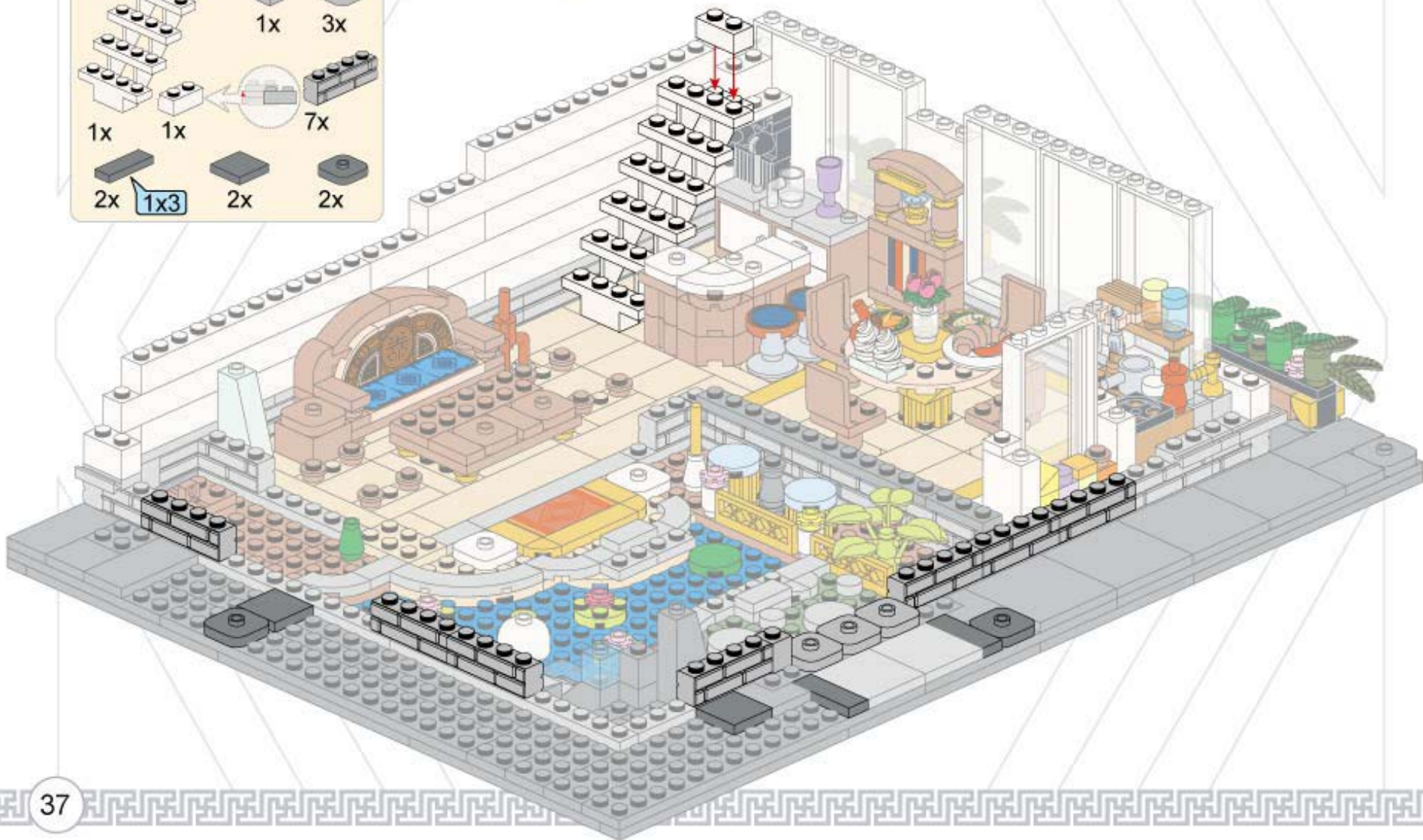

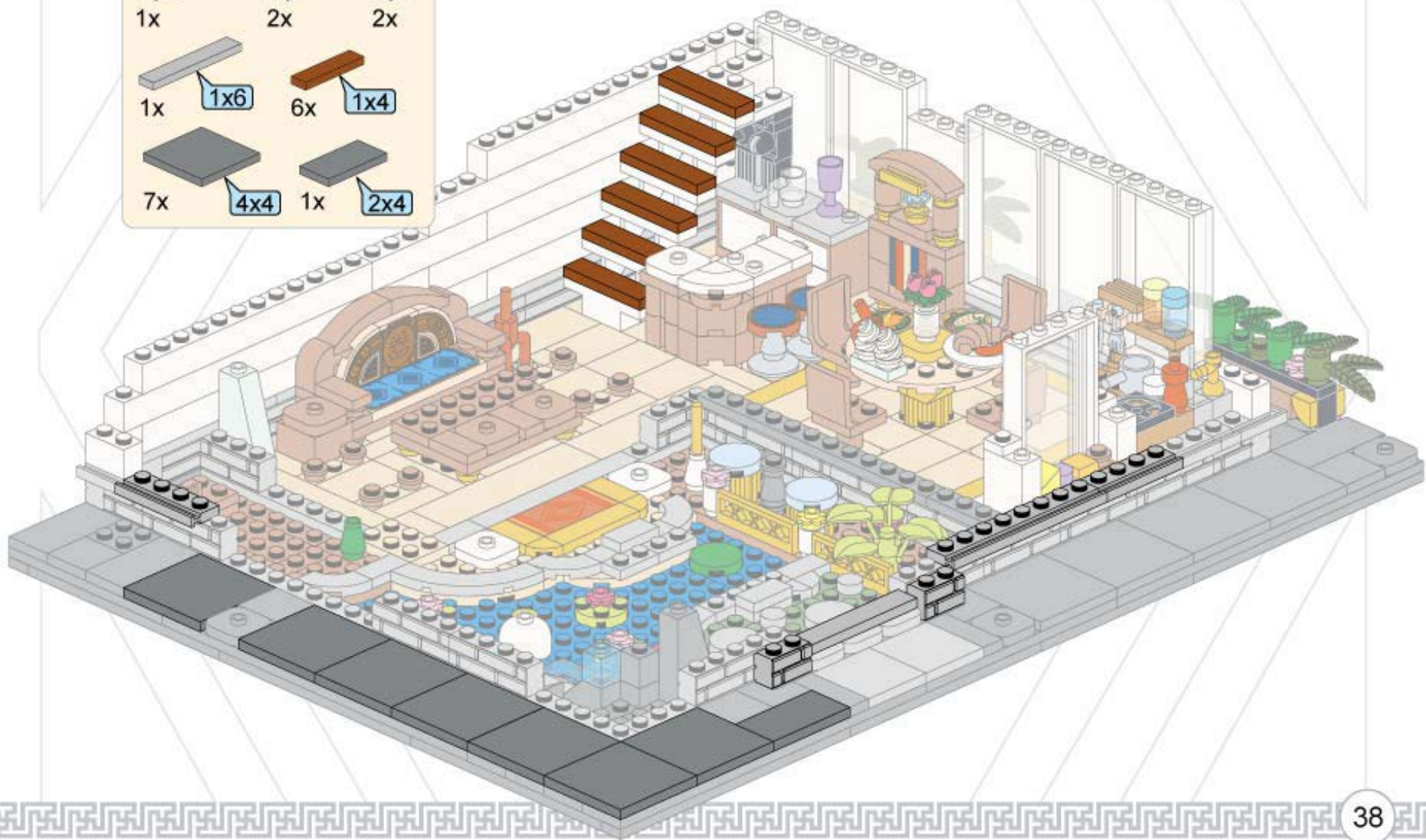
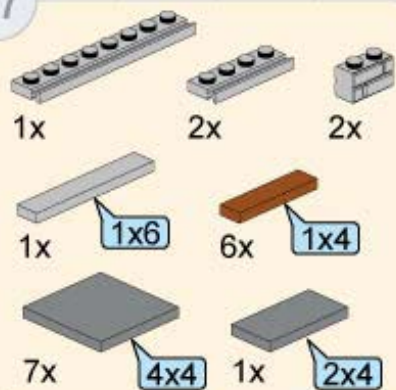

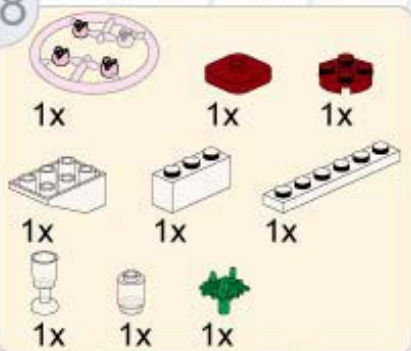

1



2



- 1x [Grey 1x2 Technic Brick]
- 1x [White 1x2 Technic Brick]
- 1x [White 1x2 Technic Brick]
- 1x [Brown 1x2 Technic Brick]
- 1x [Light Green 1x2 Technic Brick]
- 1x [Light Blue 1x2 Technic Brick]
- 1x [Black 1x2 Technic Brick]
- 1x [Green 1x2 Technic Brick]

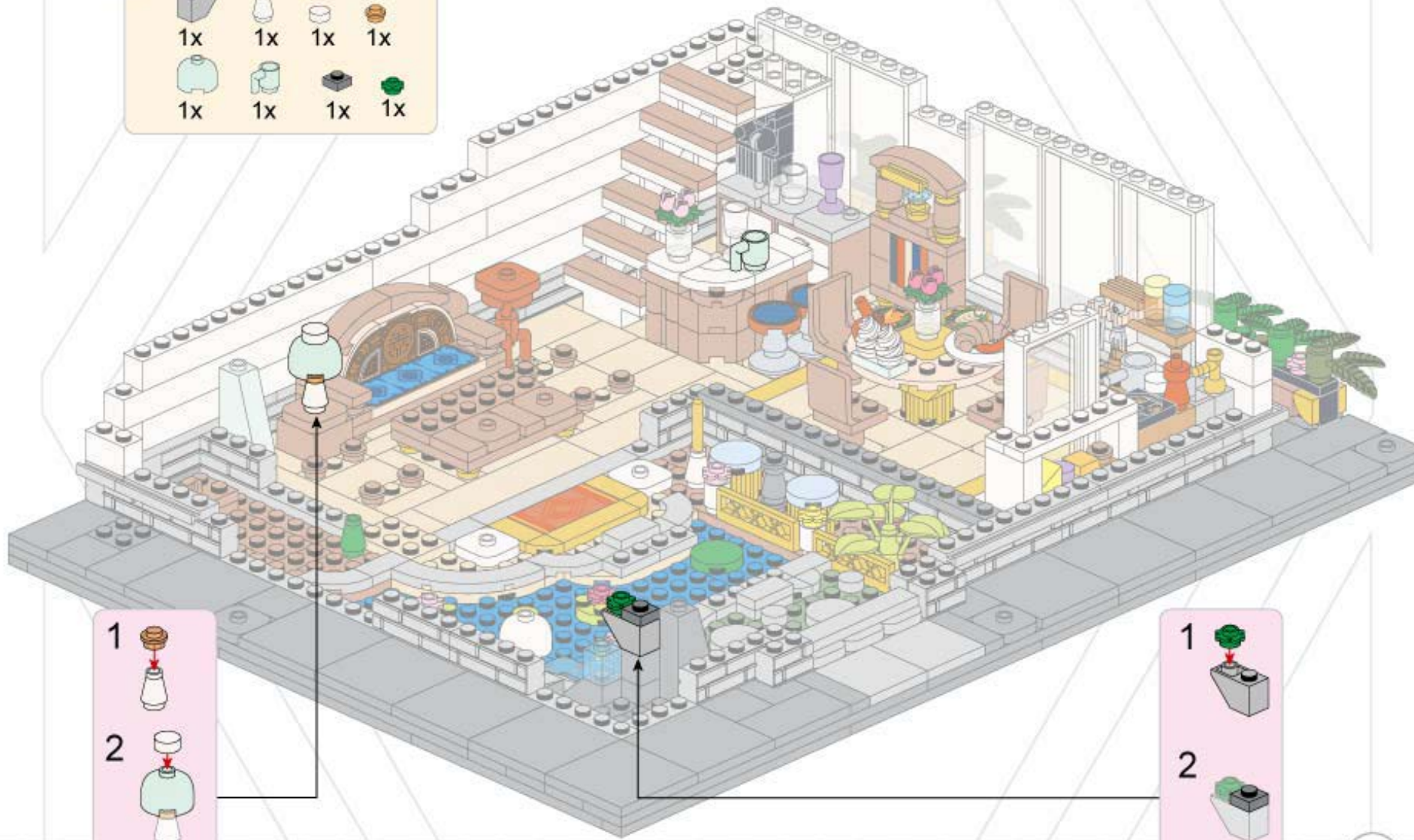

- 1 [Brown 1x2 Technic Brick]
- 2 [Light Green 1x2 Technic Brick]

- 1 [Green 1x2 Technic Brick]
- 2 [Grey 1x2 Technic Brick]

- 2x [1x2 brown brick]
- 4x [1x2 brown brick with hole]
- 2x [1x4 brown brick]
- 4x [1x2 brown brick]
- 4x [1x4 brown brick]
- 4x [1x2 brown brick]
- 6x [1x3 brown brick]
- 8x [1x2 brown brick]
- 1x [1x4 grey brick]
- 1x [1x2 blue brick]
- 2x [1x2 blue plate]
- 2x [1x2 black plate]

- 1
 - 2
 - 3
 - 4
 - 5
 - 6
- 2x

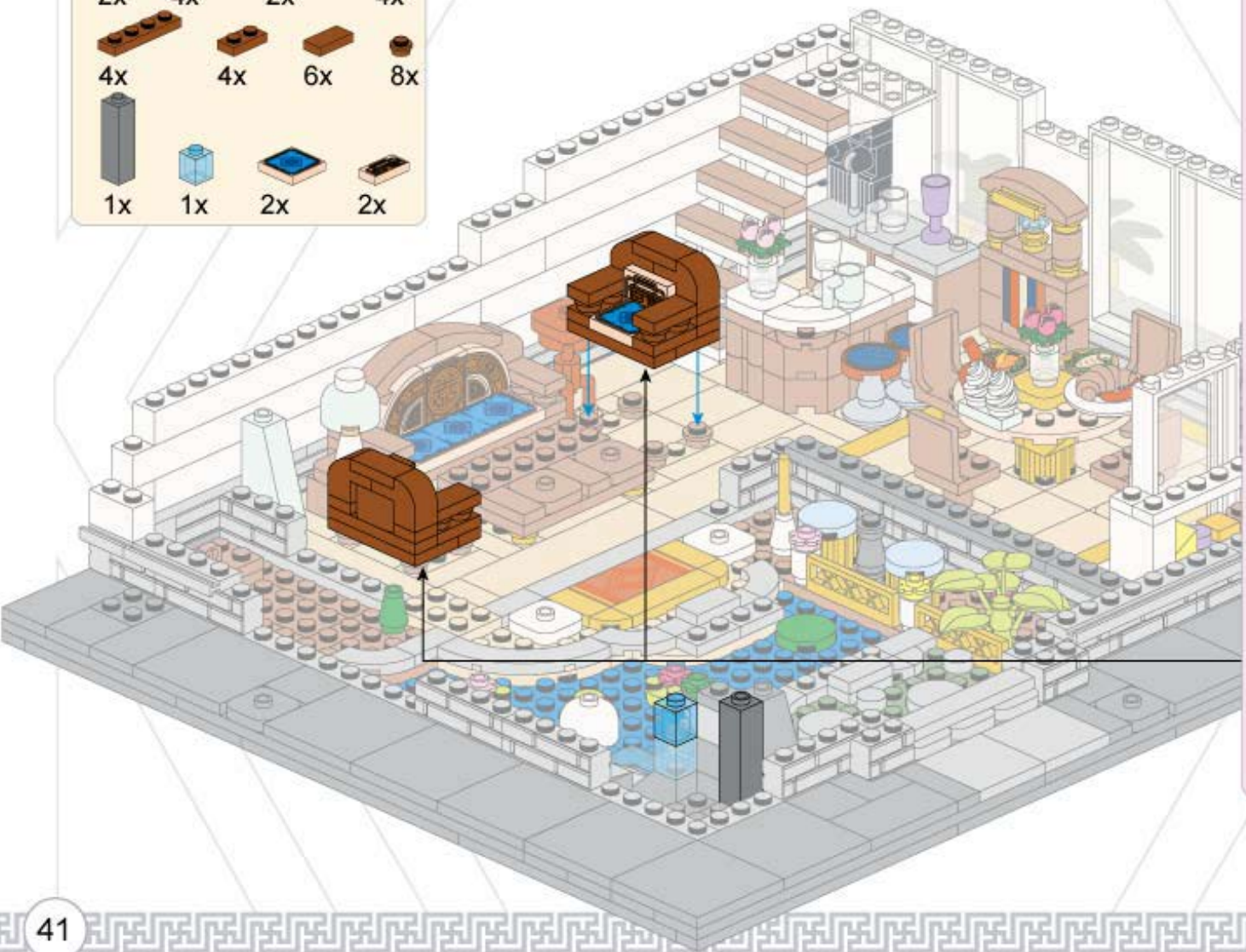

71

- 1x
- 1x
- 1x
- 1x
- 1x
- 2x
- 6x
- 3x
- 1x
- 1x
- 1x

-
-
-

-
-
-

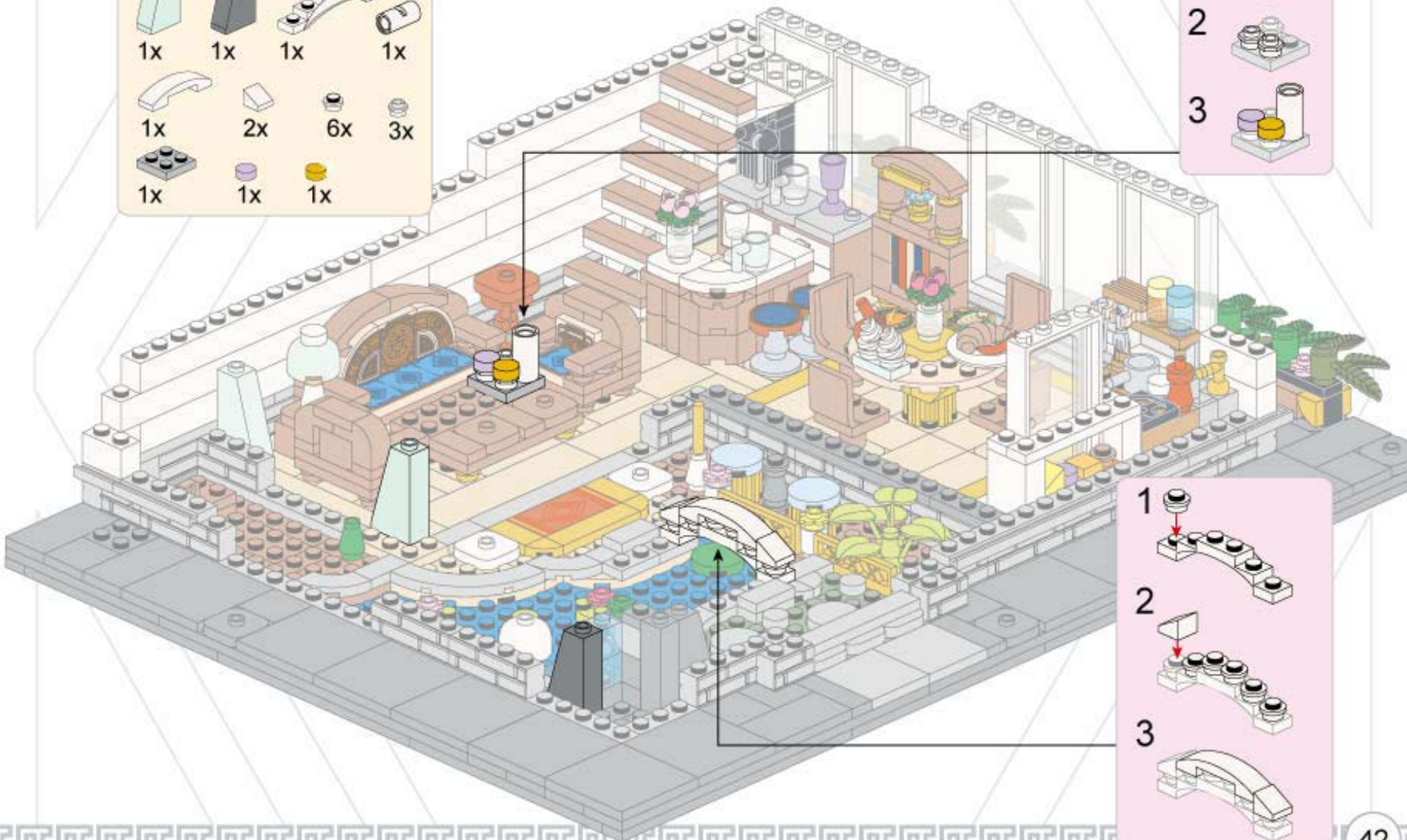

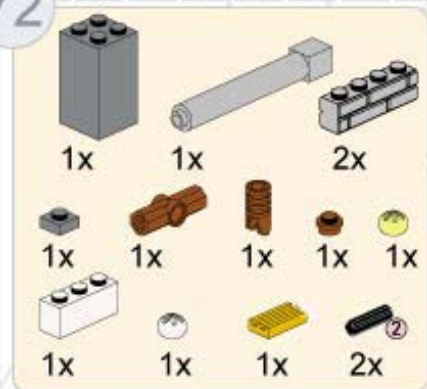

② 1:1

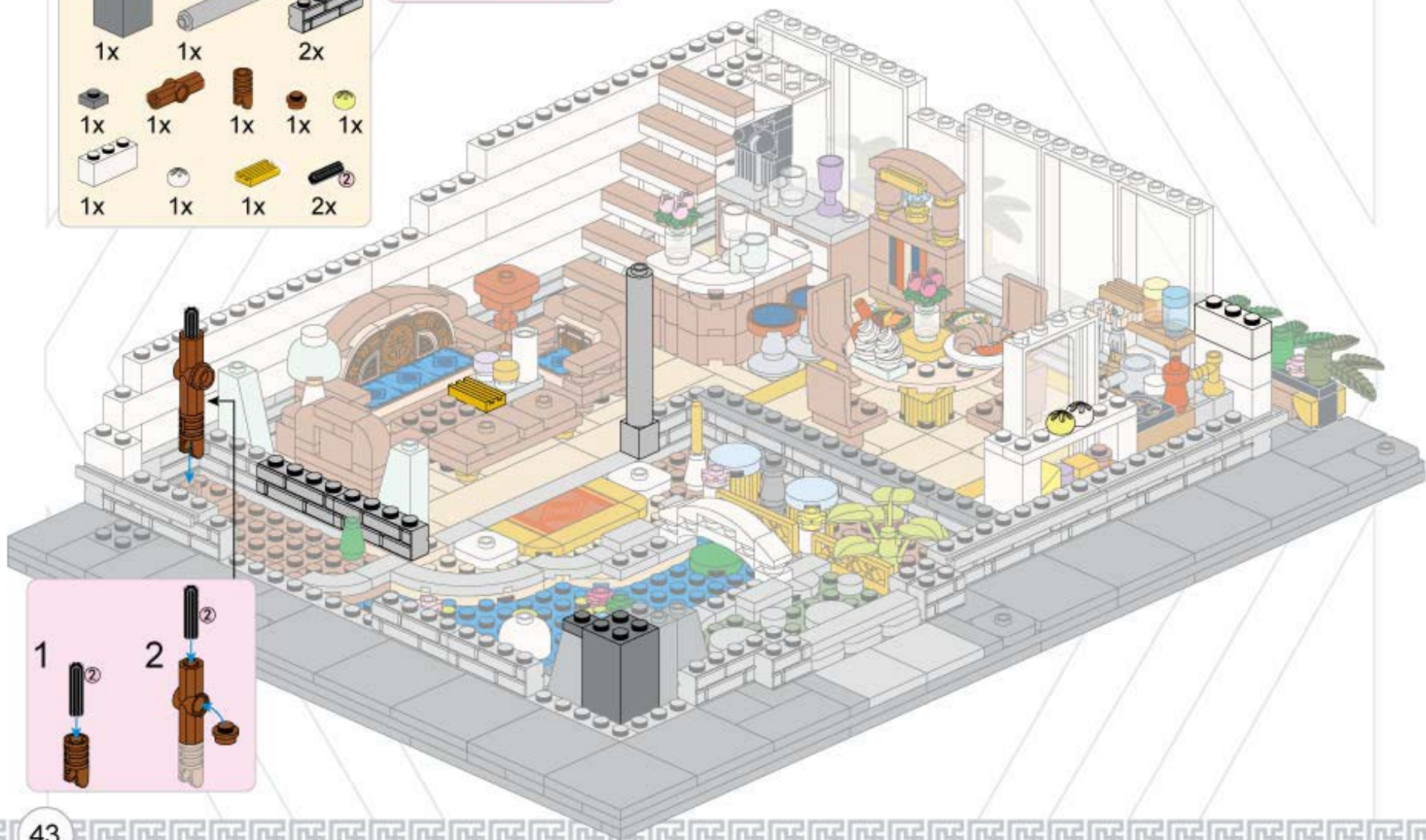













1





2



73

- 1x  1x  1x 
- 1x  1x  1x  1x  1x 
- 2x  1x  1x  1x 

- 1 
- 2 
- 3 

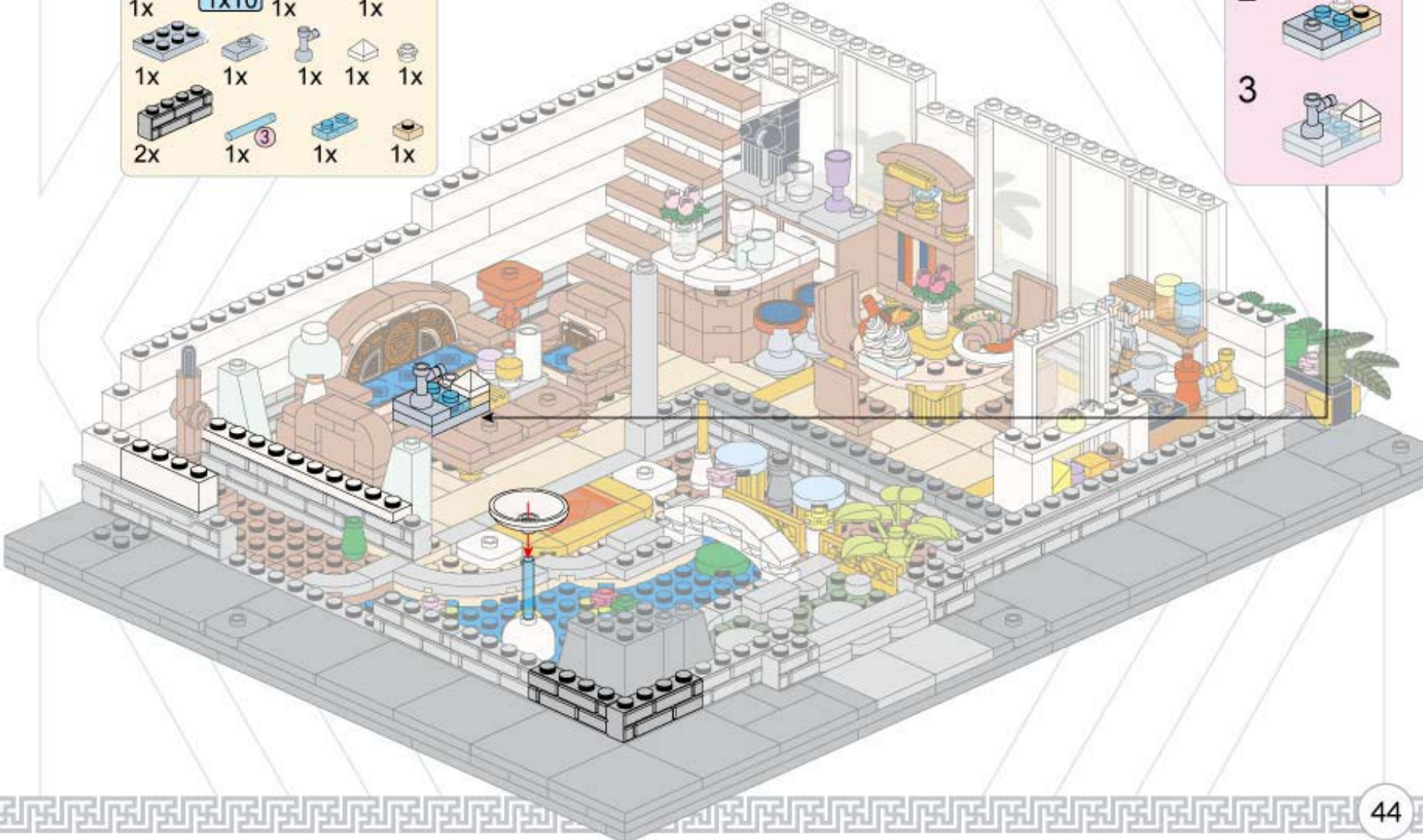

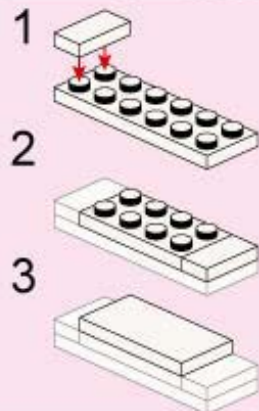
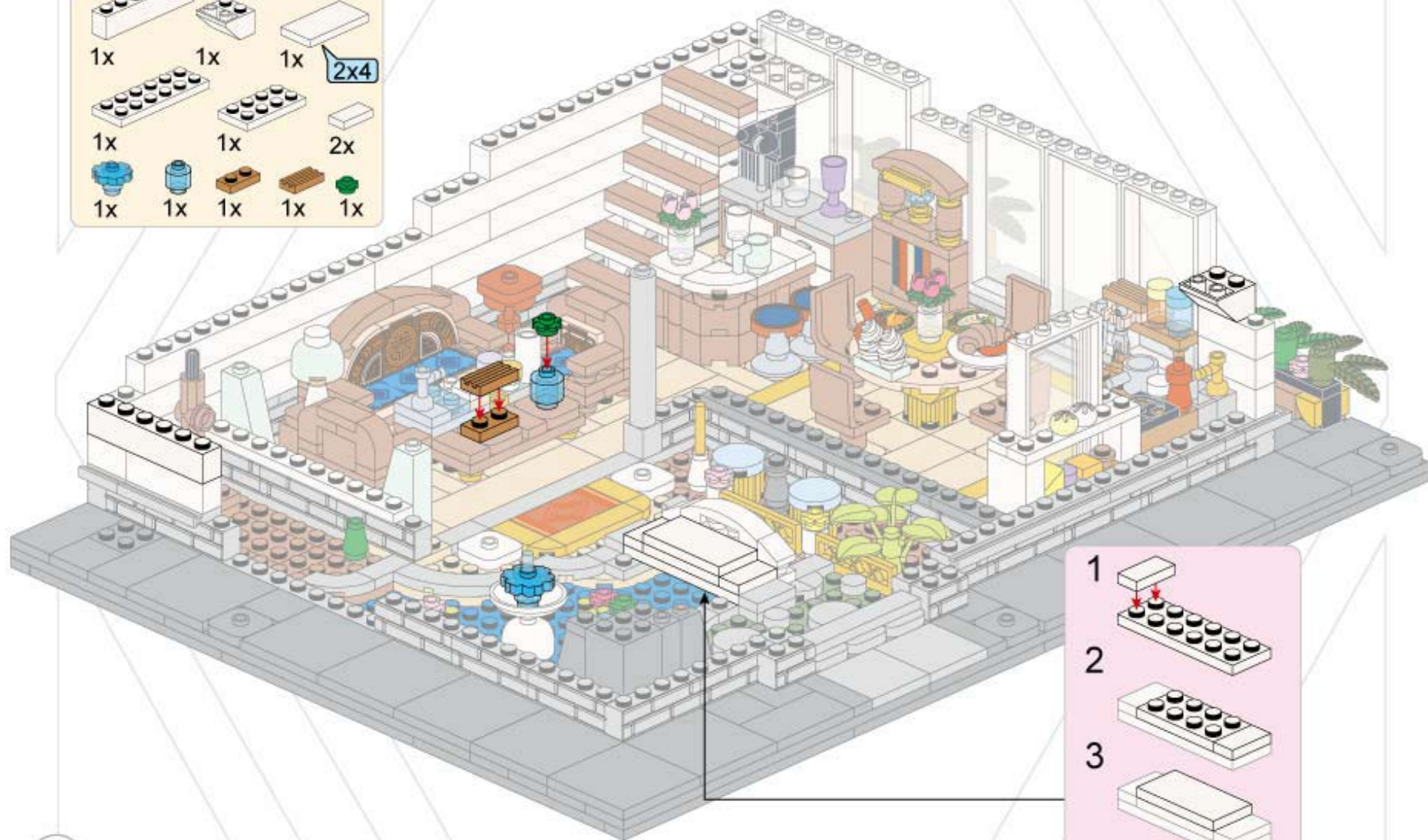
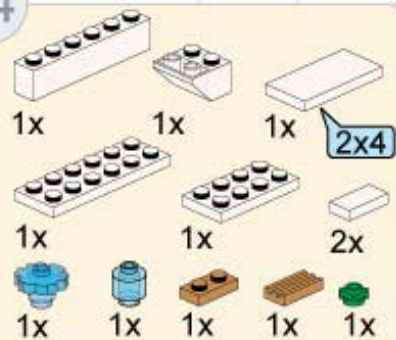

75

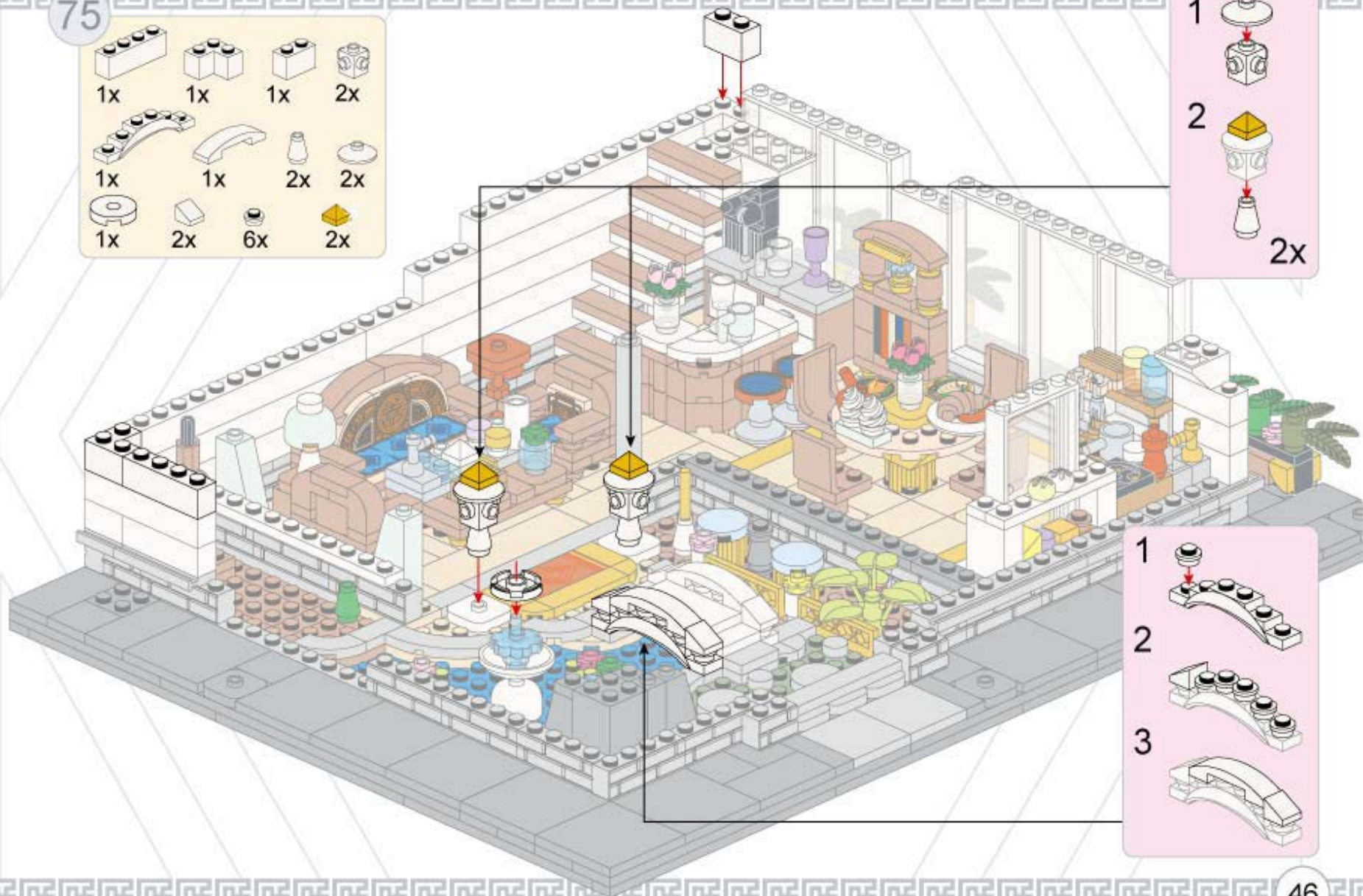
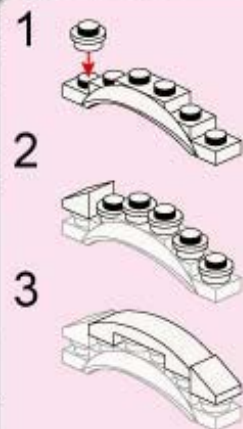
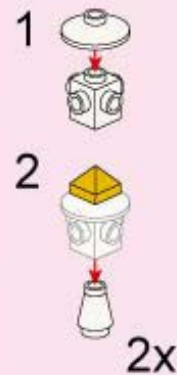

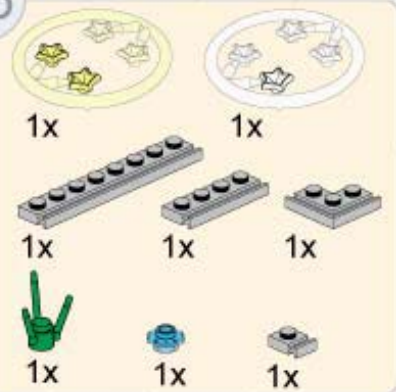

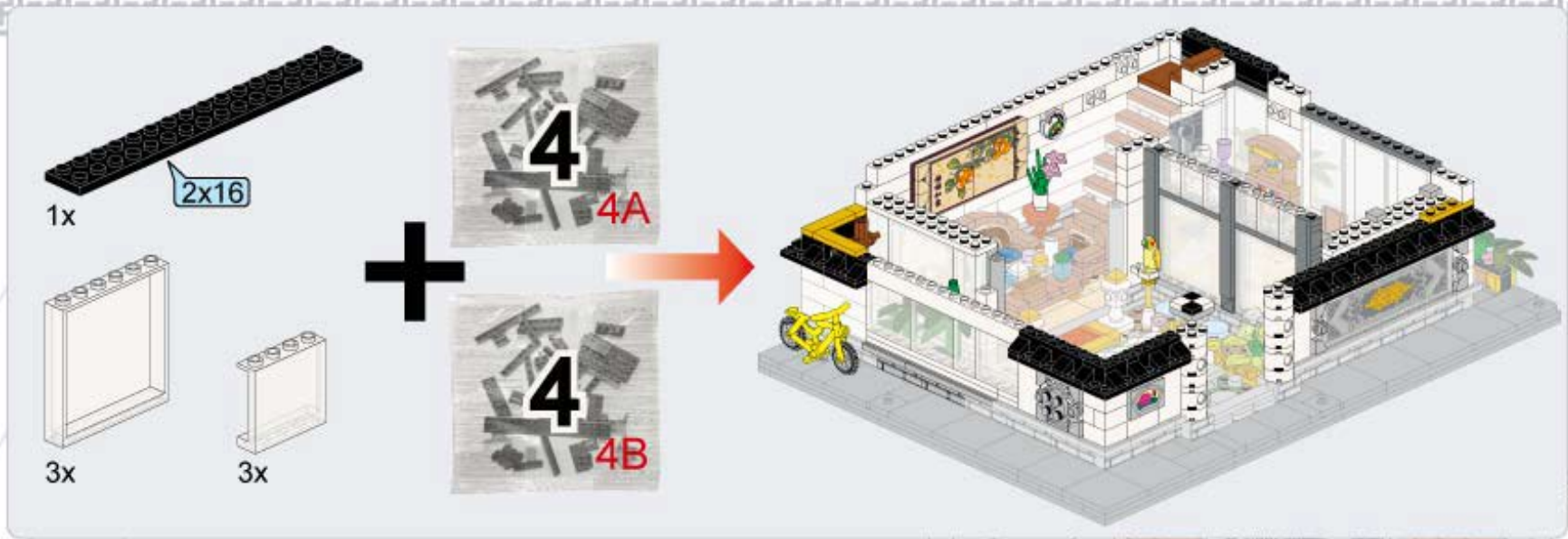

77

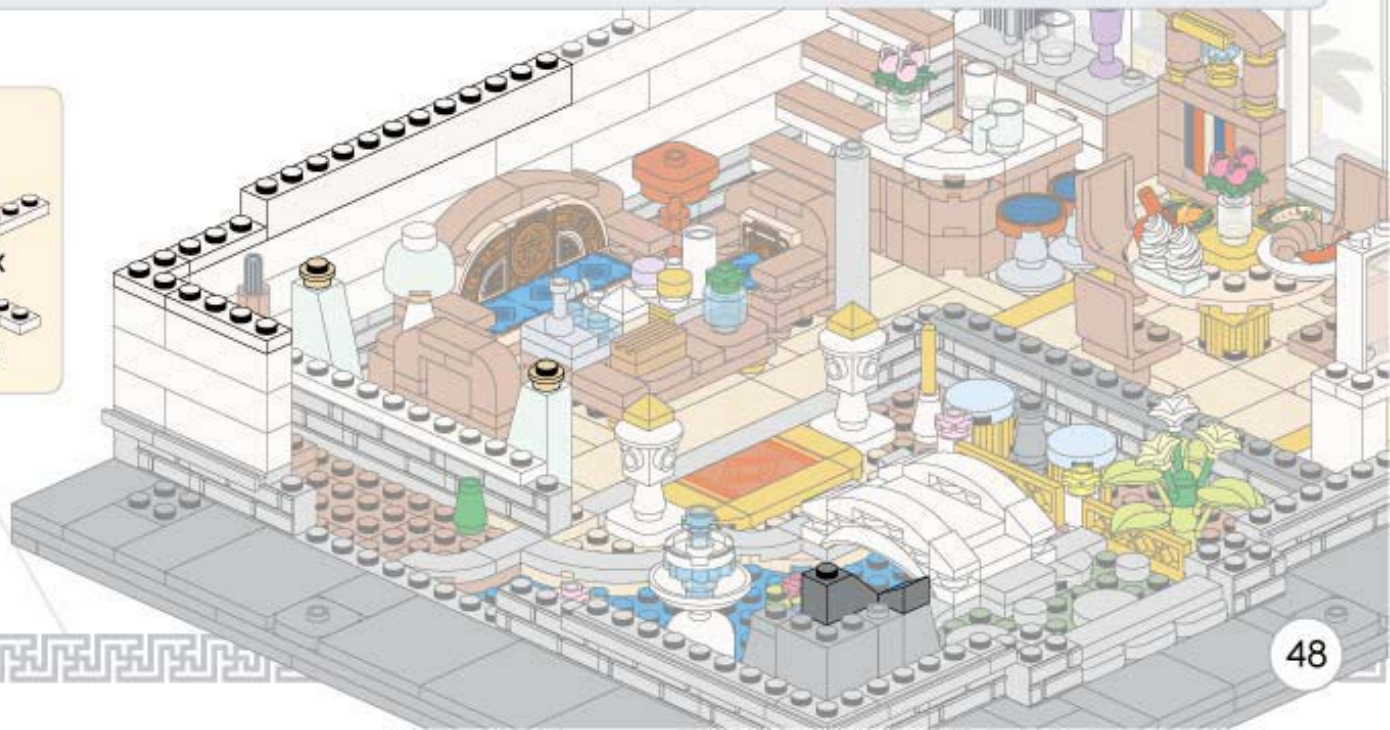
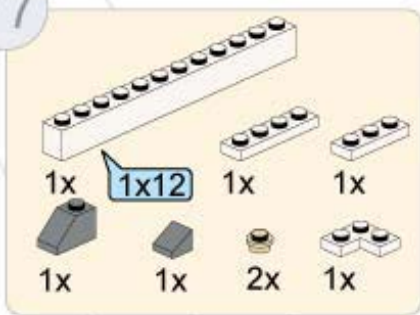

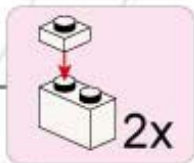
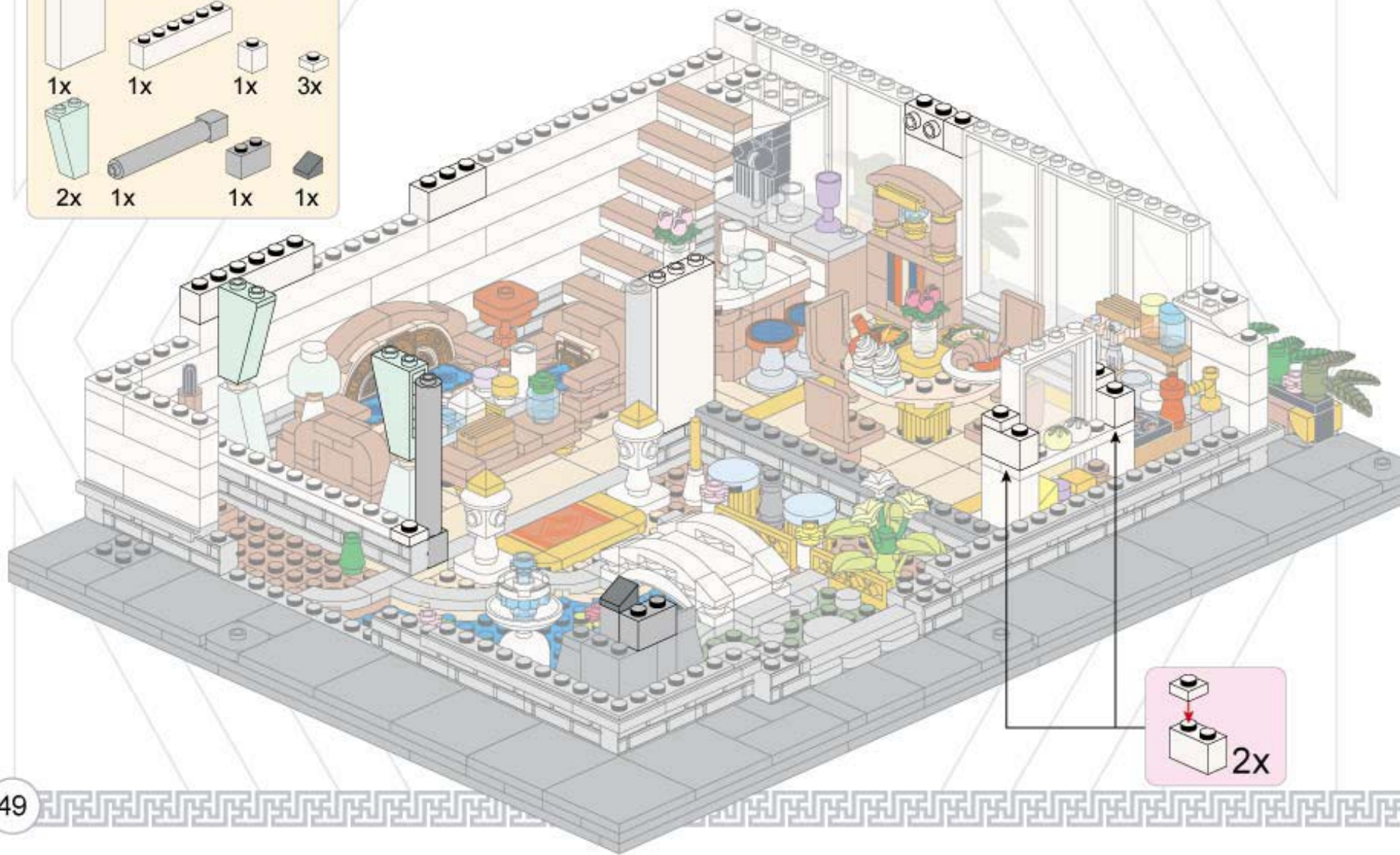
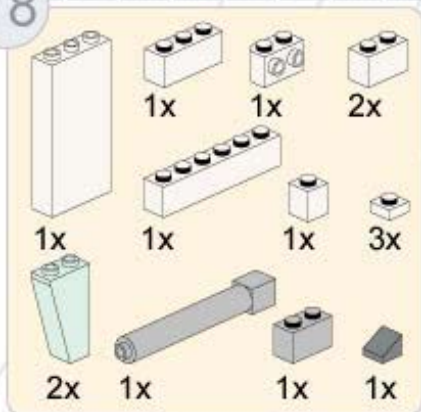

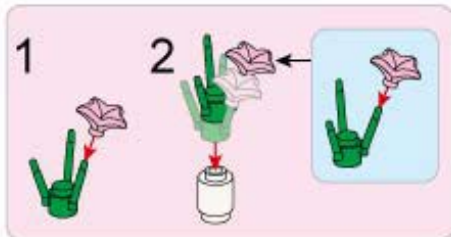



1x



1x



1x



1x



1x



4x



1x



1x



1x

③



1



③



2



81

- 3x
- 3x
- 1x
- 3x
- 1x
- 1x
- 2x
- 3x
- 1x
- 1x

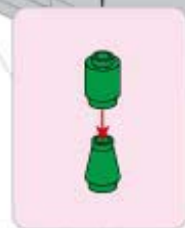
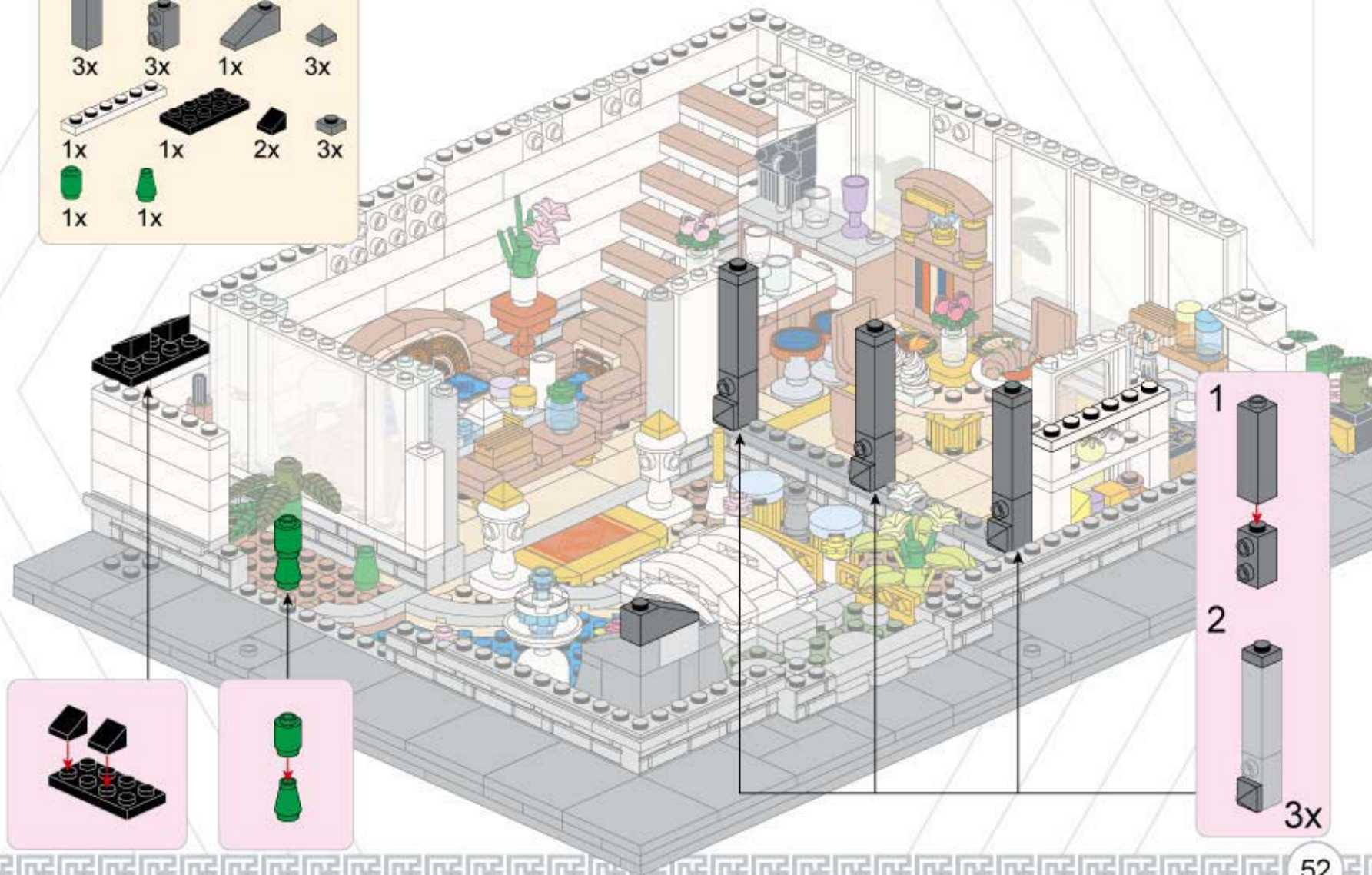

- 1
- 2
- 3x

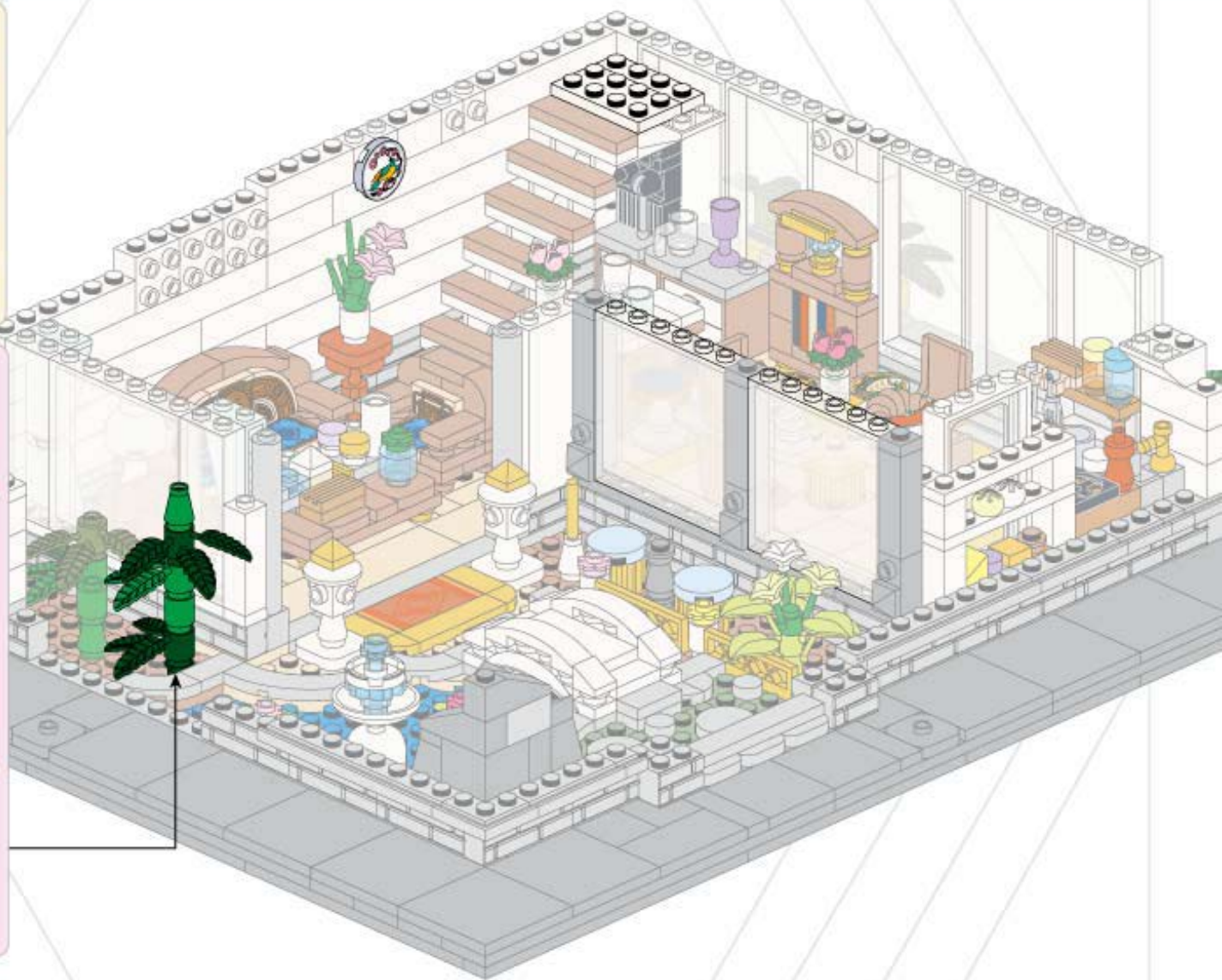
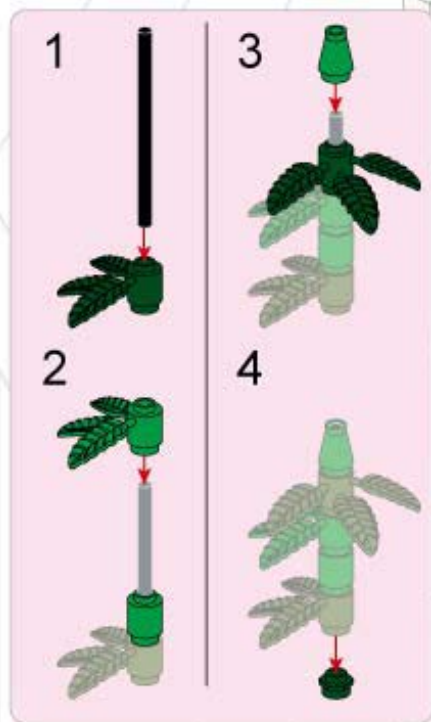

83

- 1x [1x5 white Technic brick]
- 1x [1x3 white Technic brick]
- 1x [2x2 white Technic brick]
- 1x [1x2 white Technic brick]
- 1x [brown 1x3 Technic plate]
- 1x [3x3 grey Technic plate]
- 2x [1x3 grey Technic brick]
- 1x [grey Technic brick]
- 2x [grey Technic brick]
- 1x [black 1x3 Technic brick]
- 1x [black 1x3 Technic brick]
- 4x [black Technic pin]
- 1x [green Technic bush]

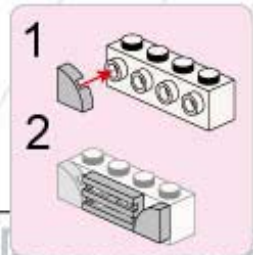
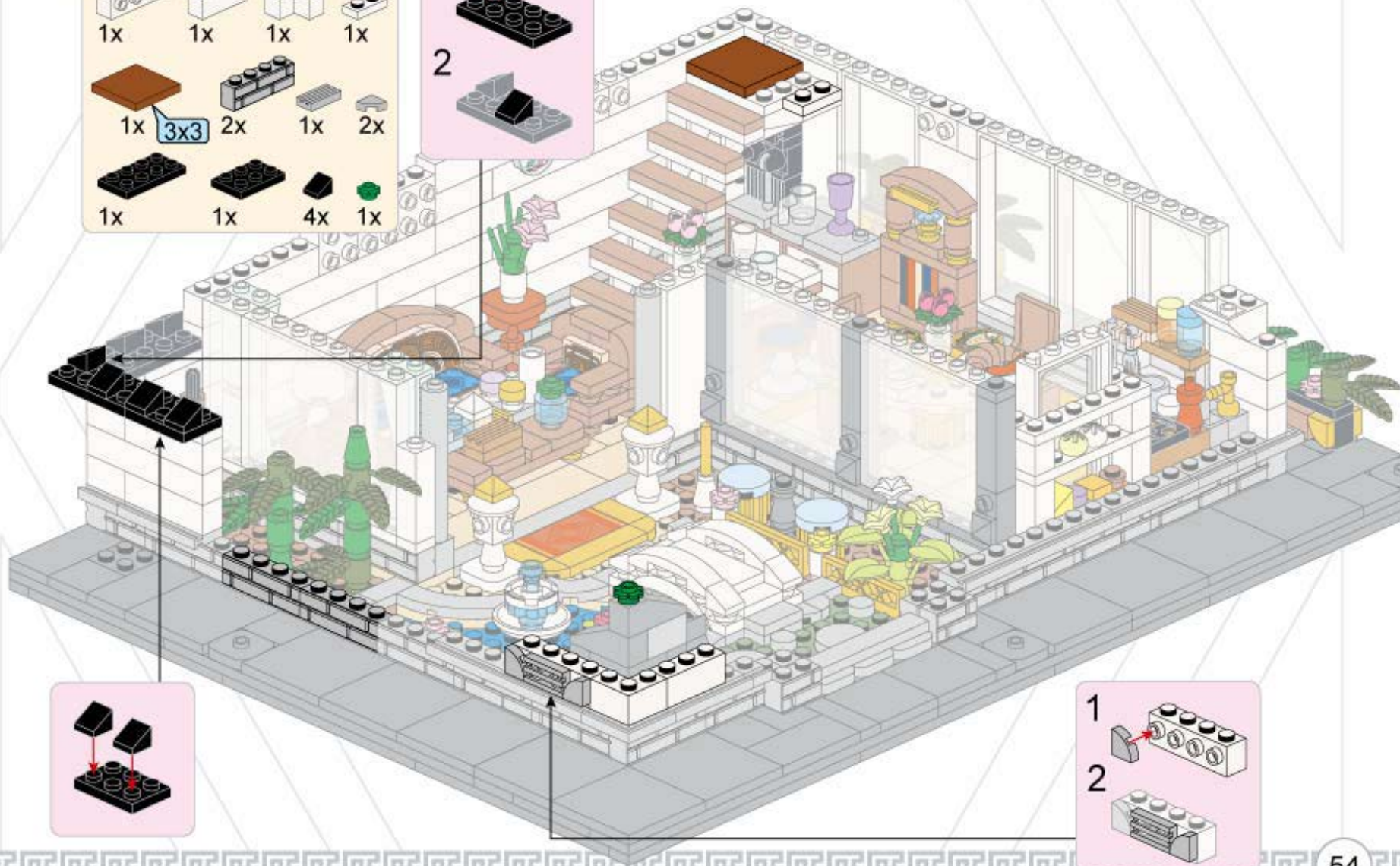
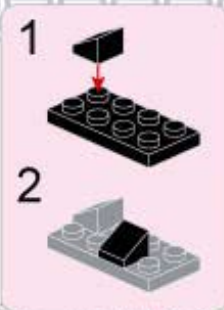

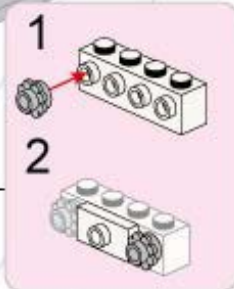
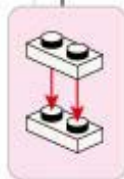
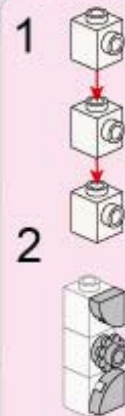
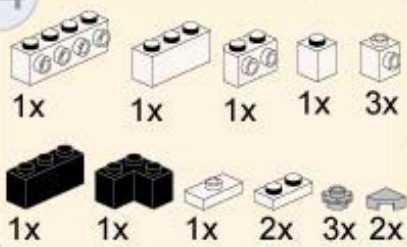

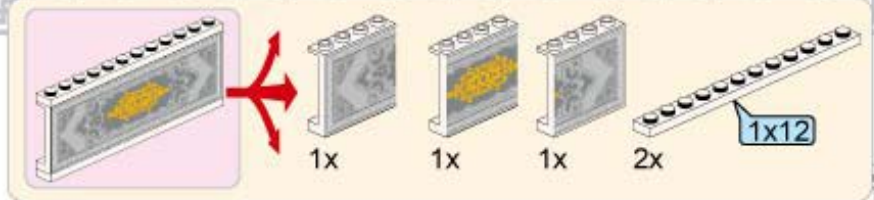

85

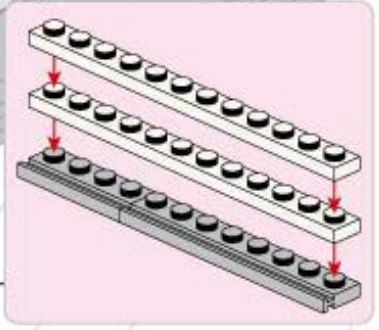
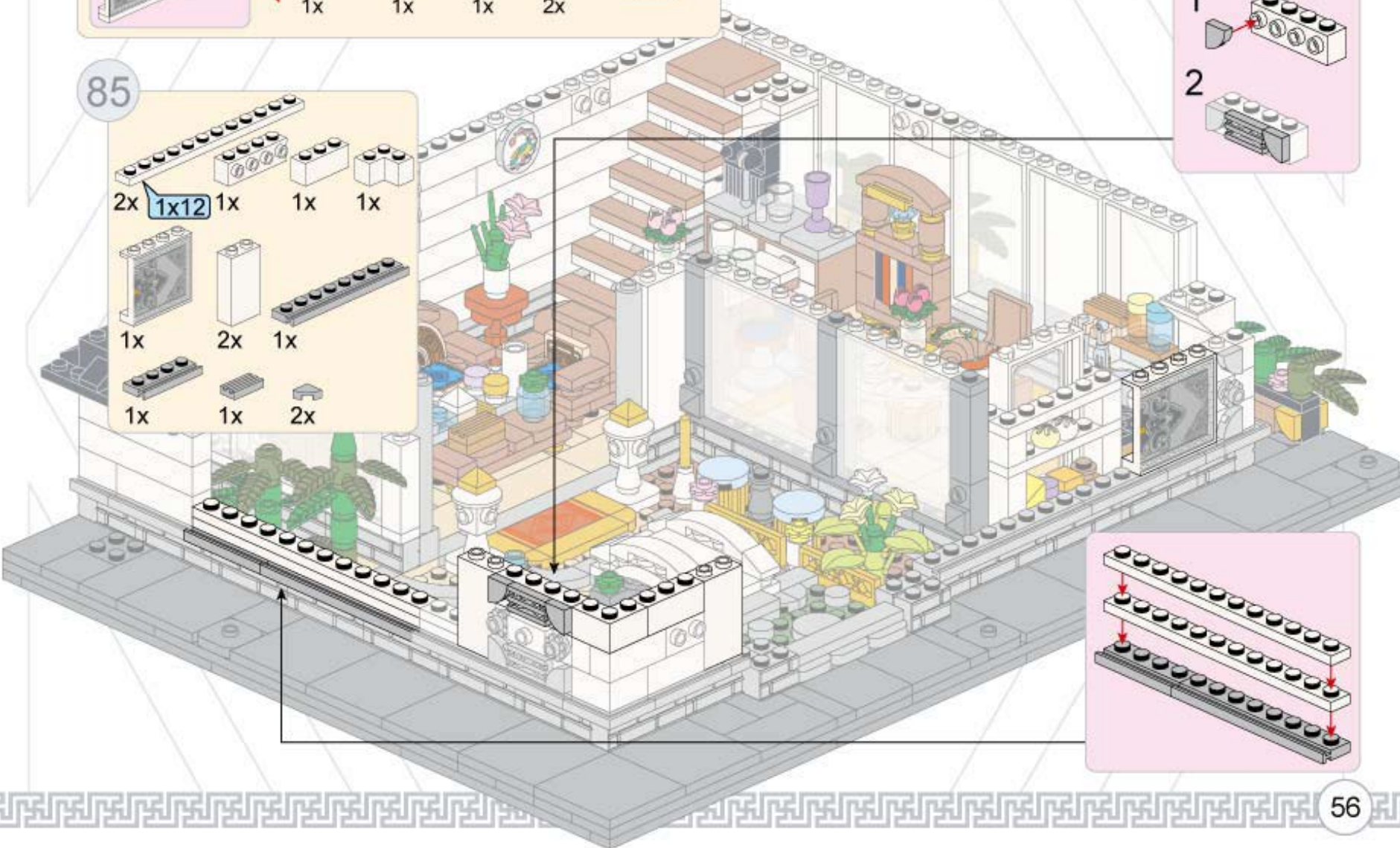
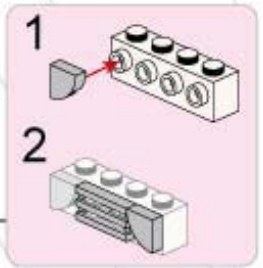
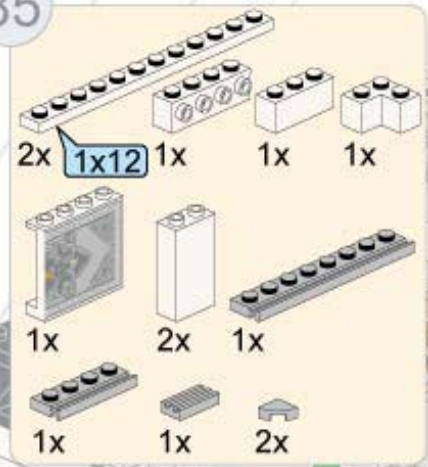



- 1x [Grey 1x4 Technic Brick with Hole]
- 2x [White 1x1 Technic Brick]
- 1x [Yellow 3-Way Connector]
- 2x [Black 1x1 Round Technic Wheel]
- 1x [Black 1x2 Technic Brick]
- 2x [Black 1x1 Technic Brick]
- 1x [Yellow 1x1 Technic Brick]
- 1x [Grey 1x2 Technic Brick with Hole]
- 1x [Grey 1x2 Technic Brick with Hole]
- 2x [Grey 1x1 Round Technic Wheel]

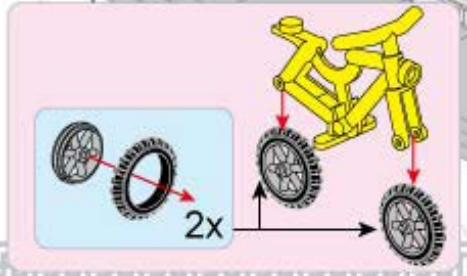
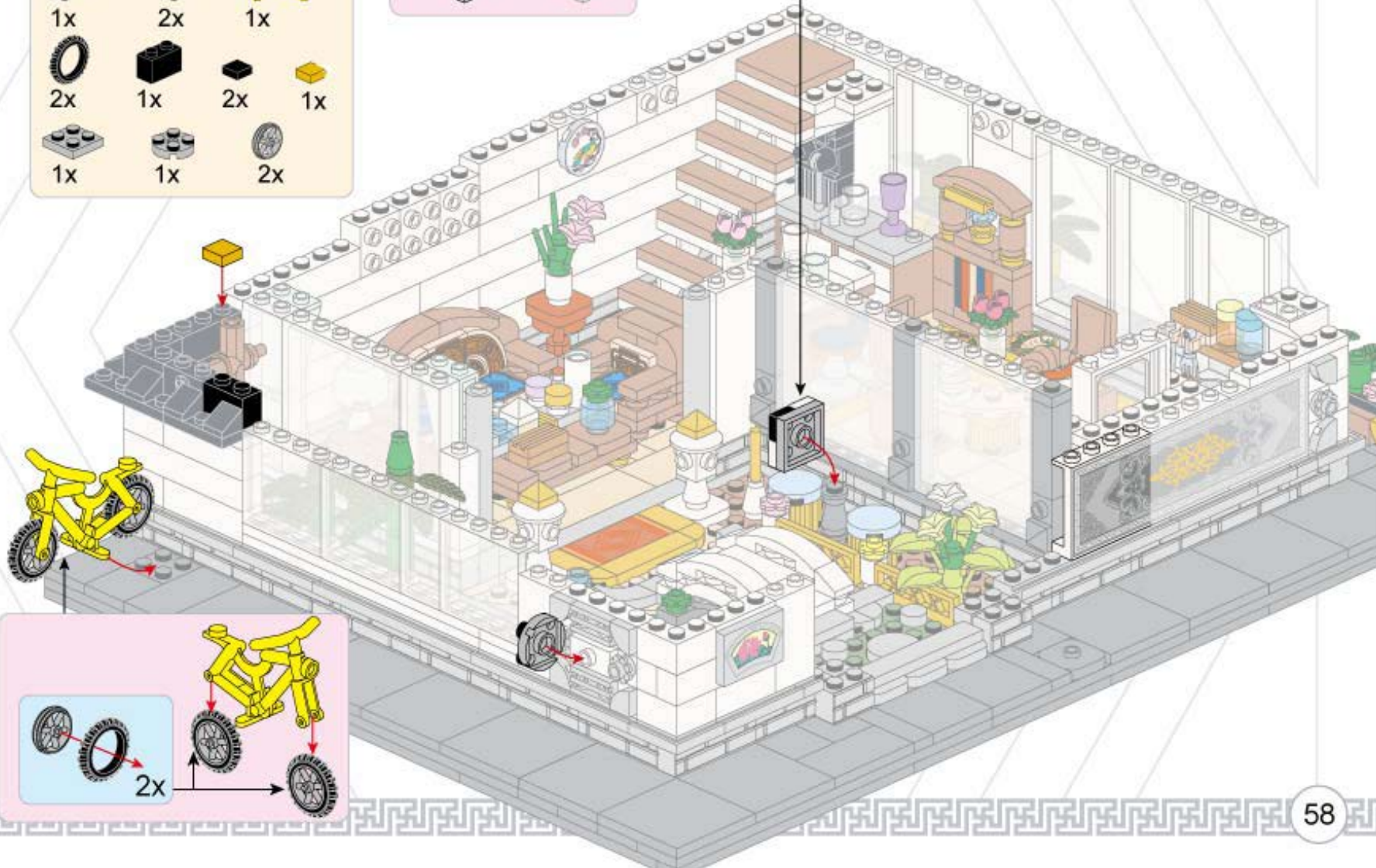
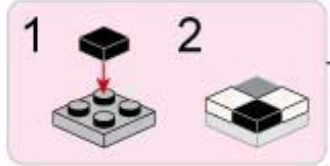

2x **1x12** 1x 1x 2x 1x 2x
 1x **1x8** 2x 2x
 1x 1x 1x 1x

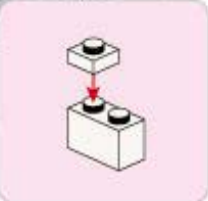
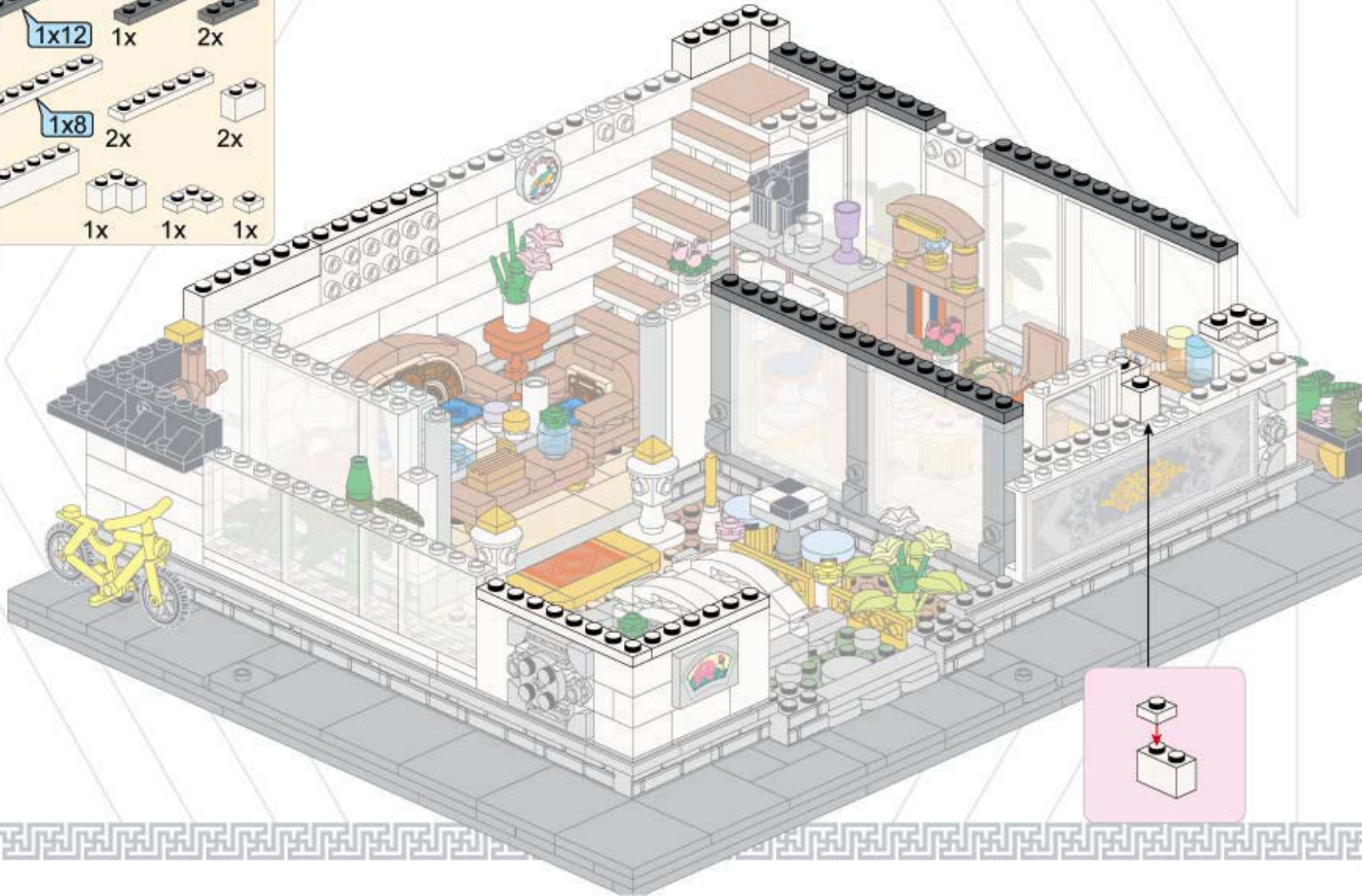

- 1x
- 1x
- 4x
- 1x
- 3x
- 2x
- 1x
- 1x
- 2x
- 1x
- 1x
- 1x
- 1x
- 1x
- 1x
- 1x
- 1x

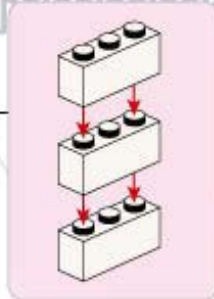

- 1
- 2
- 3

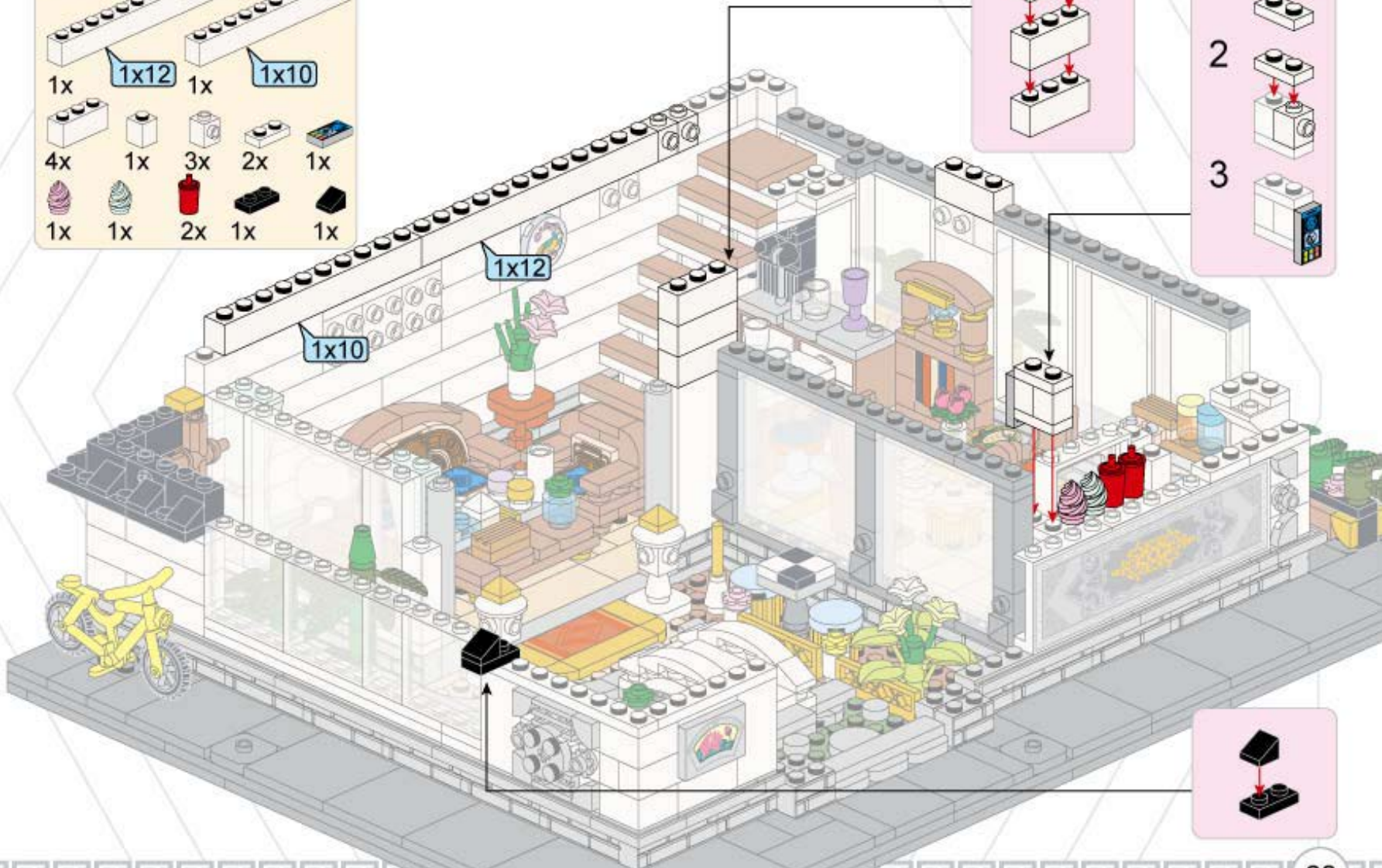

- 1x [1x8] (black 1x8 Technic brick)
- 1x [2x8] (black 2x8 Technic brick)
- 3x (black 1x1 Technic brick)
- 1x (grey 1x1 Technic brick with hole)
- 1x (grey 1x1 Technic brick with hole)
- 1x (orange 1x1 Technic brick)
- 1x (black 1x1 Technic brick)
- 1x (white 1x1 Technic brick with hole)
- 3x (grey 1x1 Technic brick)
- 9x (grey 1x1 Technic brick)

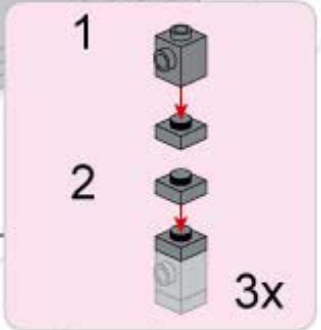
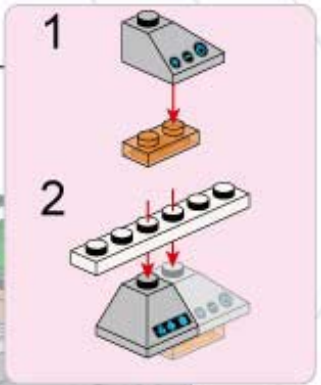
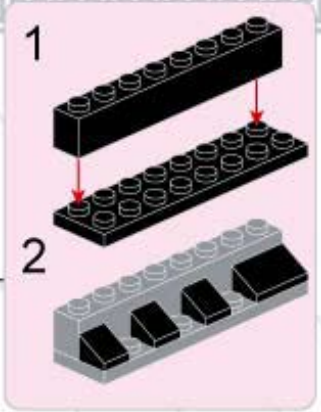

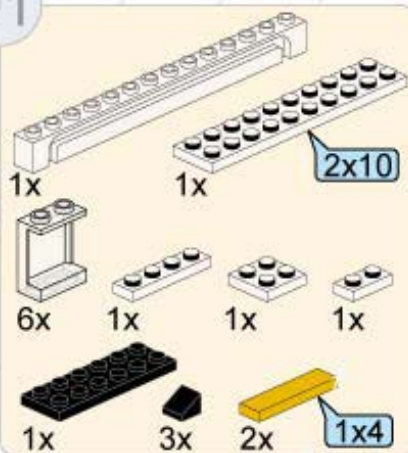

- 1x 2x12
- 1x 2x4
- 3x 1x8
- 1x 1x3
- 3x 1x3
- 1x 2x8
- 1x 2x8
- 4x 1x2

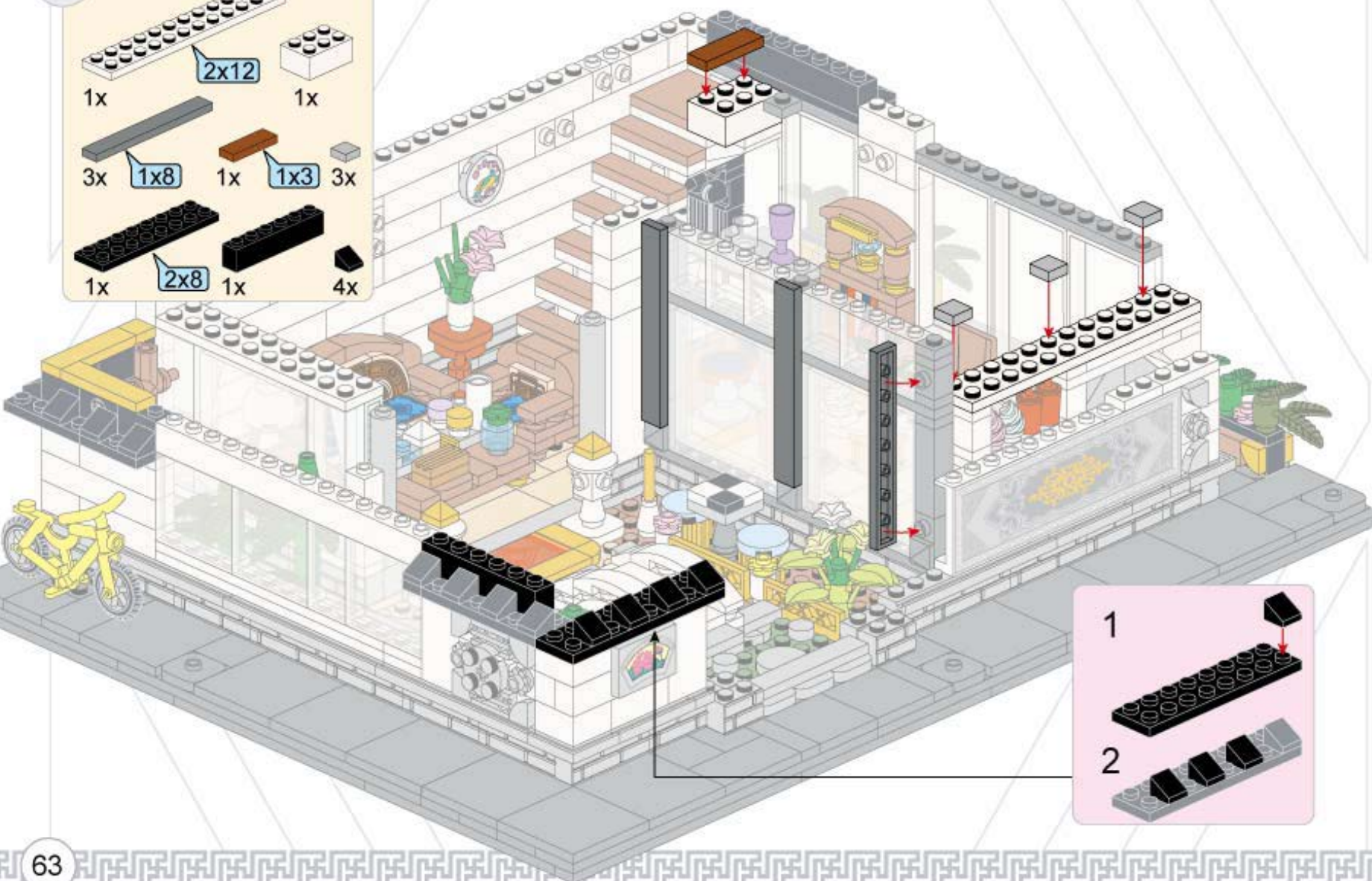

- 1
- 2

- 1x
- 8x
- 1x
- 2x
- 1x
- 1x
- 1x
- 1x
- 3x
- 1x
- 1x
- 1x
- 1x

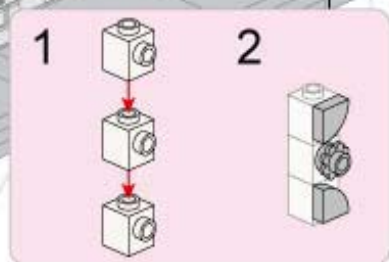
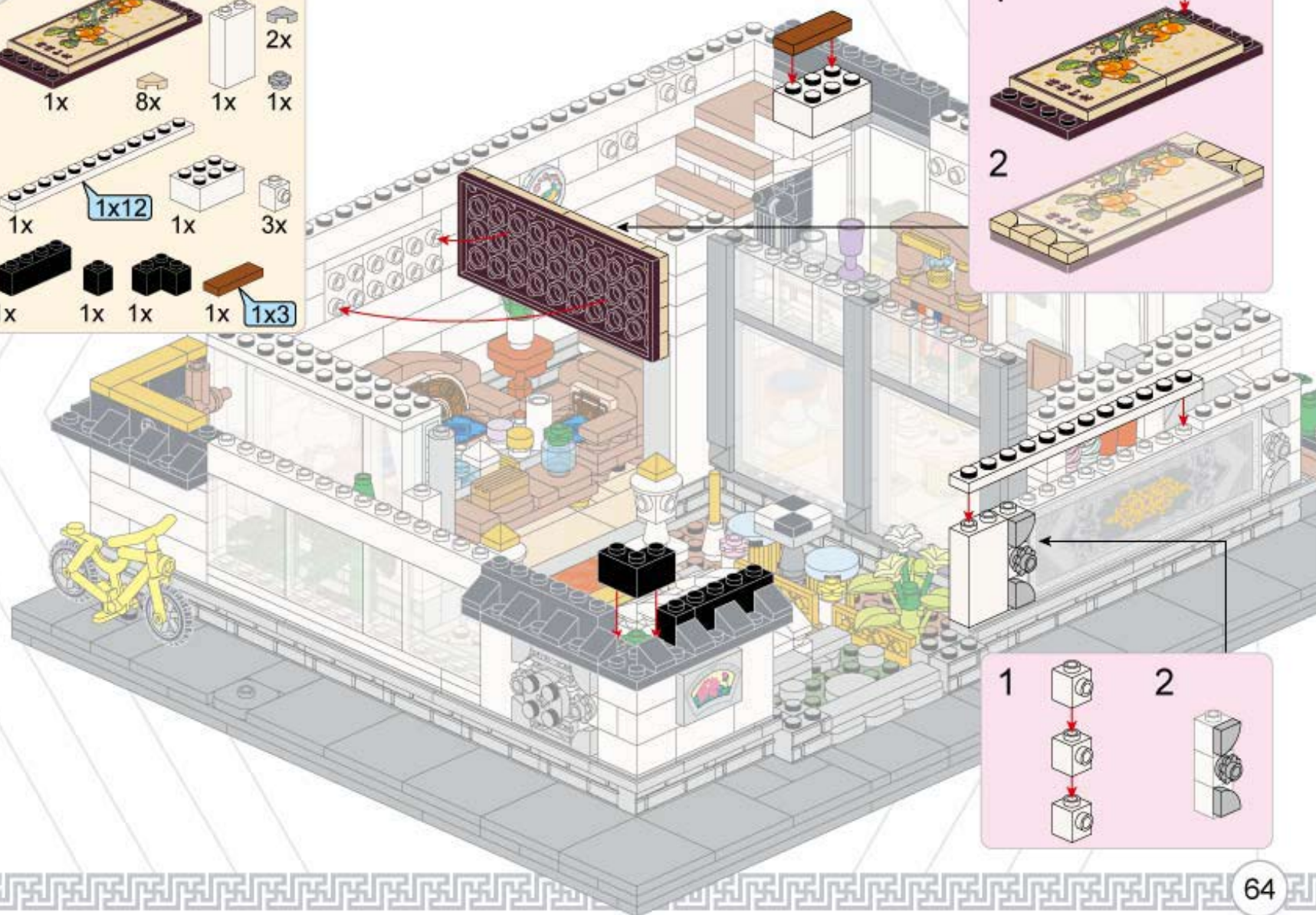
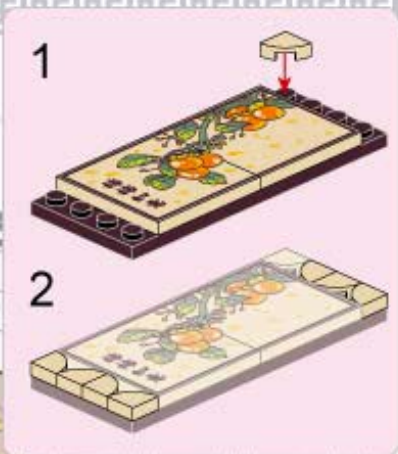

1x [1x16] 1x 1x 1x 10x

1x [2x16] 1x 1x 1x

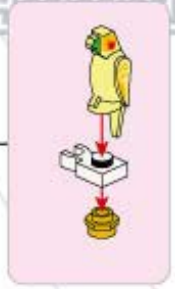

1

2

3

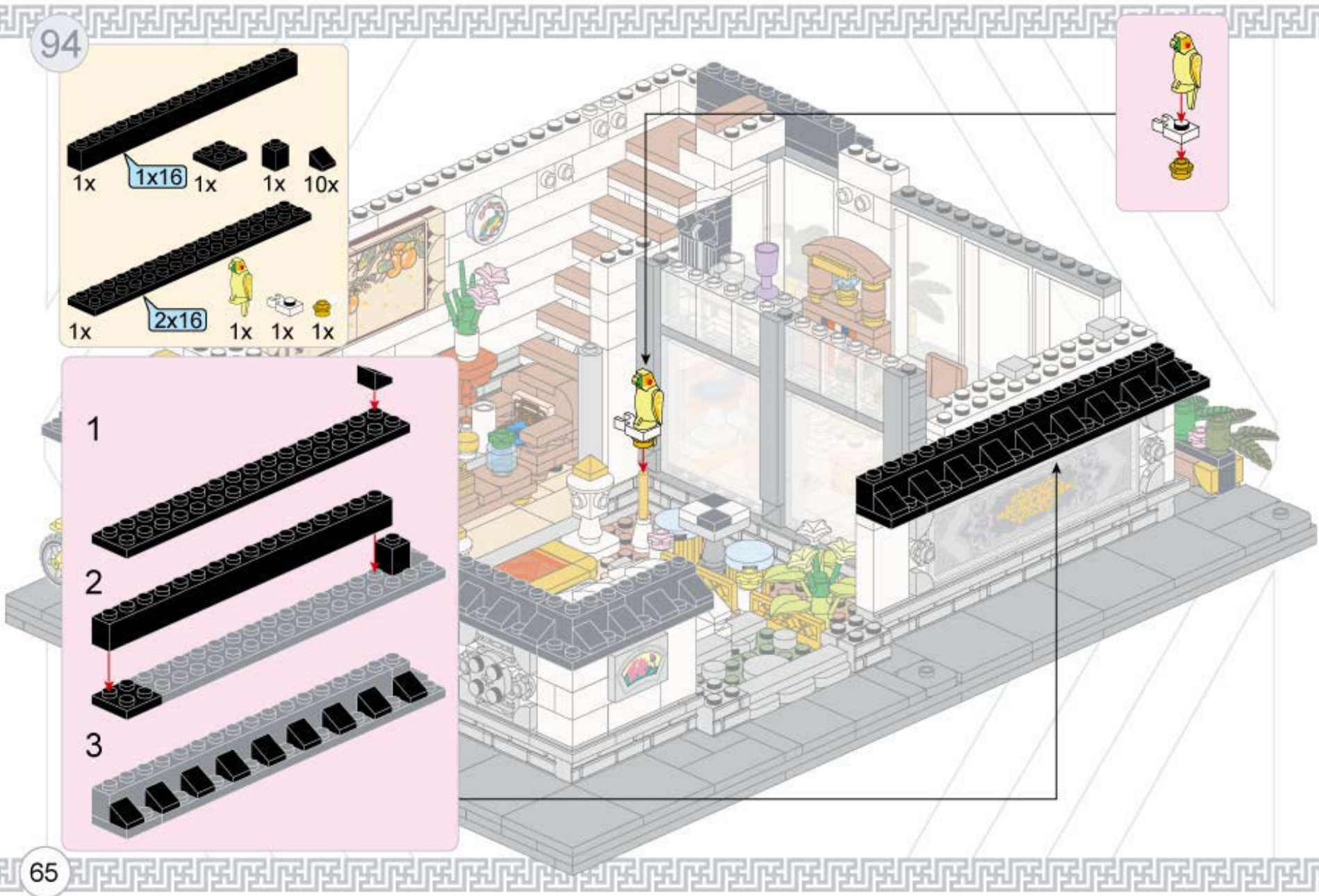

95



1x



4x



8x



2x



1x



1



2



3



2x

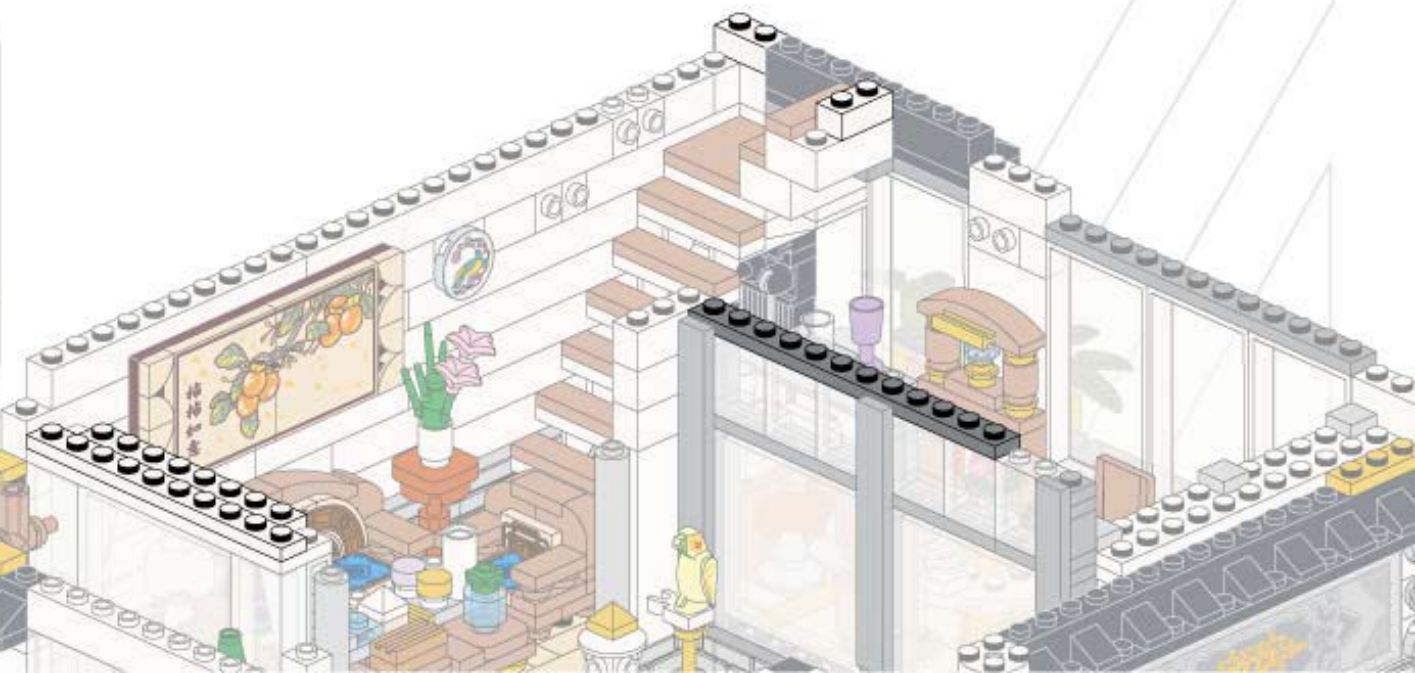
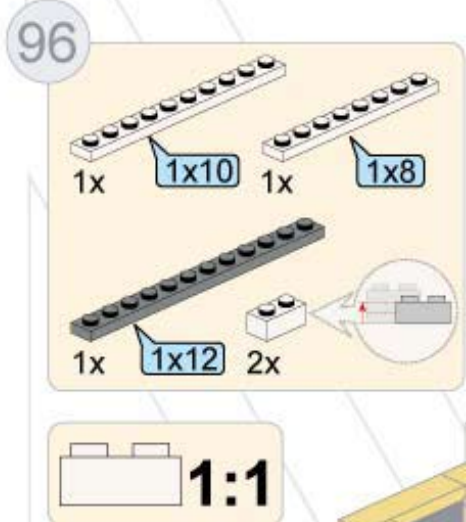
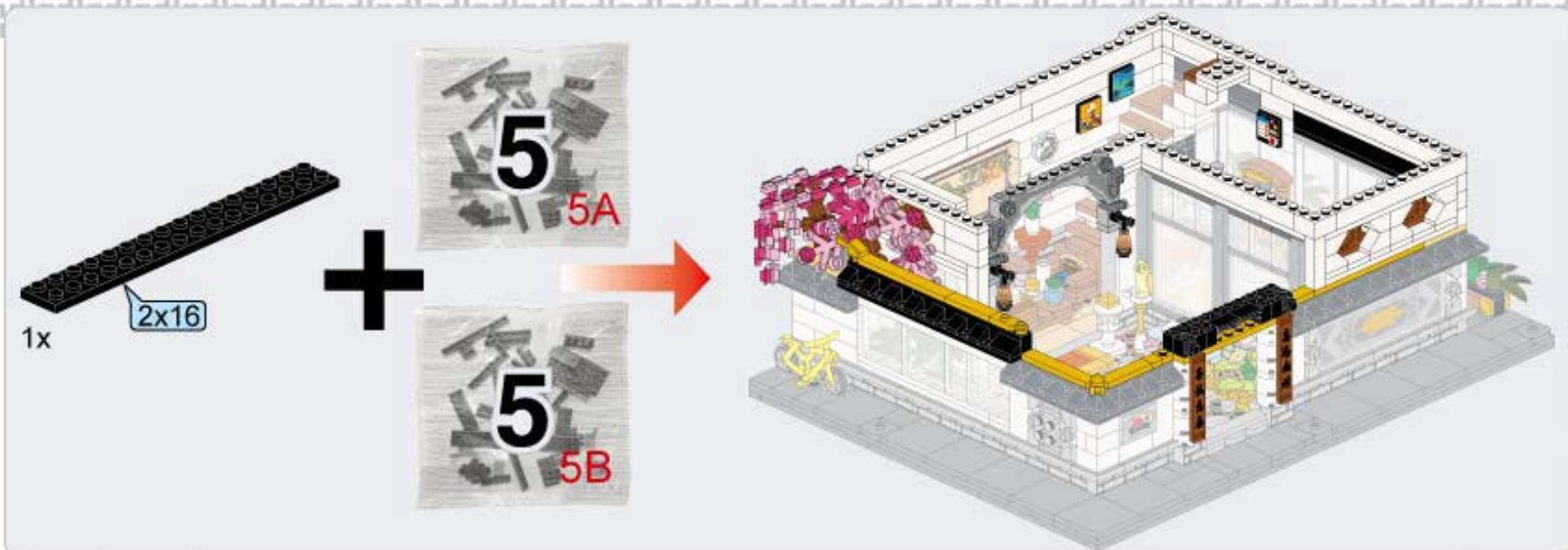

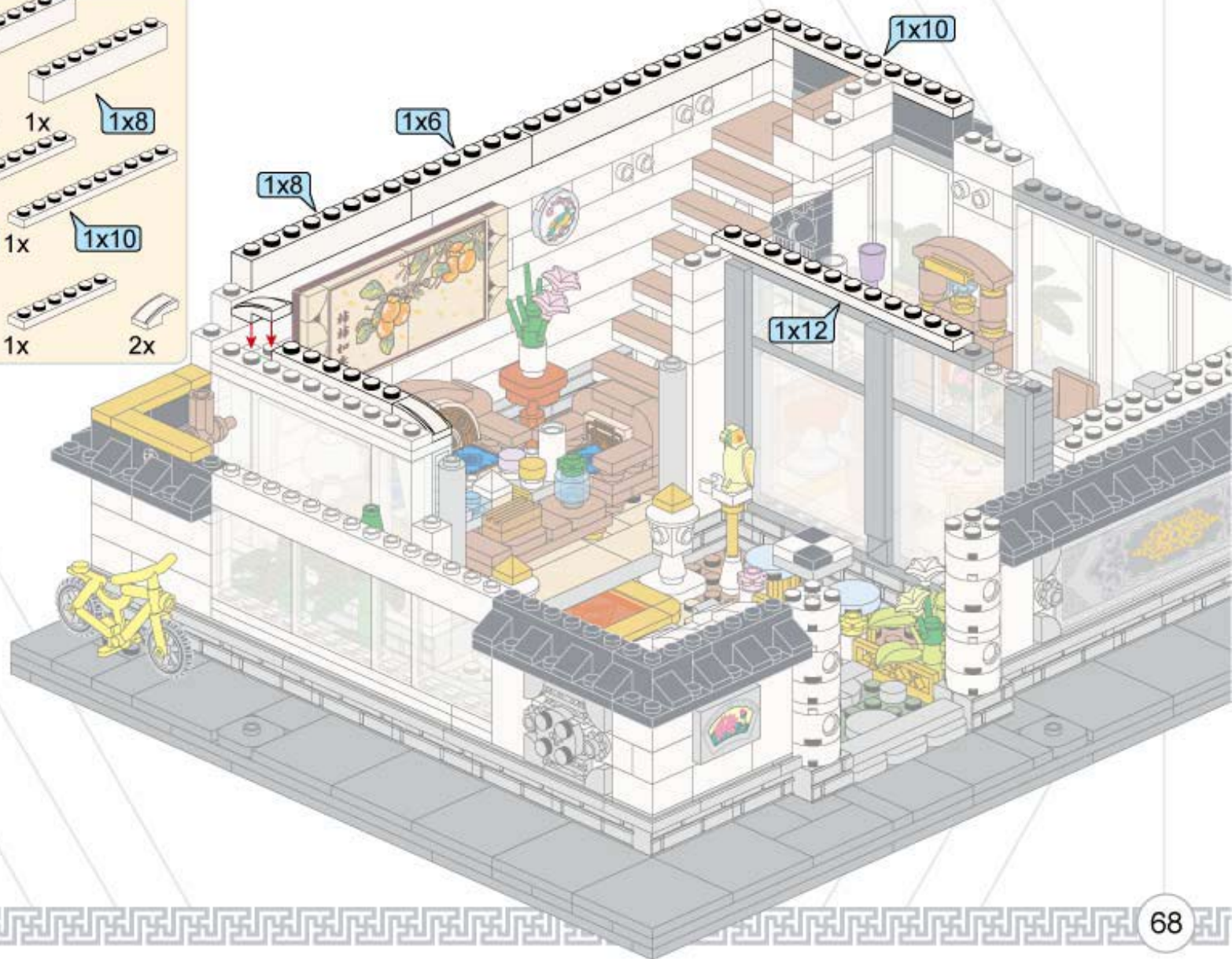
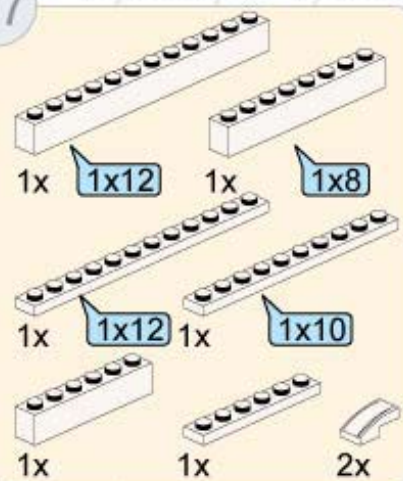

- 1x
- 1x
- 1x
- 1x
- 1x
- 2x
- 2x
- 2x
- 4x
- 2x
- 1x

2x



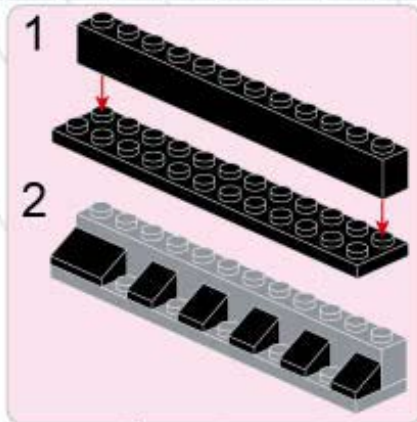
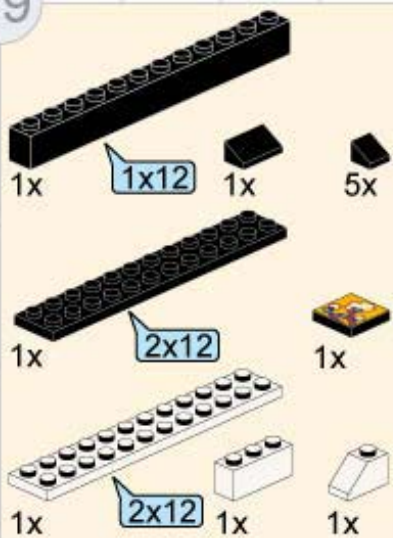

- 1x
- 1x
- 1x
- 1x
- 1x
- 1x
- 1x
- 2x
- 1x
- 1x
- 1x
- 2x
- 2x



2x

101

- 2x
- 1x
- 1x
- 4x
- 1x
- 1x
- 1x
- 135°
- 1x
- 1x
- 1x

1

2

3

1

2

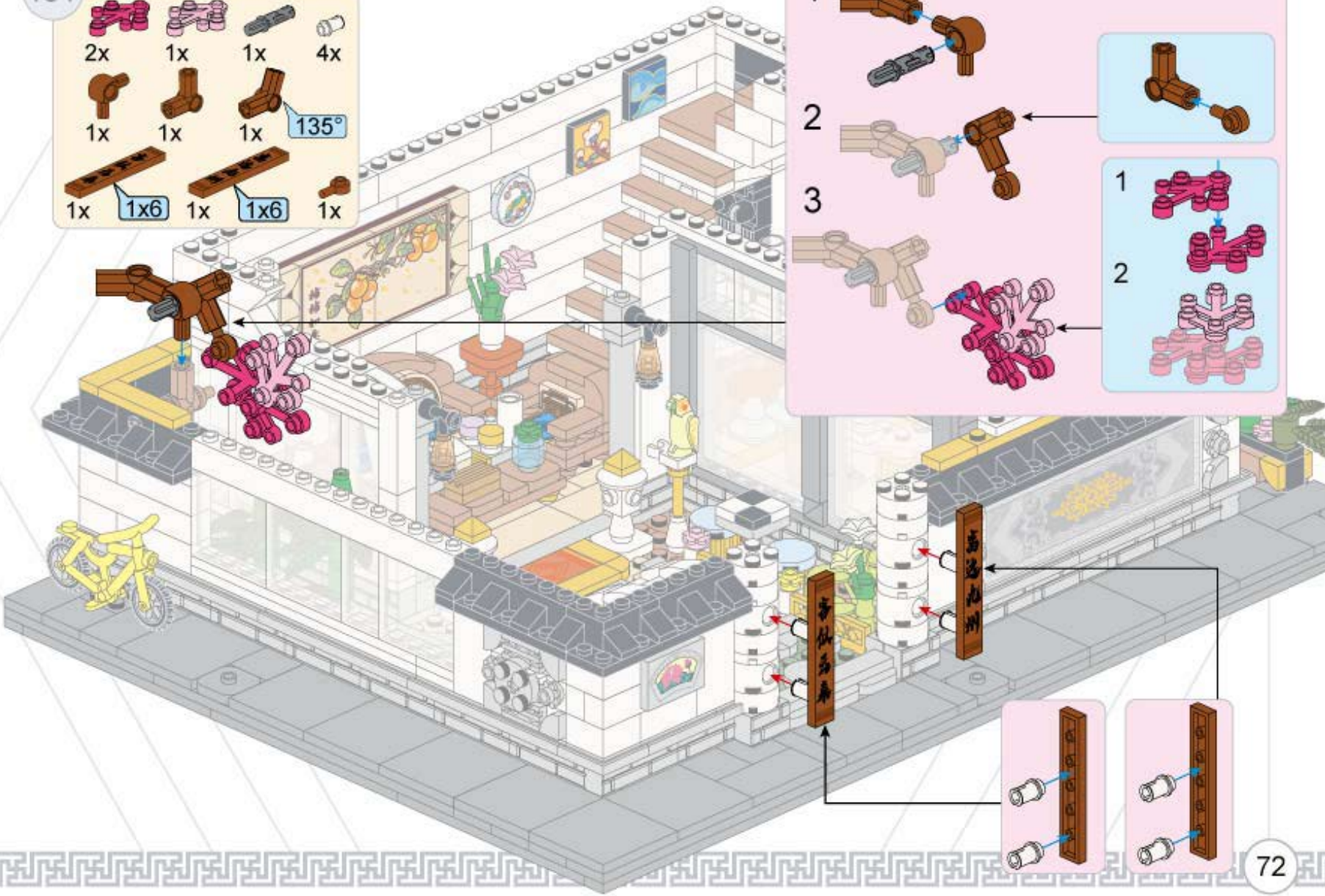

72

- 5x
- 2x
- 6x
- 1x
- 2x
- 1x
- 1x



1

2

3

4

1

2











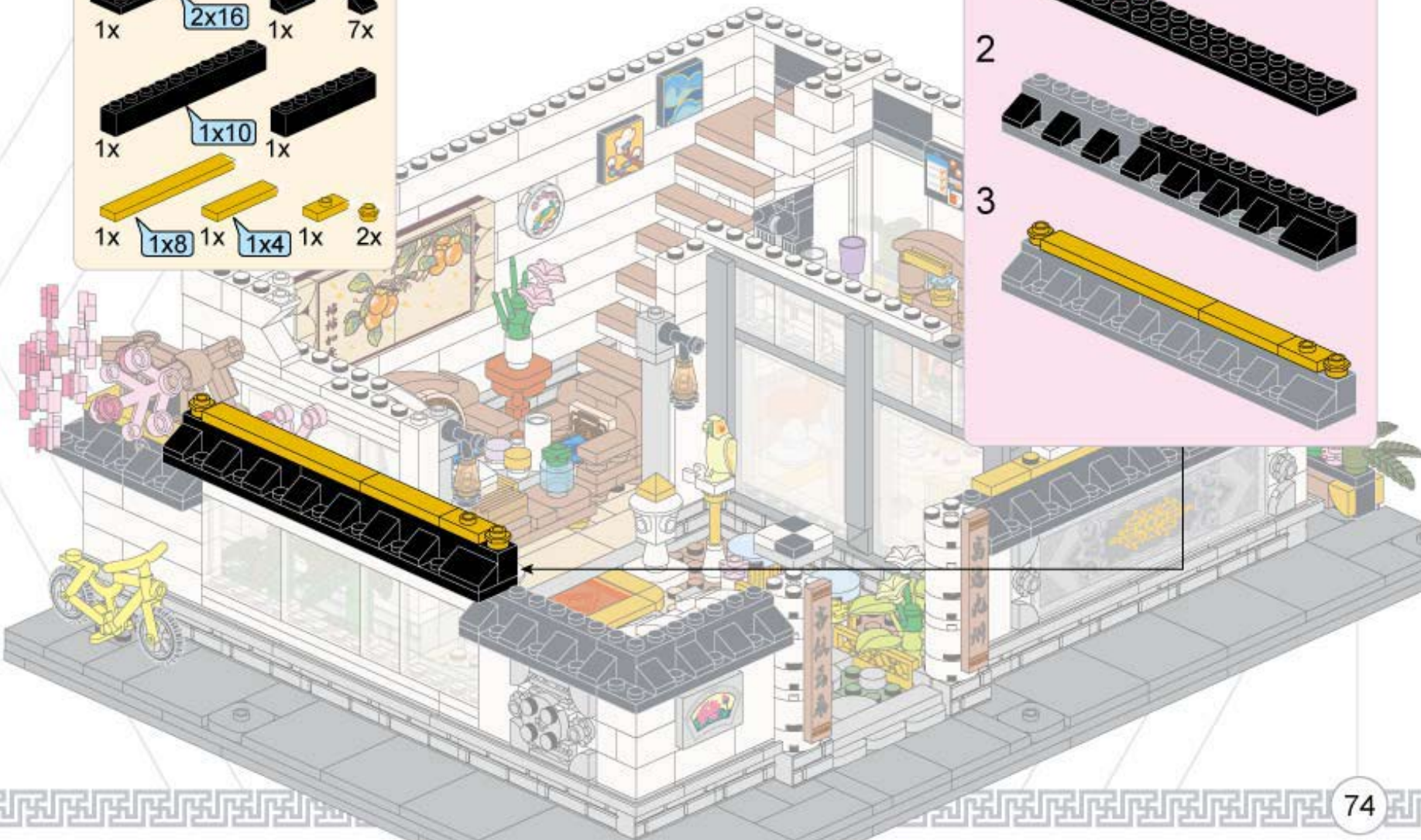
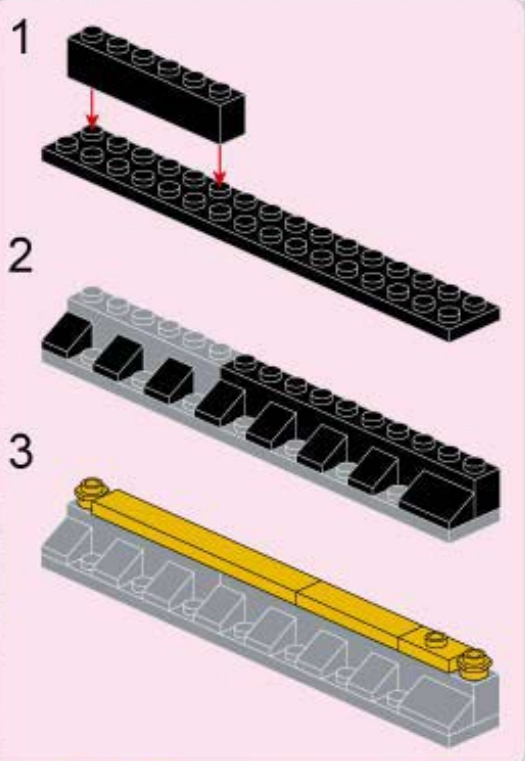

1

2

3

- 1x 2x16
- 1x 1x
- 7x 1x
- 1x 1x10
- 1x 1x
- 1x 1x8
- 1x 1x4
- 1x 1x
- 2x 2x



- 1x  2x  5x  2x  1x 
- 1x  1x  1x  1x 

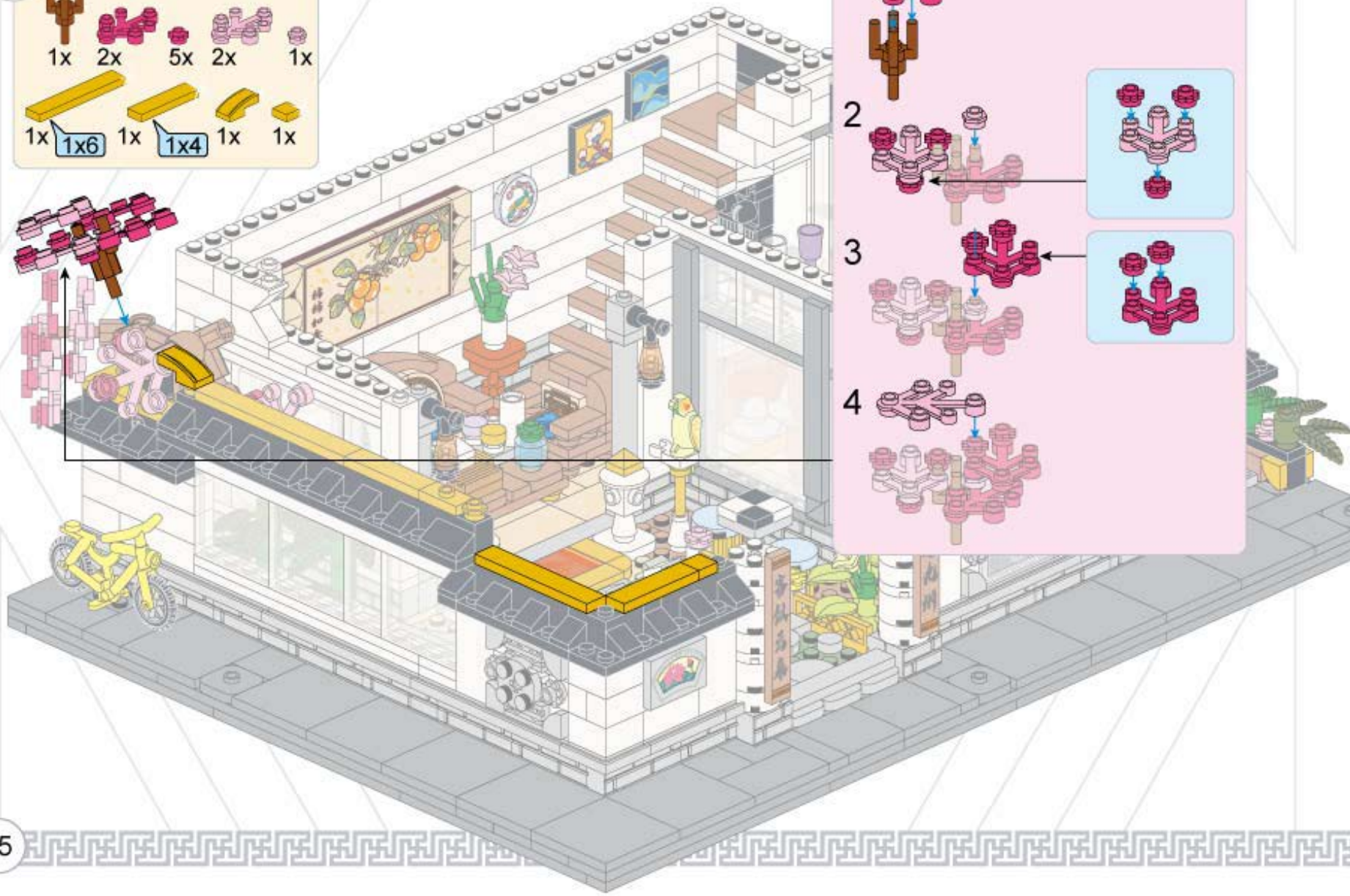
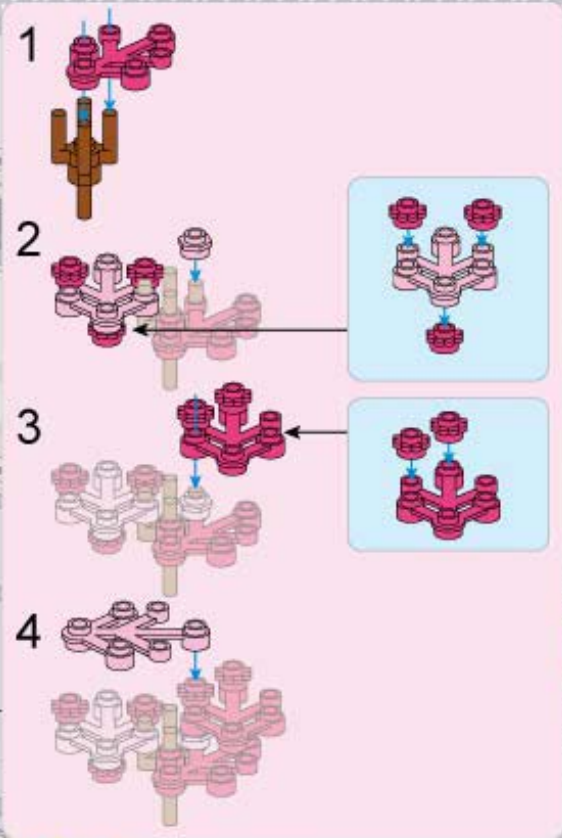
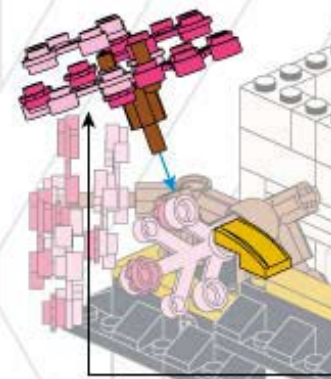

105

- 1x
- 1x
- 4x
- 1x
- 1x
- 6x
- 1x
- 1x
- 1x

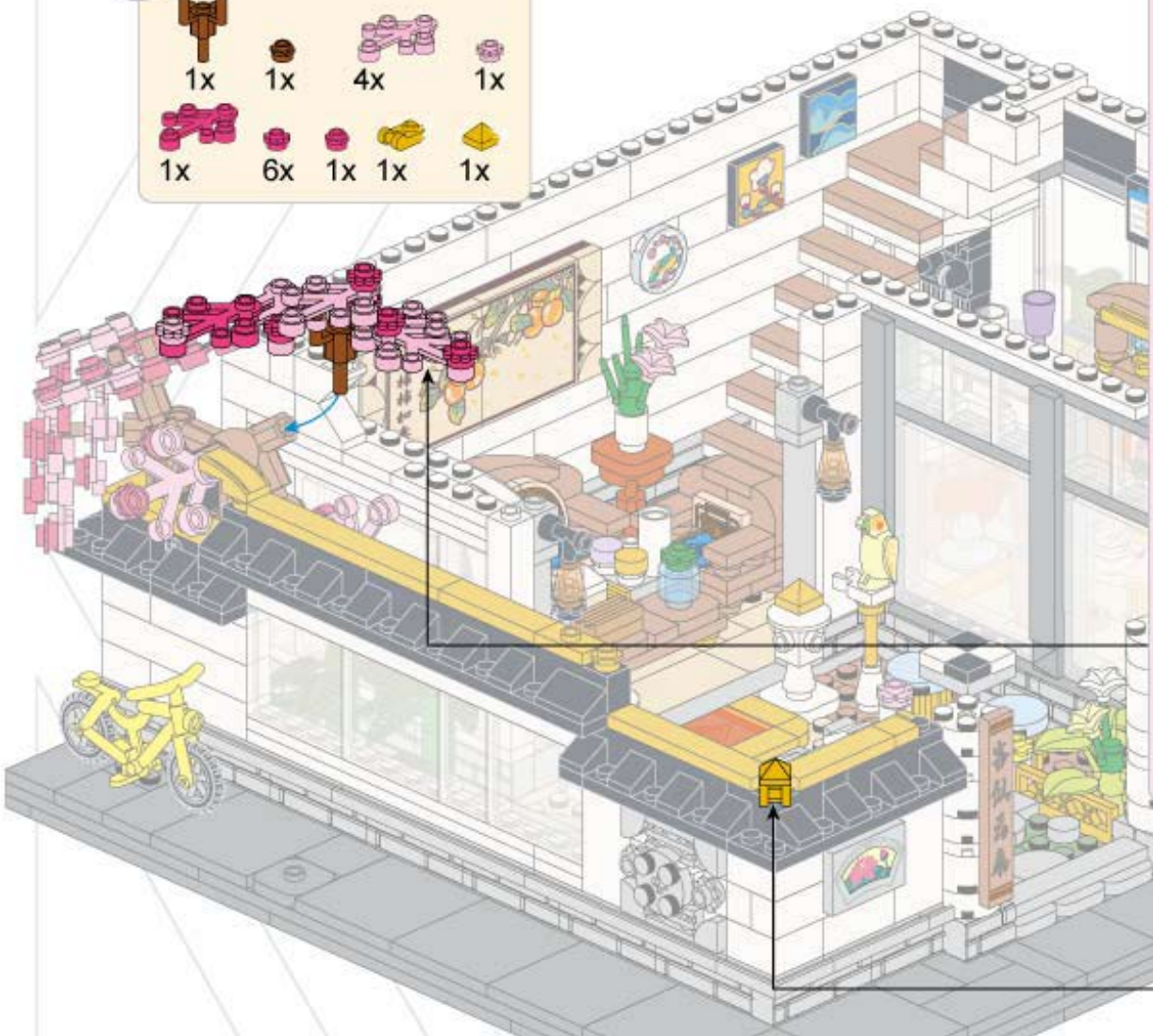

-
-
-
-
-

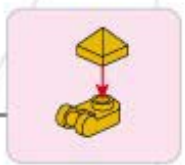

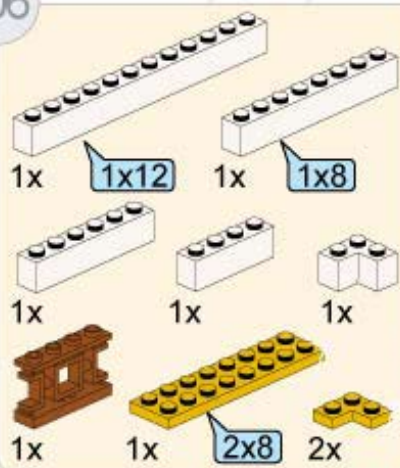

107

- 1x [Black 1x4 Technic Brick]
- 2x [Black 2x2 Technic Brick]
- 2x [Black 2x2 Technic Brick]
- 2x [Grey 1x2 Technic Brick]
- 1x [White 1x4 Technic Brick]
- 2x [White 1x2 Technic Brick]
- 2x [White 1x4 Technic Brick]
- 2x [White 1x2 Technic Brick]

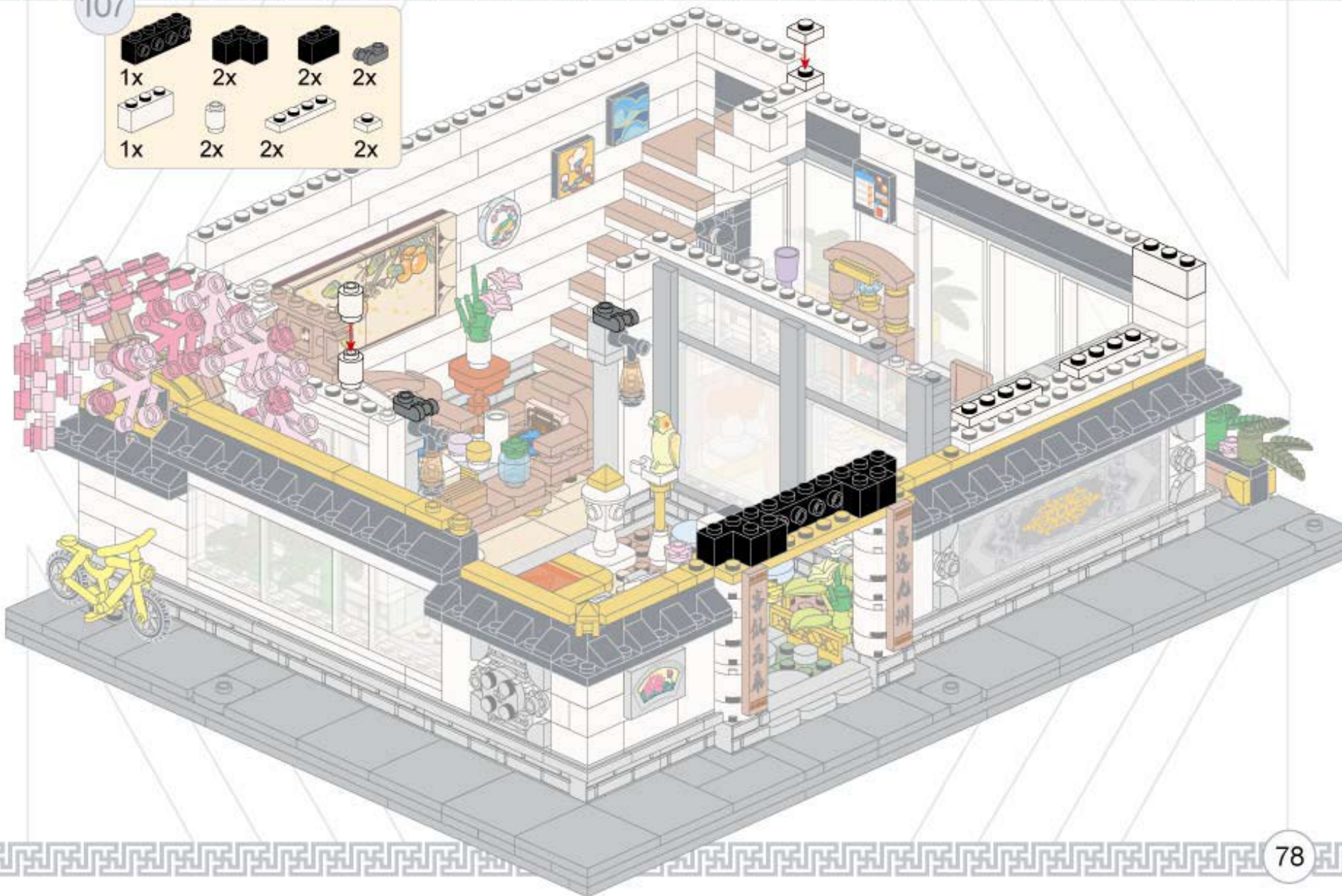

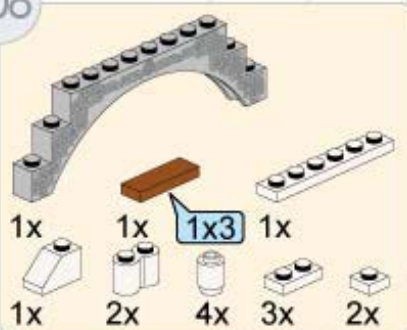

Parts list for step 108:

- 1x Grey arch
- 1x Brown 1x3 Technic brick
- 1x White 1x3 Technic brick
- 1x White 1x1 Technic brick with hole
- 1x White 1x1 Technic brick with hole
- 2x White 1x1 Technic brick with hole
- 4x White 1x1 Technic brick with hole
- 3x White 1x1 Technic brick with hole
- 2x White 1x1 Technic brick with hole

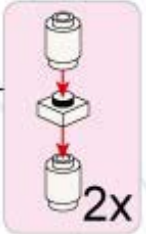

Assembly diagram for step 108:

2x



Assembly diagram for step 79:

1x White 1x1 Technic brick with hole

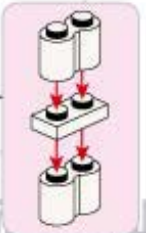

Assembly diagram for step 79:

2x

- 2x [Brown 1x3 Technic Beam]
- 2x [Grey 1x2 Technic Brick]
- 2x [Black 1x2 Technic Brick]
- 2x [Black 1x2 Technic Pin]
- 1x [White 1x6 Technic Beam]
- 2x [White 1x2 Technic Brick]
- 1x [White 1x2 Technic Brick]
- 1x [White 1x2 Technic Brick]
- 4x [Black 1x2 Technic Pin]
- 2x [White 1x2 Technic Brick]
- 2x [Black 1x2 Technic Pin]

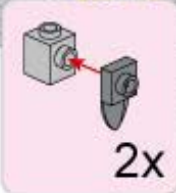

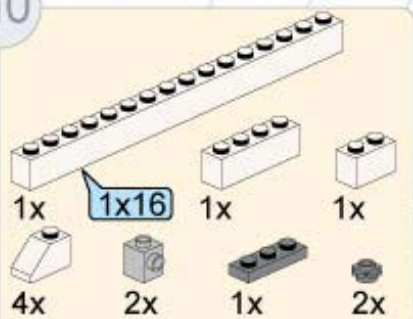

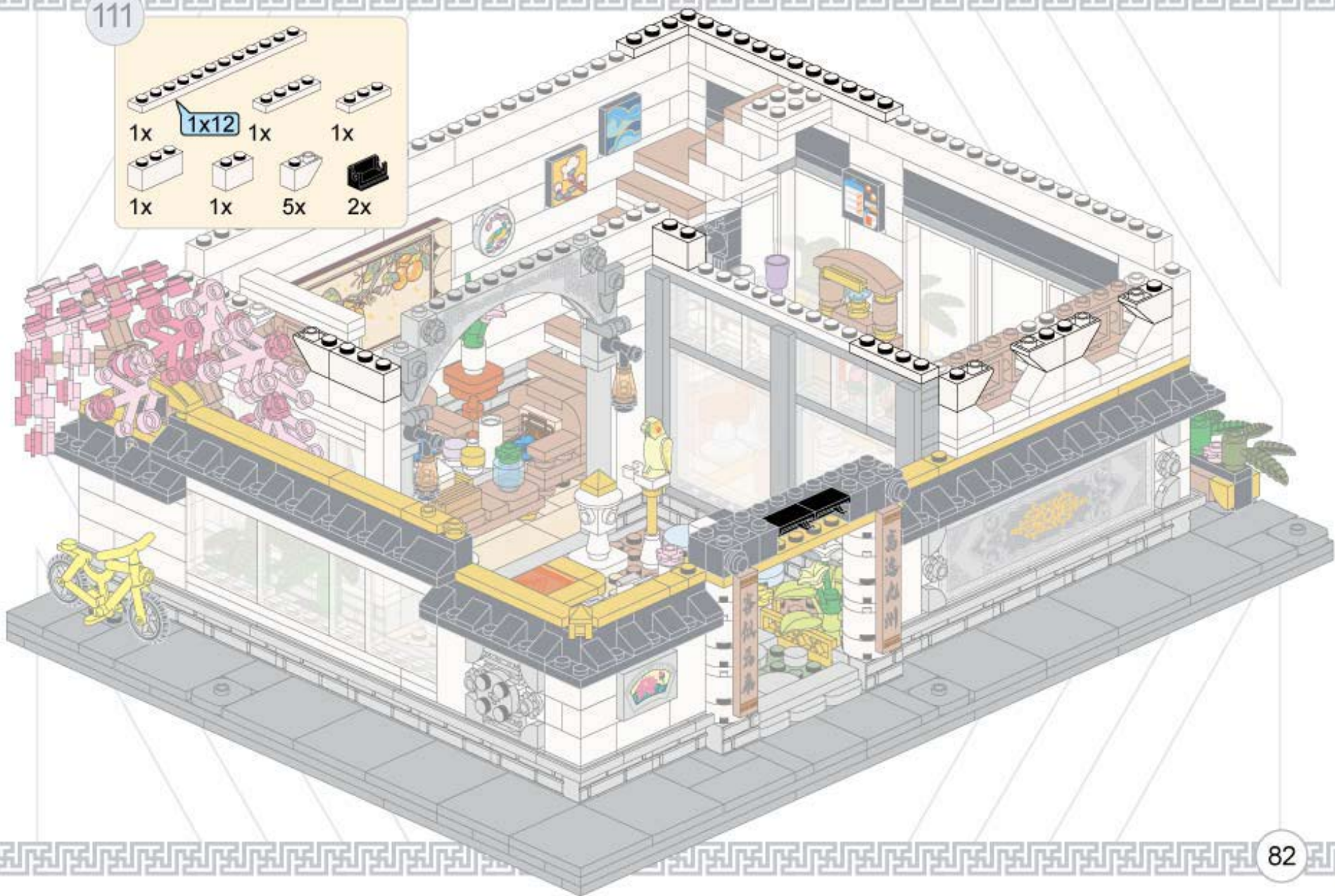
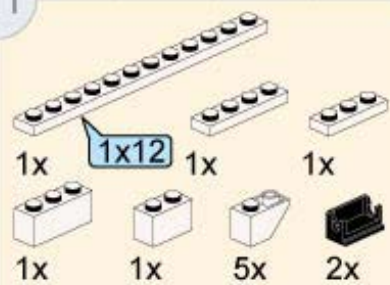

1x 1x12 1x 1x8
1x 1x 2x12 1x 1x4

1
2



113

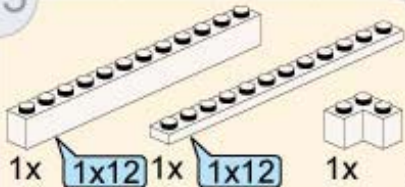

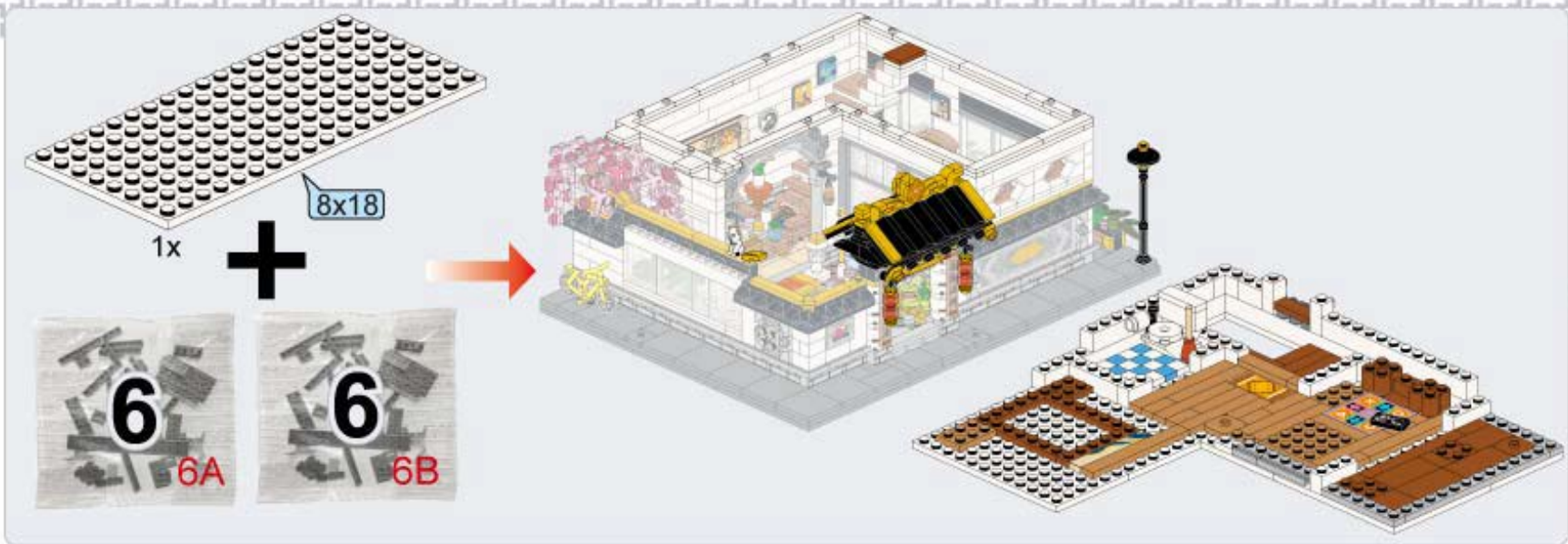

- 1x [Black 1x8 Technic Brick]
- 2x8 [Black 2x8 Technic Brick]
- 1x [Black 1x2 Technic Brick]
- 2x [Black Technic Pin]
- 1x [White 1x12 Technic Brick]
- 1x [White 1x4 Technic Brick]
- 2x [White 1x2 Technic Brick]
- 2x [White 1x2 Technic Brick]
- 4x [Red Technic Pin]
- 4x [Yellow Technic Pin]



- 1 [Red Technic Pin]
 - 2 [Black Technic Pin]
- 2x [Red Technic Pin]

- 5x 1x8
- 5x 1x3
- 1x 1x8
- 1x 1x3
- 1x 1x1
- 3x 1x1
- 2x 1x2
- 1x 1x2
- 1x 1x2

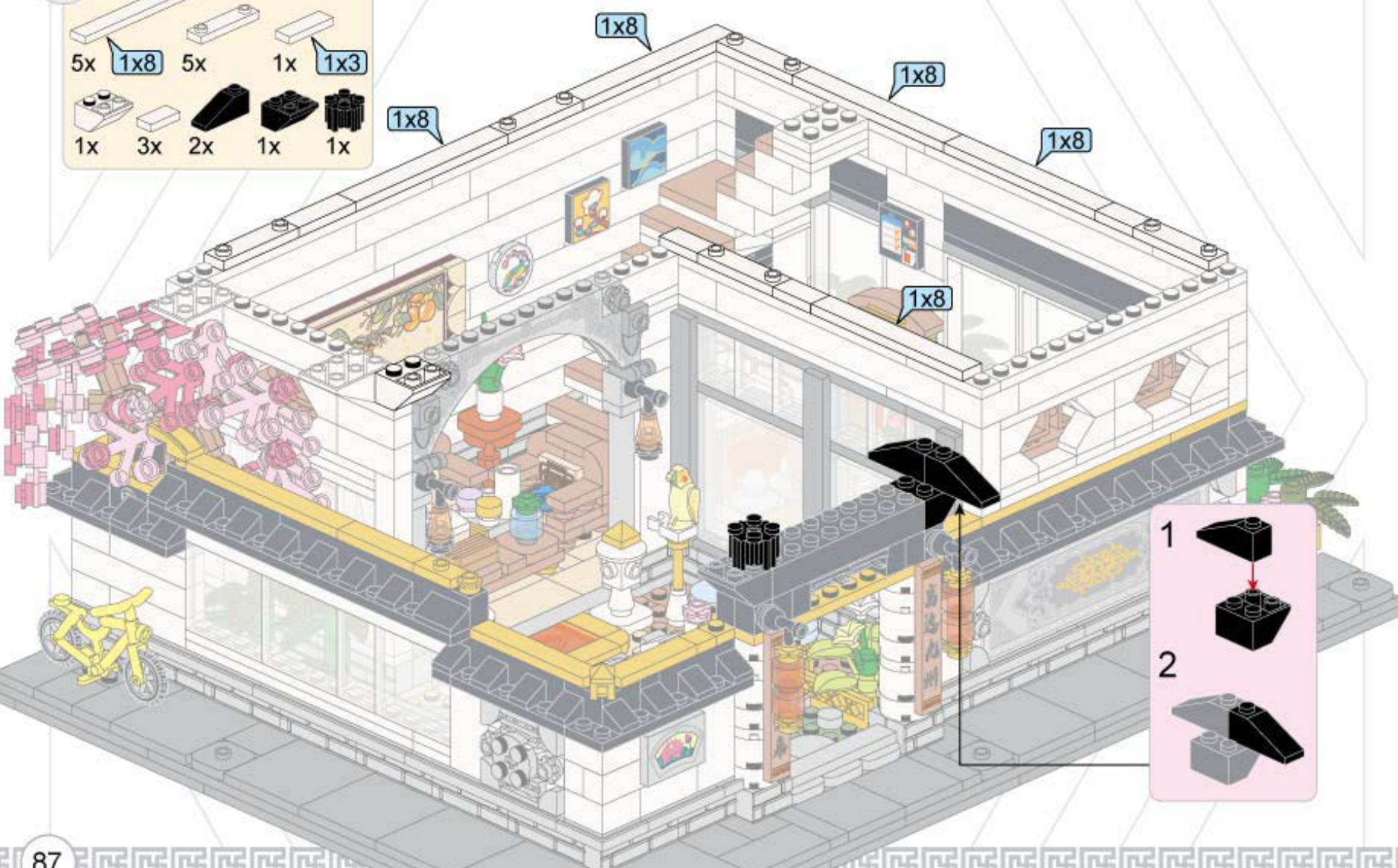

- 1
- 2

- 1x
- 2x6
- 1x
- 2x
- 2x
- 2x
- 1x8
- 2x
- 1x6
- 2x
- 2x
- 1x
- 2x
- 2x



- 1
- 2
- 3

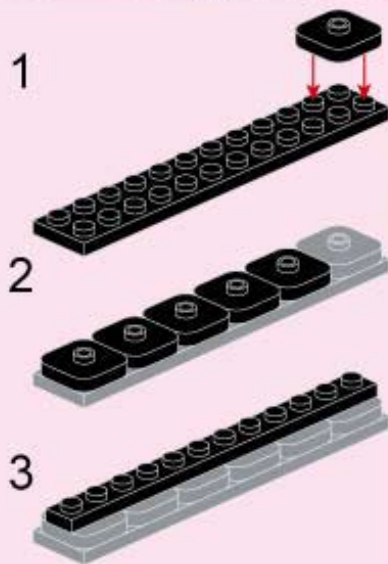
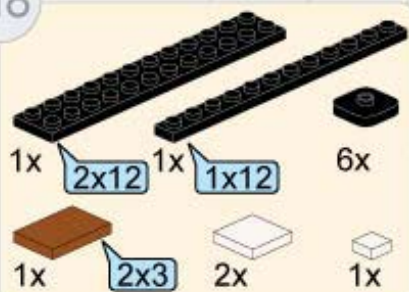

119

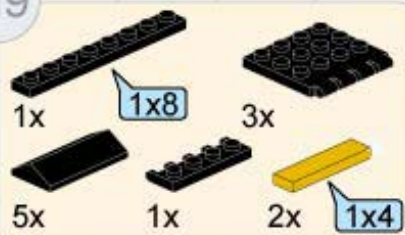

1



2

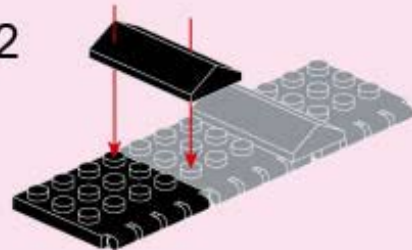

3

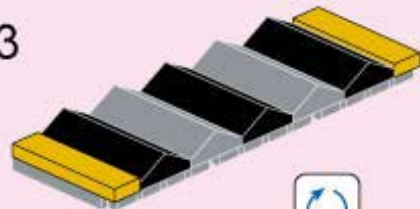

4

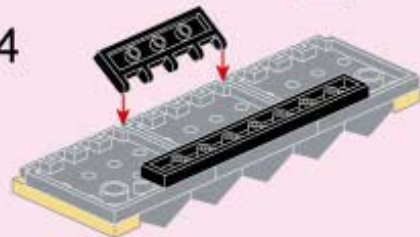

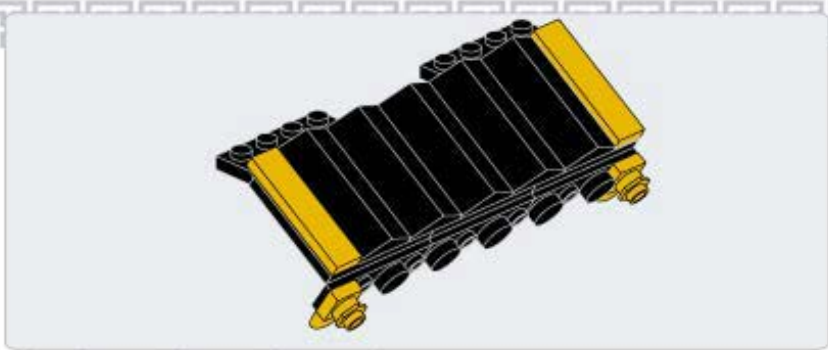

120

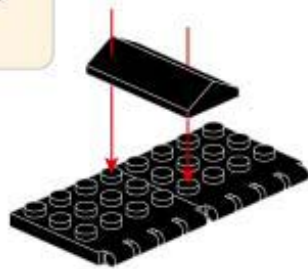

121

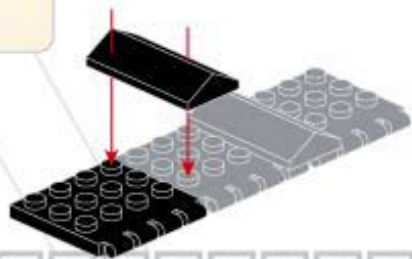

122

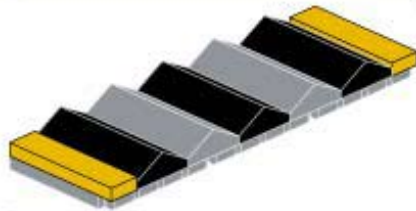



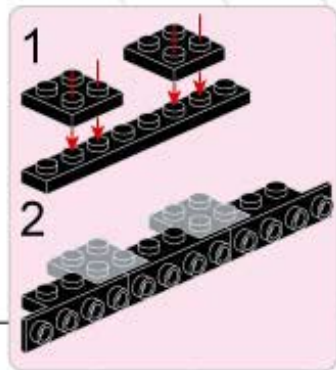
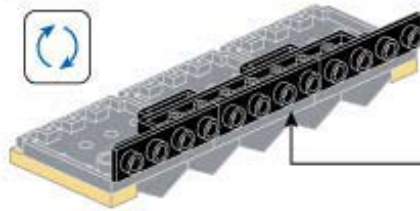
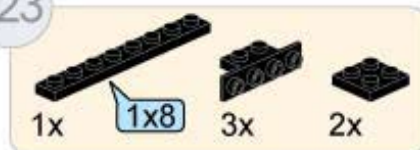



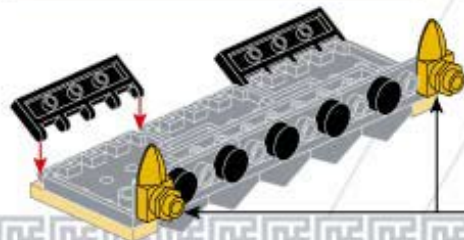

123





124



125











- 1x 
- 2x 
- 2x 
- 2x 
- 1x 
- 1x 
- 1x 
- 2x 

- 1 
- 2 
- 2x 

- 1 
- 2 



124

- 1x 
- 1x 
- 1x 
- 1x 
- 1x 
- 3x 
- 1x 
- 2x 
- 1x 
- 4x 

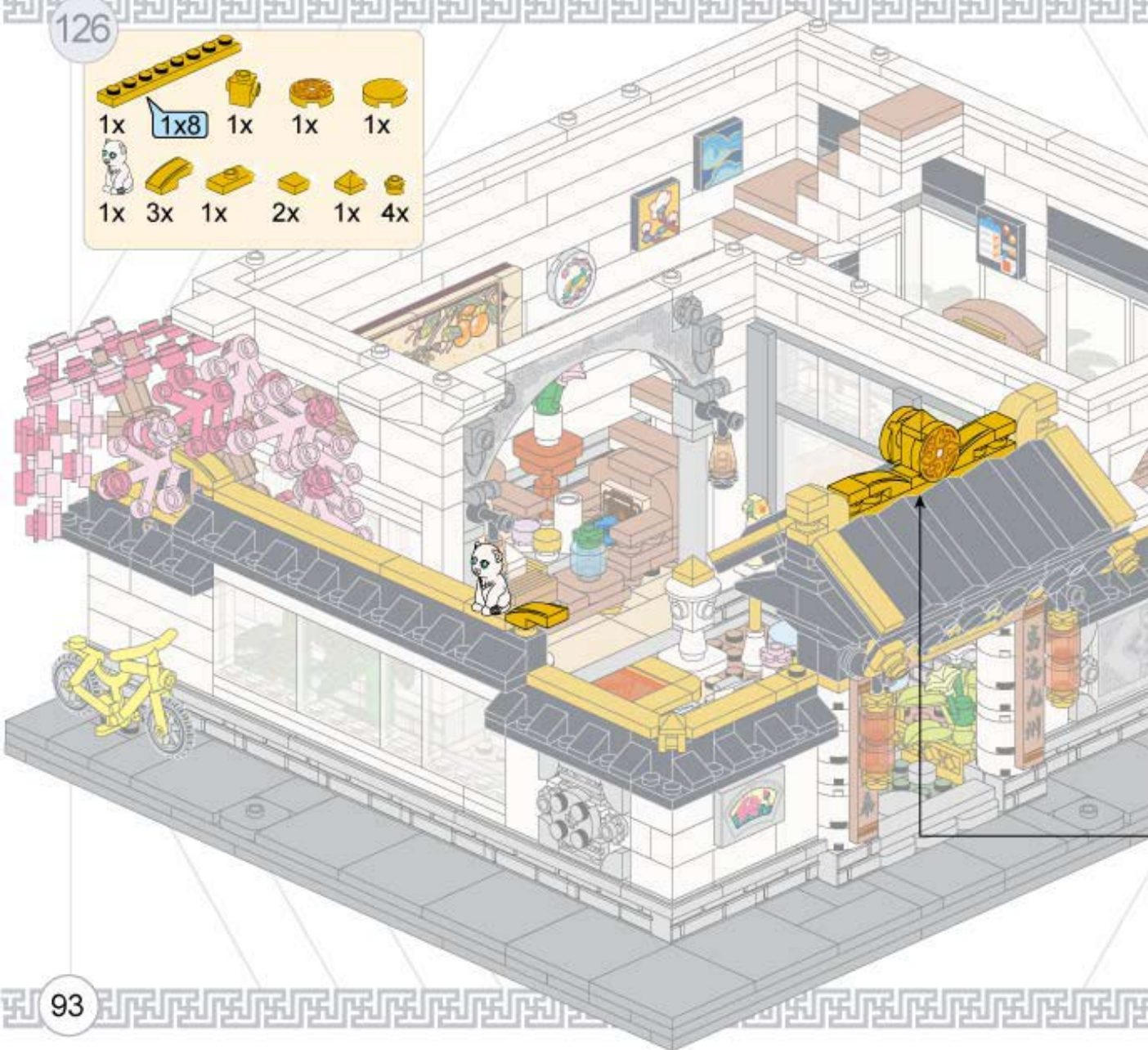

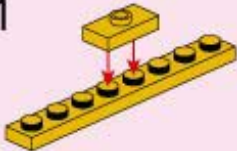
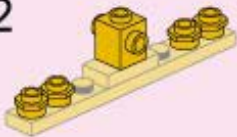
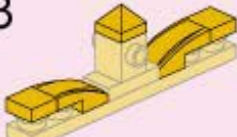
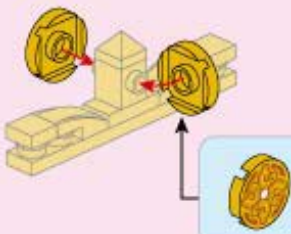
- 1 
- 2 
- 3 
- 4 



127

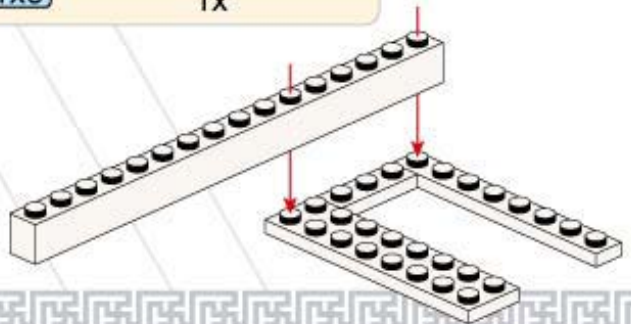
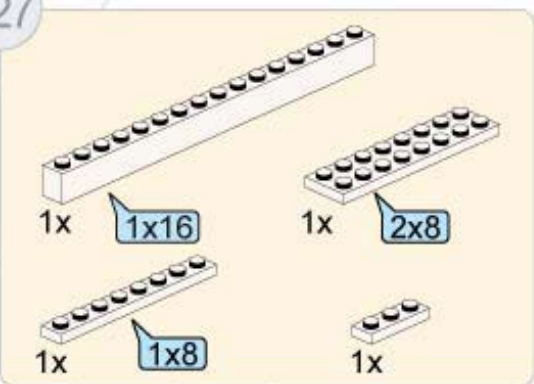

128

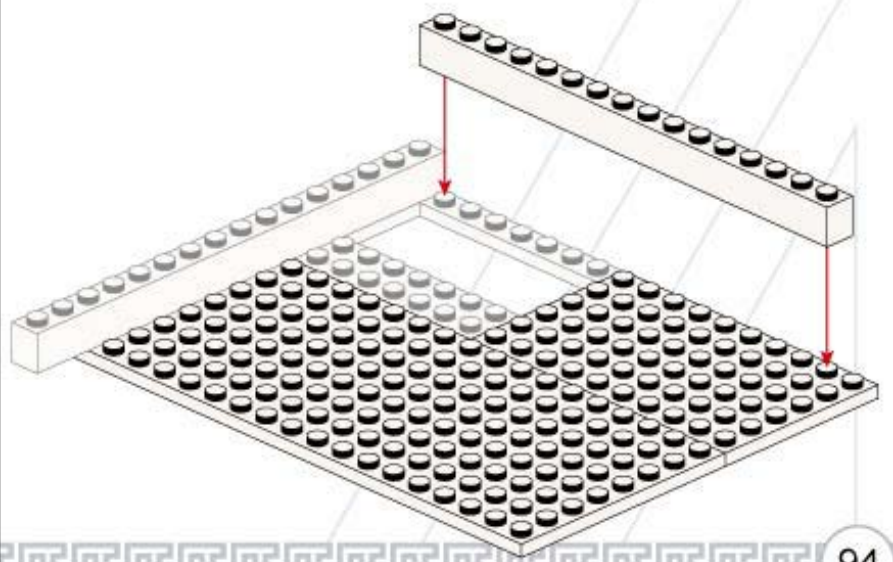
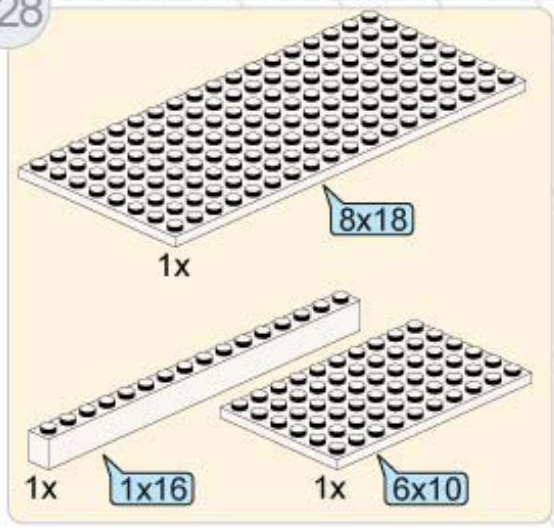

94

129

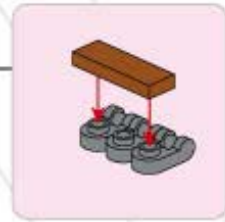
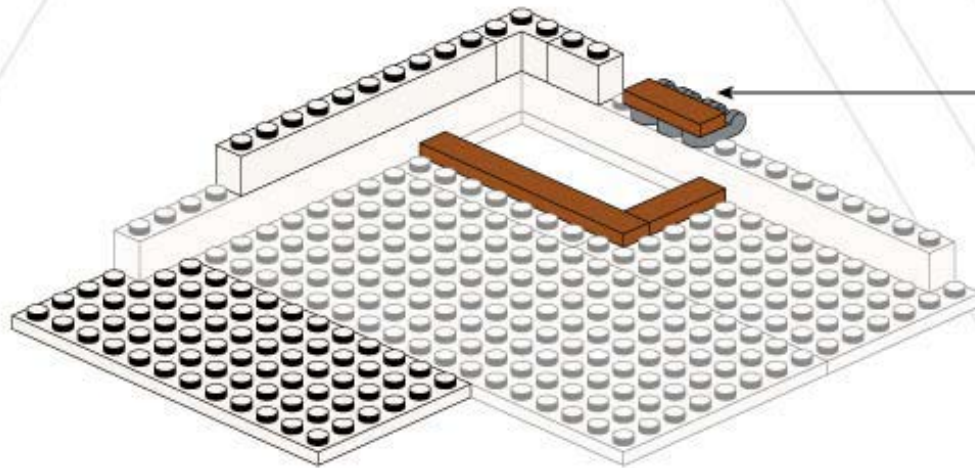
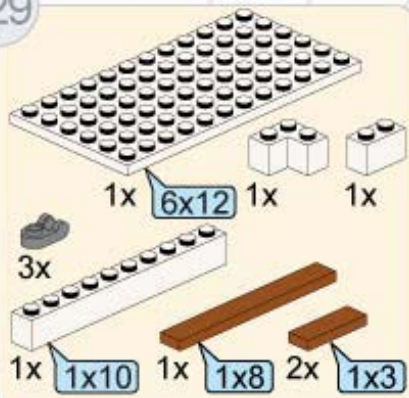



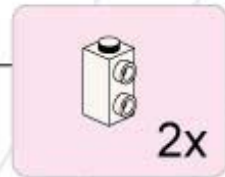
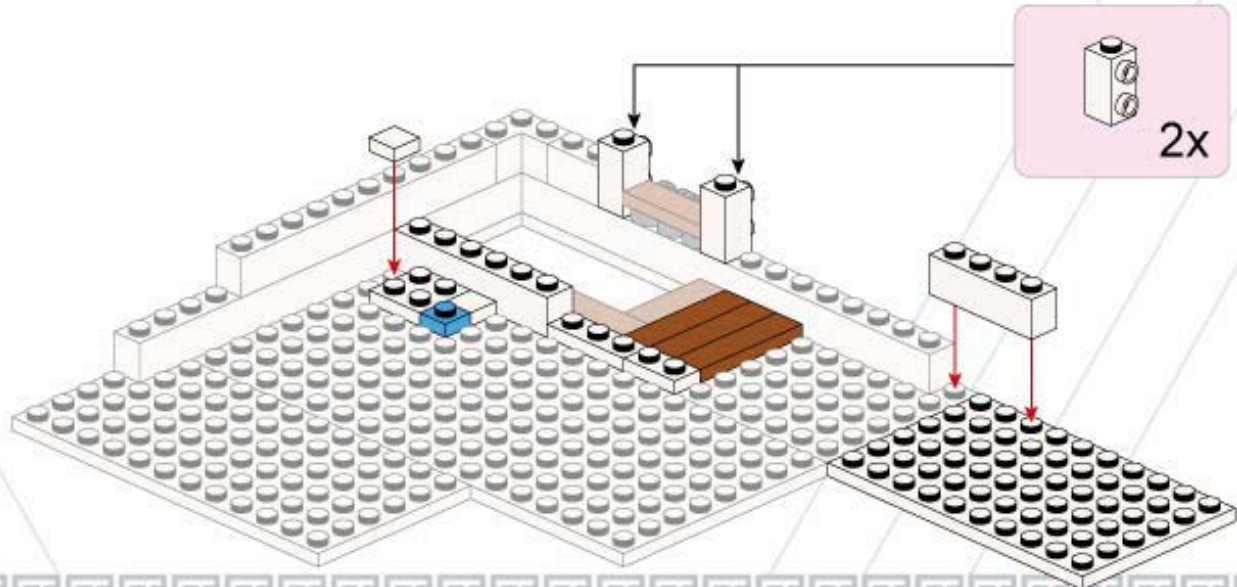
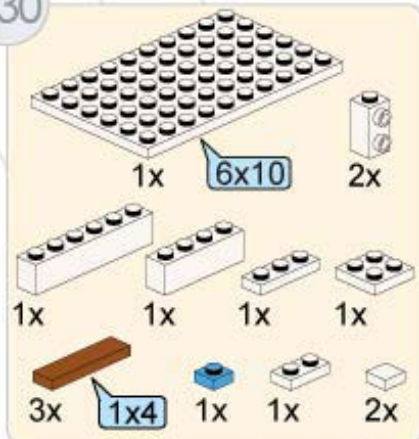



130





95

131





1x  1x  **1x12**

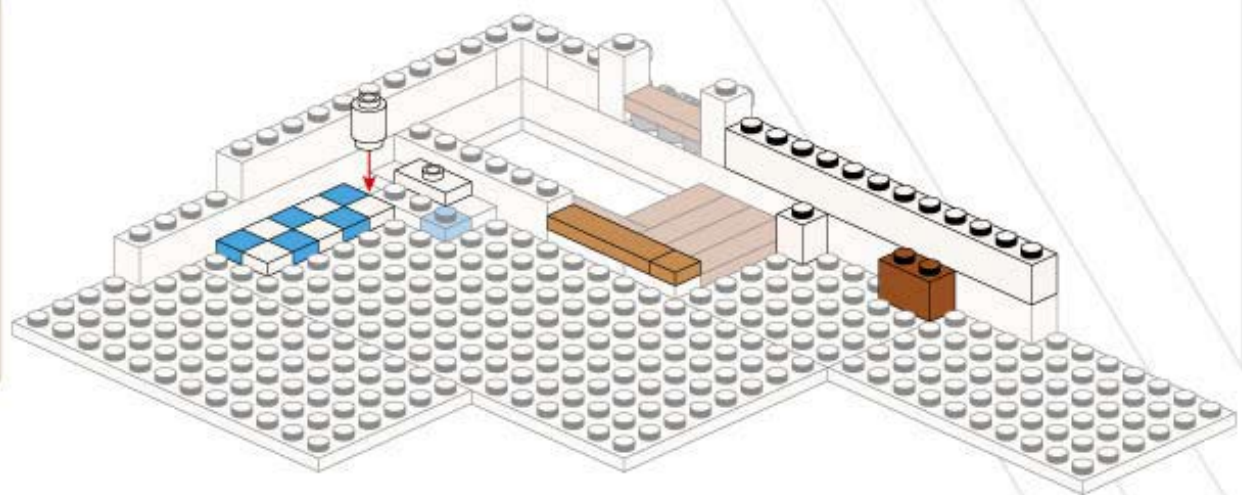



1x  1x  5x  5x 

1x  1x  **1x4** 1x 



132

1x  1x  1x  5x  2x 

1x  2x  1x  1x  5x 

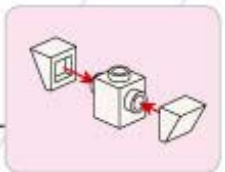
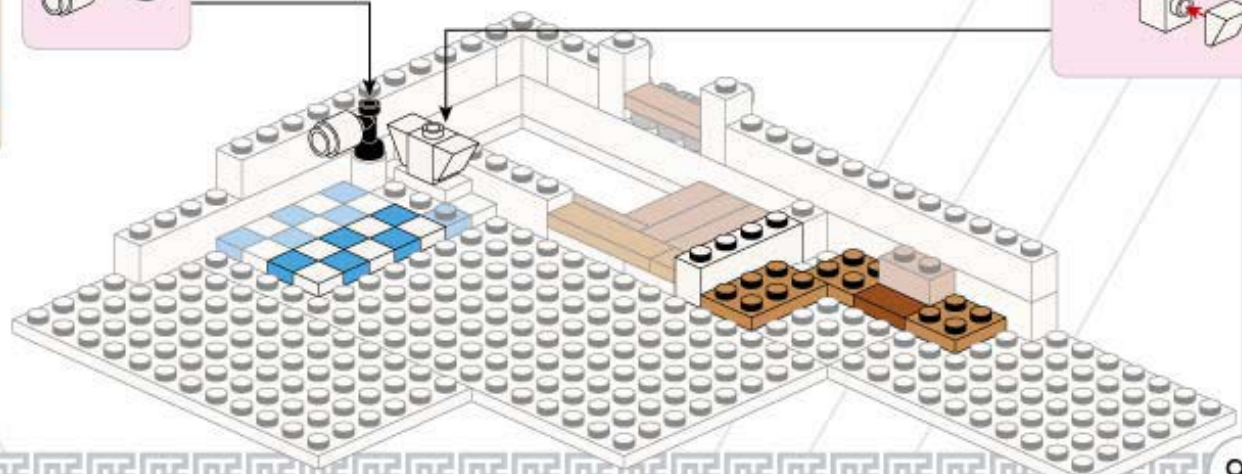

133

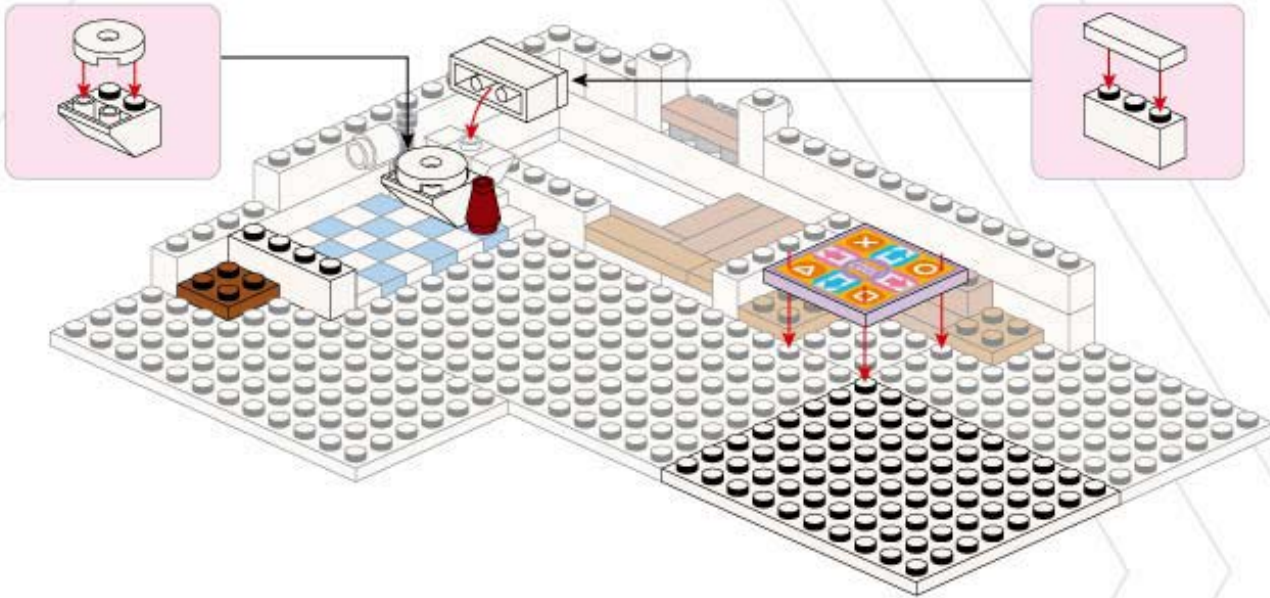
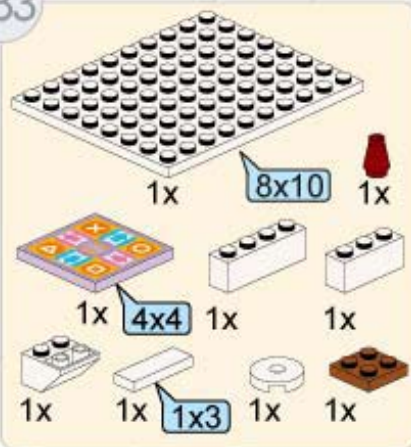

134

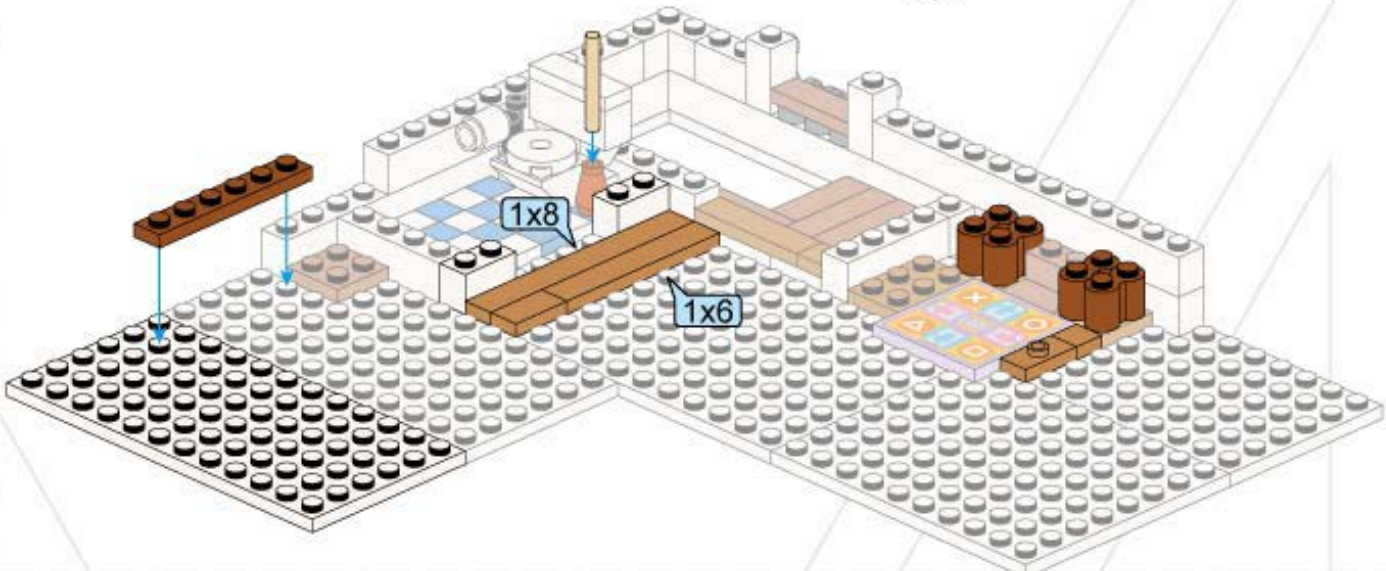
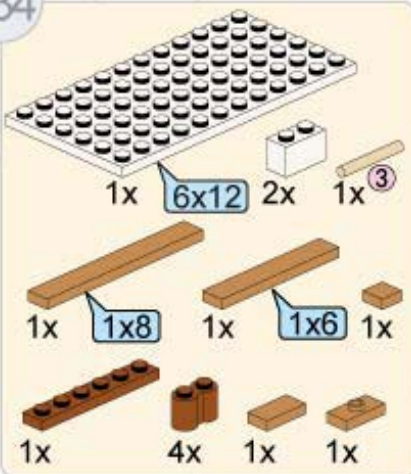



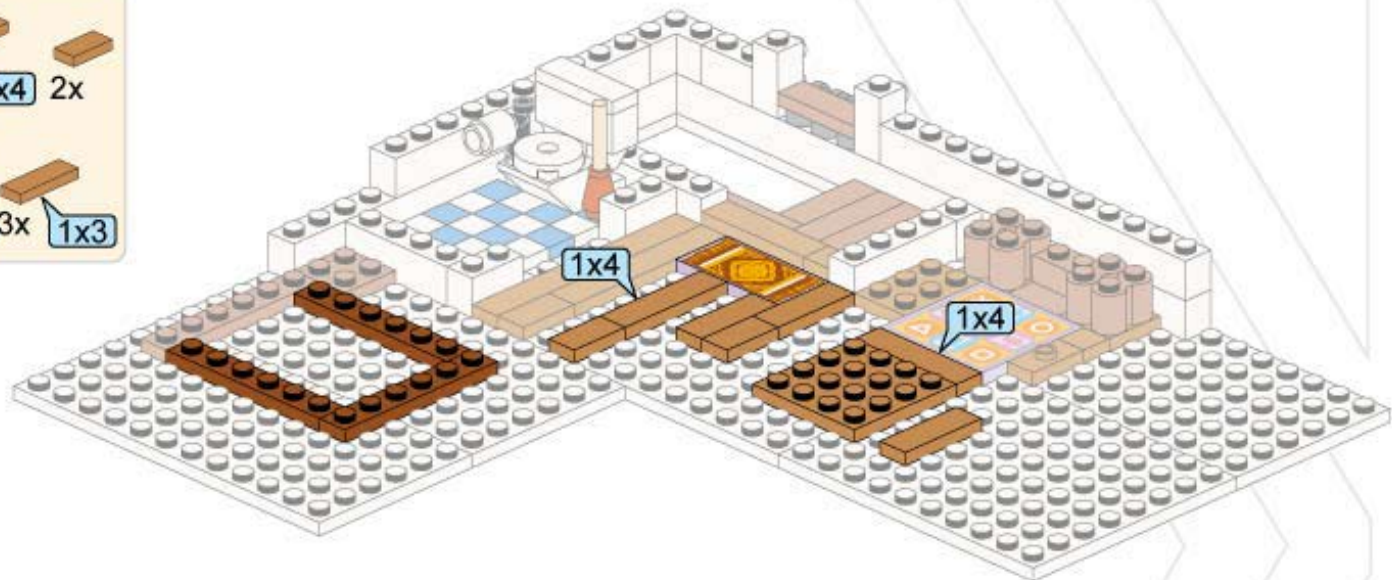
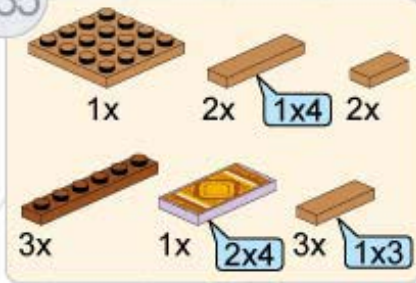



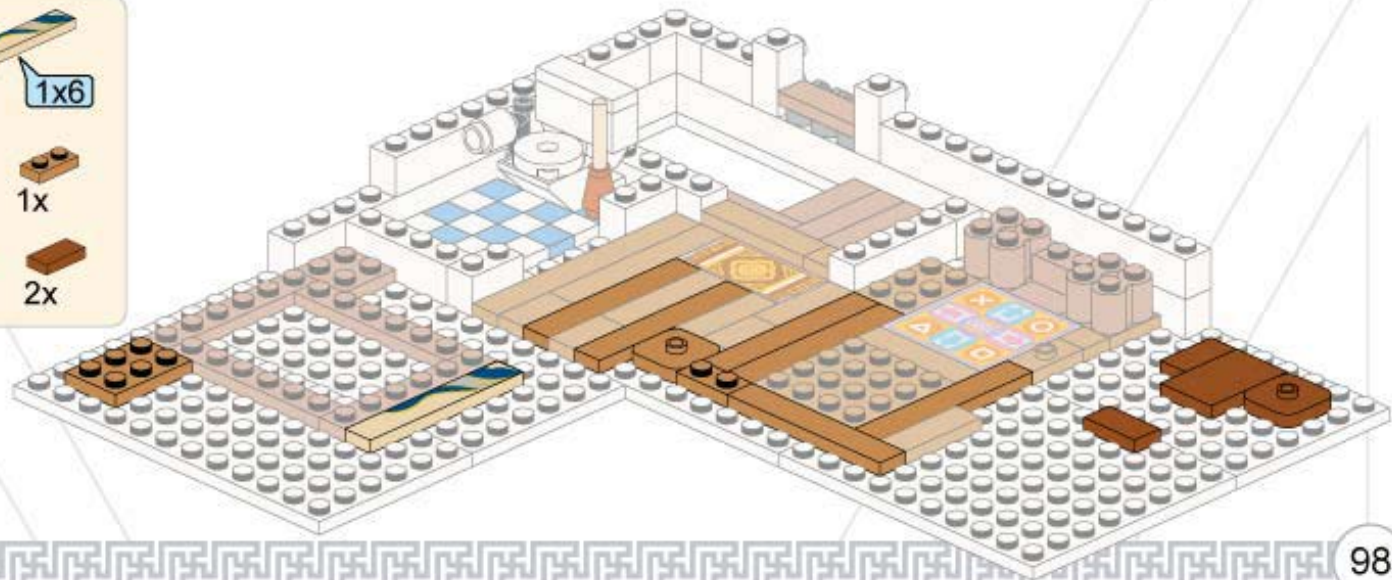
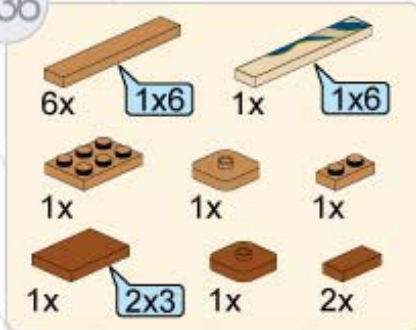

135



136







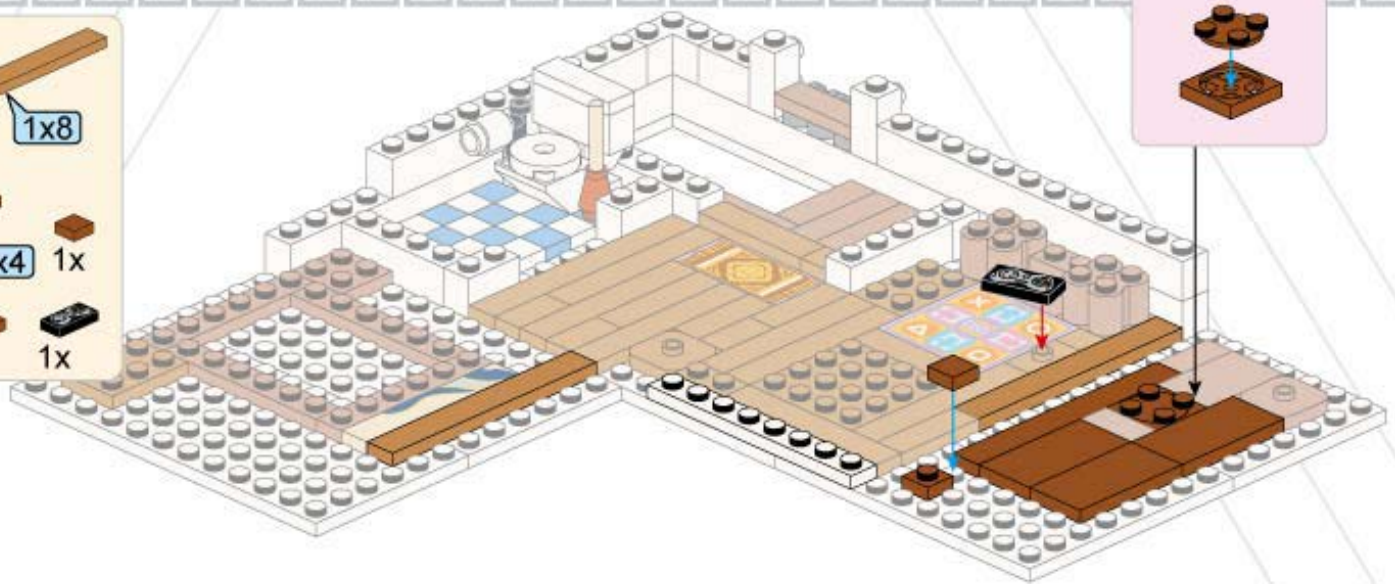

137

- 1x  1x8
- 2x  1x8
- 1x  1x8
- 3x  2x4
- 1x  1x
- 1x  1x
- 1x  1x
- 1x  1x



138

- 1x  1x12
- 2x  1x12
- 2x  1x2
- 1x  1x2
- 1x  1x2
- 1x  1x
- 1x  1x

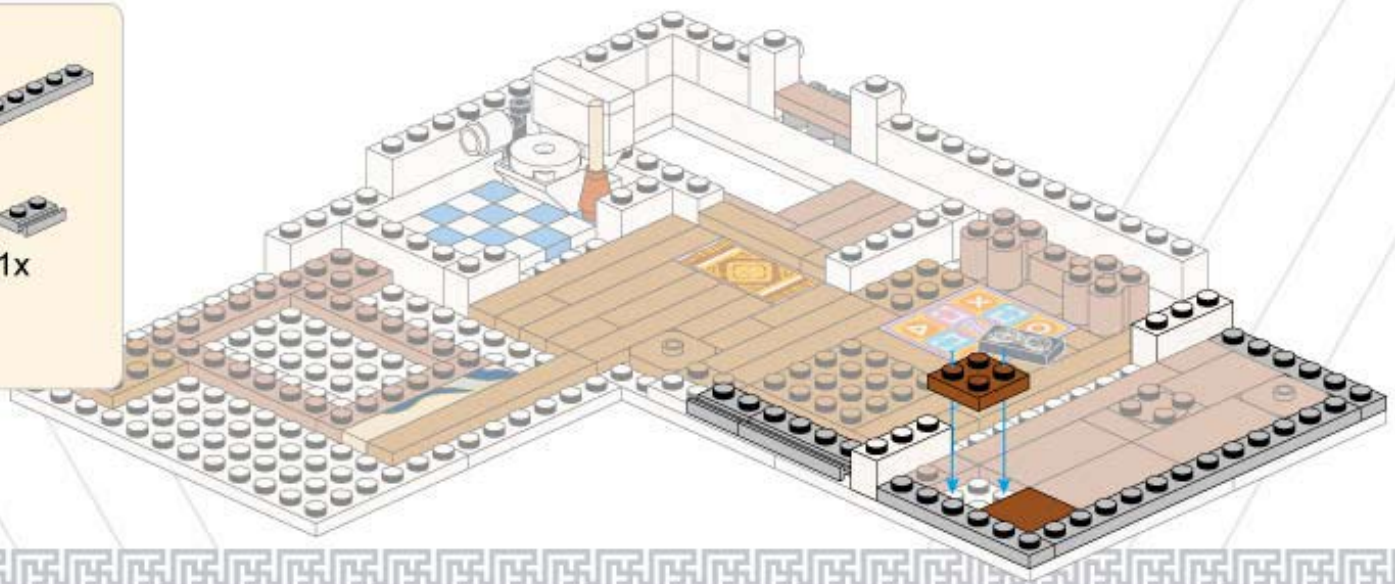

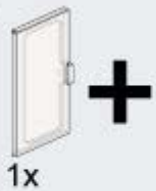

+

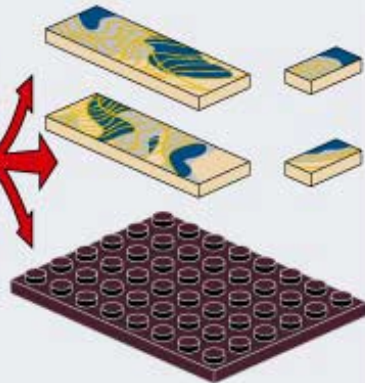
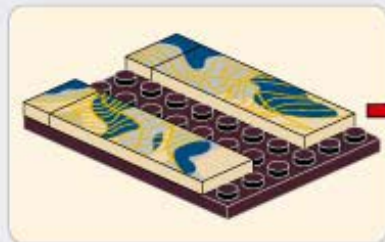

139

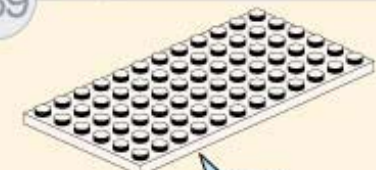

1x

6x12

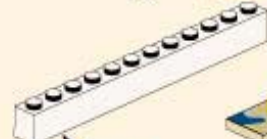

1x

1x12



1x

2x6



1x

2x6



1x



1x



100

140

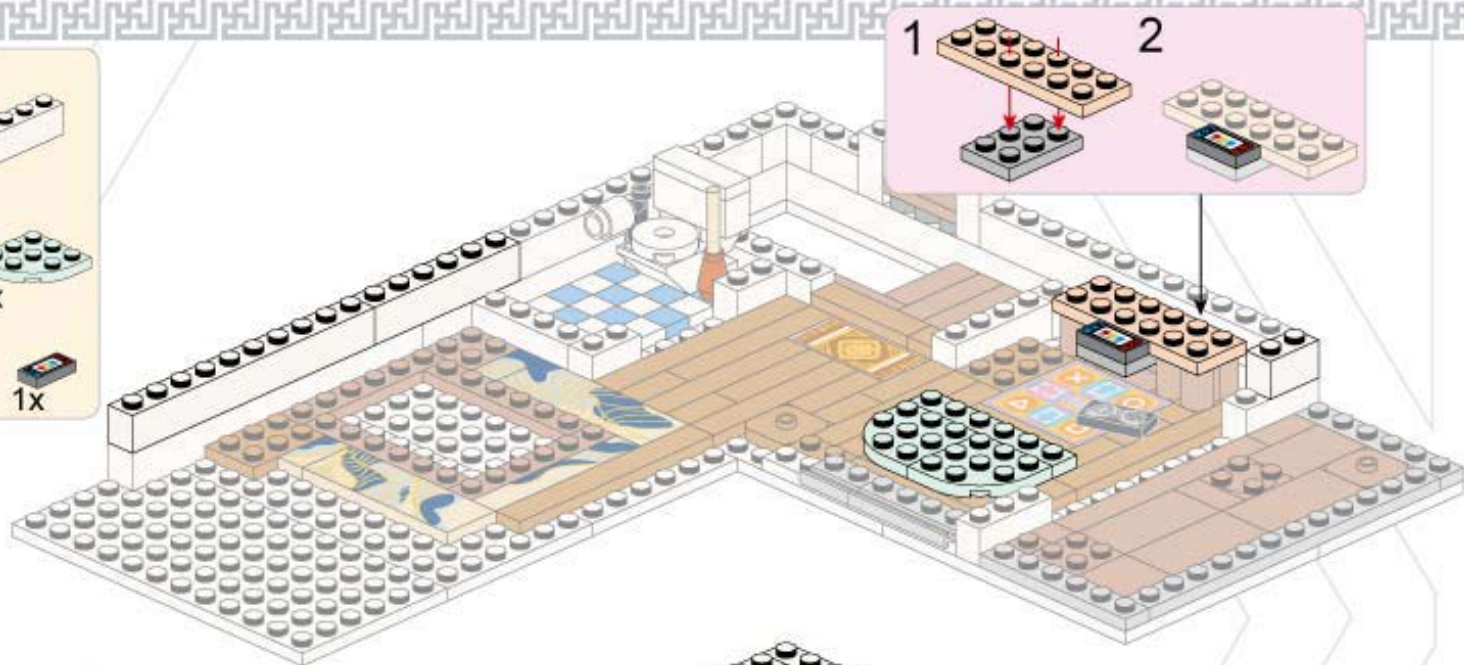
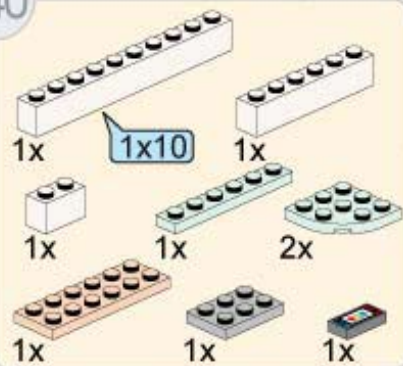

141

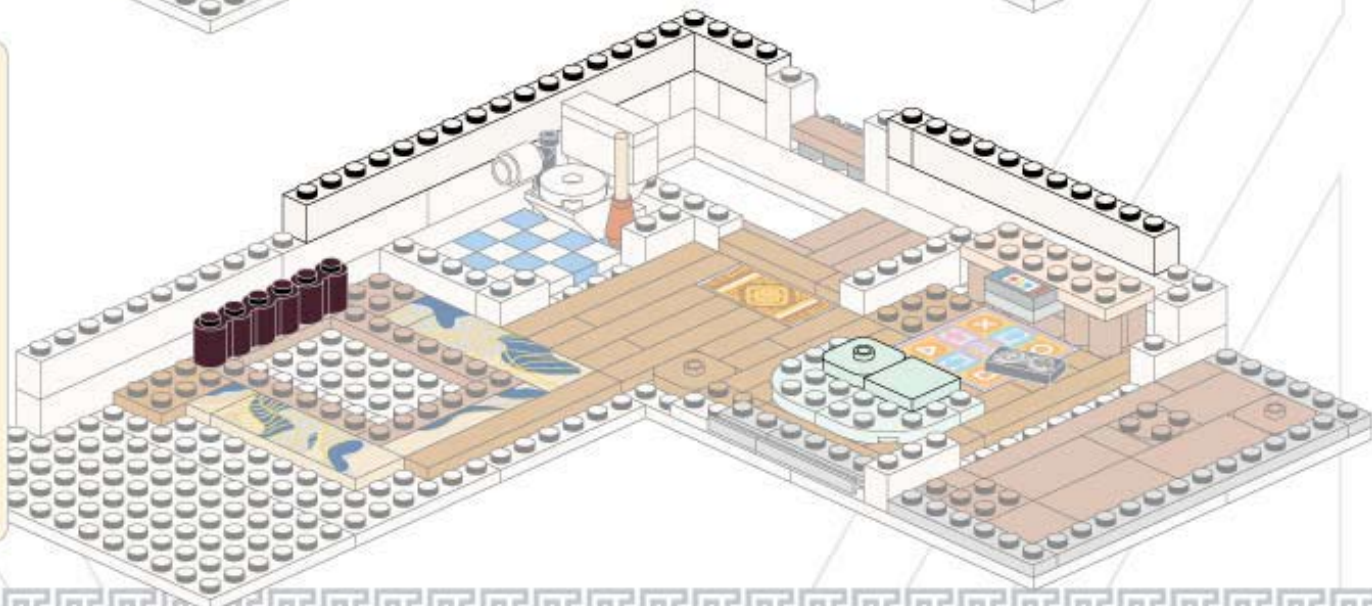
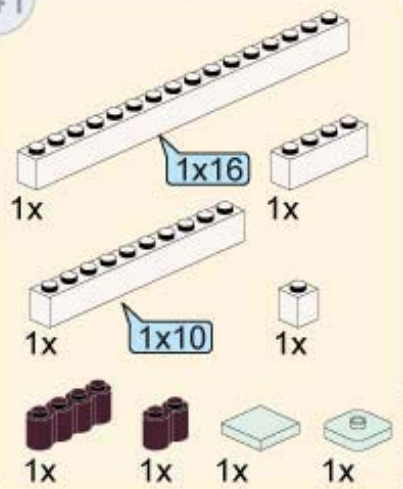

101

142

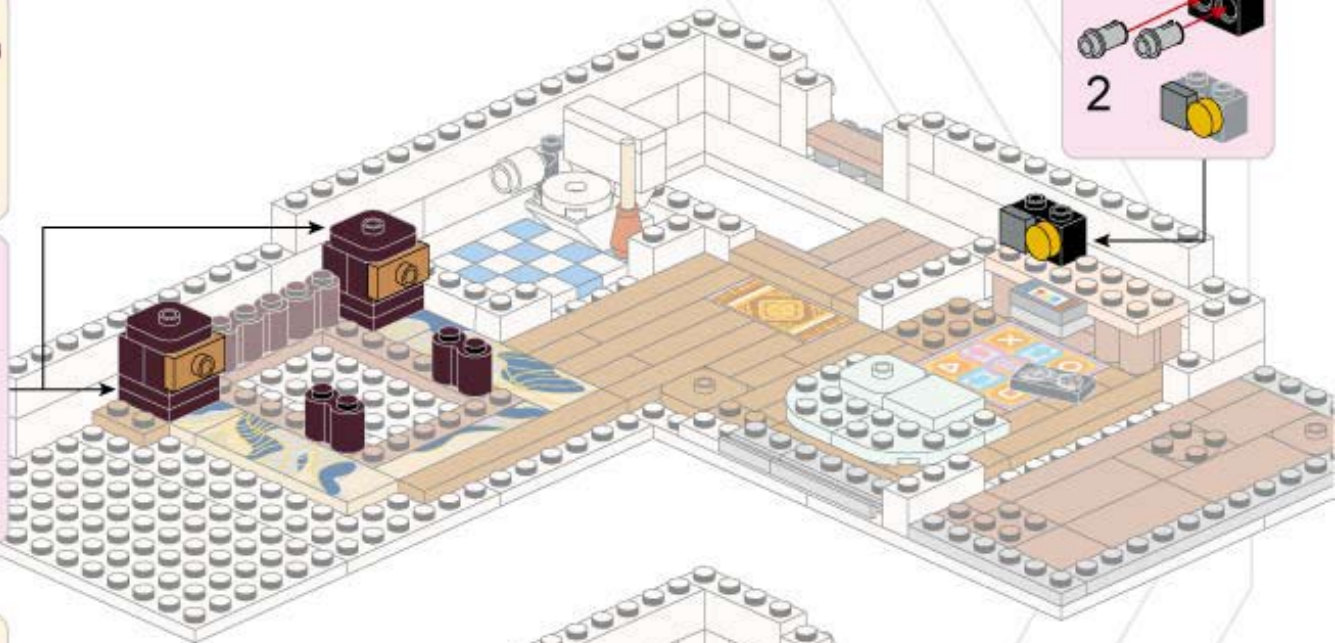
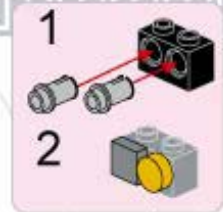
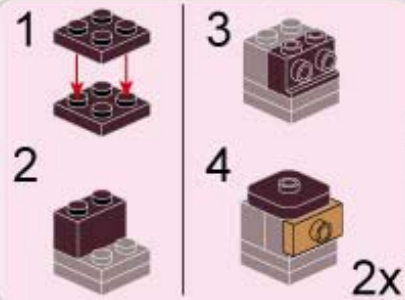
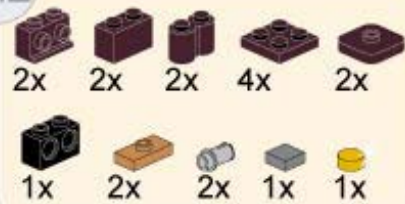

143

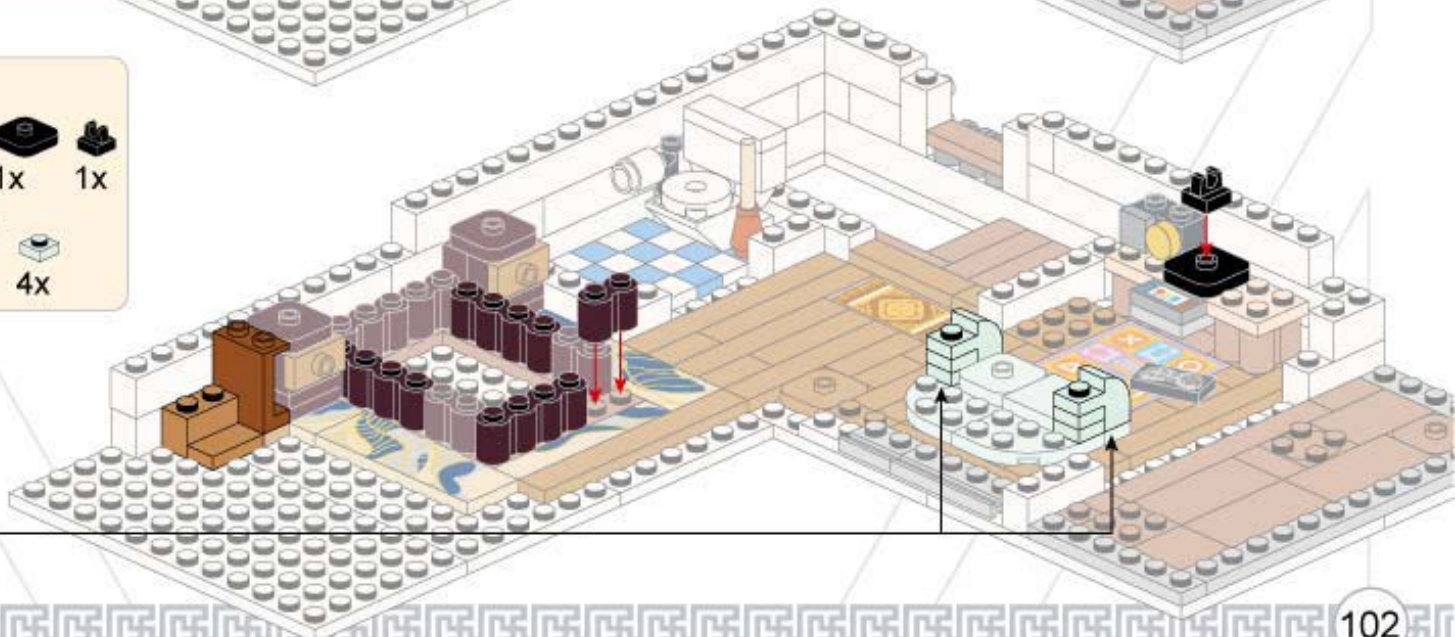
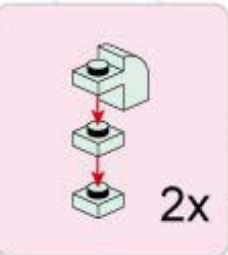
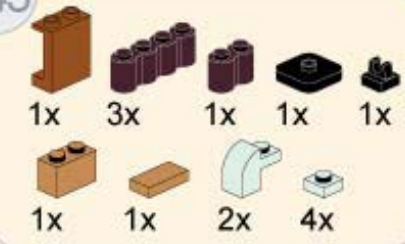

144

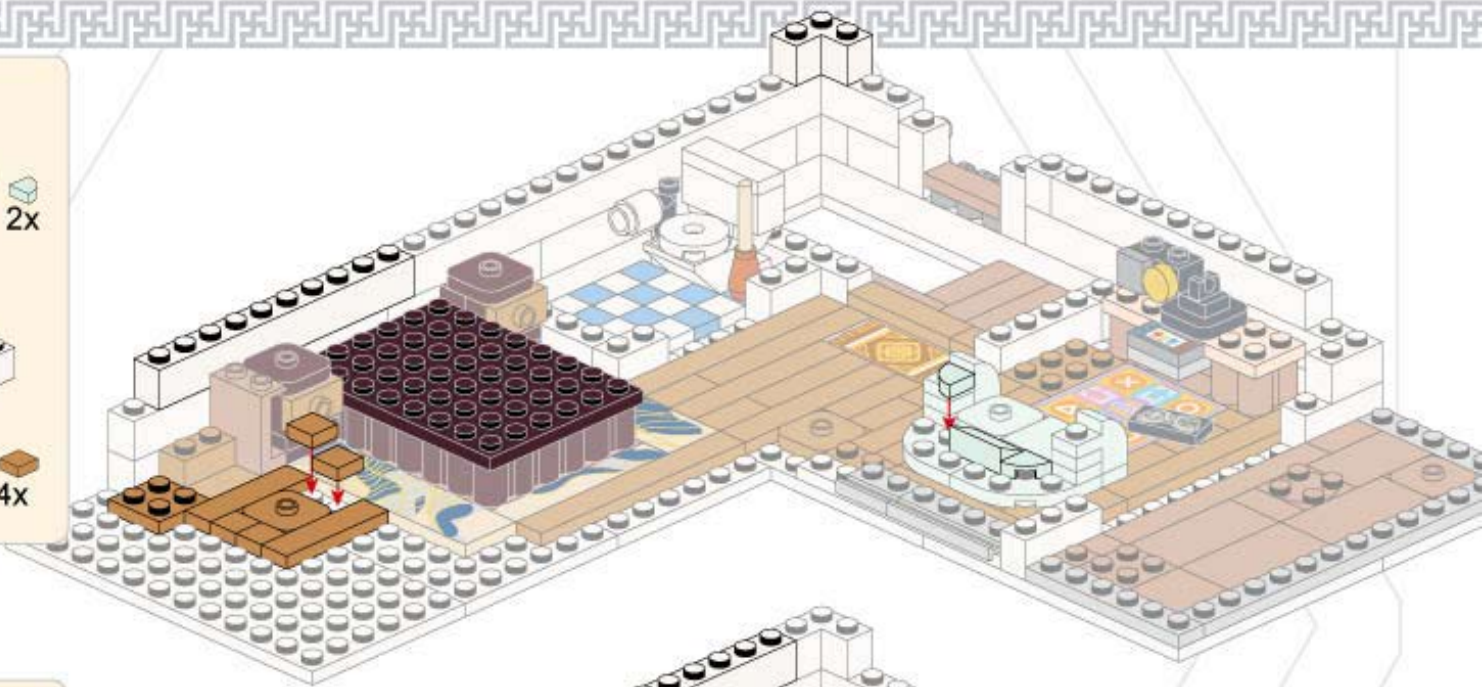
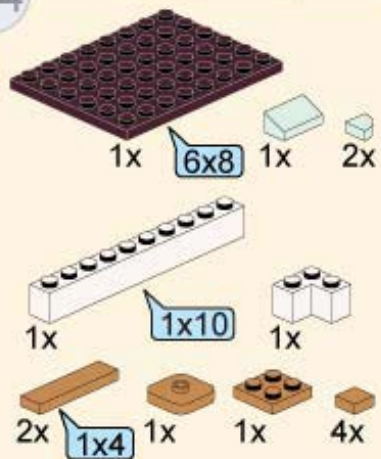

145

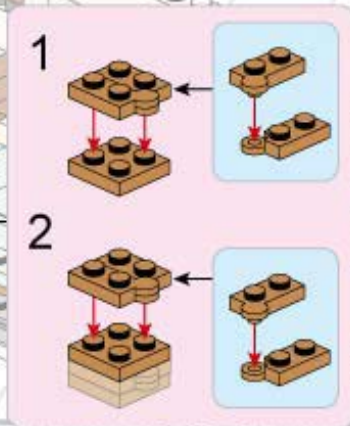
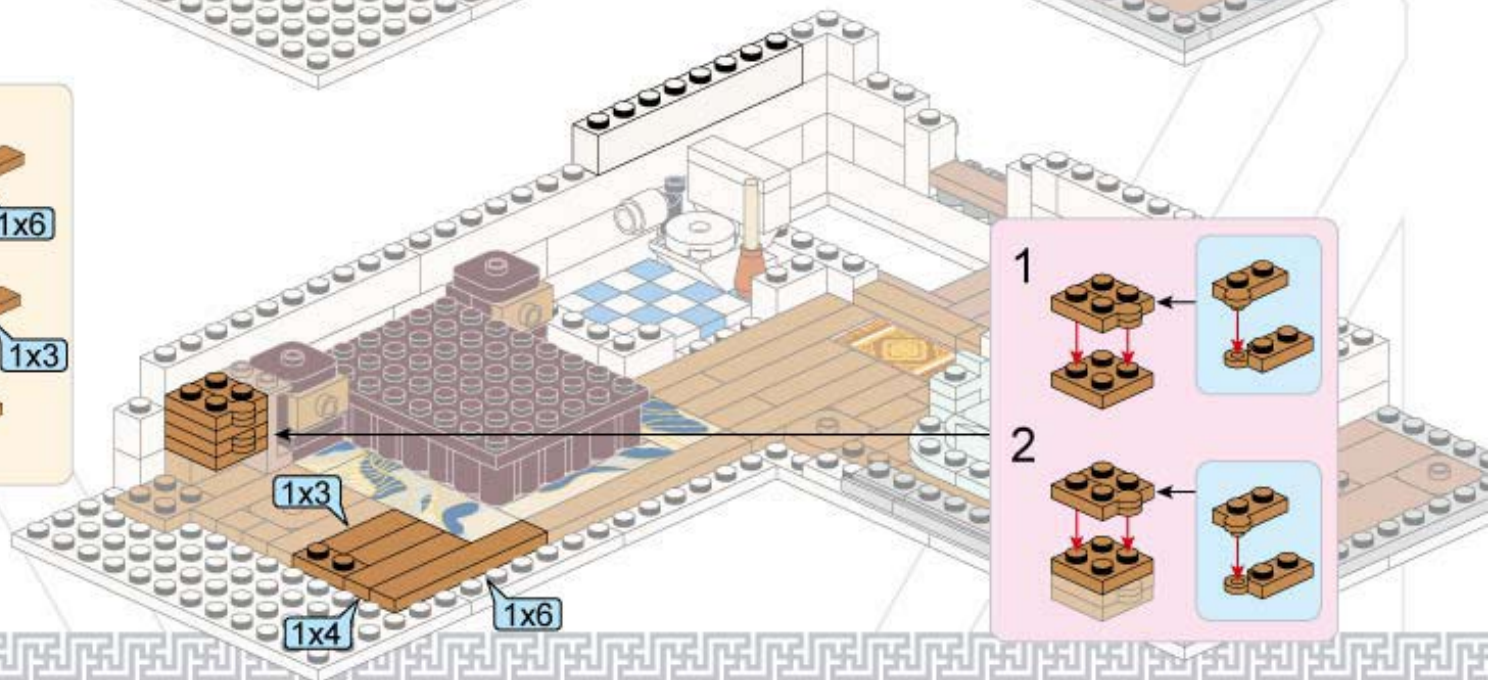
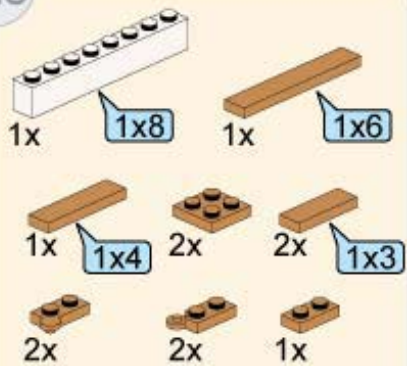

103

146

- 1x 2x12
- 1x 1x10
- 1x 1x8
- 1x 1x1
- 3x 1x1
- 2x 1x1
- 1x 1x1
- 1x 1x1
- 1x 1x1
- 1x 1x1

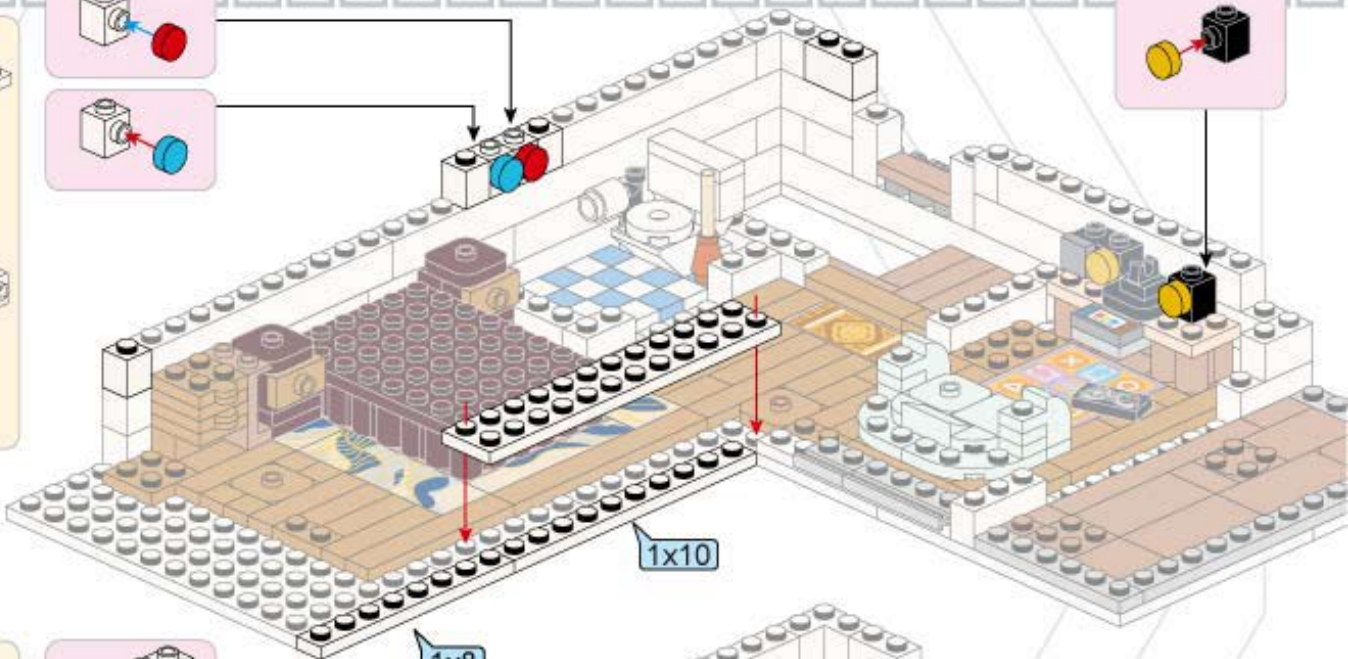
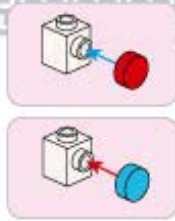

147

- 1x 1x1
- 1x 1x10
- 1x 1x1
- 1x 1x1
- 2x 1x1
- 1x 1x1
- 1x 1x1
- 1x 1x1
- 1x 1x1
- 1x 1x1

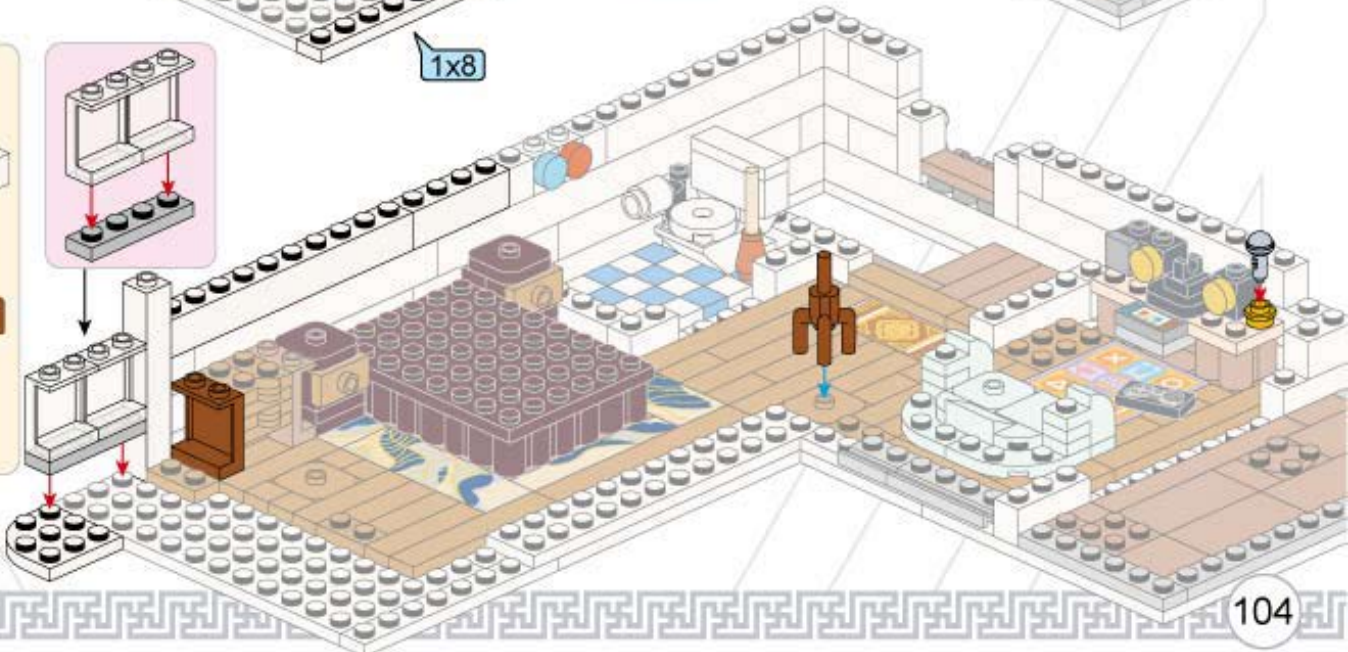
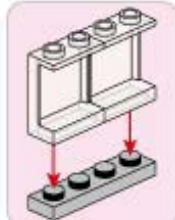

148

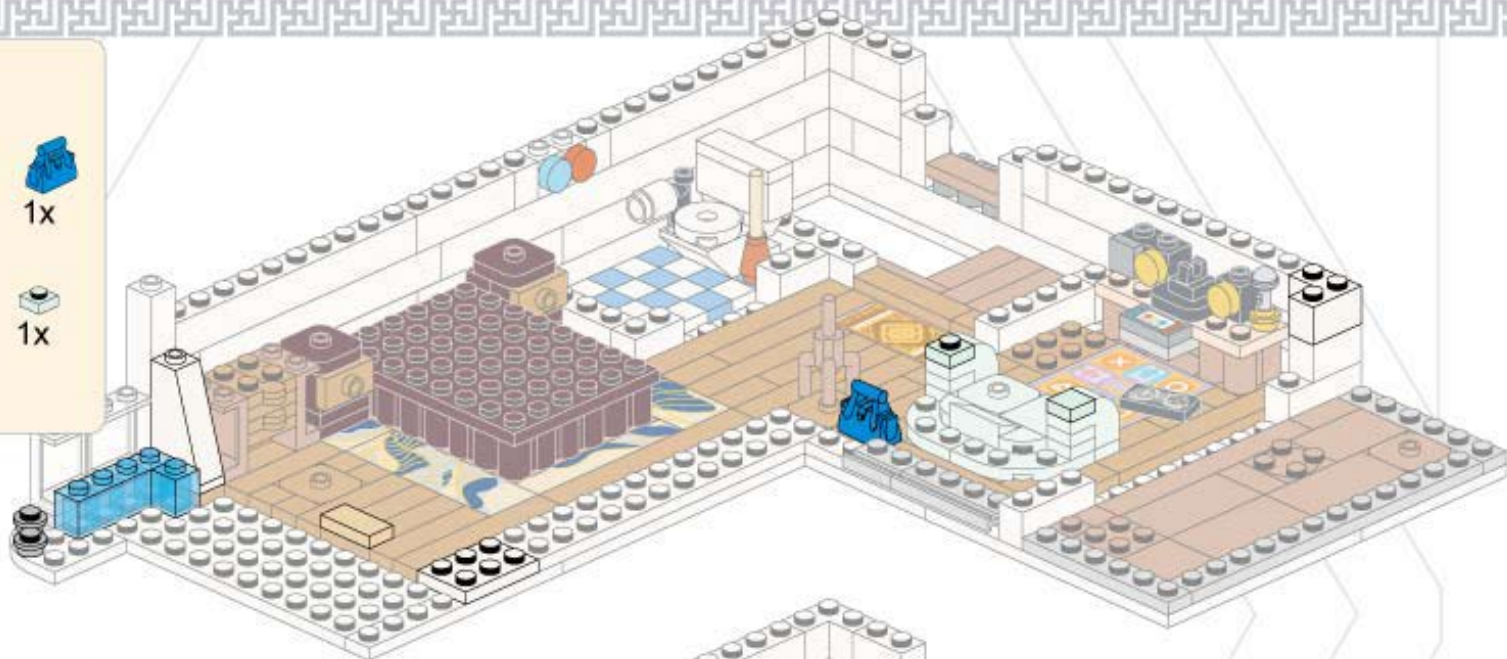
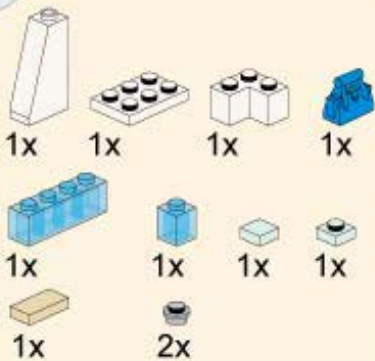

149

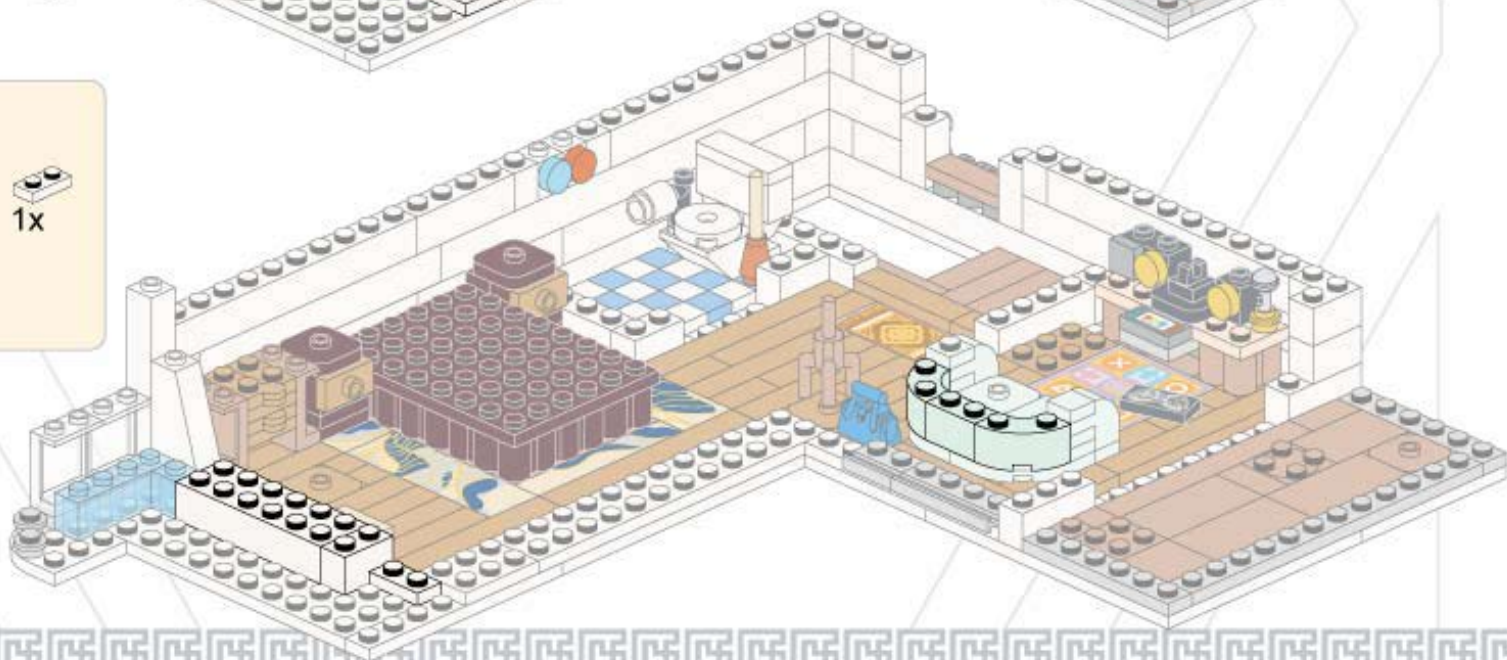
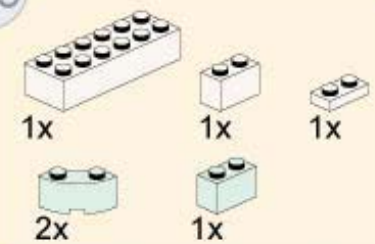

105

150

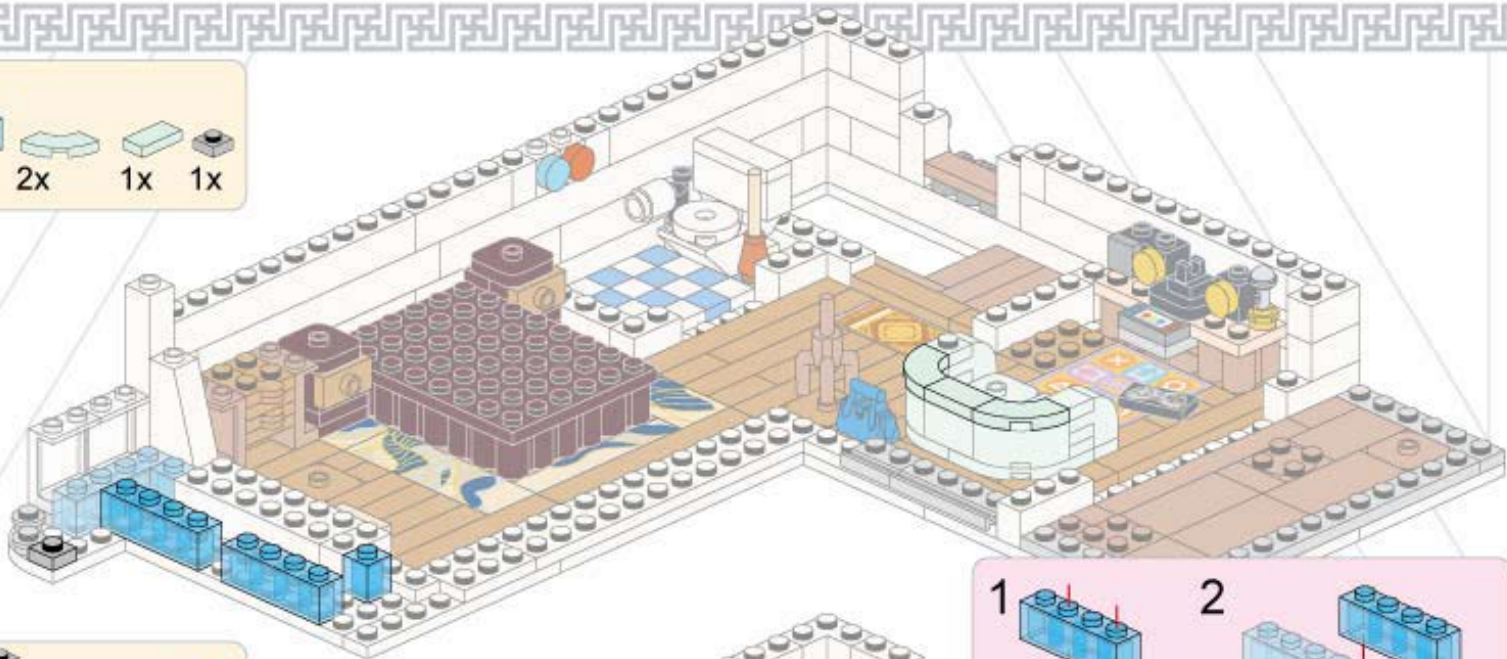
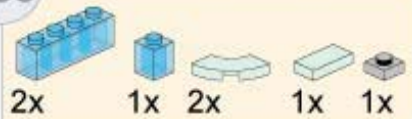

151

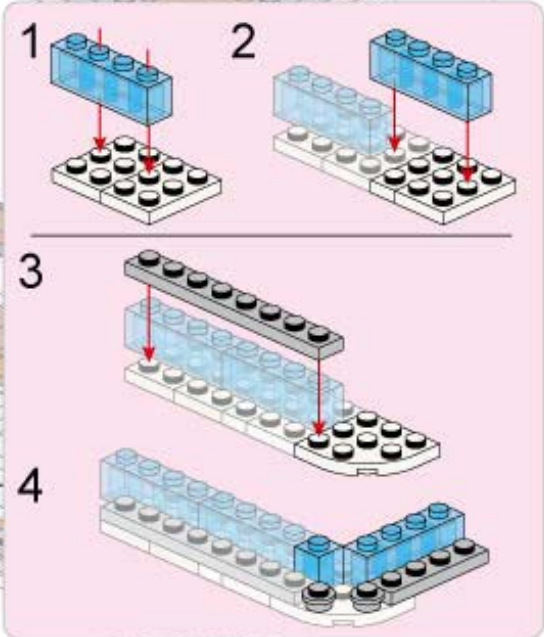
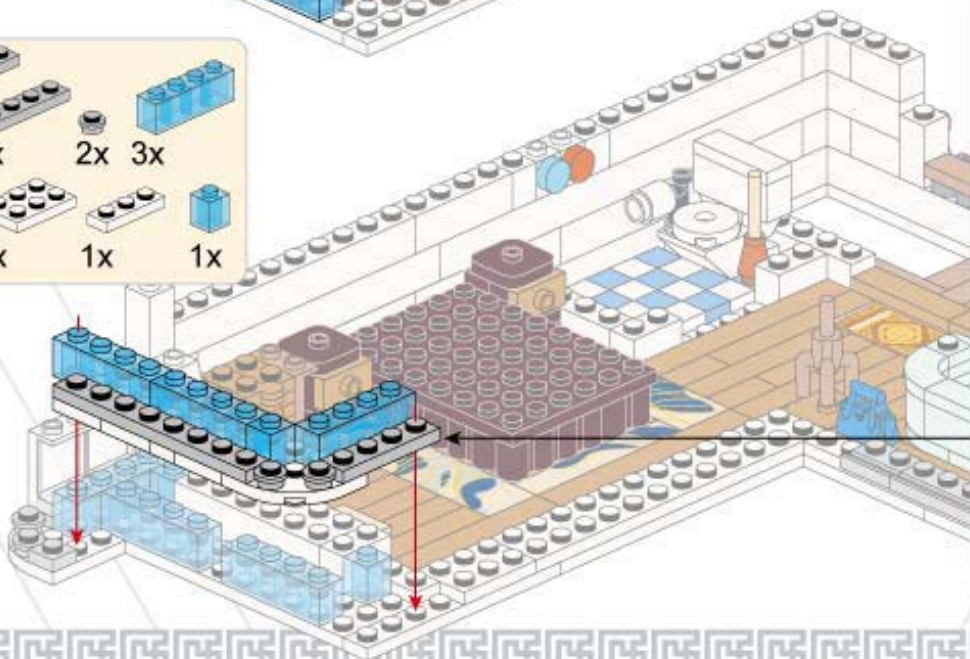
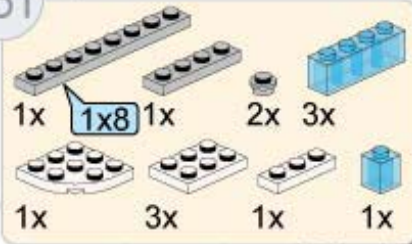

152

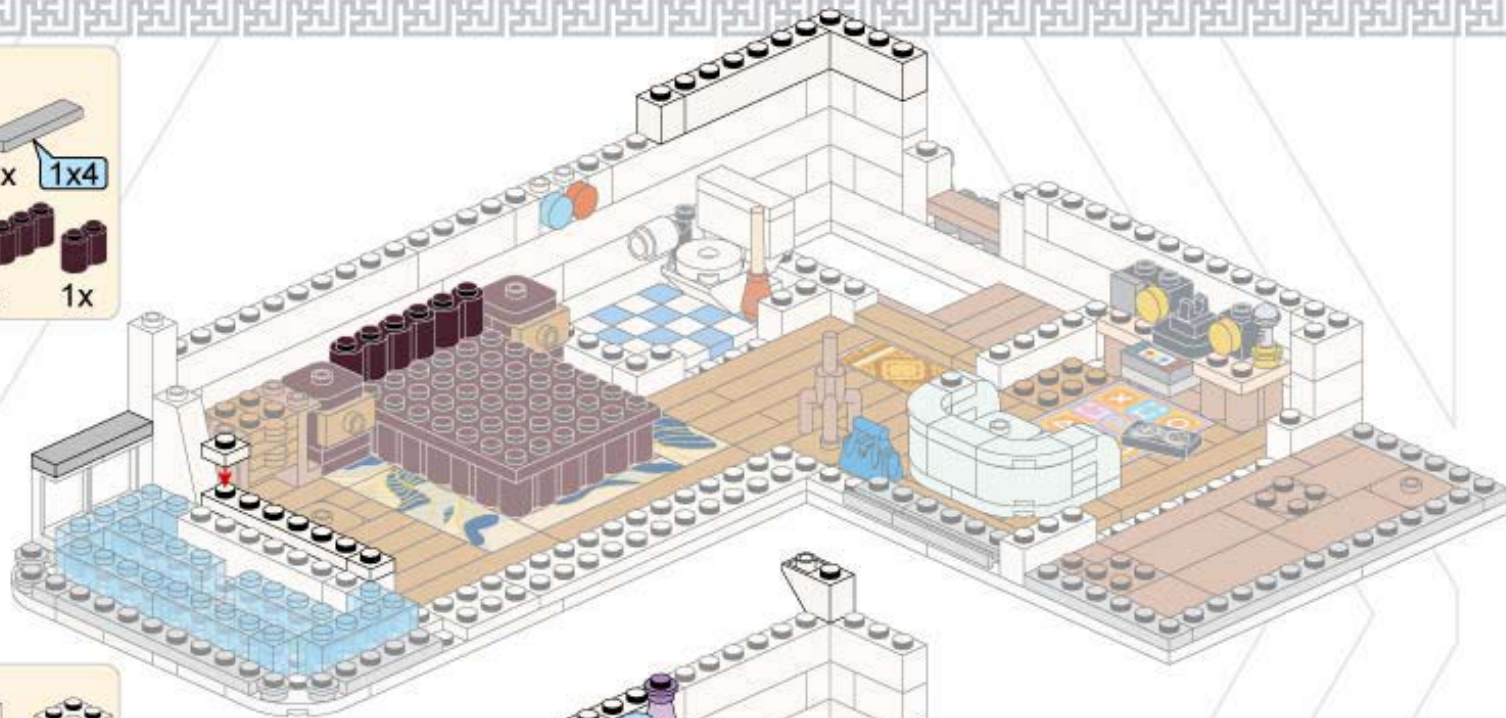
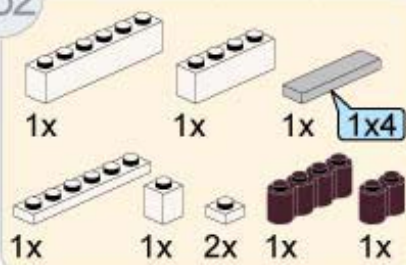



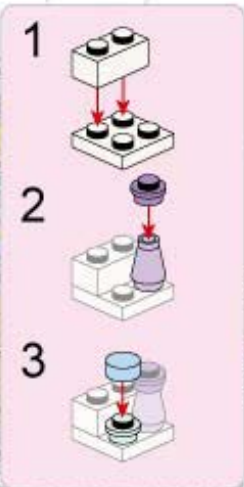
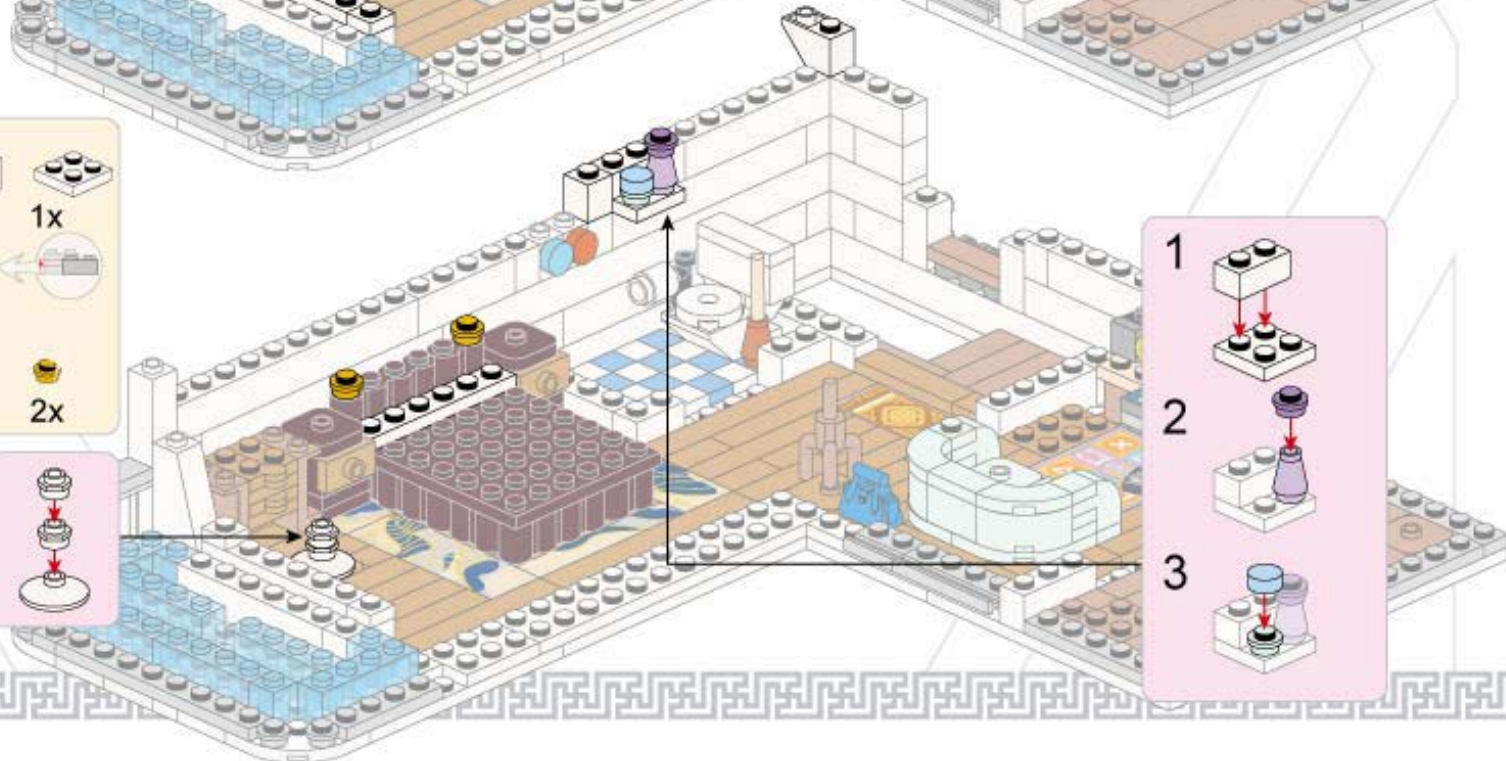
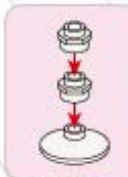
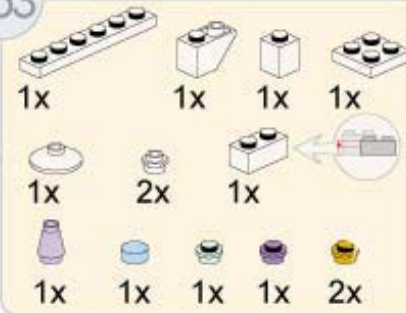



153









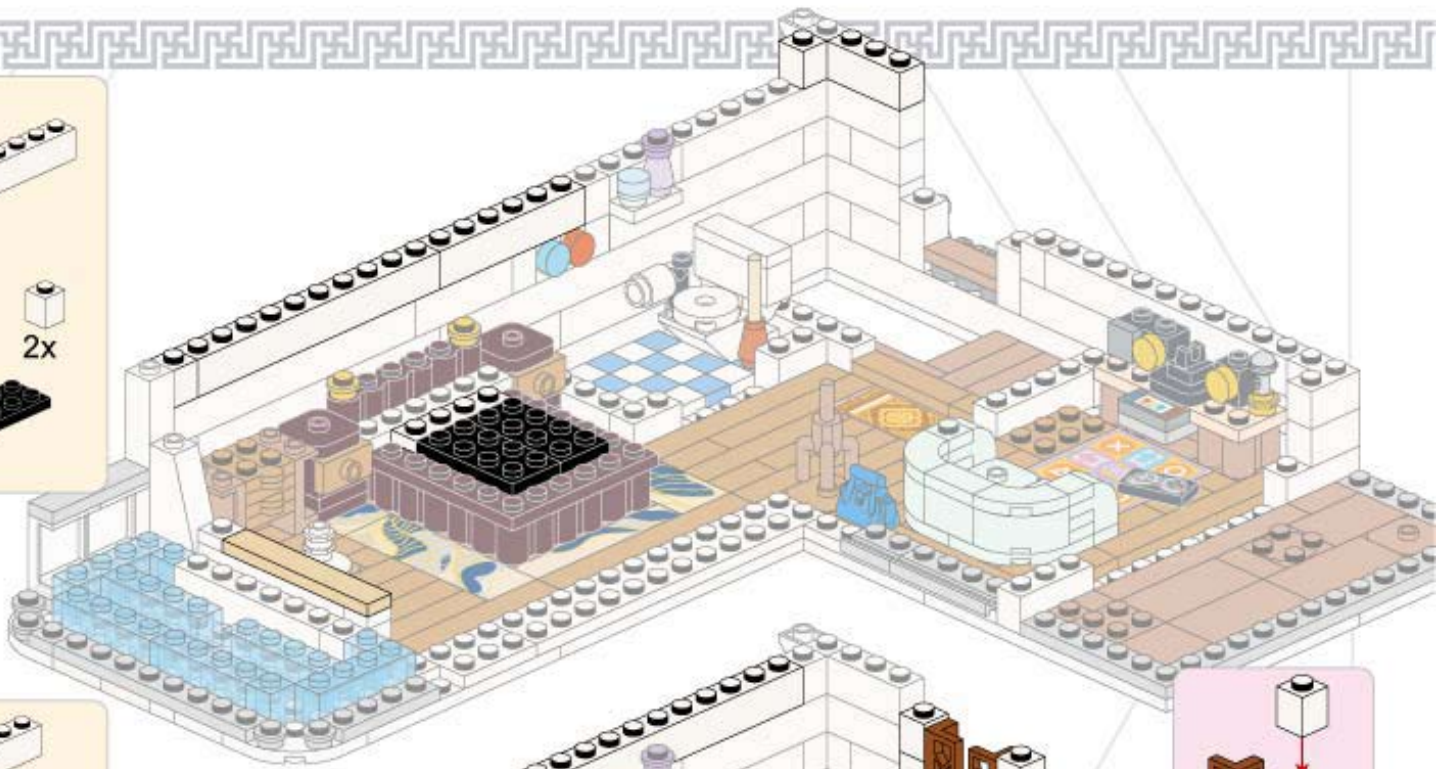

107

154

- 1x  1x 
- 1x  1x  2x 
- 1x  2x 







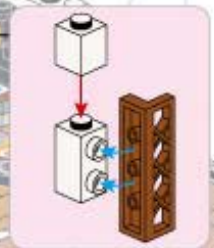
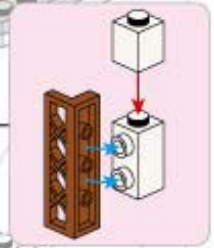



155

- 1x  2x  2x 
- 1x  2x 
- 1x  1x  1x  1x 



156

1x  3x  1x  2x 

2x  2x  2x  1x  2x 

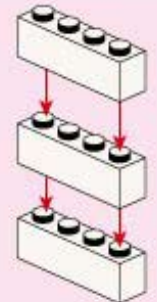



2x



157

1x  2x  1x 

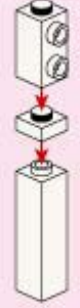
1x  1x  2x  2x 

1x  2x  2x 



- 1 
- 2 

2x

109

158

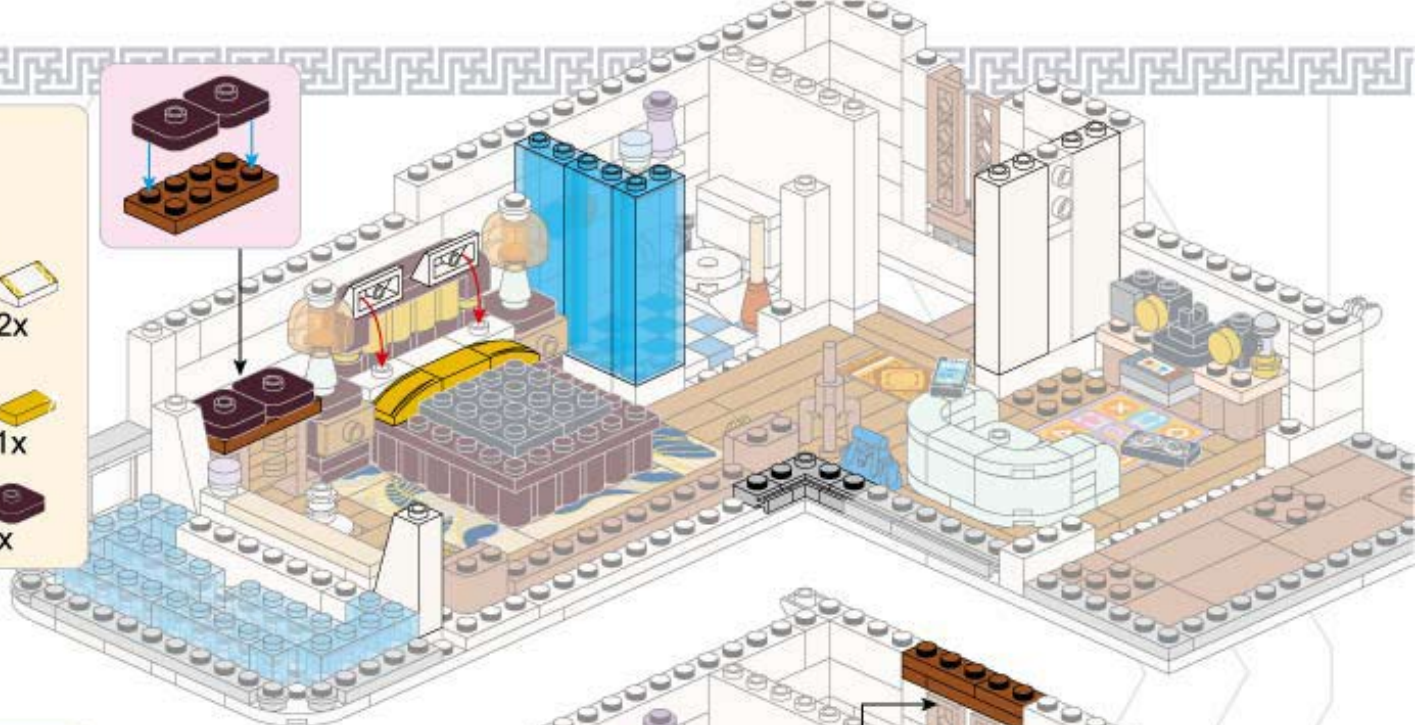
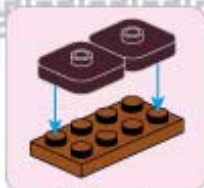

159

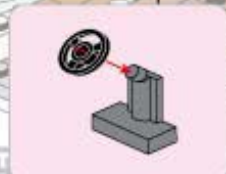
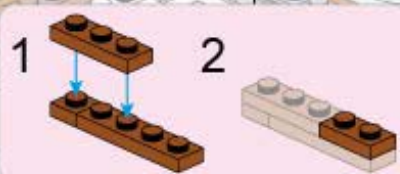
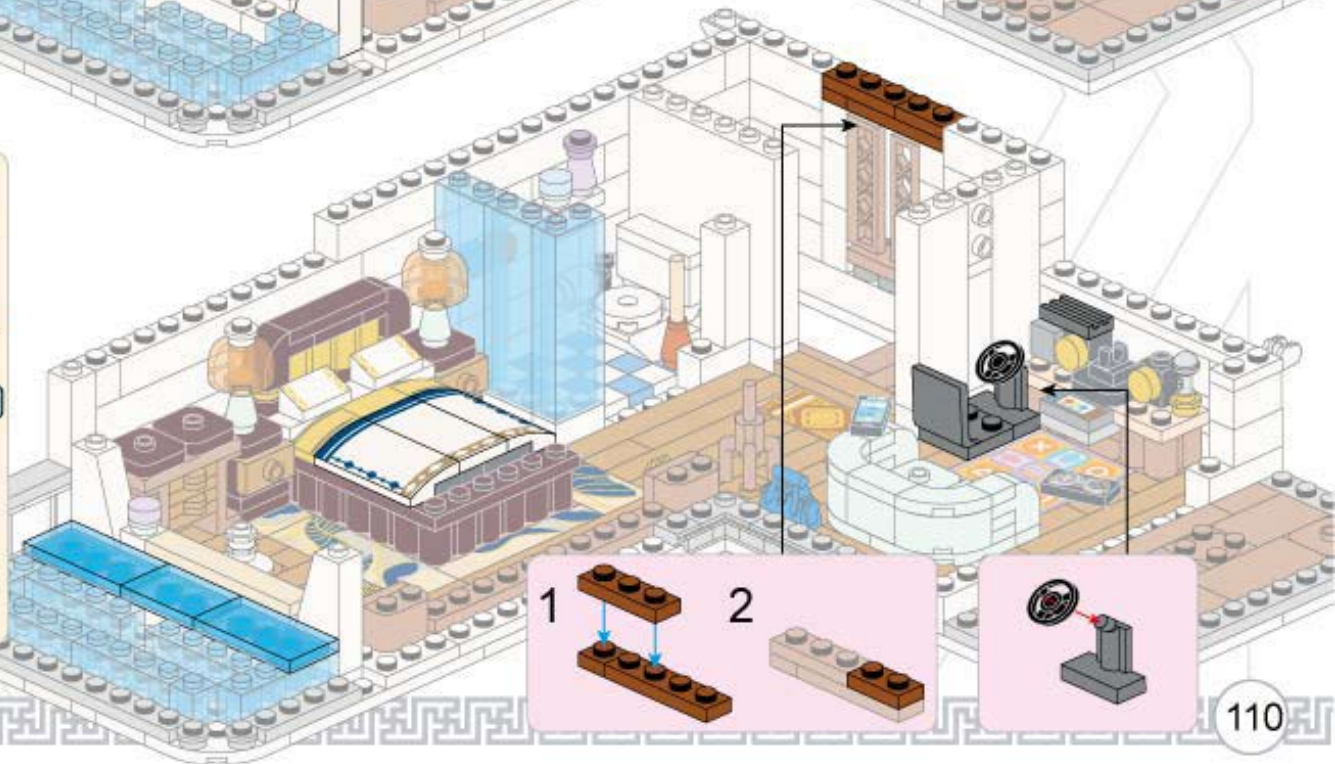
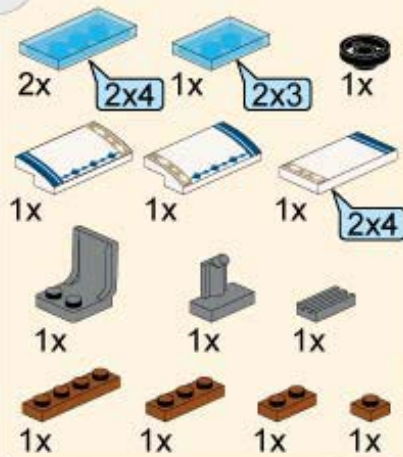

160

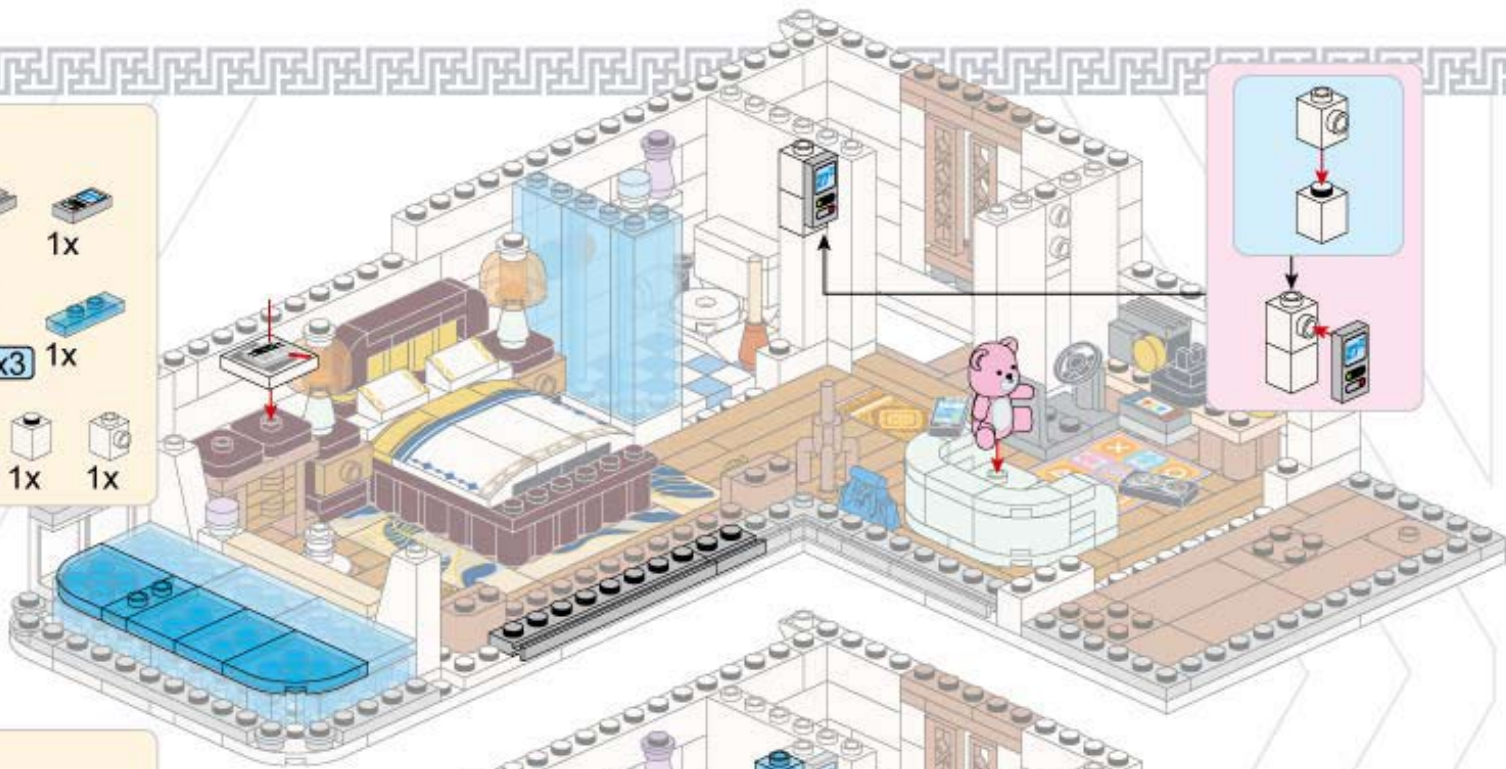

161

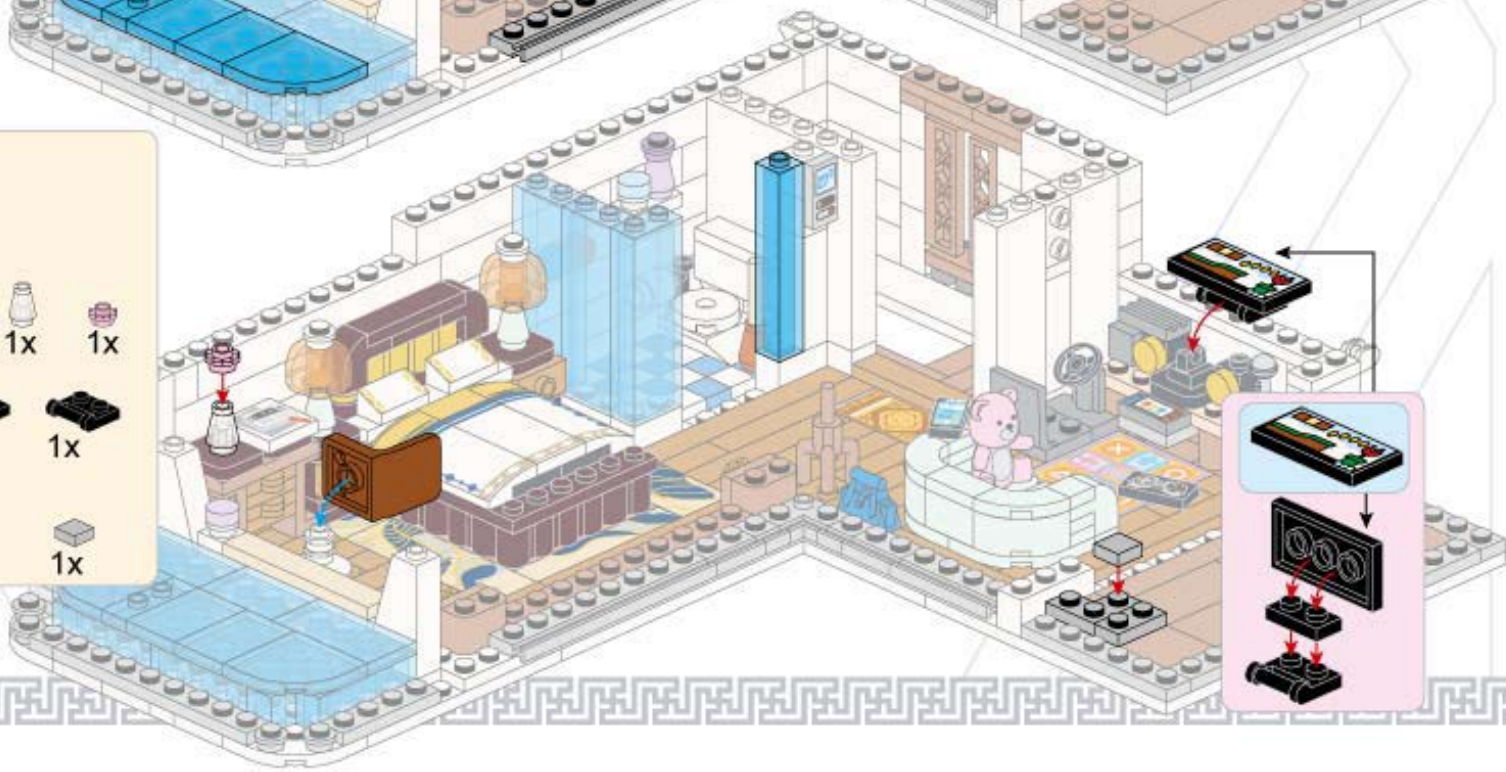

111

162

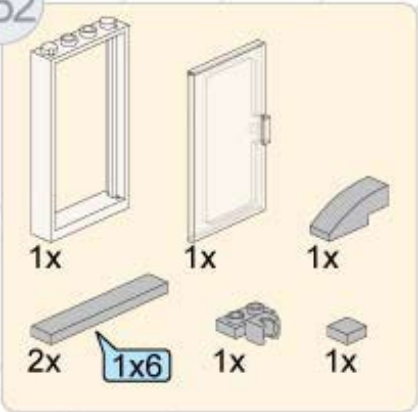

1x [1x6 Technic Beam] 1x [1x6 Technic Beam] 1x [Grey Technic Arch] 2x [Grey Technic Beam] 1x [Grey Technic Connector] 1x [Grey Technic Connector]

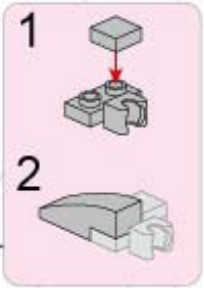
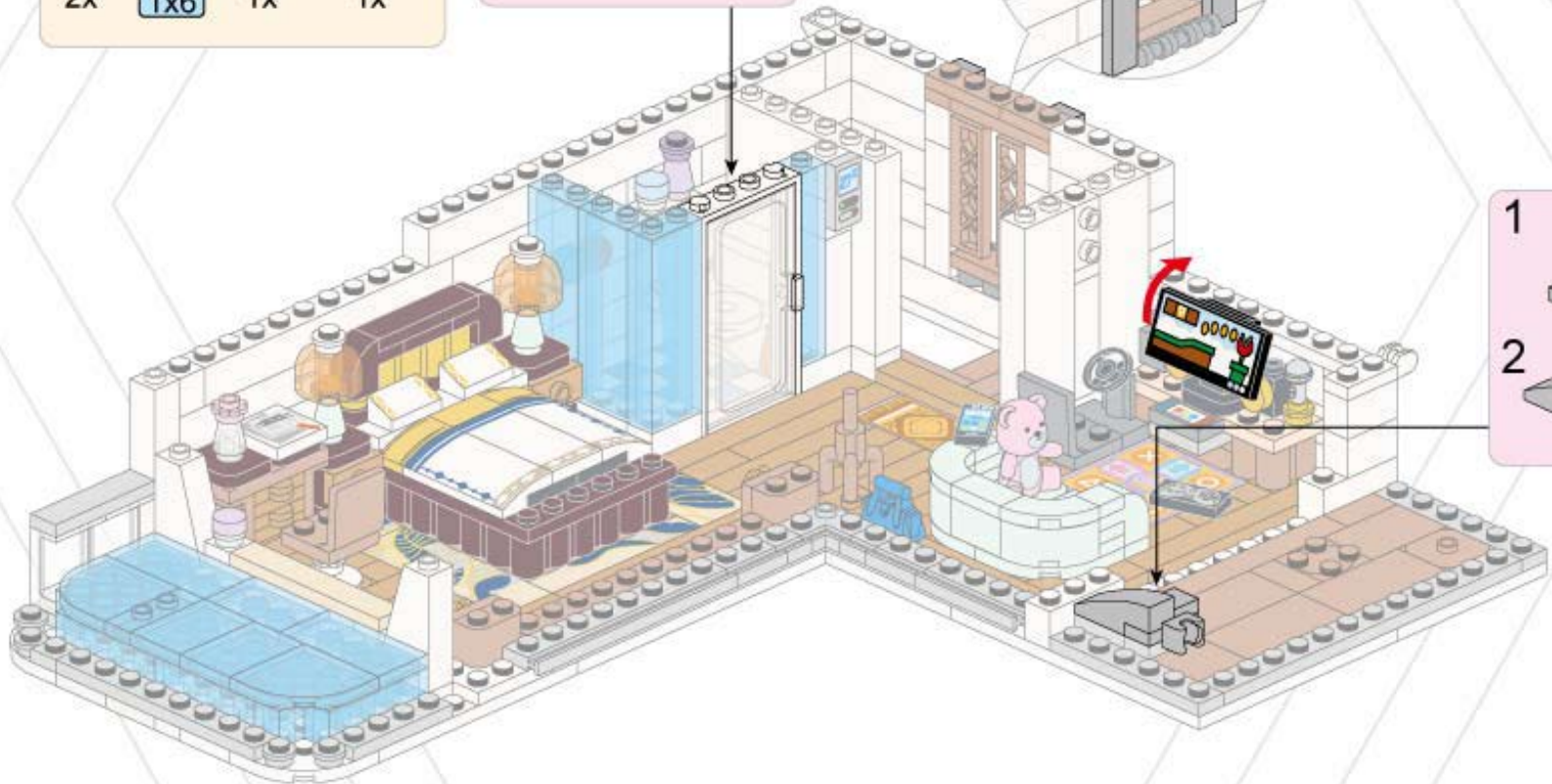
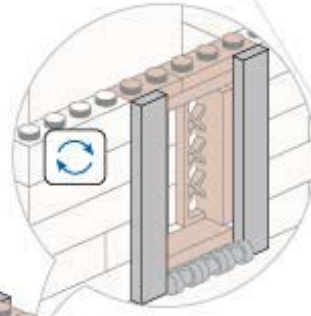
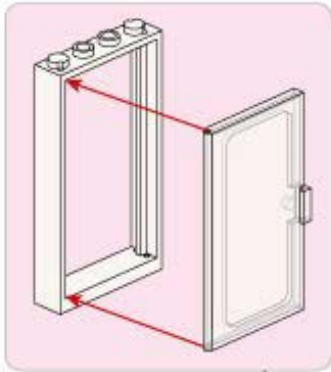



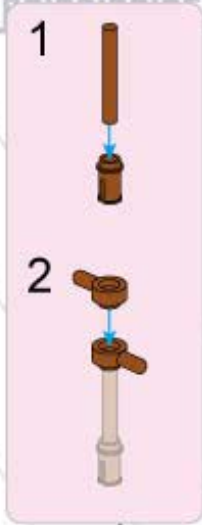



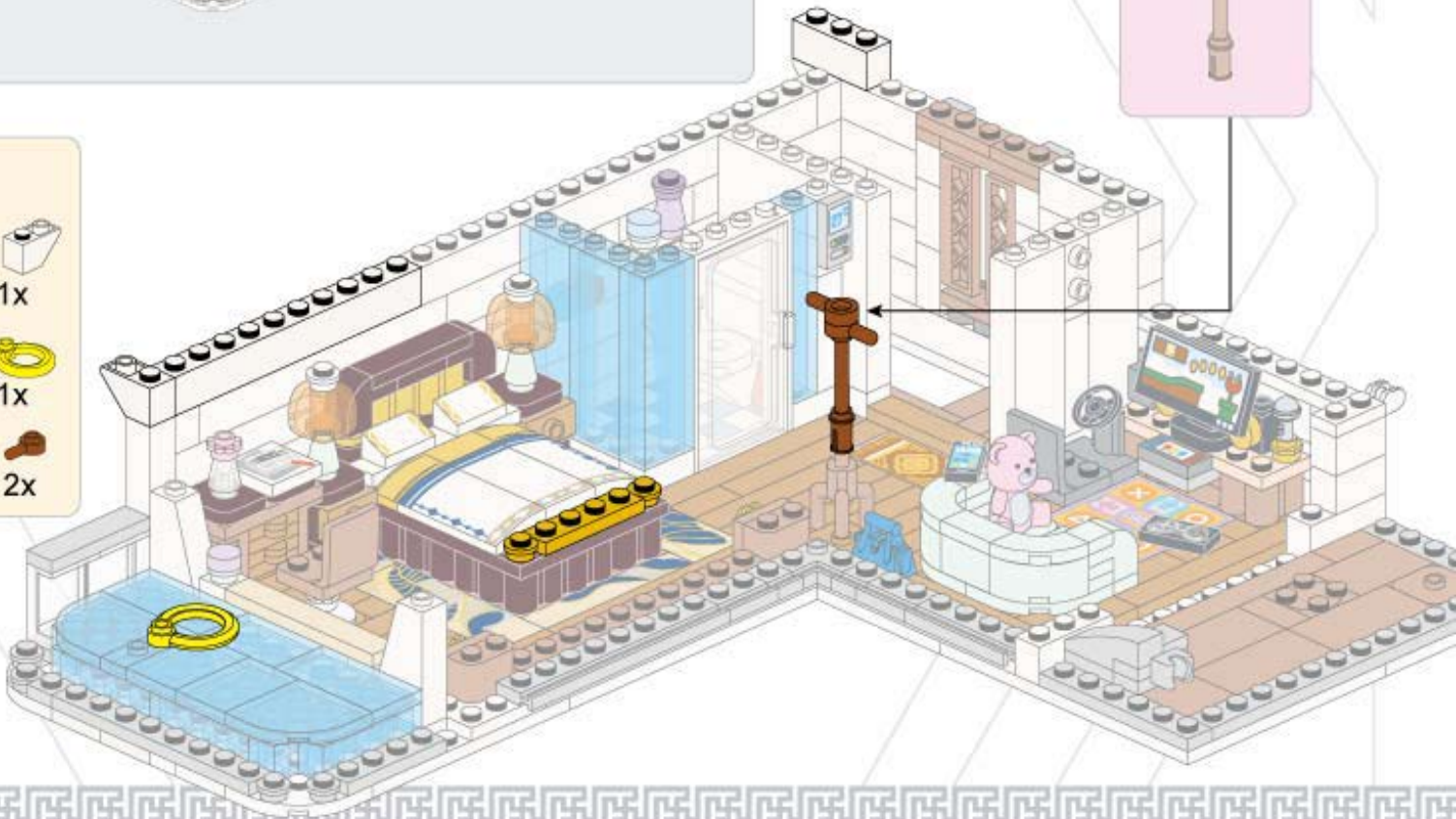
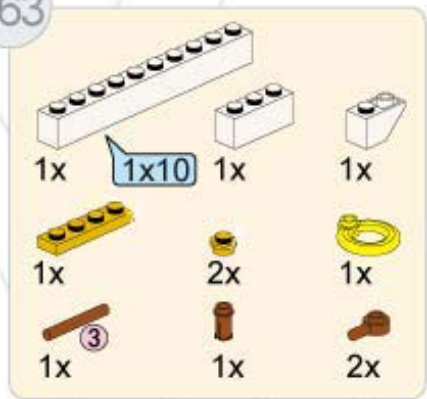



1 [Grey Technic Connector] on top of [Grey Technic Connector]
2 [Grey Technic Arch] on top of [Grey Technic Connector]



163







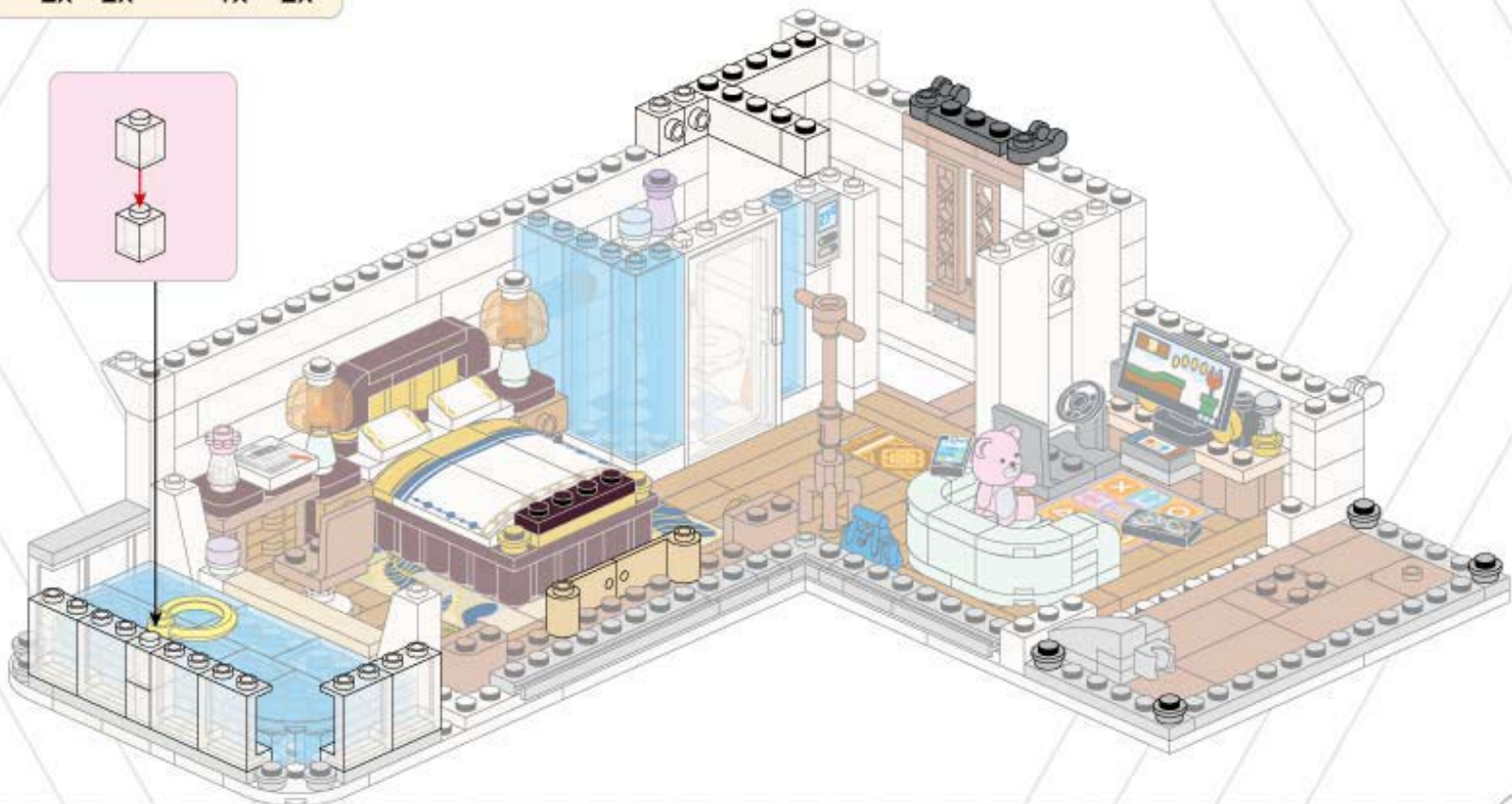
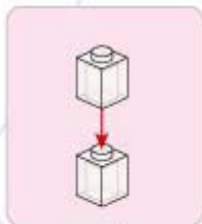



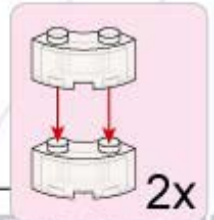
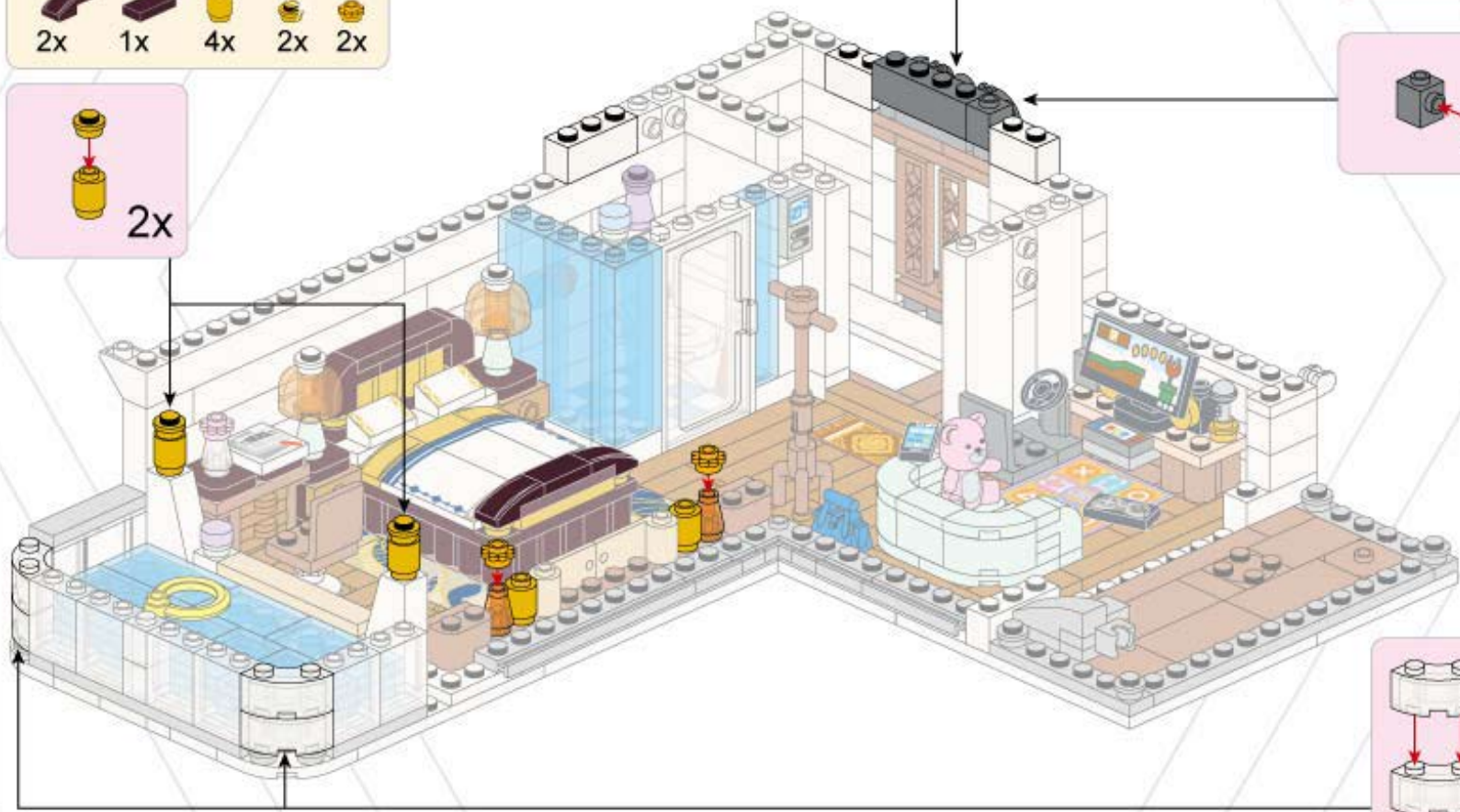
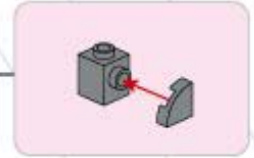
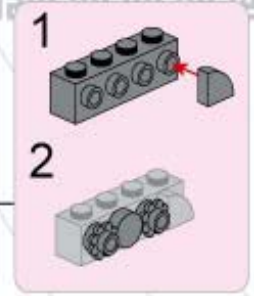

164

- | | | |
|---|---|---|
|  |  |  |
| 1x | 1x | 1x |
|  |  |  |
| 1x | 2x | 4x |
|  |  |  |
| 6x | 2x | 2x |
| |  |  |
| | 1x | 2x |



- 1x
- 1x
- 2x
- 2x
- 1x
- 1x
- 2x
- 4x
- 2x
- 2x
- 1x
- 4x
- 2x
- 2x



- 1x  1x  1x 
- 1x  2x  1x  2x 
- 2x  2x  1x 

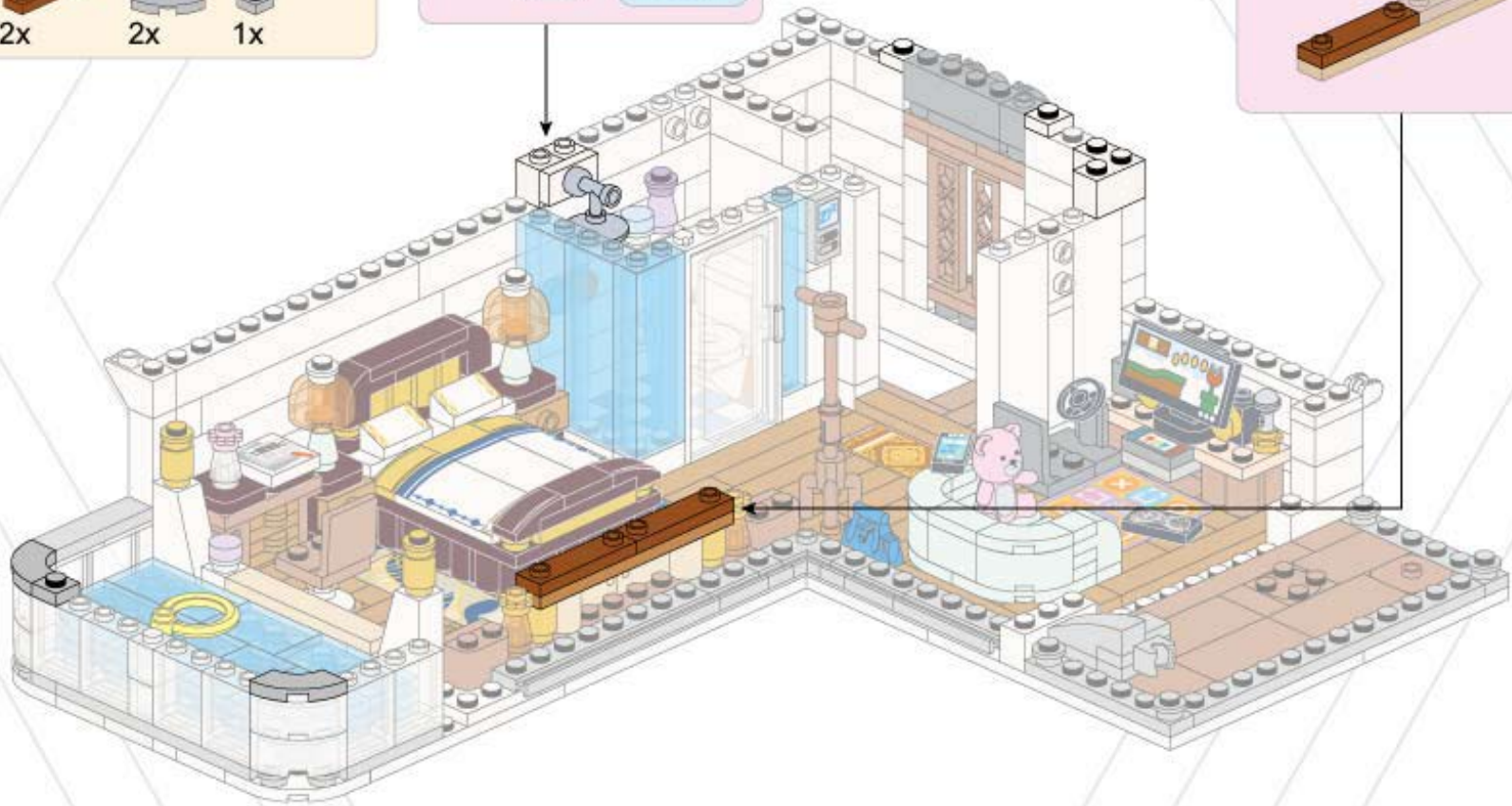
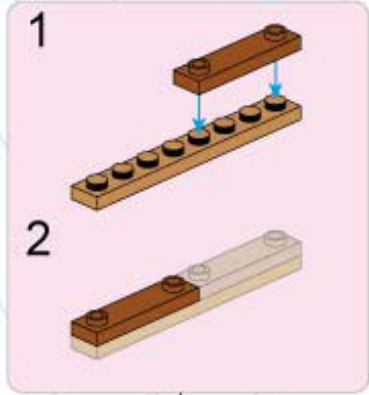
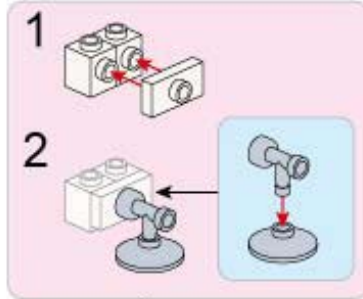

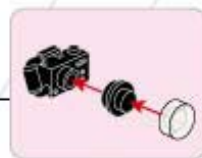
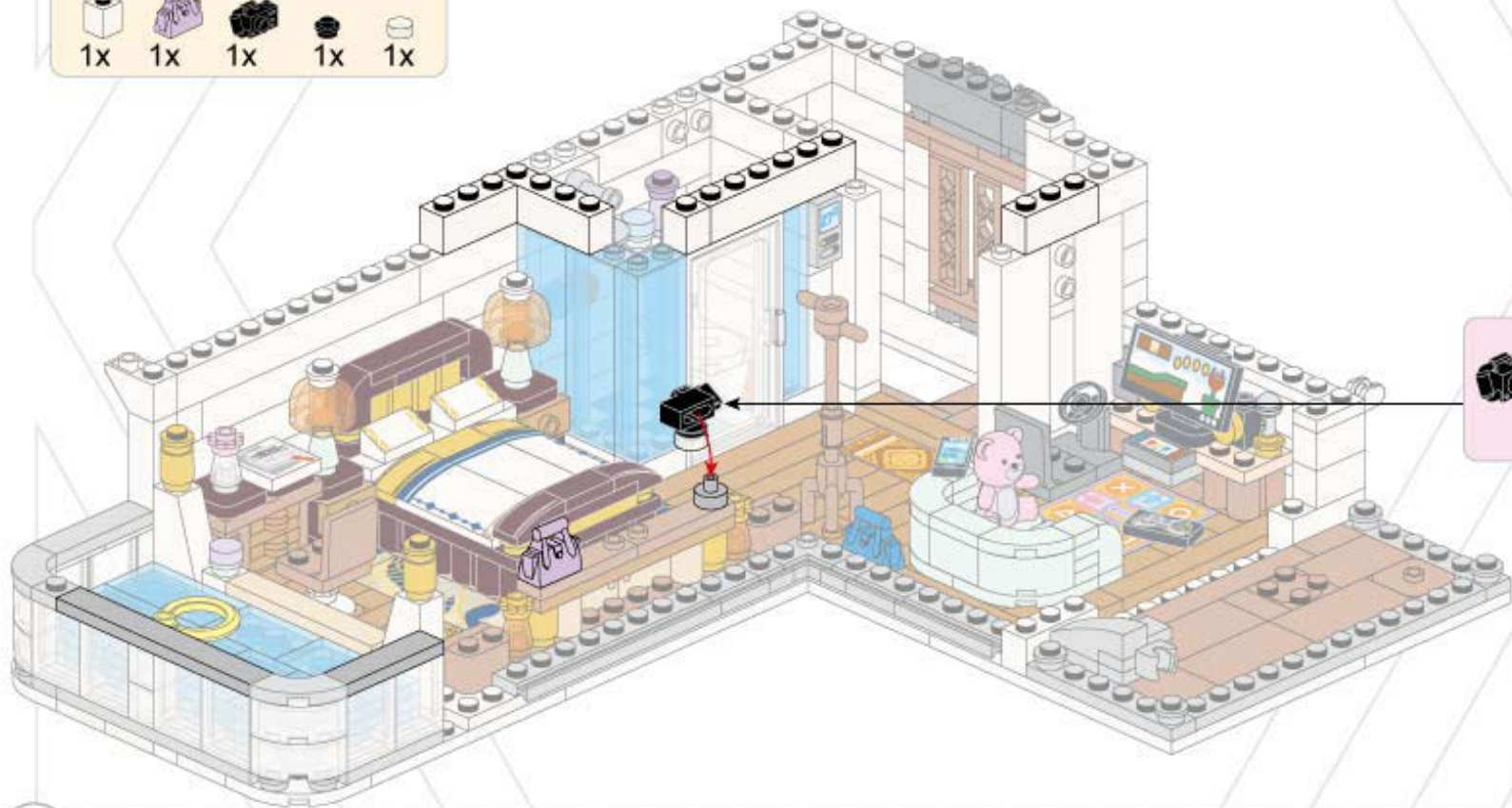
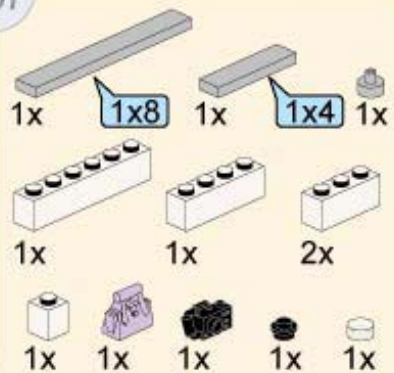

- | | | | |
|----|----|----|----|
| | | | |
| 2x | 2x | 4x | 2x |
| | | | |
| 2x | 2x | 1x | 4x |
| | | | |
| 1x | 2x | 1x | 1x |

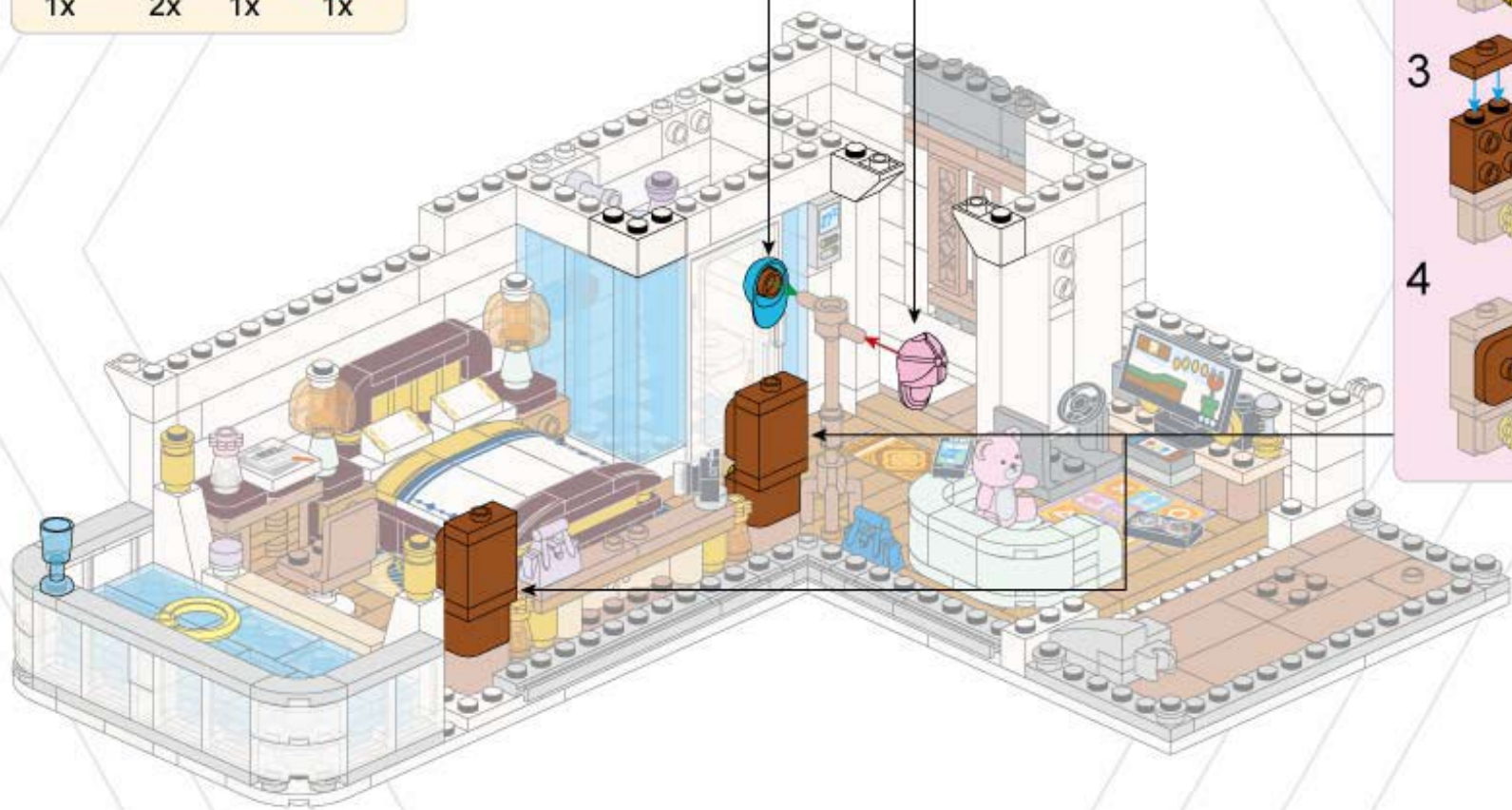

-
-
-
-

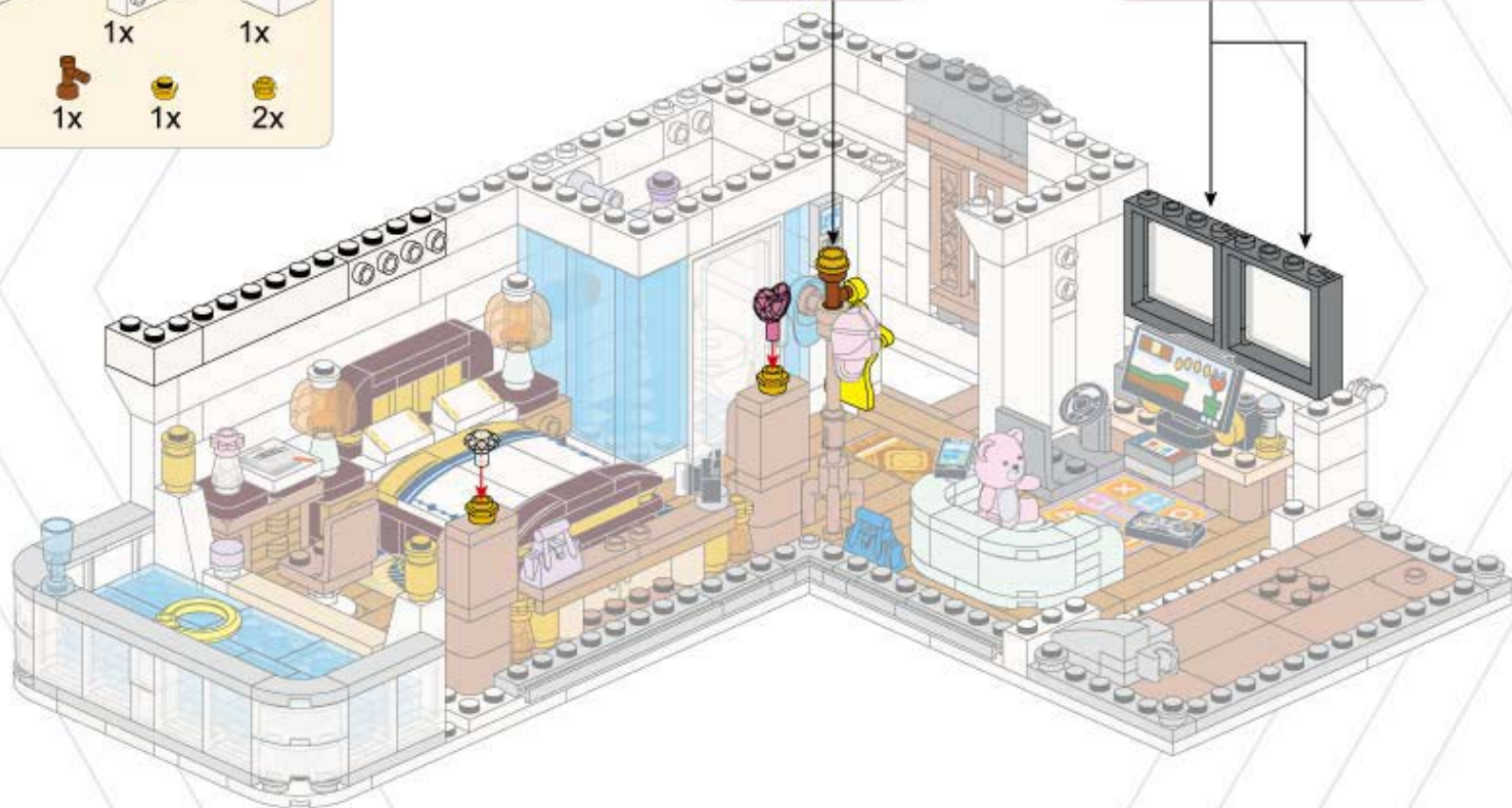
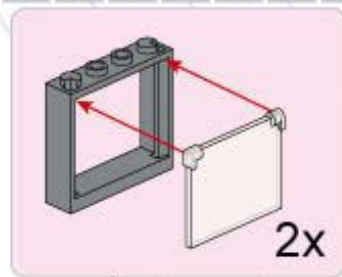

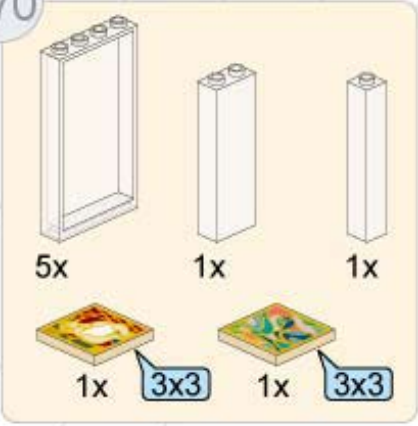

5x
1x
1x
1x
3x3
1x
3x3

This block lists the parts required for step 170. It includes five white 1x5 Technic bricks, one white 1x3 Technic brick, one white 1x2 Technic brick, one yellow 1x3 Technic plate with a red and blue pattern, one green 1x3 Technic plate with a red and blue pattern, and two blue 3x3 Technic plates.

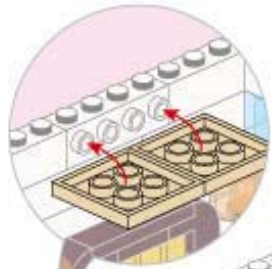

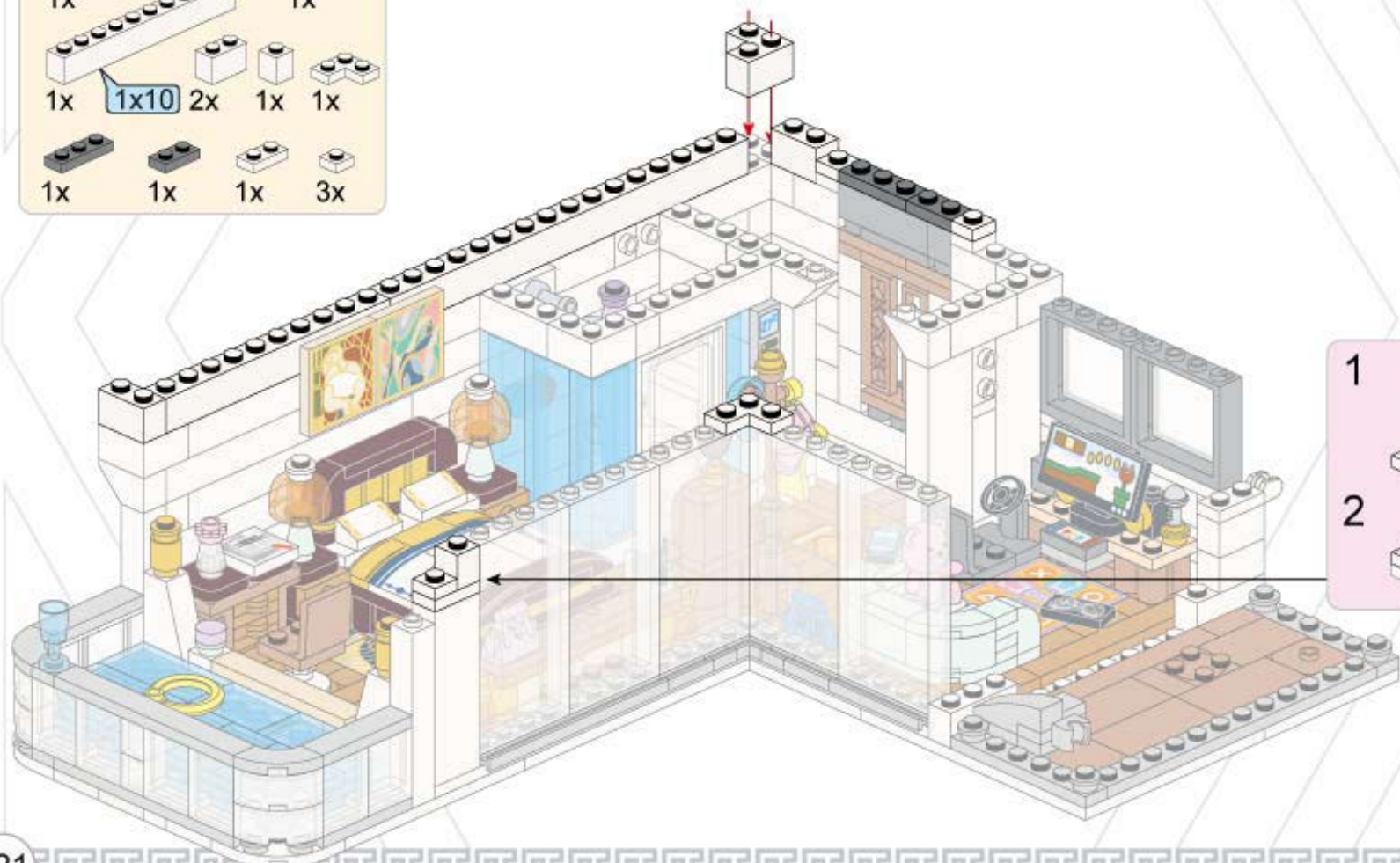
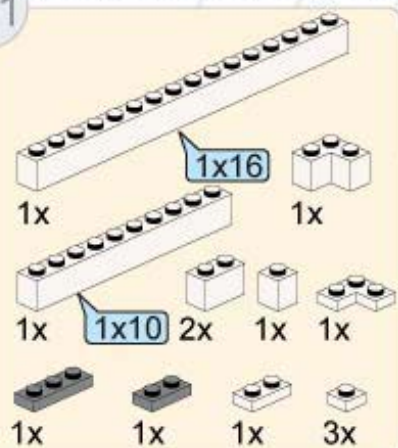

1



2



- 2x
- 1x
- 2x
- 1x
- 1x
- 2x
- 2x
- 1x
- 1x
- 4x
- 2x

- 1
- 2
- 3
- 4
- 5

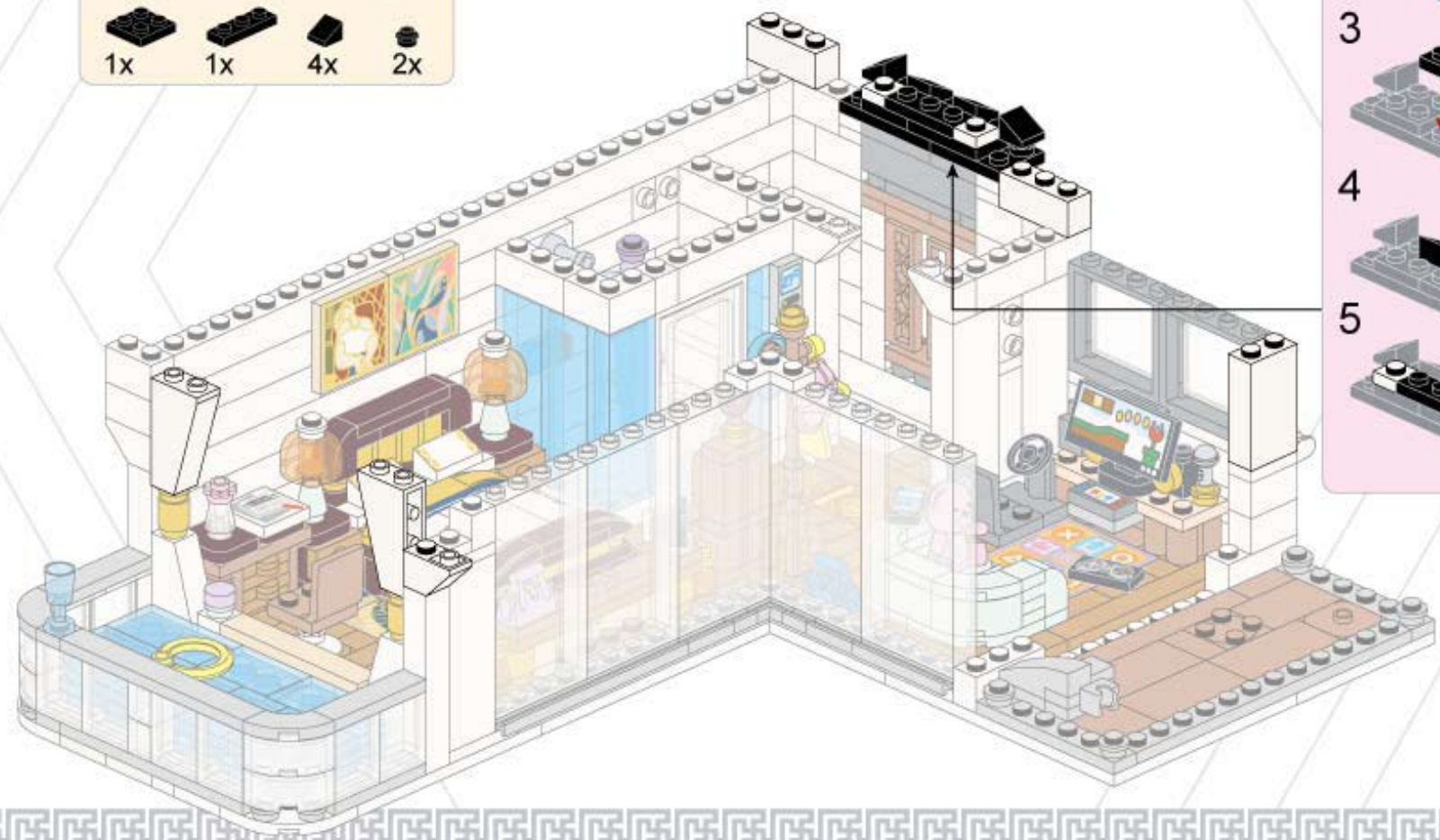

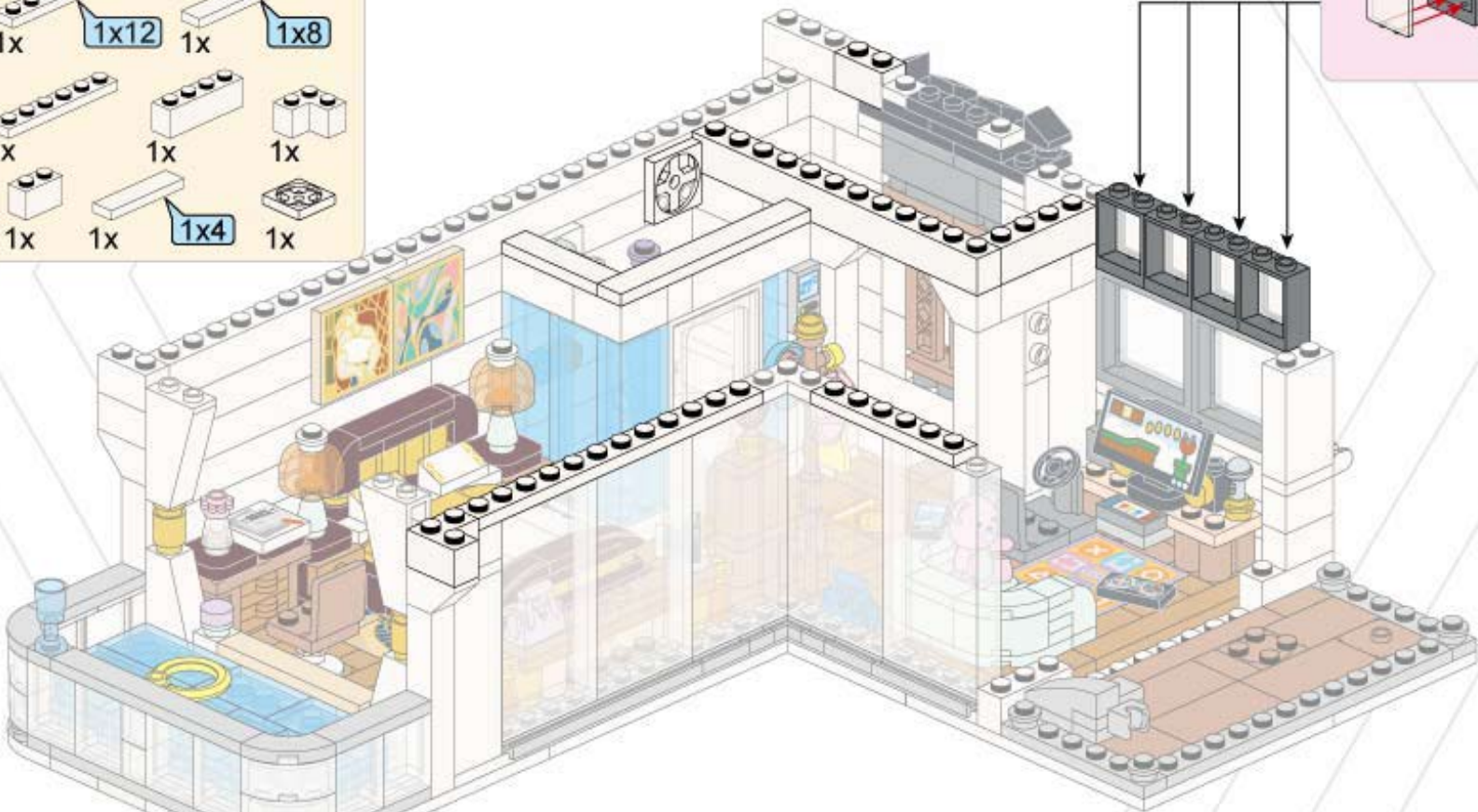
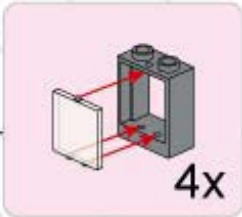
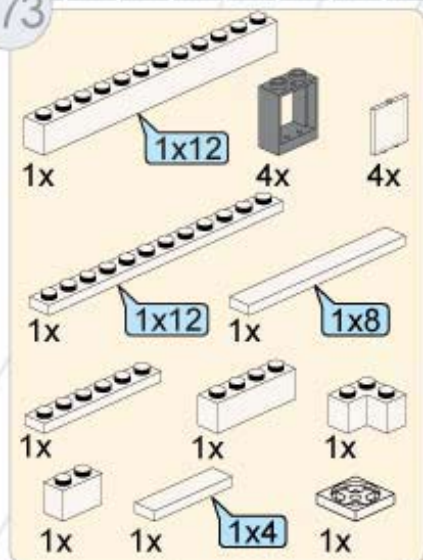

174

- 2x
- 1x
- 1x
- 1x
- 2x
- 2x
- 1x
- 2x

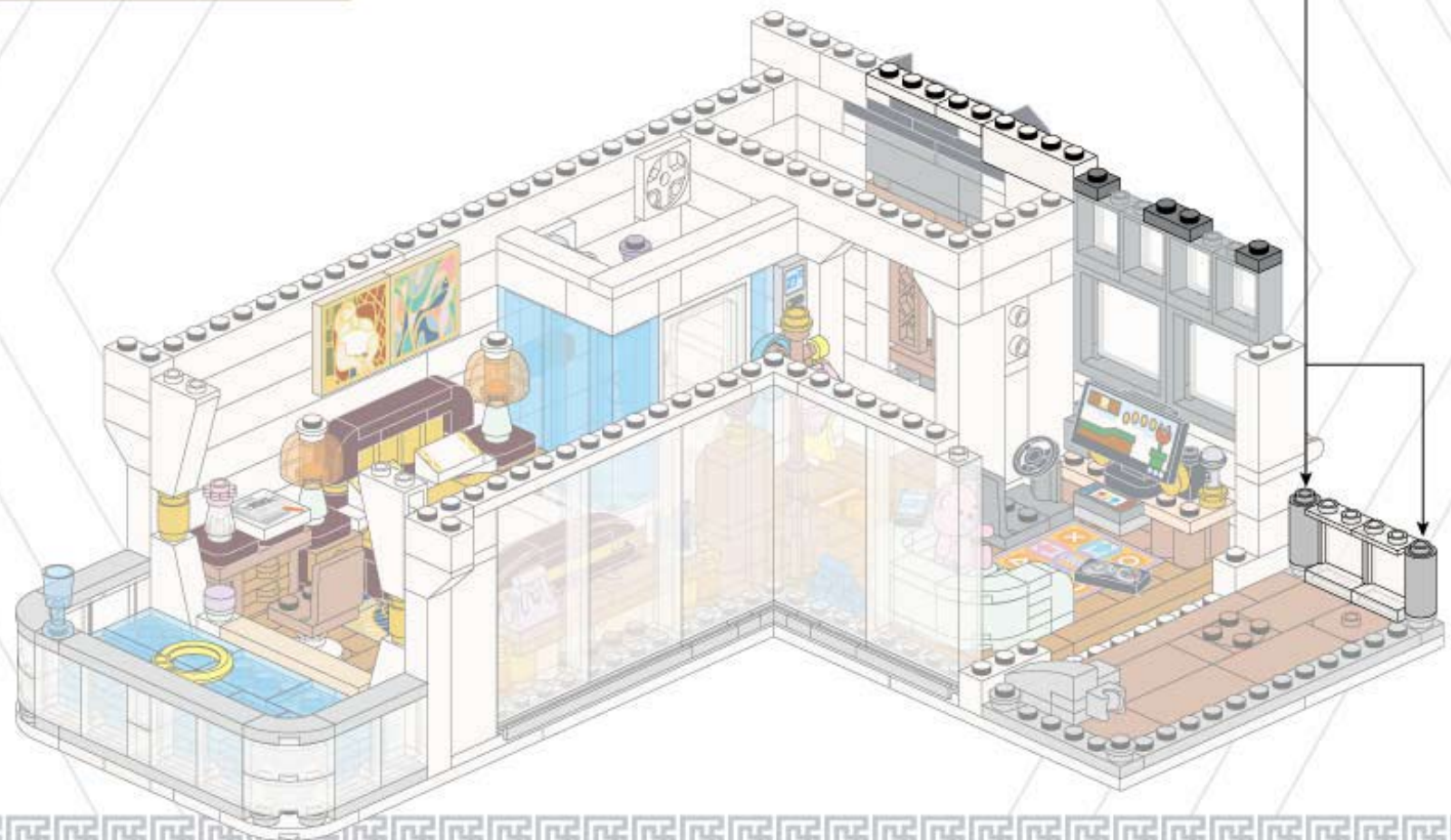
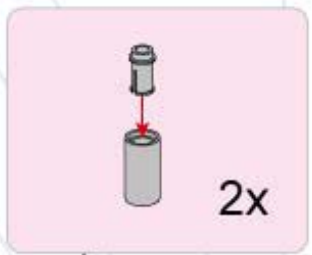

124

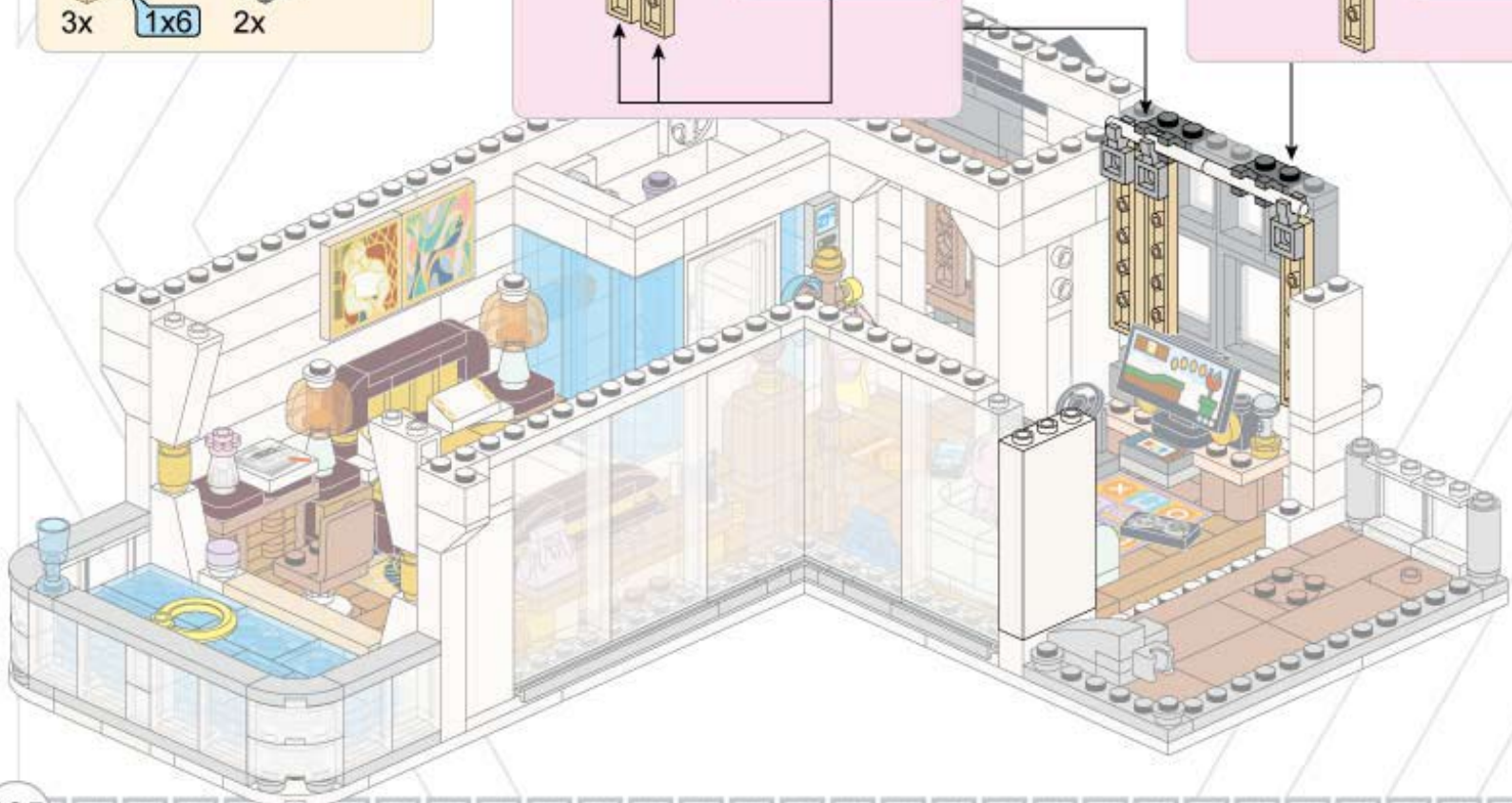
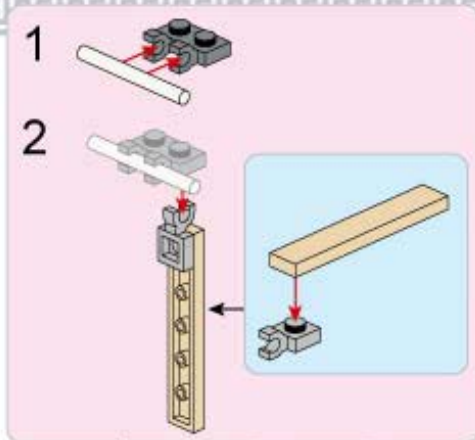
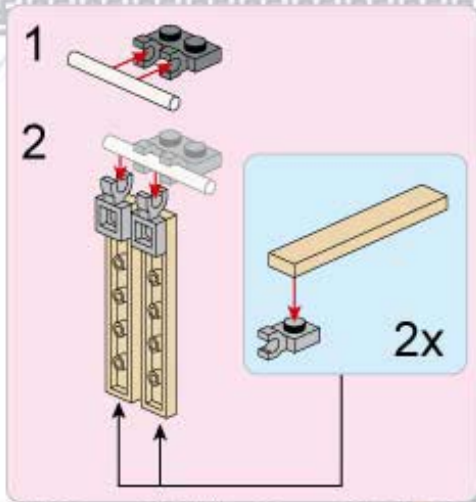
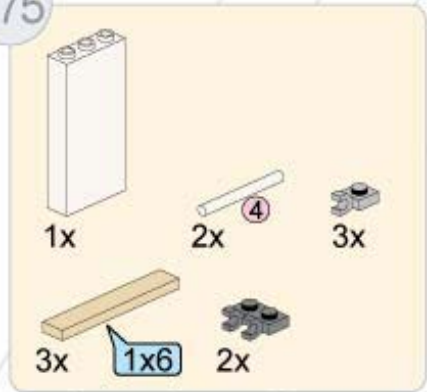

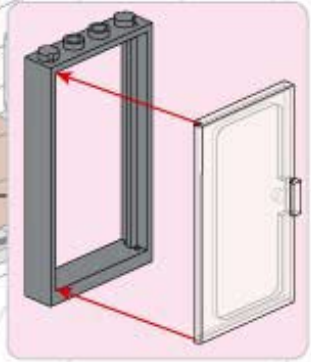
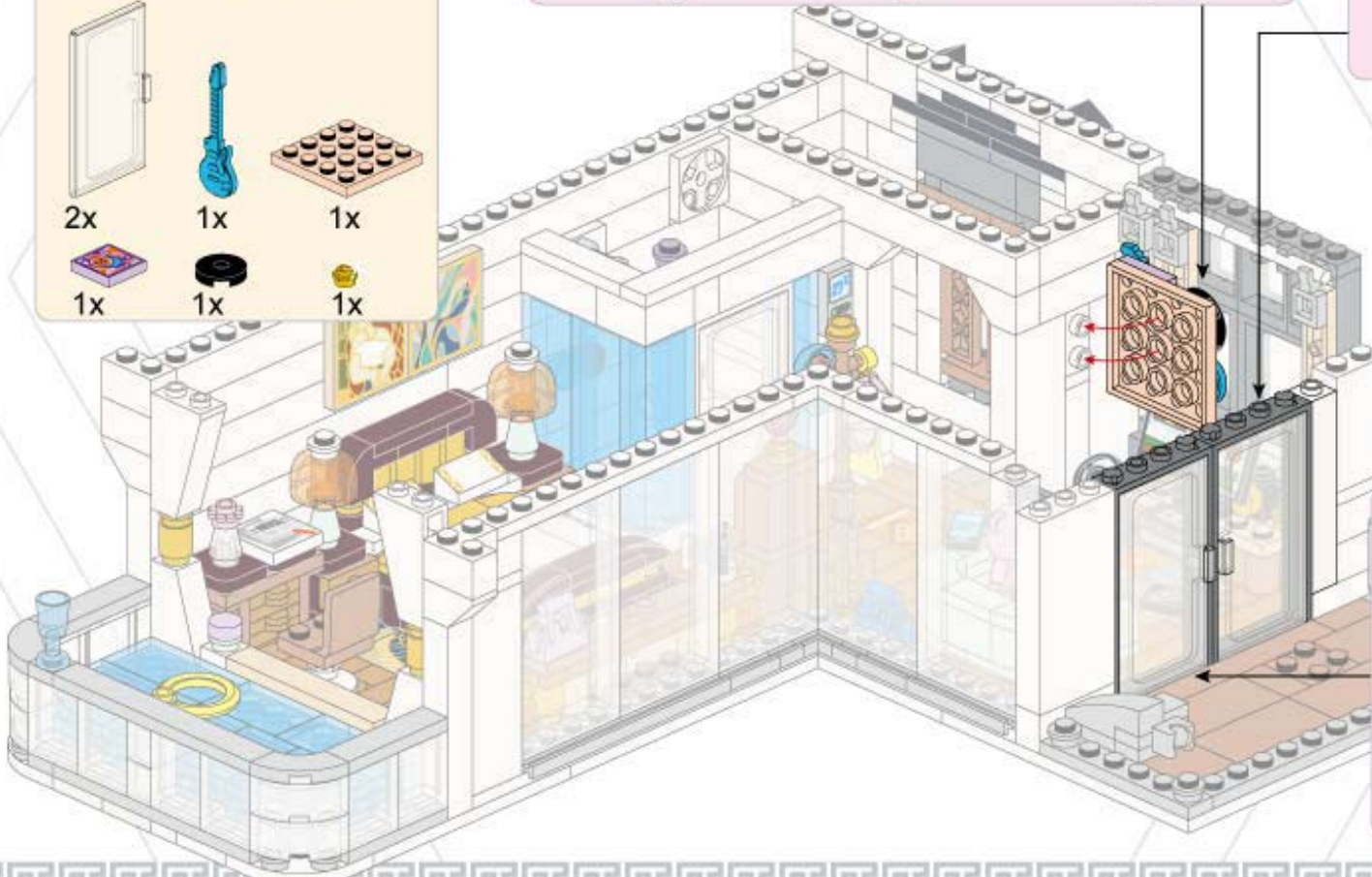
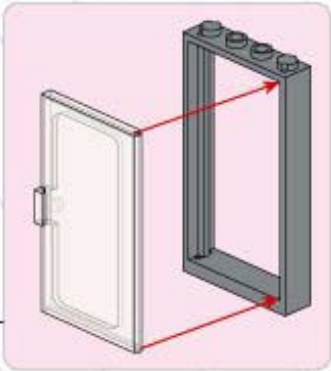
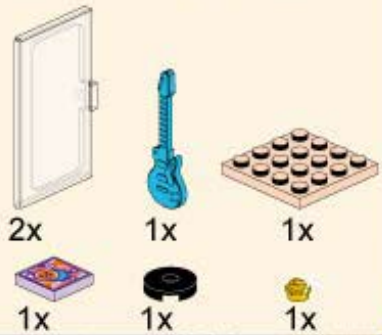
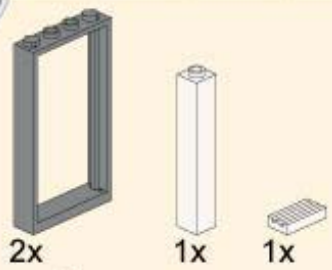

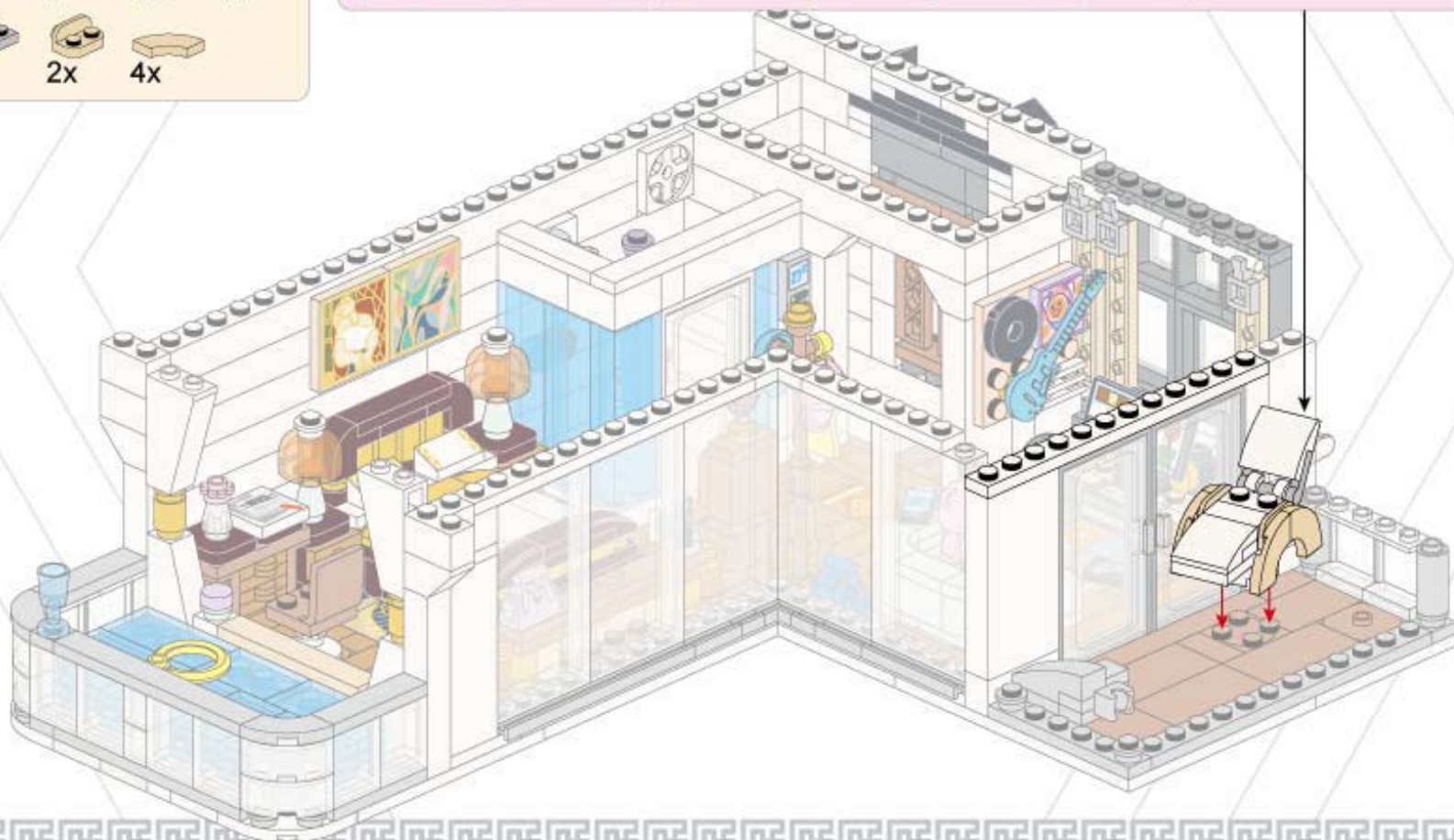
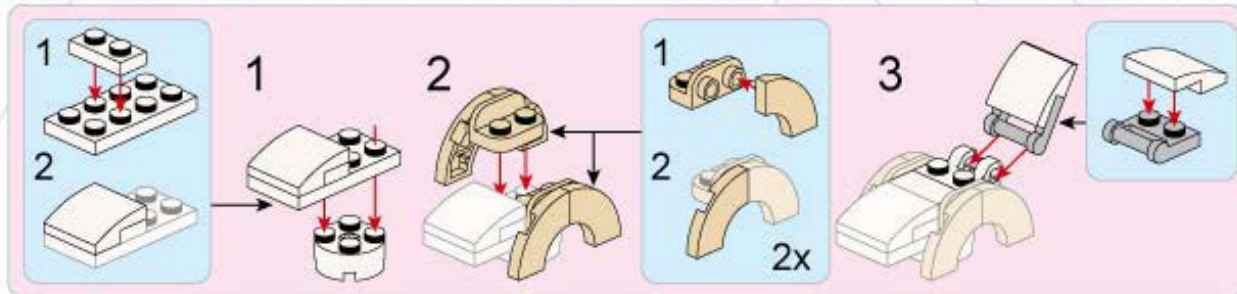
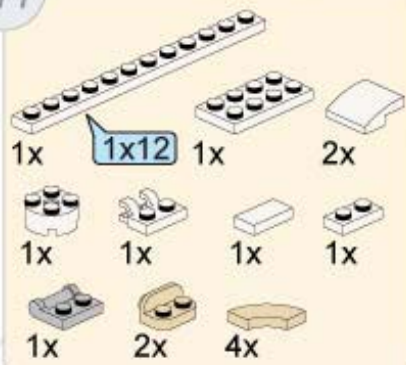



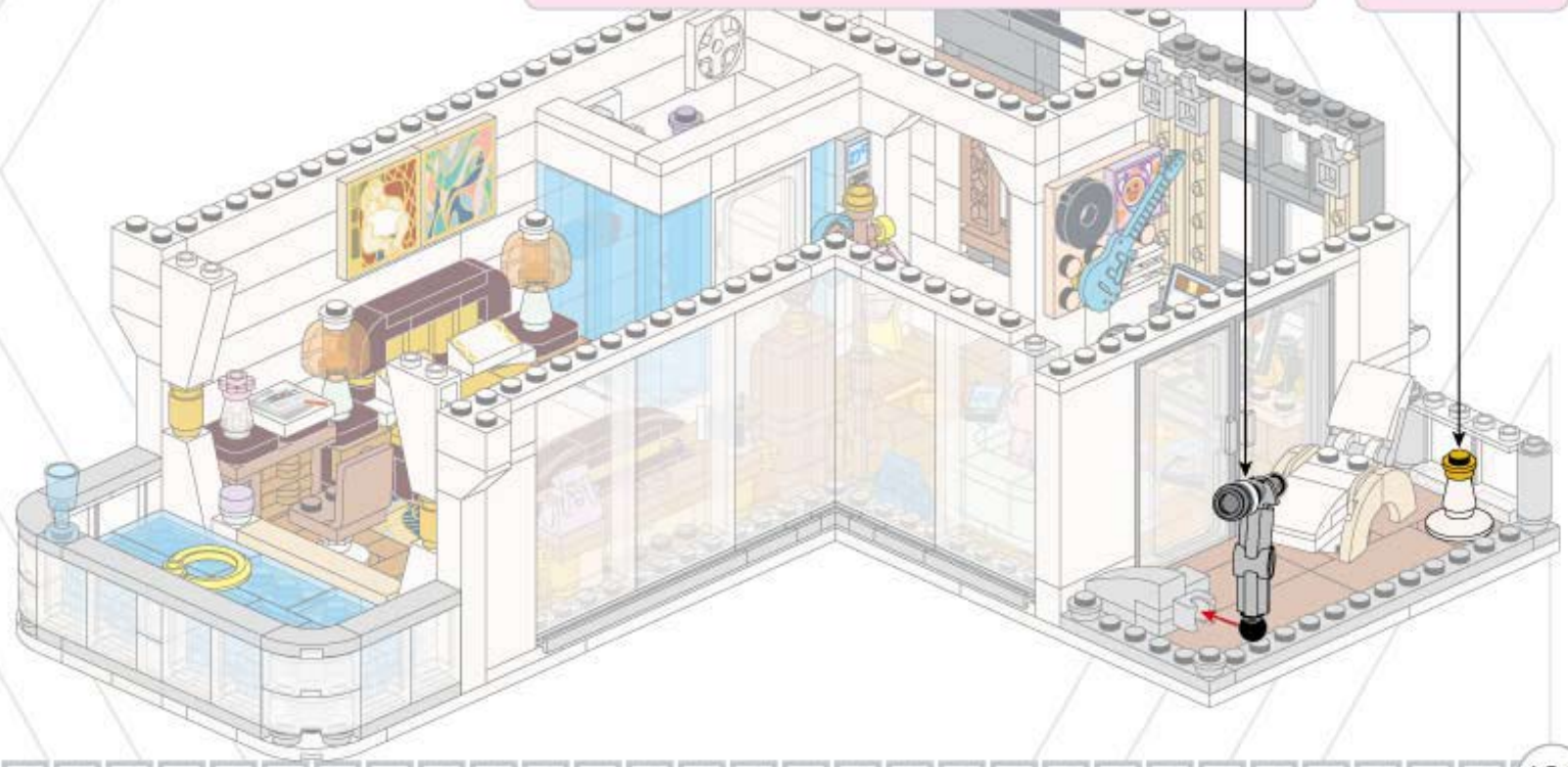
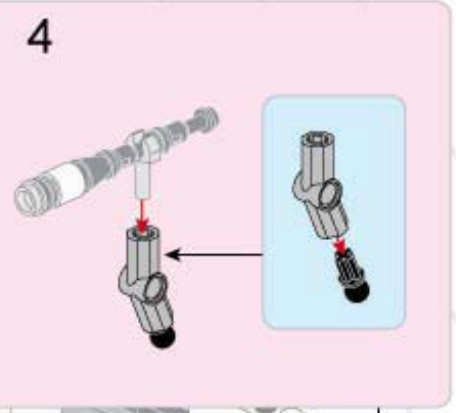
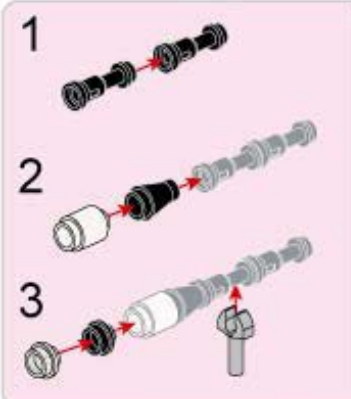

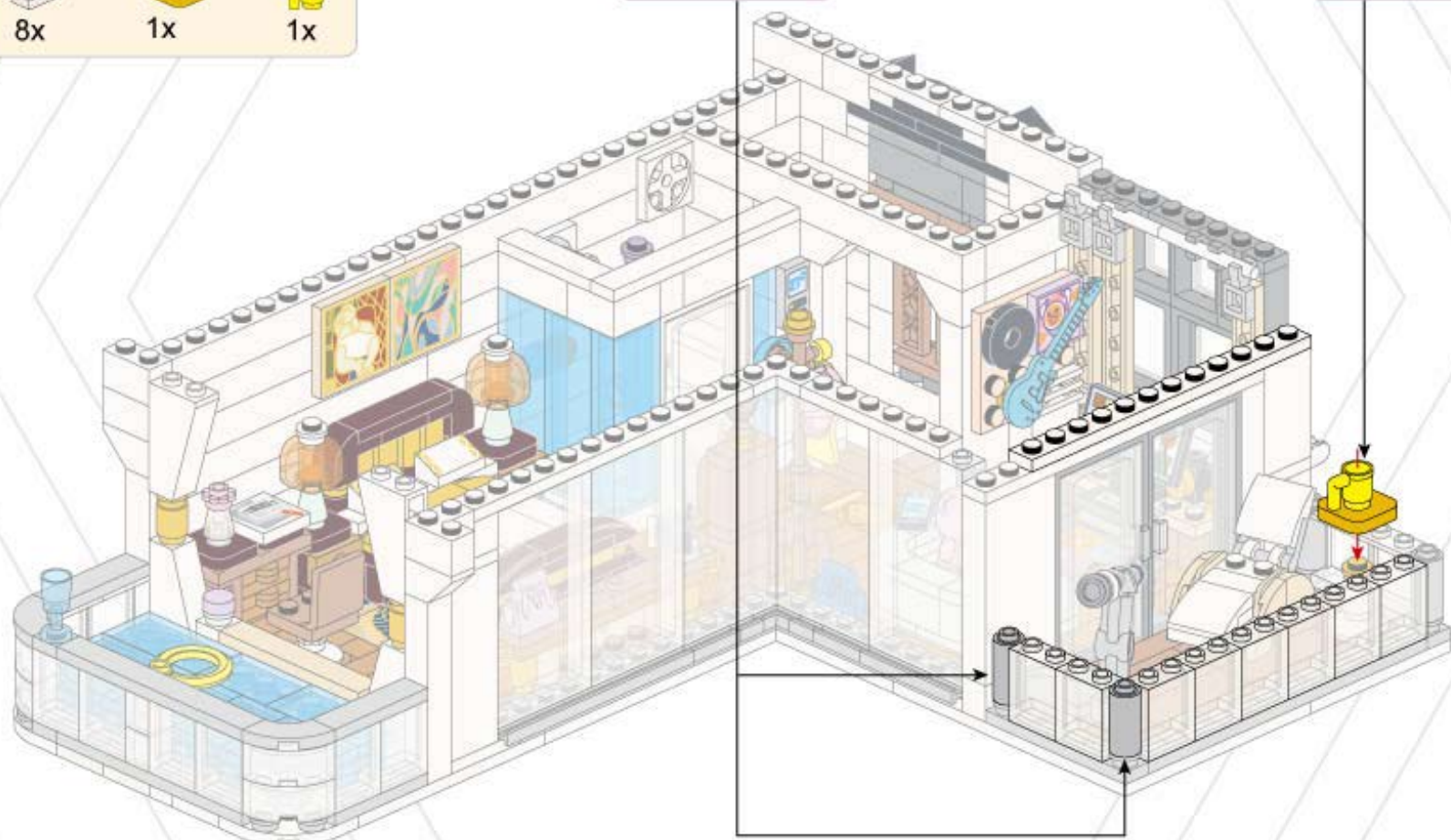
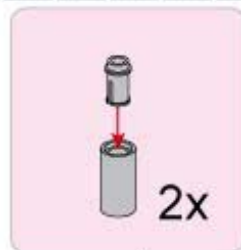
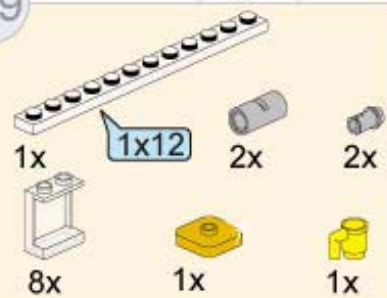

- 157°
- 1x 
 - 1x 
 - 1x 
 - 1x 
 - 1x 
 - 1x 
 - 1x 
 - 2x 
 - 1x 
 - 1x 
 - 1x 





- 1x 
- 3x 
- 2x 
- 1x 
- 1x 

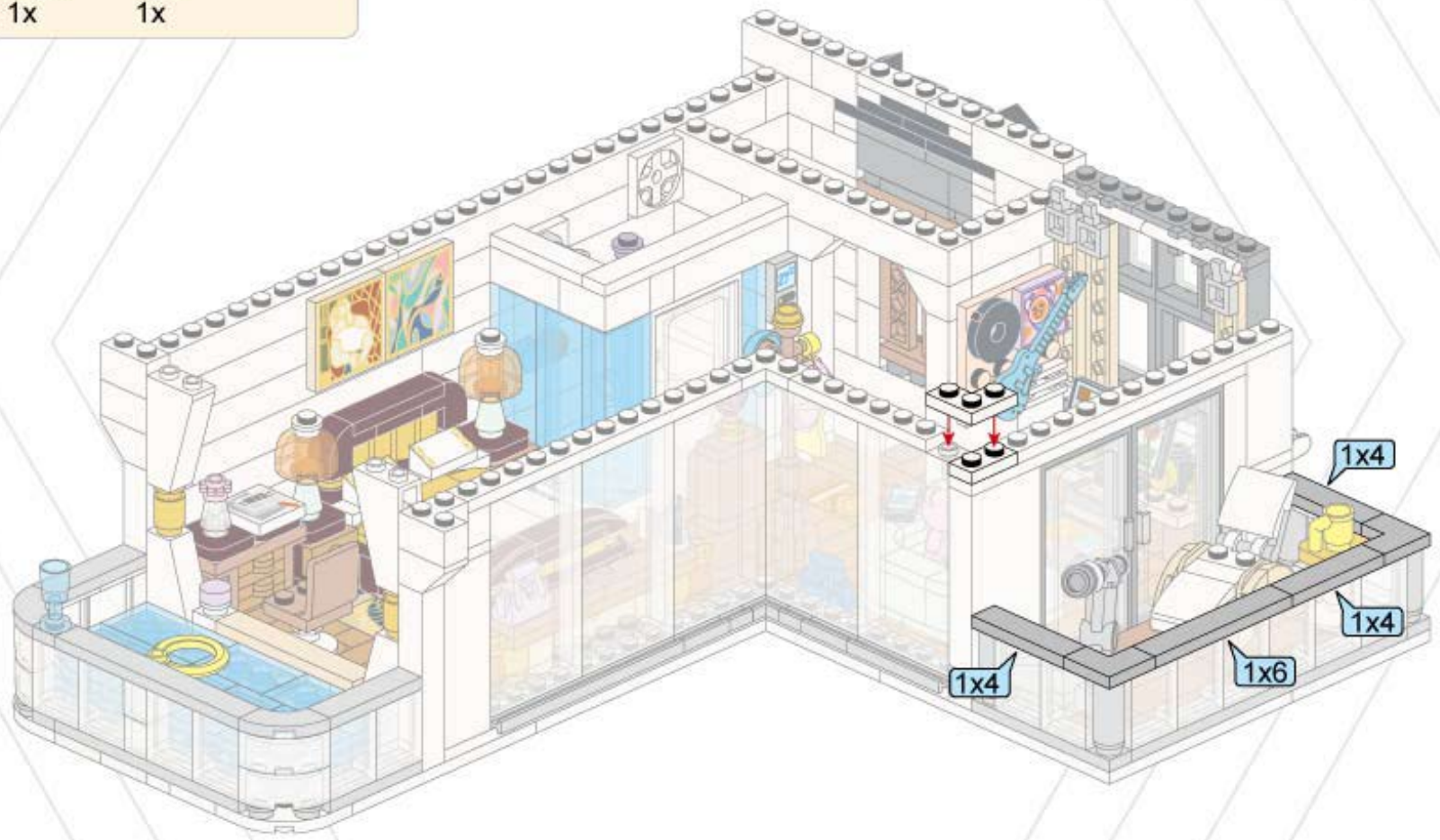



181

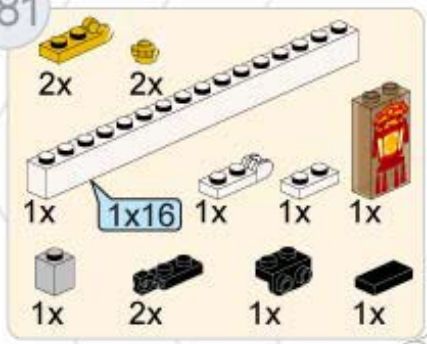



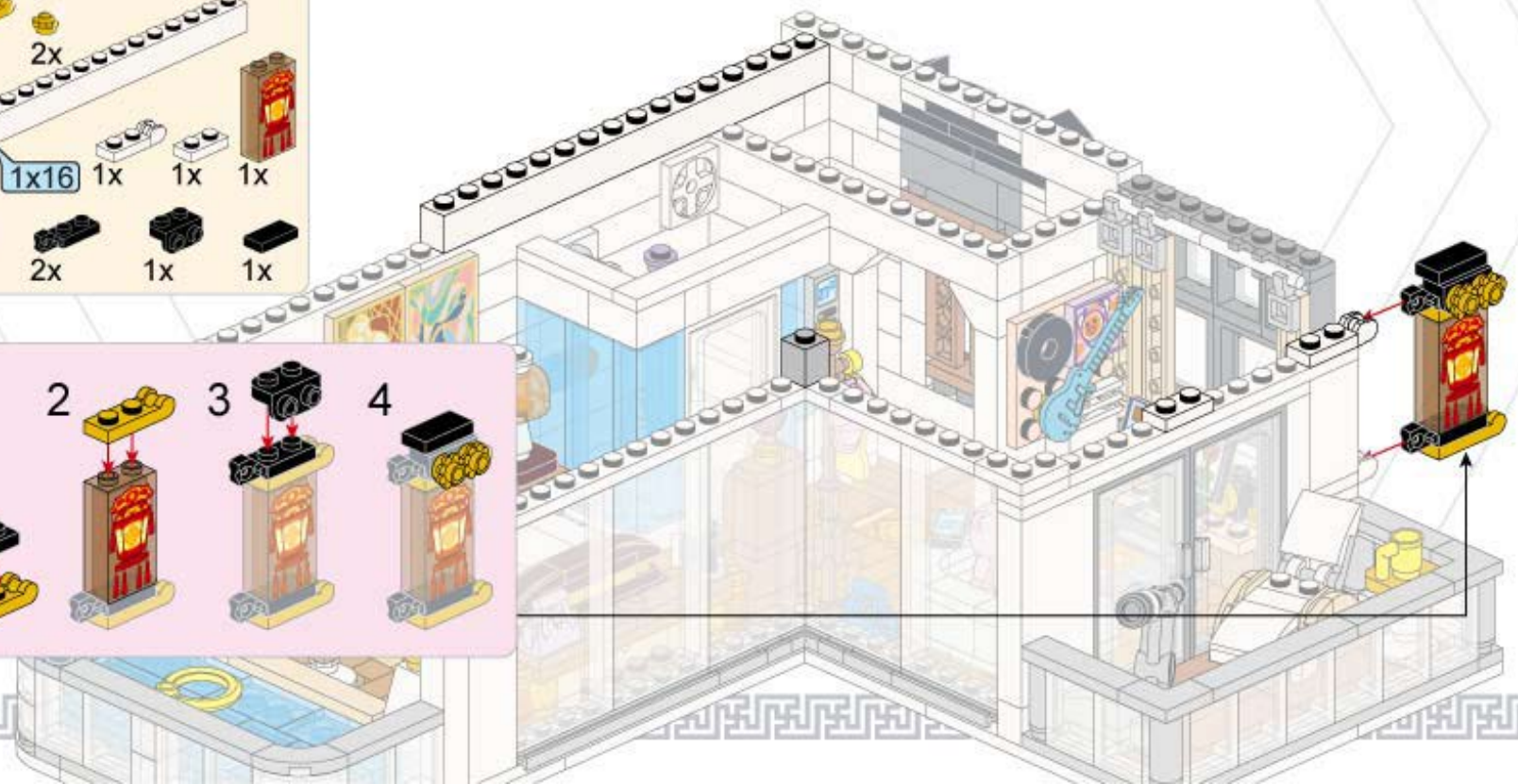



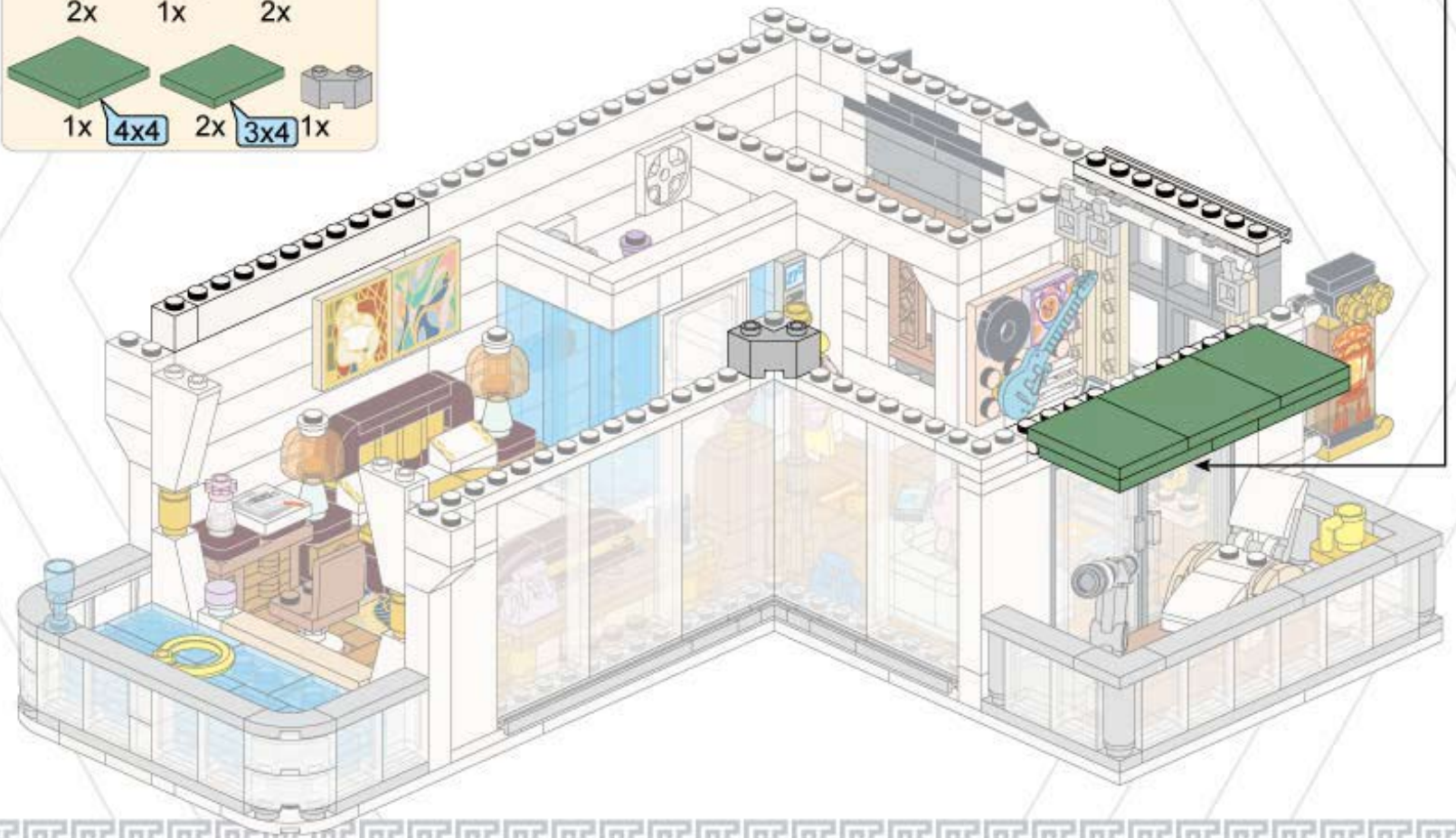
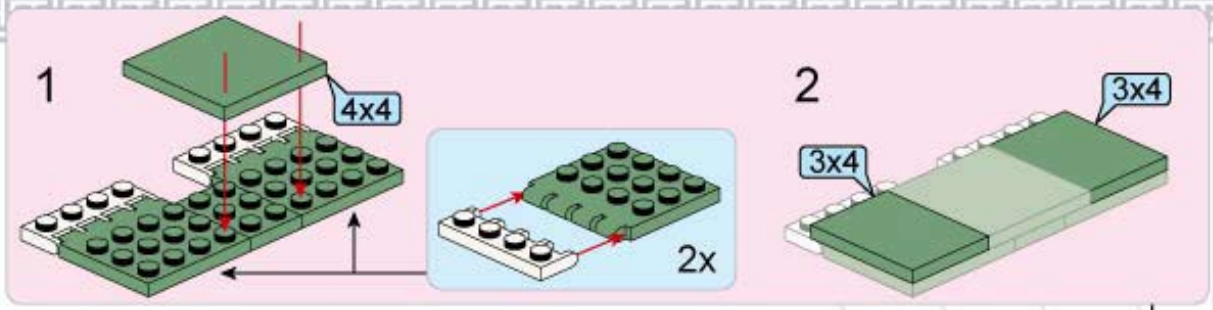

131



- 1x 1x10
- 1x
- 1x
- 2x
- 1x
- 2x
- 1x 4x4
- 2x 3x4
- 1x



- 2x  1x  1x 
- 1x  6x  1x  3x  1x  2x 

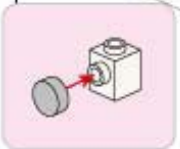
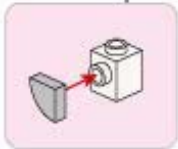
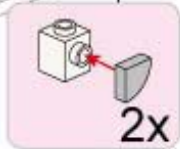
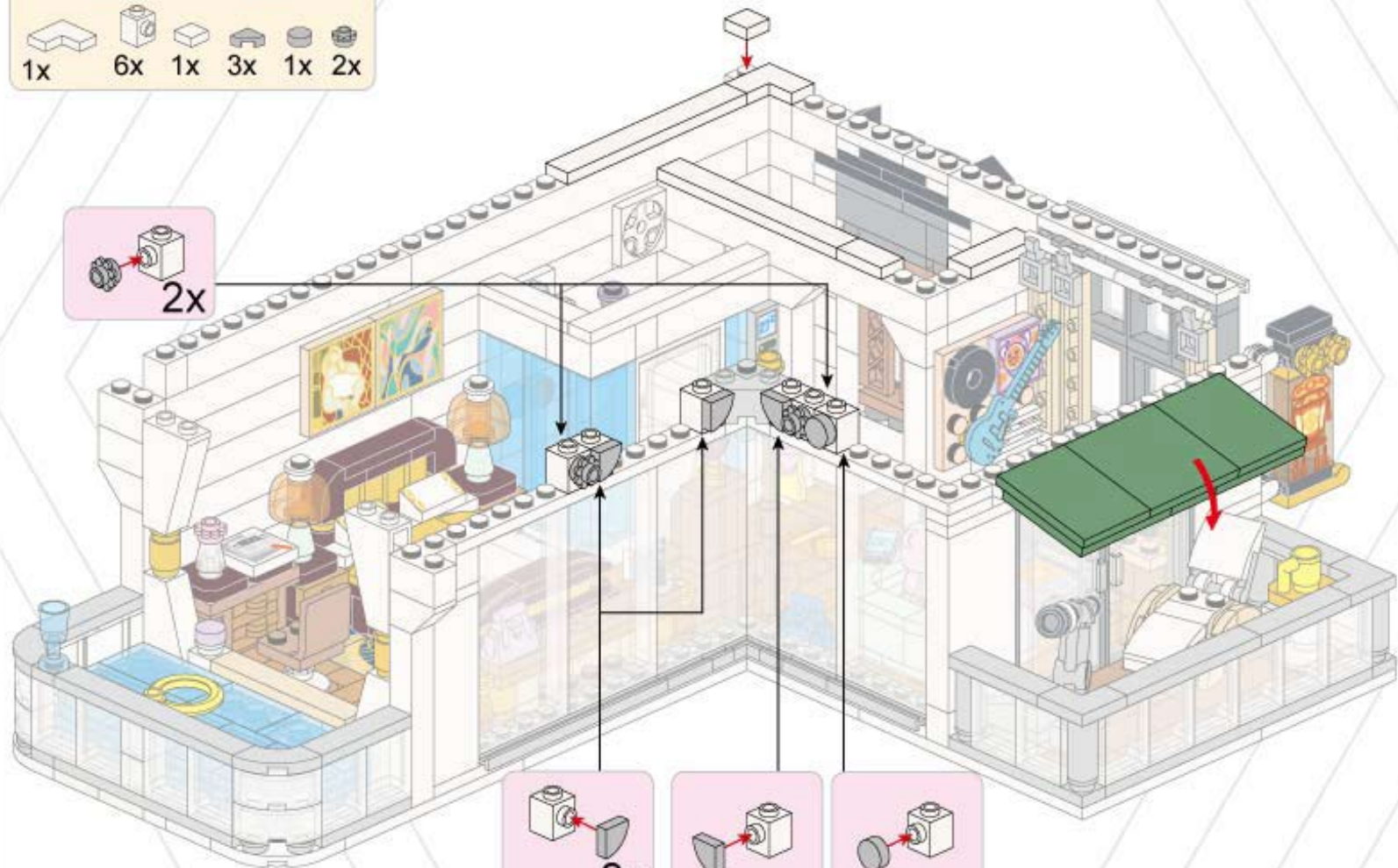
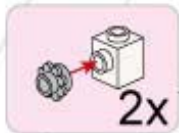

1x 1x14 3x 1x 2x 3x 2x 2x 2x

1

2









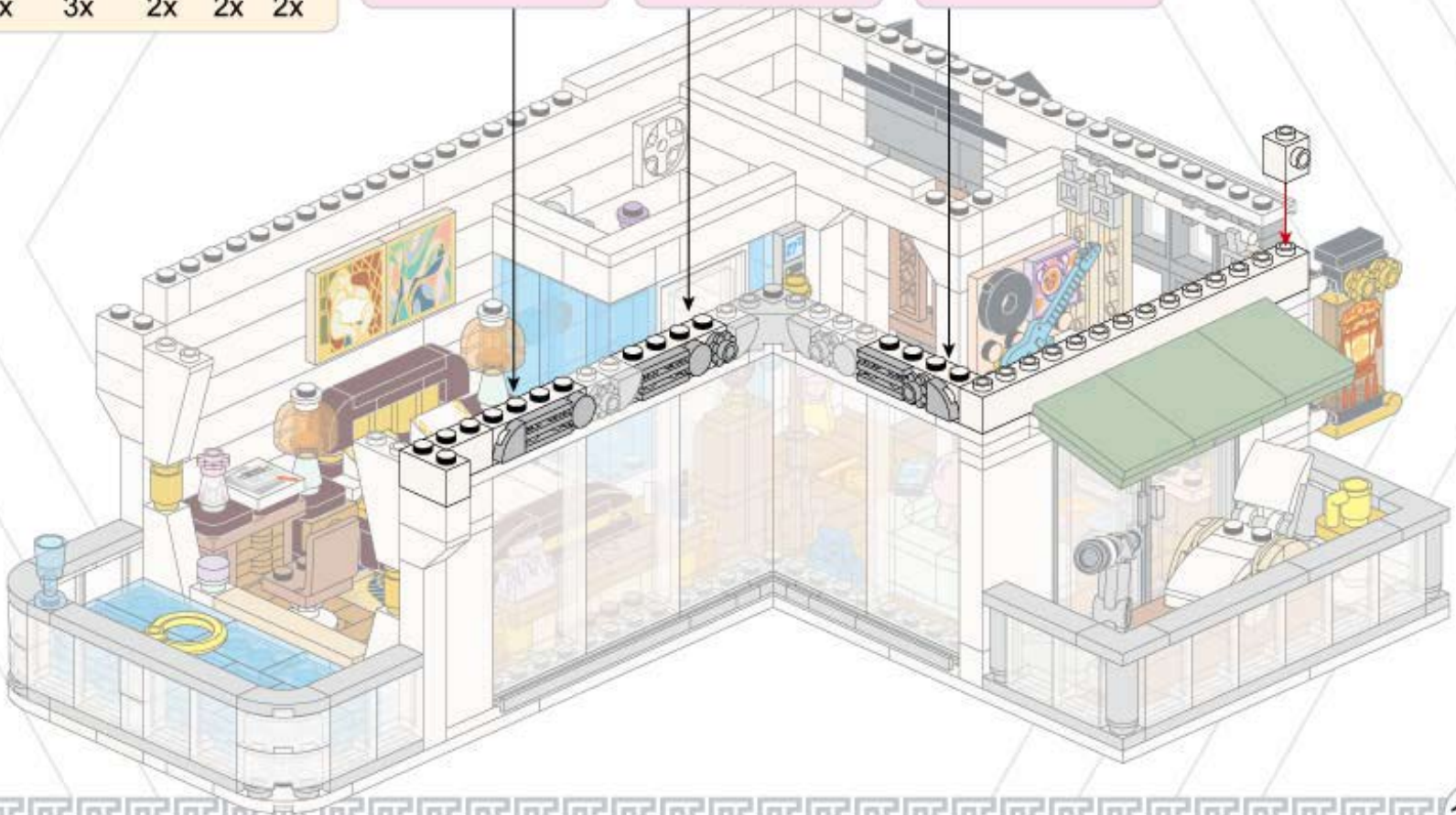

1

2

1

2



- 2x  1x8  3x  4x
- 1x  1x  1x  1x 
- 2x  2x  2x 

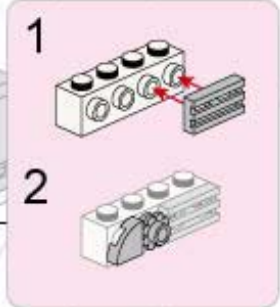
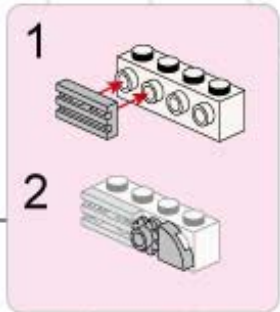

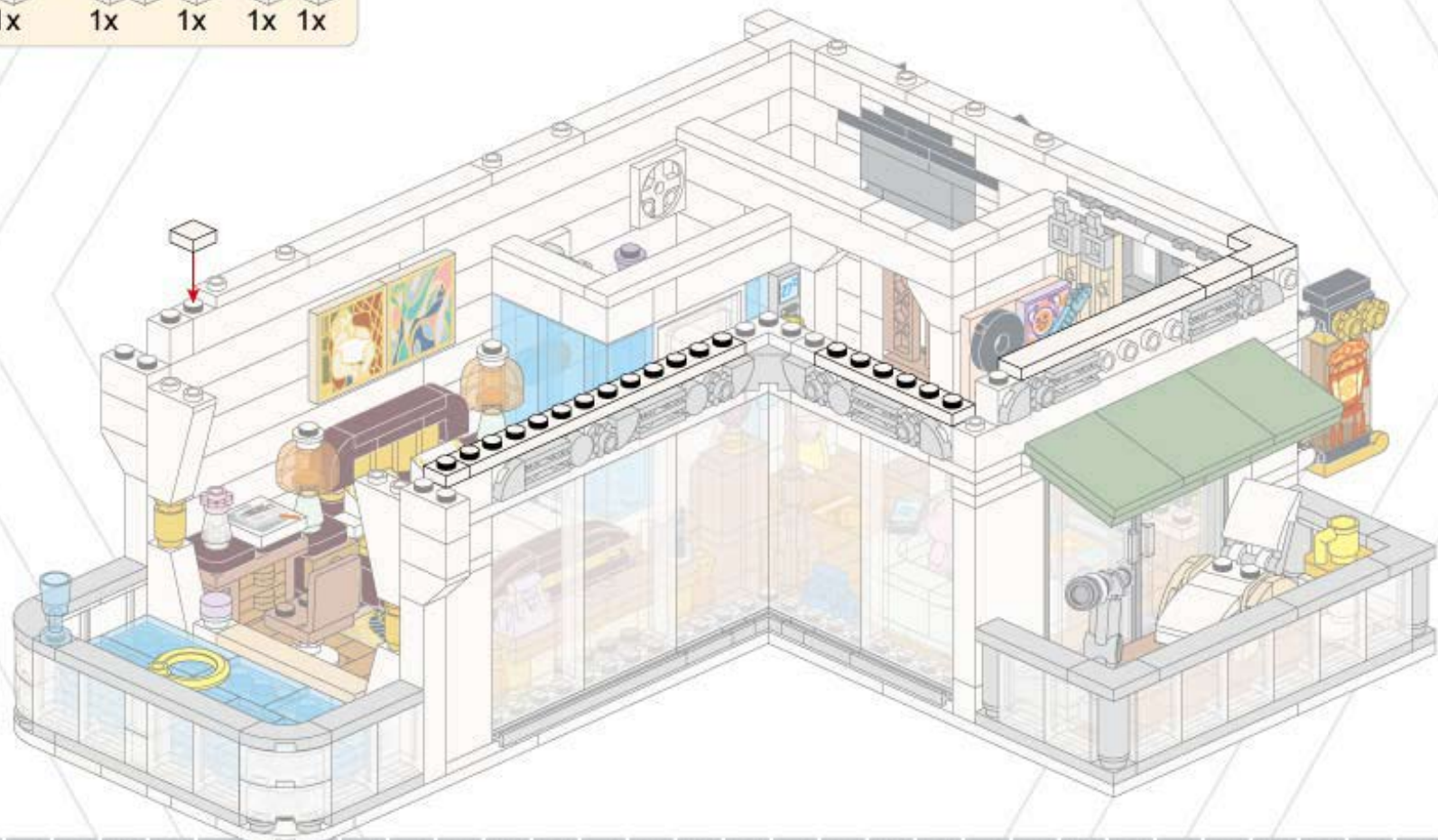
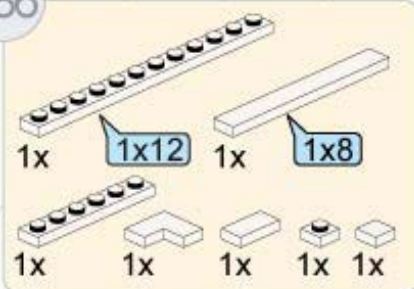

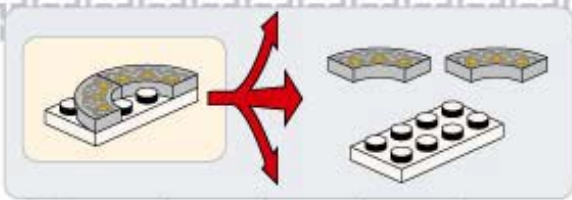

187

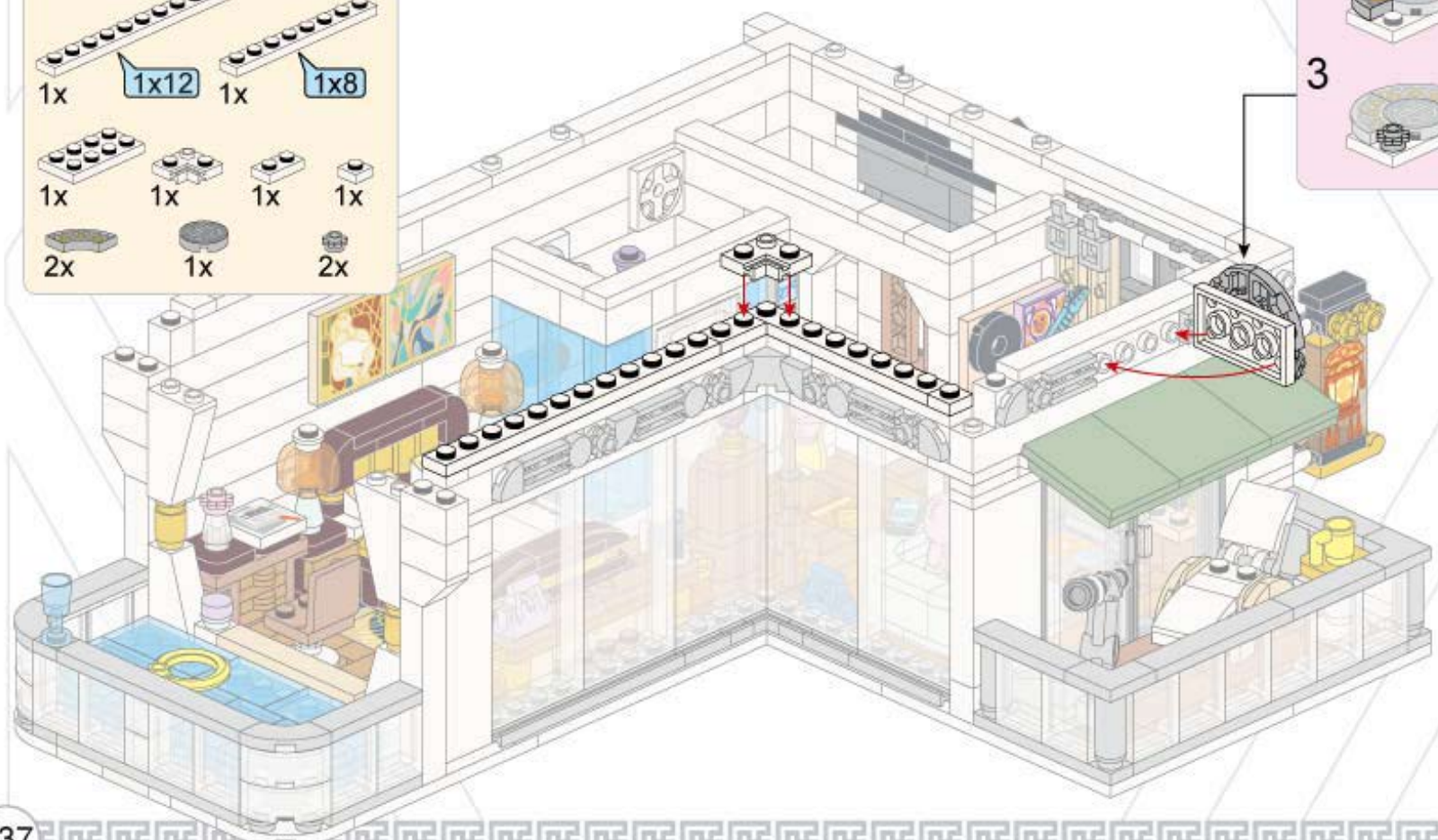
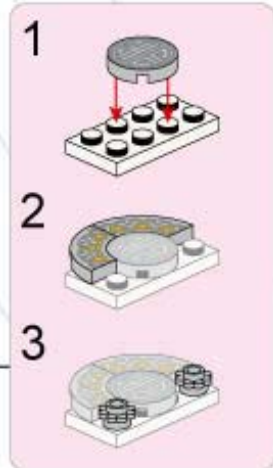
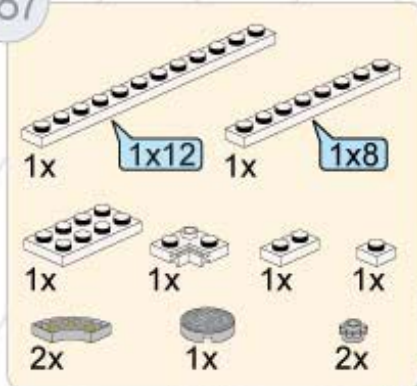

137

- 1x
- 1x
- 2x
- 2x
- 1x
- 2x
- 1x
- 1x
- 2x
- 1x
- 1x
- 1x
- 1x
- 1x
- 1x
- 1x
- 1x

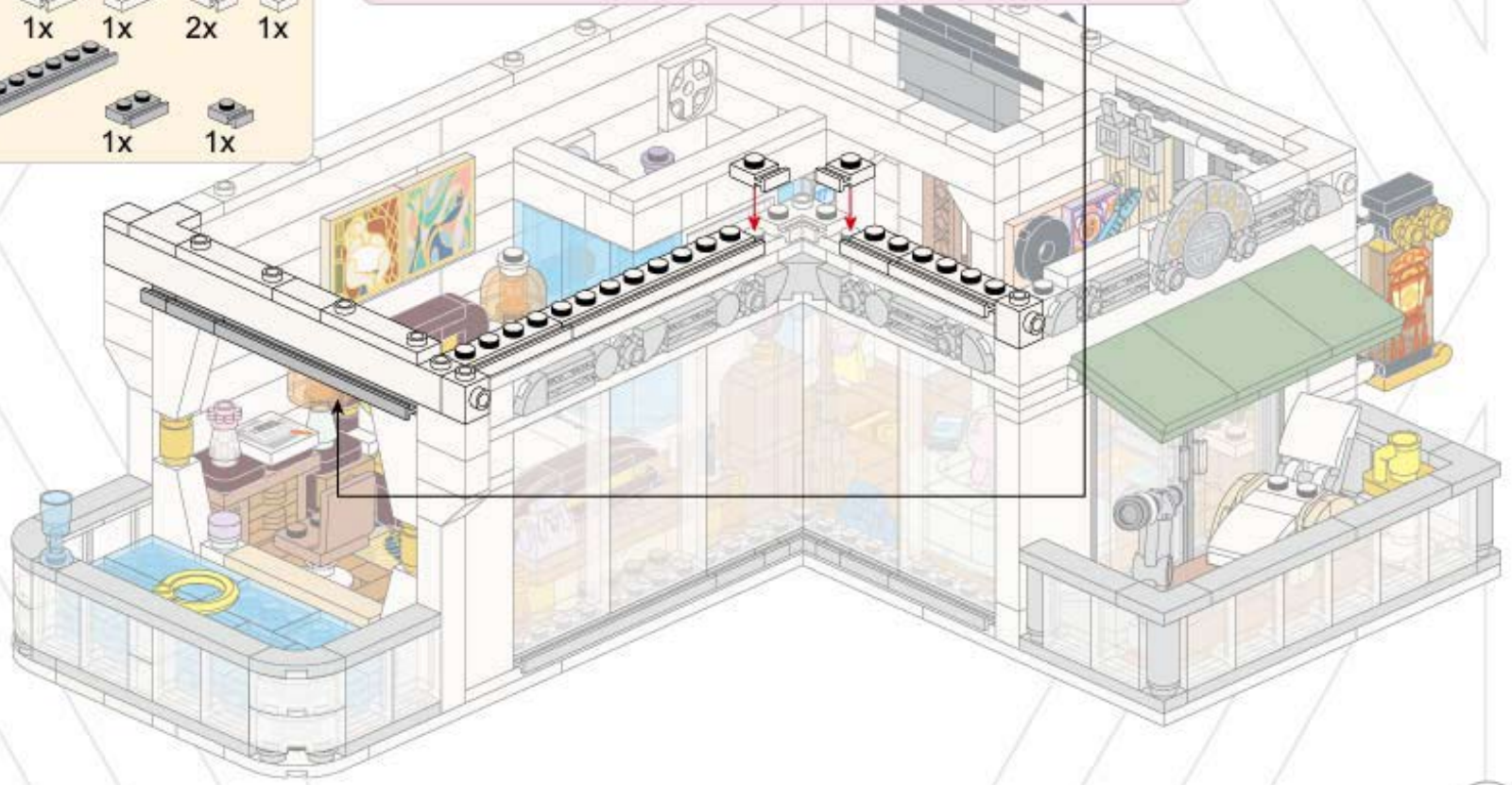
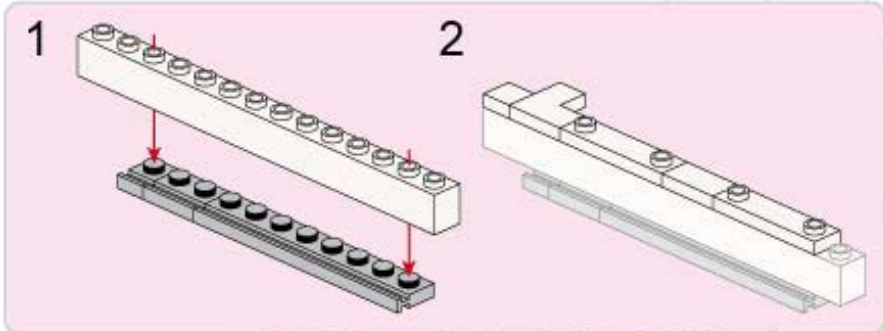

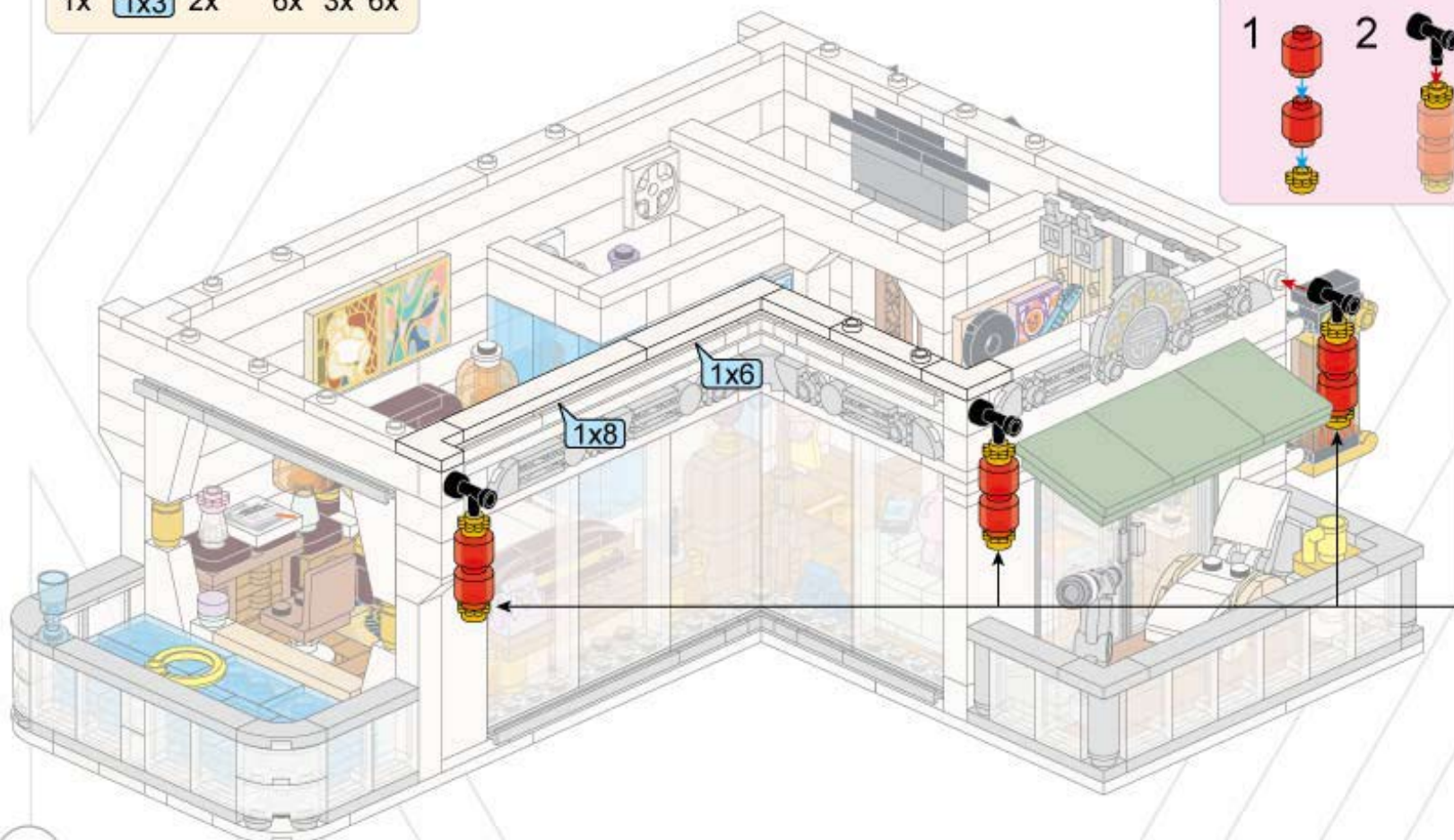
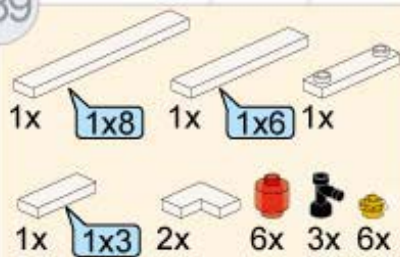

190



2x



2x

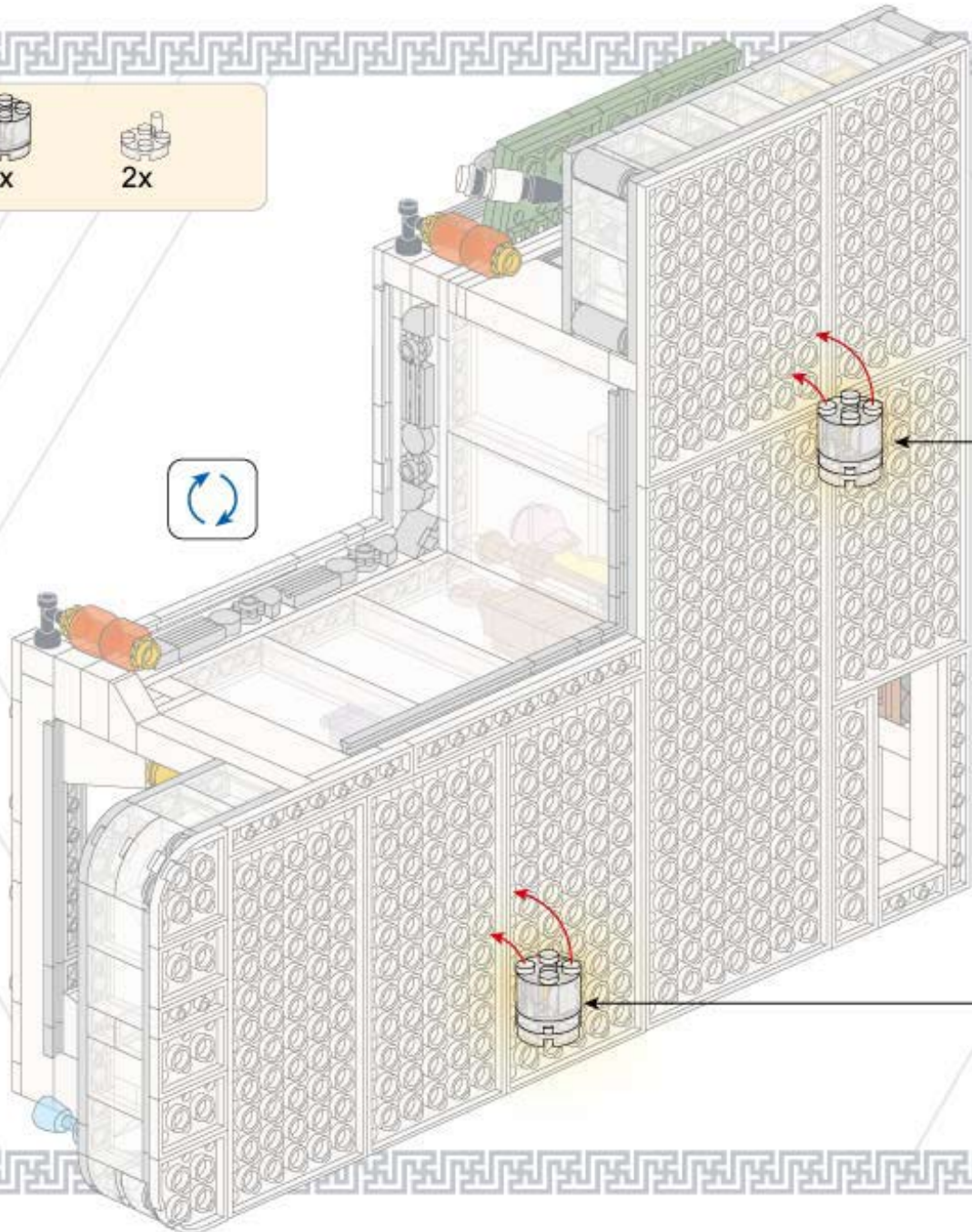

2x

140

191

190

126



141

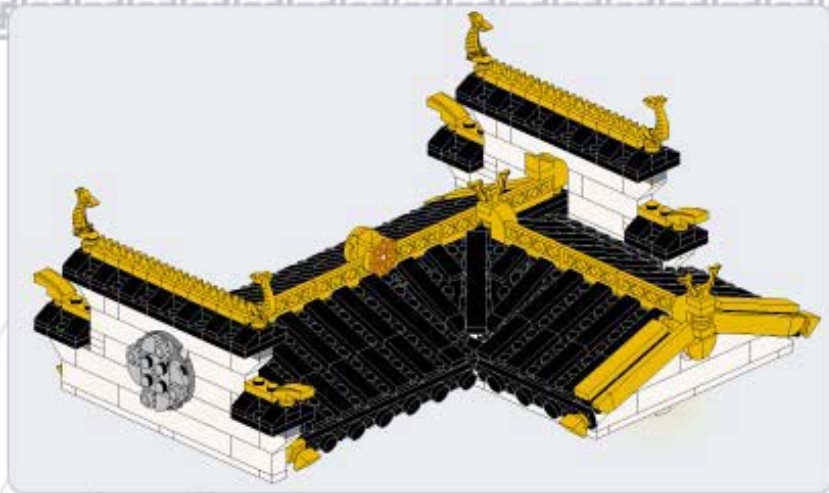

192

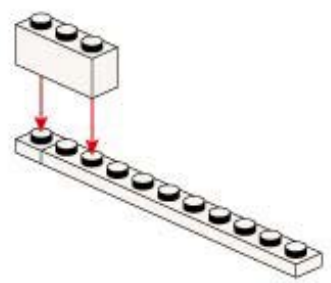
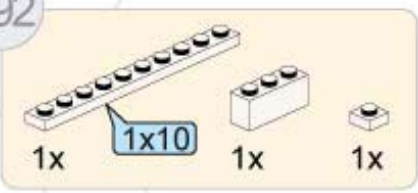

193

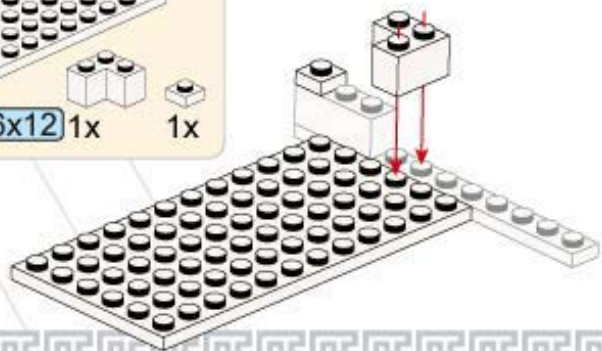
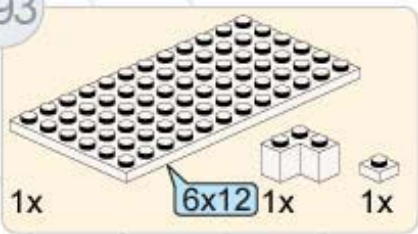

194

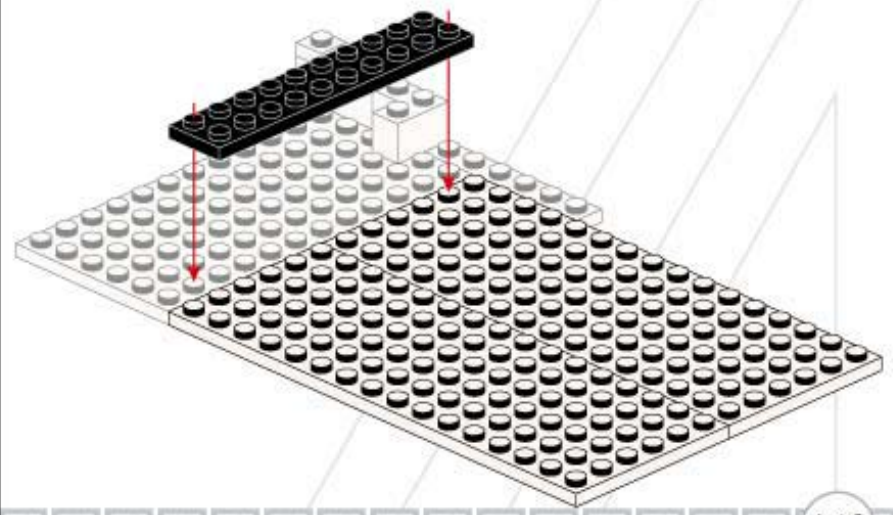
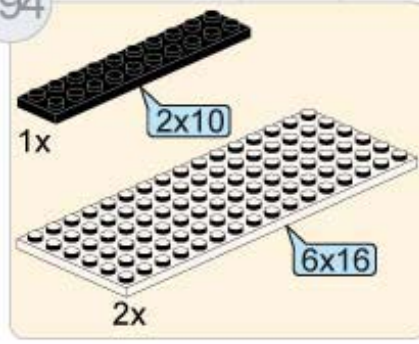

195

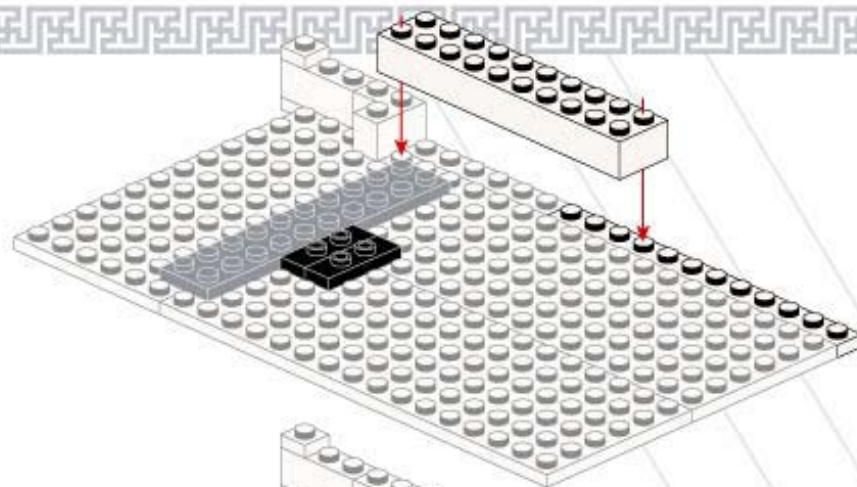
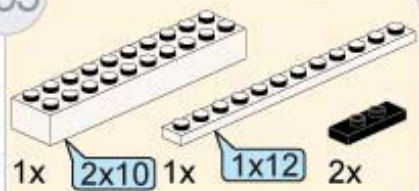

196

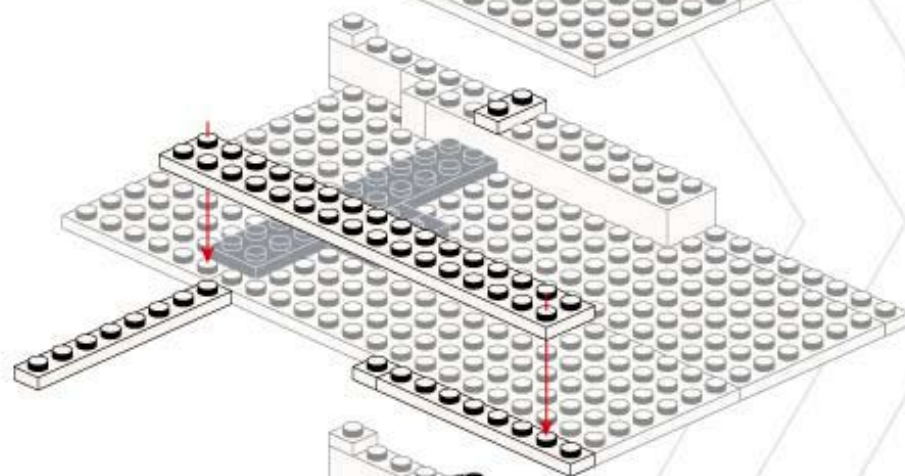
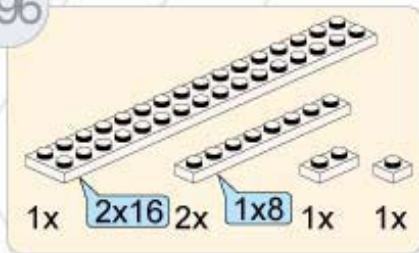

197

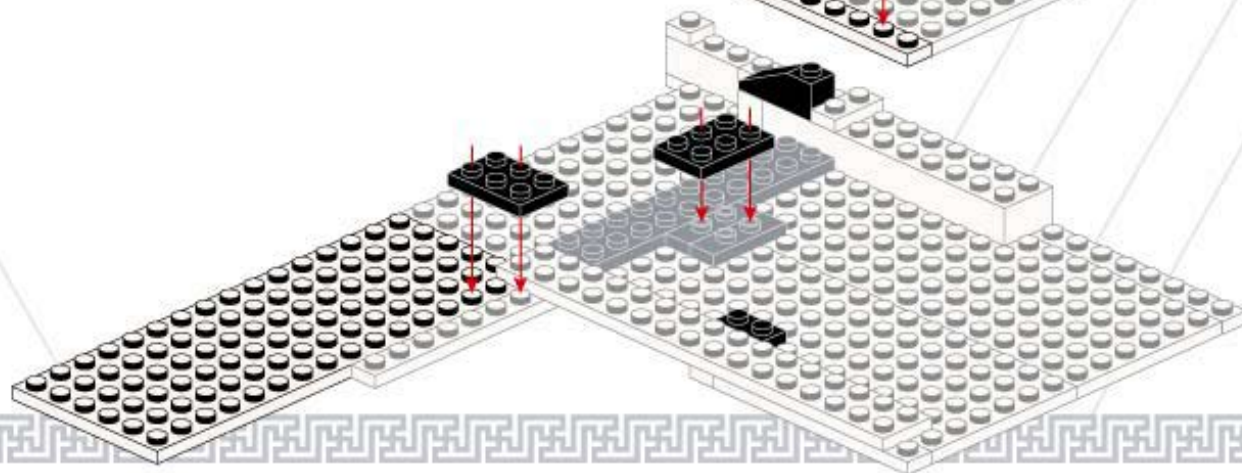
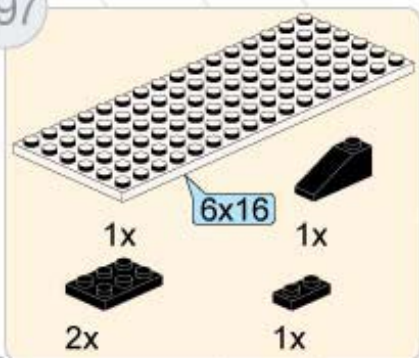

143

198

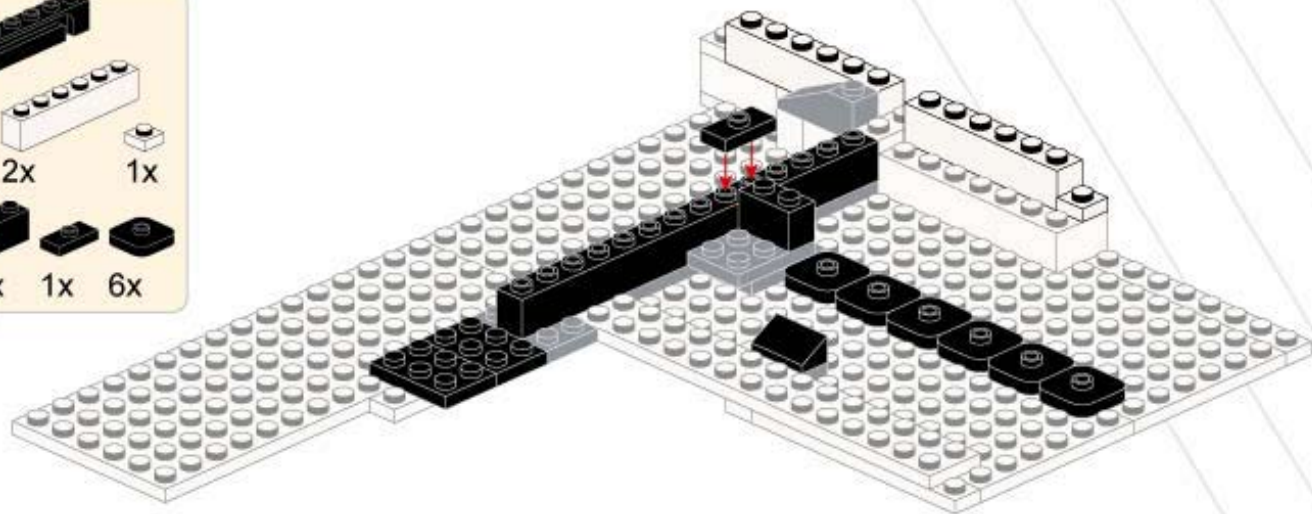
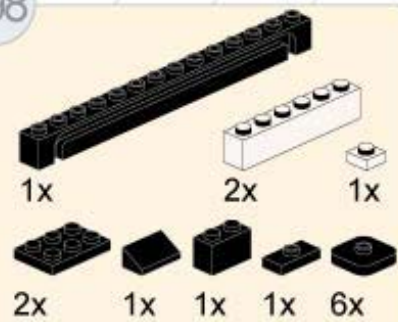

199

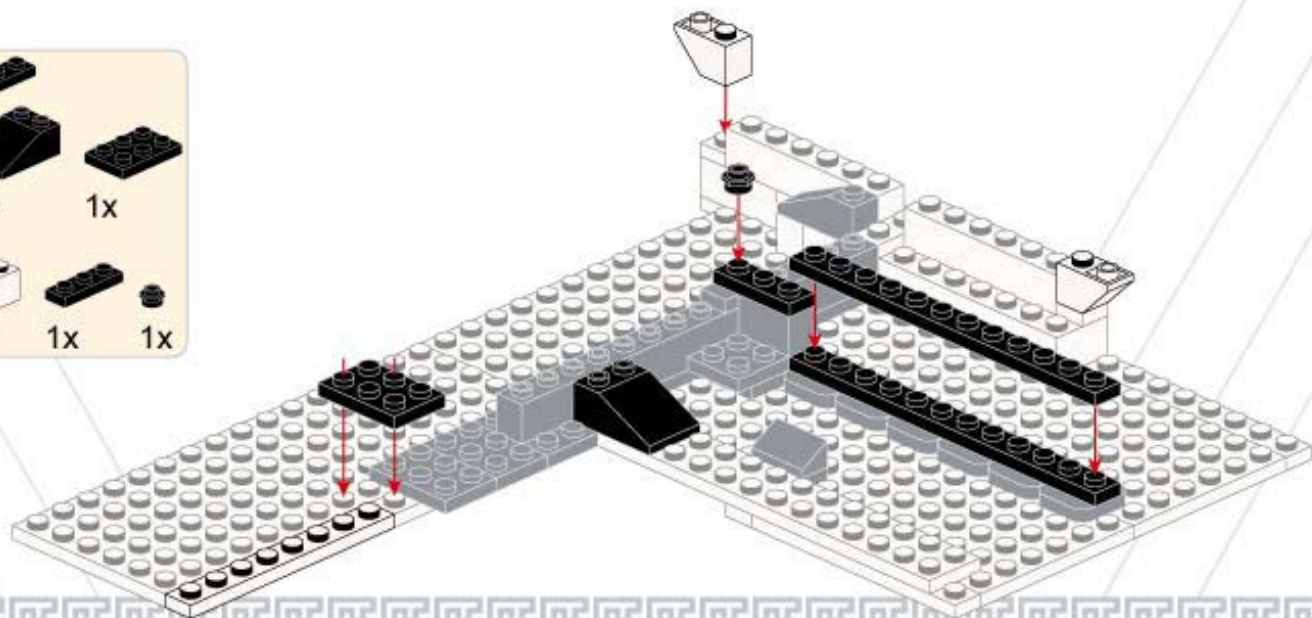
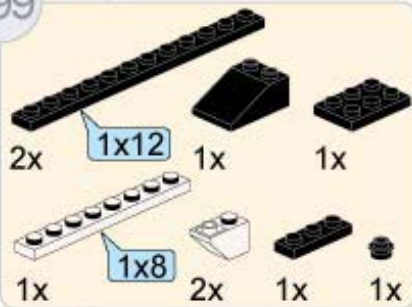

200

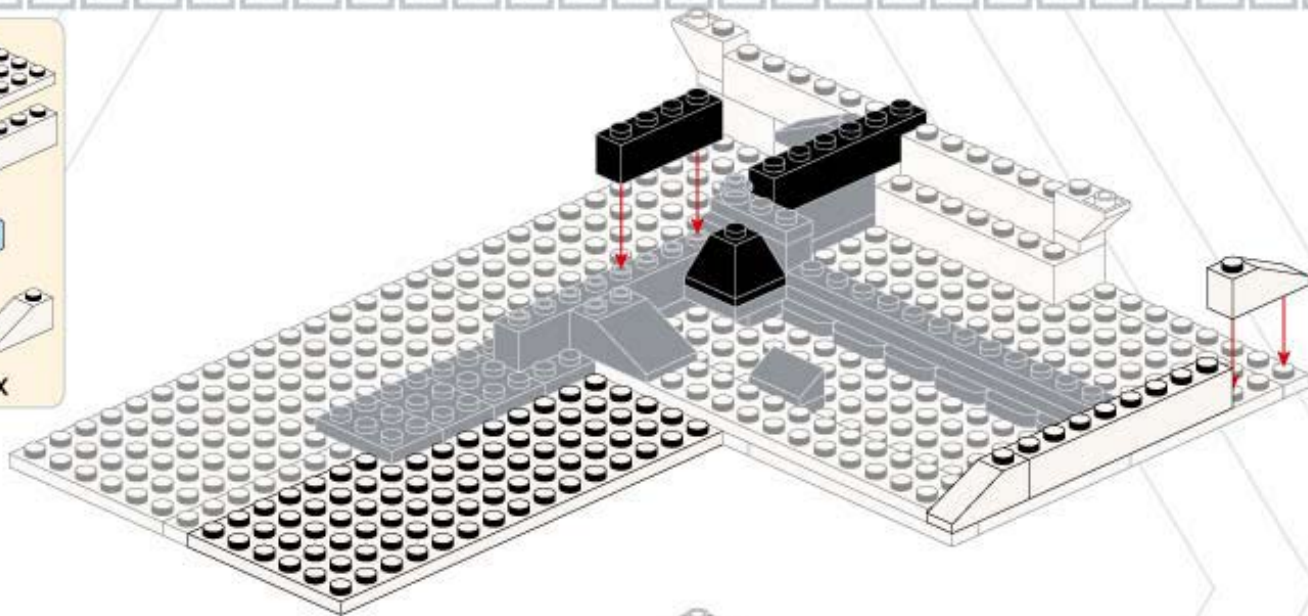
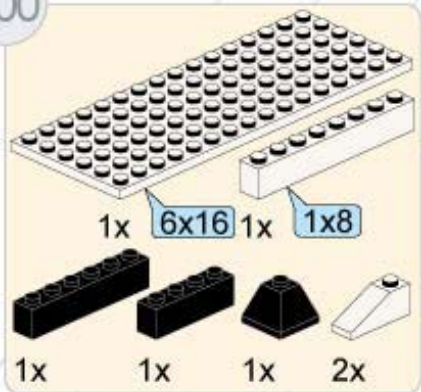

201

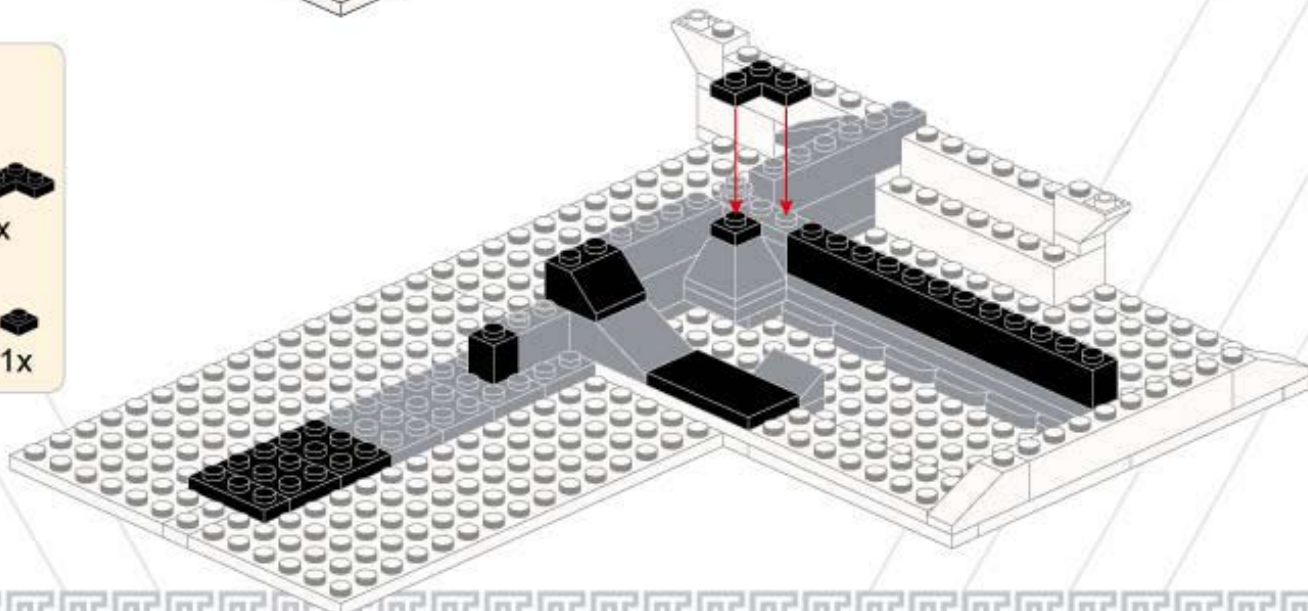
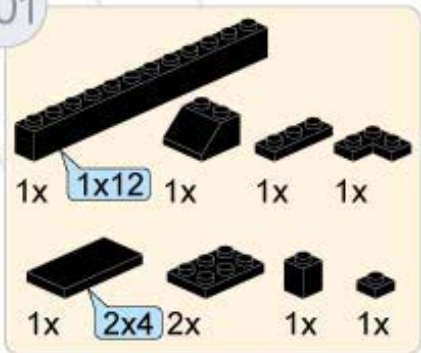

202

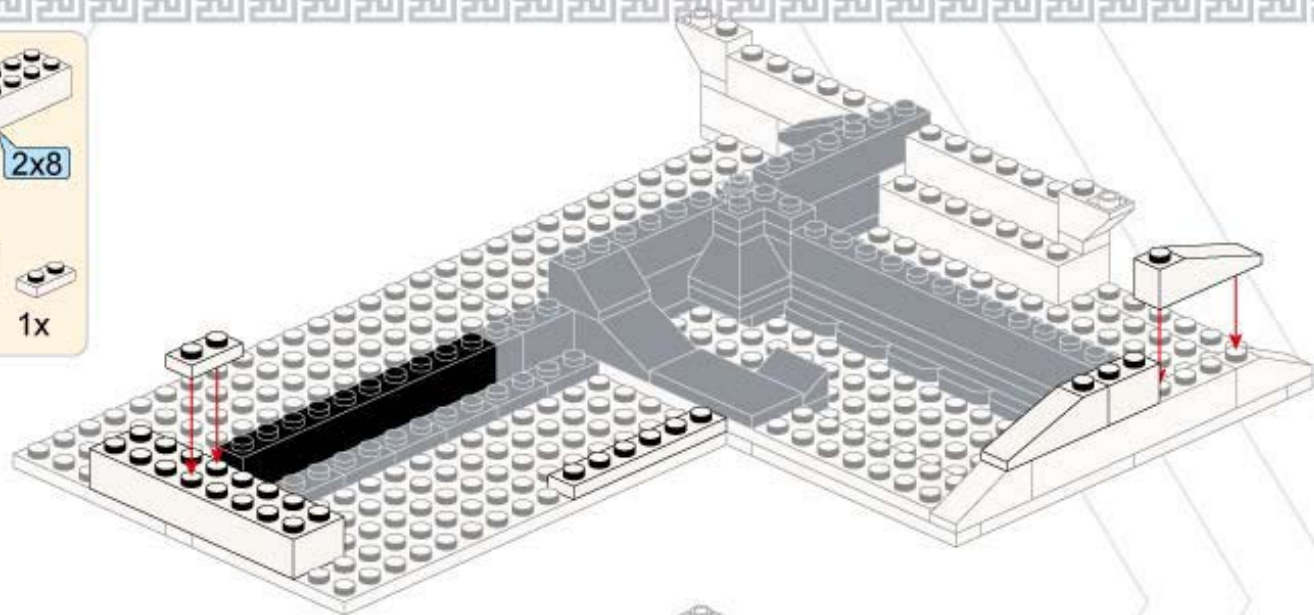
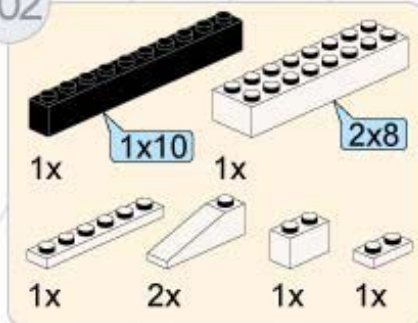

203

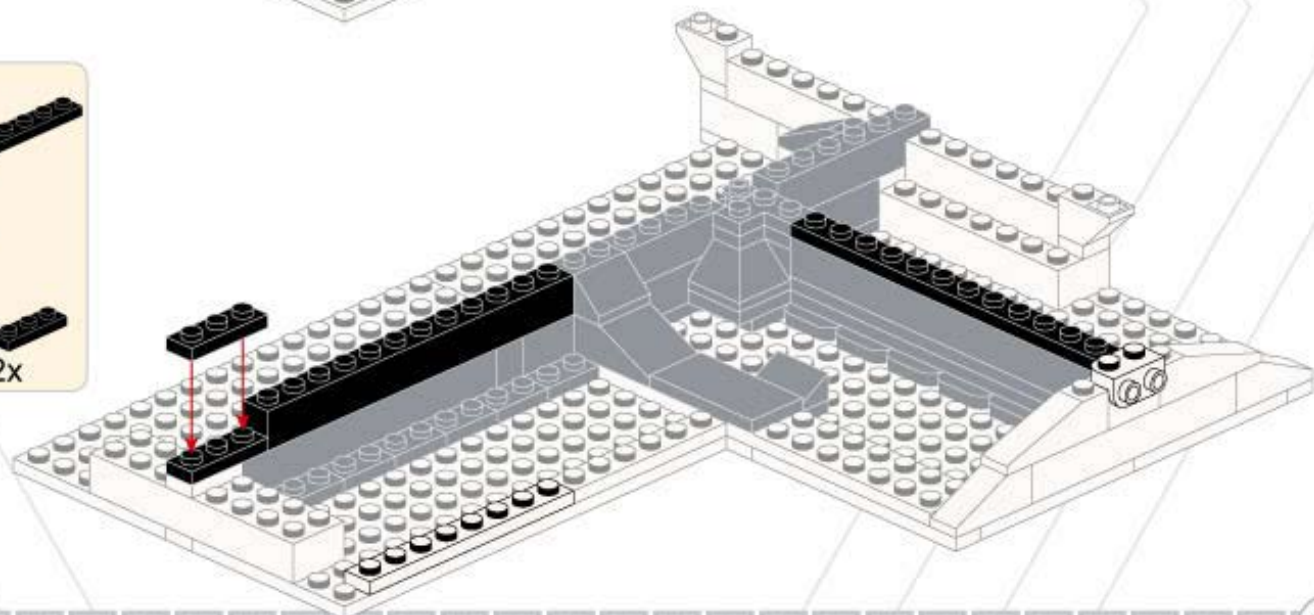
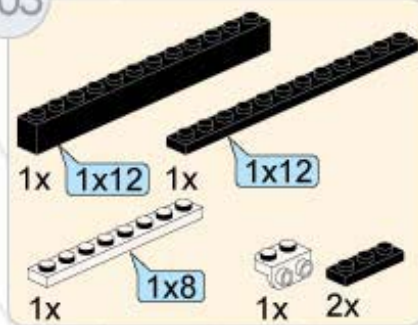

204

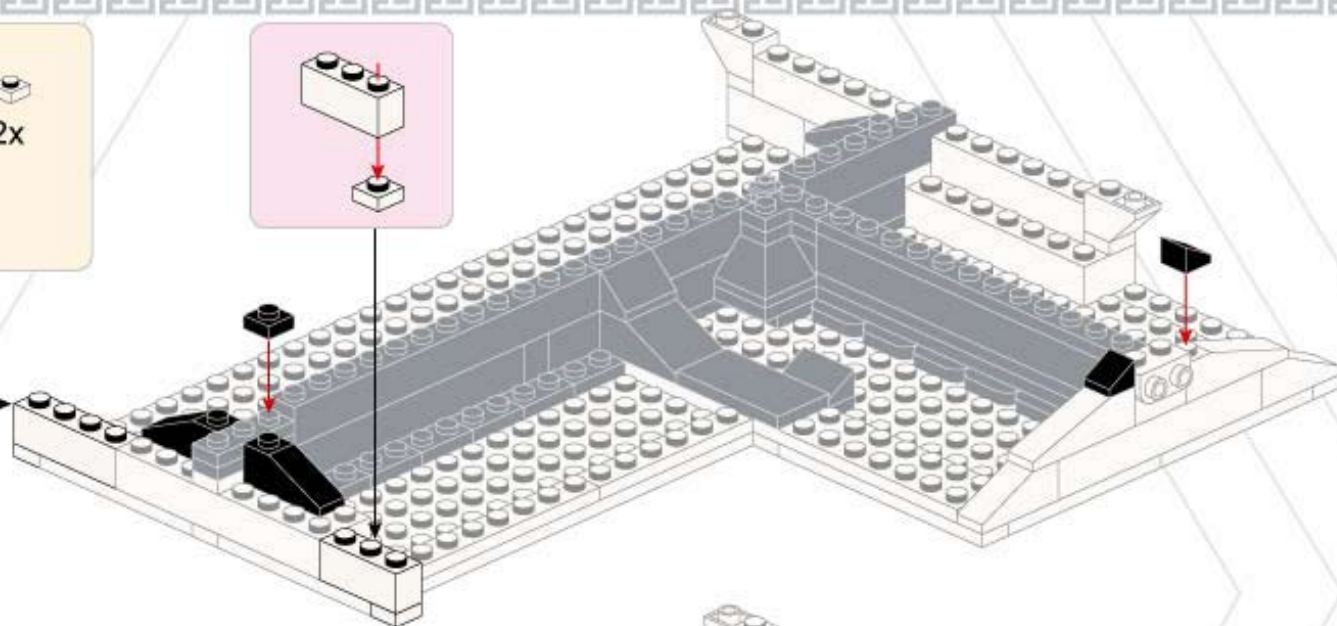
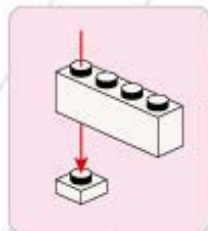
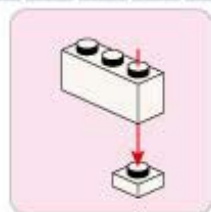
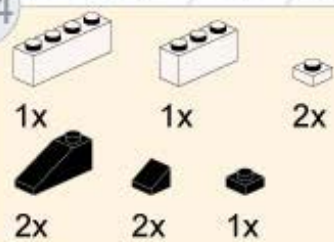

205

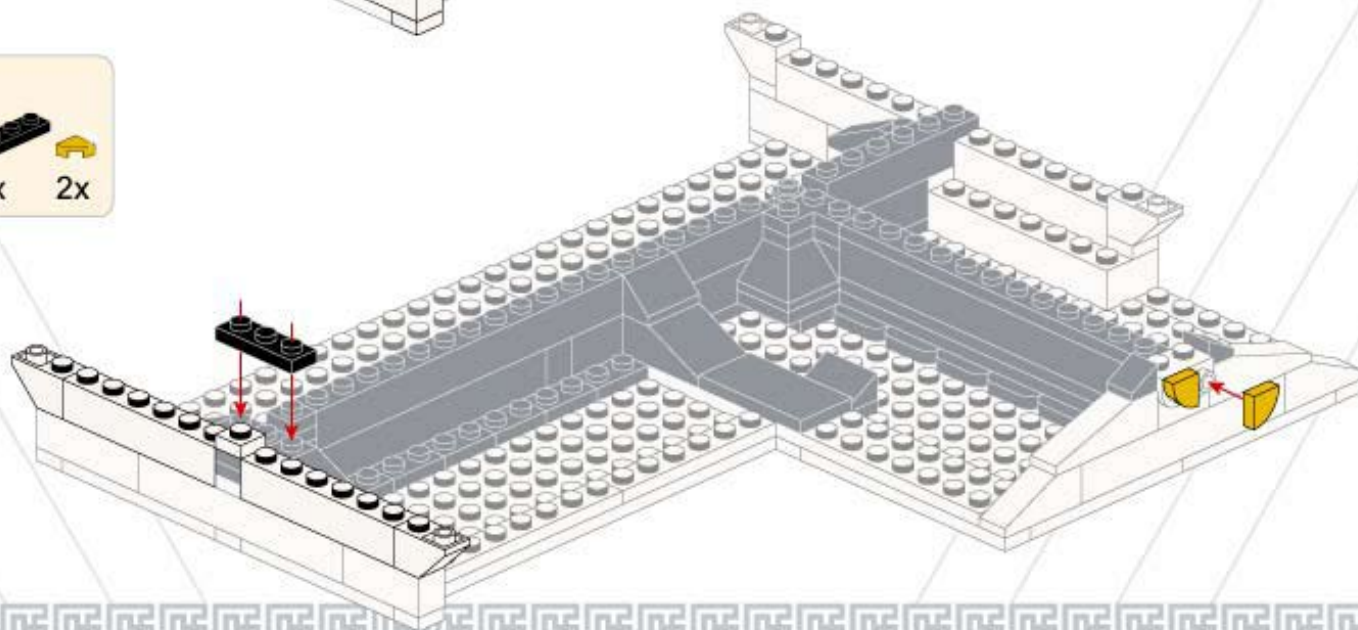
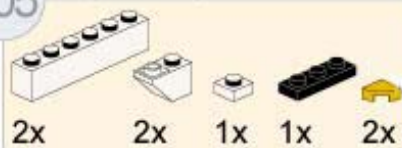

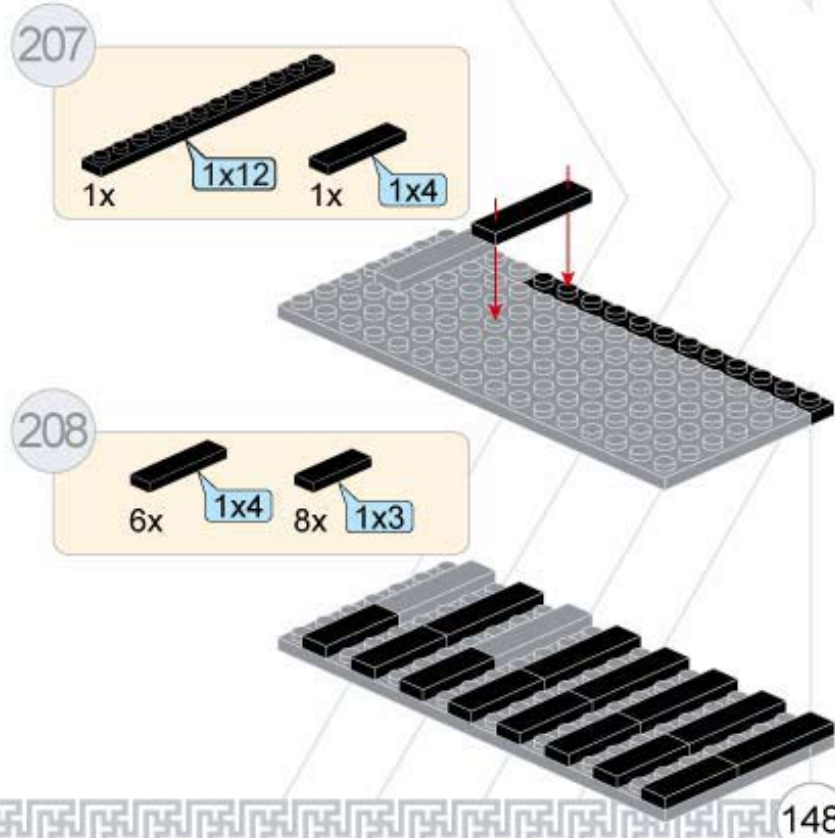
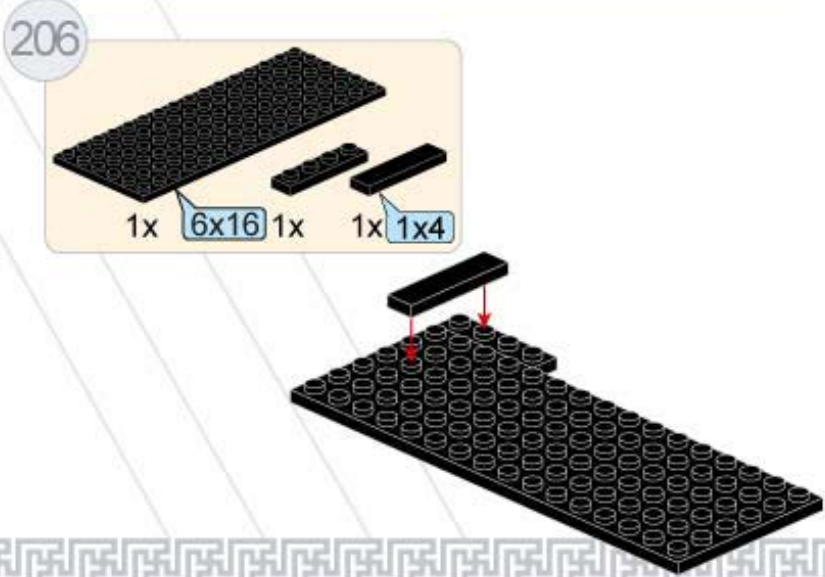
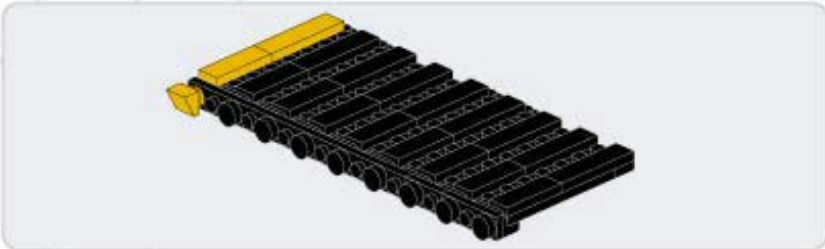
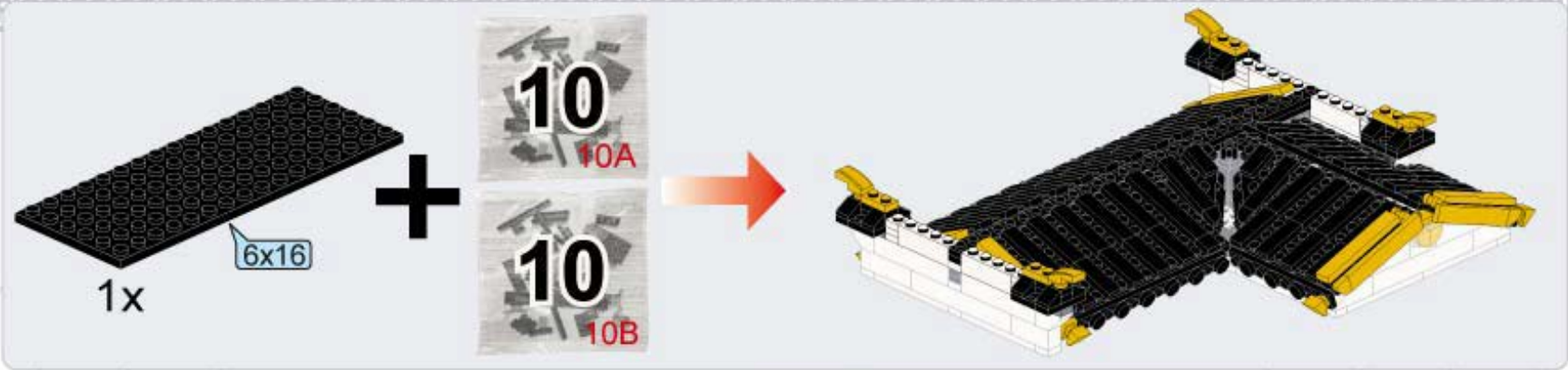

209

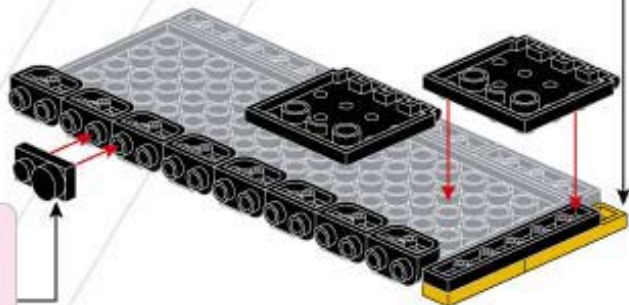
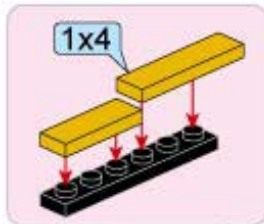
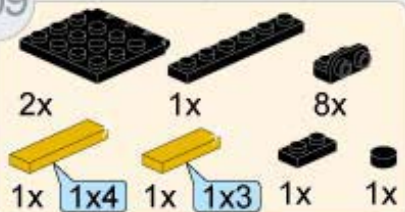

210

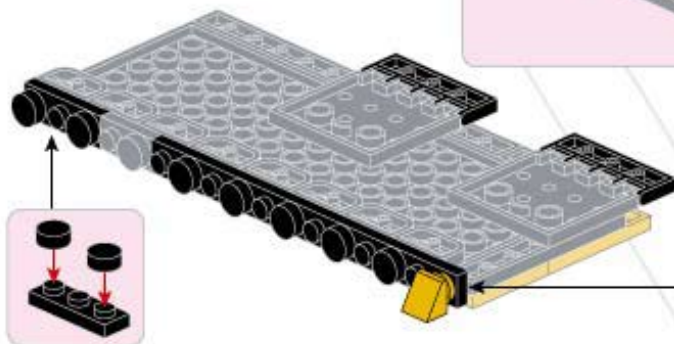
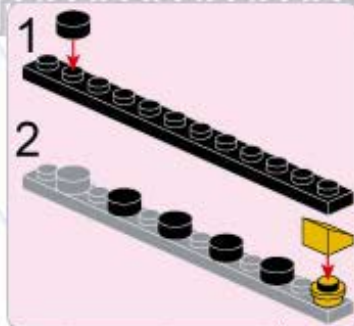

211

210

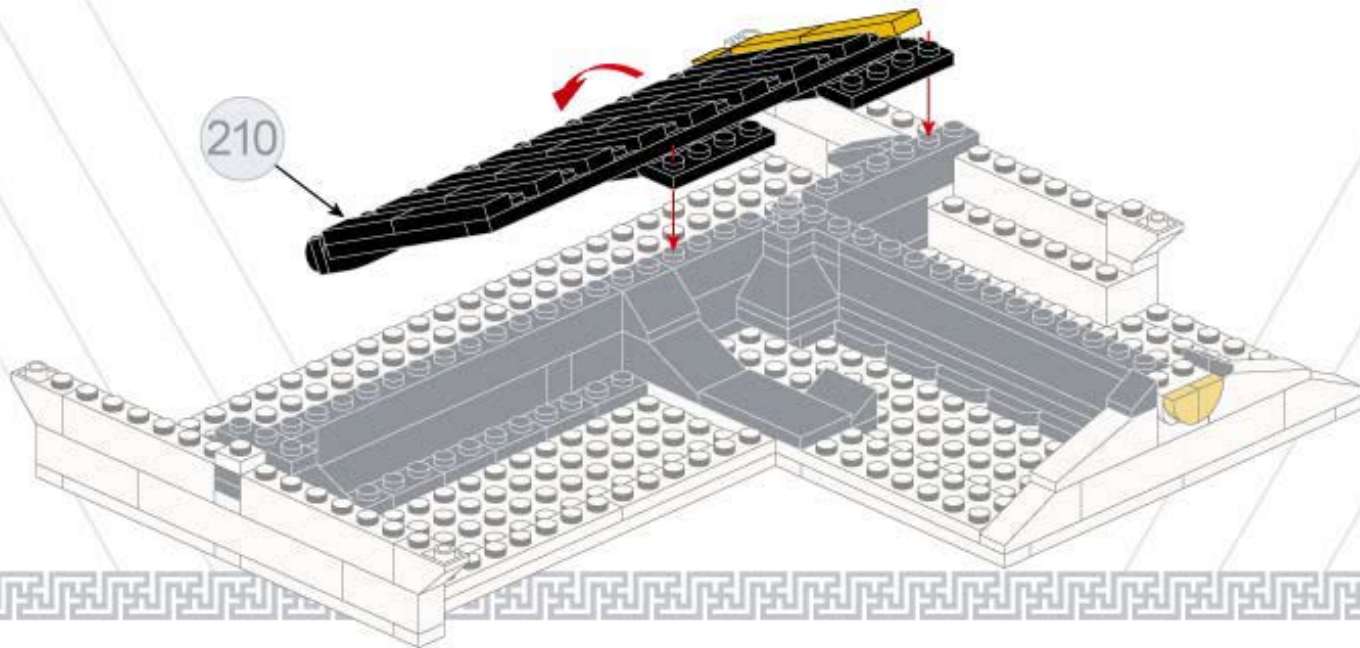

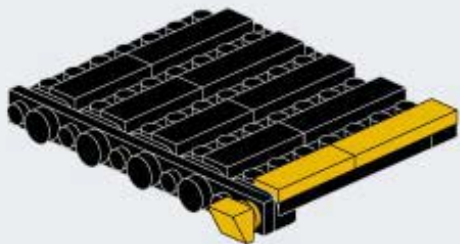

212

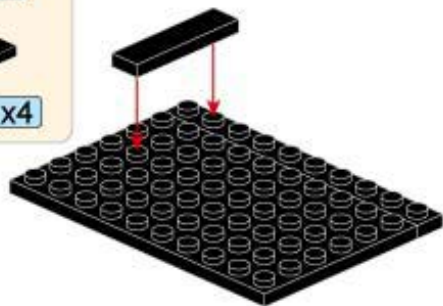
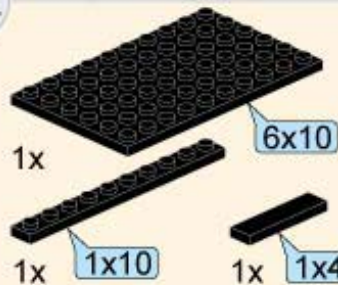

213

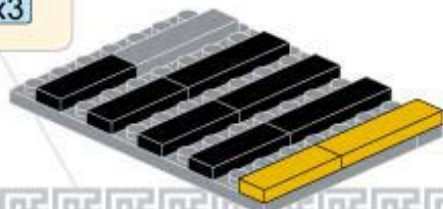
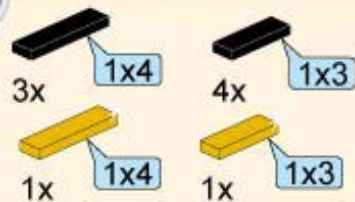

214

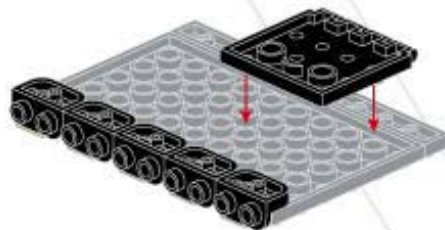

215

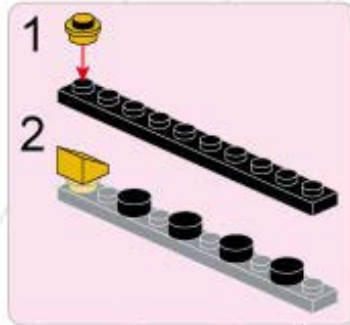
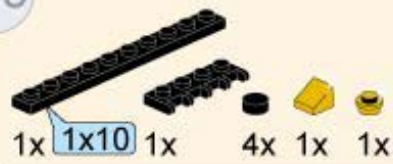

216



1x



1x

215

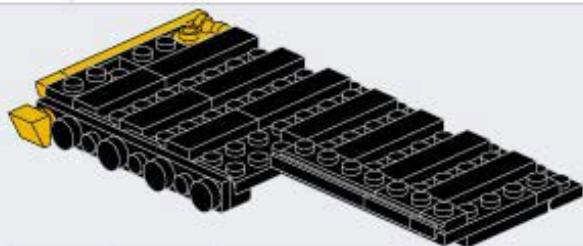
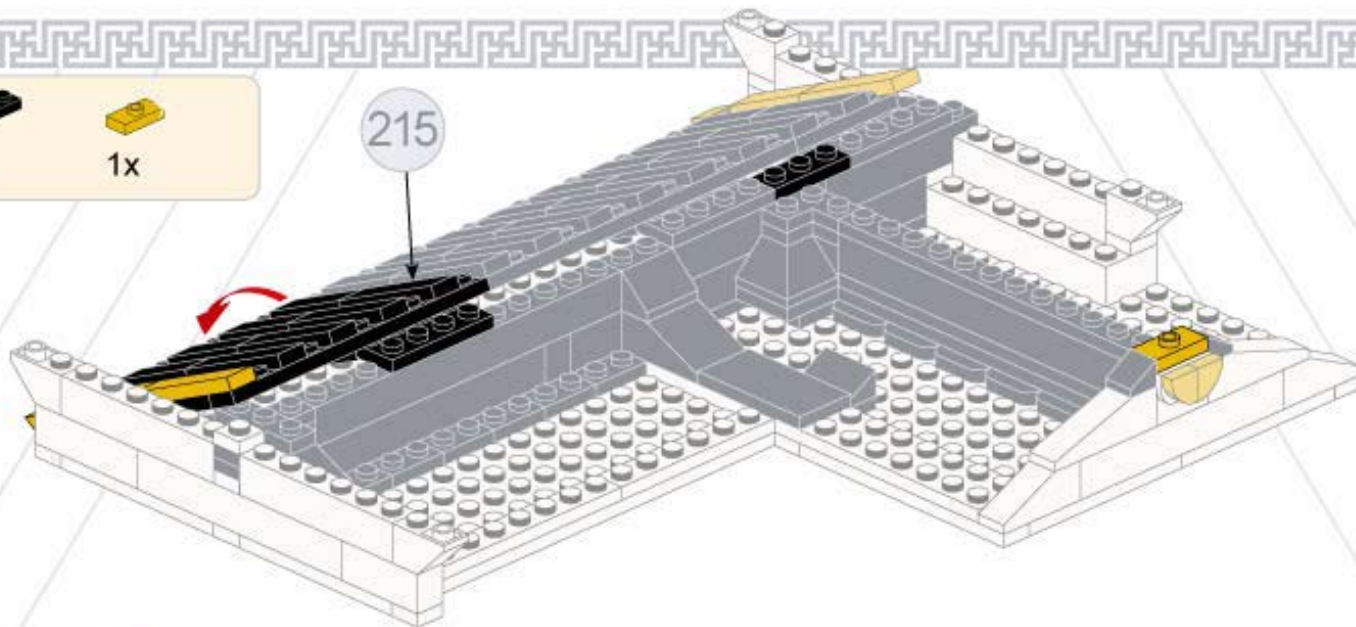

218



1x

4x6



5x

1x4



3x

1x3

1

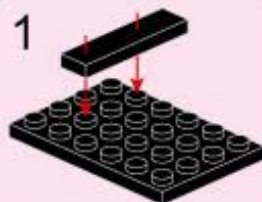

2

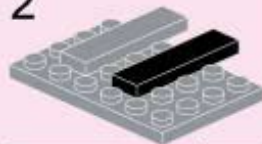

217



1x

1x12



1x

1x4



1x

6x8

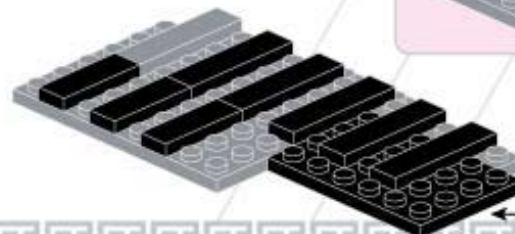
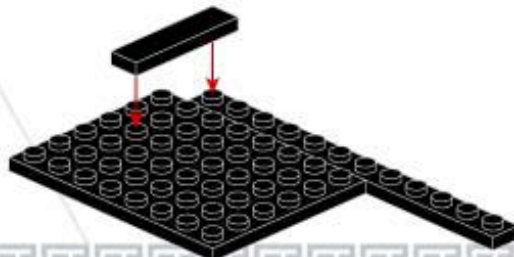

151

219



2x

2x

3x



2x

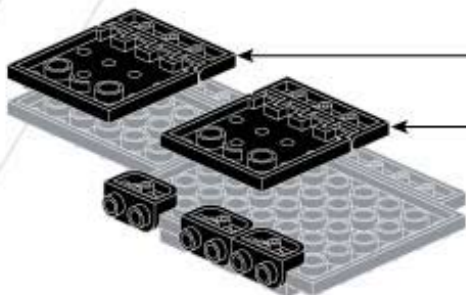

220



1x

1x6

1x

1x



1x



1x

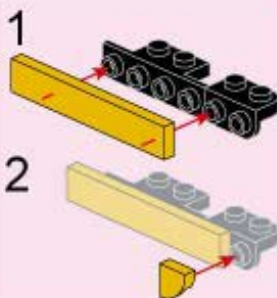

1

2

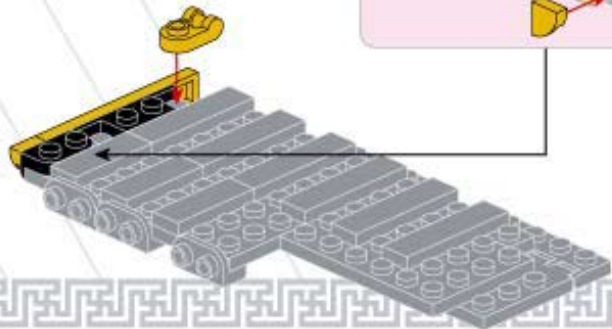

221



1x

1x

1x



1x

1x6



1x

1x4

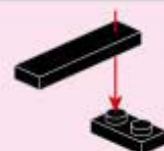

222



1x

1x8

1x

1x

1x

1x

4x

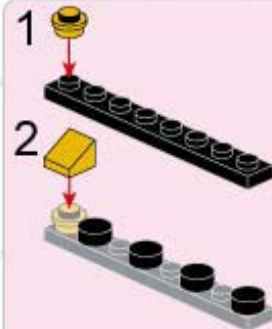

1

2

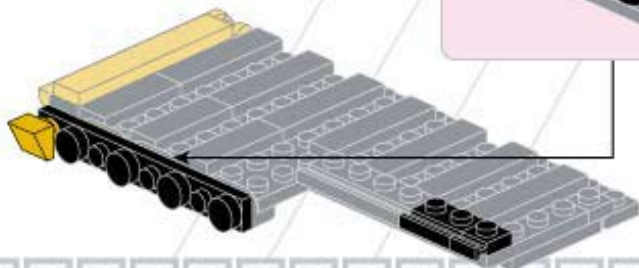

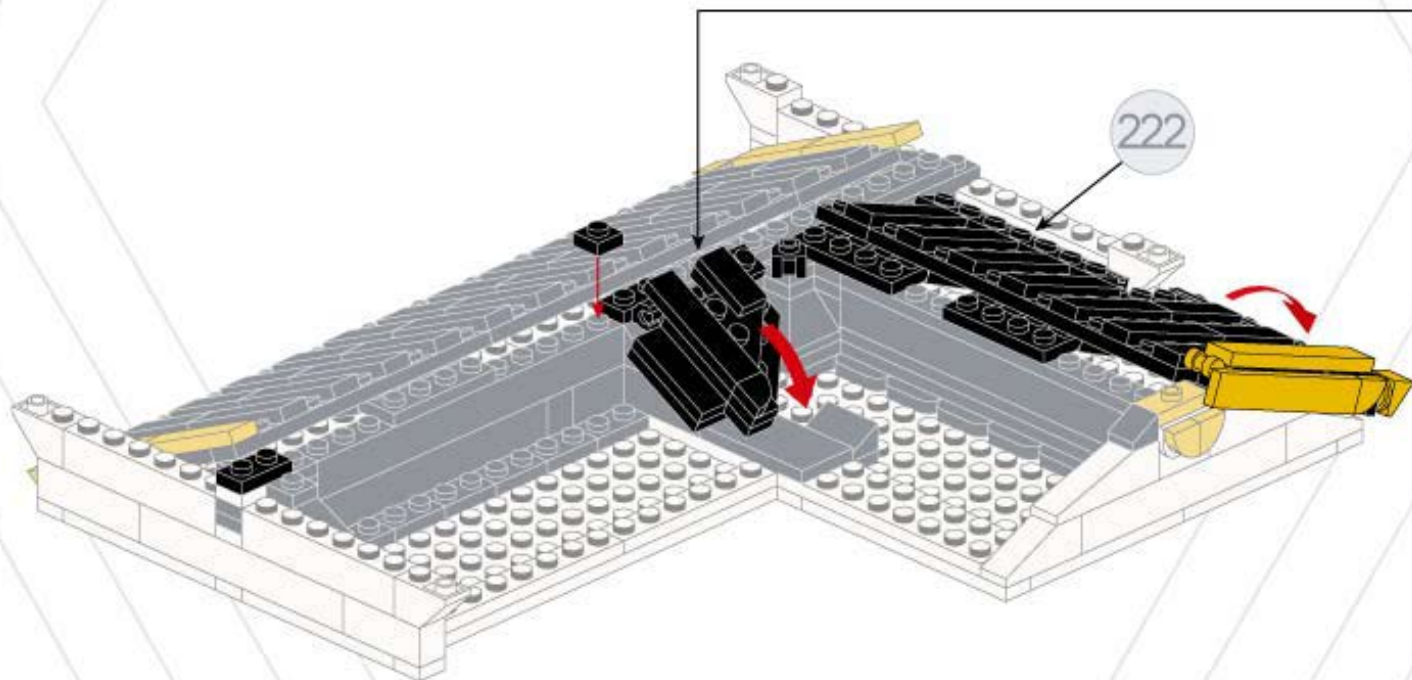
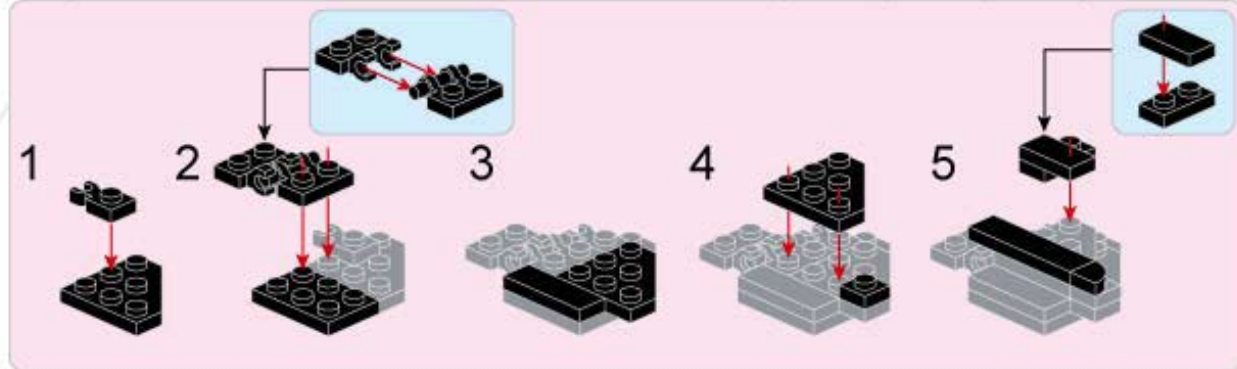
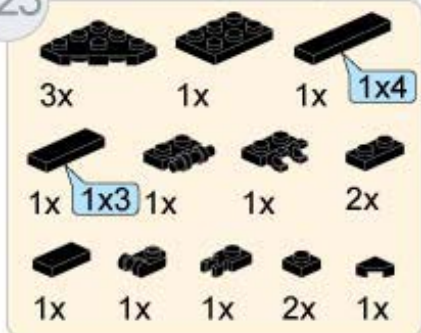

224

3x	1x	1x	1x4	
1x	1x	1x	1x	1x
1x	1x	1x	2x	3x

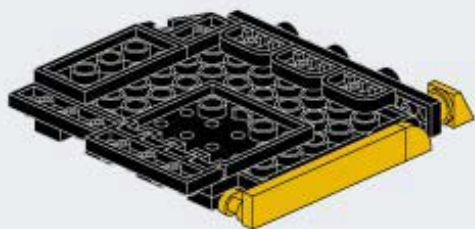

225

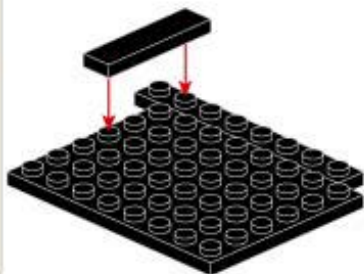
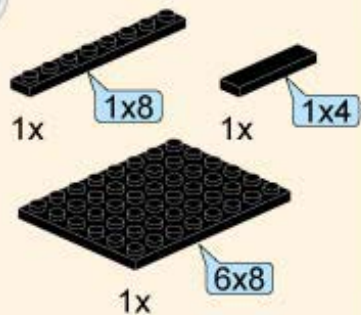

226

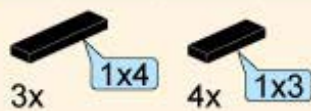

227

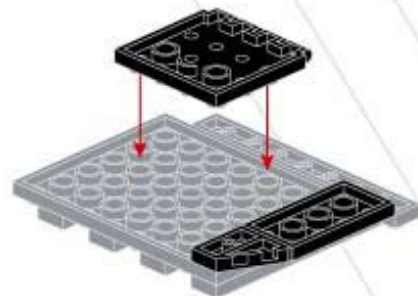
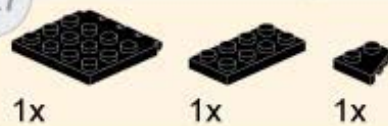

228

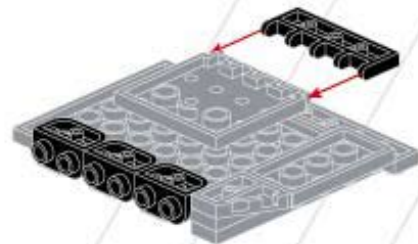

229

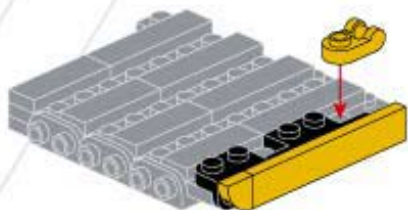
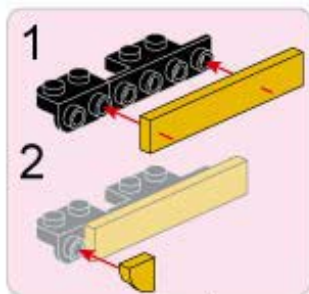

230

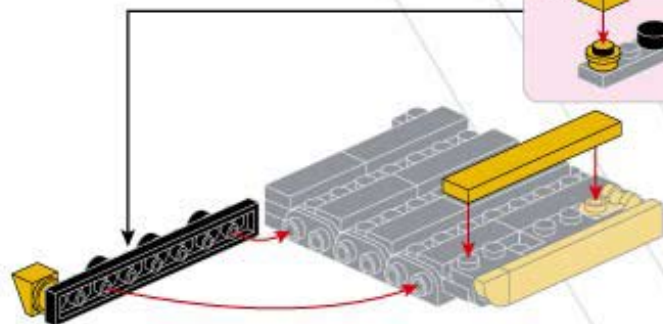
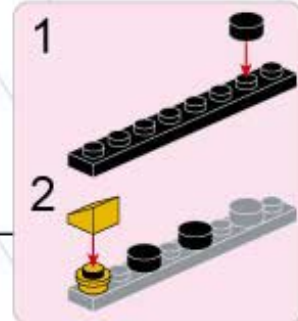
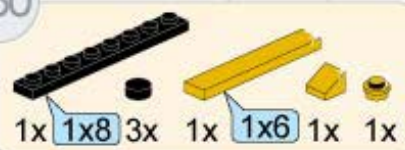

231

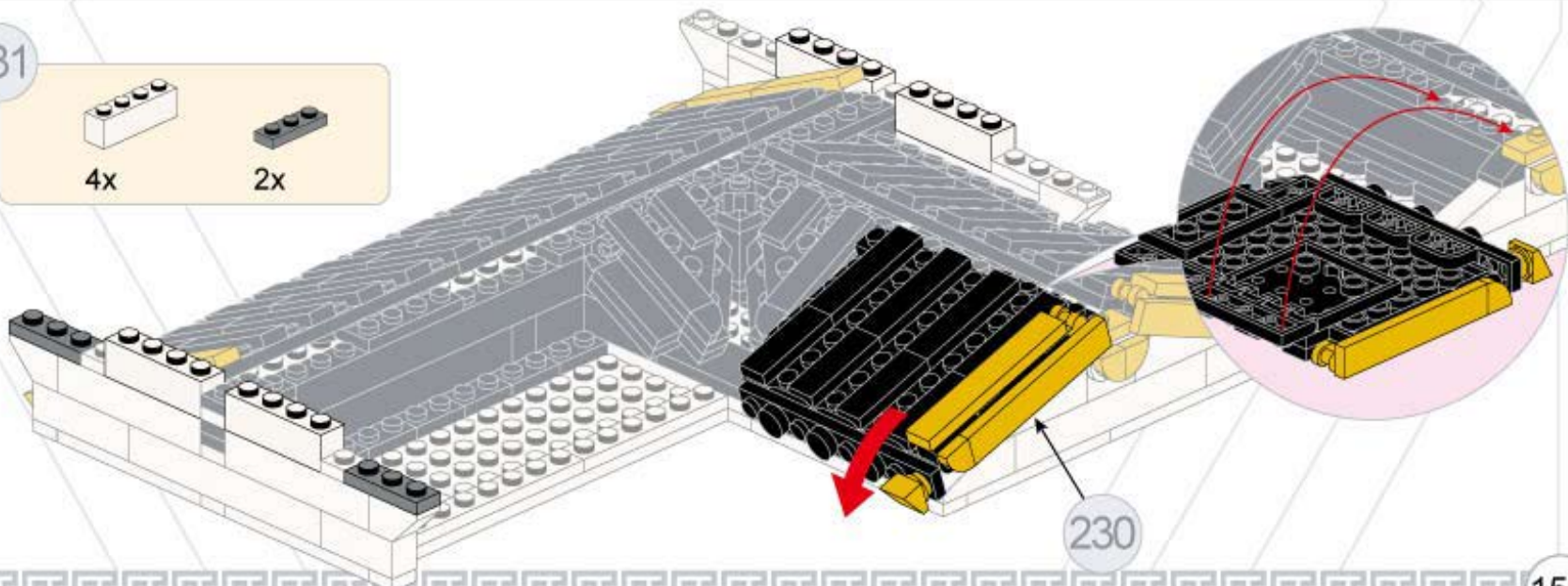
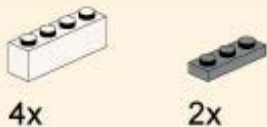

230

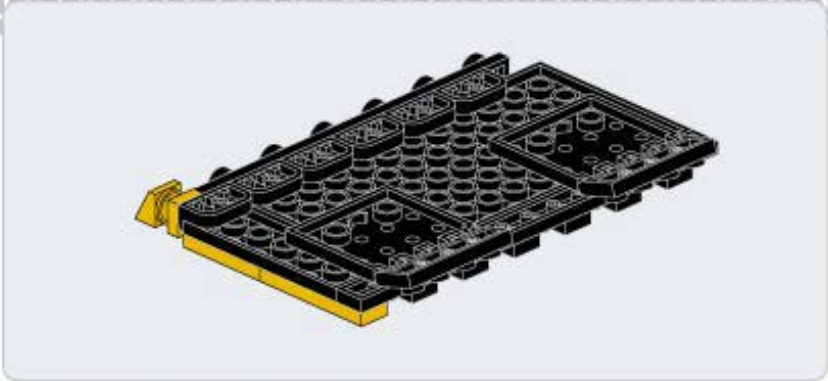

232

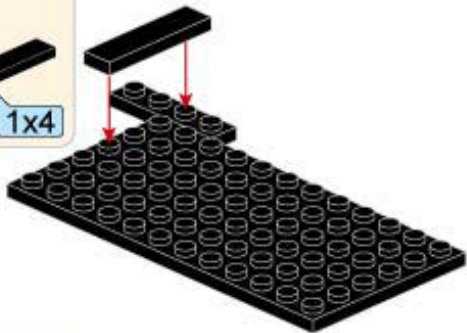
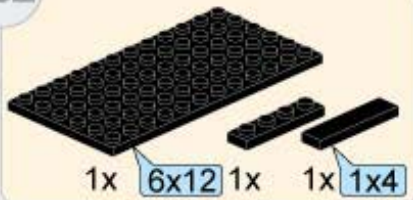

233

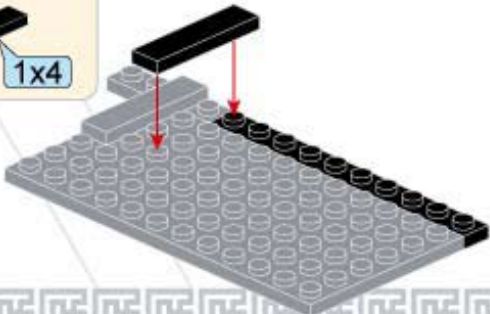
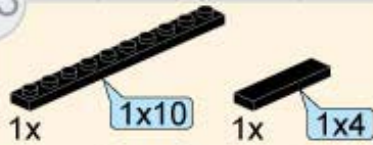

234

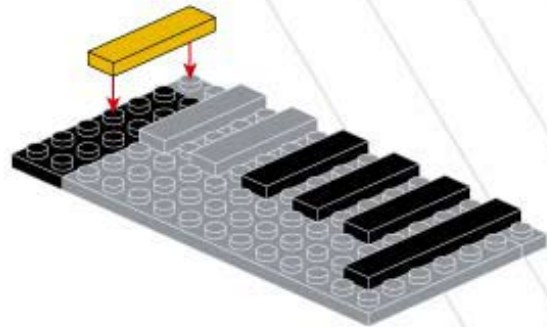
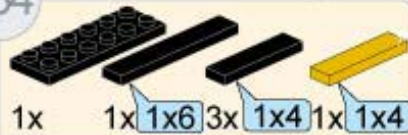

235

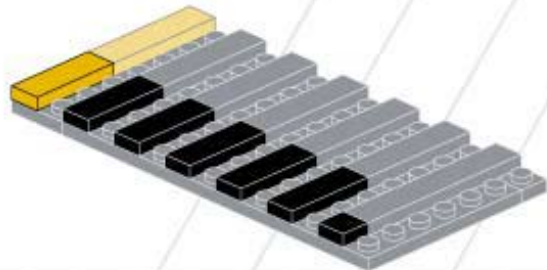

236



2x

6x

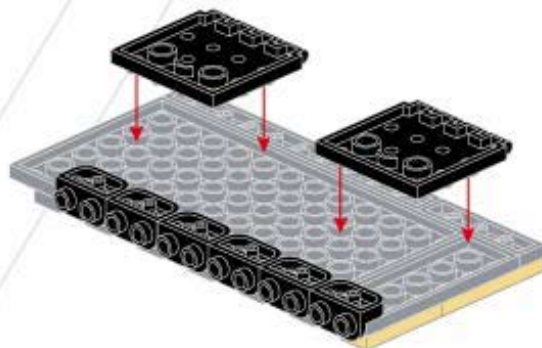

237

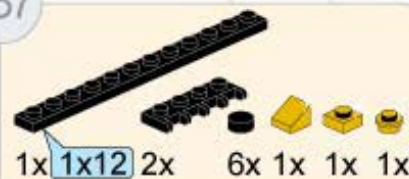

1x 1x12 2x 6x 1x 1x 1x

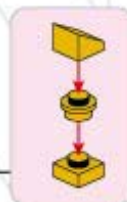
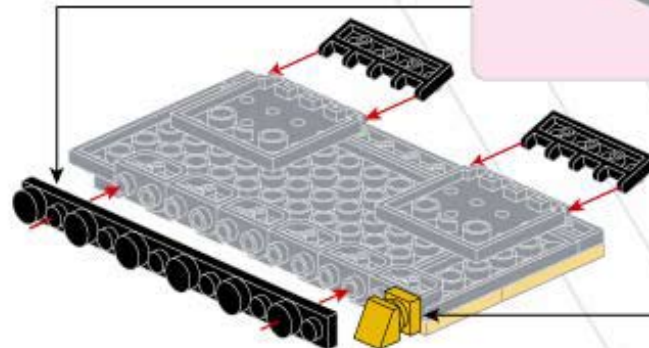
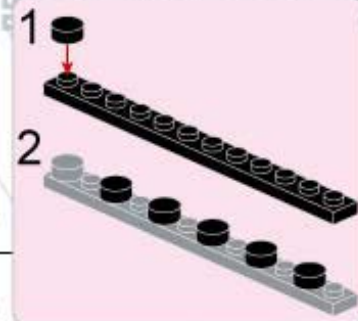

238



1x

1x10

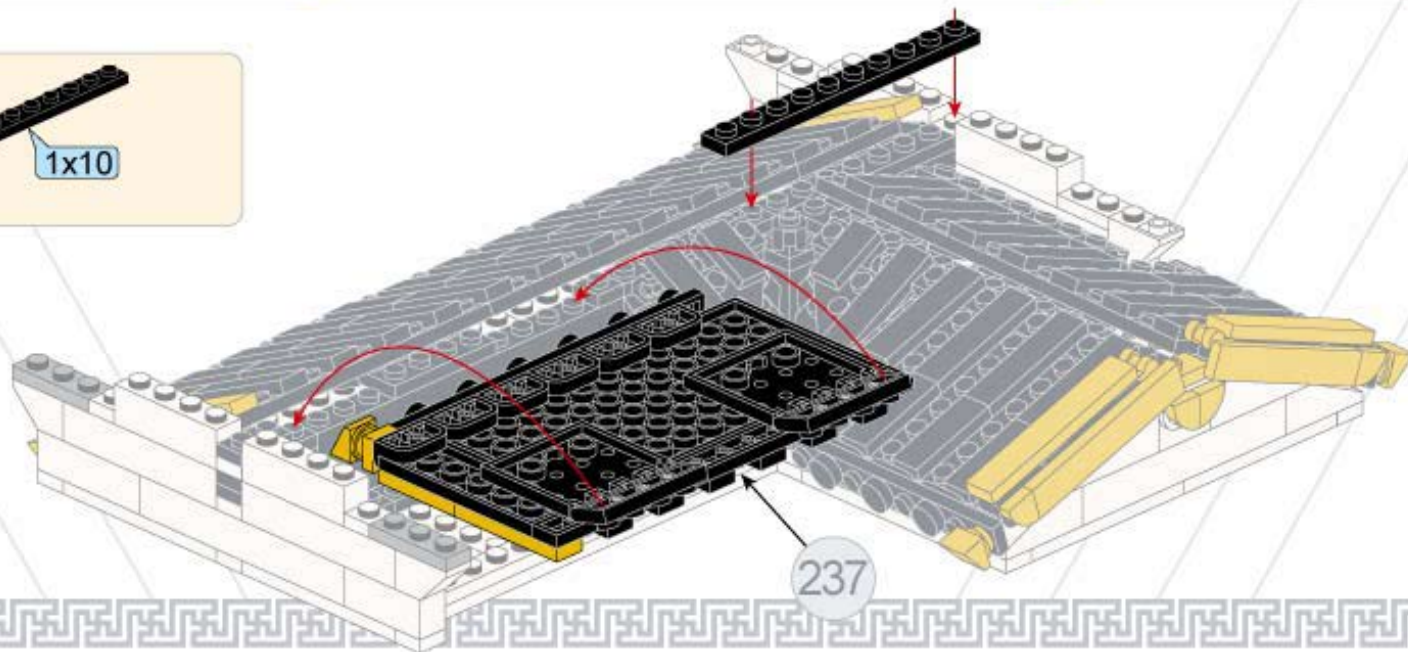

239

- 1x 1x10
- 1x 1x8
- 1x

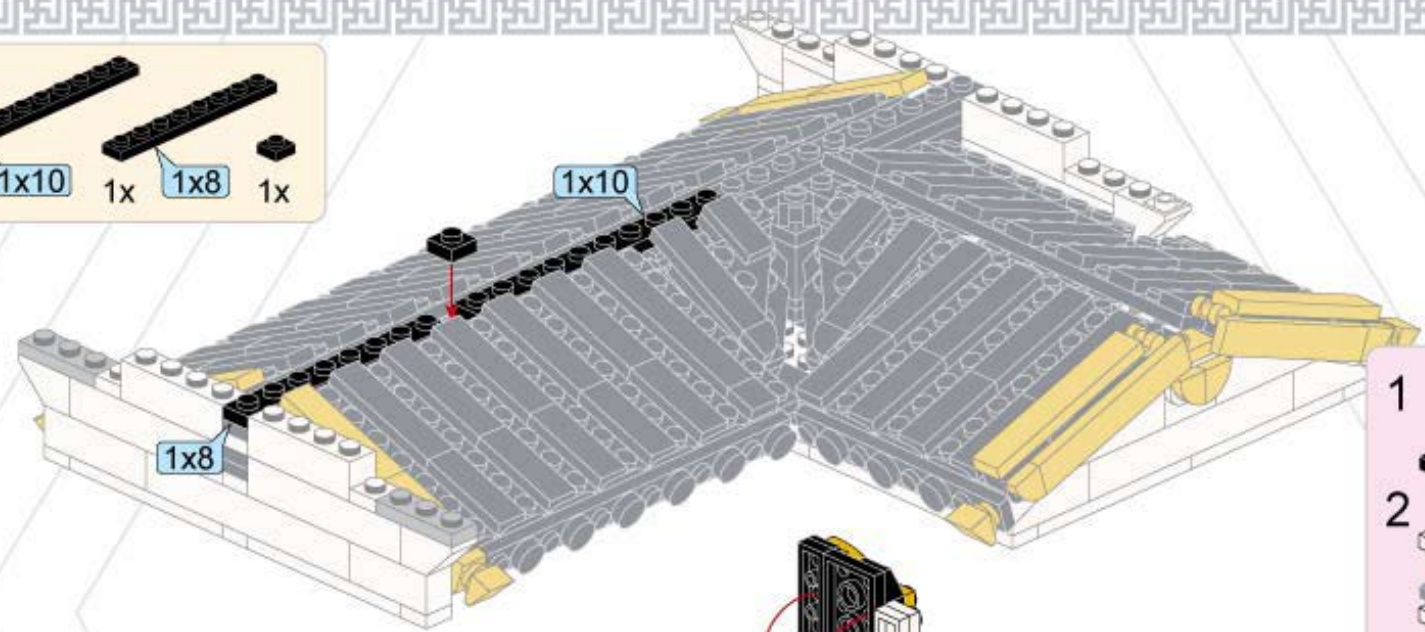

240

- 4x
- 8x
- 4x
- 16x
- 4x
- 4x
- 4x
- 4x
- 4x

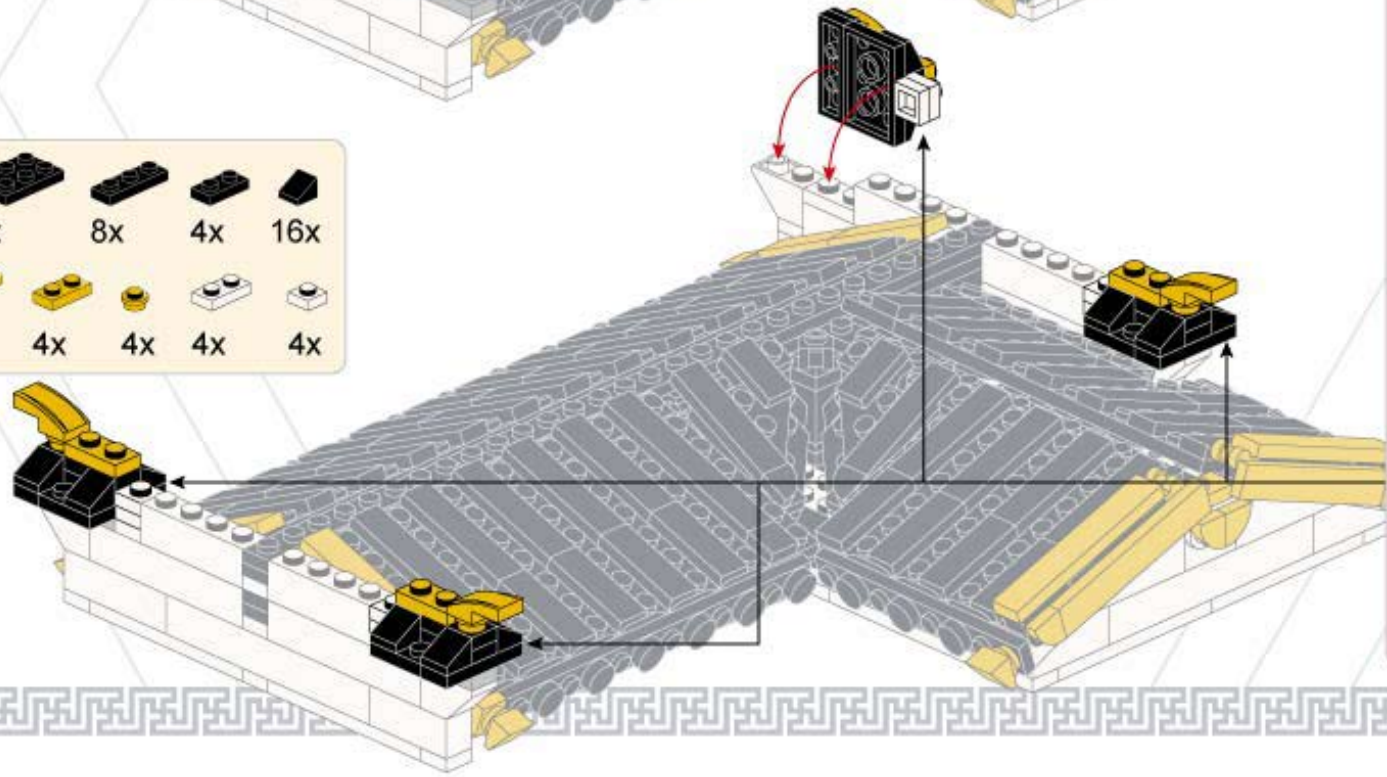

- 1
 - 2
 - 3
 - 4
 - 5
- 4x

159

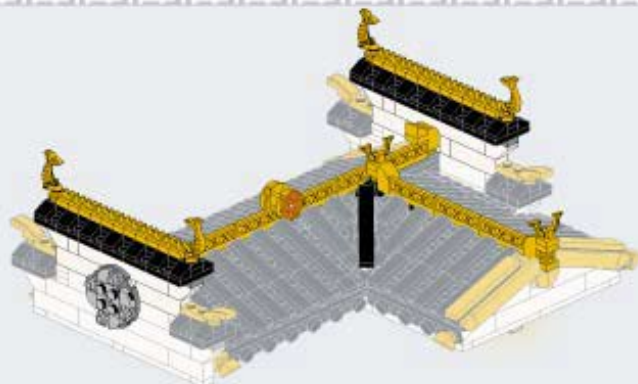

241

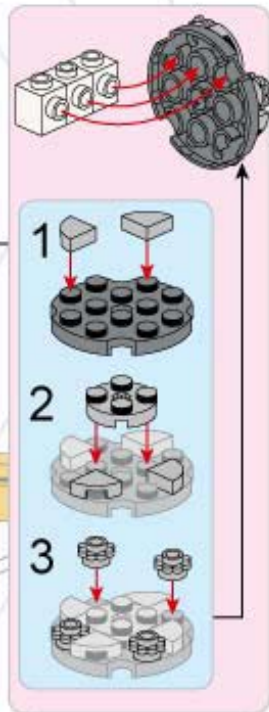
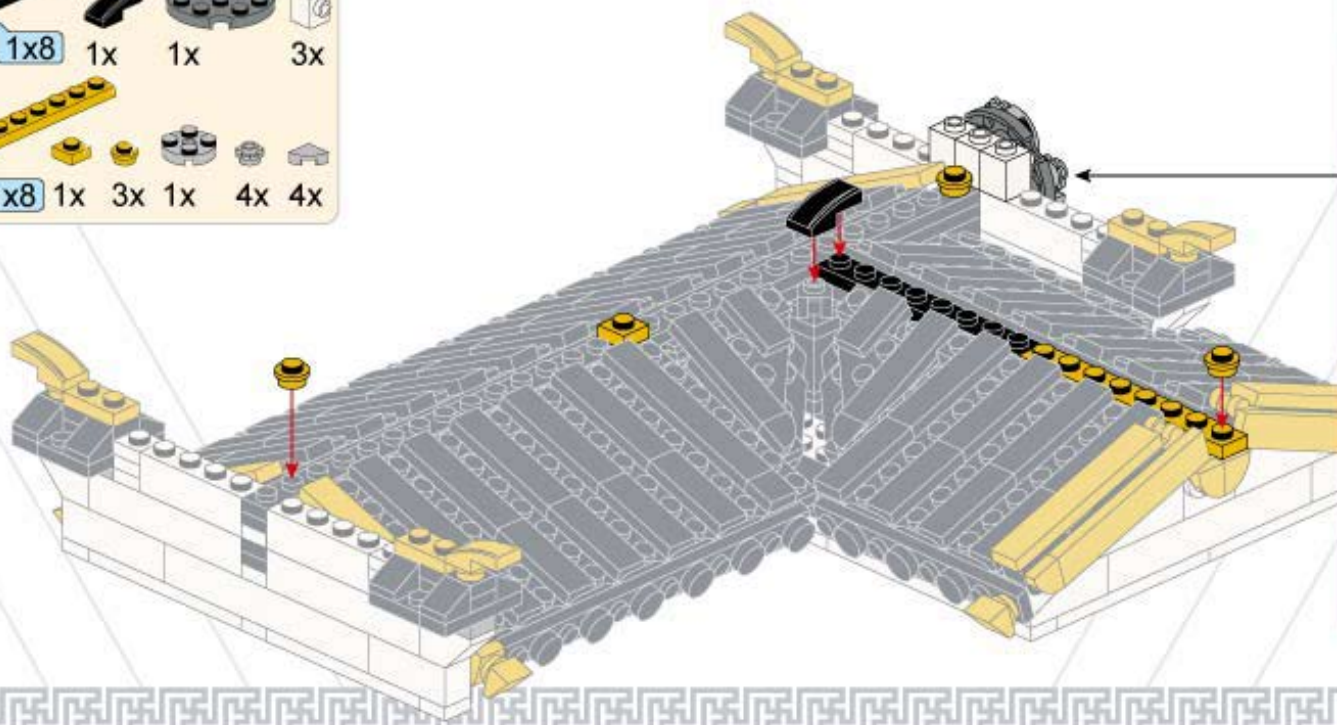
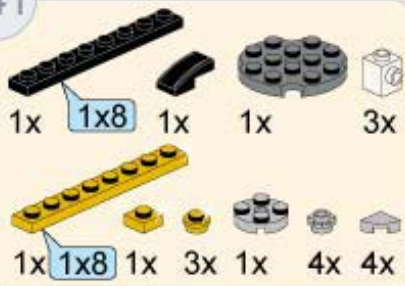

242

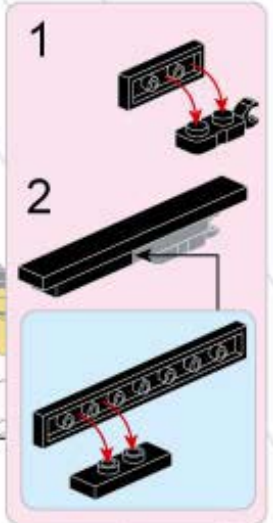
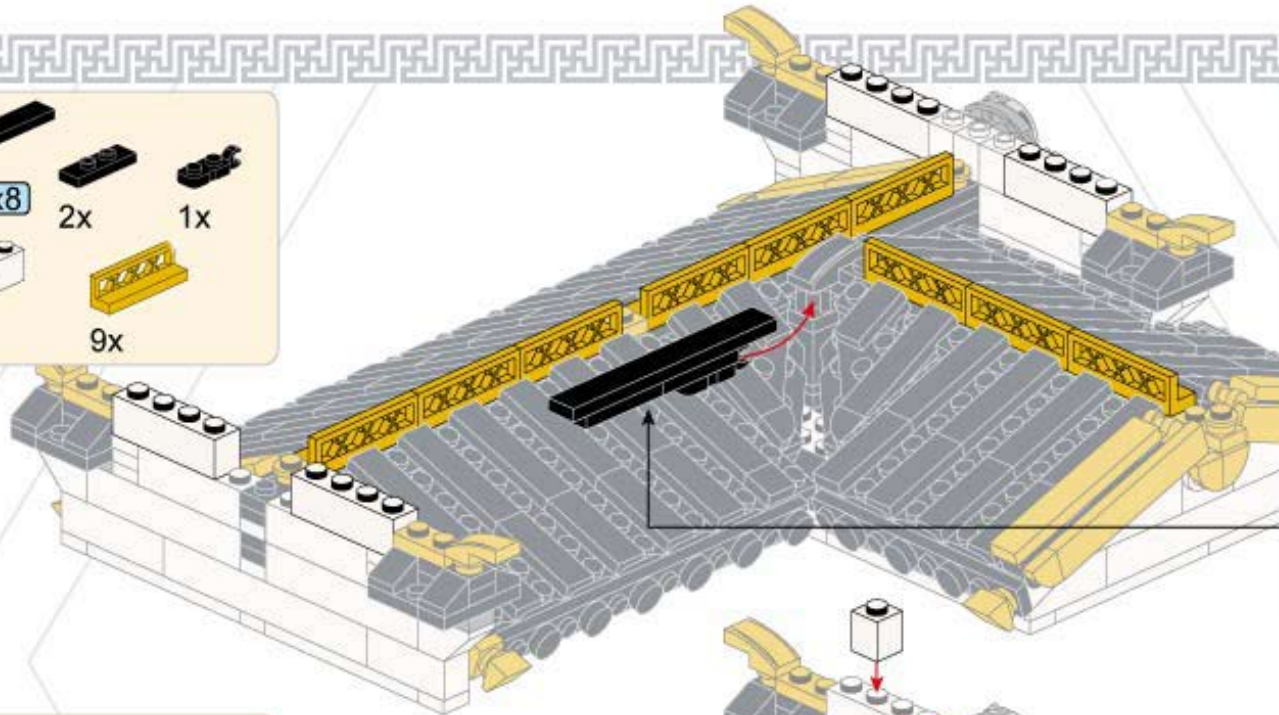
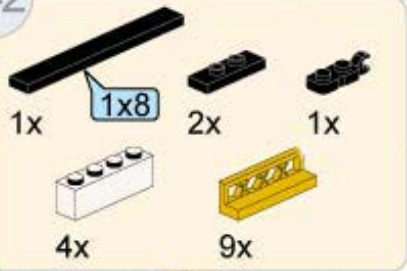

243

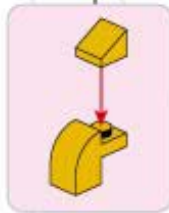
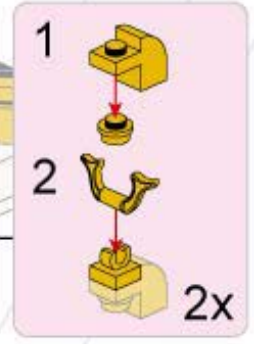
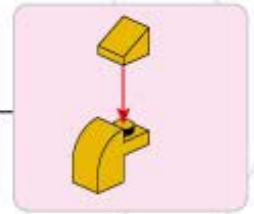
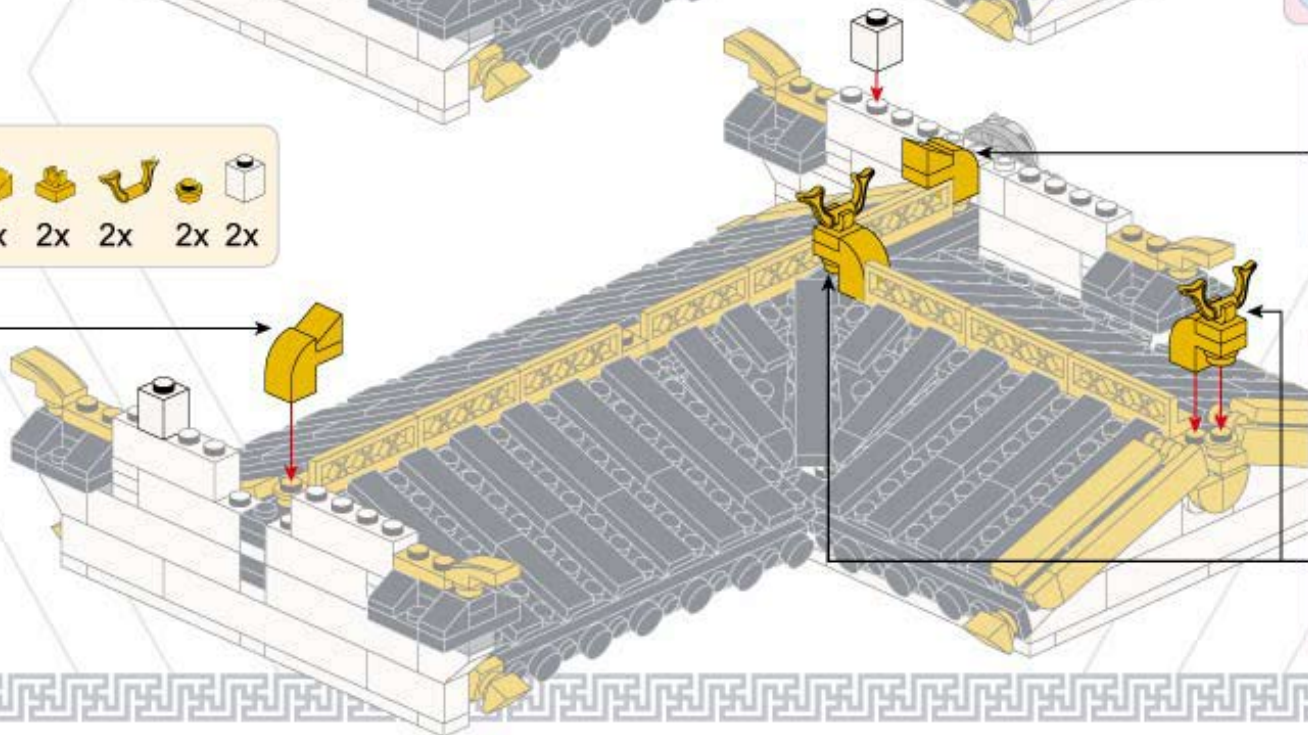
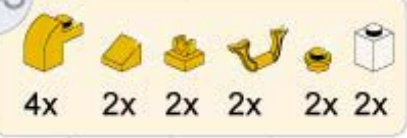

161

244

- 2x 1x8
- 4x 1x1
- 1x 1x2
- 1x 1x3
- 1x 1x4
- 1x 1x6
- 1x 1x8

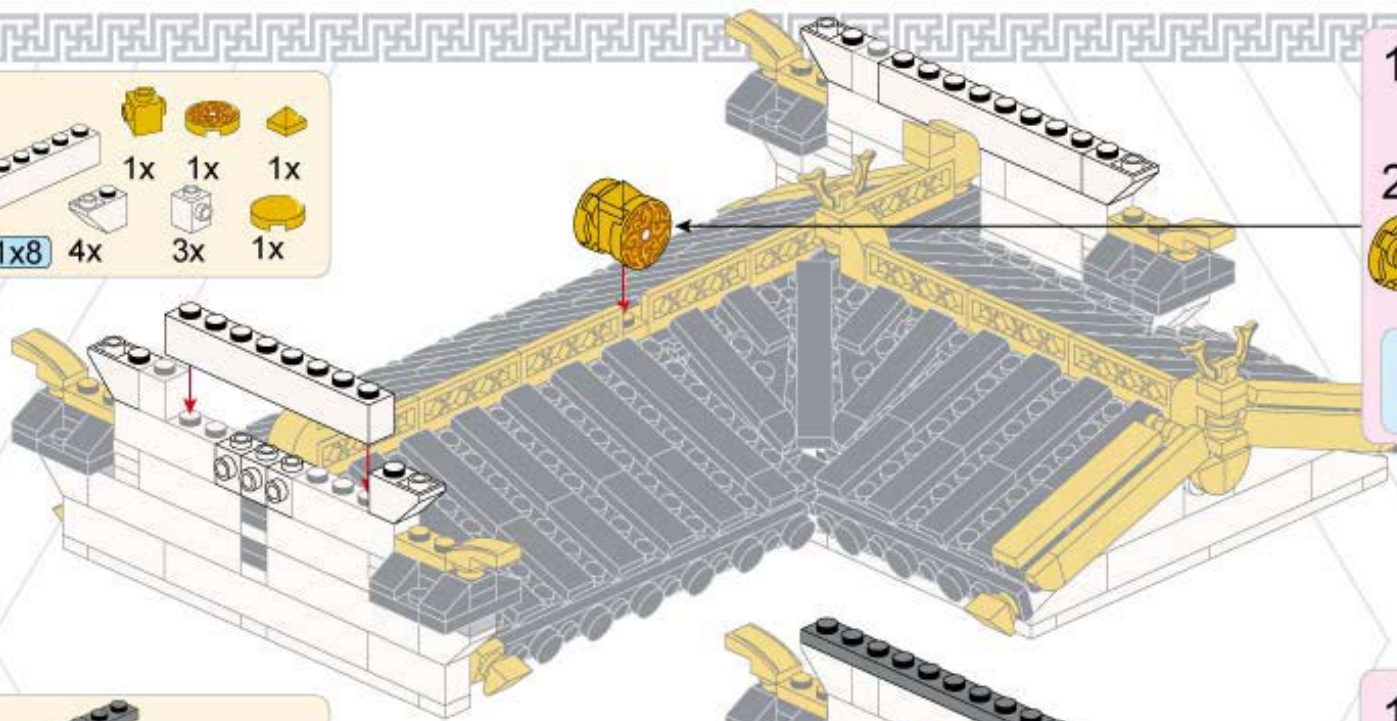

- 1
- 2

245

- 2x 1x10
- 1x 1x2
- 2x 1x3
- 1x 1x4
- 4x 1x6
- 4x 1x8

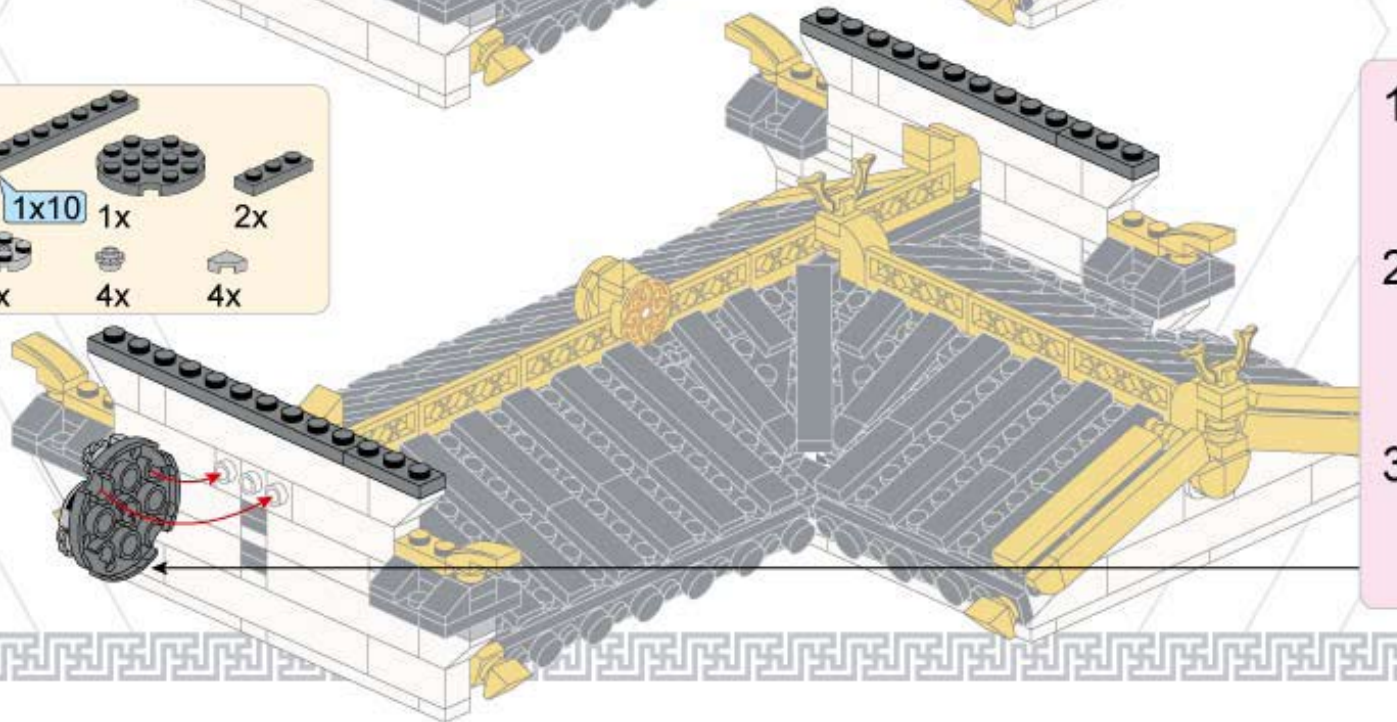

- 1
- 2
- 3

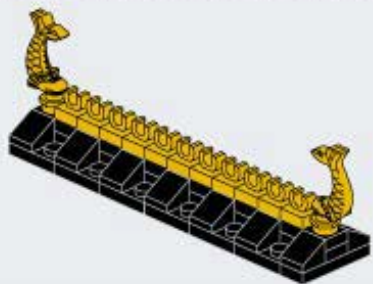

2x

246



1x 1x10 3x

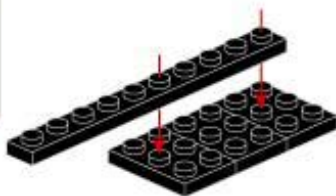

247



3x 2x

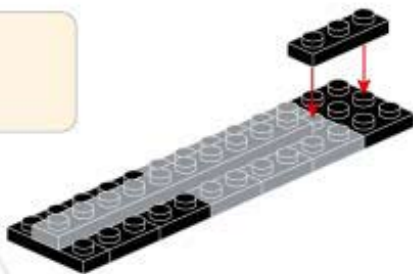

248



1x 1x10 7x

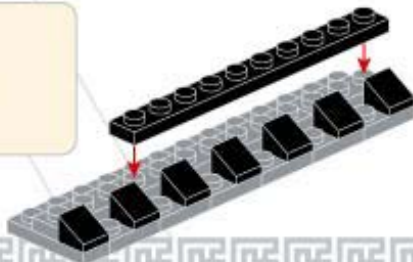

249



1x 7x 3x

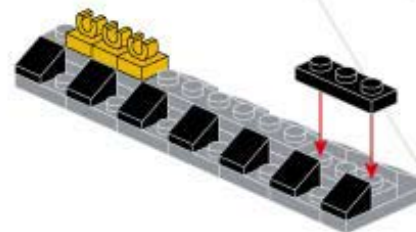

250



2x 8x 2x

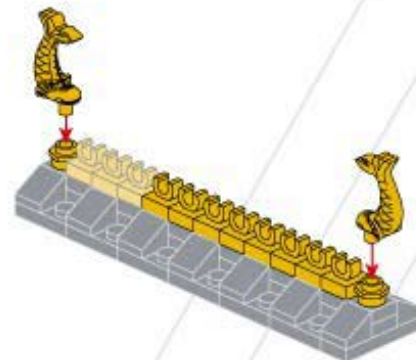

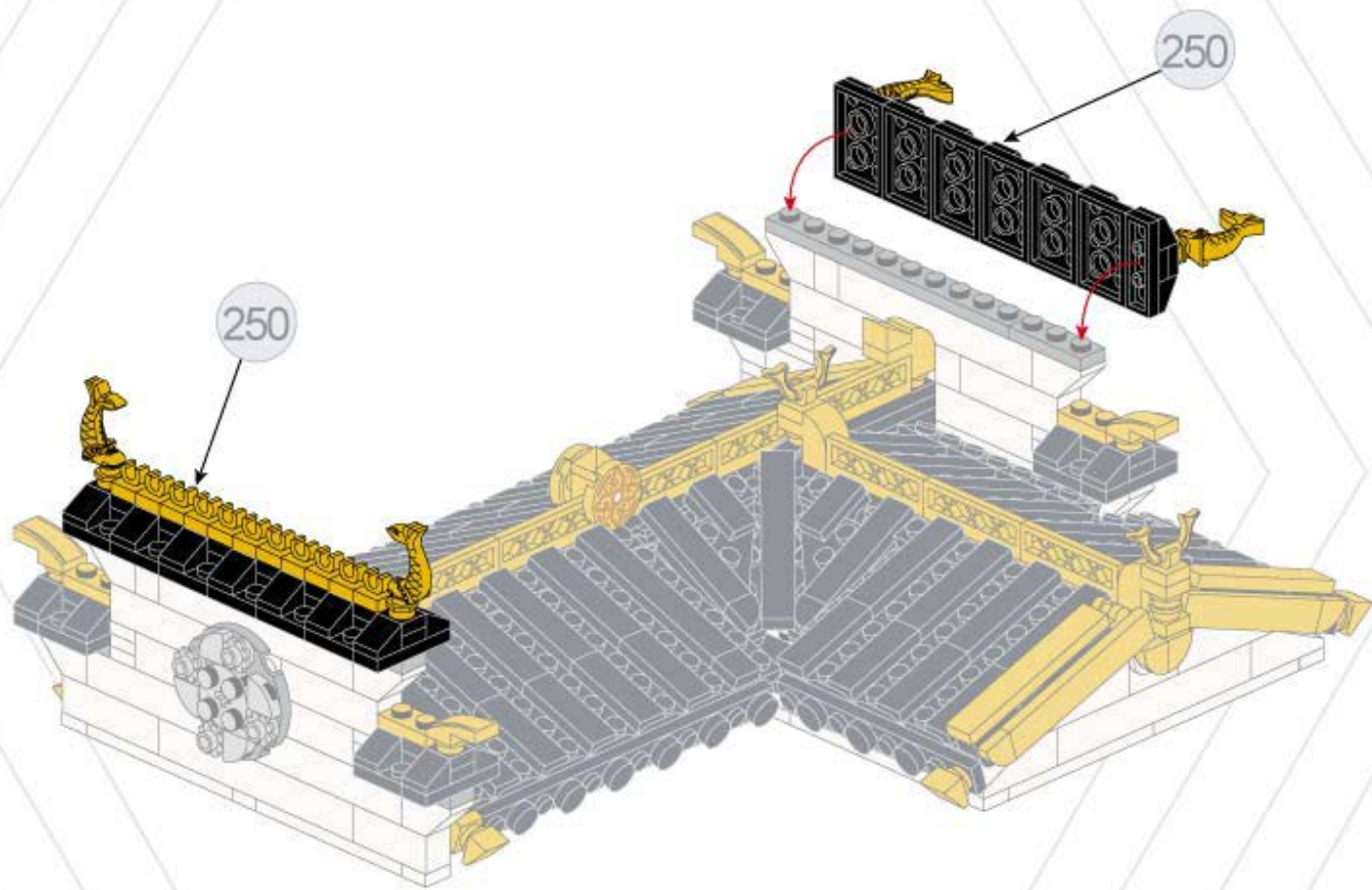

252



2x



2x

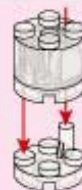
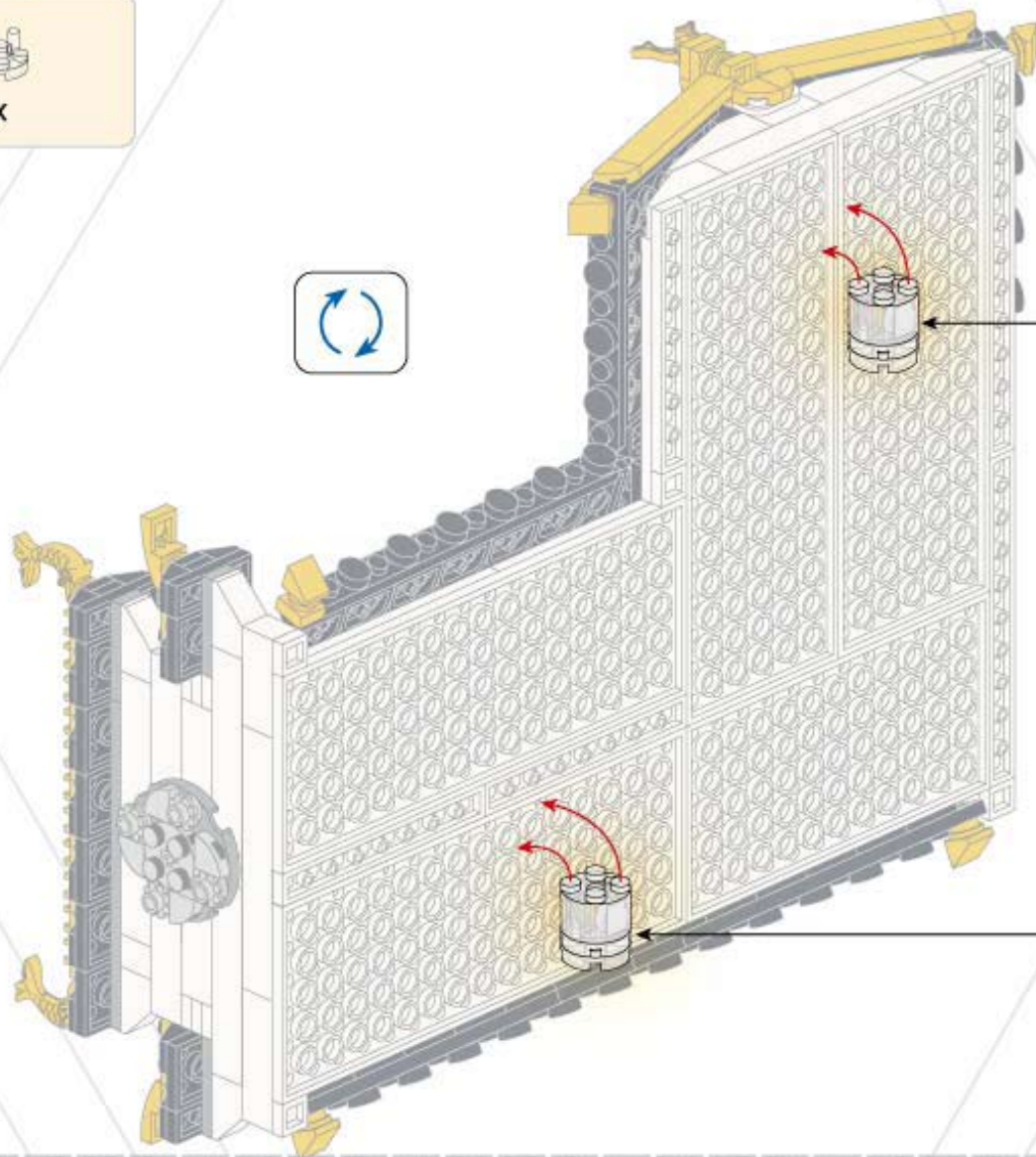

2x

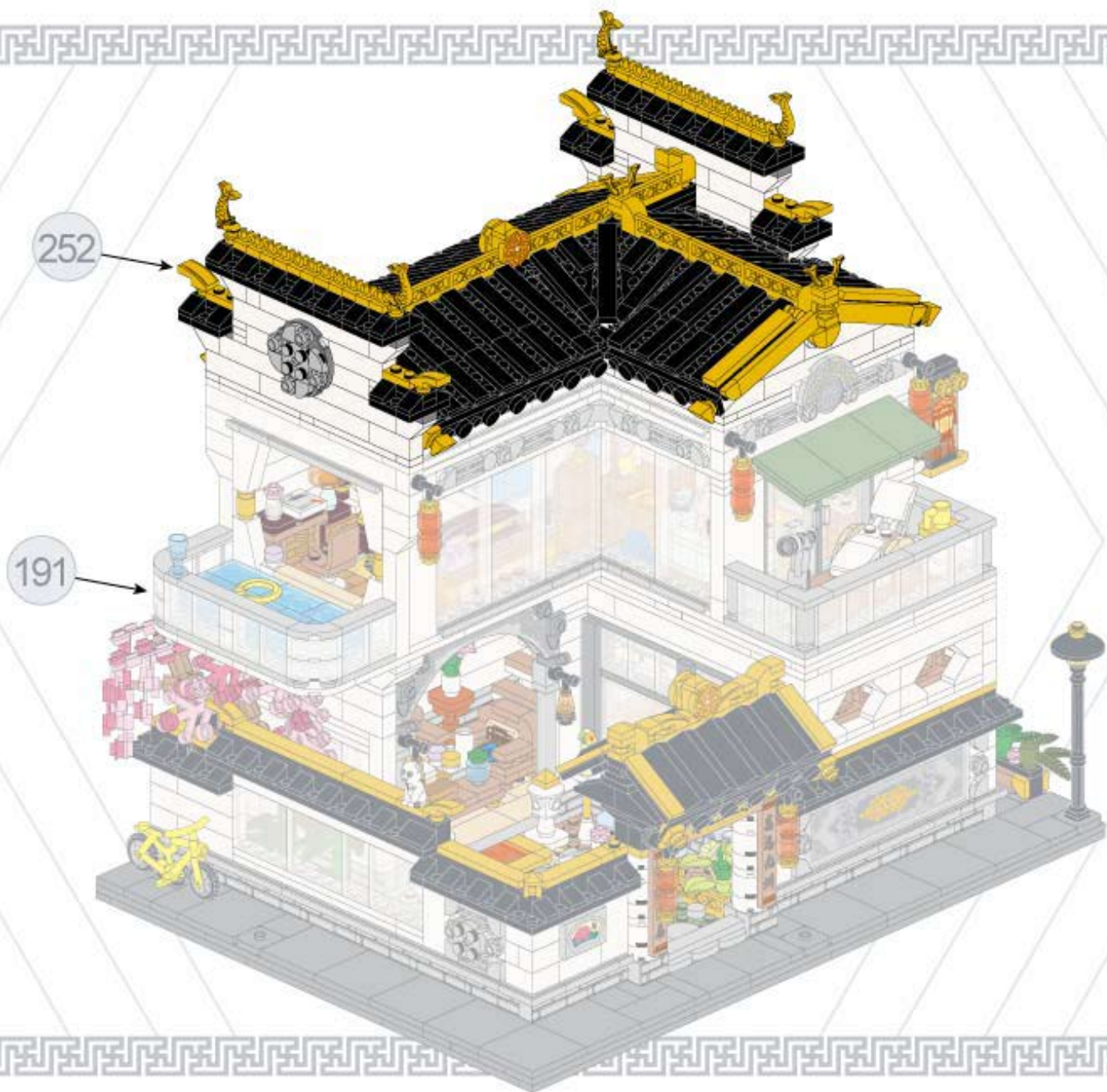

keeppley

国玩系列

精彩细节图

2F

露台无边泳池，私人享受

露台泳池



家庭娱乐，趣味非凡

二楼休闲室



小酌流水，赏山爱诗，景色怡人

一楼庭院



中式沙发，品茶香，知客趣

一楼客厅



烹饪设备齐全，品尝美味佳肴

一楼餐厅



配有咖啡机，休闲，享受阅读时光

转角吧台



喜州佳韵
可移动定制



二层

一层



瑞云小院一间全

徽派建筑是徽文化的重要组成部分，并非特指安徽建筑。徽派建筑布局依山就势，构思精巧，规模灵活，变幻无穷；建筑造型丰富，讲究韵律美，以马头墙、小青瓦最具特色；综合运用了雕刻艺术，融石雕、木雕、砖雕为一体，整体富丽堂皇。而瑞云小院为独特的徽派特色韵味民宿，马头墙造型别致有代表性，外部为传统古式外观，内部为现代民宿，两者巧妙融合，风格独特。

