

启蒙

33013

年龄: 6+

人仔数: X2

片数: 293

九州
芳华录

当窗理云鬓
对镜帖花黄

花木兰



图片仅供参考, 请以实物为准。

木兰闺房

南北朝时期，北方游牧民族不断南下骚扰，北魏政权规定每家必须出一男丁参军入伍。但花木兰家中父亲年事已高，弟弟尚还年幼，两难之下花木兰决定女扮男装，替父参军。从军数十年后，花木兰凯旋而归，北魏皇帝念其军功赦免花木兰欺君之罪，并应她请求，准她回乡侍奉双亲。花木兰替父从军，抵御外来侵略者守卫家园的故事千古流传，古诗《木兰辞》就是根据花木兰的故事而作。

本产品设计取自《木兰辞》“当窗理云鬓，对镜帖花黄”一句，再现木兰立军功衣锦还乡，在卧室梳妆打扮，恢复女儿身的场景。

九州
芳华录



拆件器使用方法，仅为示例
Usage of Brick Separator, Just for the sample

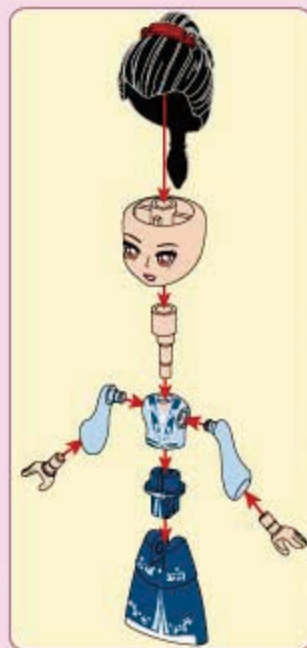
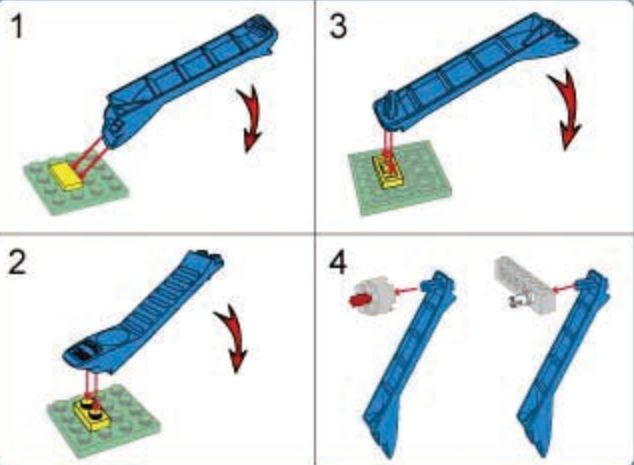

1

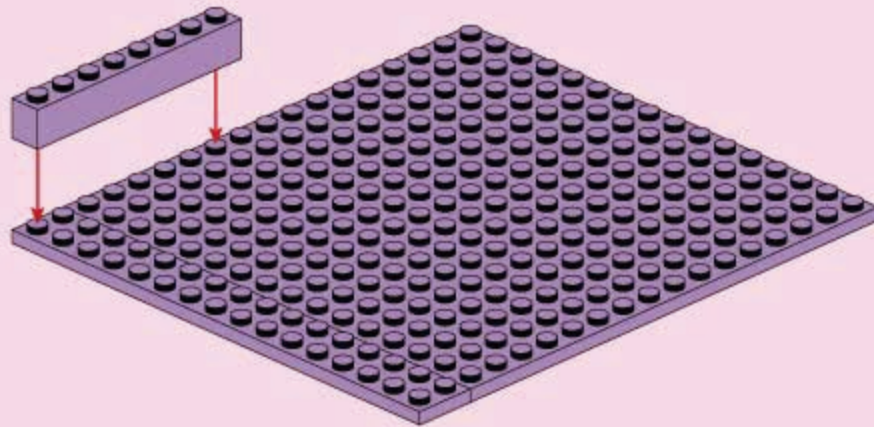
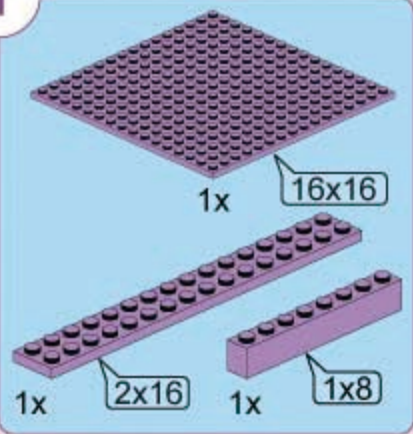

2

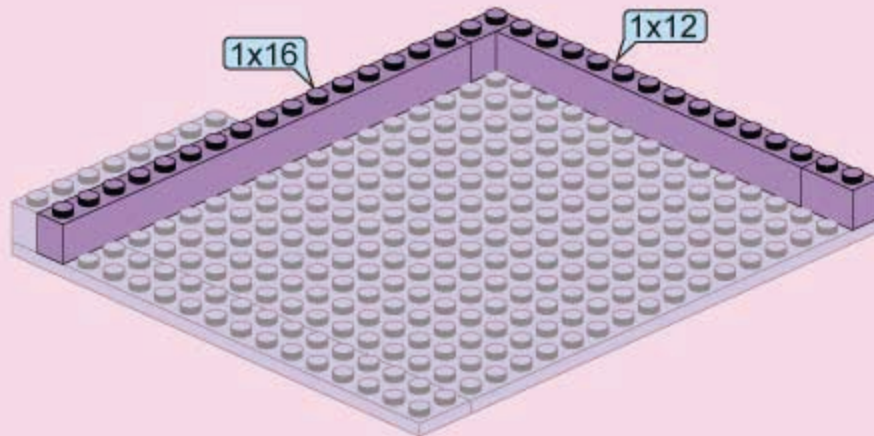
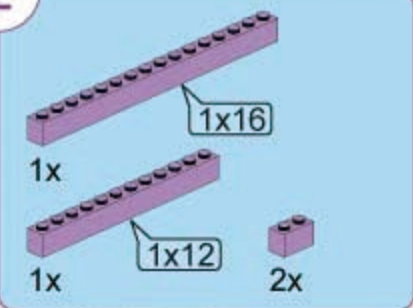

3



3

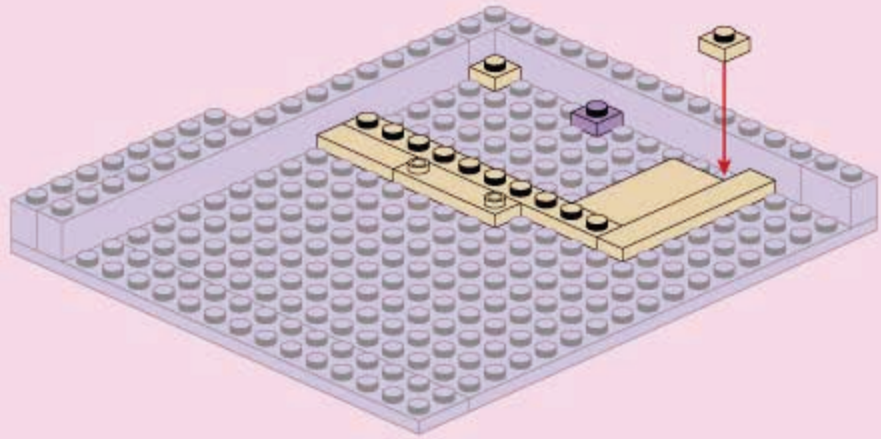
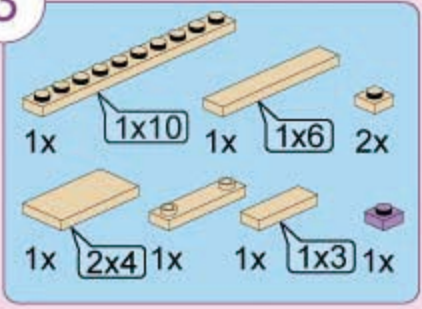

4

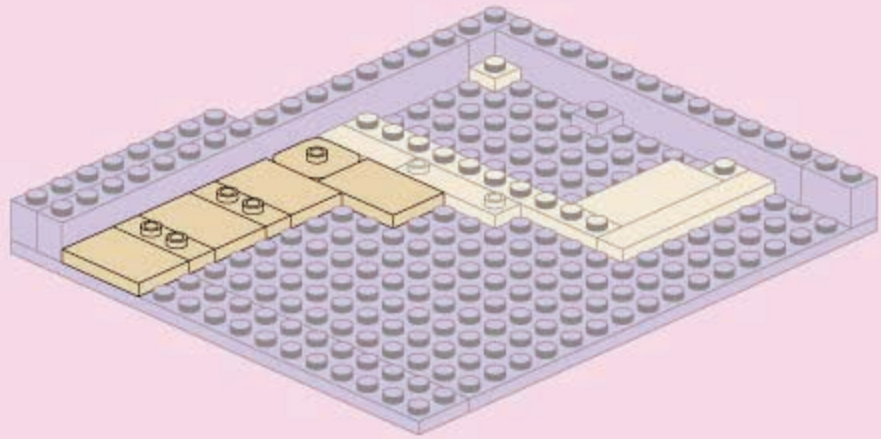
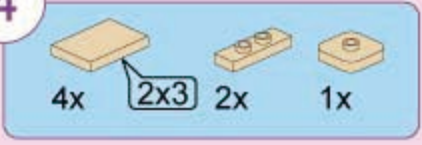

5

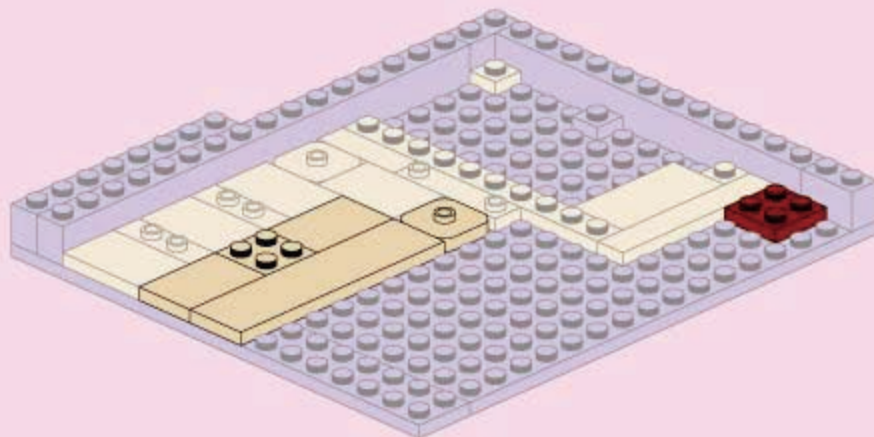
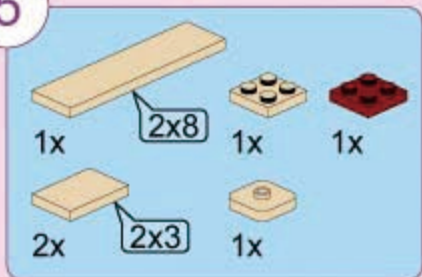

6

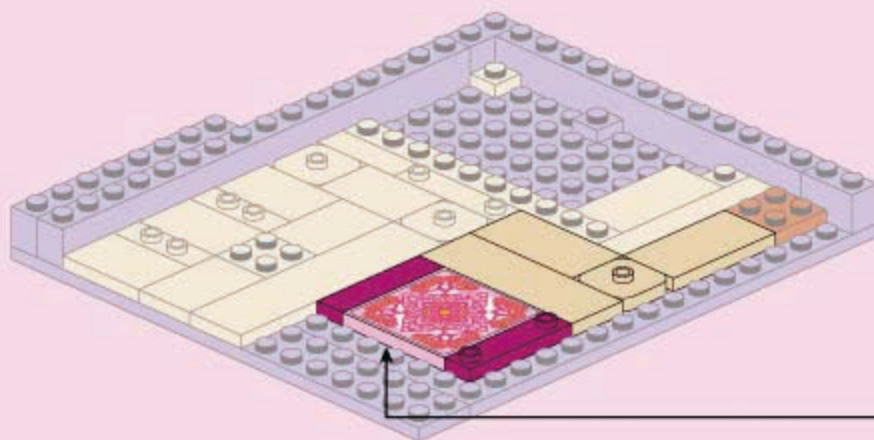
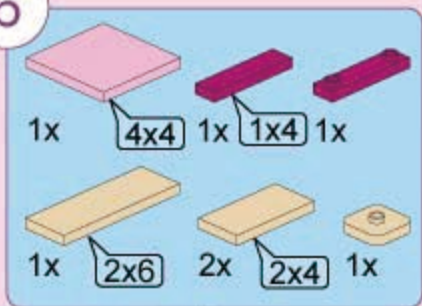

7

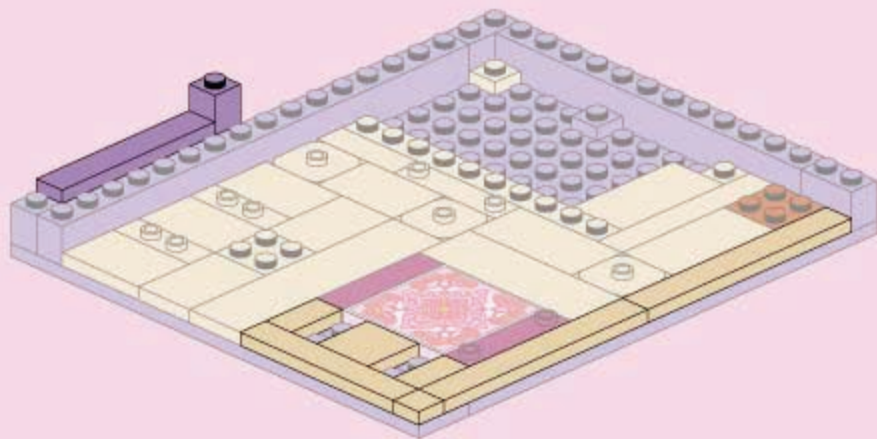
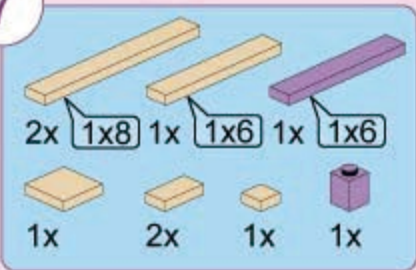

8

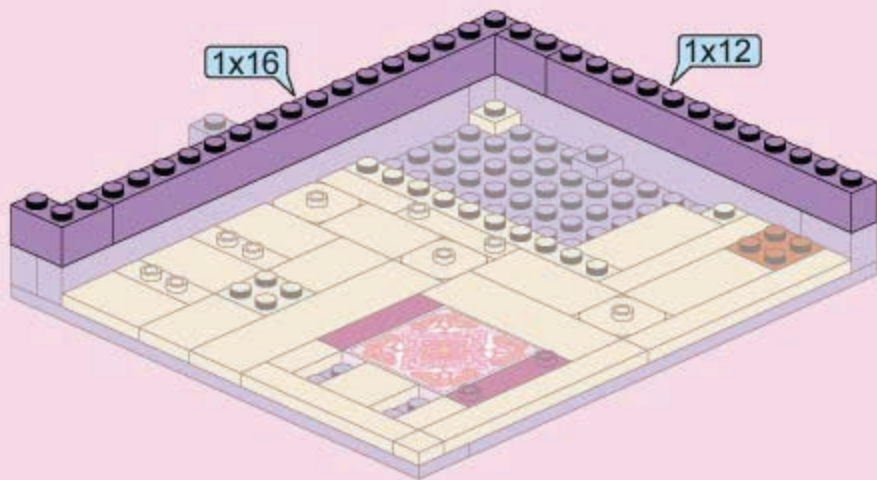
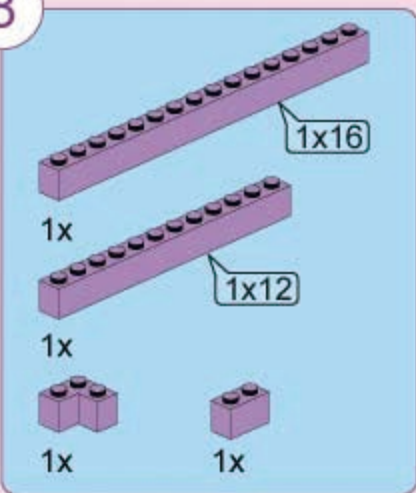

9

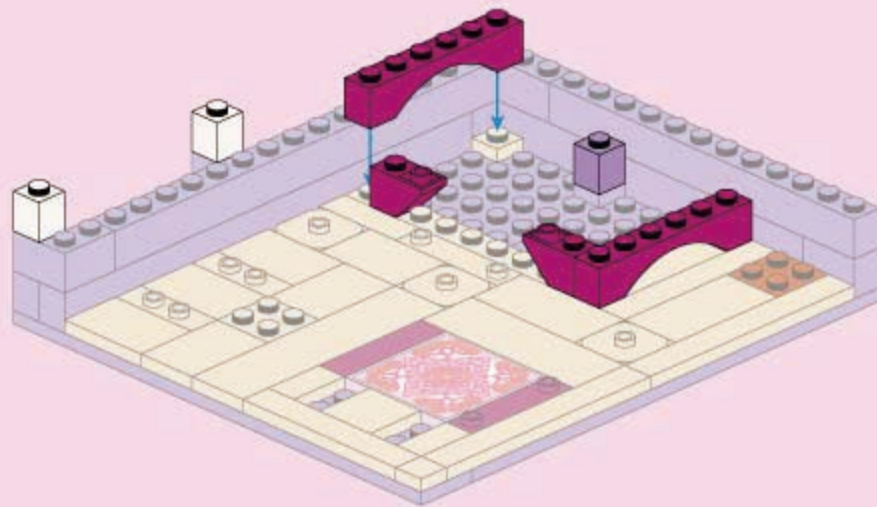
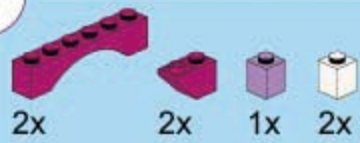

10

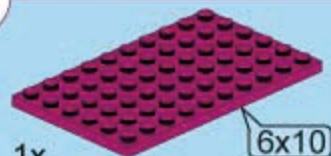

6x10

1x



2x



2x

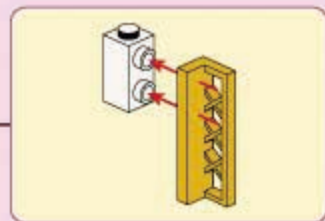
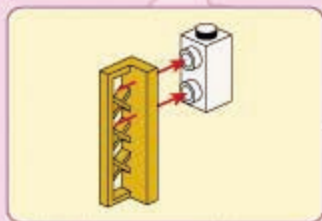
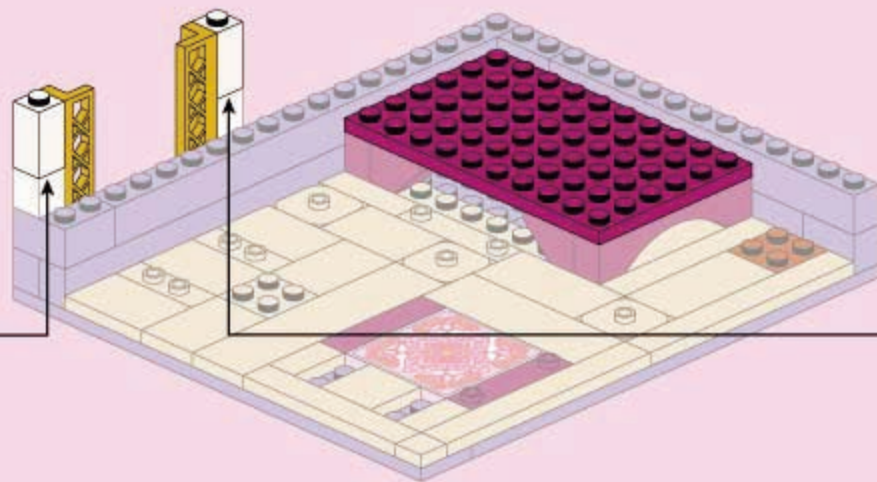



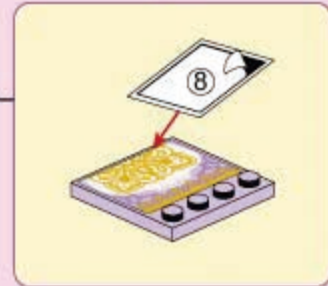
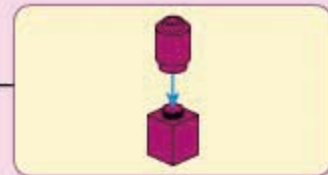
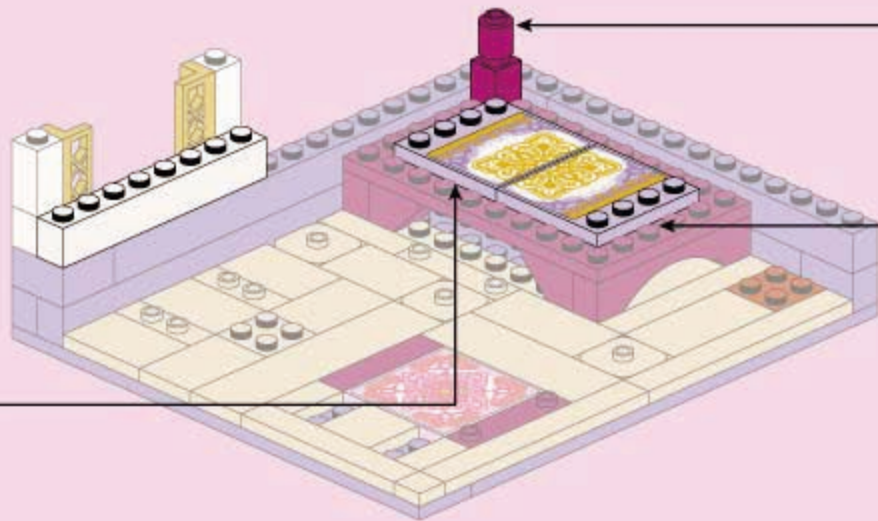
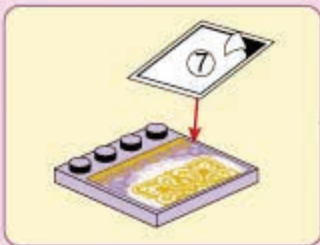
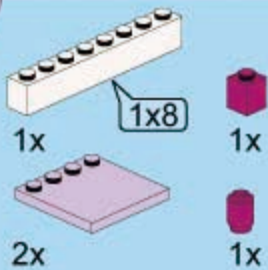



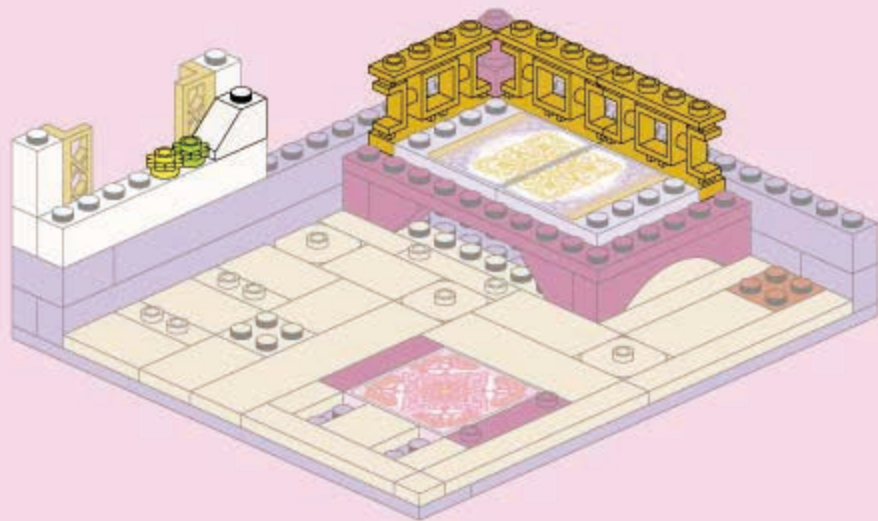

11



12







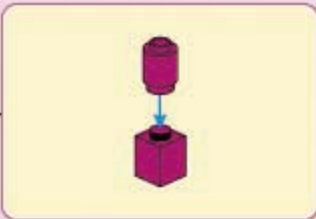
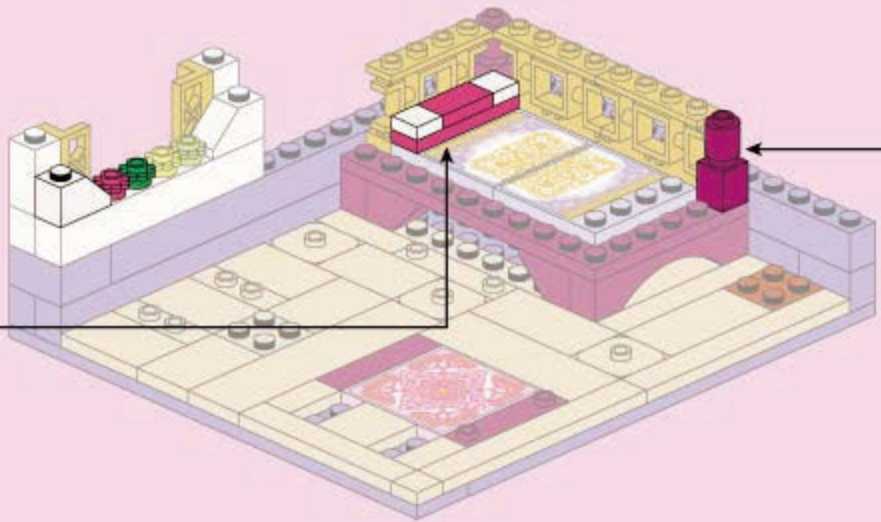
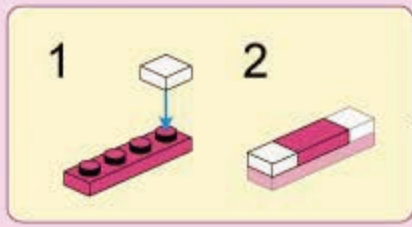

13

- 1x 
- 1x 
- 1x 
- 1x 
- 1x 
- 2x 
- 1x 
- 1x 



14

- 1x 
- 1x 
- 1x 
- 2x 
- 2x 
- 2x 

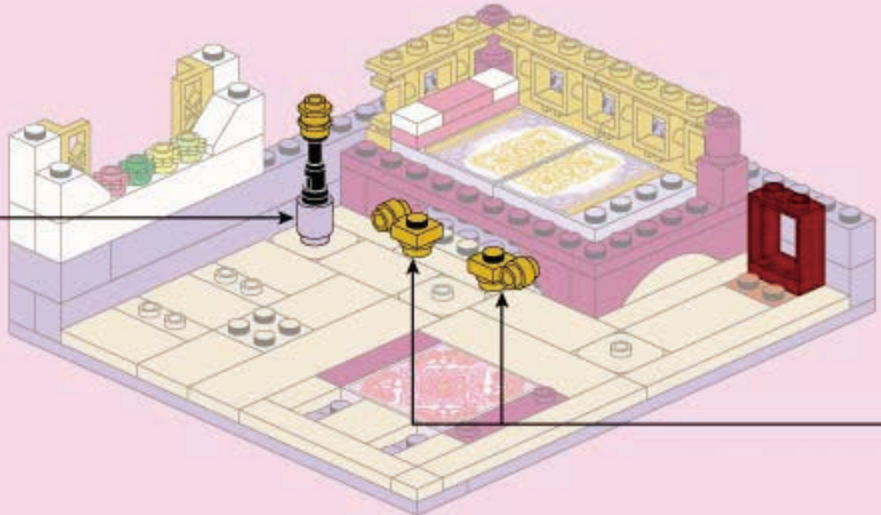
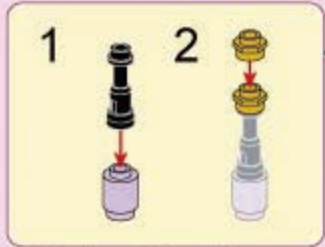

15

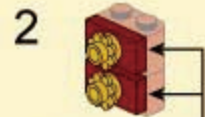
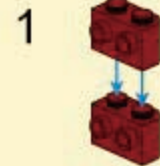
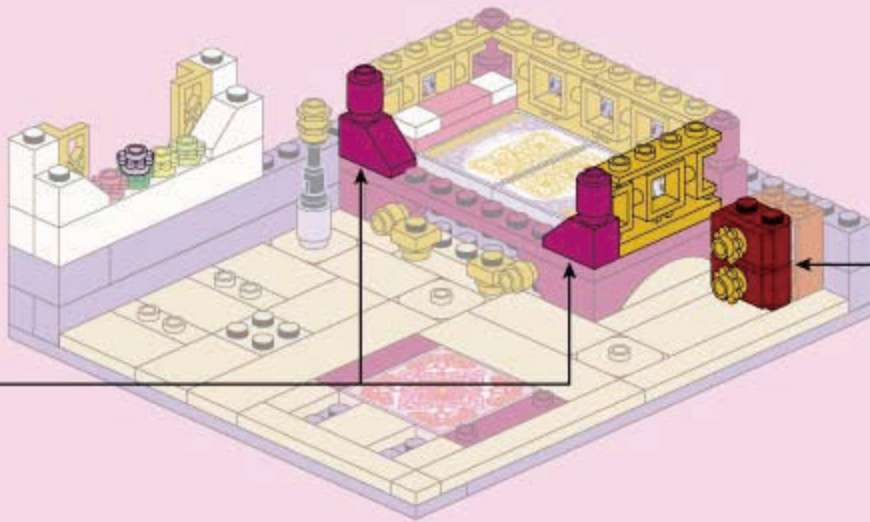
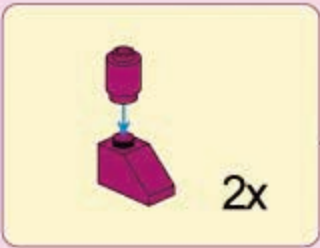
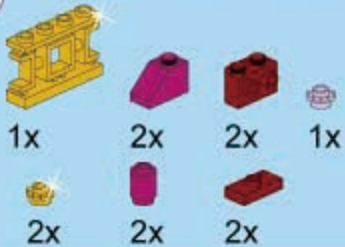

16

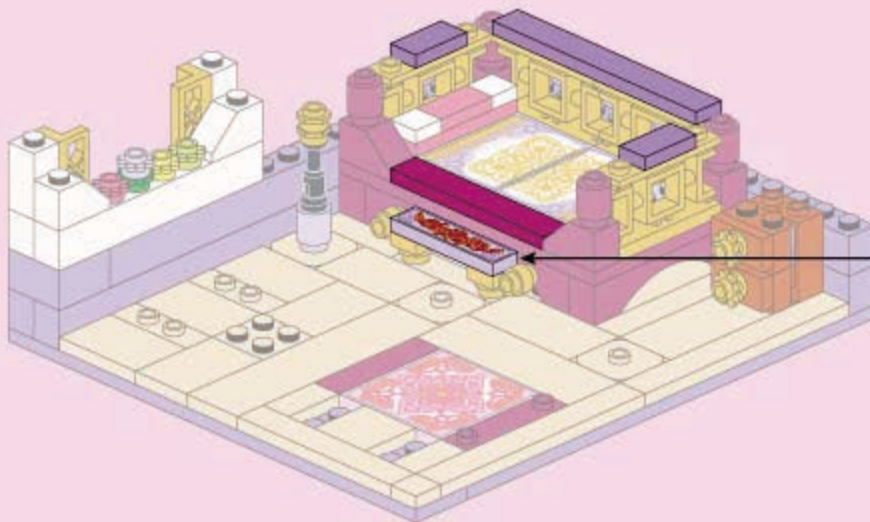
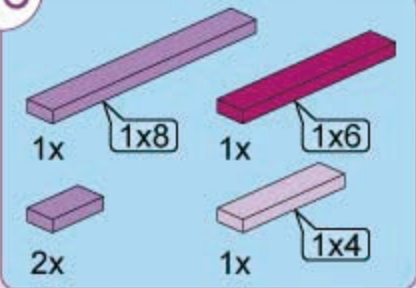

17



1x



1x



1x



1x

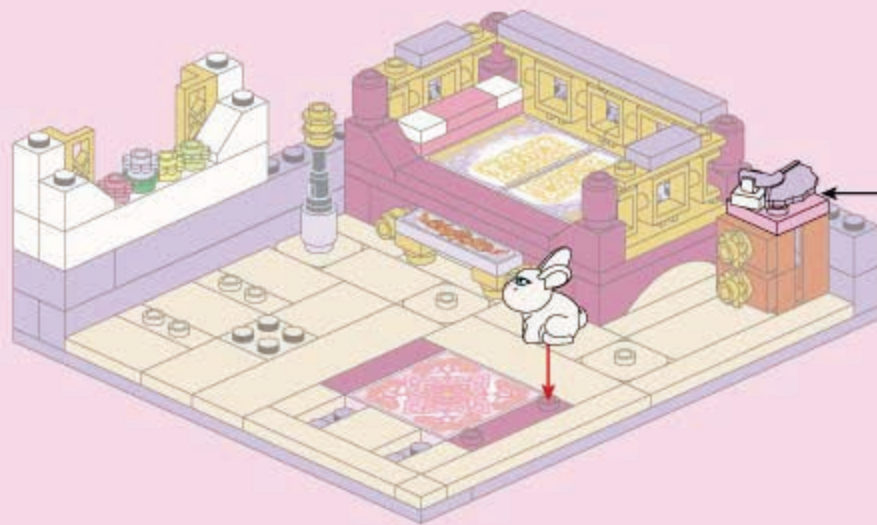

1



2



18



2x



2x



1x



1x

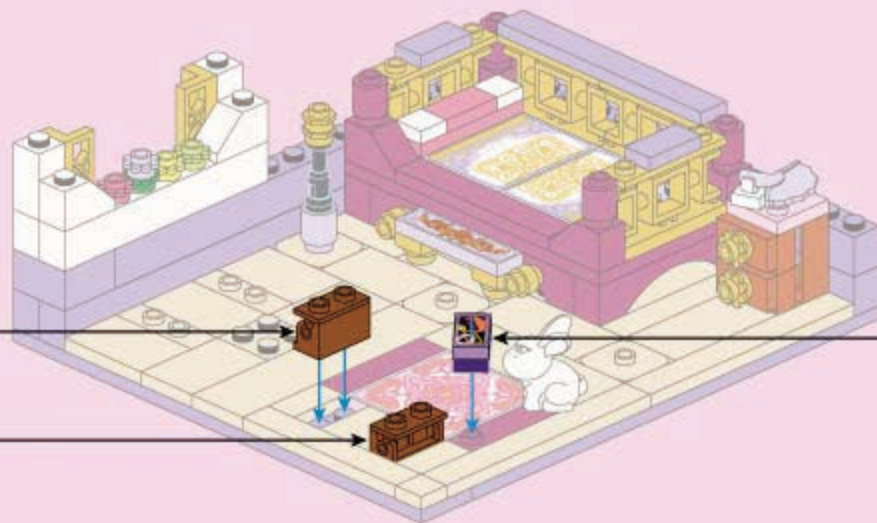

2x



19

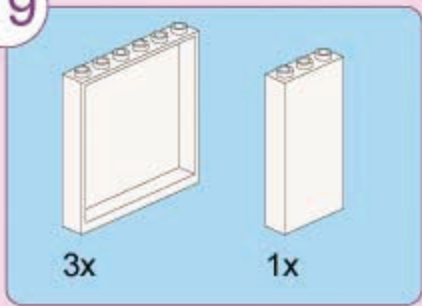

20

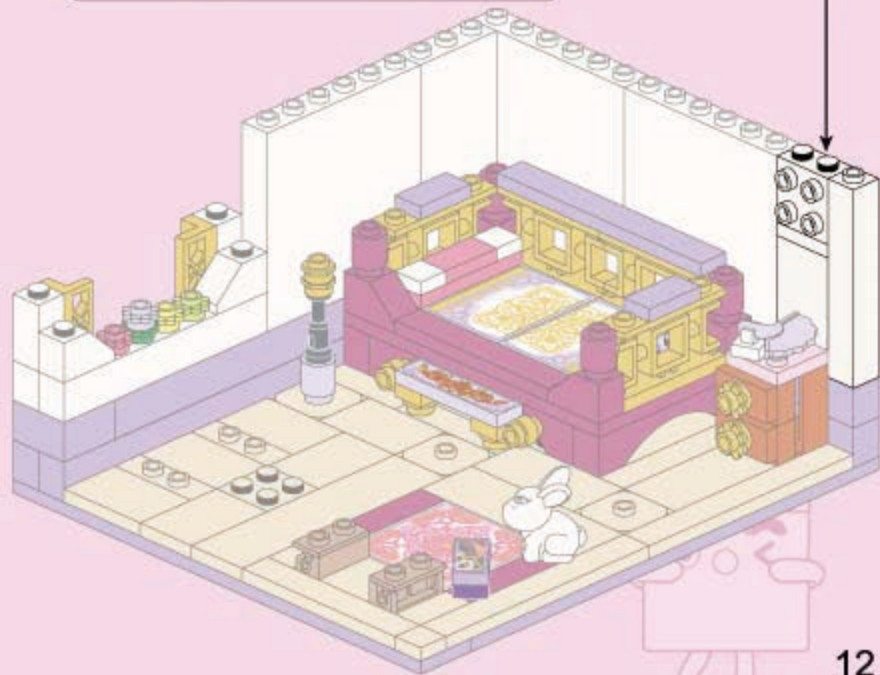
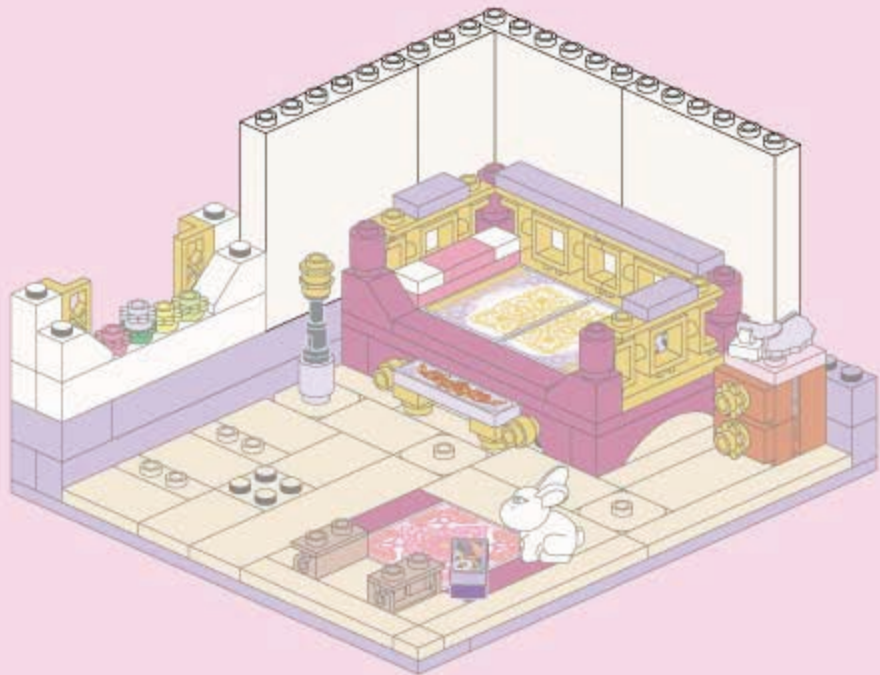
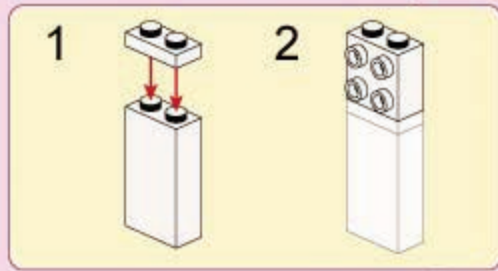
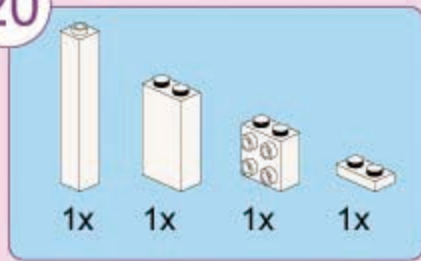



21



1x



2x



22

- | | | |
|---|---|---|
|  |  |  |
| 2x | 2x | 2x |
|  |  |  |
| 1x | 2x | 1x |
|  |  |  |
| 1x | 1x | 2x |
|  |  |  |
| 1x | 1x | 1x |

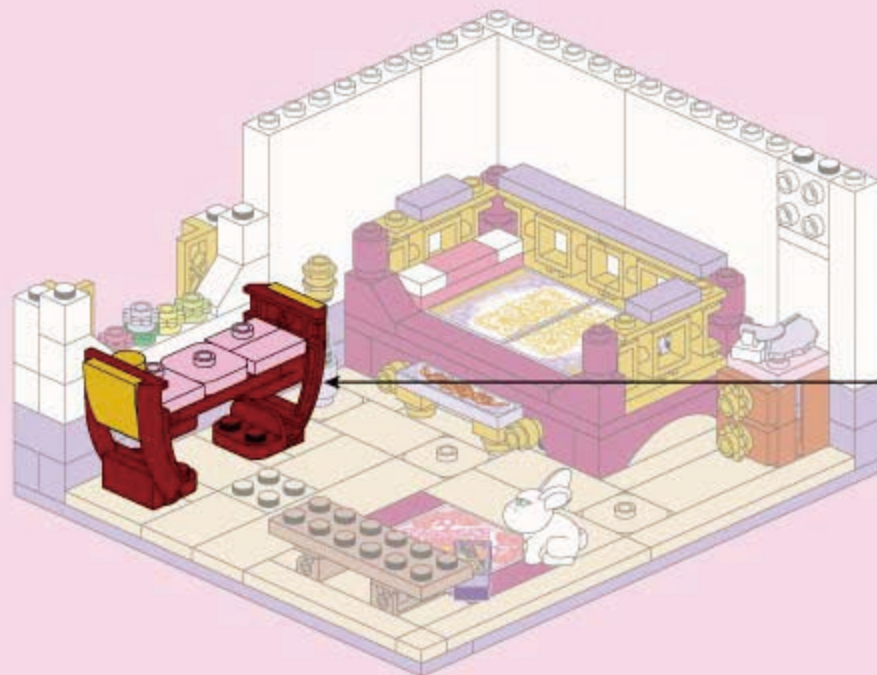

1



2

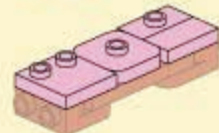

3

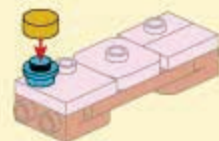

4

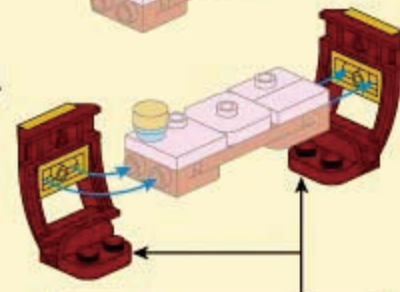

1

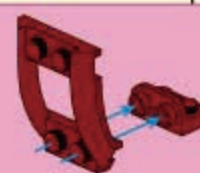

2

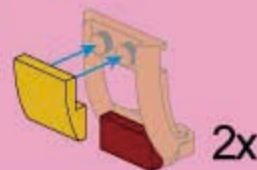

23



4x

2x

1 2

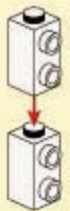

1 2

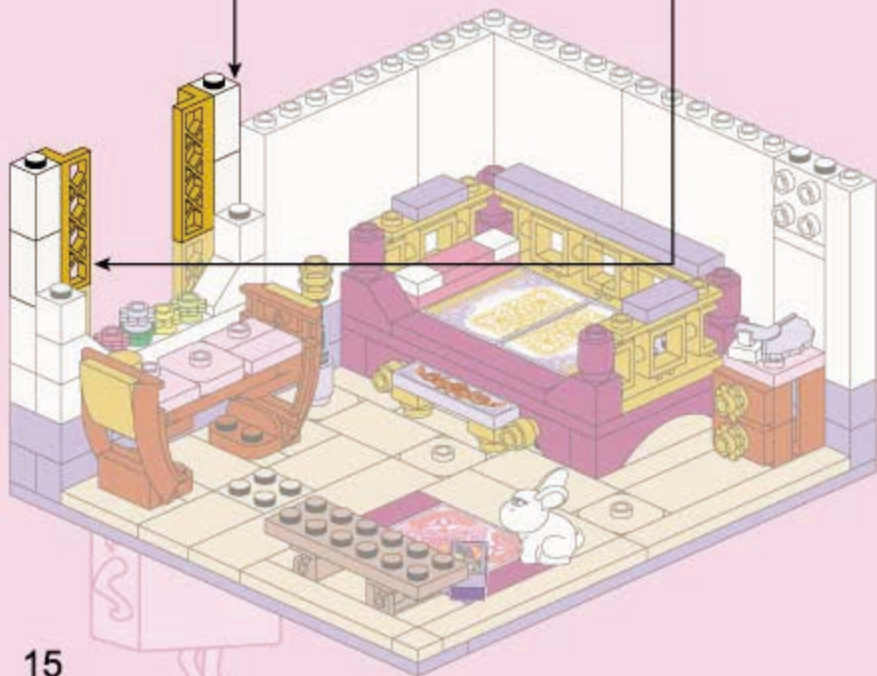
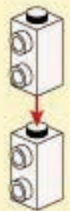

24



1x

1x

1x

2x



1 2 3



25

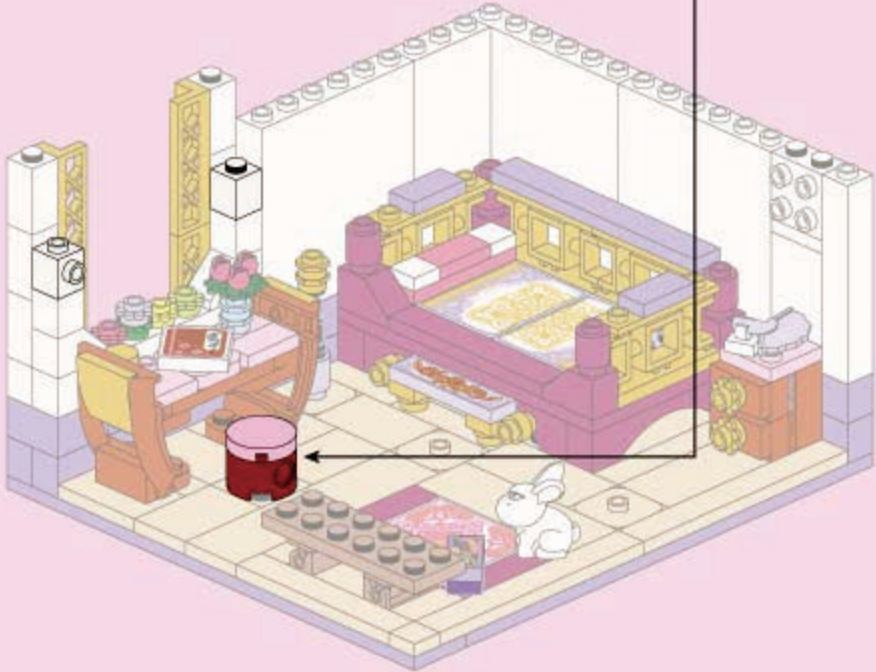

26

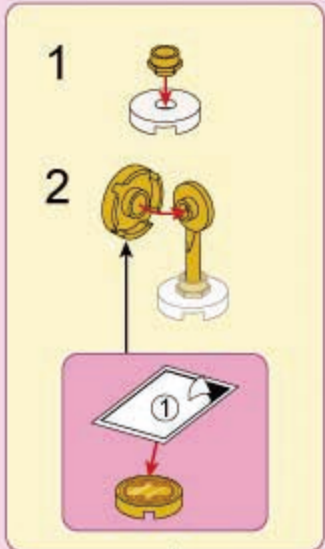
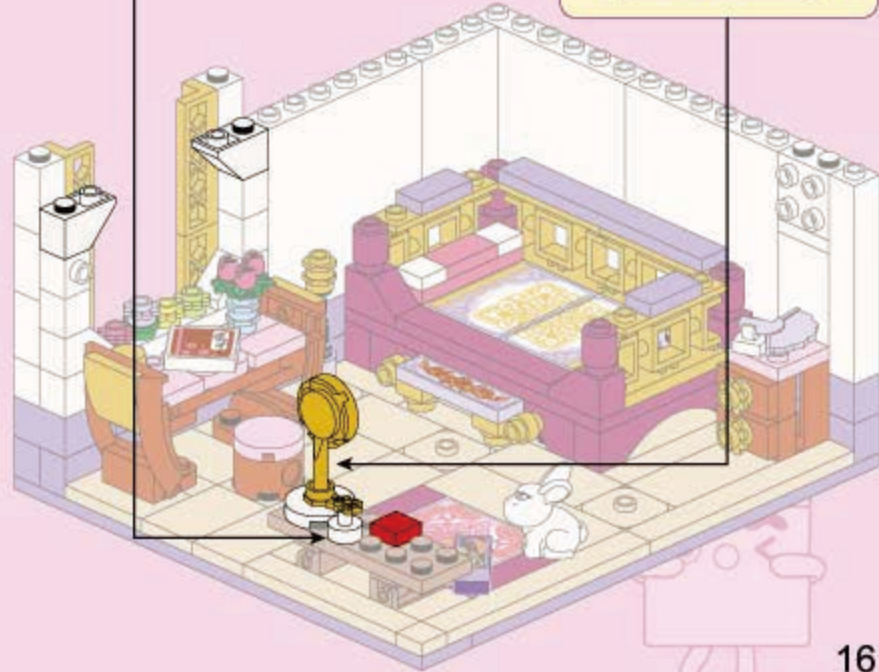
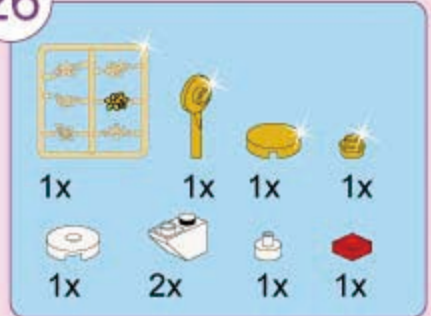

27

1x 1x10

1x 1x8

1x 1x2

1x 1x1

1x 1x2

1x 1x1

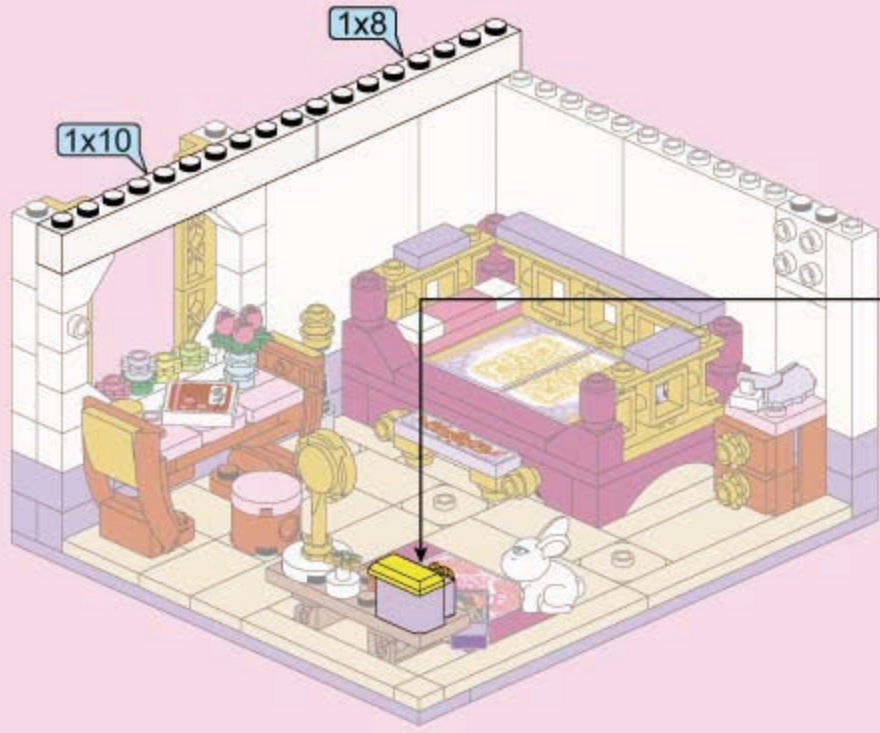

1

2

1

2



28

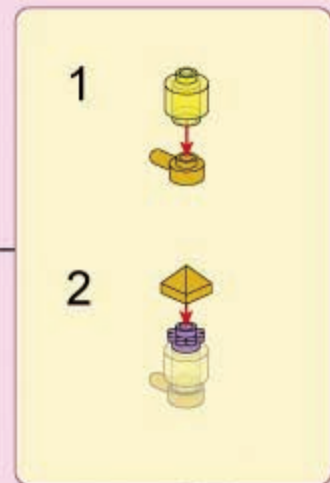
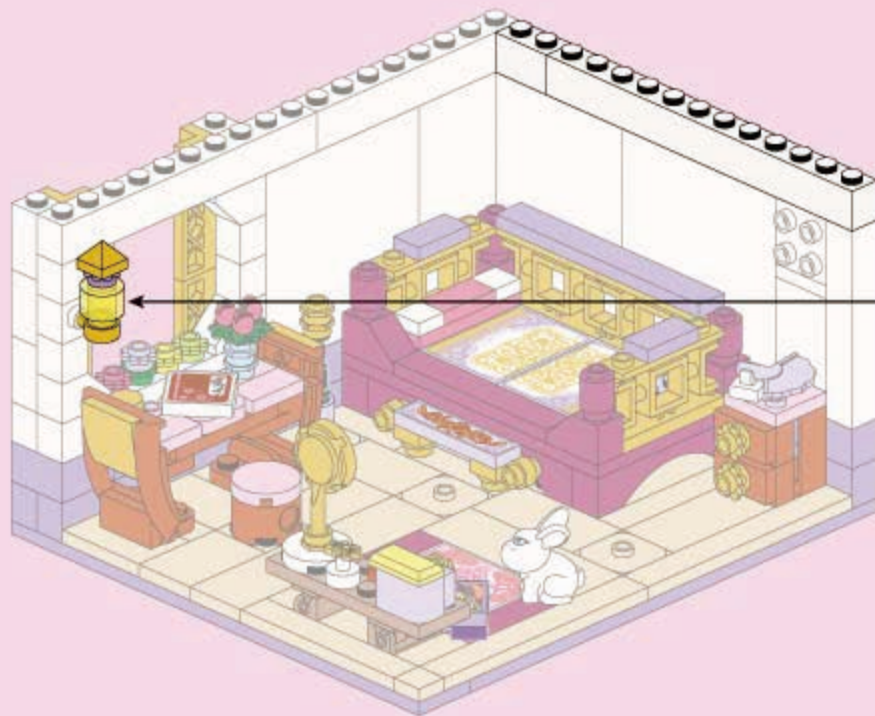
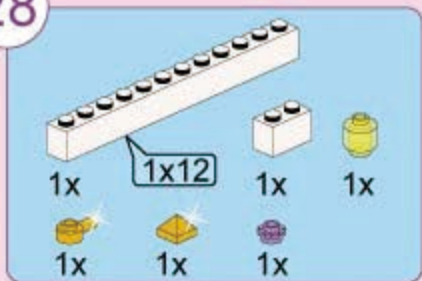

29

2x 4x 2x 2x

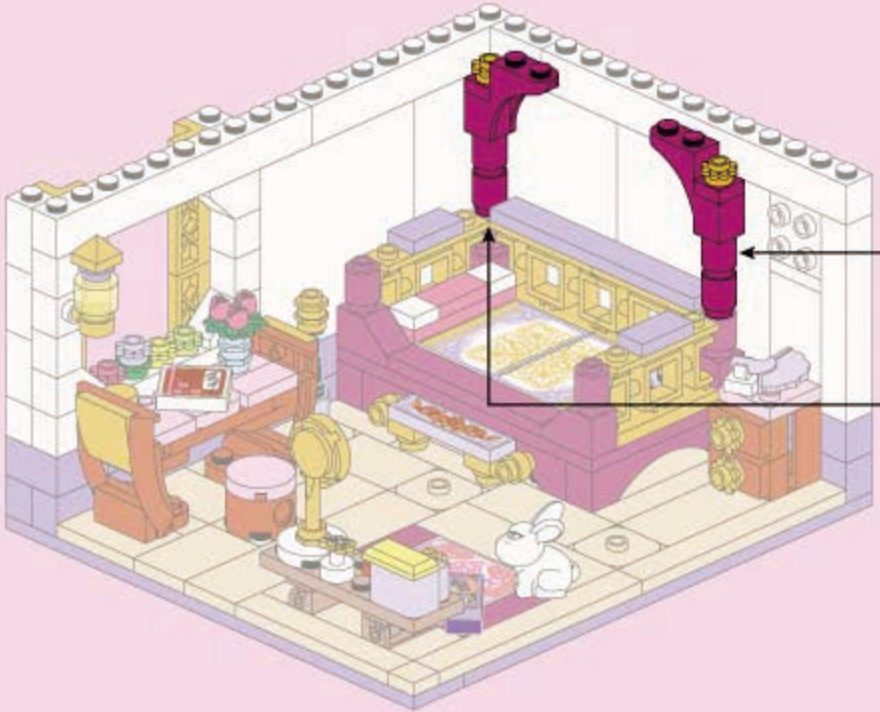

1







2

3

2x



30

 1x	 1x	 4x
 4x	 4x	 4x

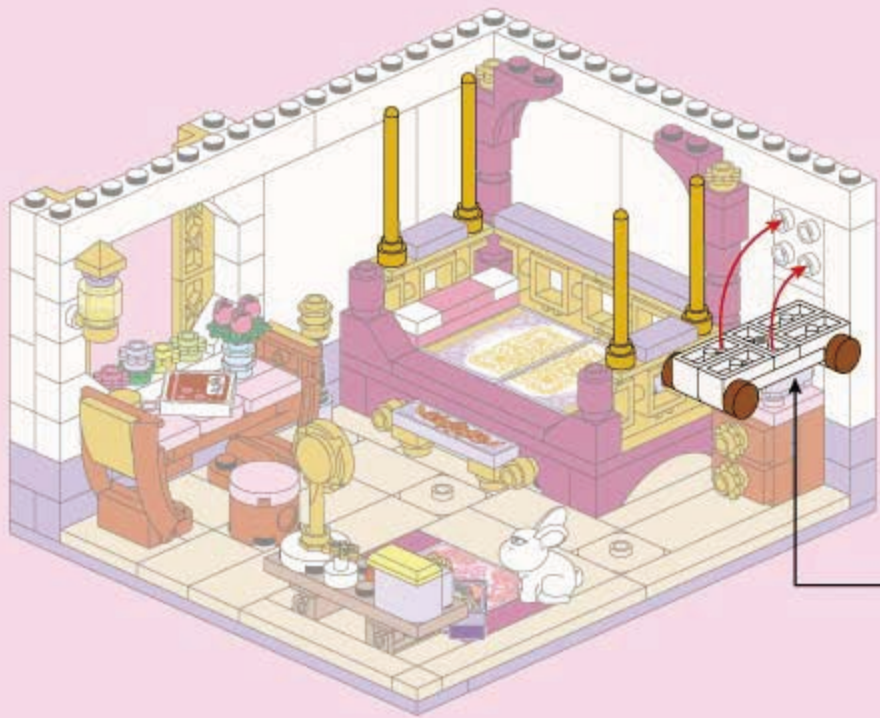

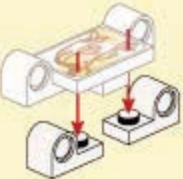

1 

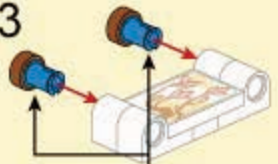
2 

3 

 2x

4 

 2x

31



2x



4x



4x



2x



2x

1



2

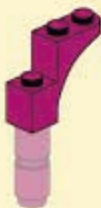

3



4



1



2



3



4



32

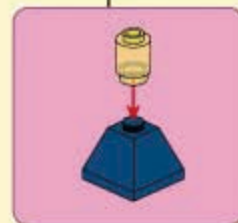
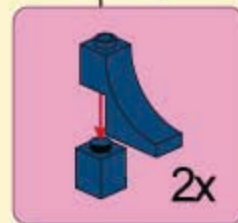
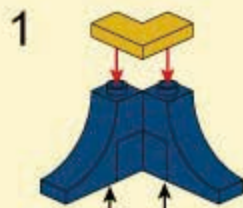
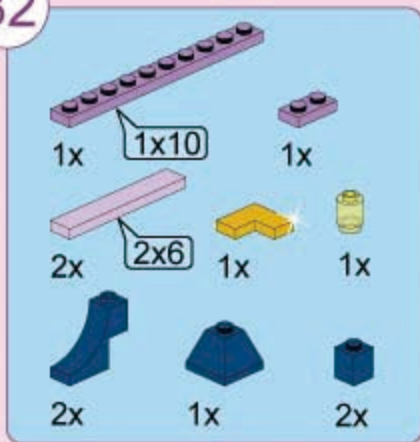

- 1x 1x8
- 2x 1x4
- 1x 1x4
- 1x 1x4
- 2x 1x4
- 2x 1x4
- 1x 1x4
- 2x 1x4
- 1x 1x4
- 2x 1x4
- 1x 1x4
- 4x 1x4

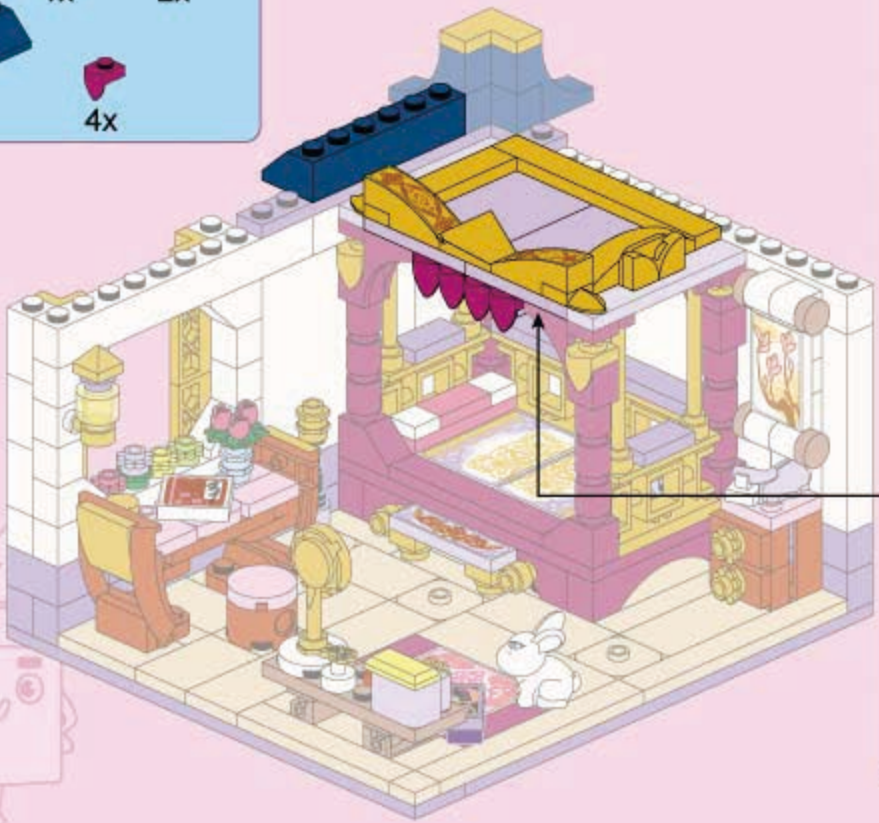

1. A yellow 1x8 Technic beam is placed on top of a purple 1x8 Technic plate.
2. A yellow 1x4 Technic beam is placed on top of the purple plate. A yellow 1x4 Technic beam with a hole is attached to the end of the purple plate.
3. A yellow 1x4 Technic beam with a hole is attached to the end of the purple plate.
4. A yellow 1x4 Technic beam with a hole is attached to the end of the purple plate.
5. A yellow 1x4 Technic beam with a hole is attached to the end of the purple plate.



34

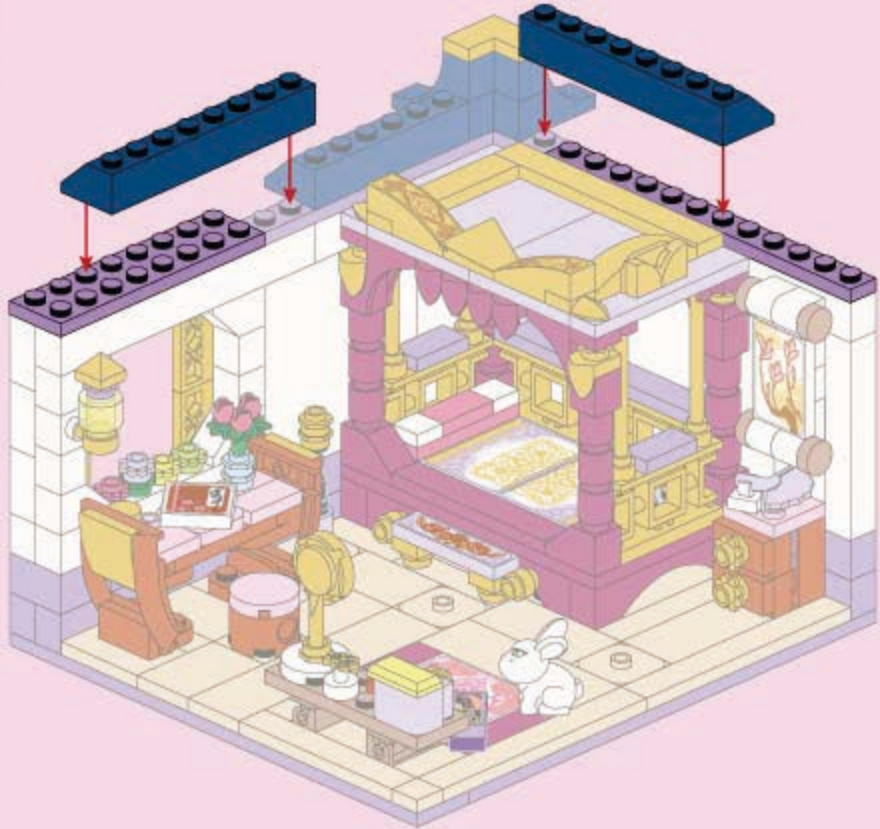
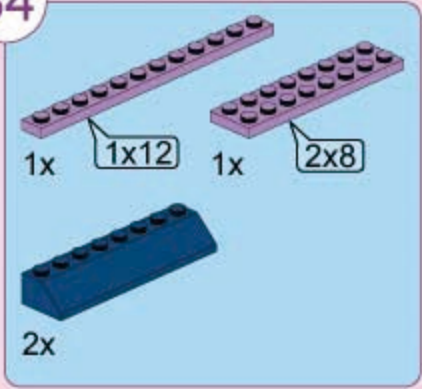

35

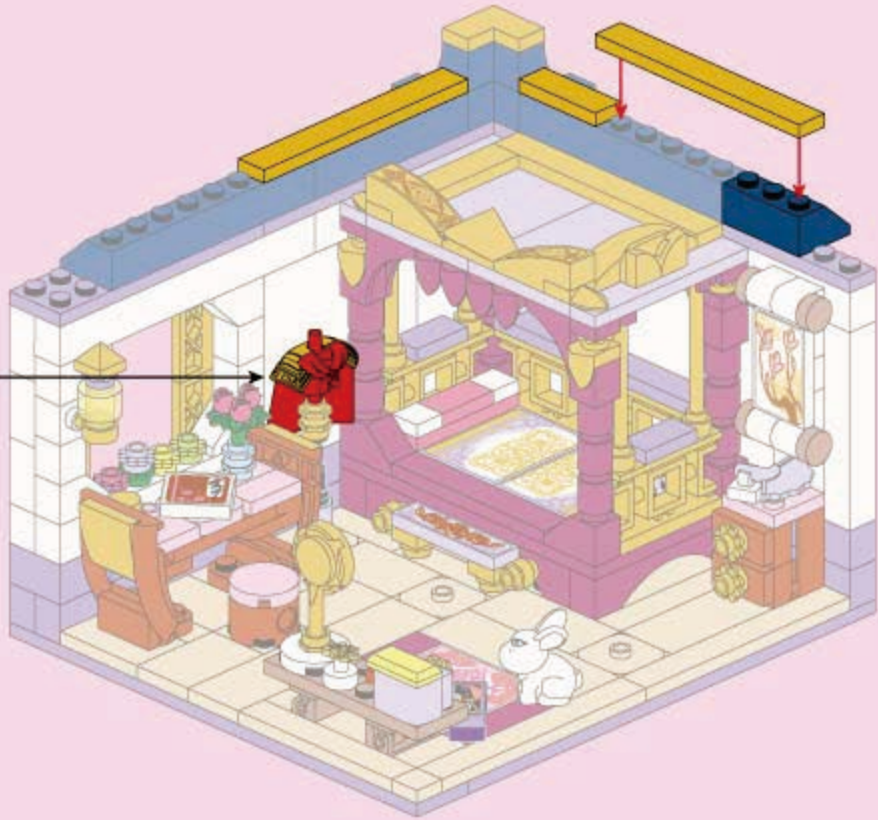
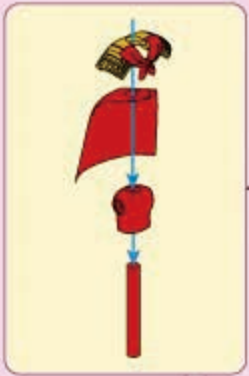
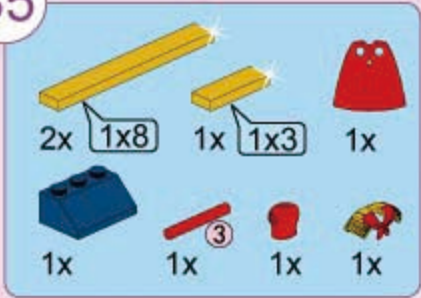

36



1x

1x6



4x



2x



2x

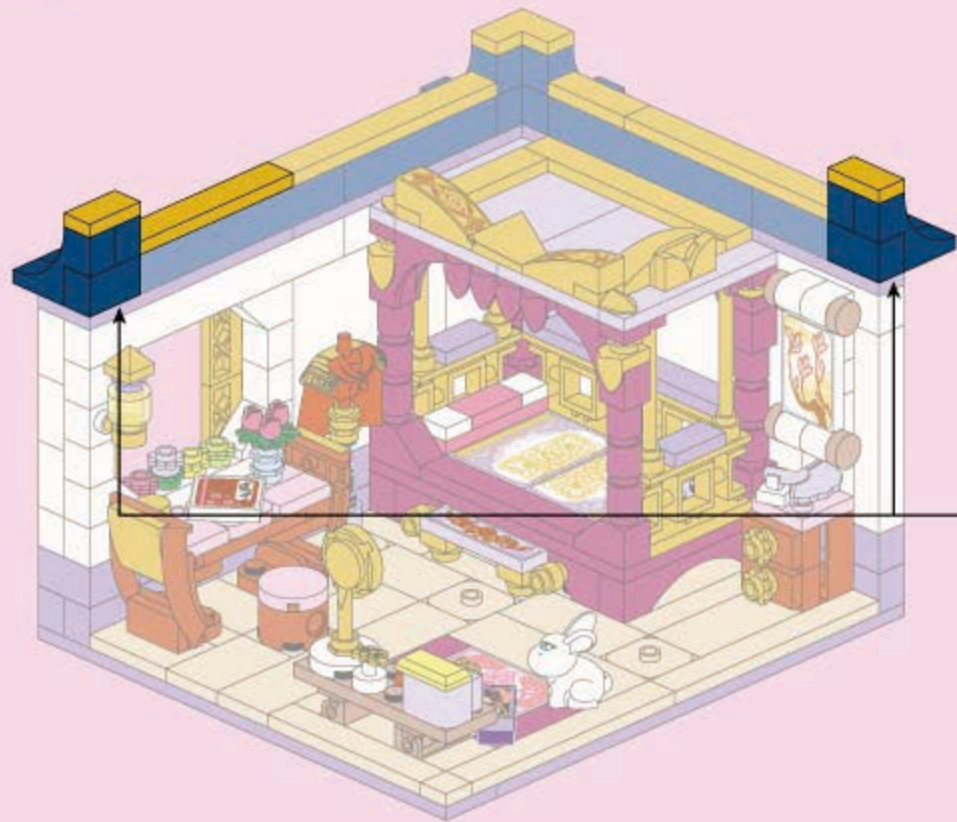

1



2

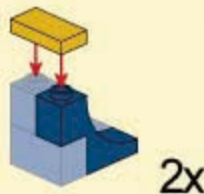



33013

愿驰千里足
策勋十二转
将军百战
万里
不闻
但闻
旦辞
东市

九州 芳华录

收集九州芳华录系列
和木兰一起做勇敢女生!

户理红妆

木兰当户
问女何所
可汗大点兵



明

秋衣

长鞭

征

名

所

忆