

Keepplay

国玩系列

宫

故宫宫廷文化

正版授权

K10127 宫廷宝箱



宫廷宝箱精妙还原紫禁城中轴线。

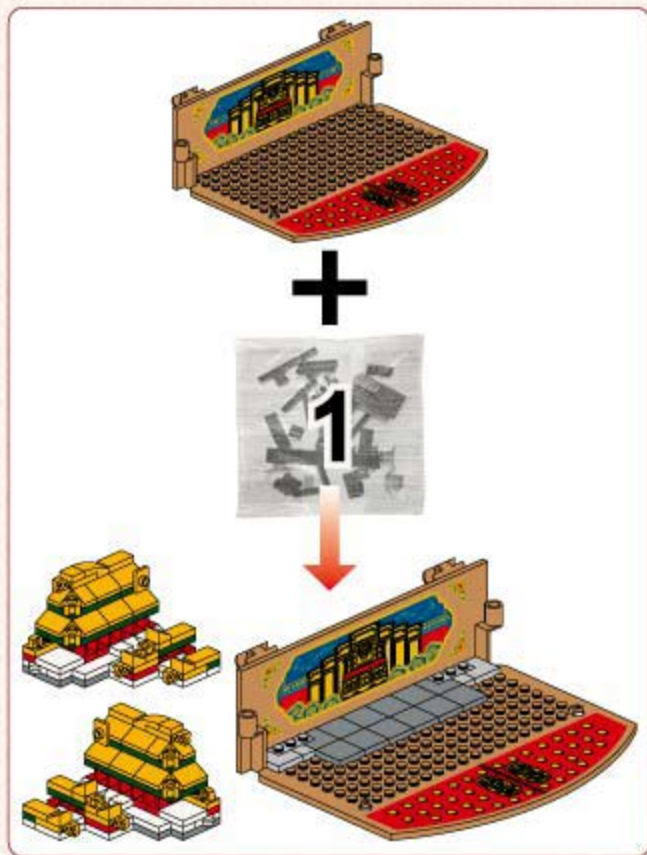

拆件器使用方法，仅为示例

Usage of Brick Separator, Just for the sample

1

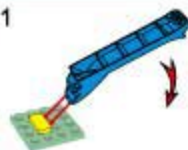

3



2



4



1

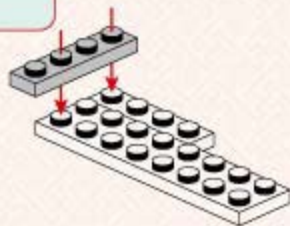
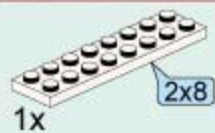

2

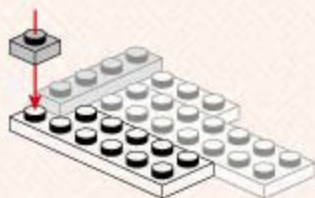
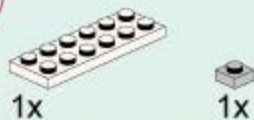

3

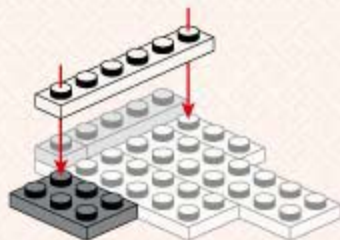
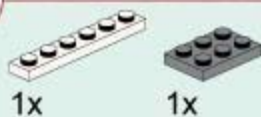

4

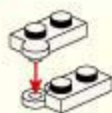

2



5

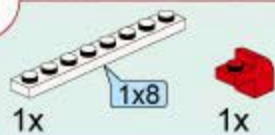

6

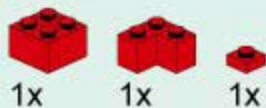

7



8

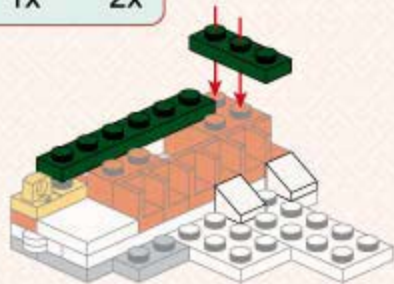
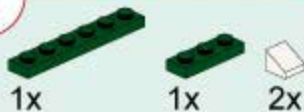

9



1x



2x



2x



2x

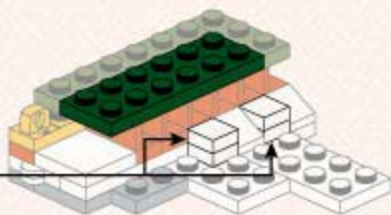

10



1x

1x4



1x



1x

1x3



1x



1x



11



1x



1x



1x



1x



1x



12



1x



1x



4x



1x

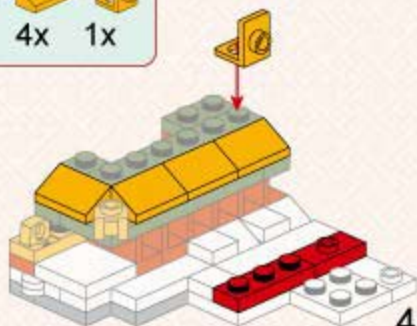

13

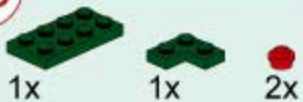

14



15



16

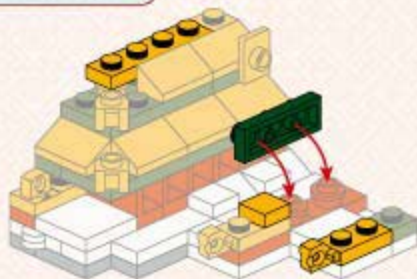
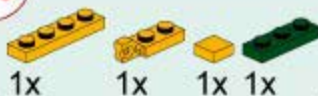



17

3x 1x 2x



18

1x 1x 3x 1x

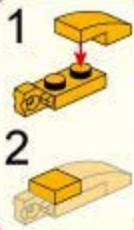

19

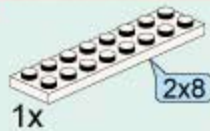

1x

2x8

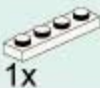

1x



1x

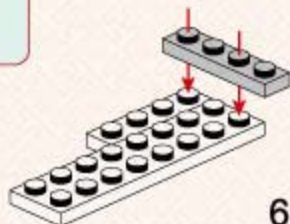

20

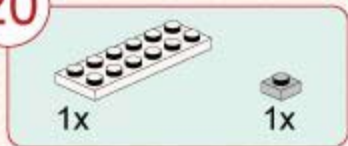

21

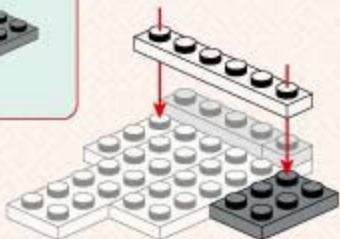
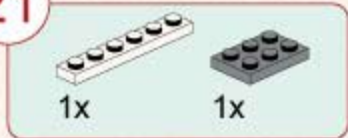

22

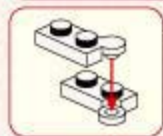

23

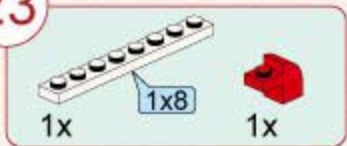

24

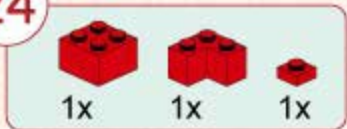



25



1x



6x



1x



26



1x



1x



2x

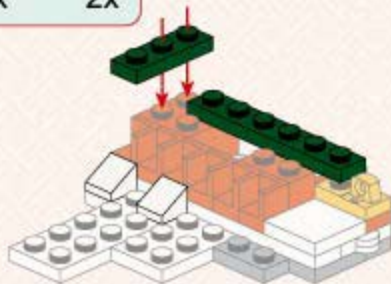

27



1x



2x



2x



28



1x

1x4



1x

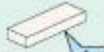

1x



1x



1x



29

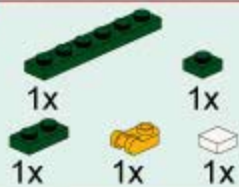

30



31

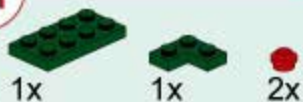

32



33



34

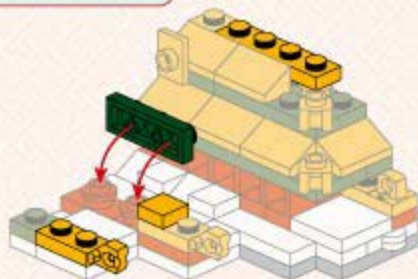

35



36

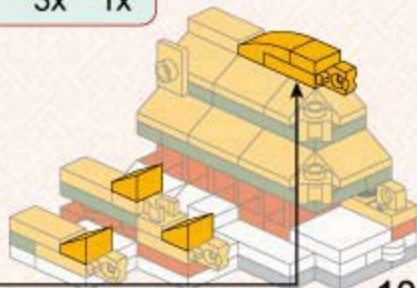
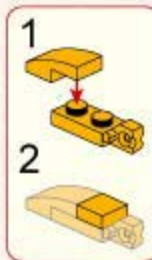



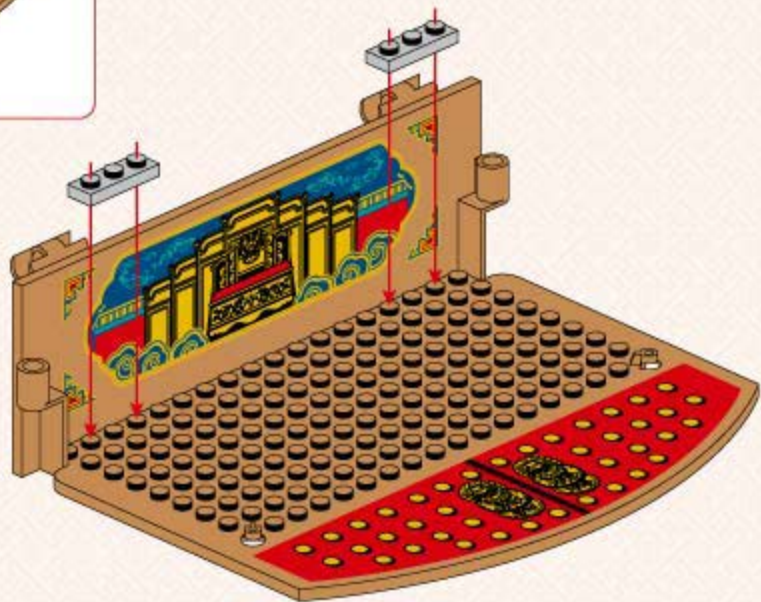
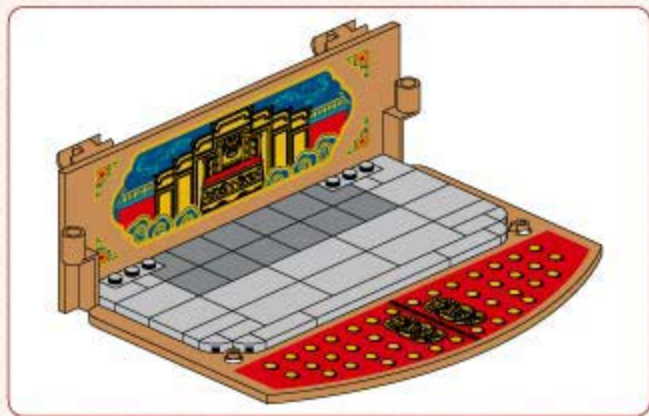

38



10x



2x



2x



2x

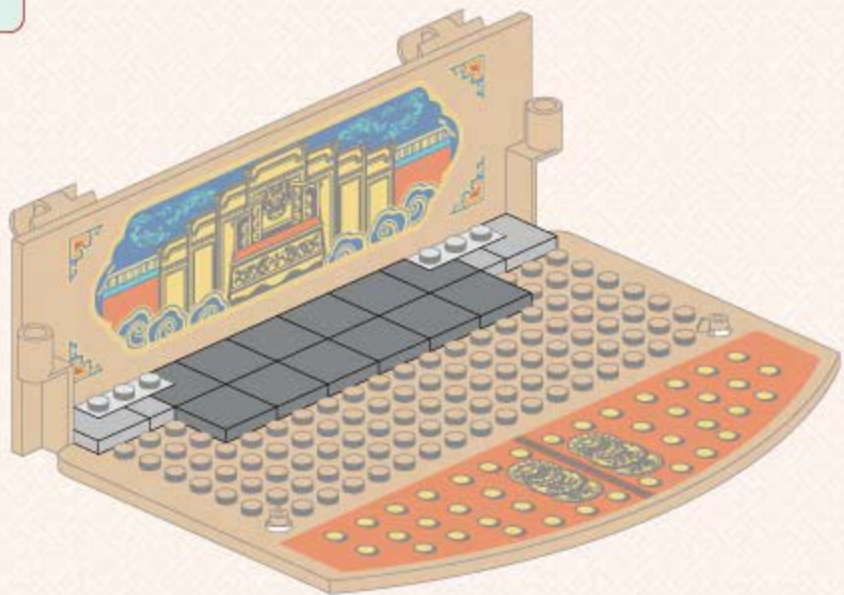



39

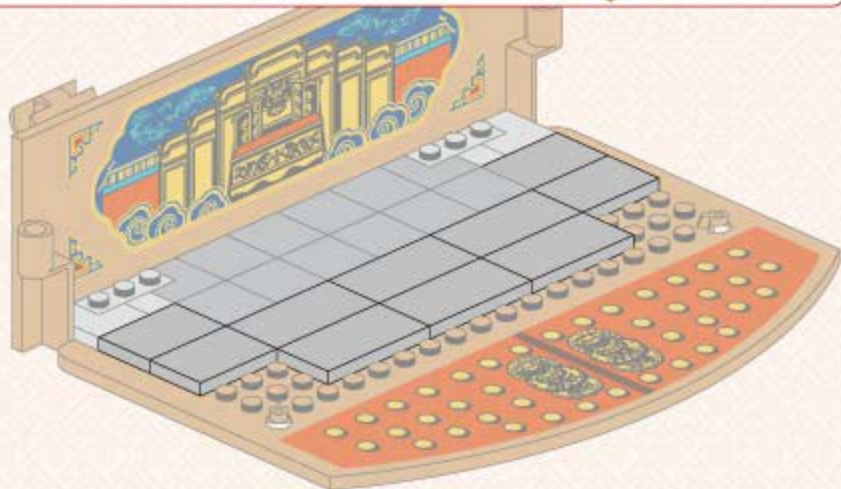
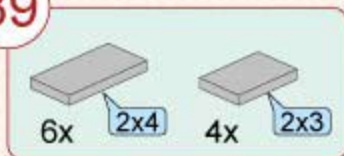



40

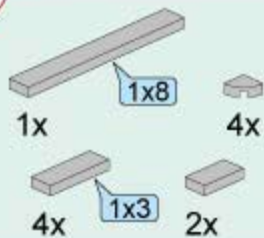

36

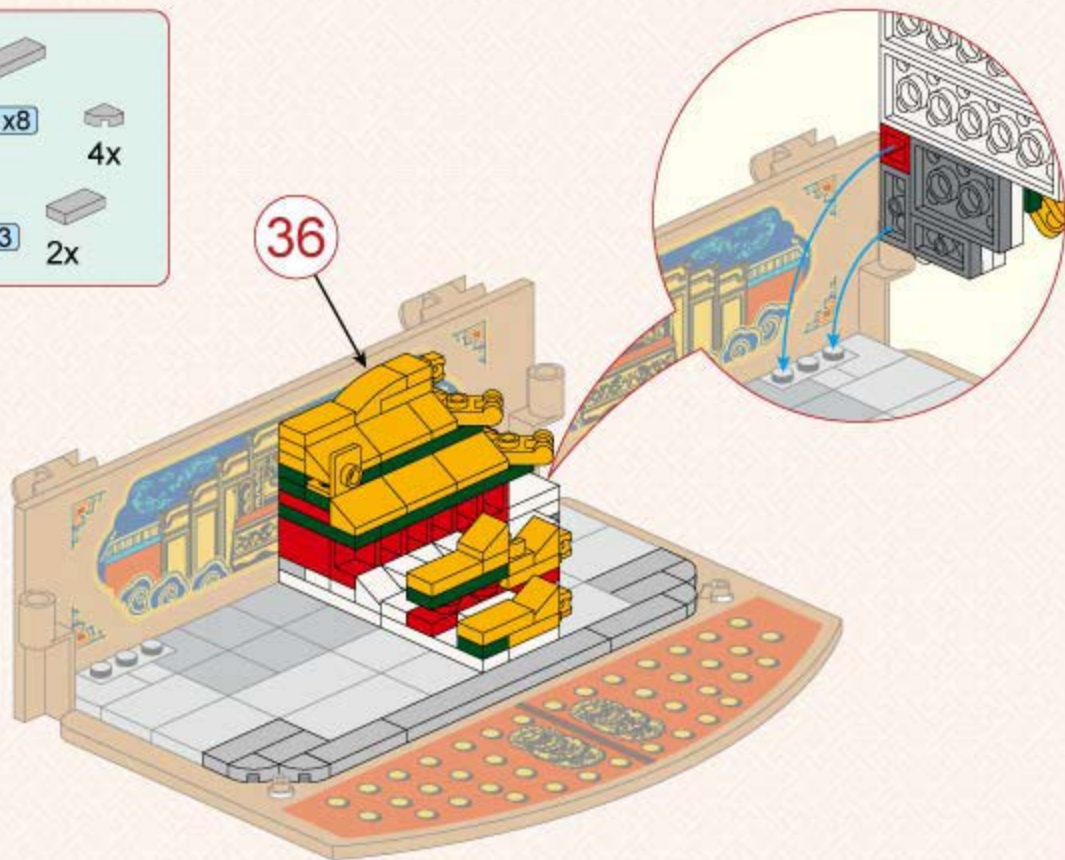

41



1x

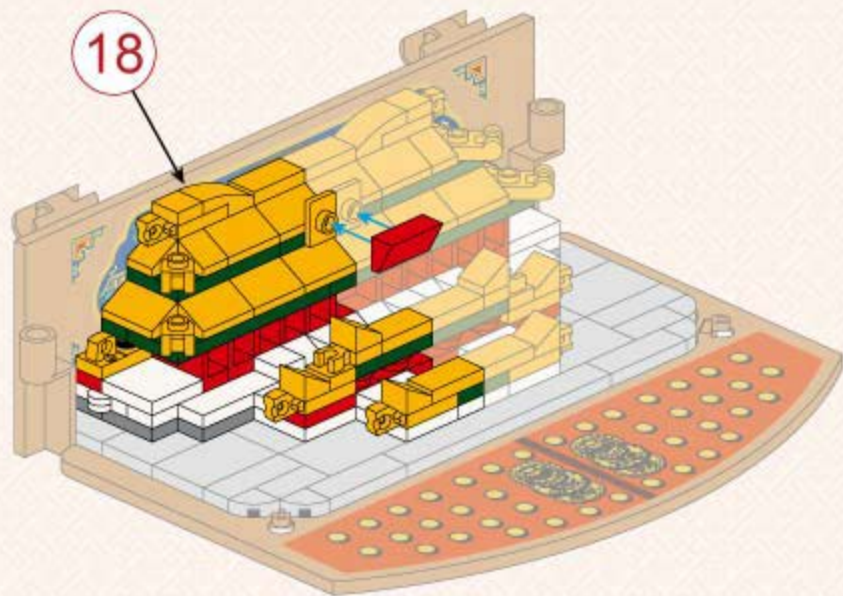

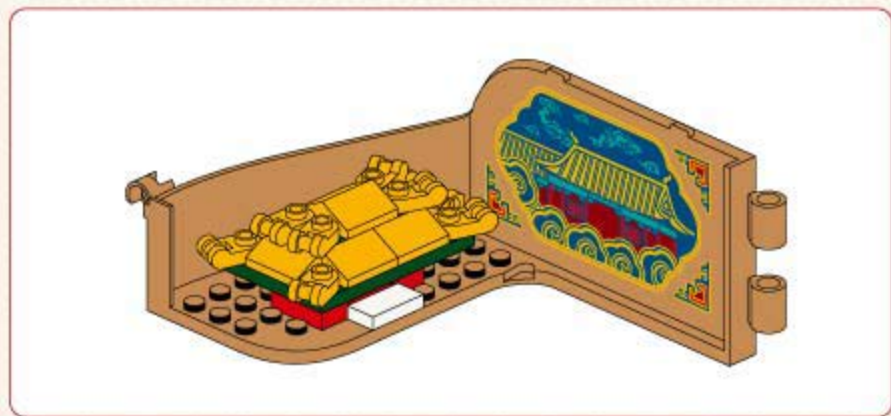

42

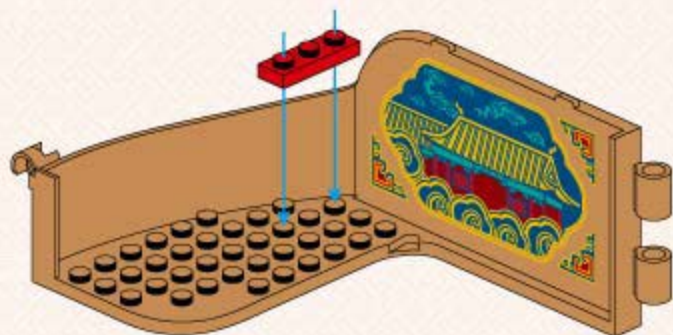
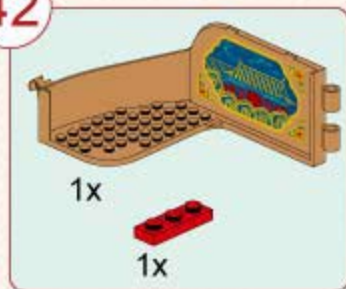



43



1x



1x



1x



1x



44



2x



1x



45



1x

4x6

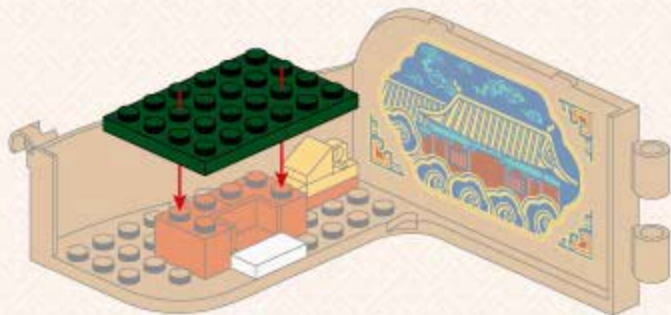

46



2x



3x



47



3x



1x



48



1x





49



3x



1x



50



1x



3x



51

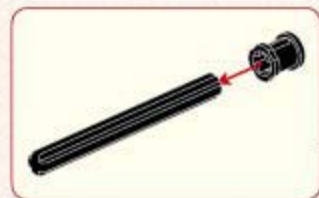

41

50

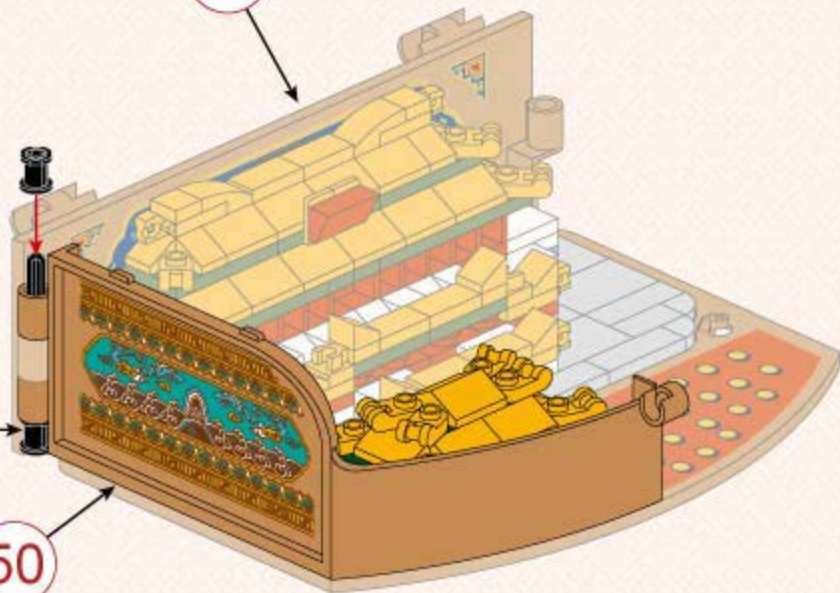

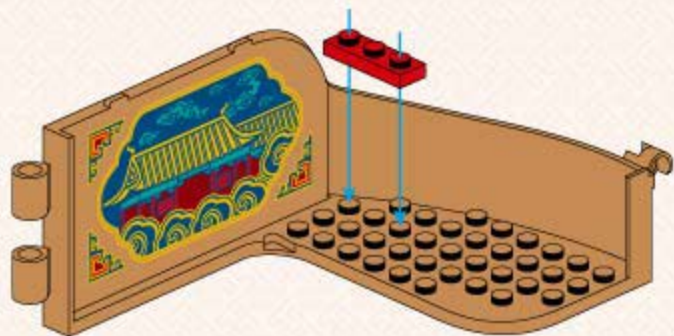
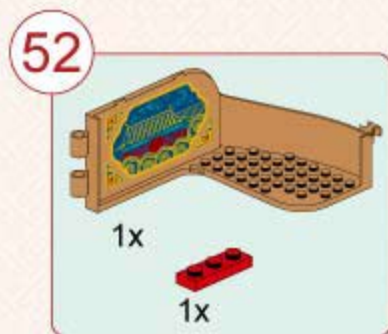



53

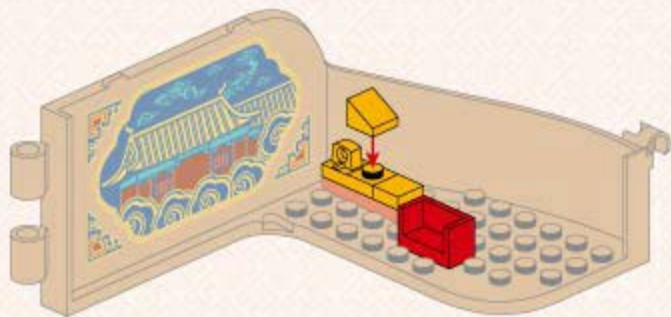

54





57



3x



1x



58



1x





59



3x



1x



60



1x



3x



61

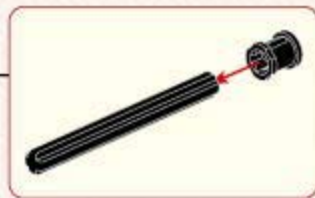
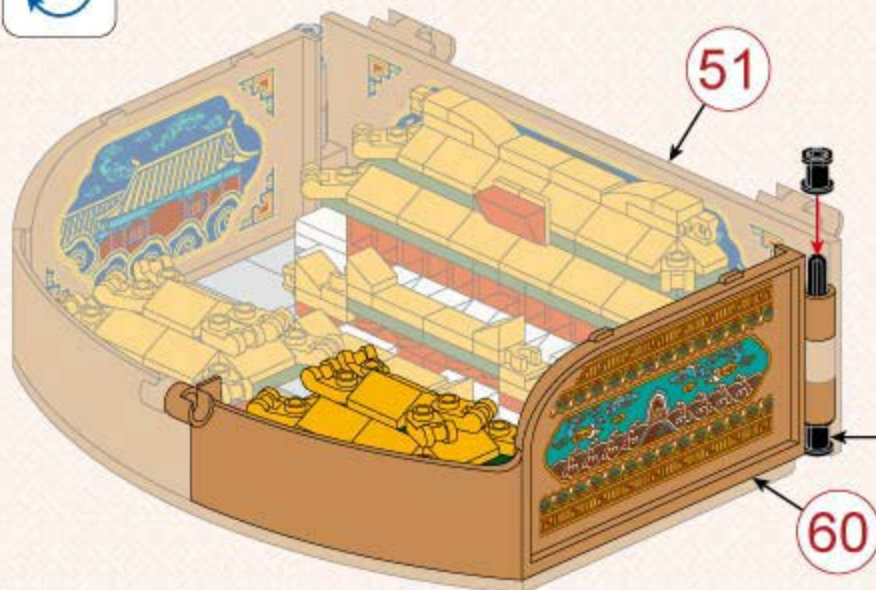

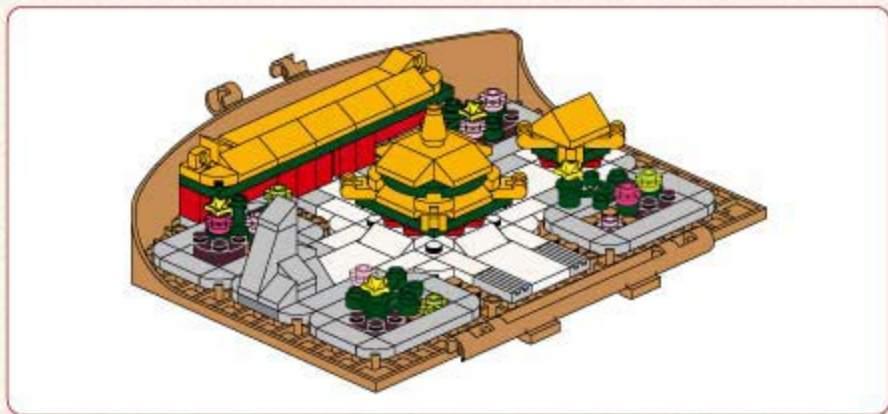

62

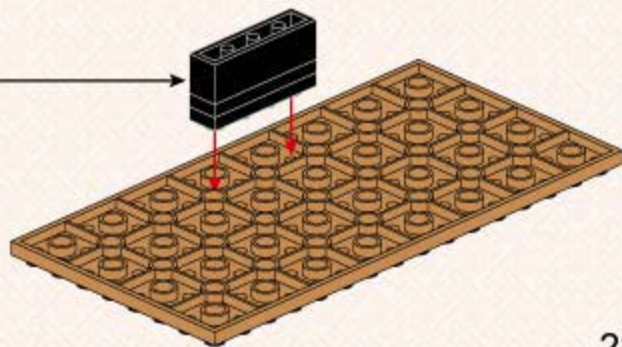
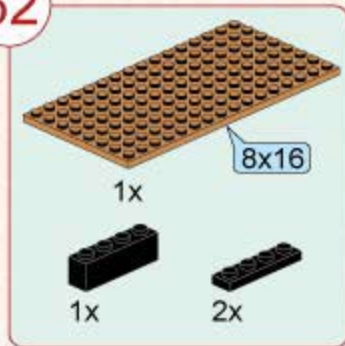



63

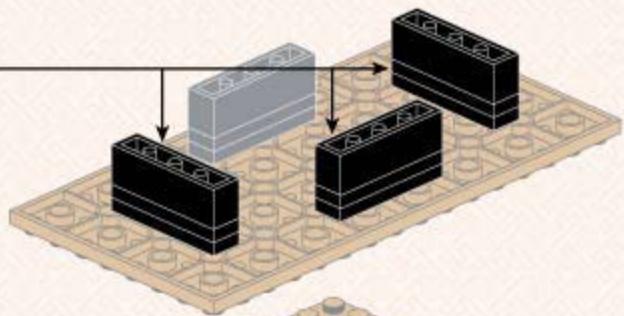
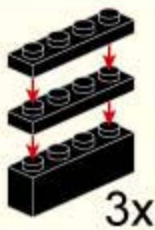

64

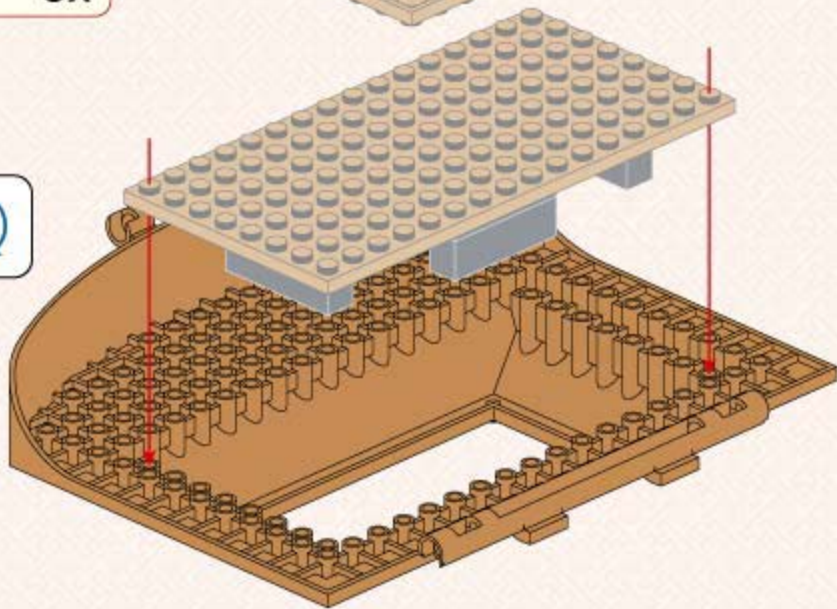



67

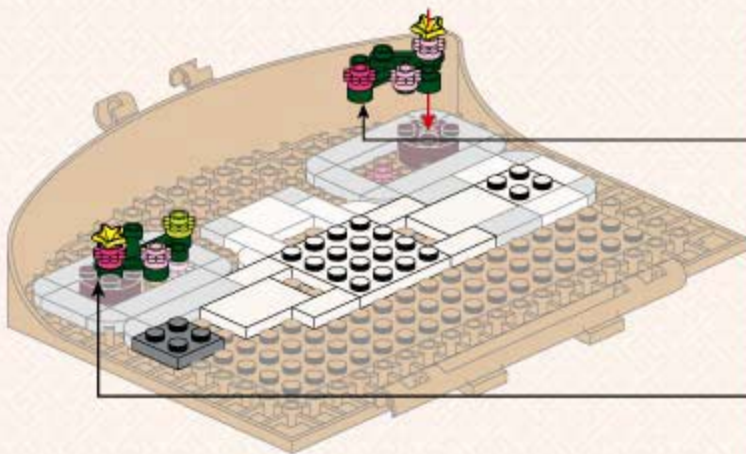

1



2



1



2



68

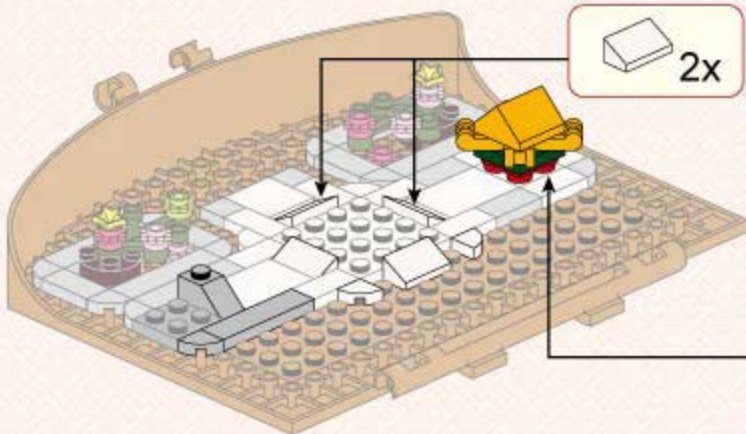

2x

1



2



3

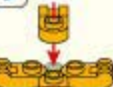

4





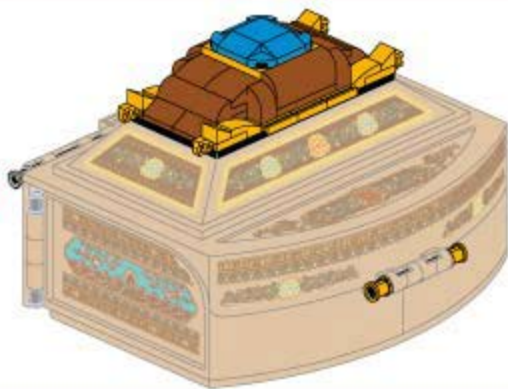

69

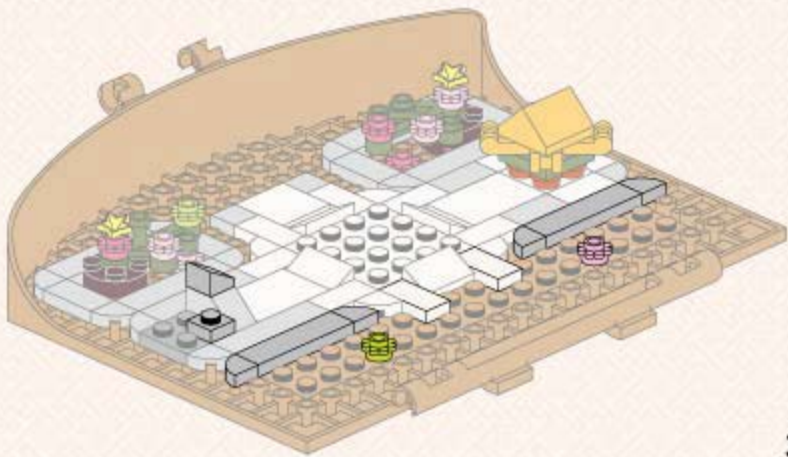
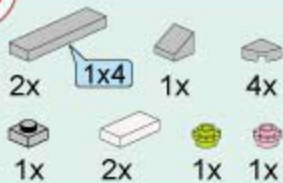

70

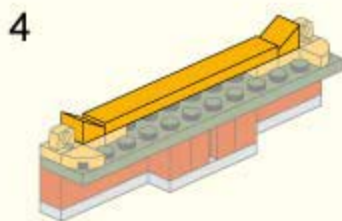
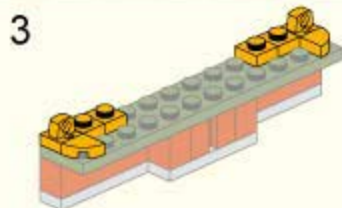
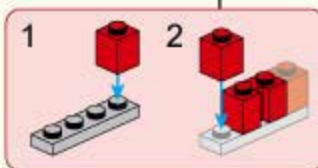
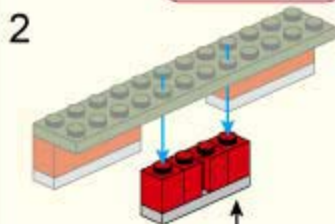
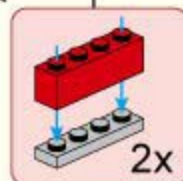
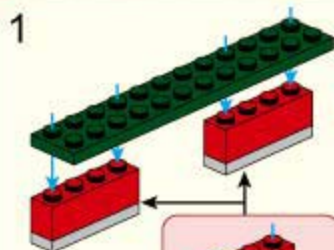
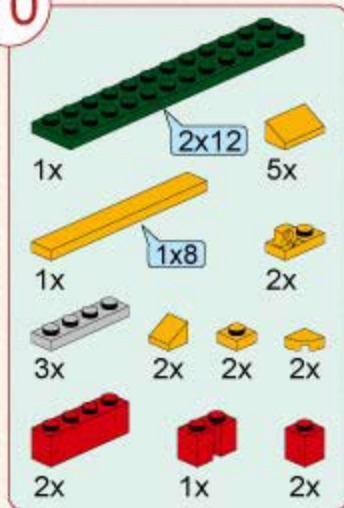

71

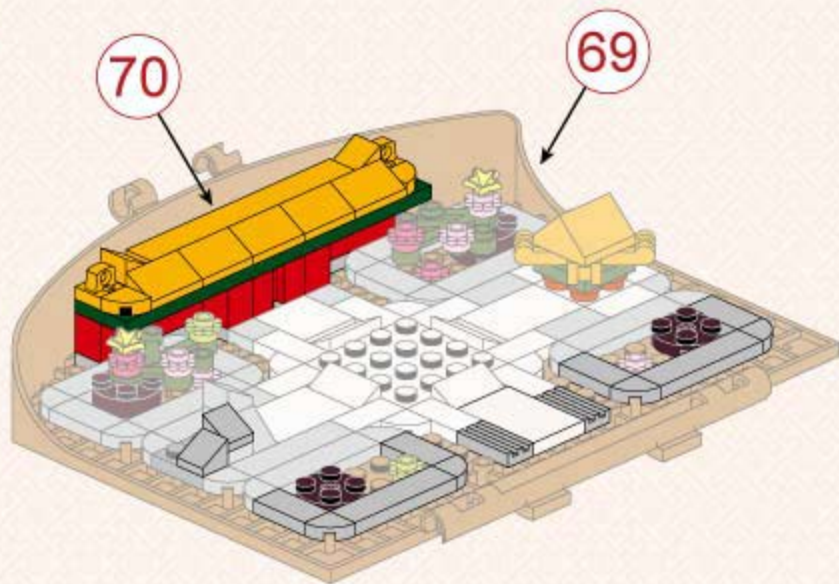
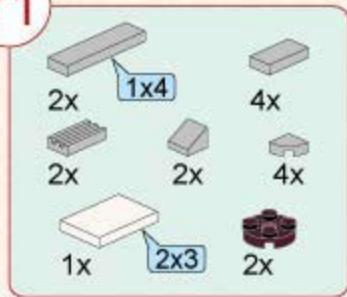



72

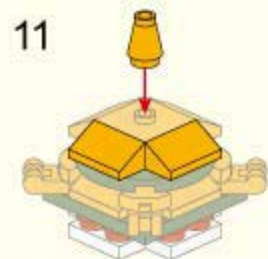
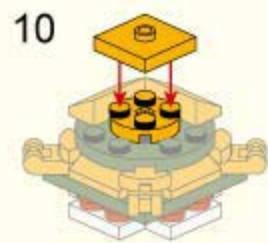
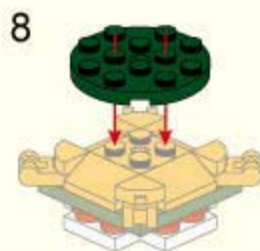
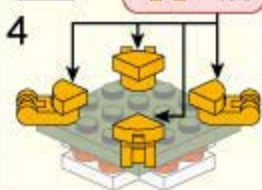
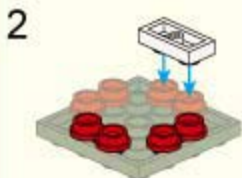
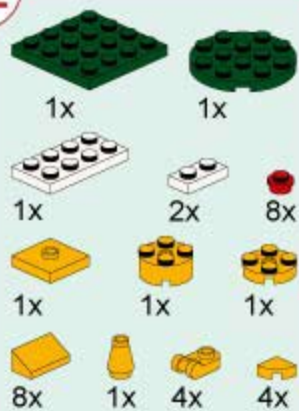

73

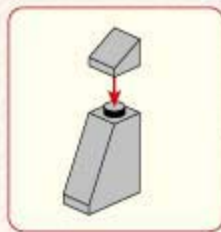
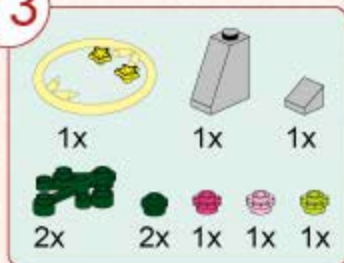

72

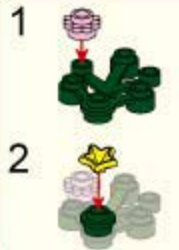
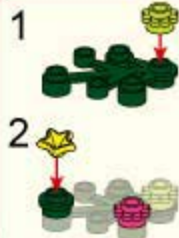
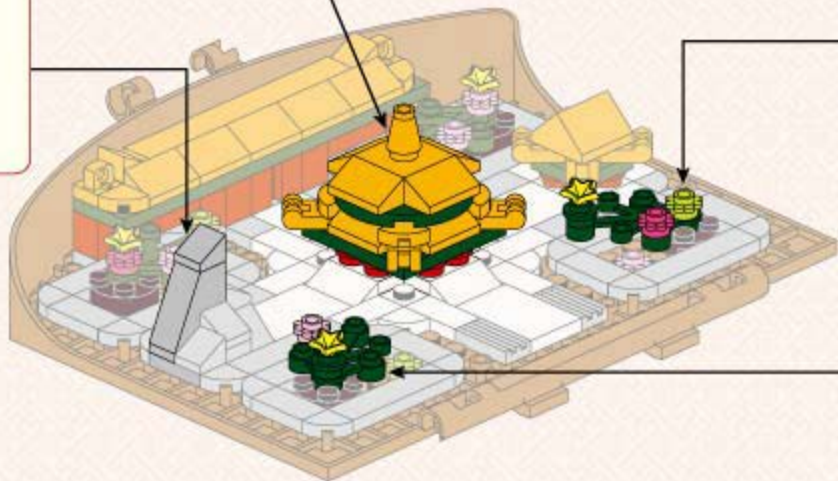

74



73



2x

61



75



1x

6



2x



6

1:1

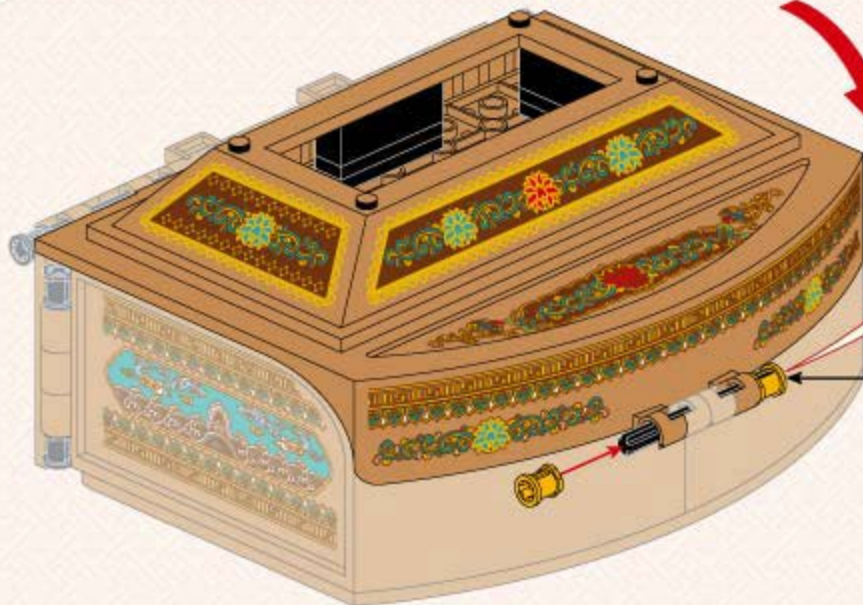

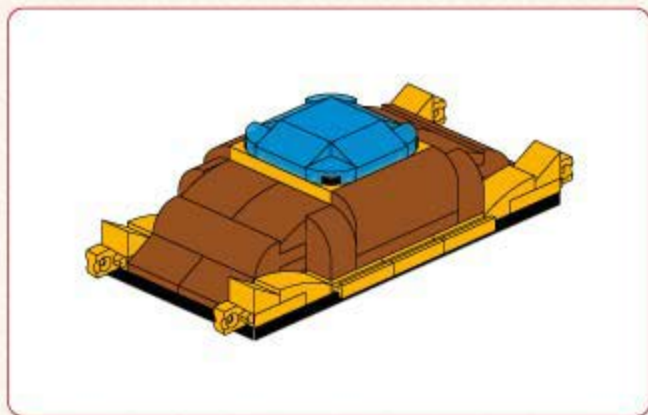

1x

6x12

2x

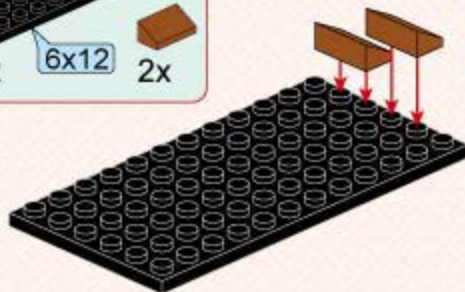

4x

3x

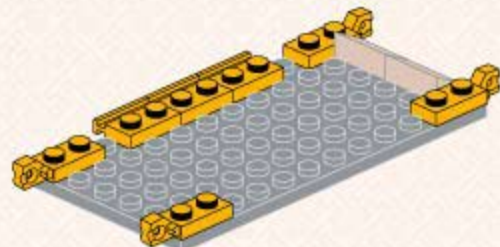

1x

2x

4x

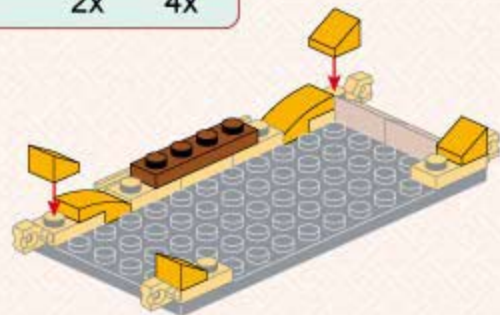

79



3x



4x



2x

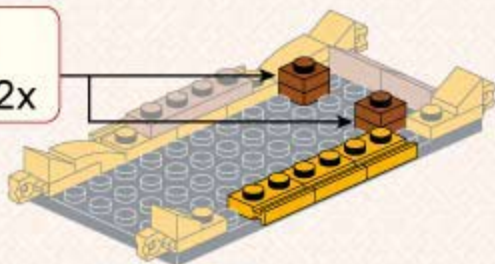

80



1x



4x

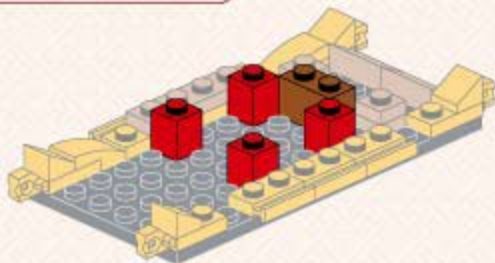

81



1x



1x



4x



2x

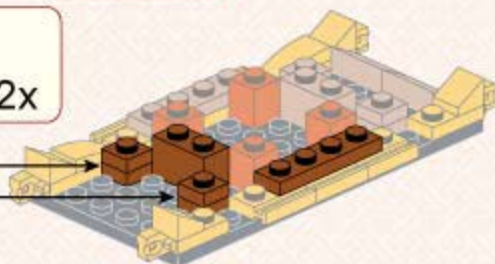

82



1x



2x



2x

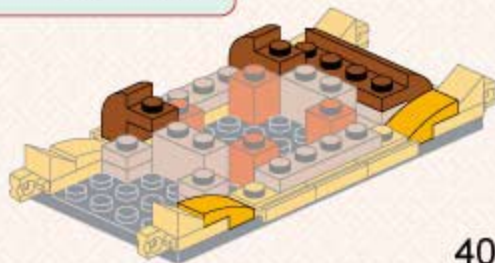



83



1x

2x

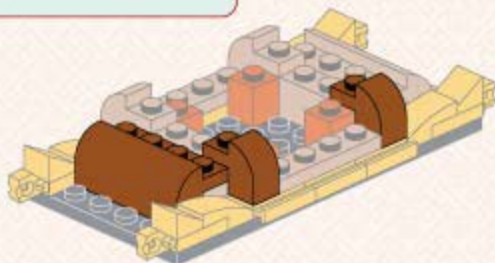

84



4x

2x

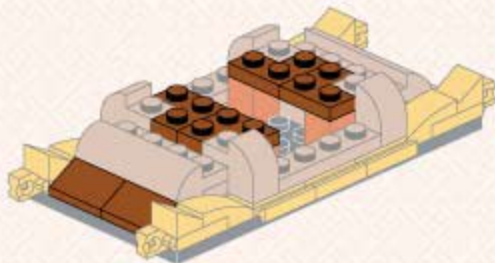

85



2x

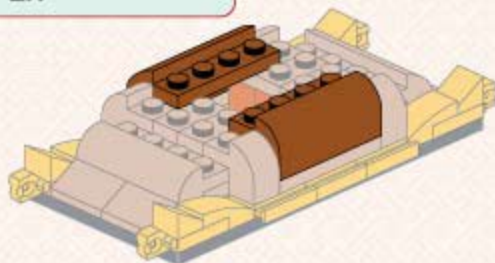

86



4x

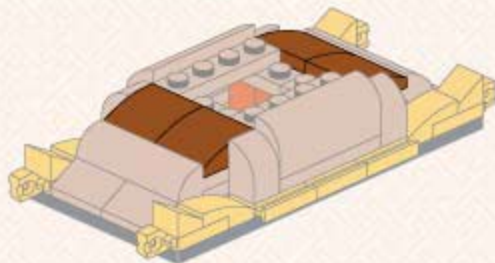

87

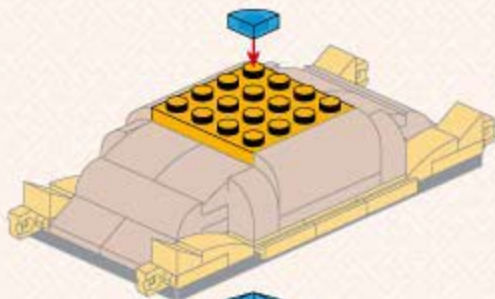

88

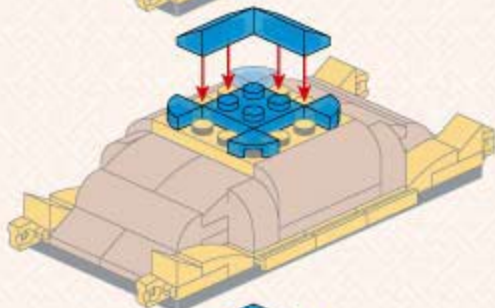

89

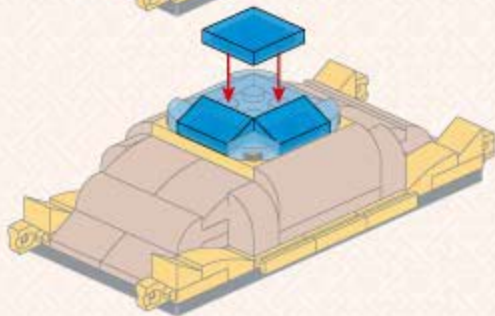

90

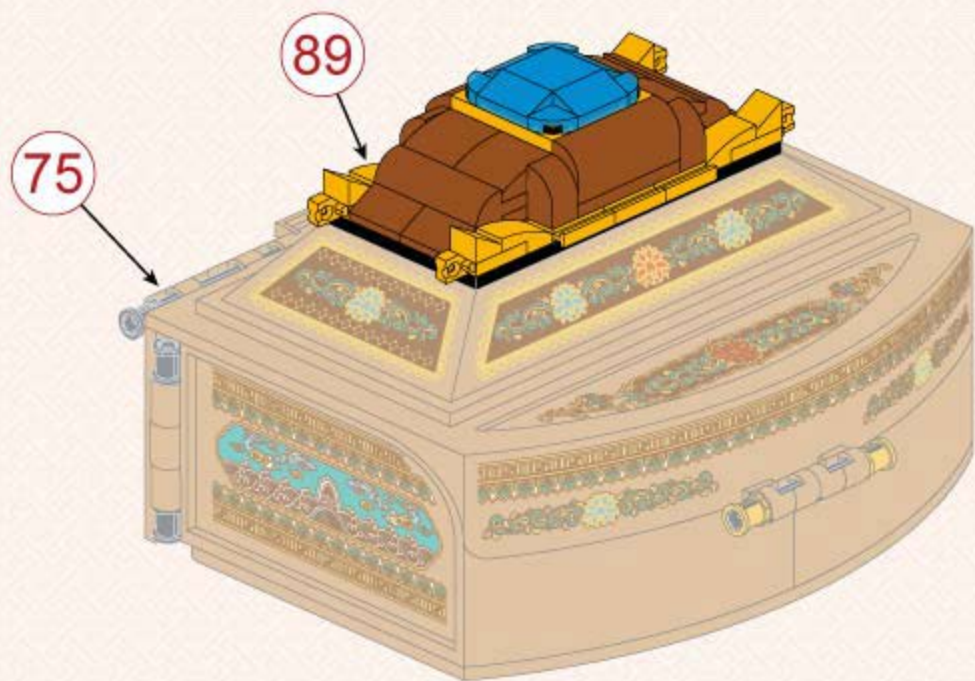



1

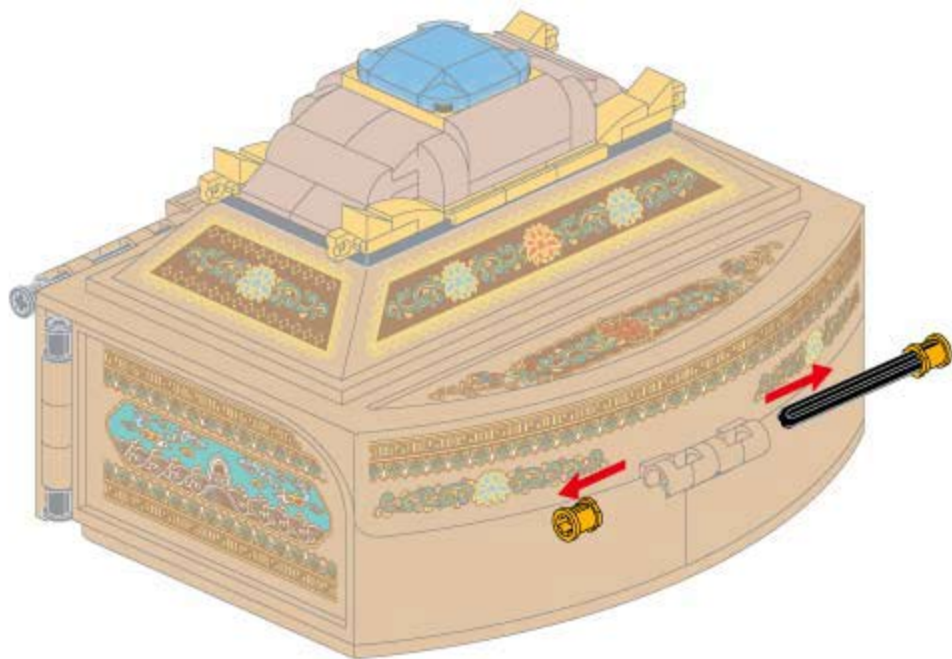

2

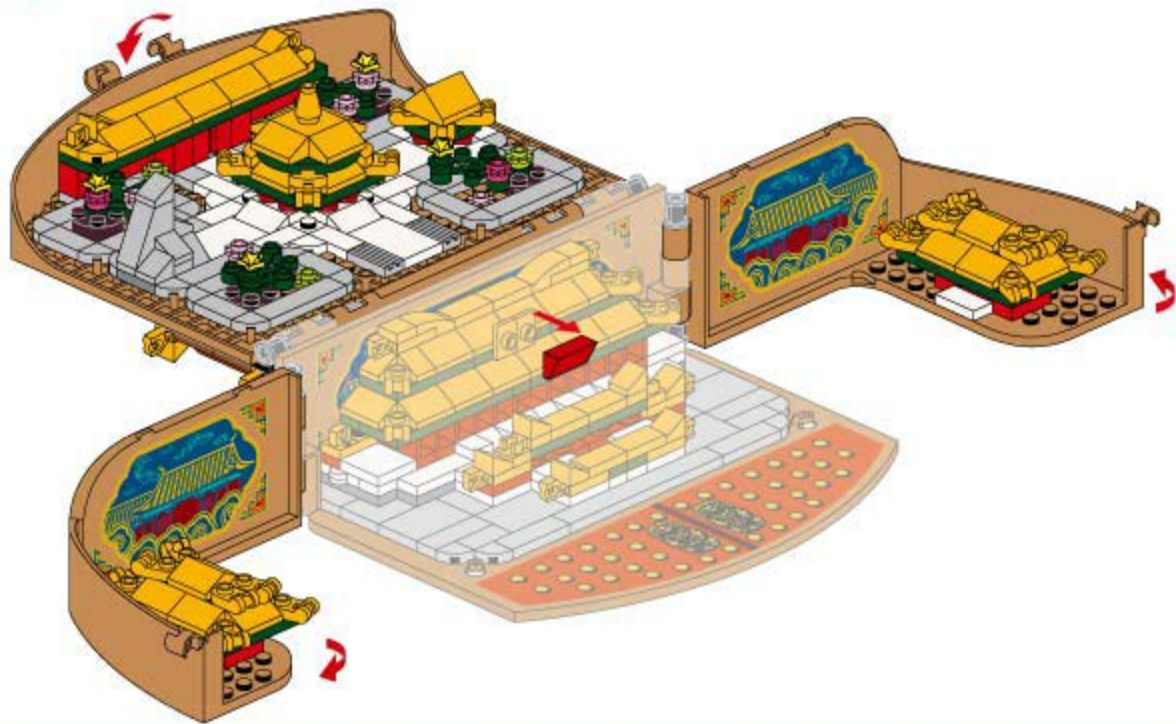

3

