



32014

Ages: 6+

Minifigs: X3

PCS: 605

Princess Leah

*Comfortable and bright
inner castle decoration*



Lake Rainbow Castle

Pictures are for your reference only. The delivered goods shall prevail.

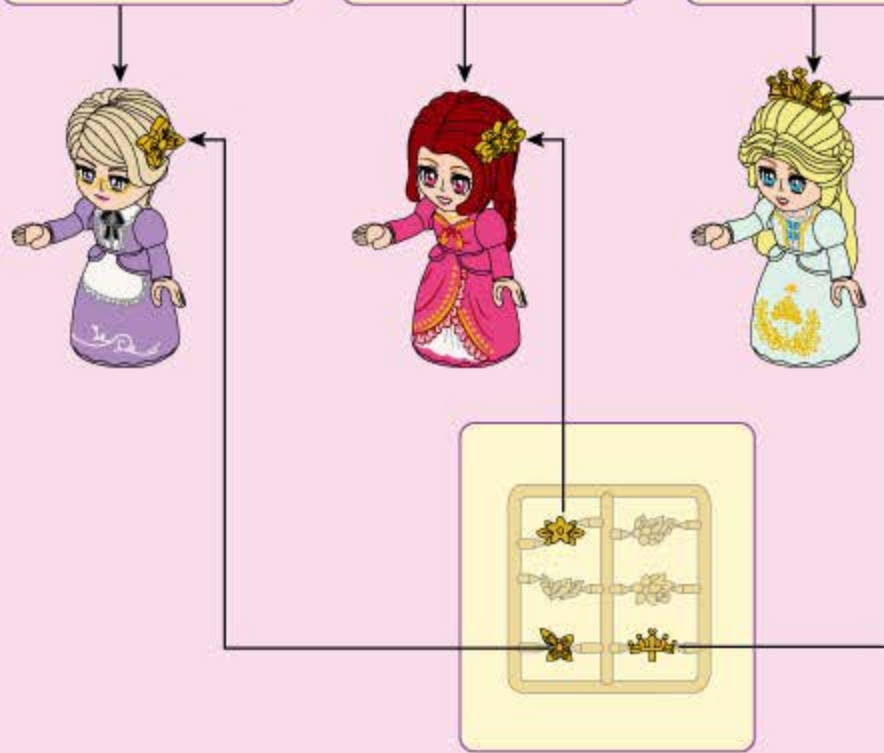
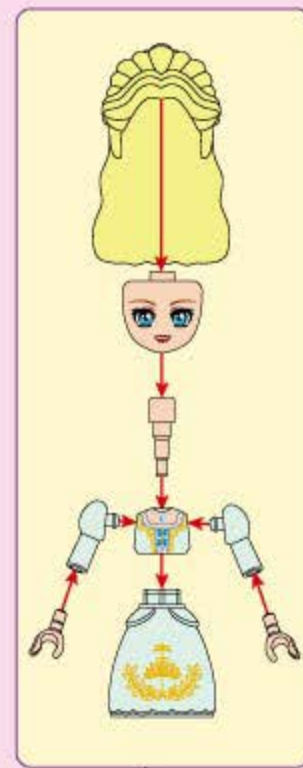
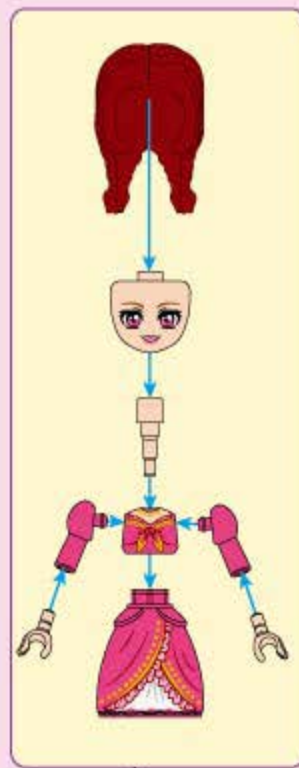
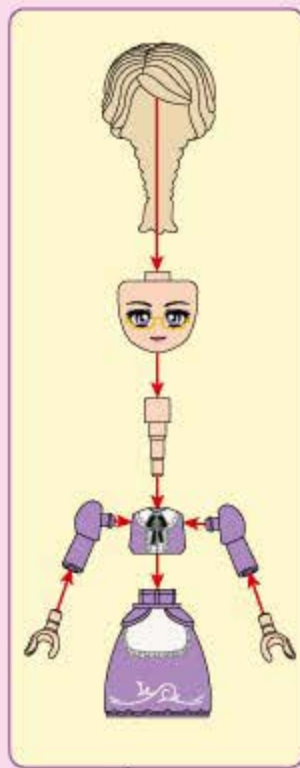
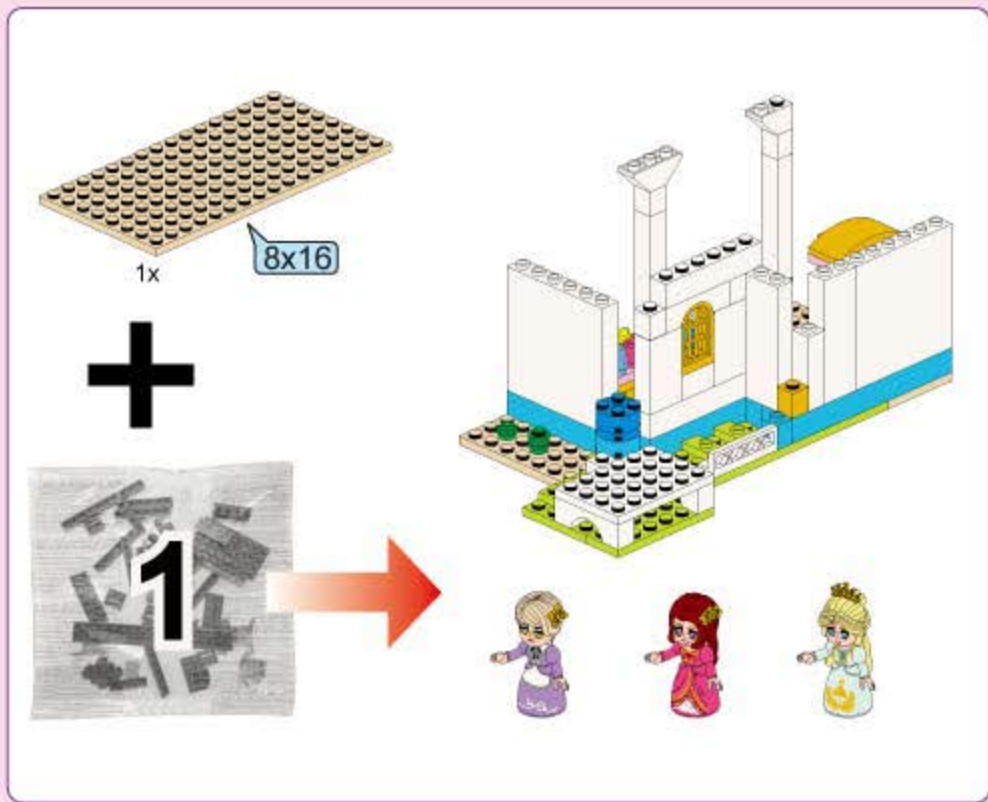

拆件器使用方法, 仅为示例
Usage of Brick Separator, Just for the sample

<p>1</p>	<p>3</p>
<p>2</p>	<p>4</p>

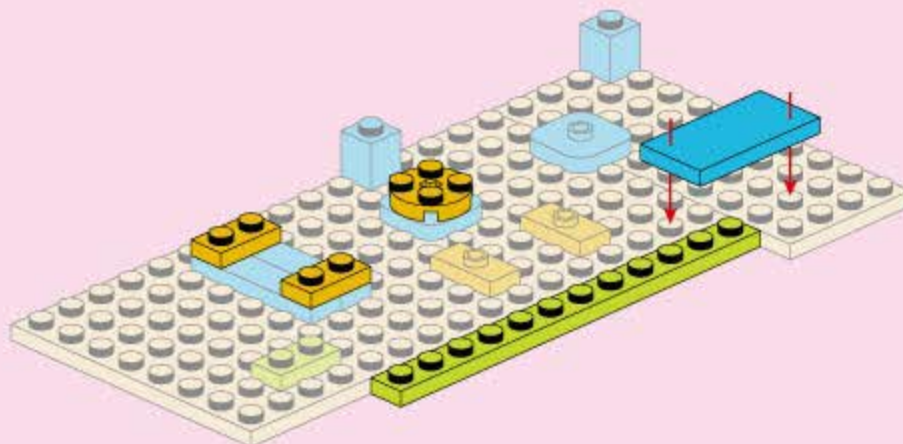
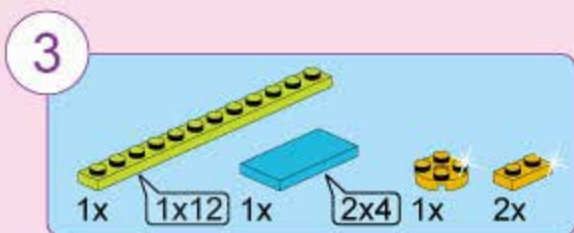
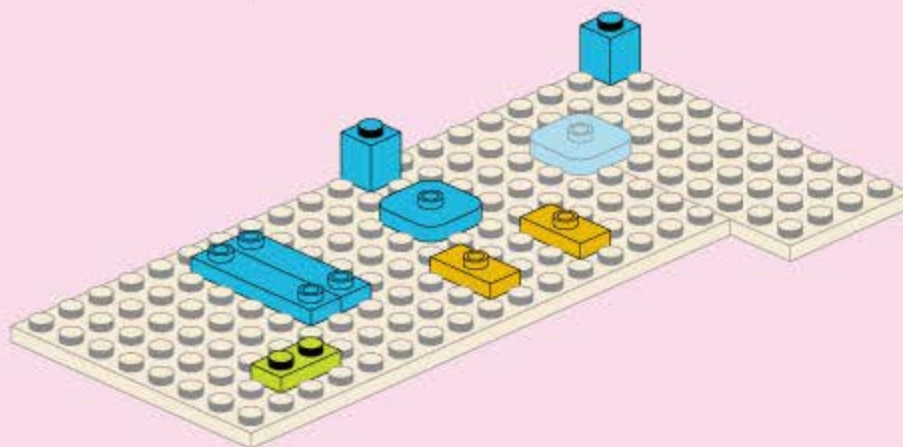
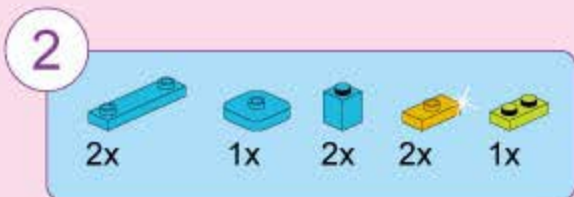
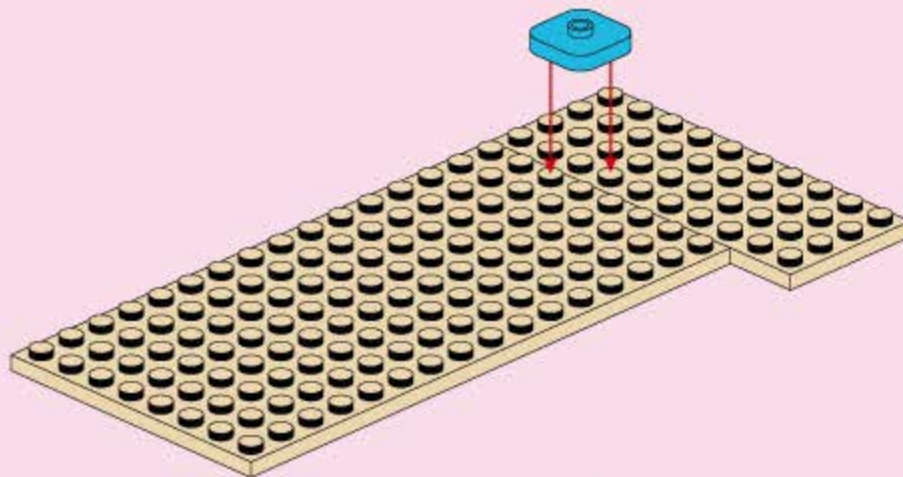
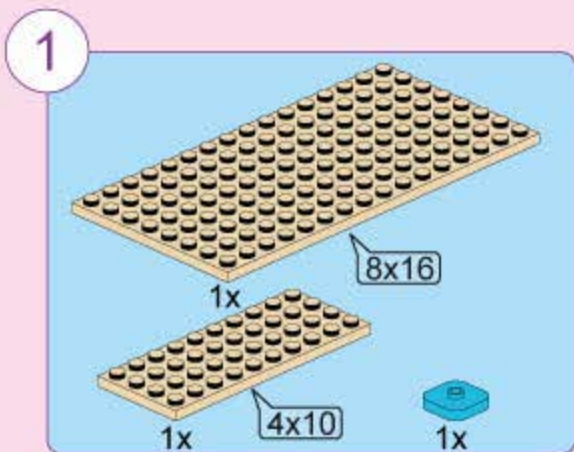

4

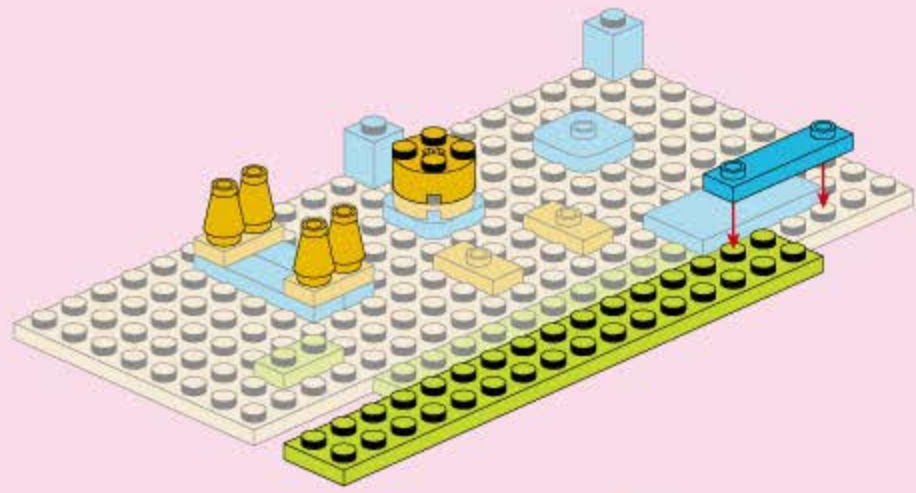
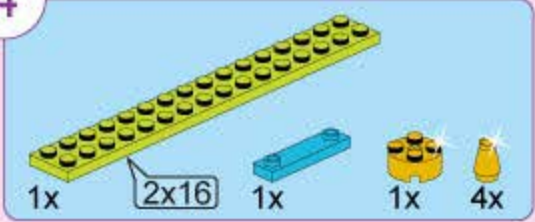

5

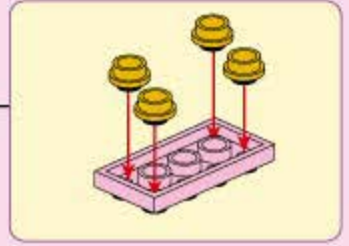
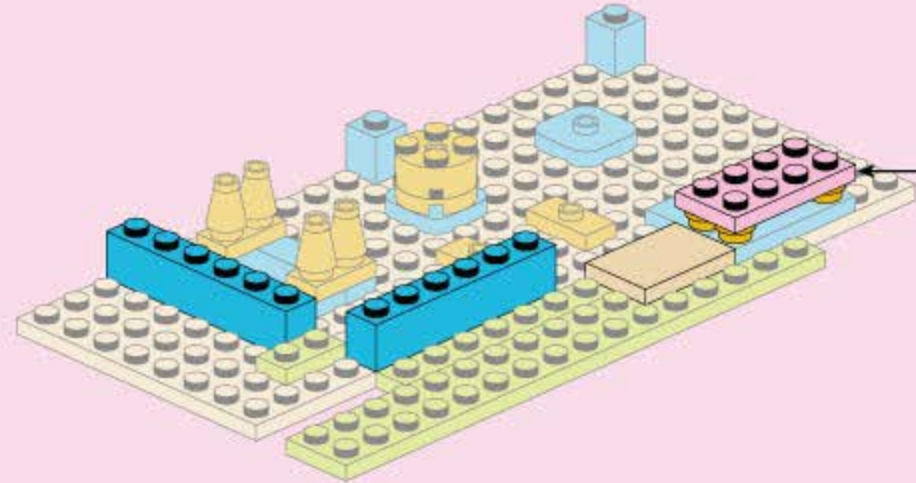
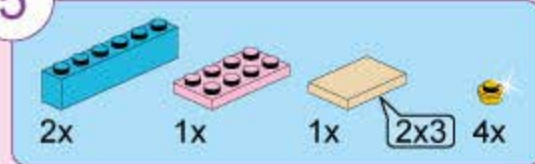

6

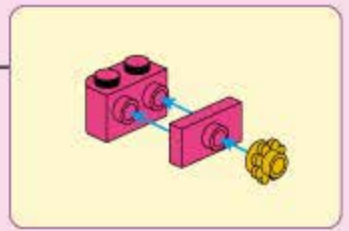
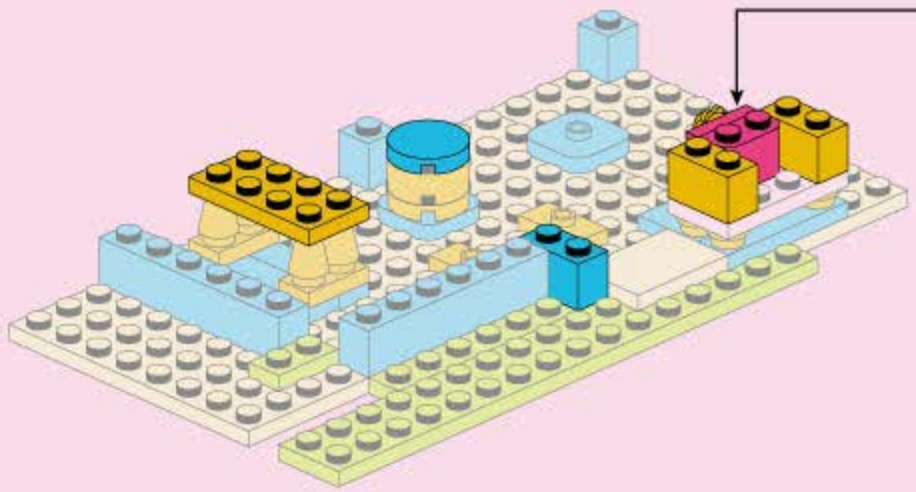
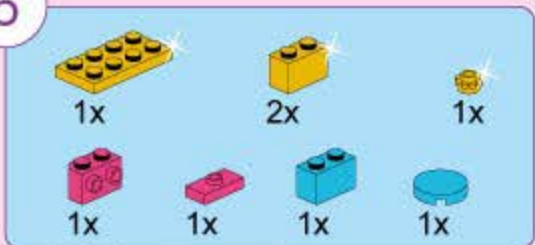

7

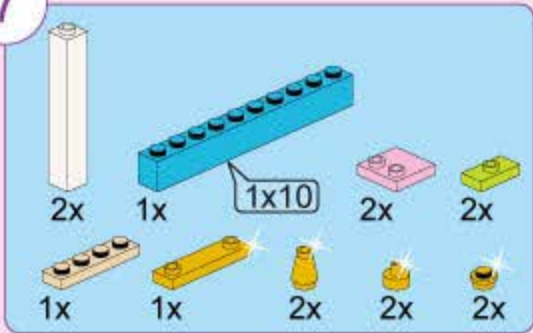

8

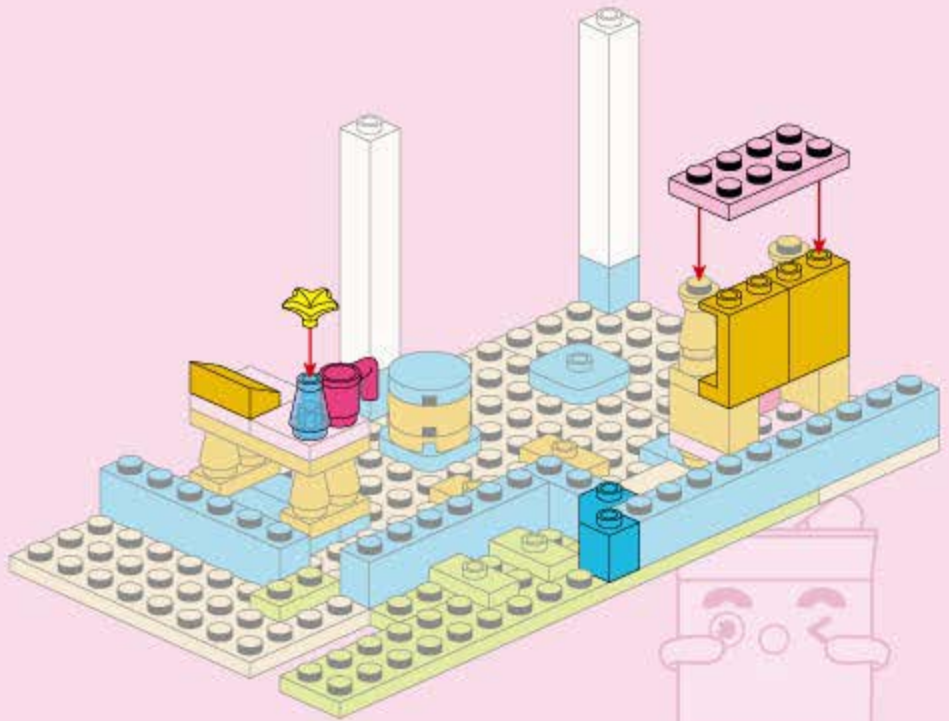
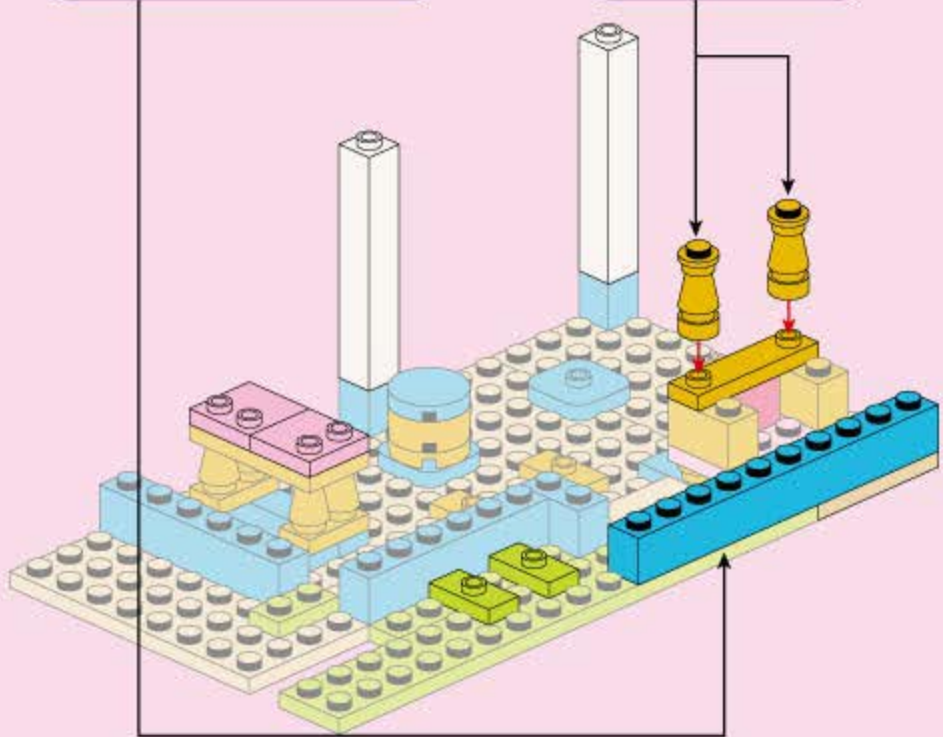
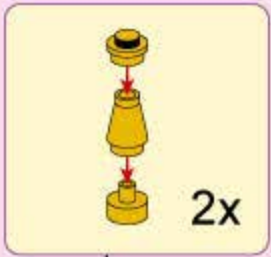
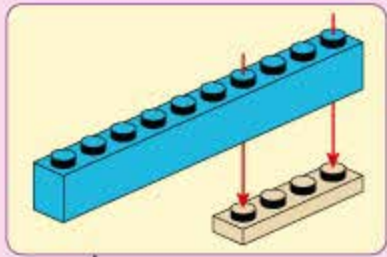

9

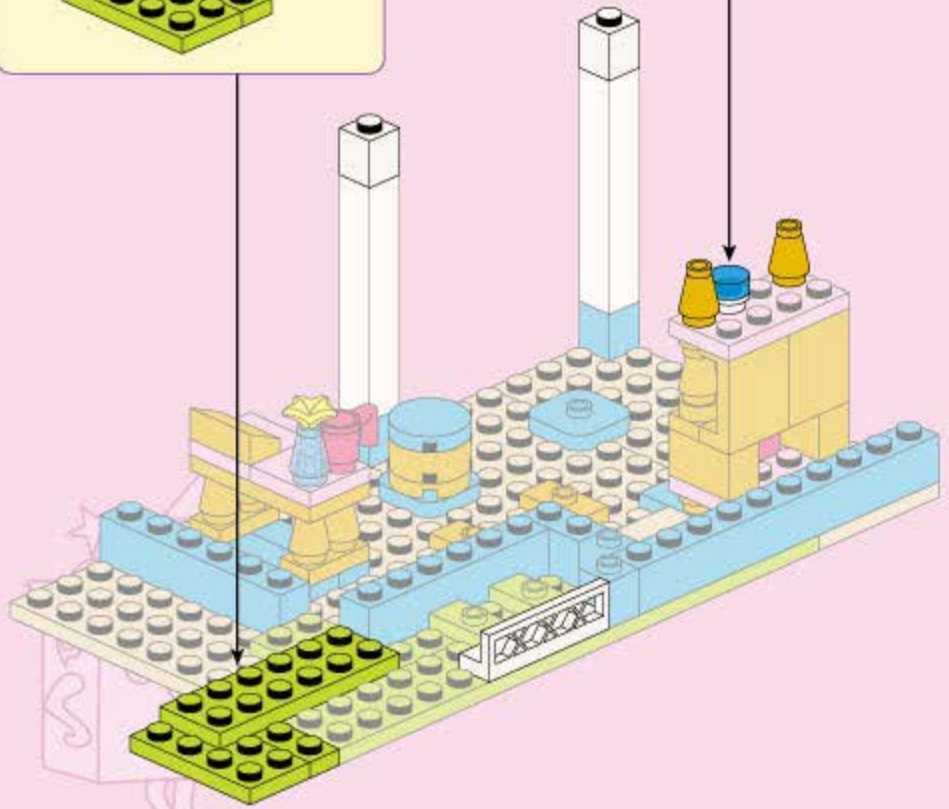
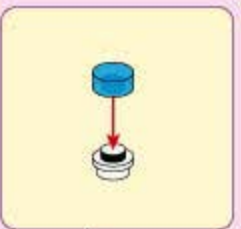
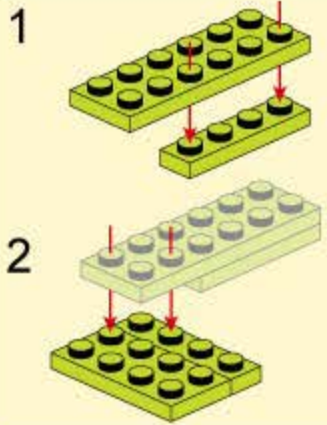
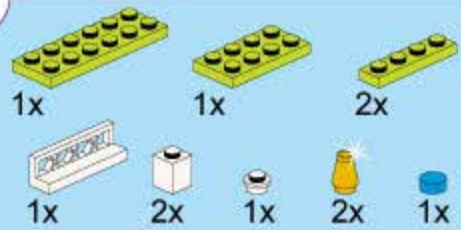

10

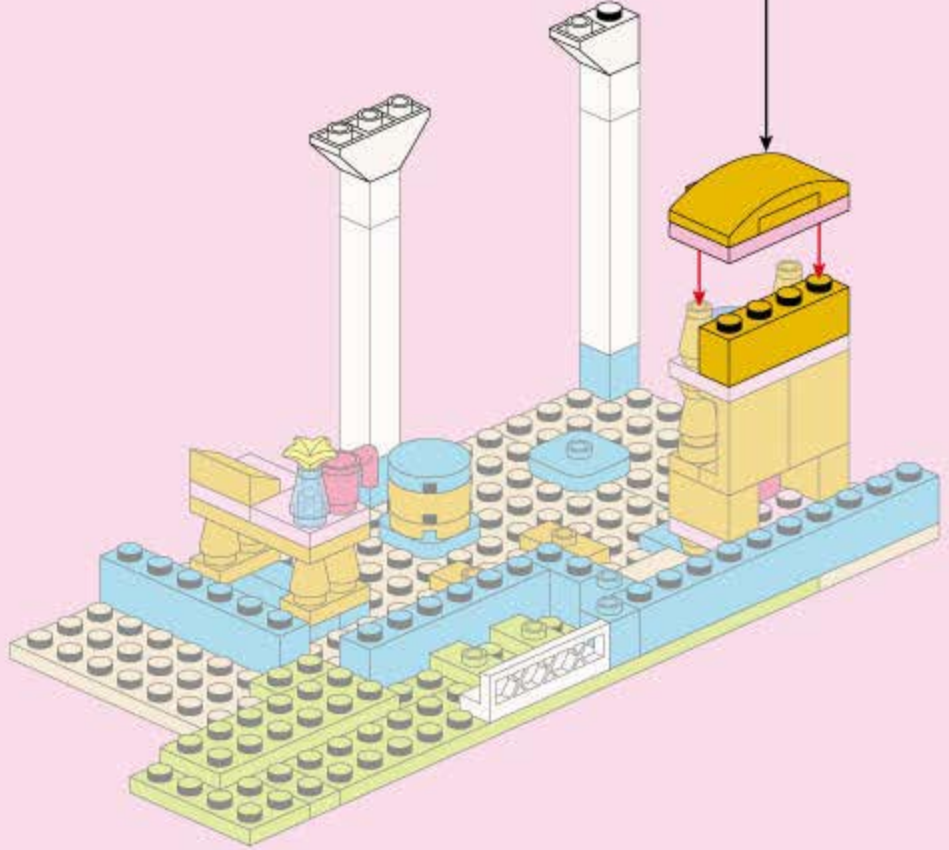
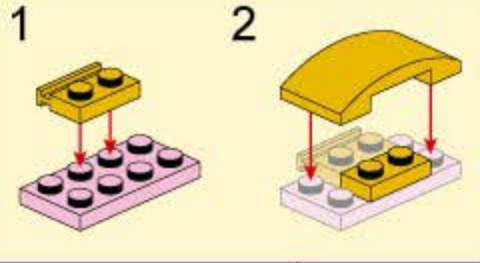
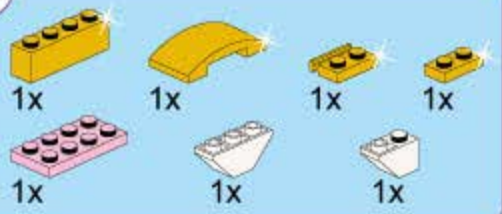

11

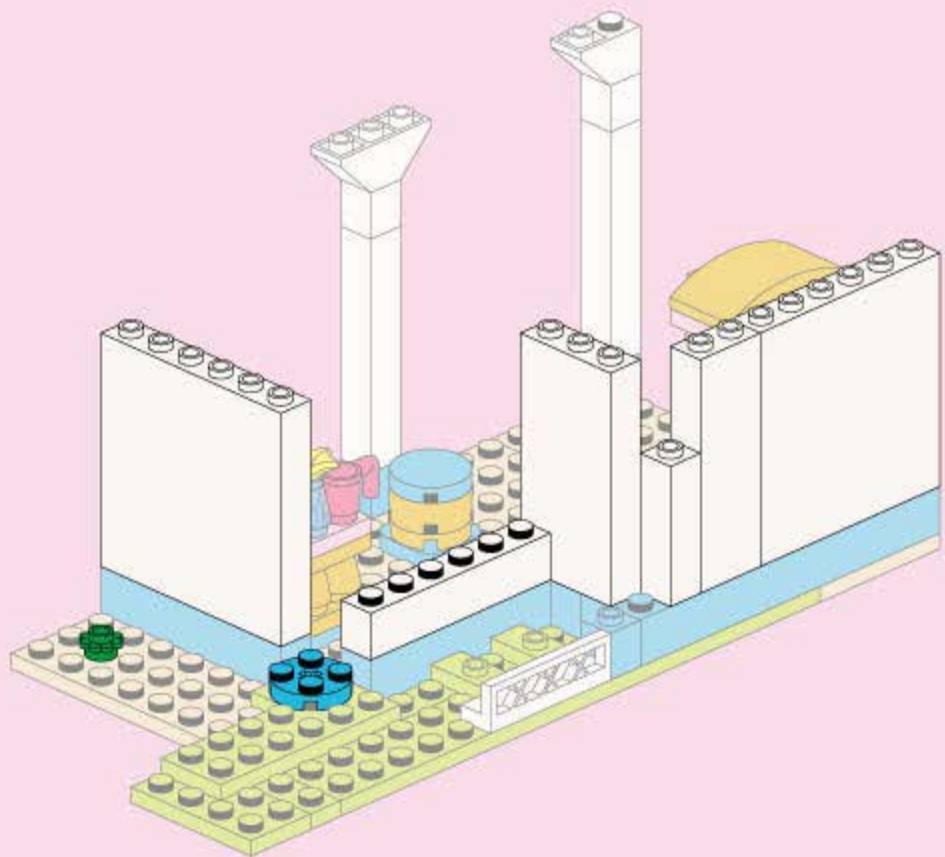
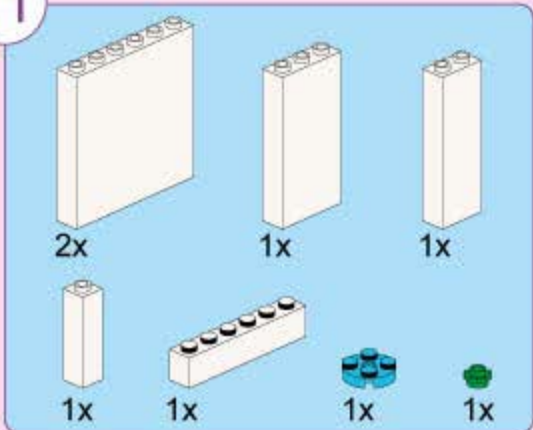

12

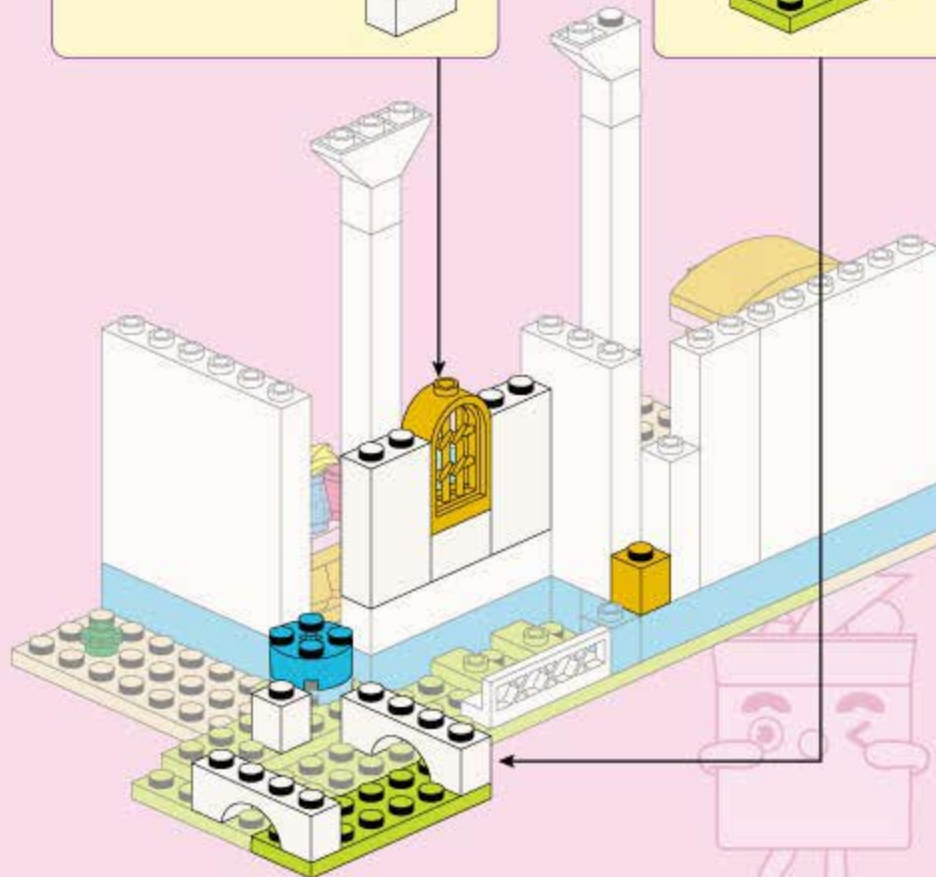
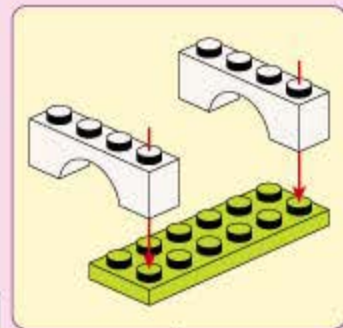
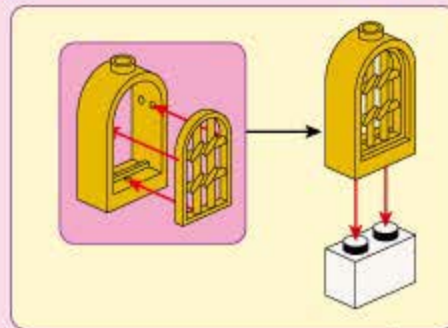
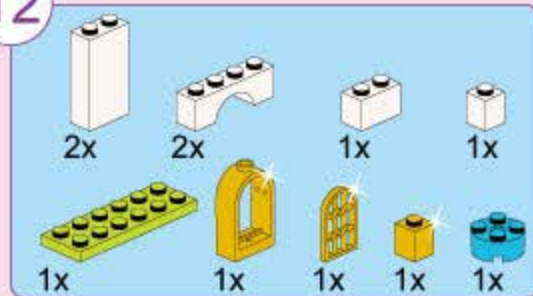

13

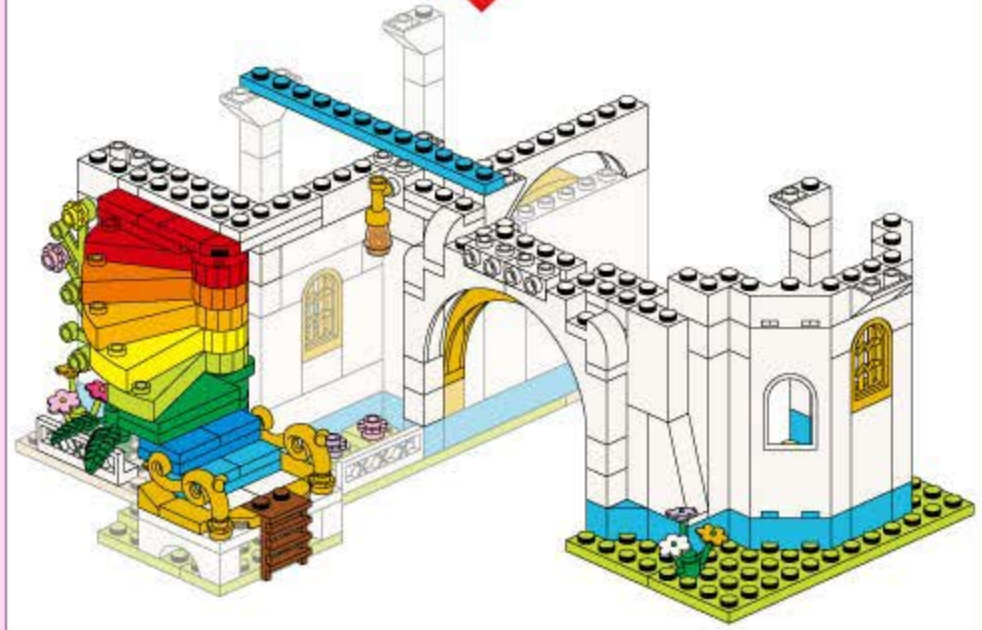
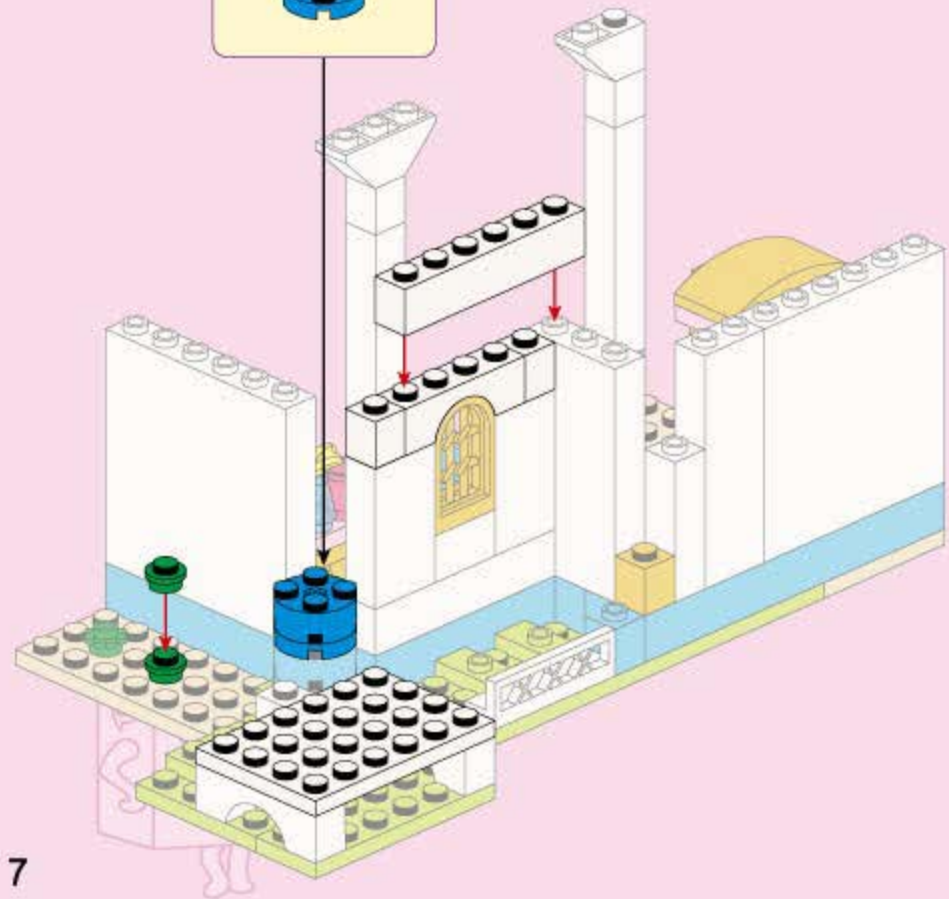
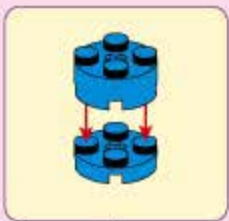
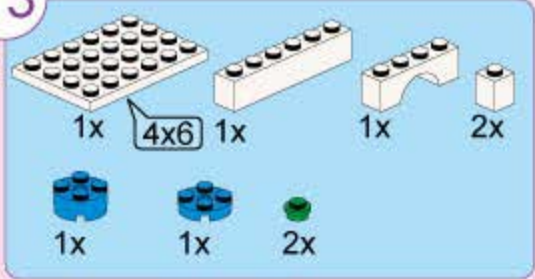

14

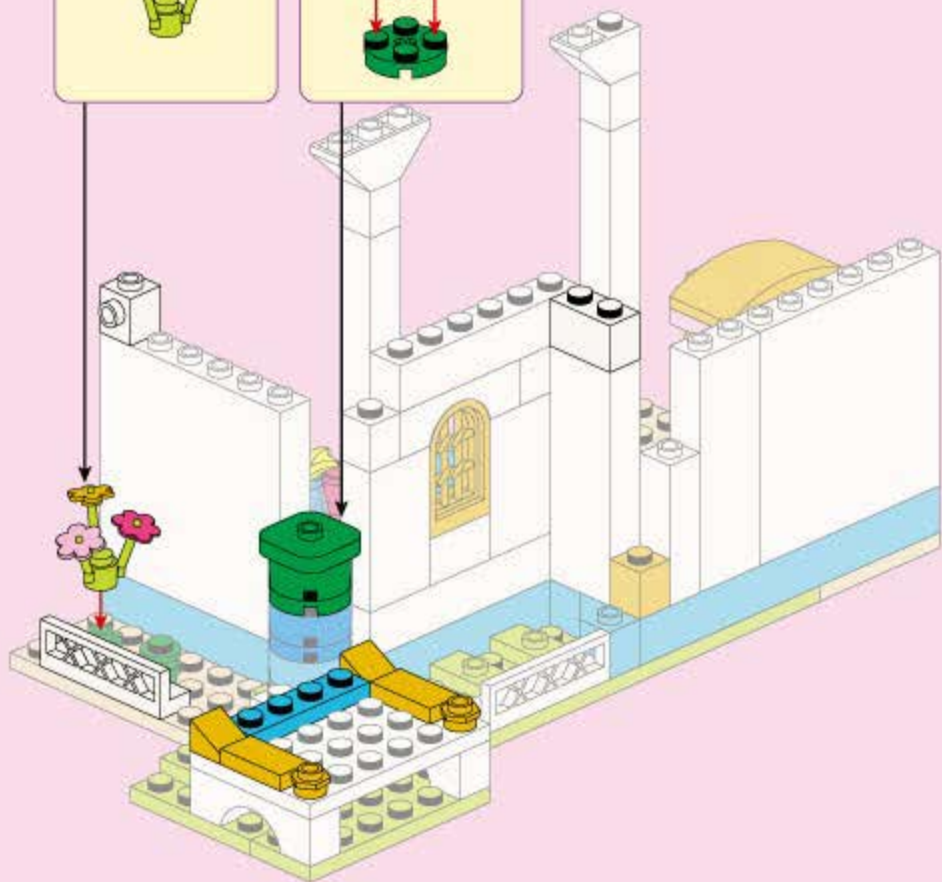
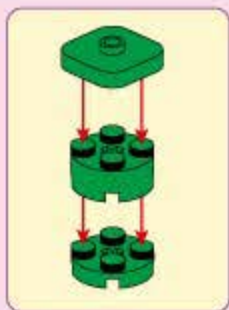
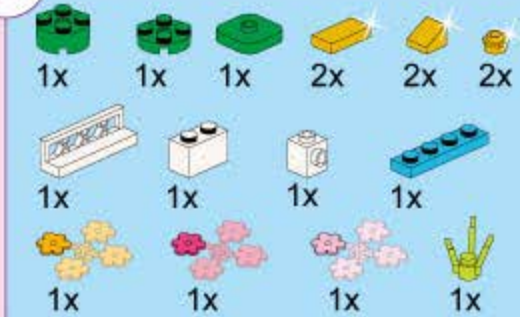

15

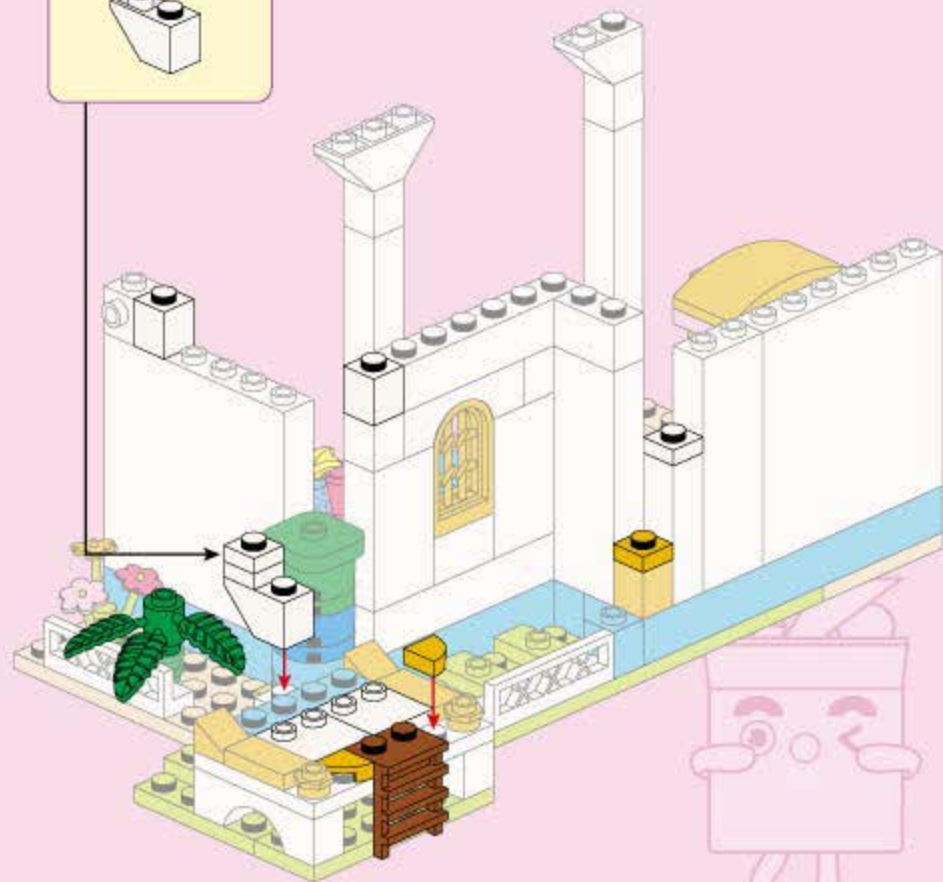
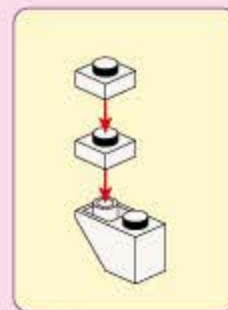
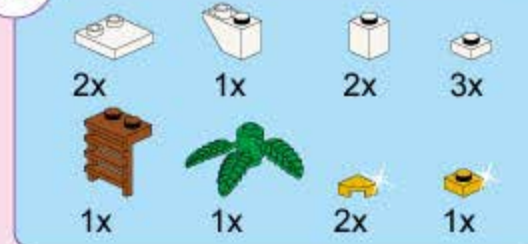

16

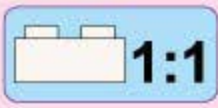
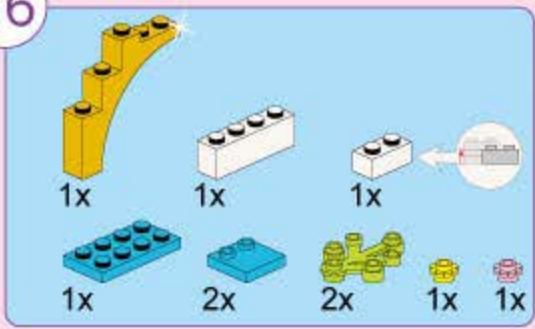

17

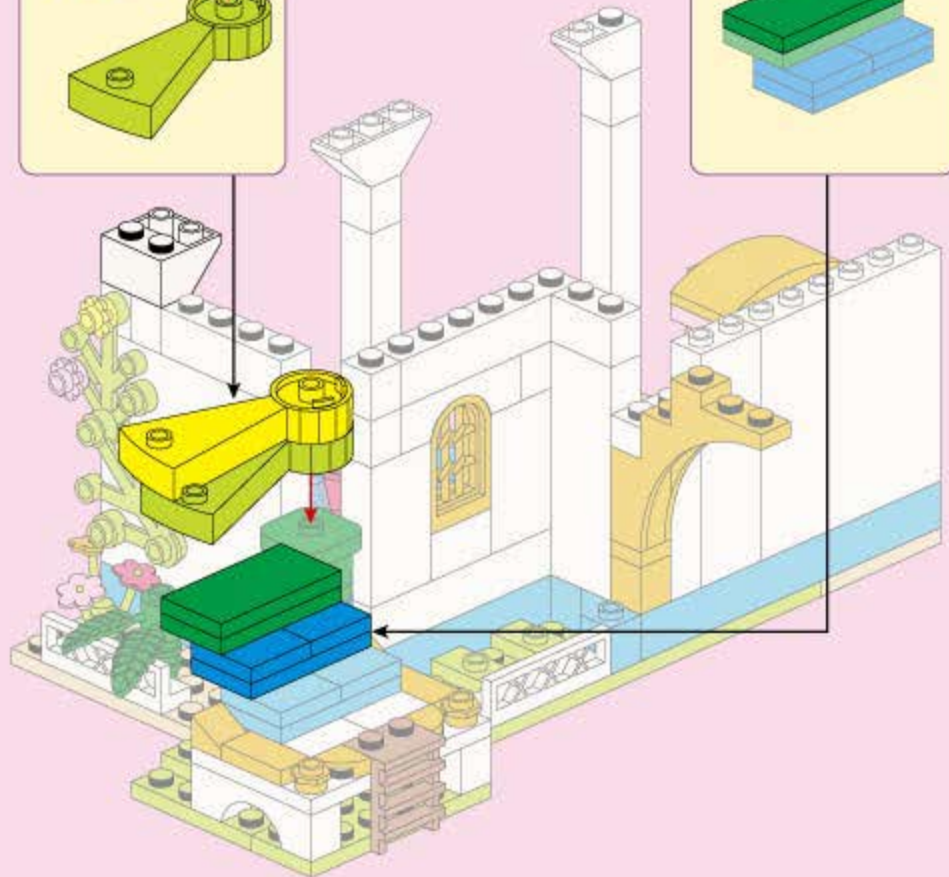
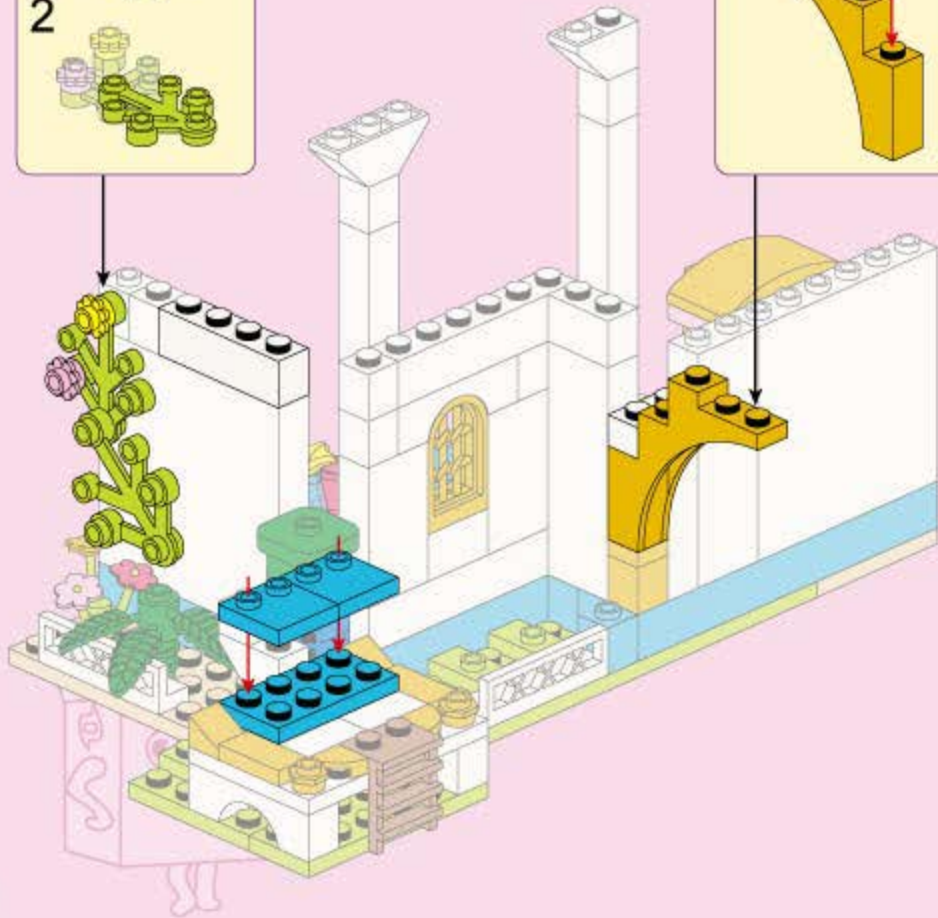
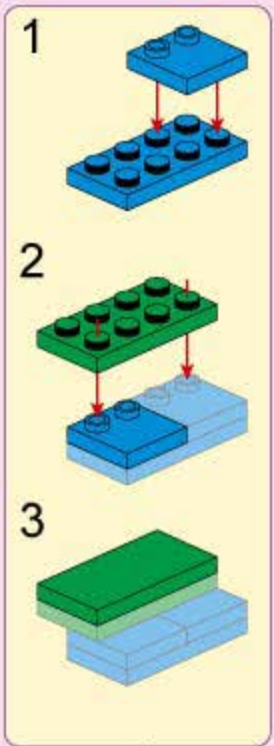
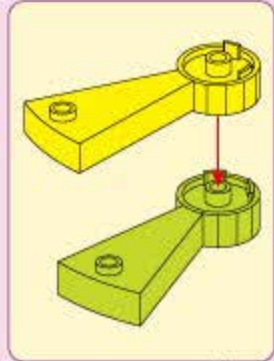
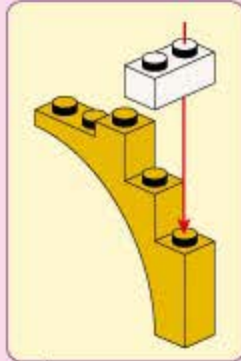
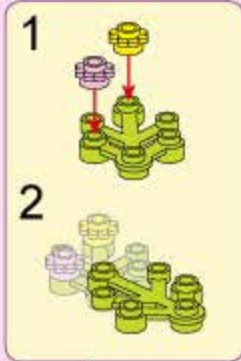
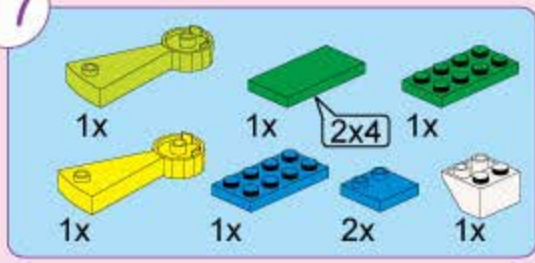

18

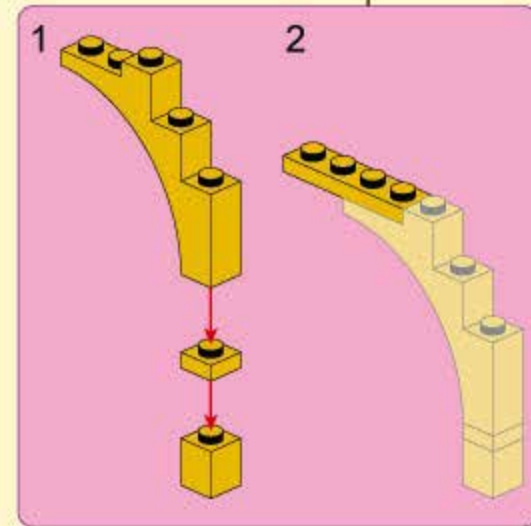
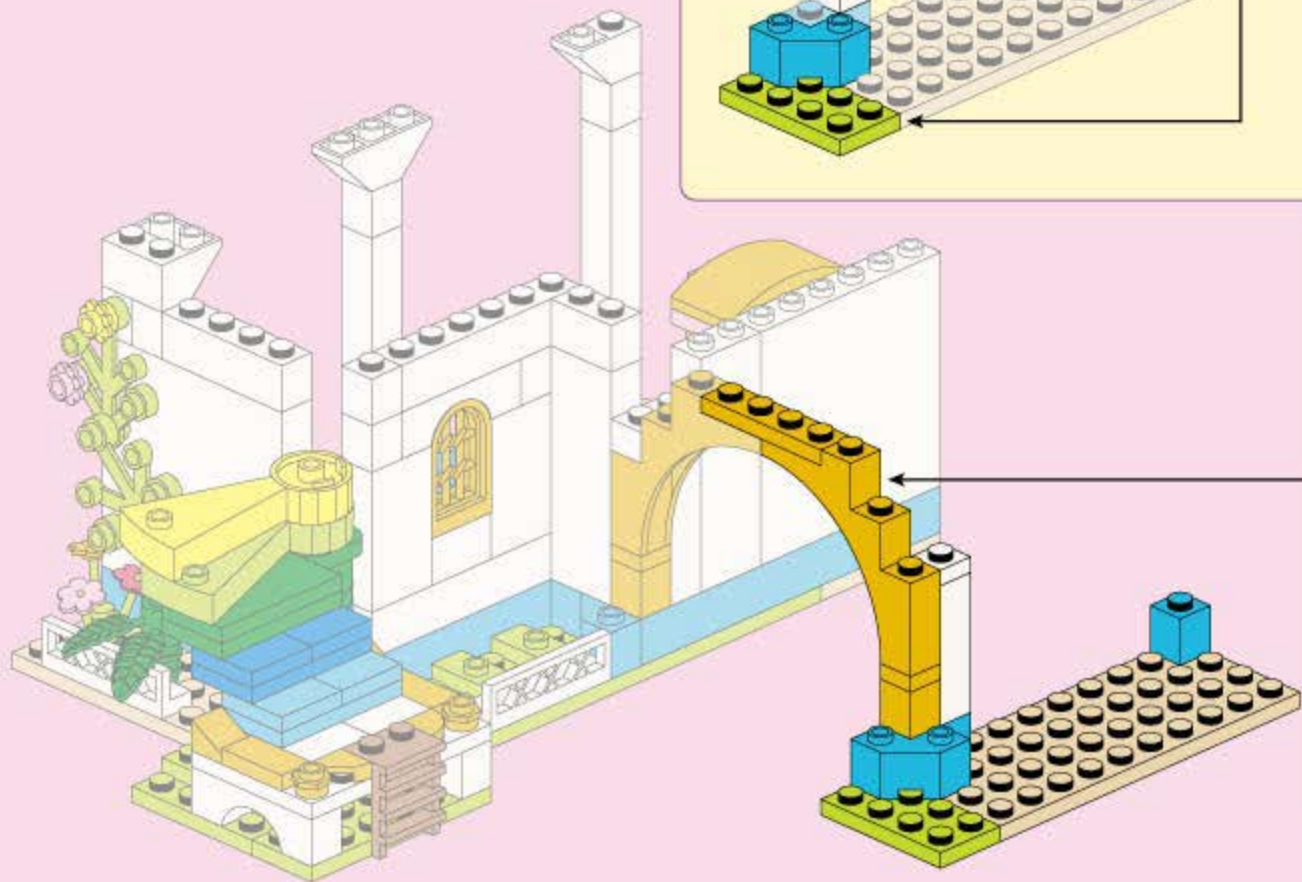
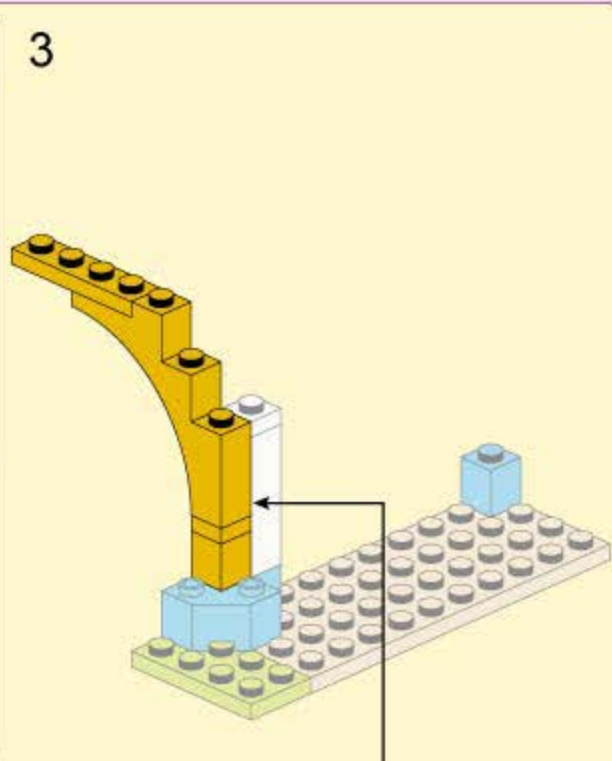
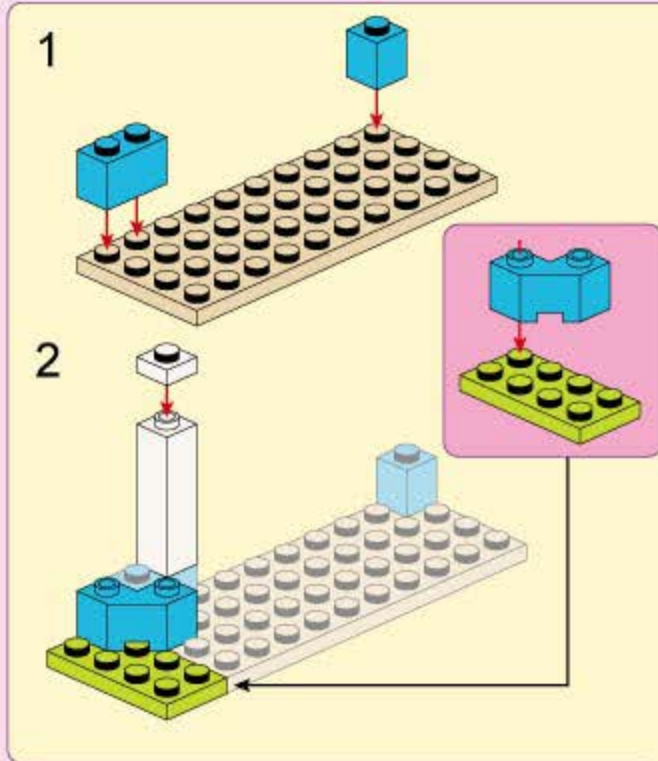
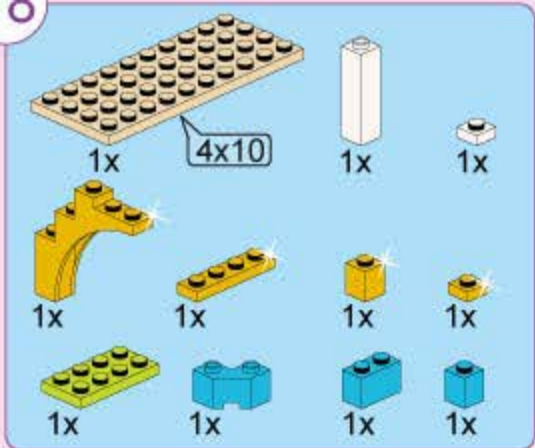

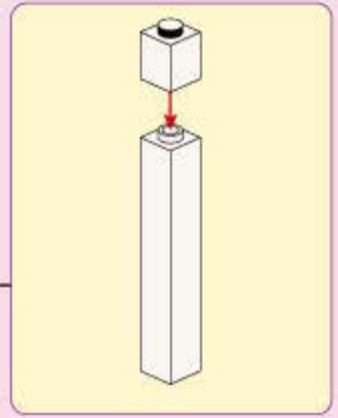
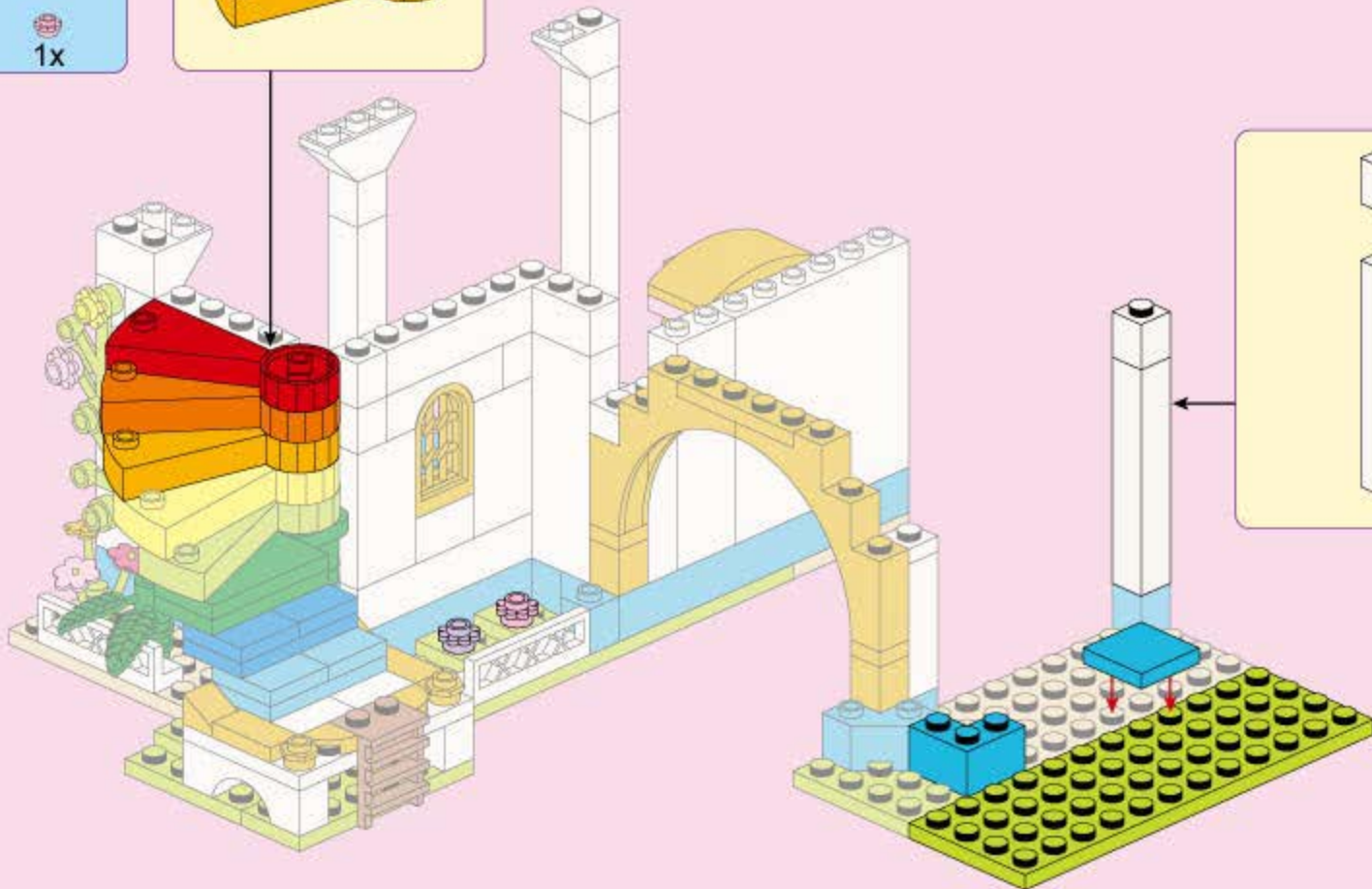
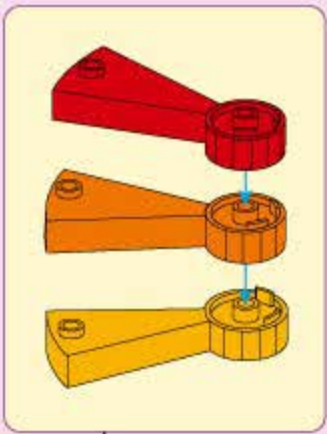
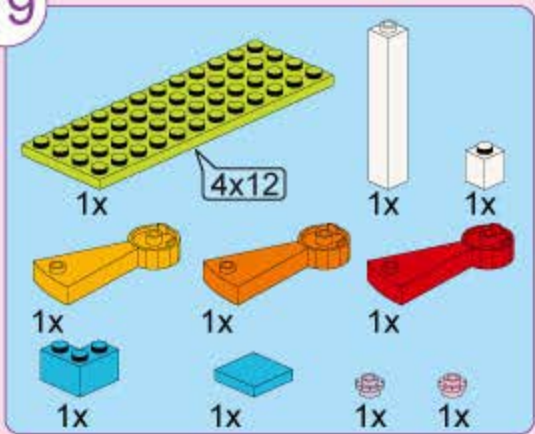

20

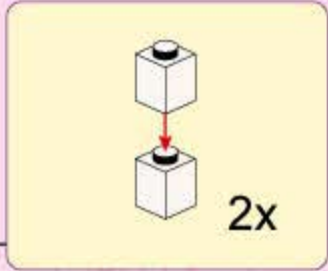
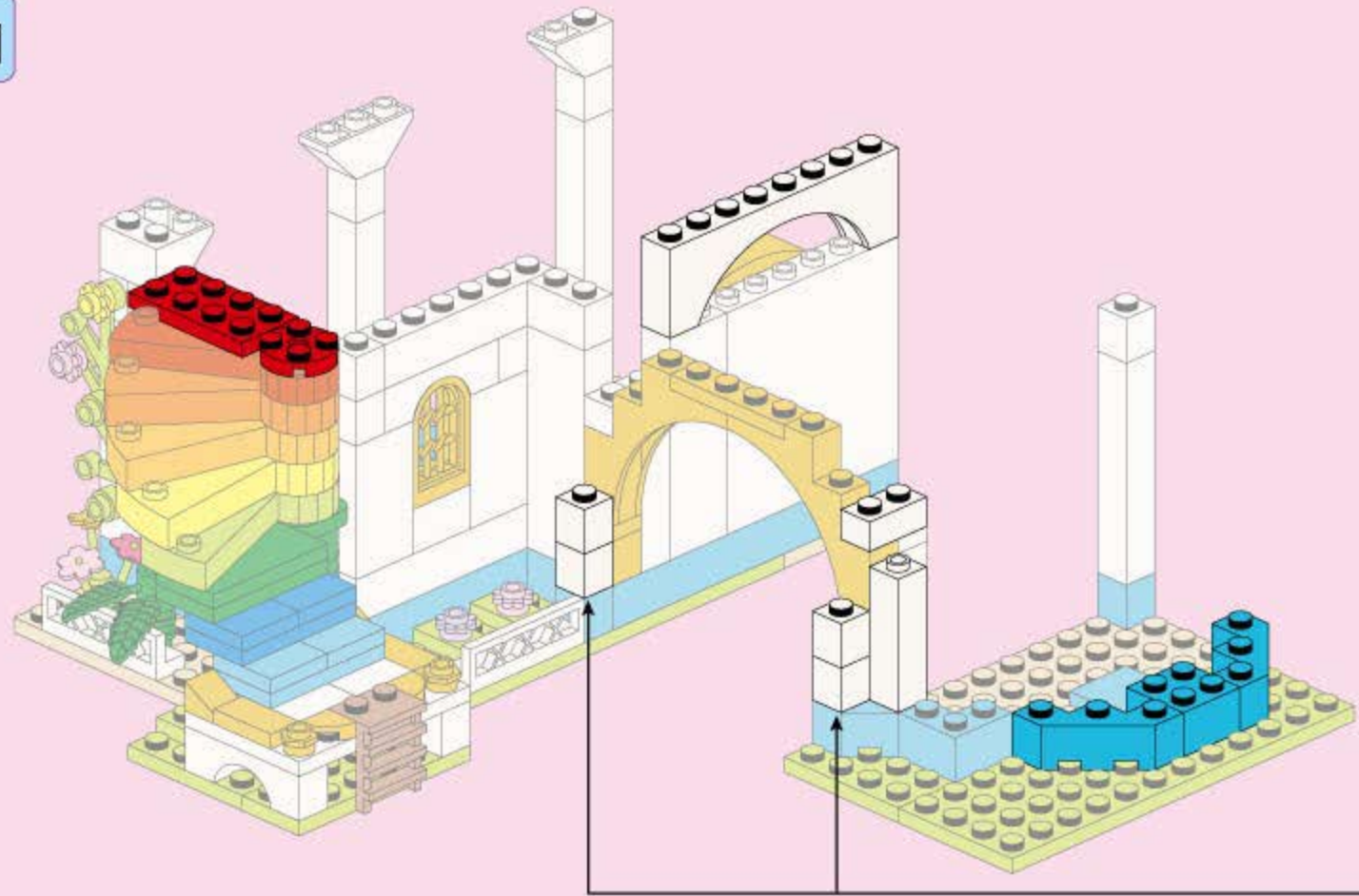
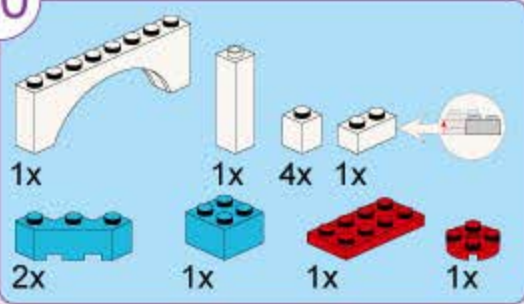

21

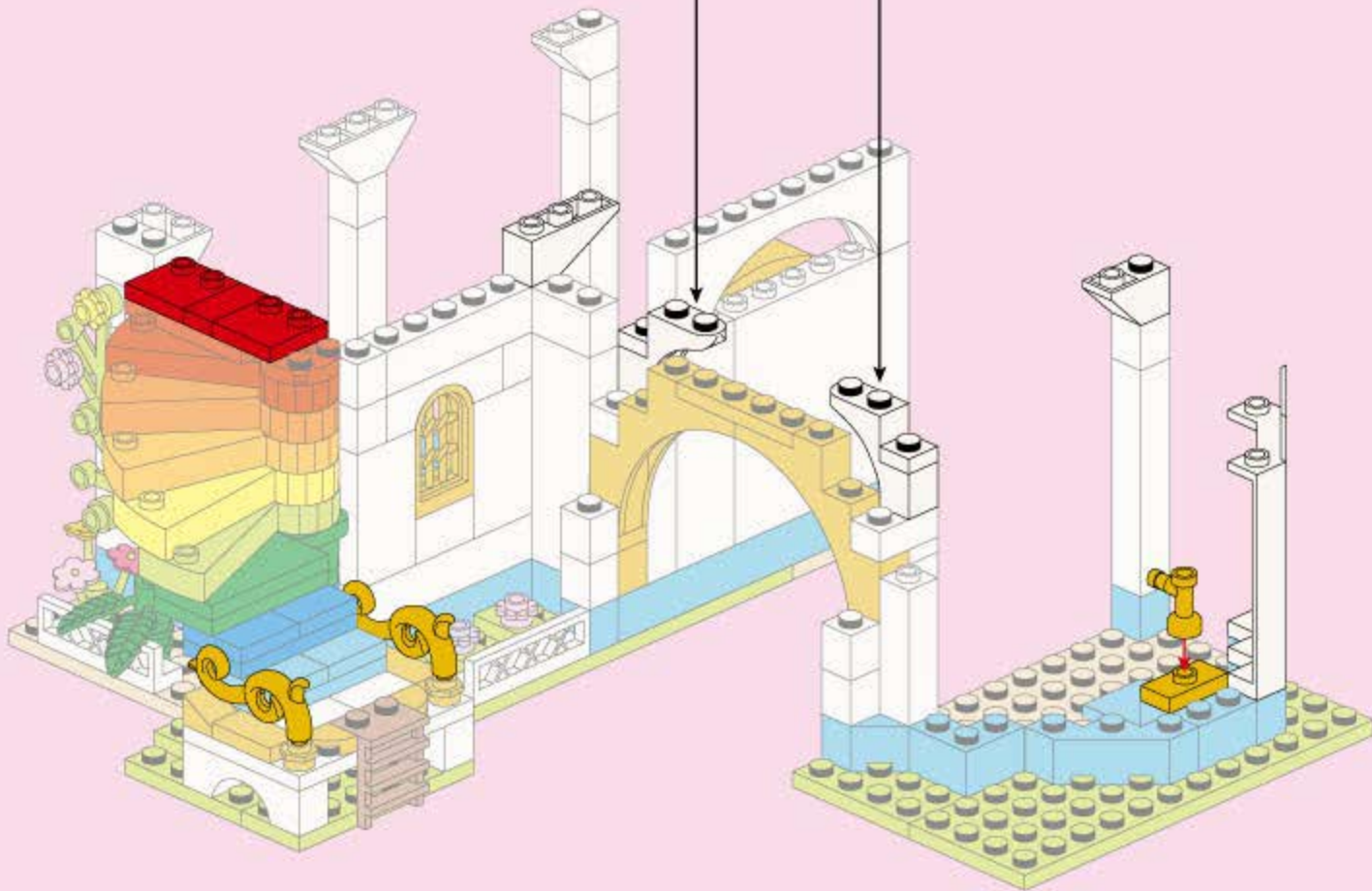
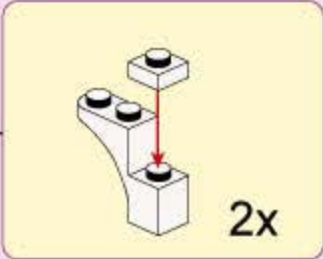
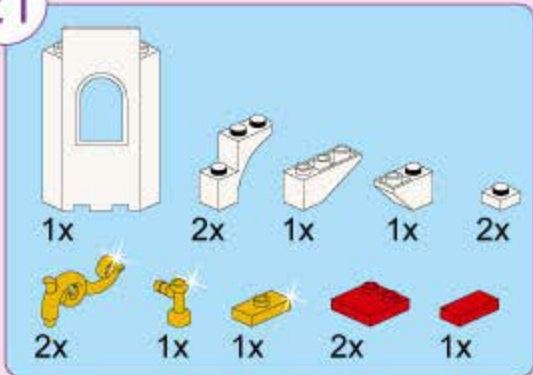

22

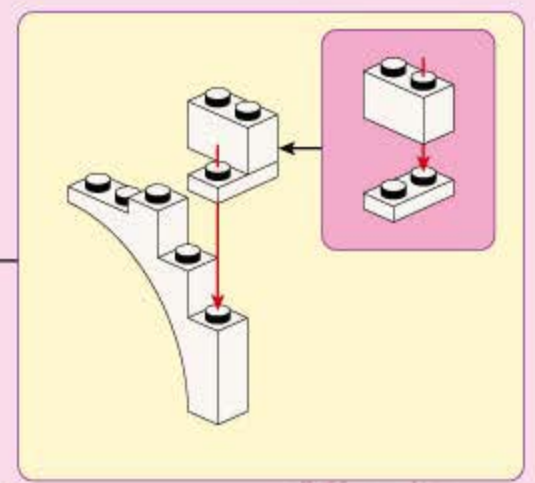
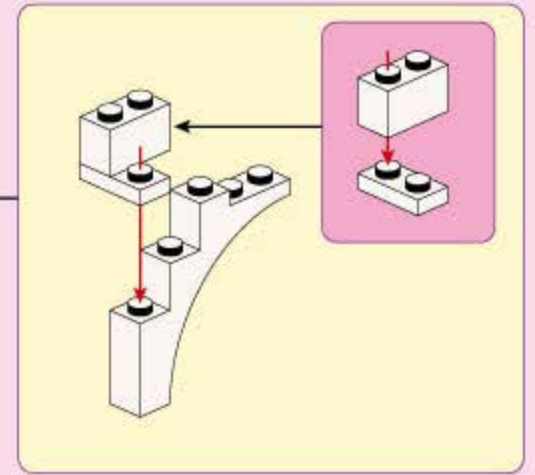
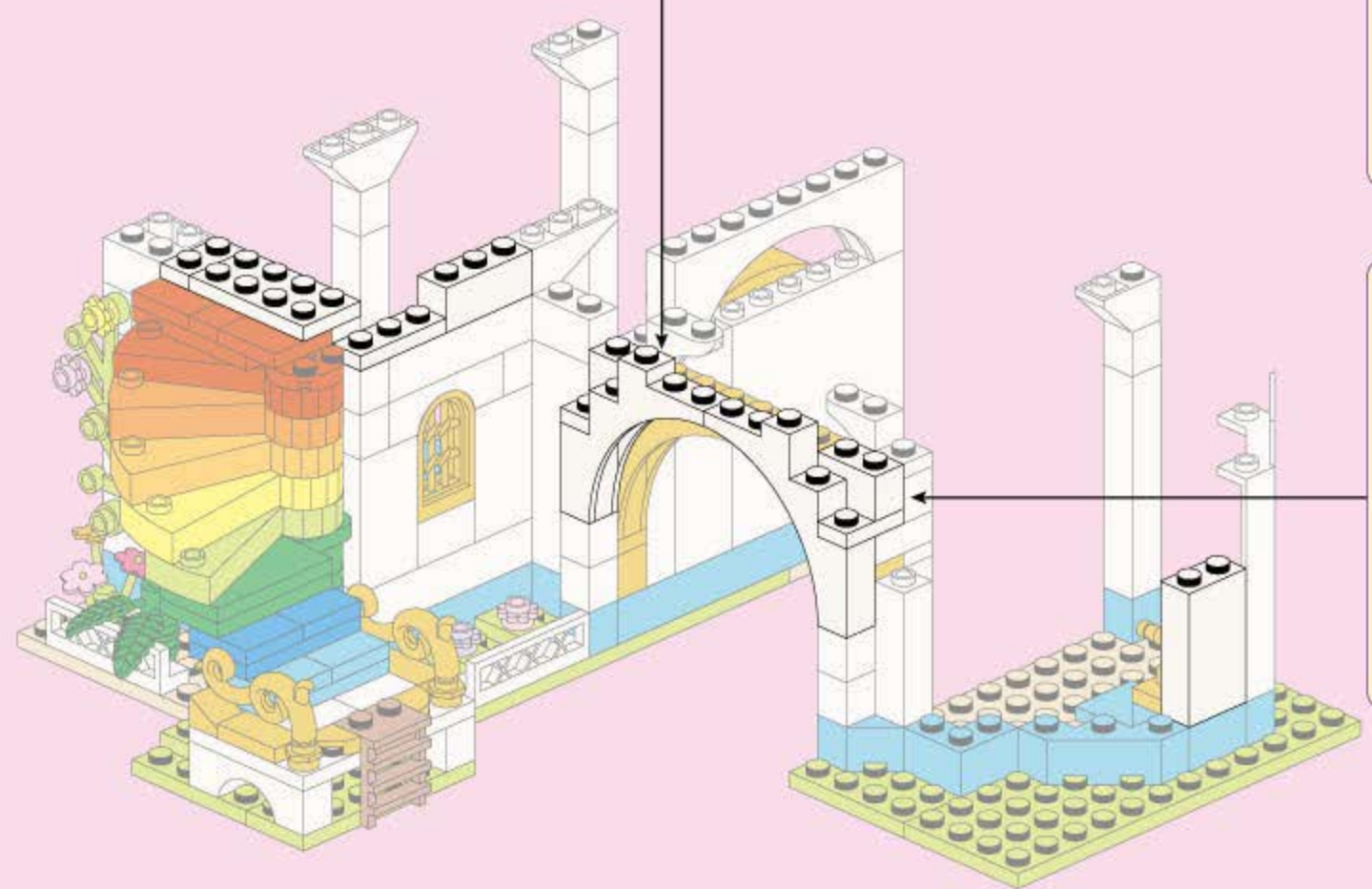
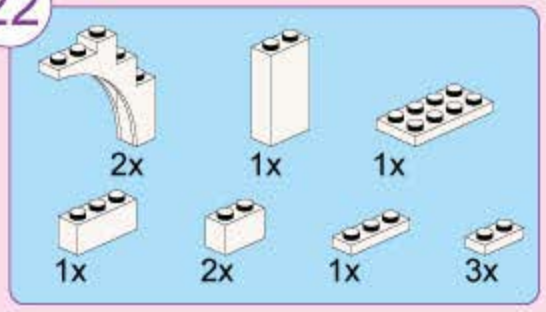

23

Parts list for step 23:

- 1x White Technic Pin
- 1x White Technic Wedge
- 1x White Technic 1x8 Beam
- 2x White Technic 1x4 Beam
- 1x White Technic 1x2 Beam with Hole
- 1x White Technic 1x2 Connector
- 1x White Technic 1x2 Connector
- 1x White Technic 1x2 Connector
- 1x Brown Technic Pin
- 1x Yellow Technic Arch Window
- 1x Yellow Technic Arch Window
- 1x Yellow Technic Pin
- 1x Red Technic Pin

1:1

Assembly inset showing a yellow Technic pin being inserted into a brown Technic pin, which is already attached to a white Technic 1x2 connector.

Assembly inset showing two white Technic 1x4 beams being connected to a white Technic 1x2 beam with holes.

Main assembly diagram showing the construction of a LEGO building. Red arrows indicate the placement of parts from the parts list. A yellow Technic arch window is being attached to a white Technic structure. A yellow Technic pin is being inserted into a brown Technic pin. A red Technic pin is being inserted into a white Technic 1x2 connector.

Assembly inset showing a yellow Technic arch window being attached to a white Technic structure.



24

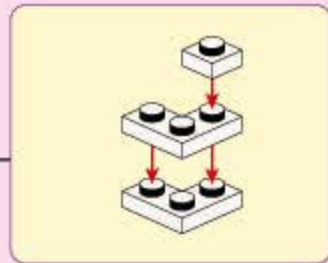
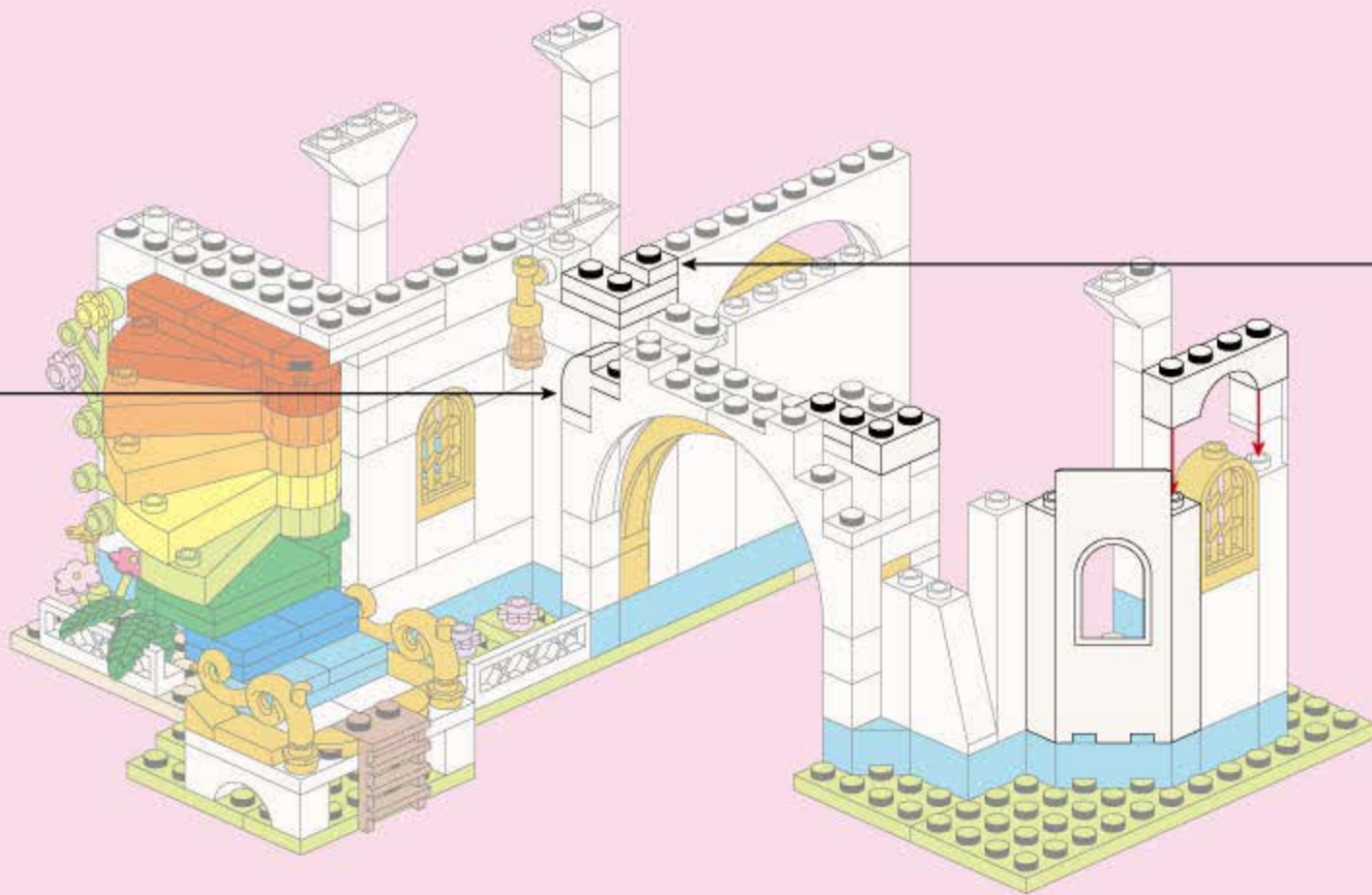
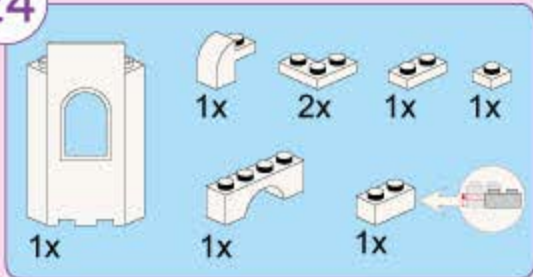

25

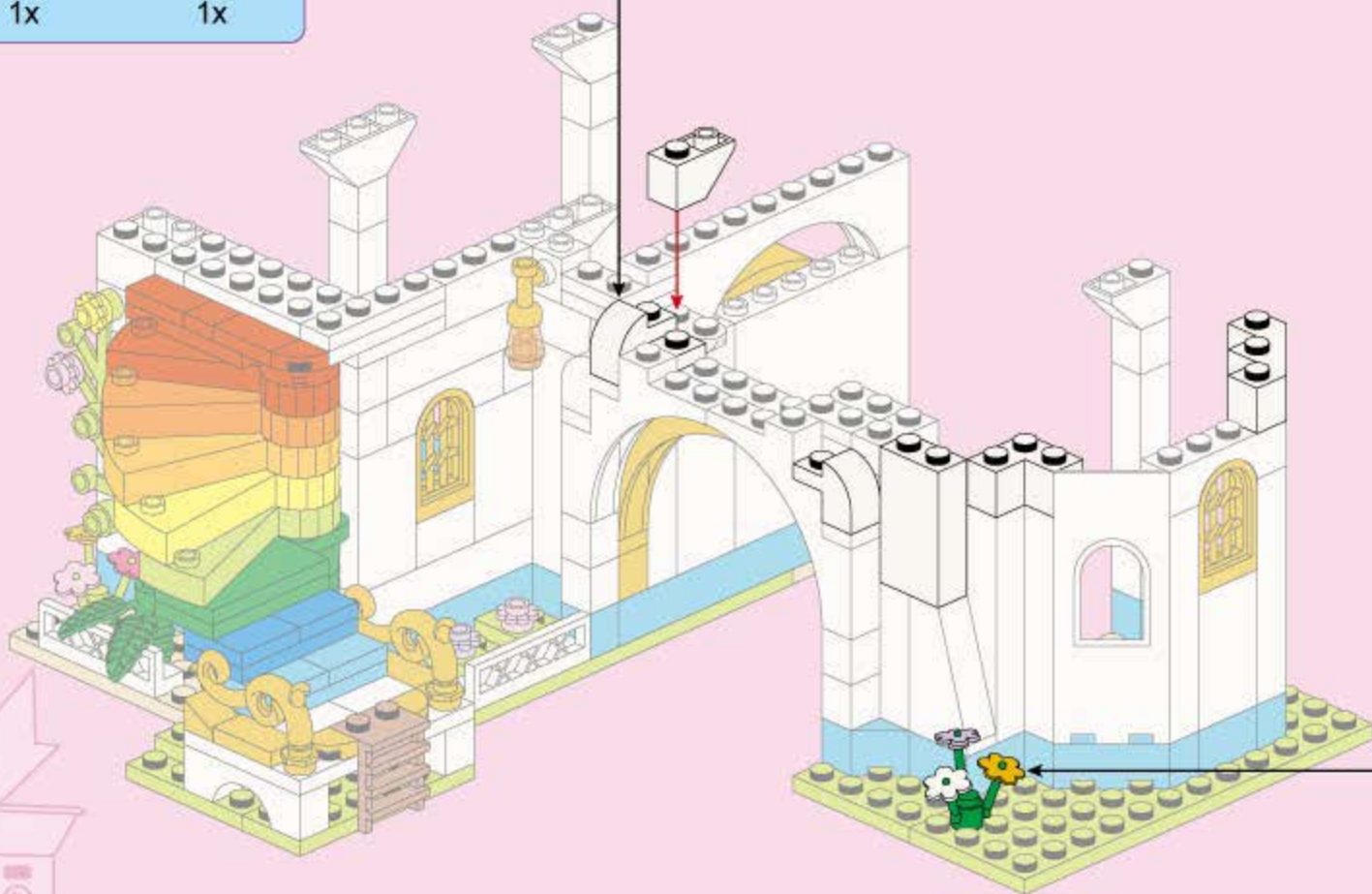
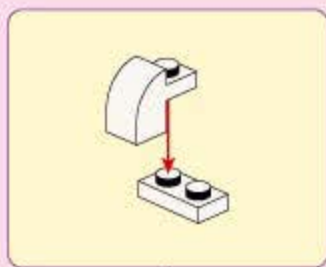

26

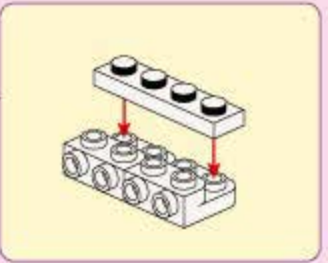
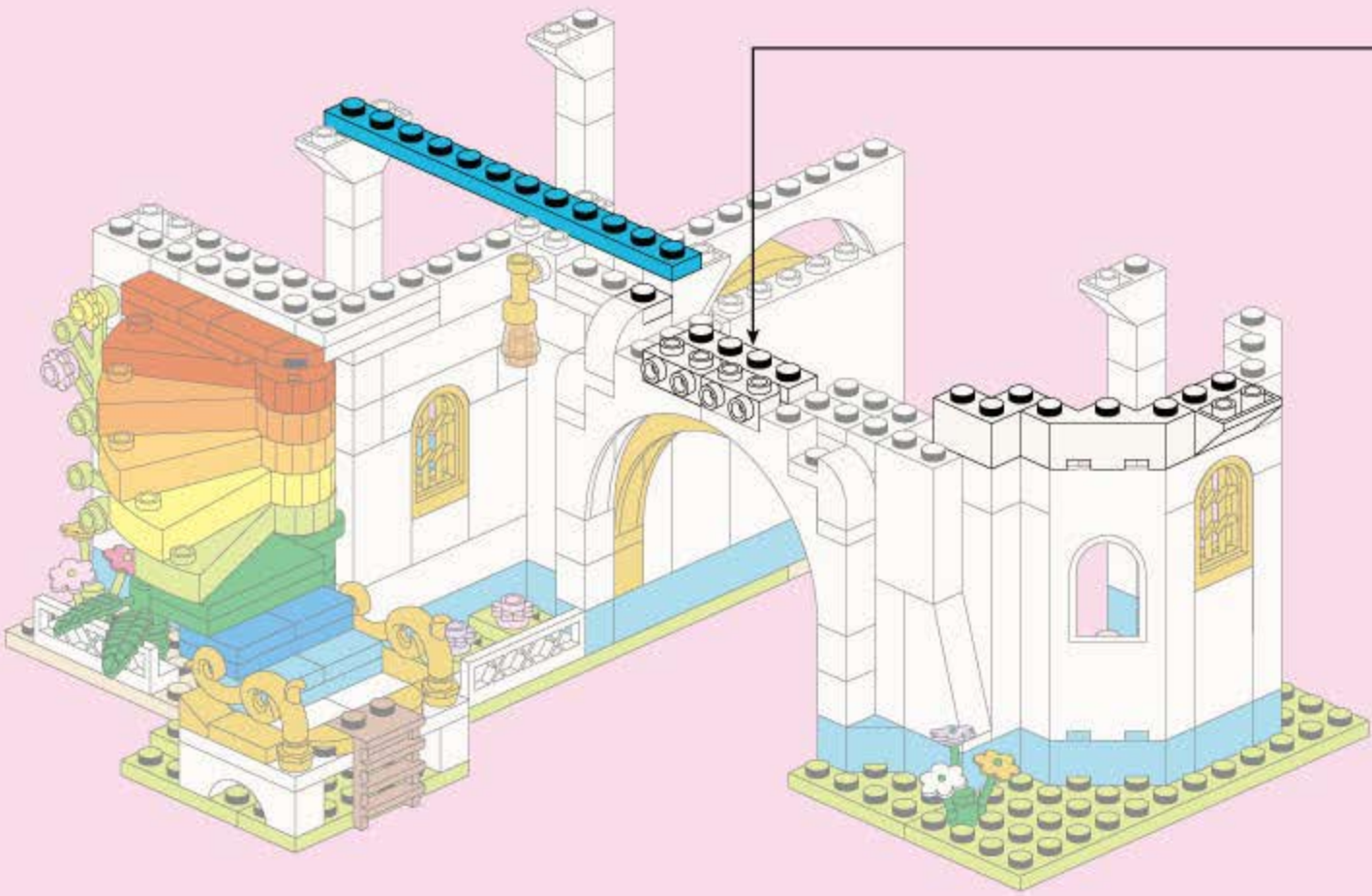
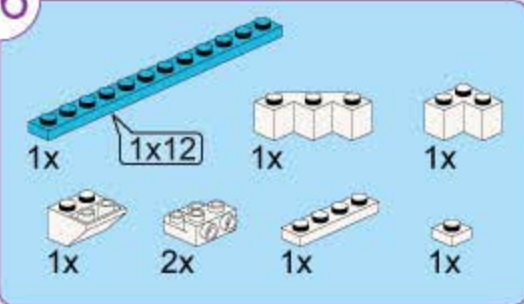

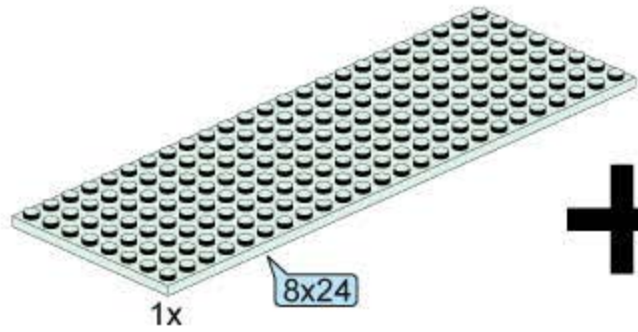

+

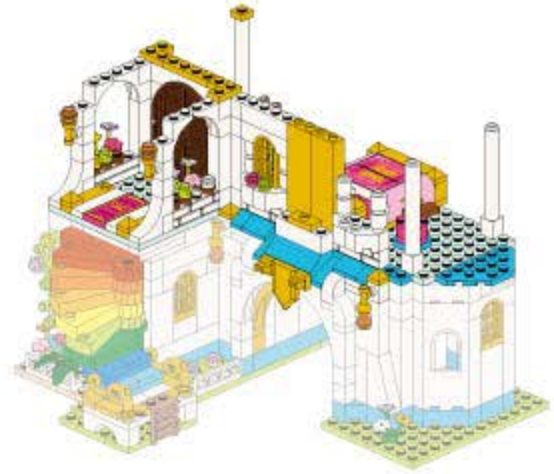

27

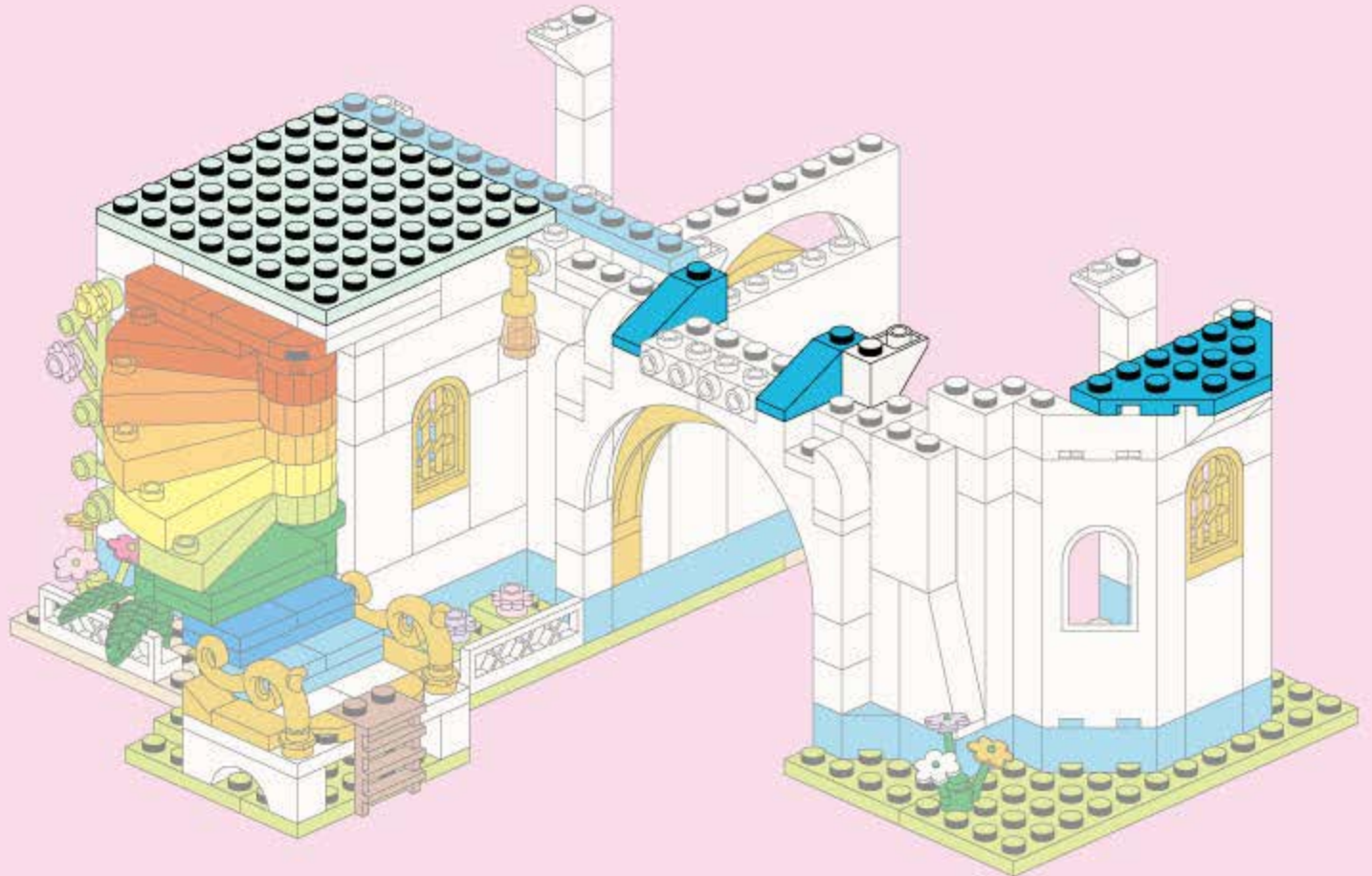
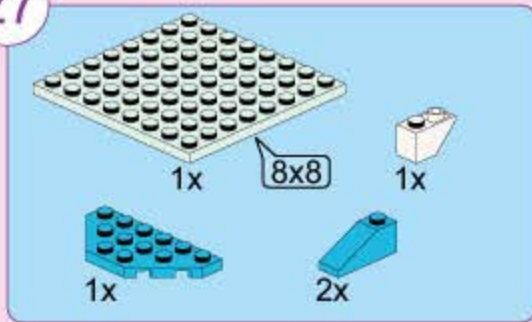

28

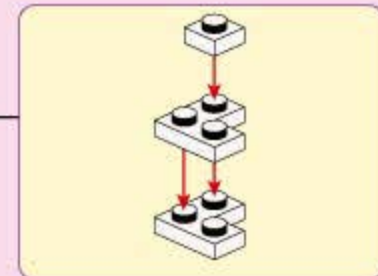
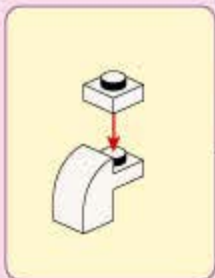
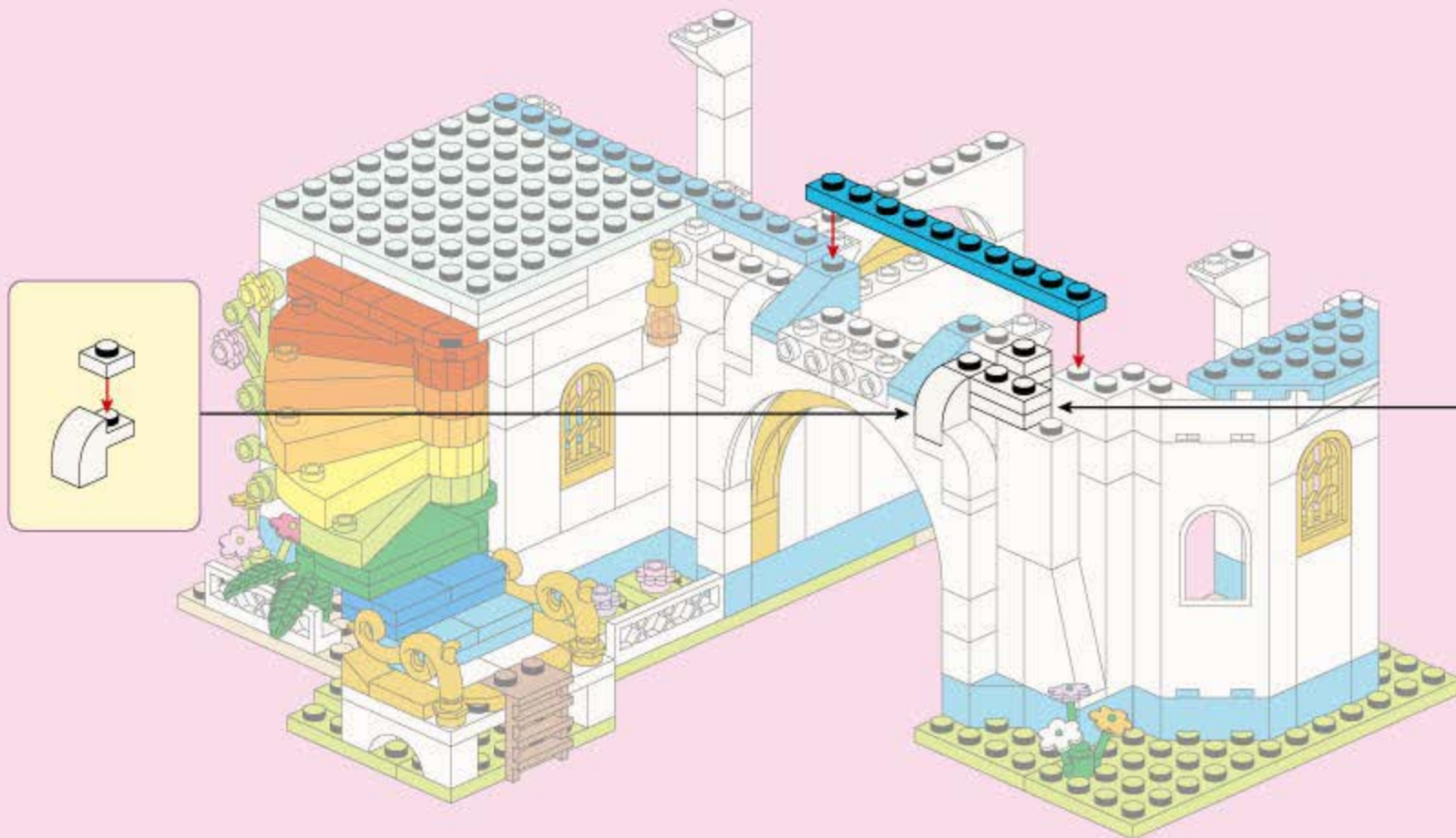
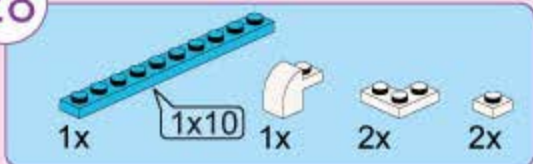

29

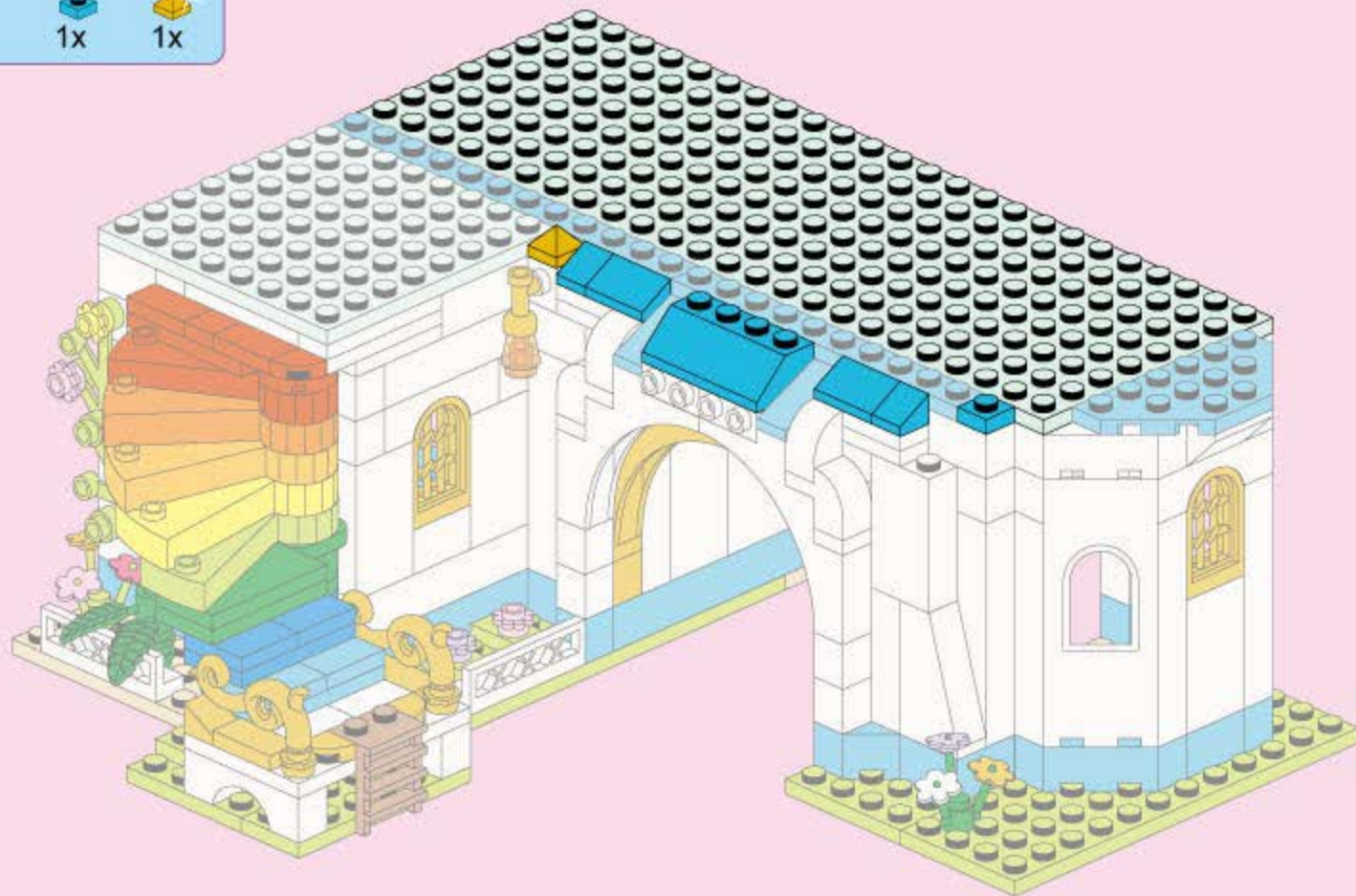
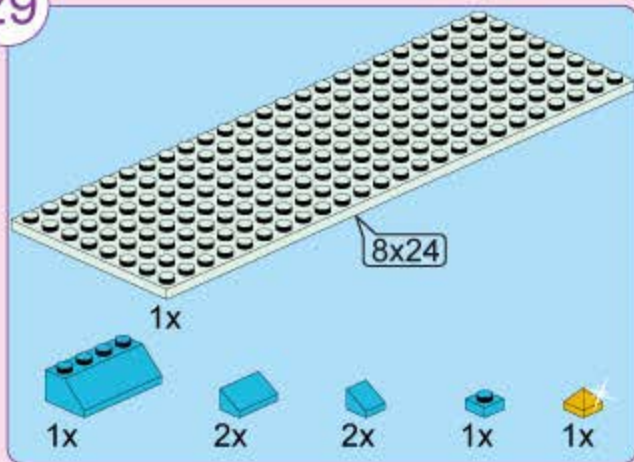

30

- 1x [Yellow Technic Beam 1x5]
- 1x [Yellow Technic Plate 1x3]
- 2x [Yellow Technic Pin]
- 1x [Yellow Technic Bush]
- 1x [Yellow Technic Connector]
- 3x [Yellow Technic Brick with Hole]
- 1x [White Technic Brick with Hole]
- 2x [White Technic Brick with Hole]
- 7x [Blue Technic Plate 1x3]
- 1x [Brown Technic Pin]

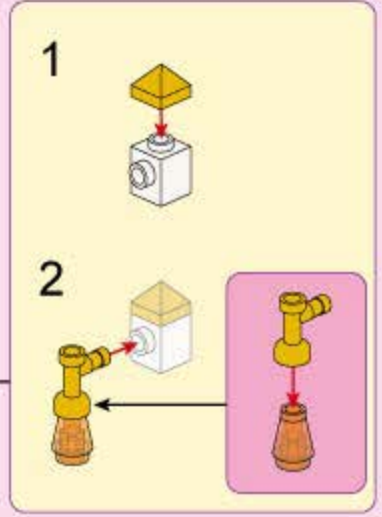
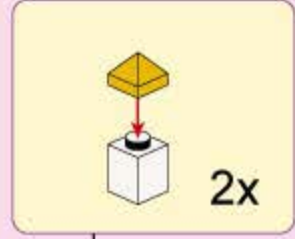



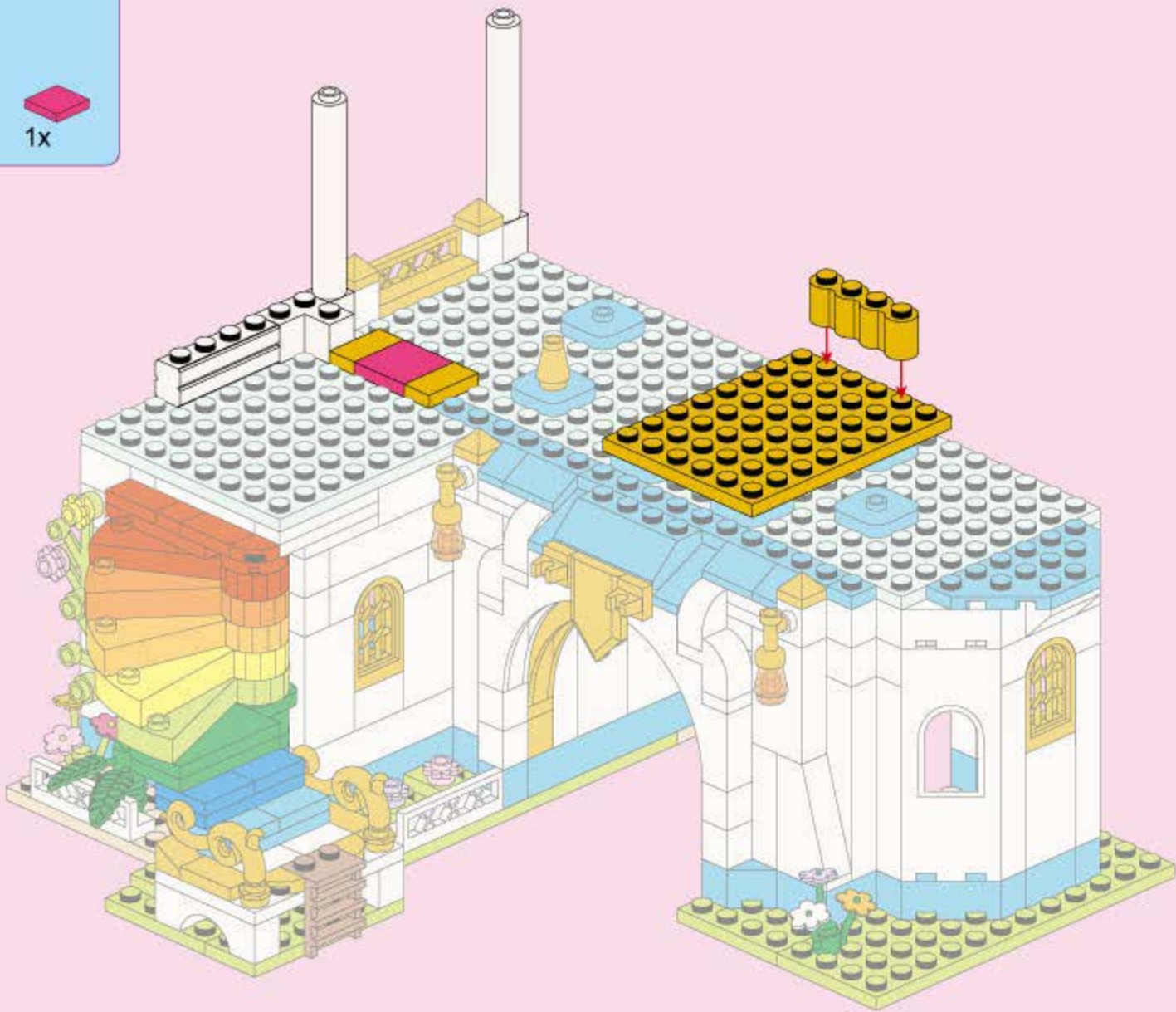
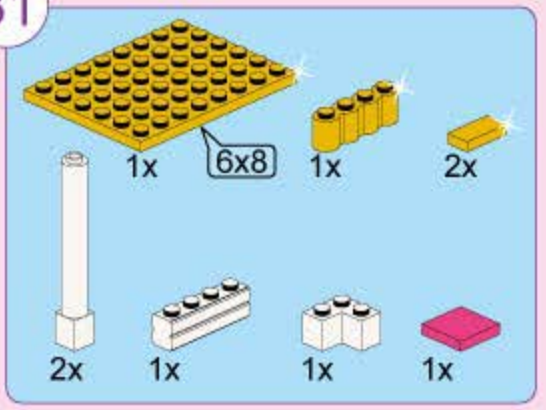



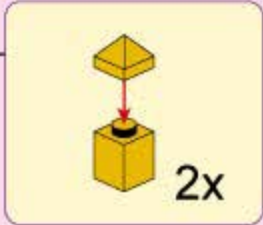
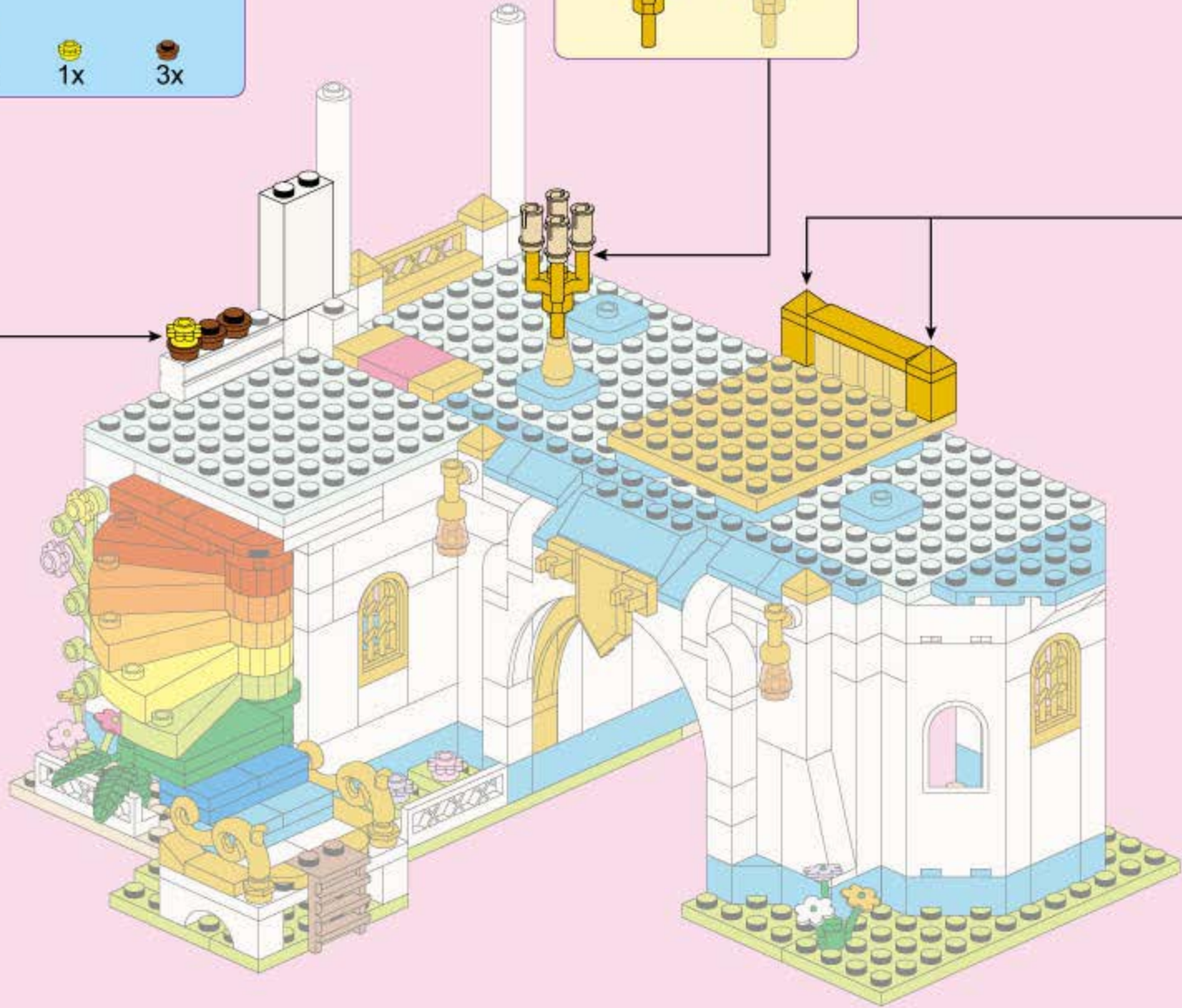
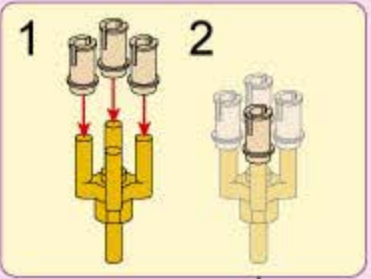
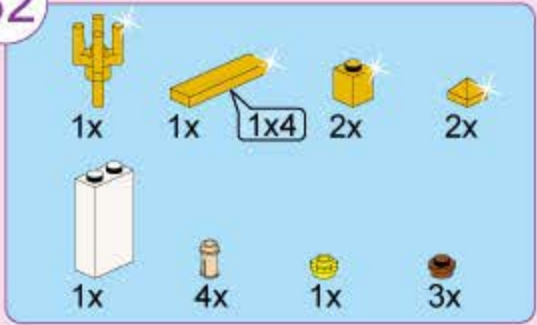



31



32



- | | | | | |
|---|---|---|---|---|
|  |  |  |  |  |
| 2x | 2x | 1x | 1x | 1x |
|  |  |  |  |  |
| 2x | 2x | 1x | 3x | 1x |

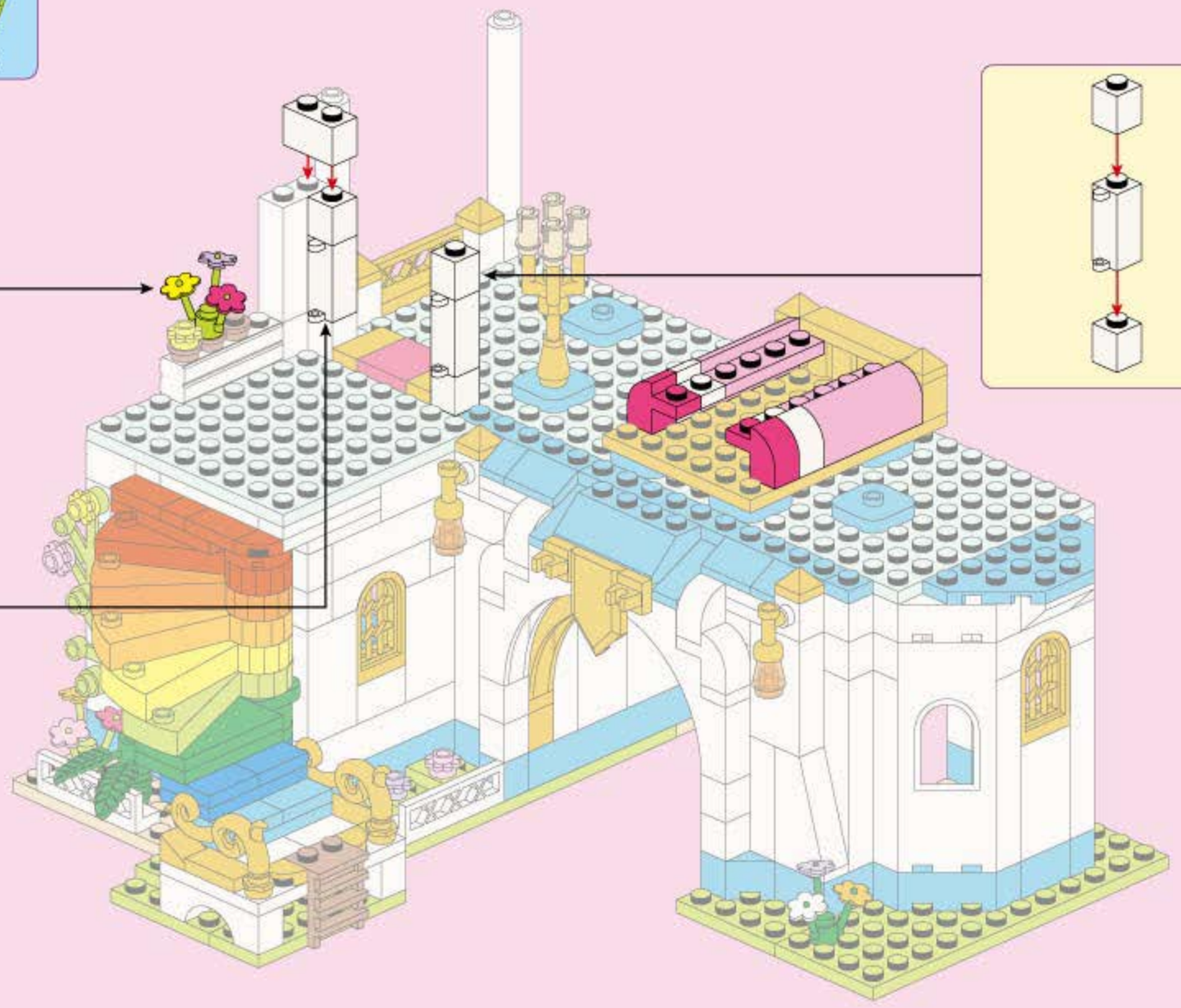
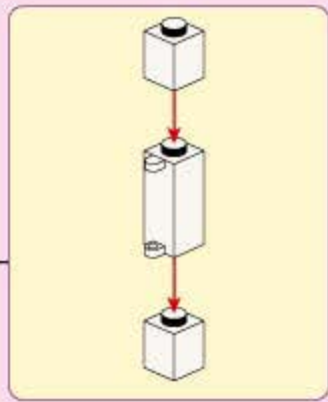
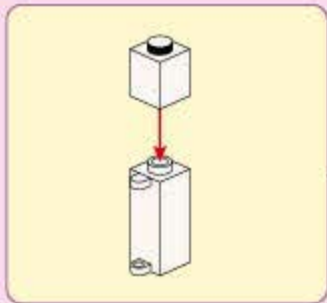

35

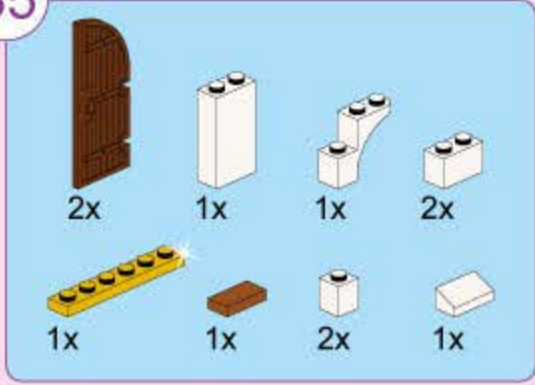

2x
1x
1x
2x
1x
1x
2x
1x

A parts list for step 35, showing eight items with their quantities: two dark brown arched door pieces, one white 1x2 brick with a hole, one white 1x2 Technic brick with a hole, two white 1x2 Technic bricks with a hole, one yellow 1x5 Technic beam with four holes, one brown 1x2 Technic brick, two white 1x2 Technic bricks with a hole, and one white 1x2 Technic brick.

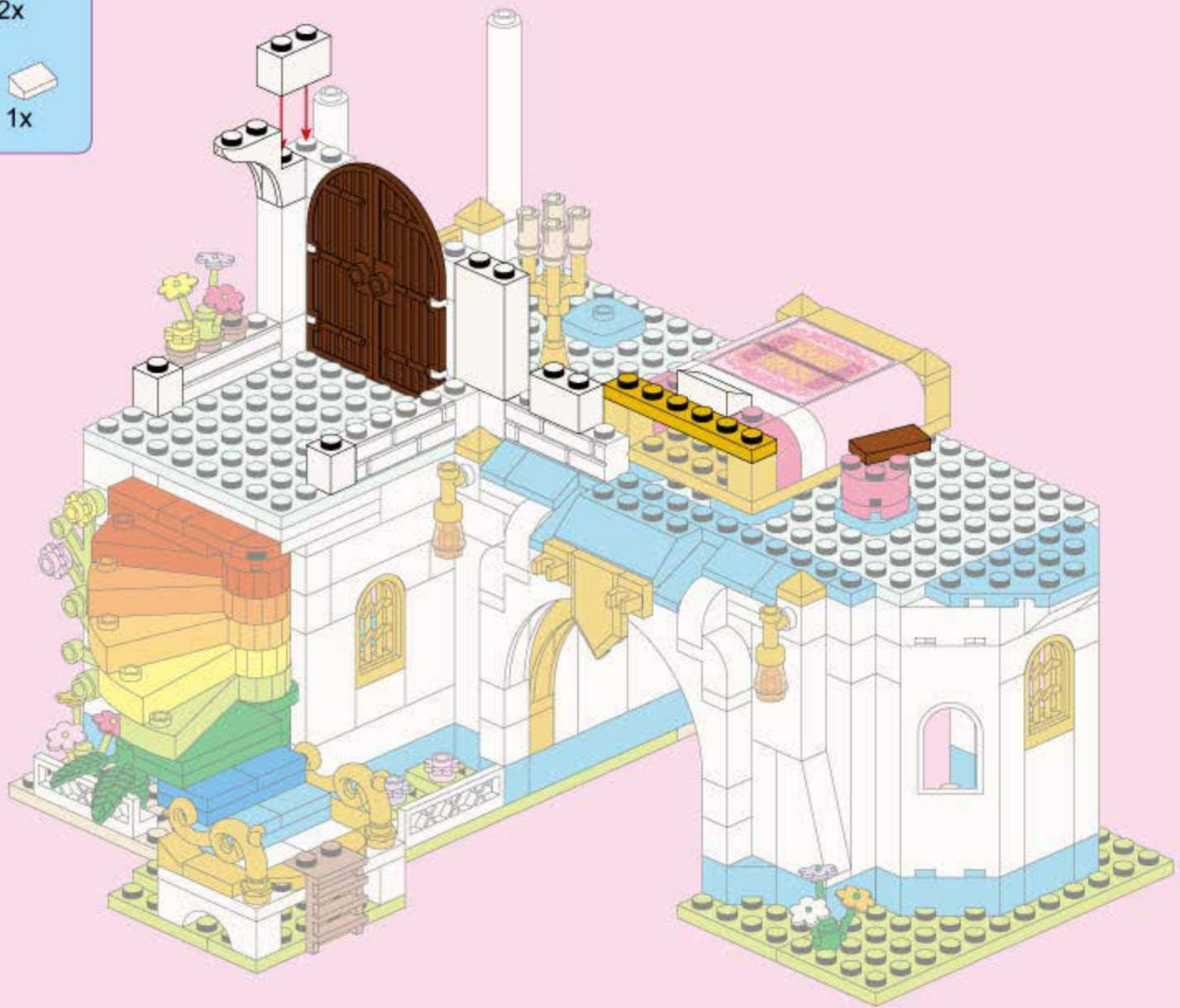

36

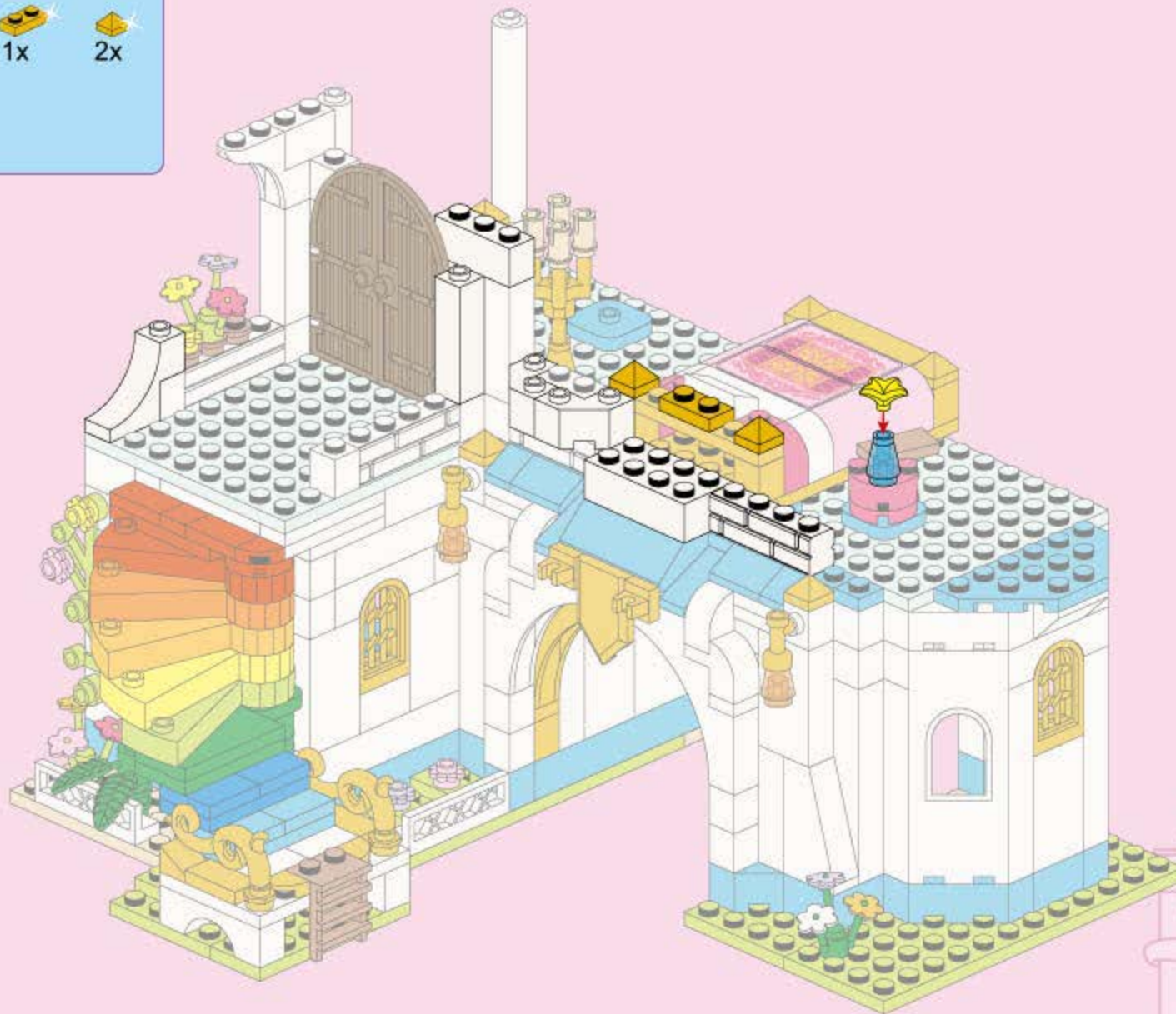
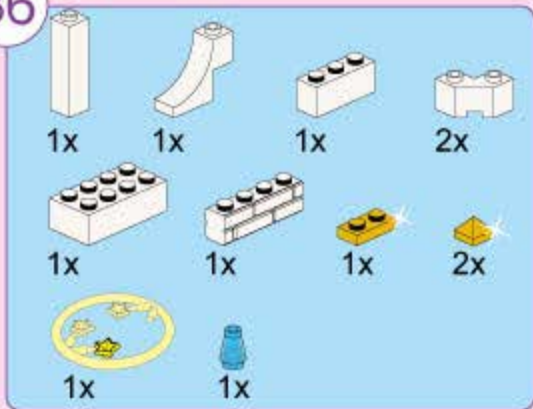

37

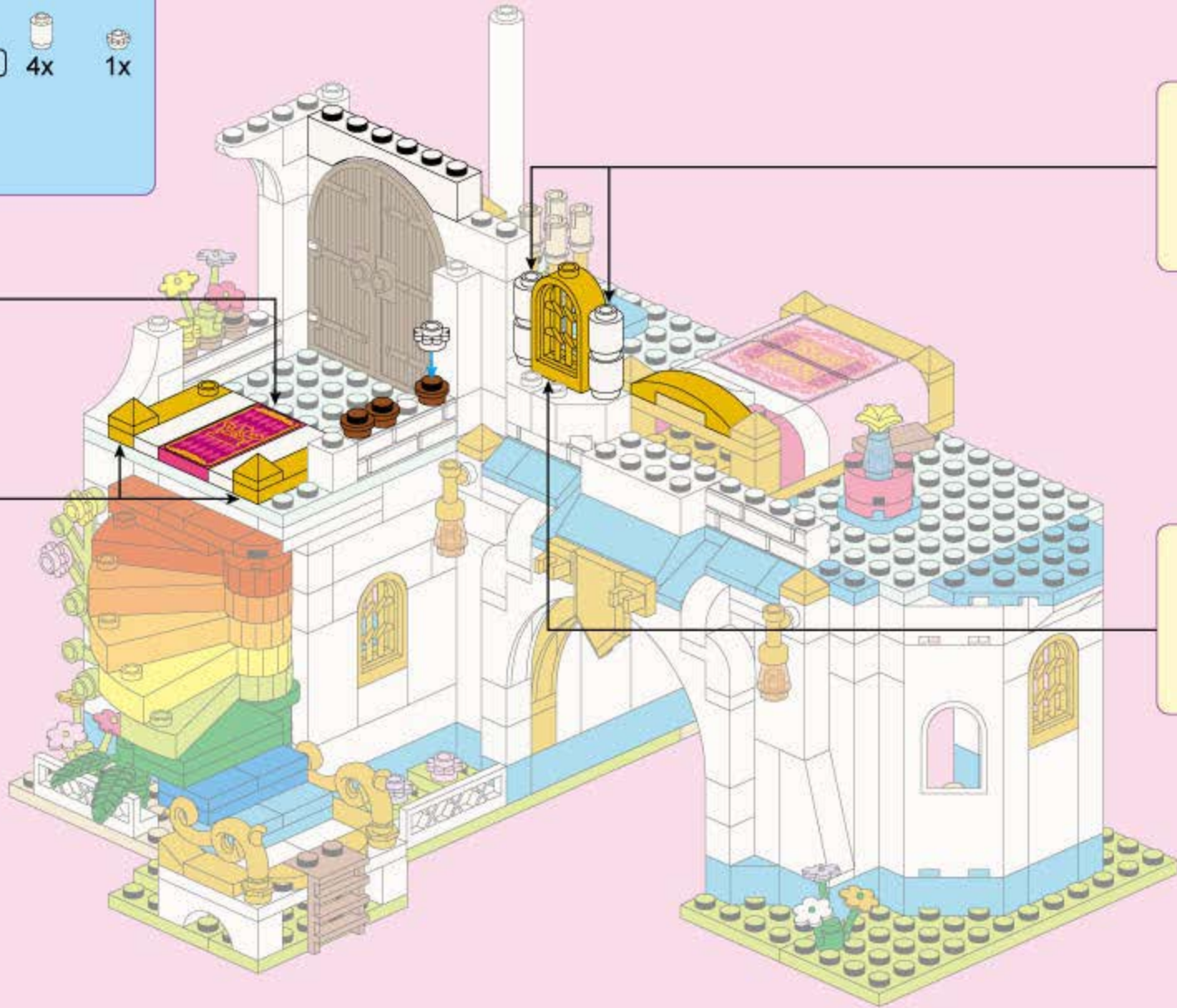
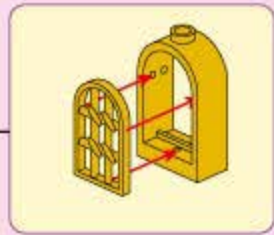
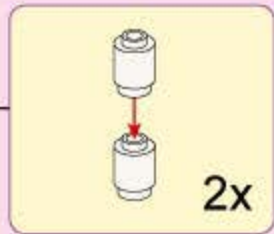
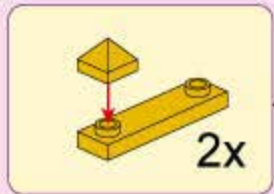
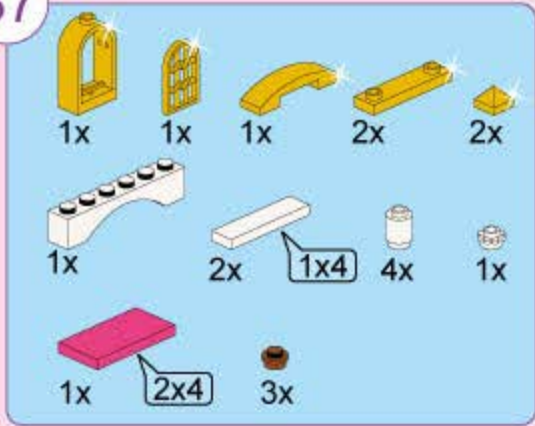

39

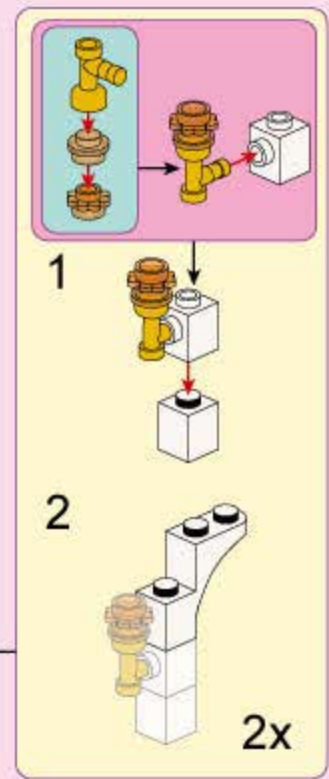
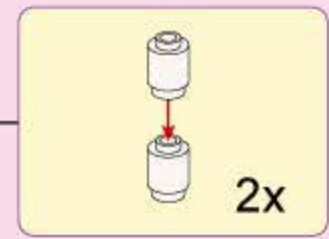
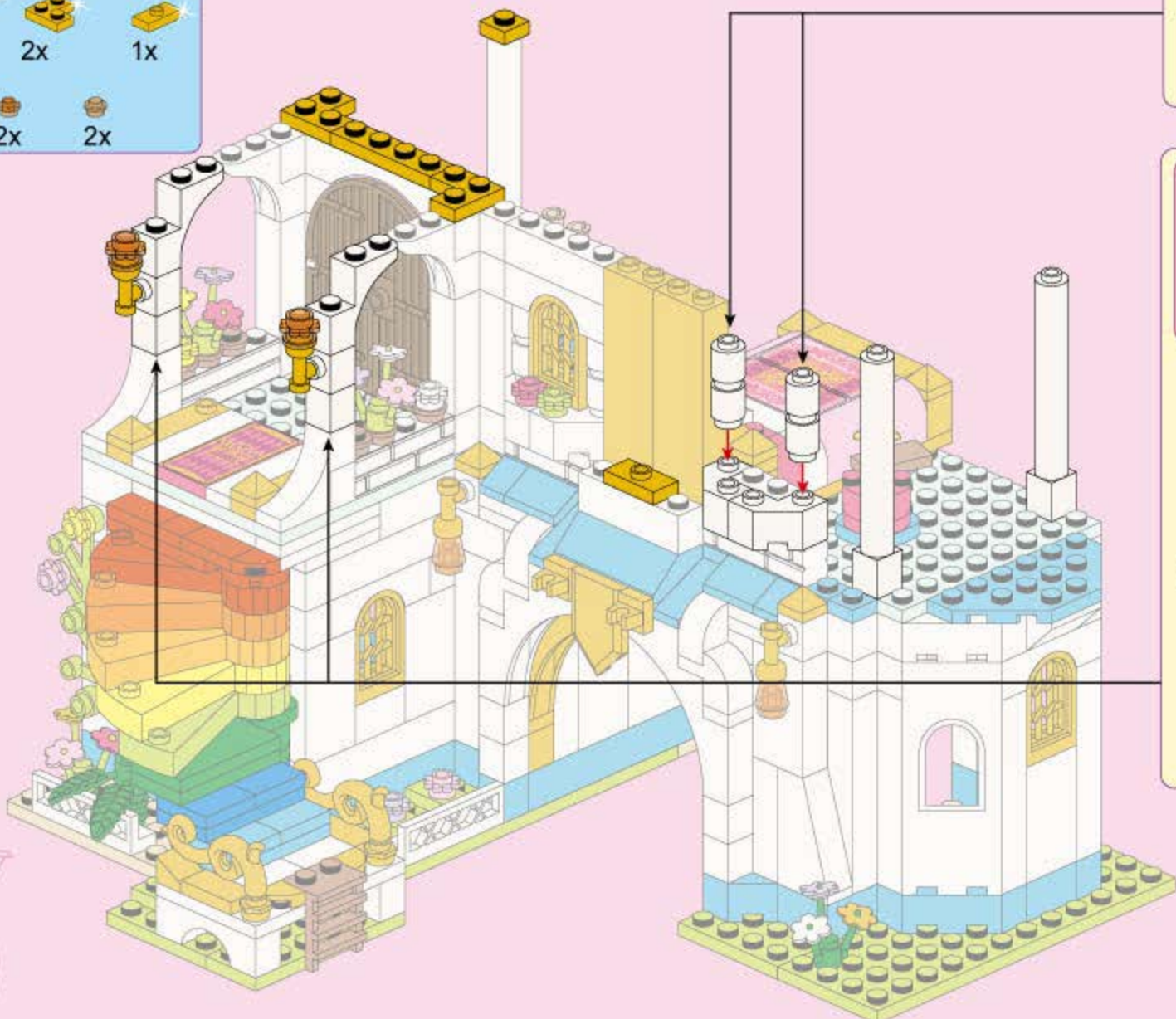
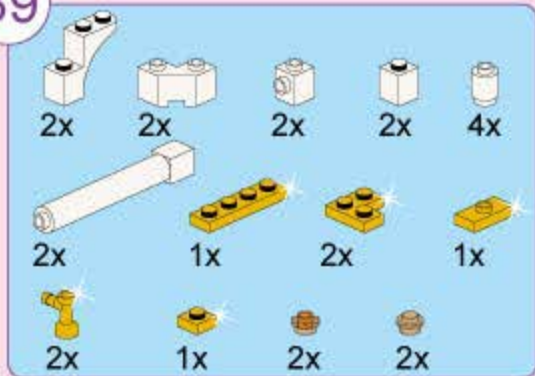

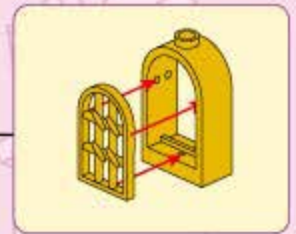
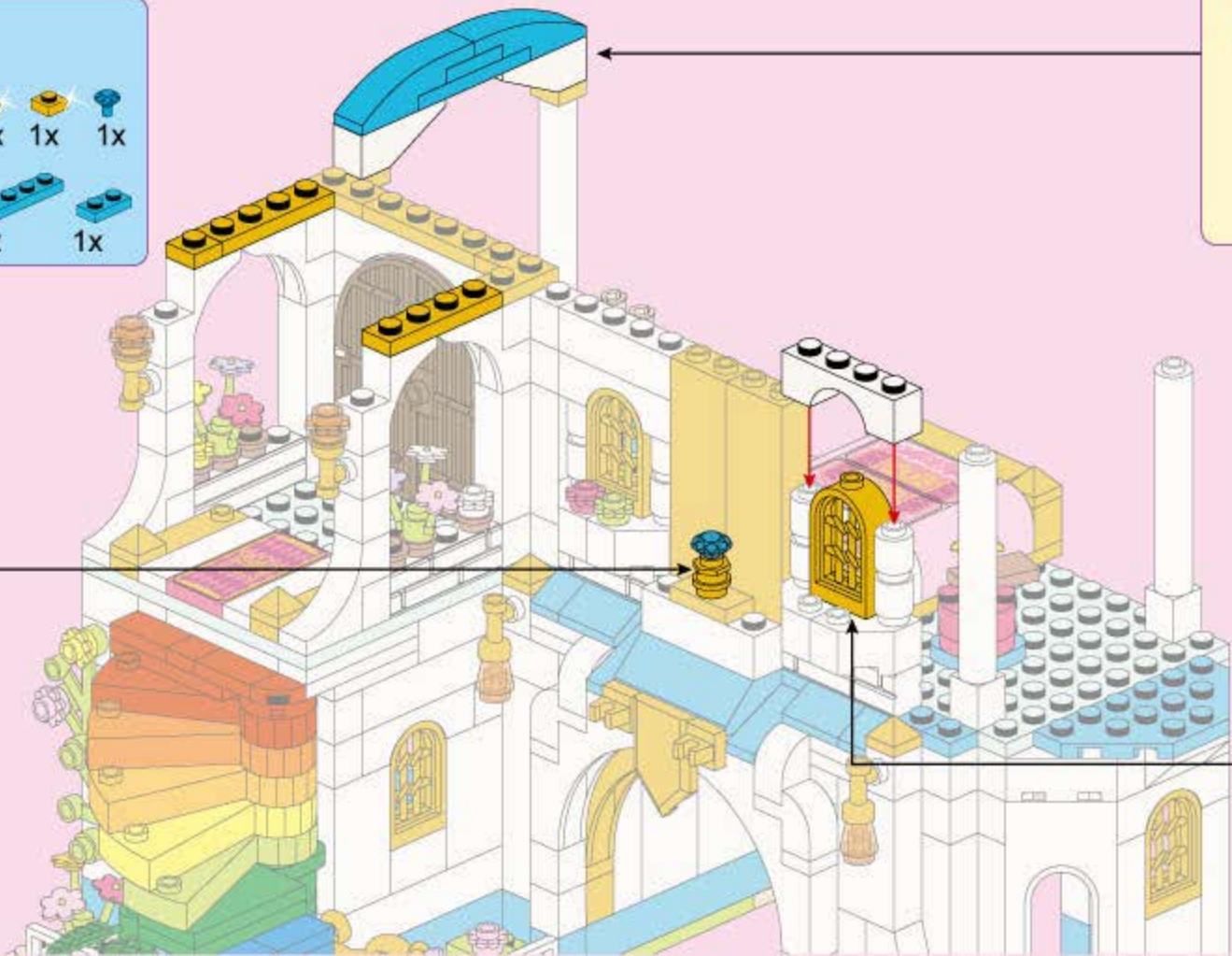
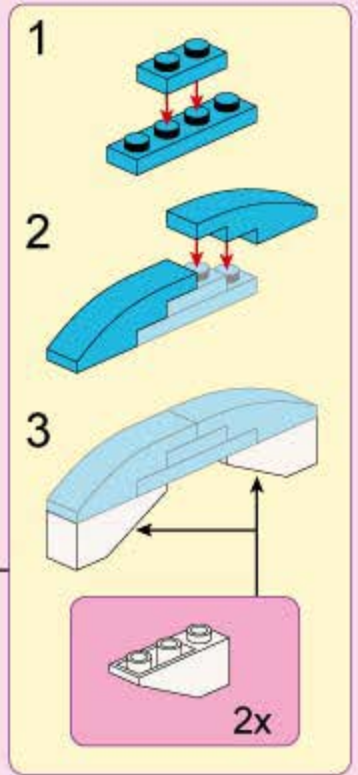
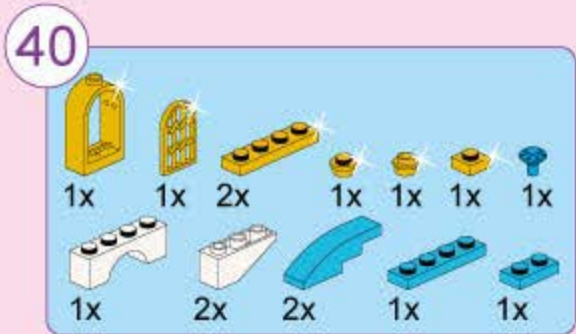
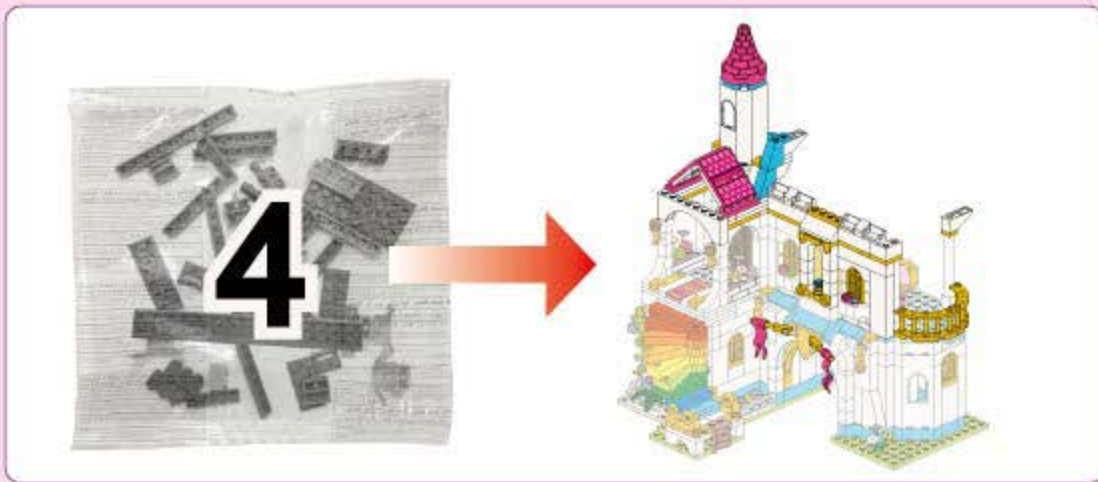

42

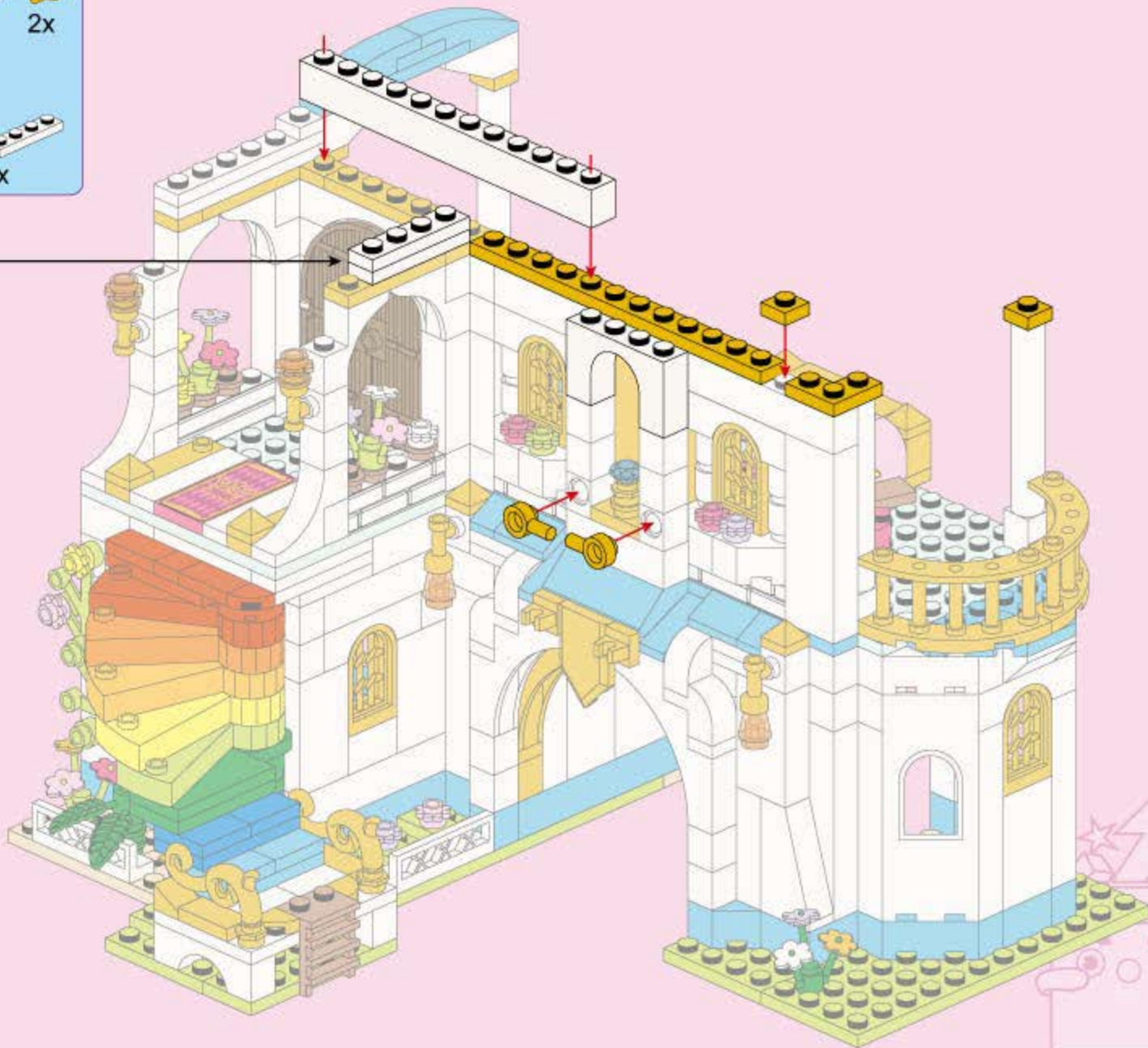
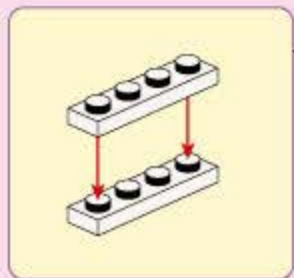
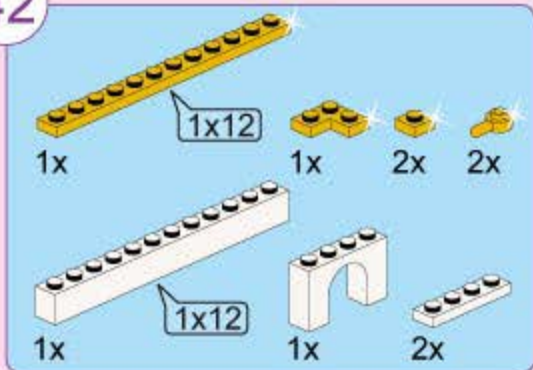

- 1x 1x8
- 1x 1x3
- 1x 1x2
- 1x 1x2
- 1x 1x3
- 1x 1x1
- 1x 1x1
- 2x 1x1
- 1x 1x2
- 1x 1x2
- 2x 1x2

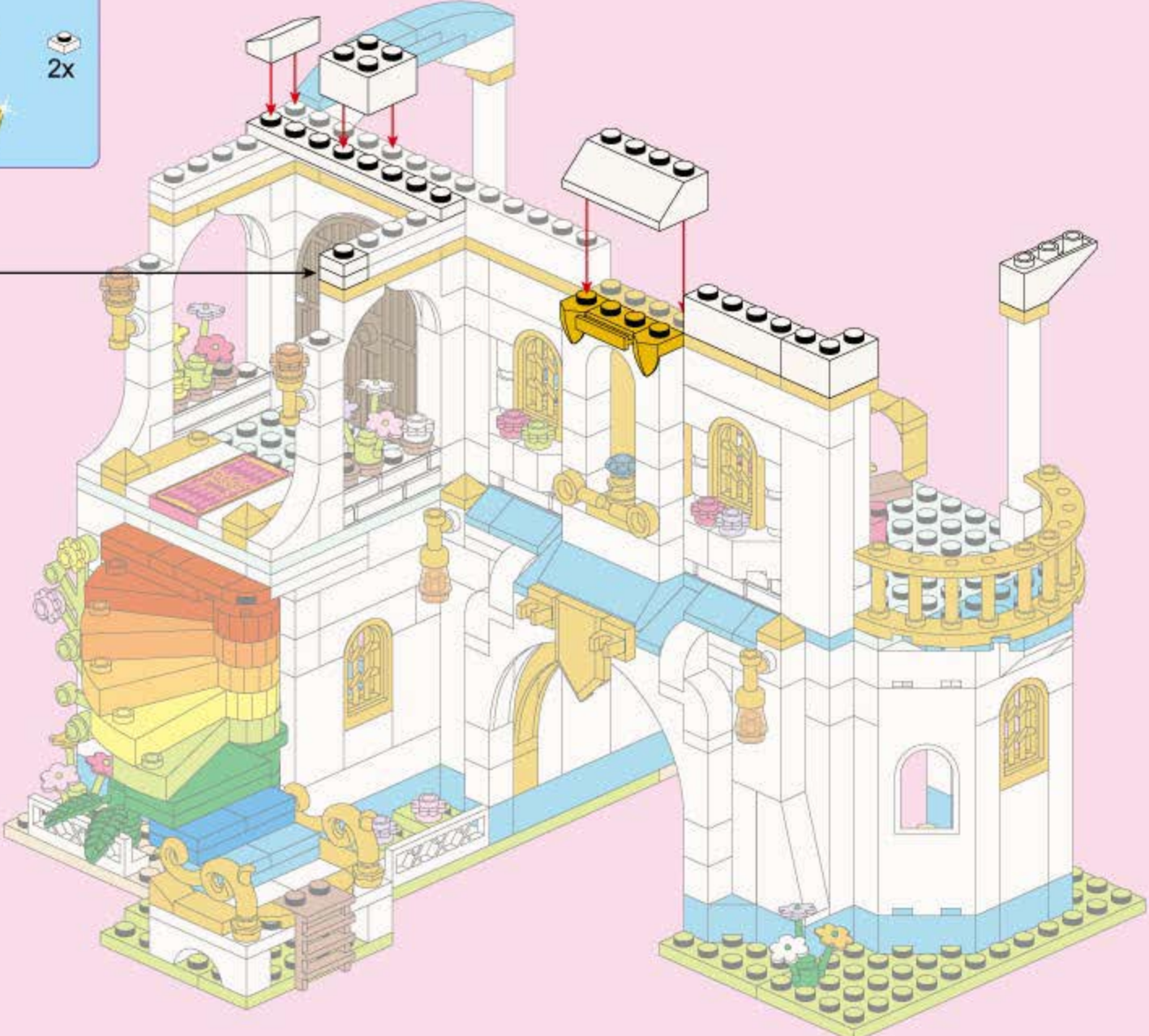
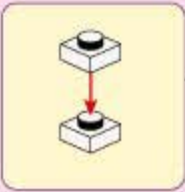

44

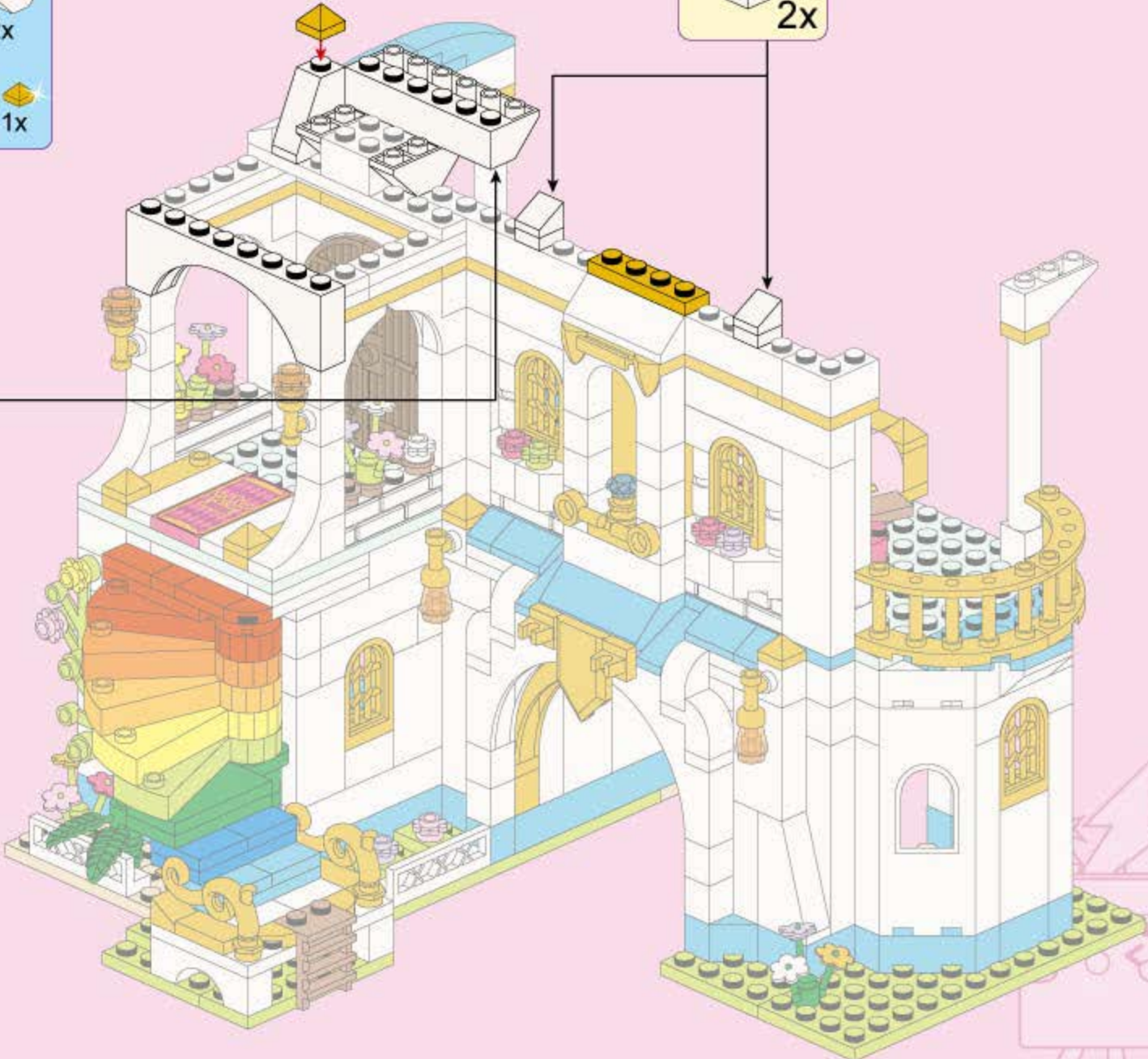
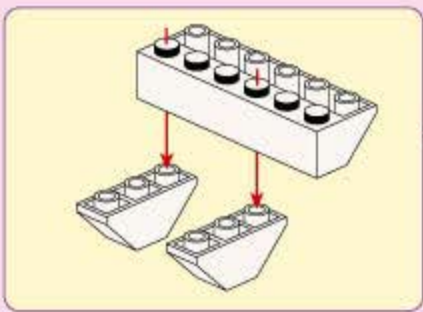
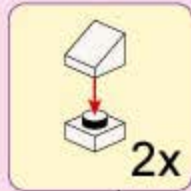
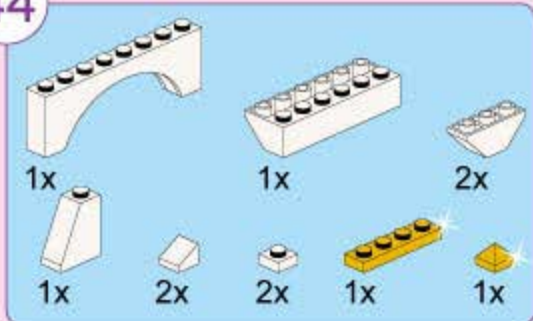

45

- 1x [1x 10-hole white Technic beam]
- 1x [1x 5-hole white Technic beam]
- 4x [1x white Technic axle connector]
- 1x [1x white Technic axle pin]
- 2x [1x white Technic axle pin]
- 2x [2x red Technic axle pins]
- 2x [2x yellow Technic axle pins]
- 2x [2x yellow Technic axle pins]

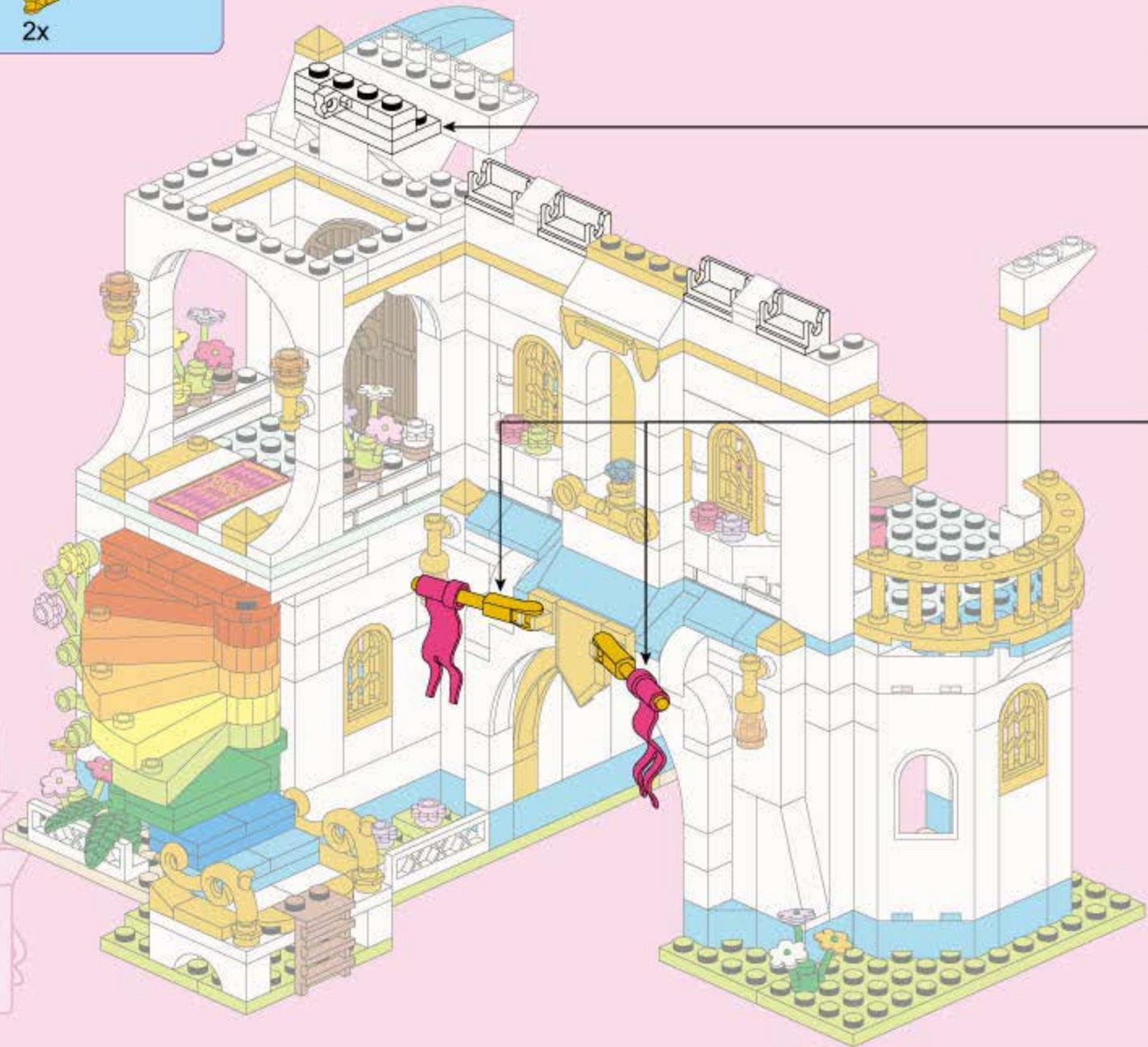
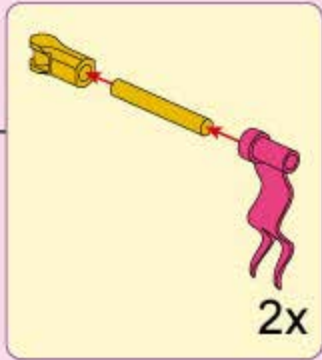
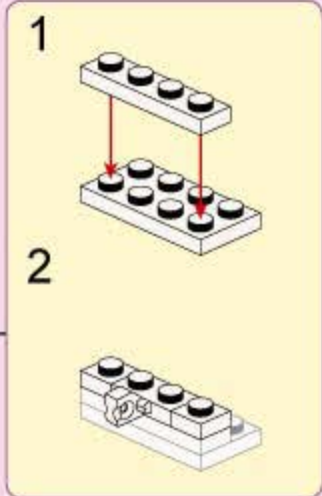

46

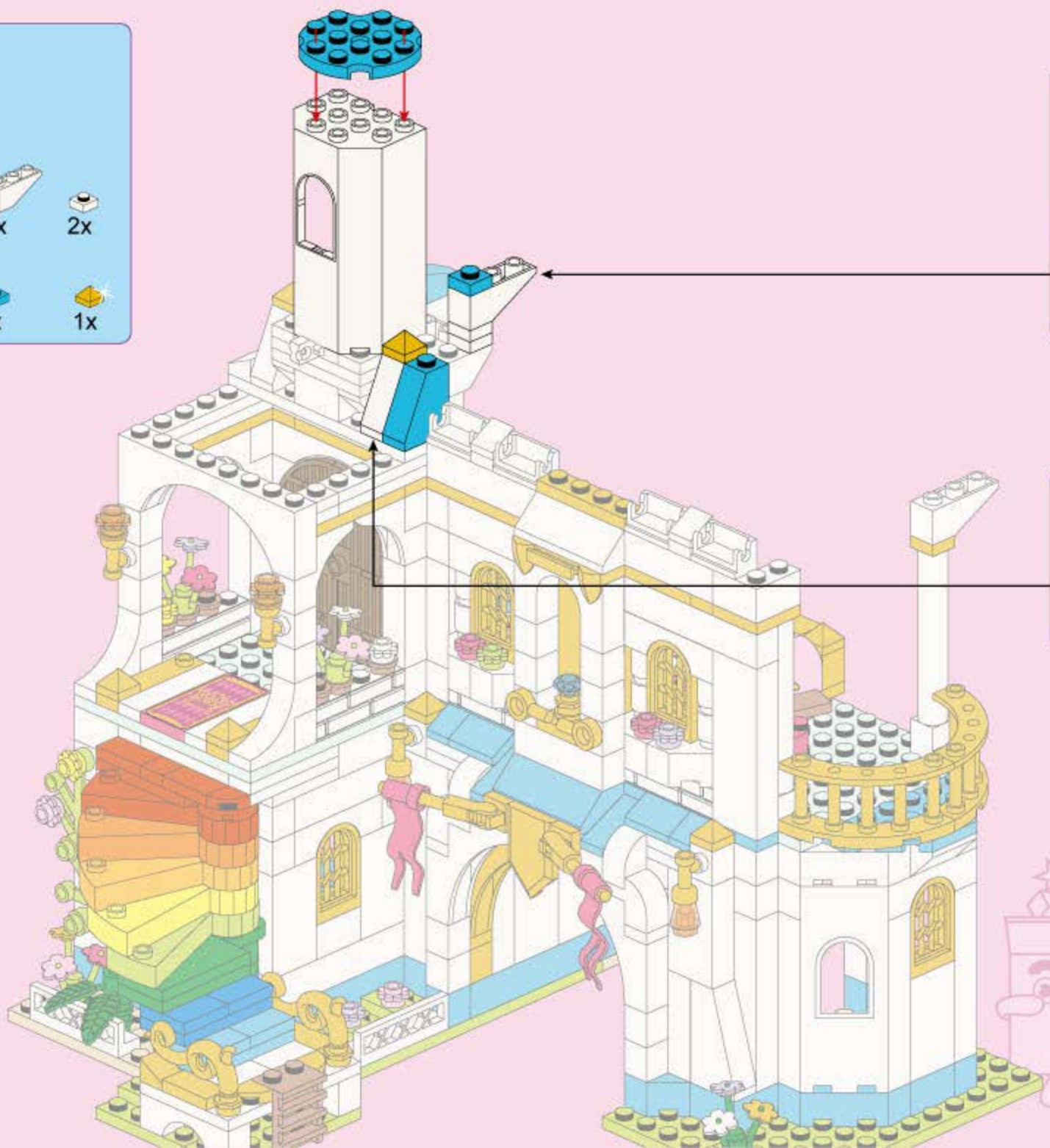
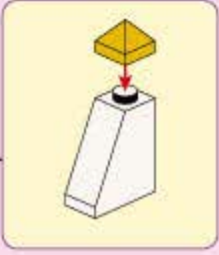
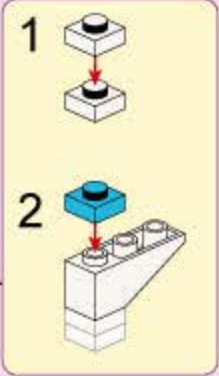
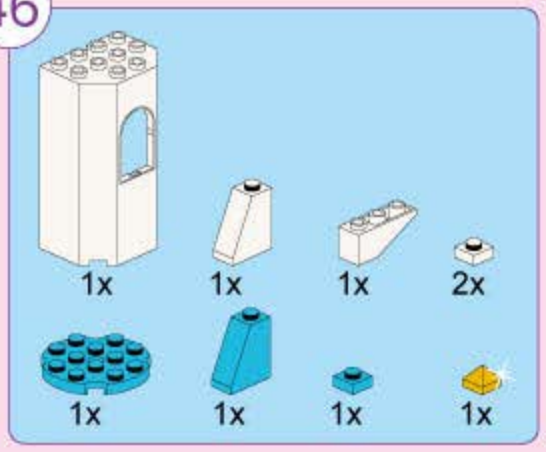

47

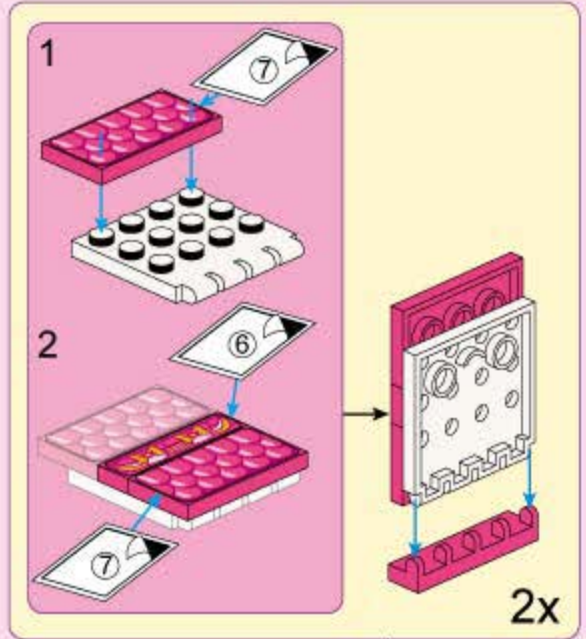
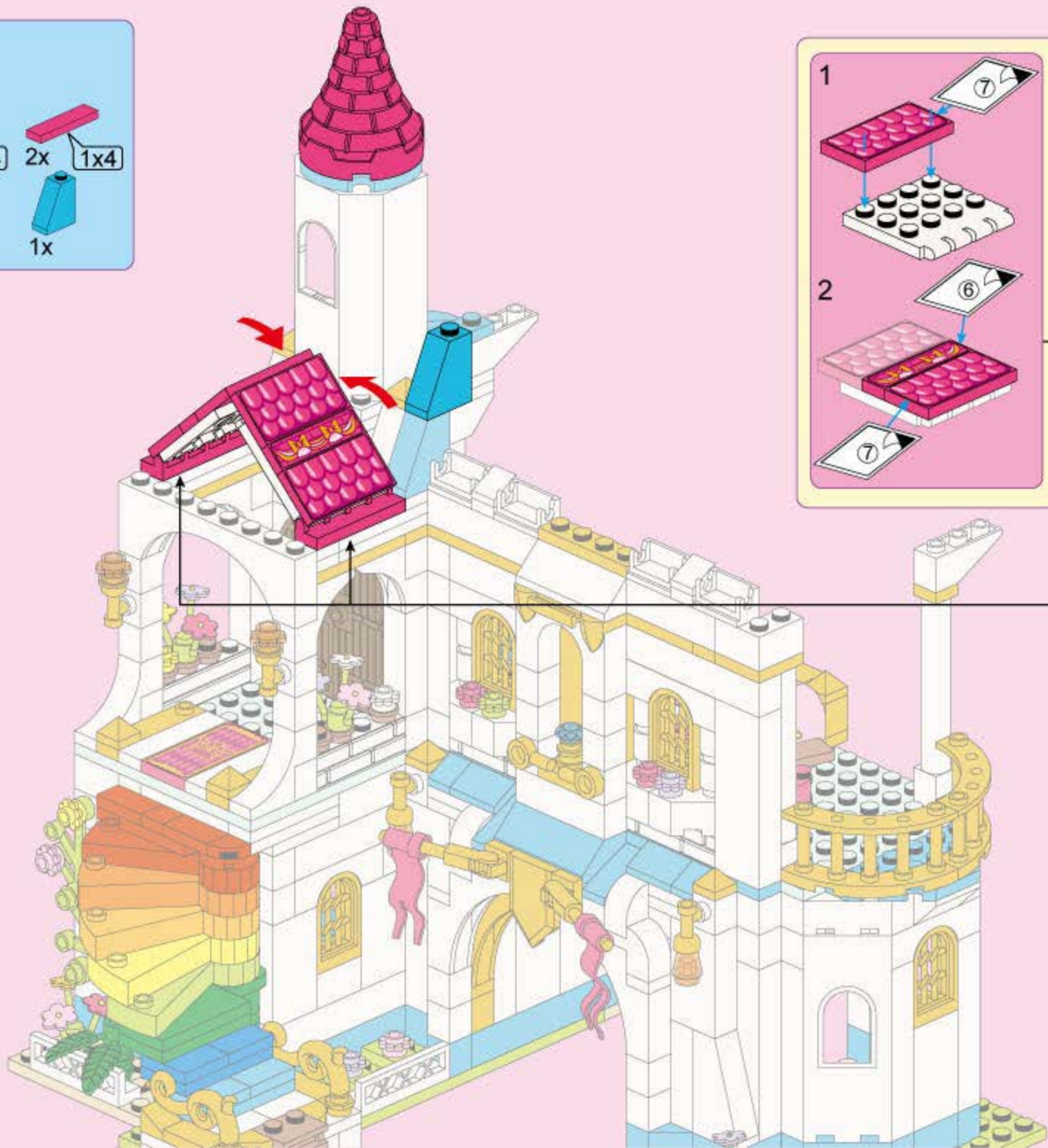
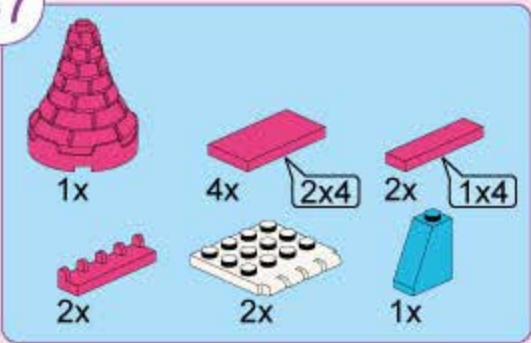

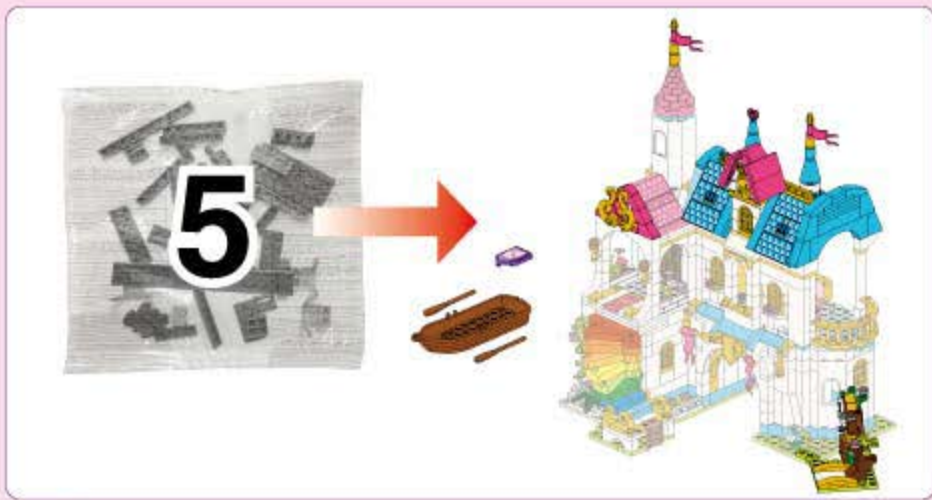

48

- 1x 4x6
- 1x 1x6
- 3x 2x4
- 1x 1x6
- 2x 2x
- 1x 1x6
- 2x 2x
- 2x 2x

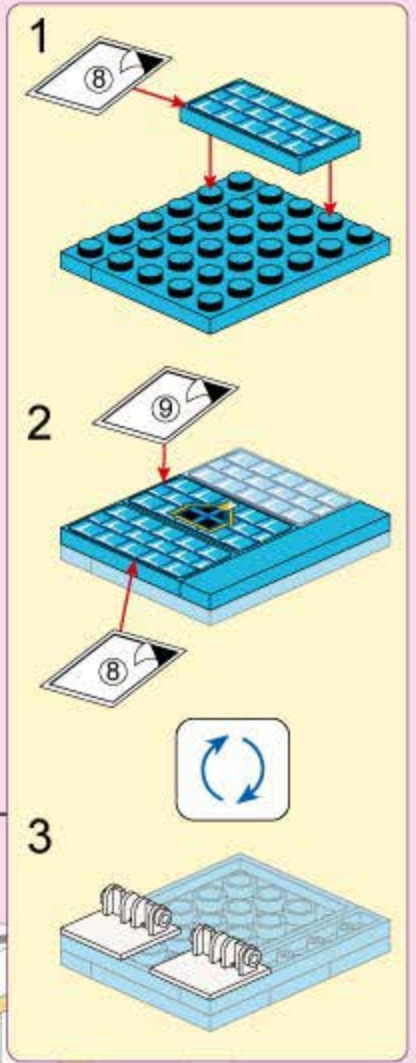
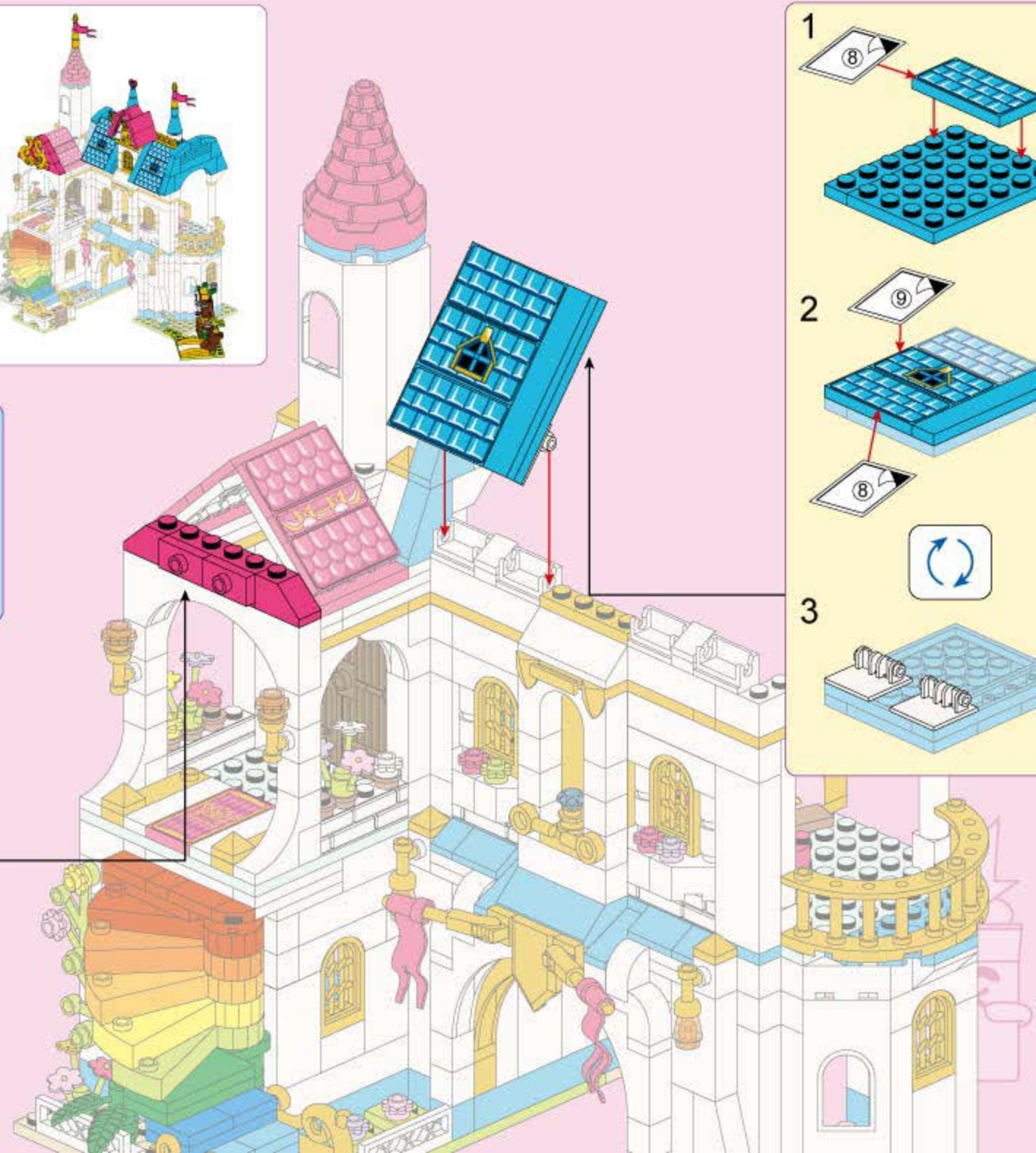
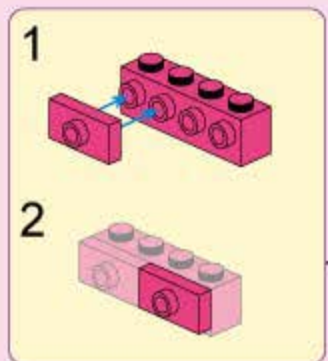

49

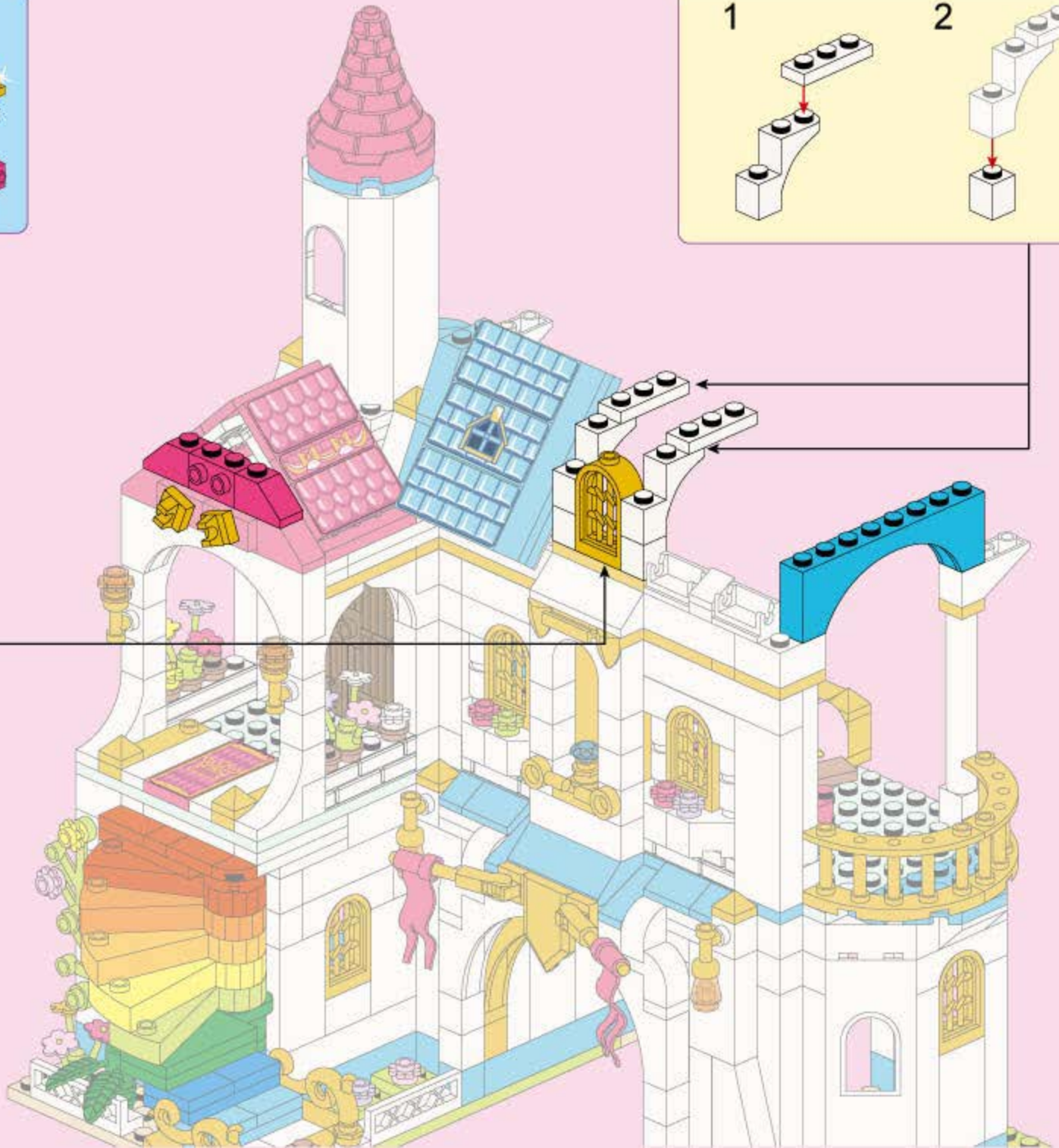
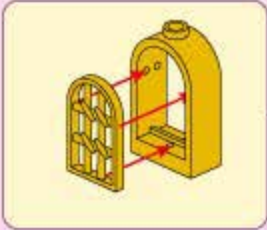
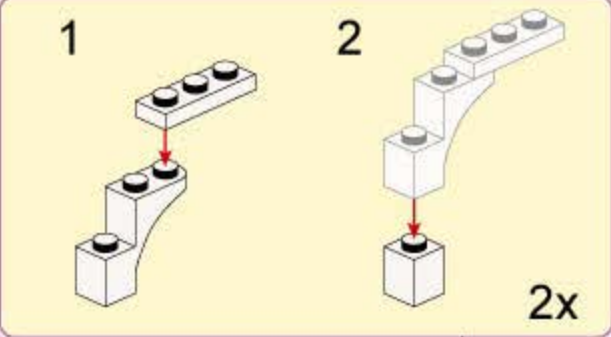
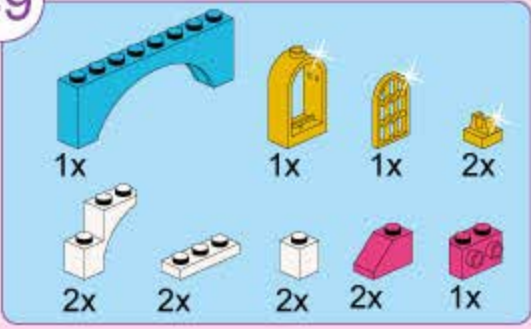

50

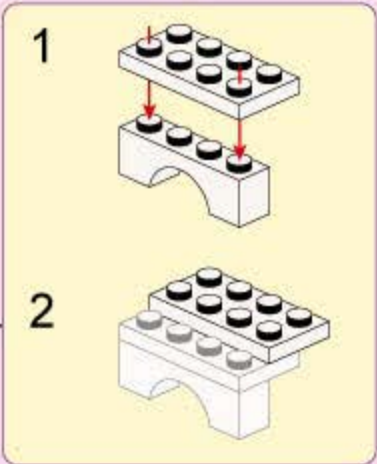
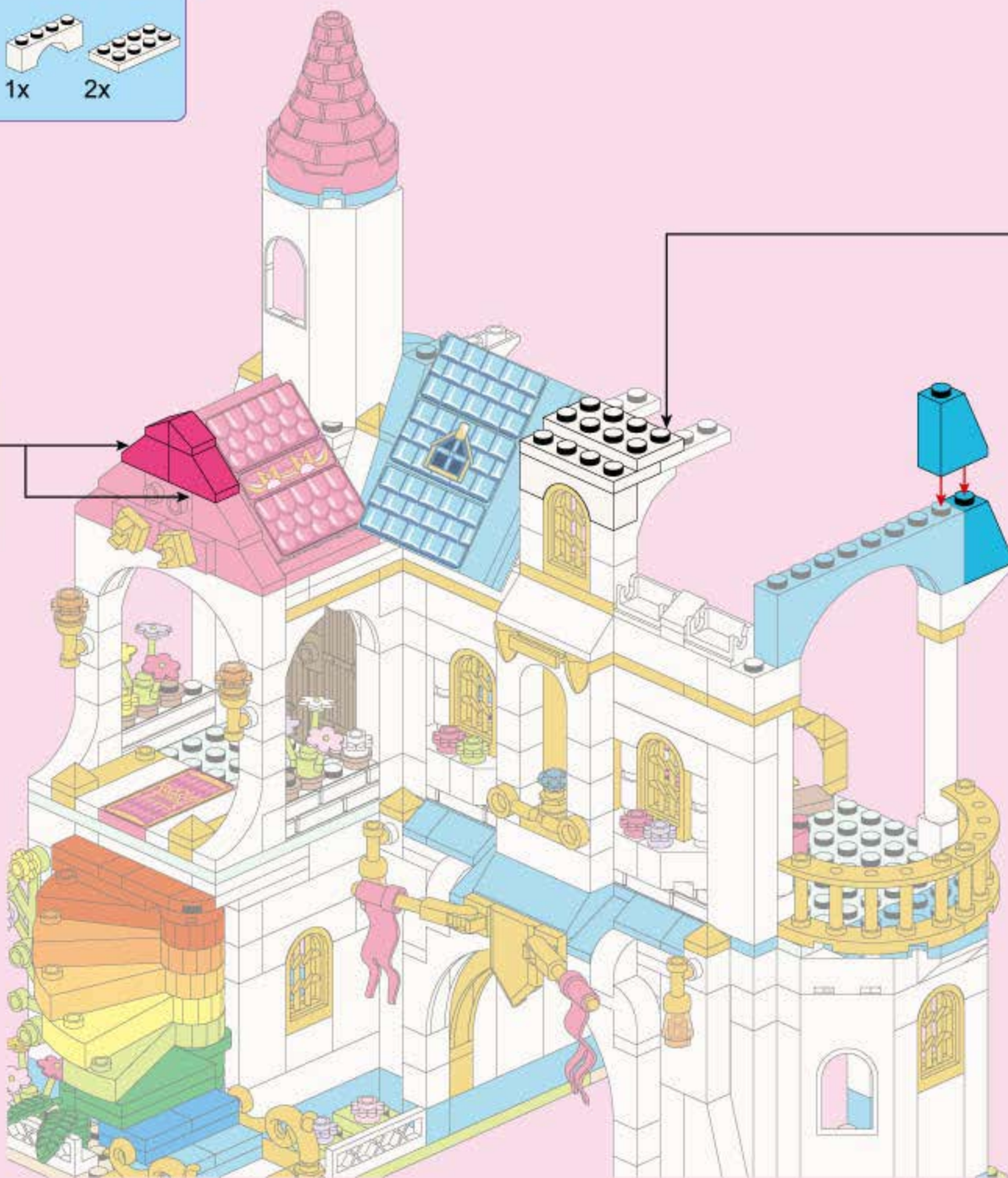
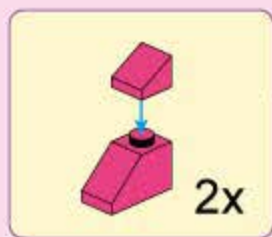

51

1x 4x6
1x 1x
1x 1x
1x 1x6
3x 2x4
2x



1
2
3

1. A white arrow points to a blue 4x6 plate being placed on top of a blue 4x6 plate. A callout box with the number 8 is shown above the top plate.

2. A white arrow points to a blue 4x6 plate being placed on top of the previous assembly. A callout box with the number 9 is shown above the top plate. A second callout box with the number 8 is shown below the top plate, with an arrow pointing to a specific hole.

3. A circular arrow icon indicates a rotation. Below it, a blue 4x6 plate is shown with a white 1x6 plate and a white 2x4 plate being placed on top. A white arrow points to the 1x6 plate.



52

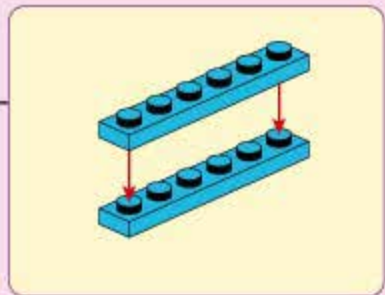
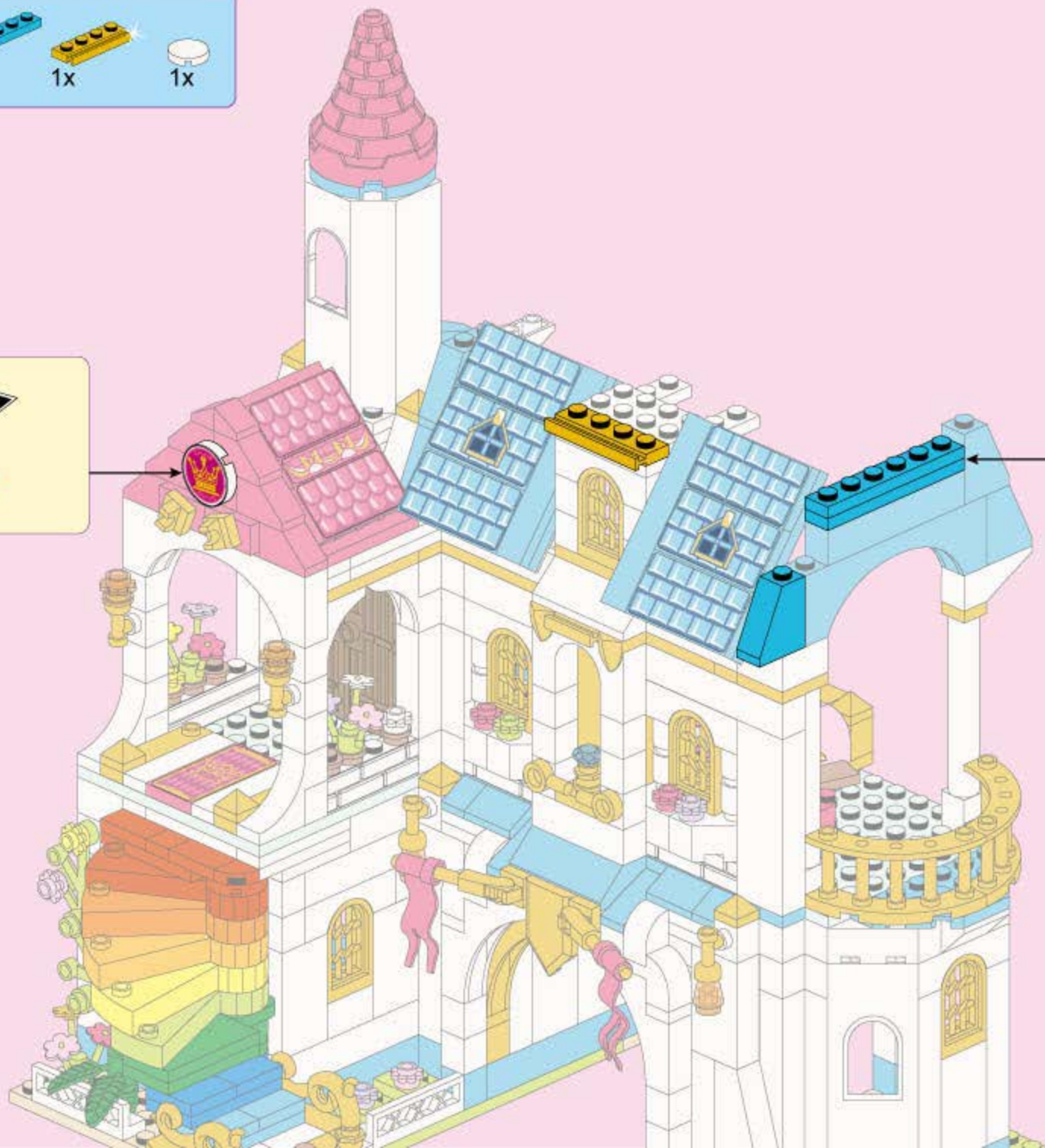
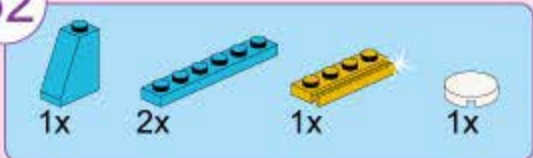

53

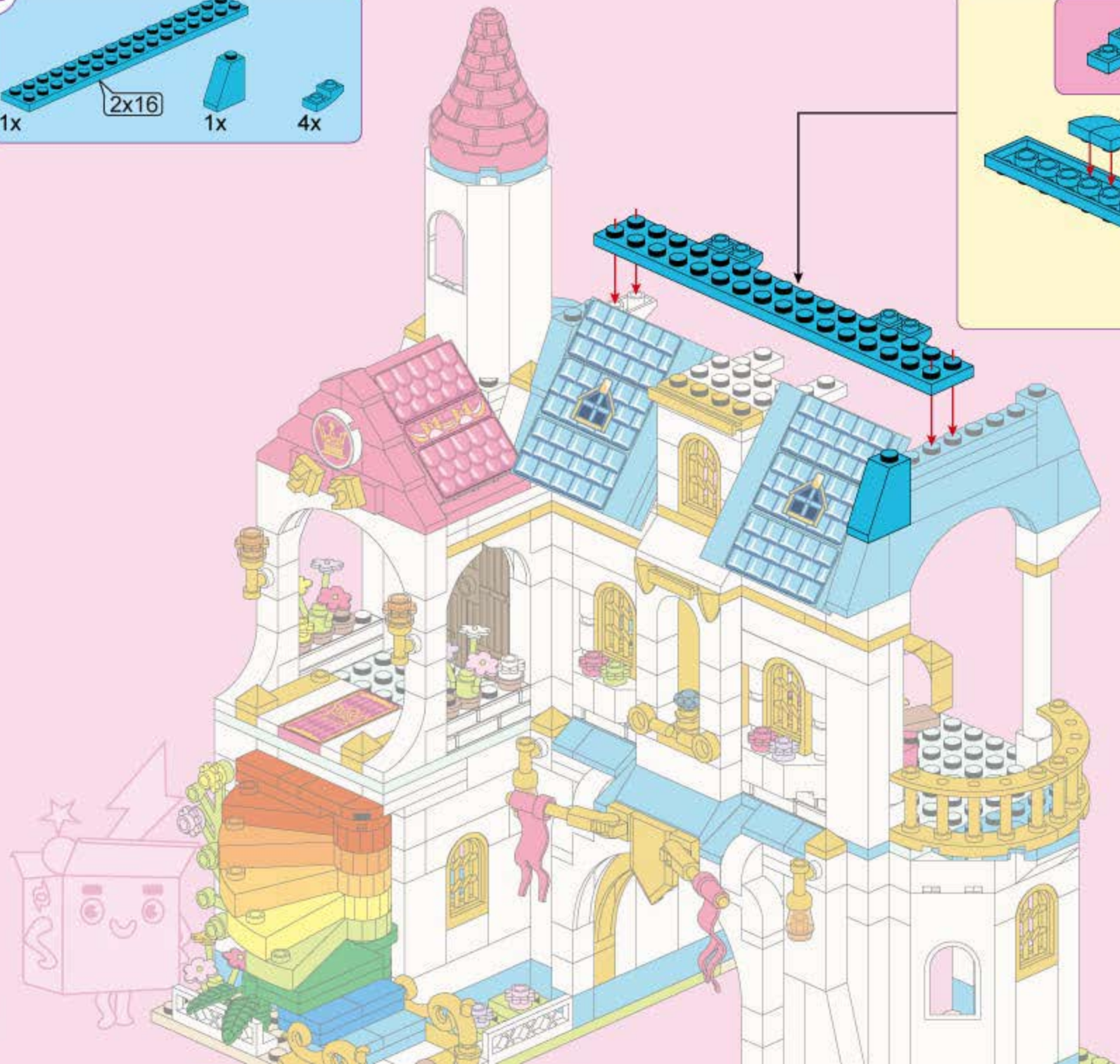
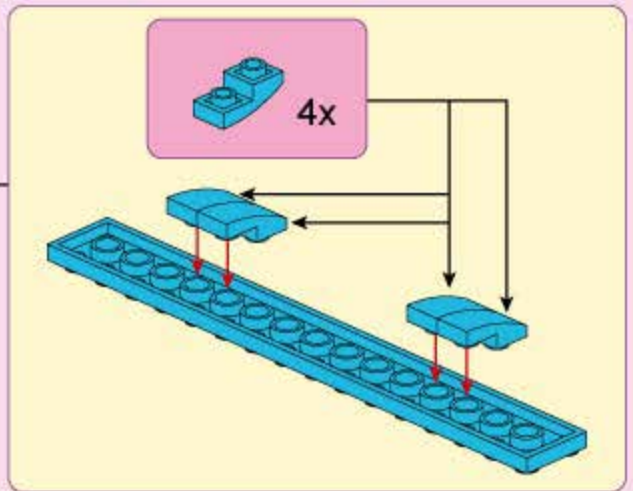
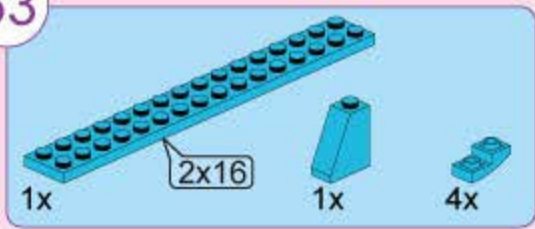

54

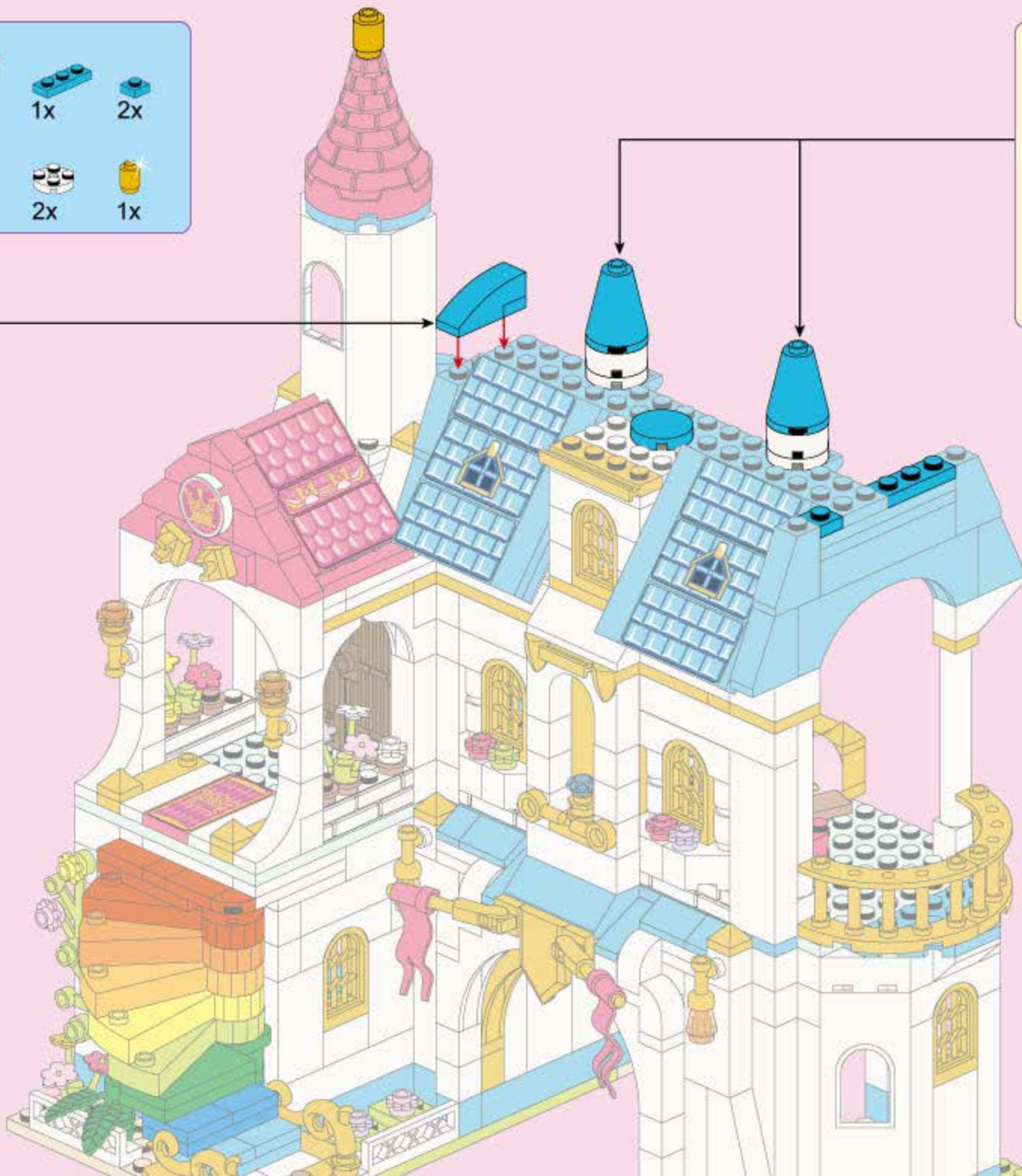
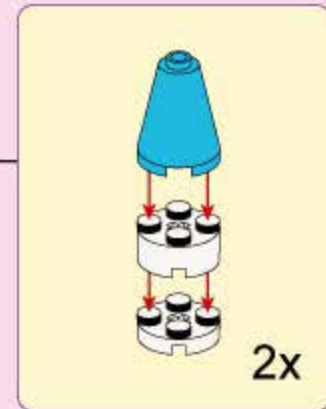
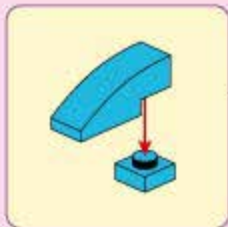
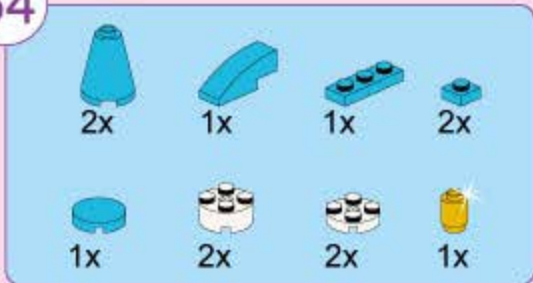

55

- 1x [Blue 1x3 Technic Beam]
- 1x [Blue 1x2 Technic Beam]
- 1x [Blue 1x2 Technic Brick]
- 1x [Blue 1x2 Technic Brick]
- 2x [Blue 1x2 Technic Pin]
- 2x [Yellow 1x3 Technic Beam]
- 2x [Yellow 1x2 Technic Pin]
- 1x [Red Heart]
- 2x [White 1x2 Technic Brick]

1:1

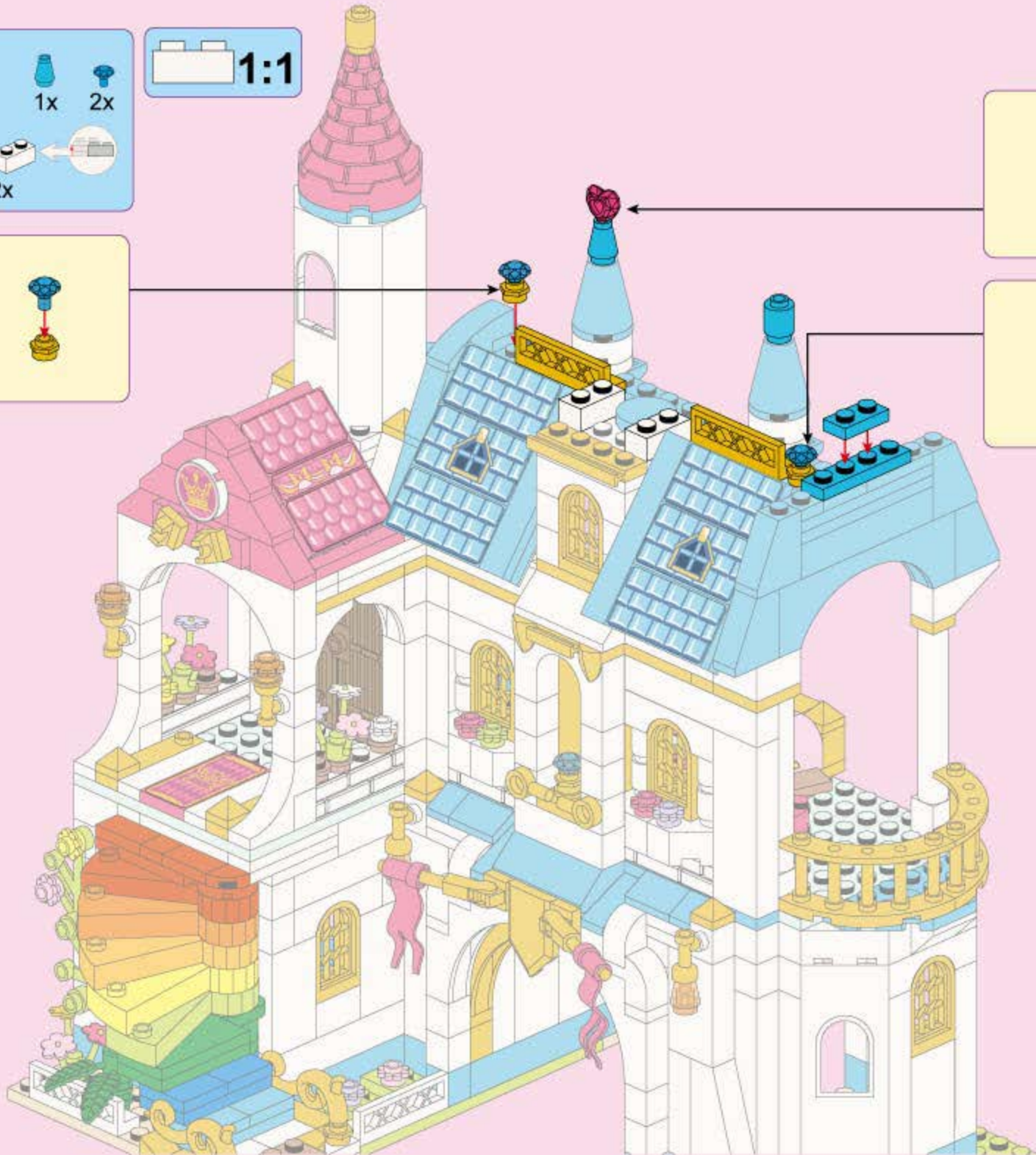

56

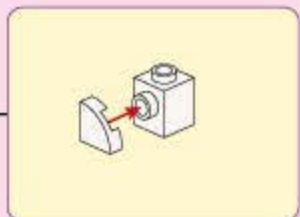
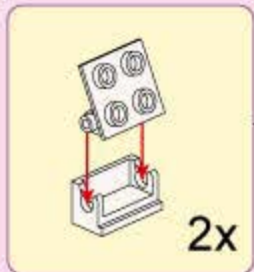
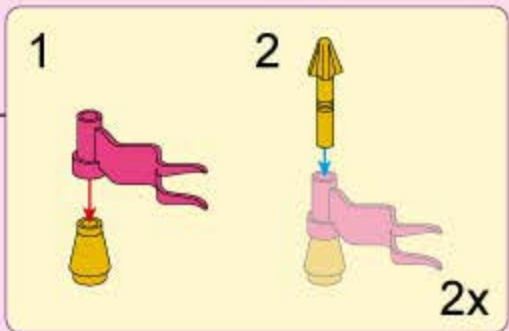

57

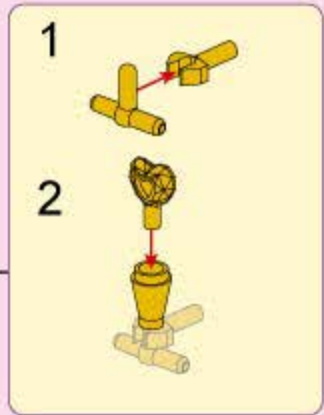

58

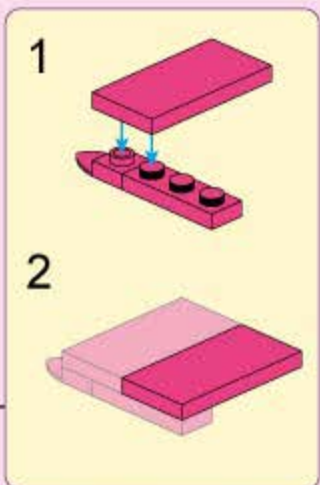
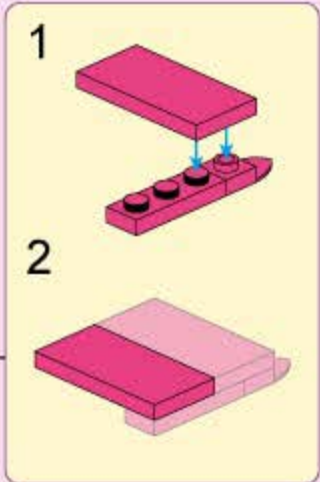
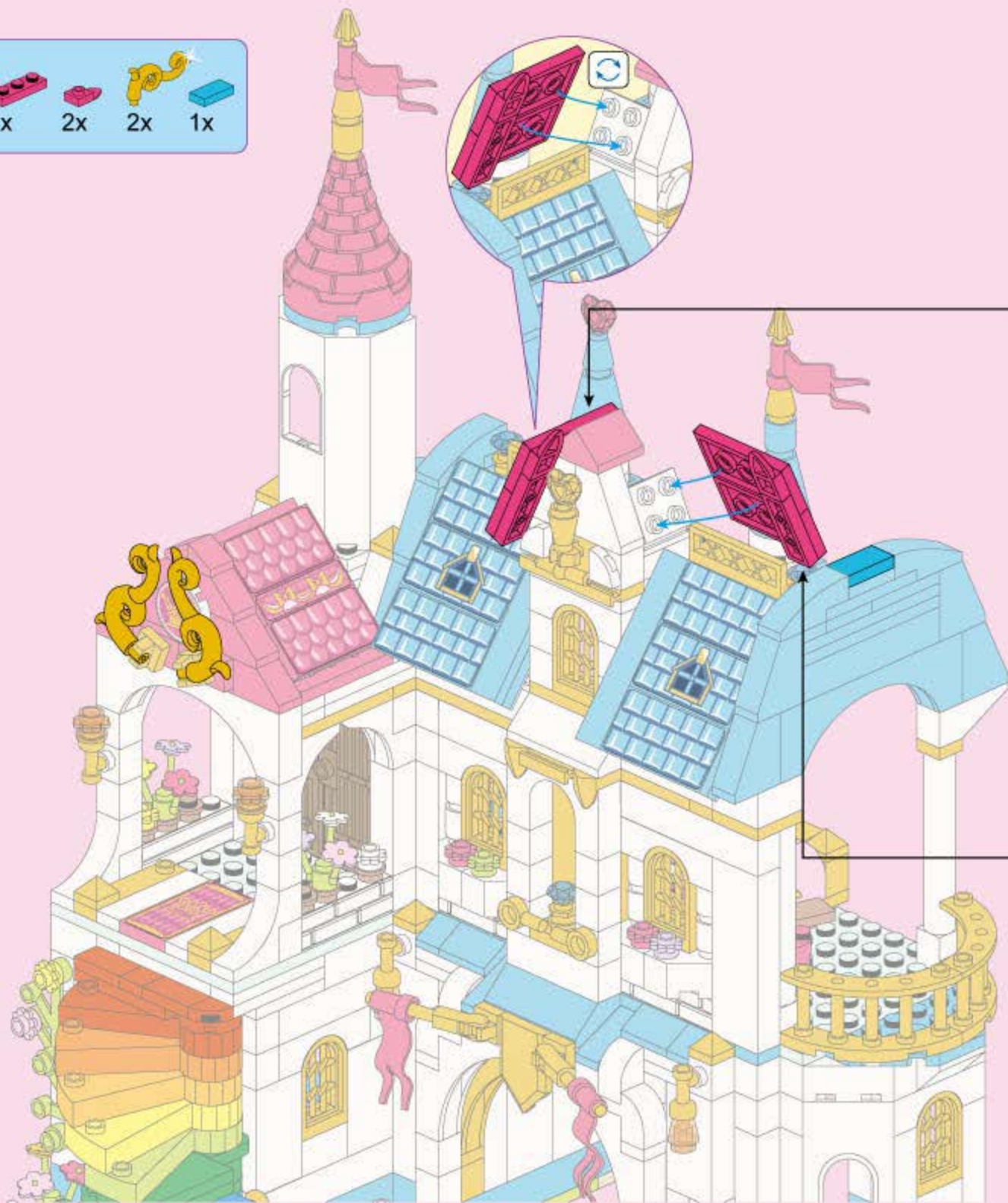
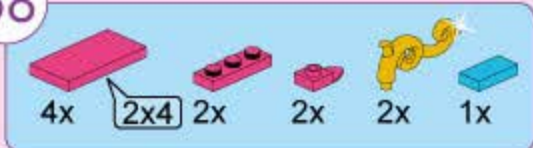



59

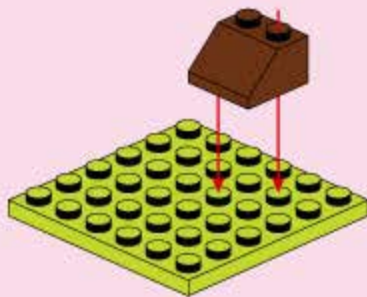
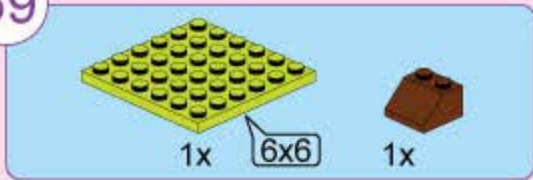

60

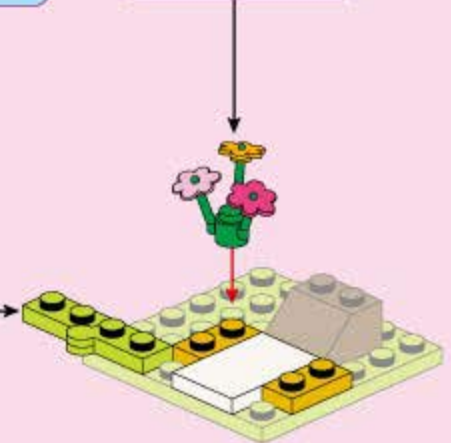
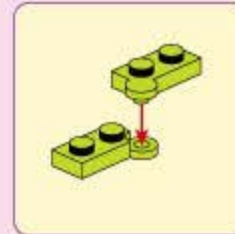
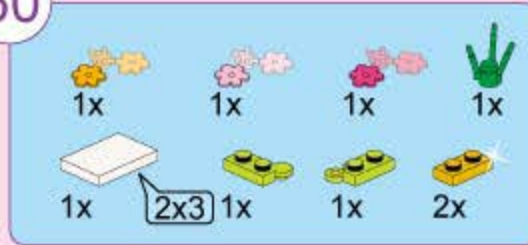

61

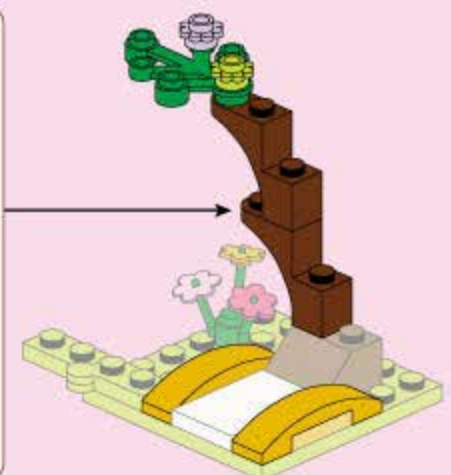
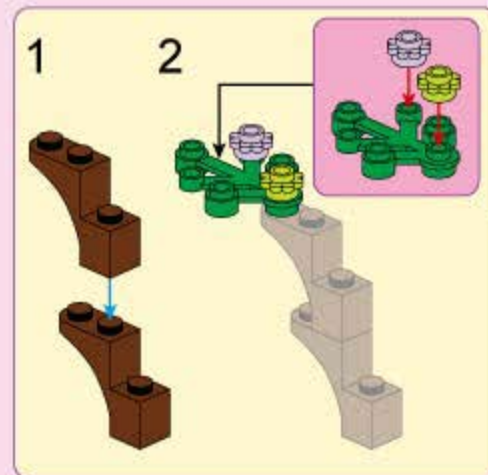
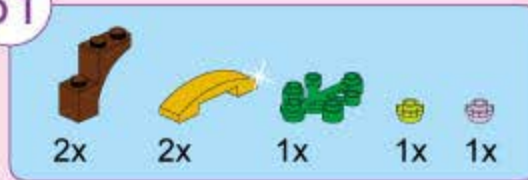

62



2x



63



1x



1x



64



1x



65



1x



1x



1x

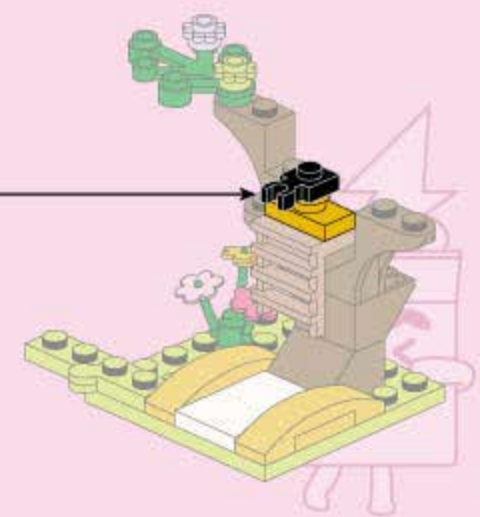

66

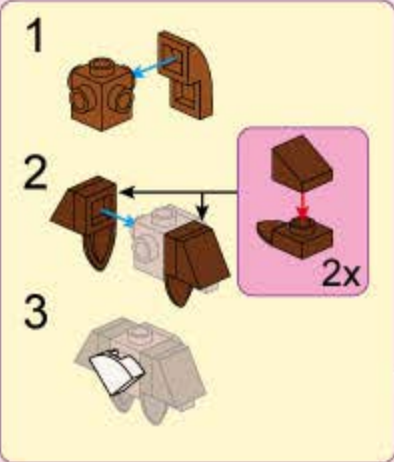

67

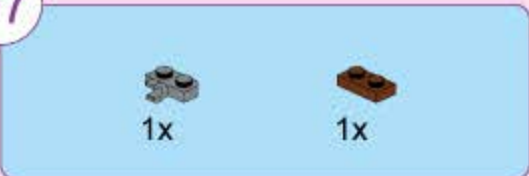

68

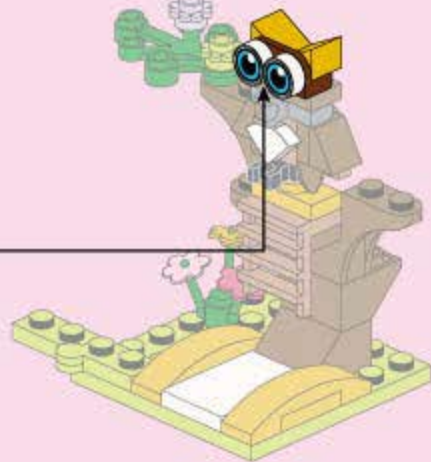
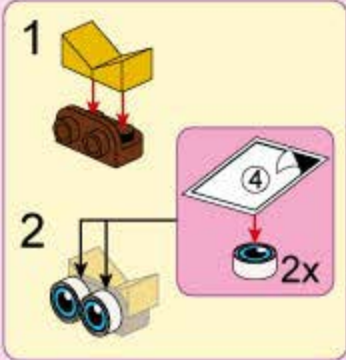

69

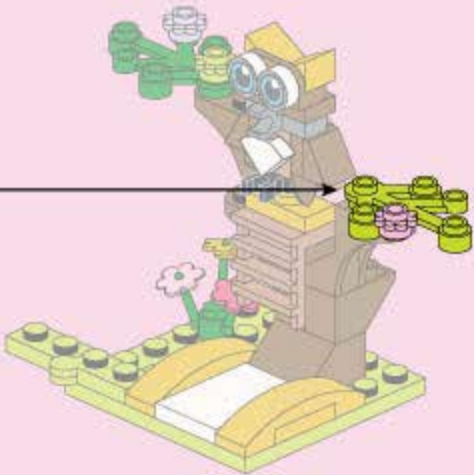

70

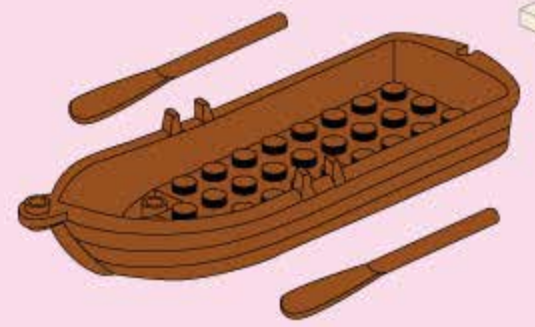
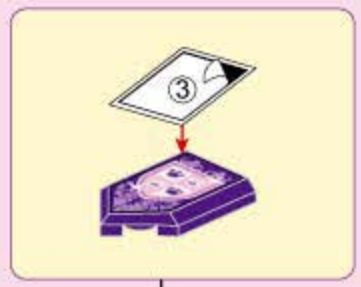
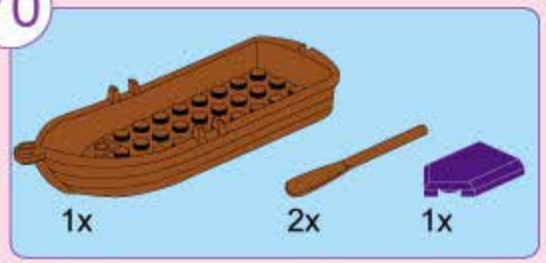



Princess Leah

32014



32011-1
Rainbow Fountain



32011-2
Royal Swing



32011-3
Rainbow Throne



32011-4
Coloured Glaze Pavilion



32012
Princess Cynya's Room



32013
Secret Garden Box



32014
Lake Rainbow Castle



32015
Flower Castle Ball