

Keepplay

国玩系列



故宫宫廷文化



正版授权
K10120 祥瑞麒麟



麒麟是中国传统瑞兽，古人认为麒麟出没处，必有祥瑞。

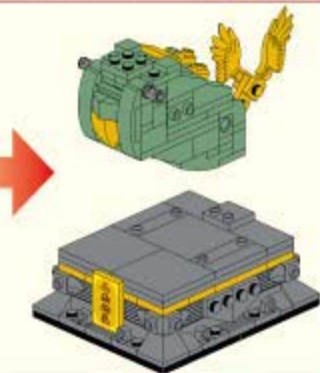

拆件器使用方法, 仅为示例

Usage of Brick Separator, Just for the sample

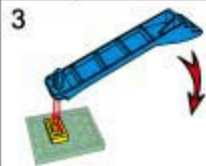
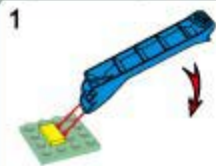

1

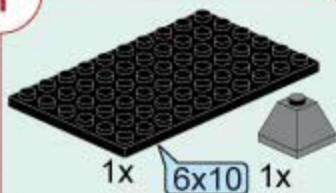

1x

6x10

1x

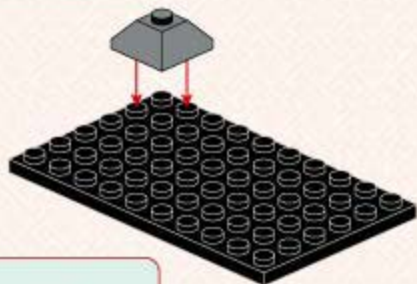

2



2x

1x

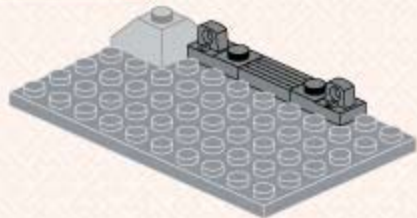

6

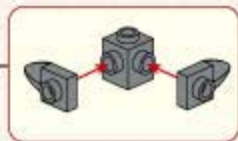
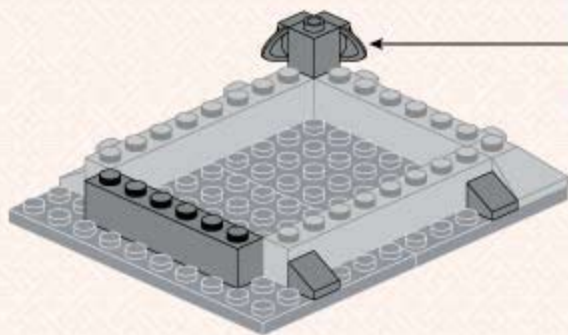
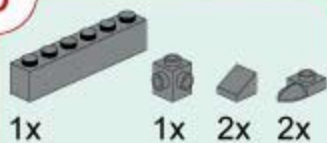

7

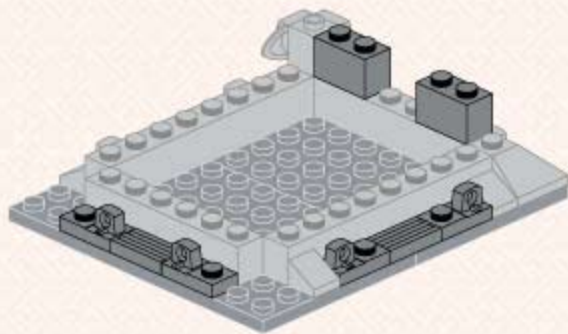

8

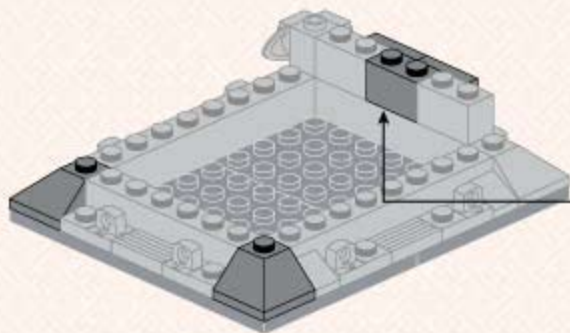
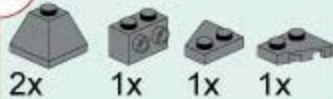

1

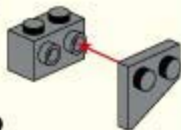

2



9

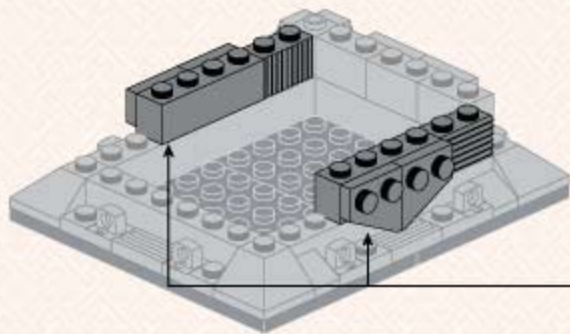
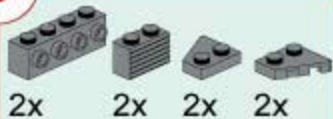

1

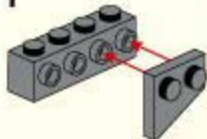

2



2x

10



4x



1x

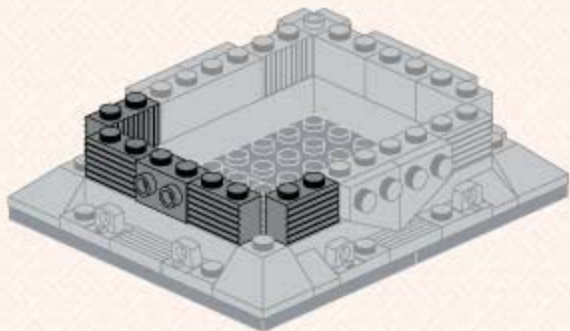

11



3x



6x

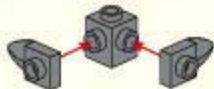
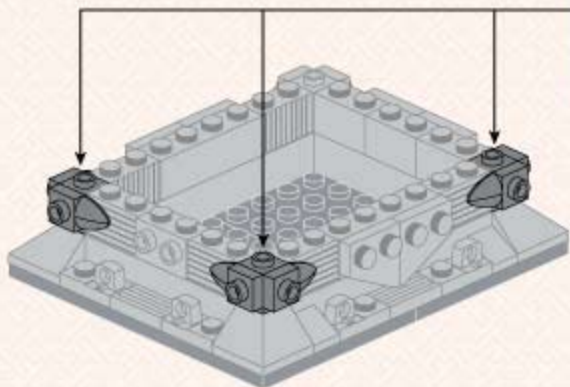

3x

12



4x



2x

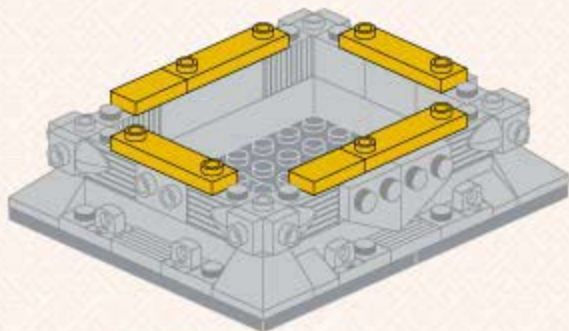

13



1x

2x3



1x

2x3



4x

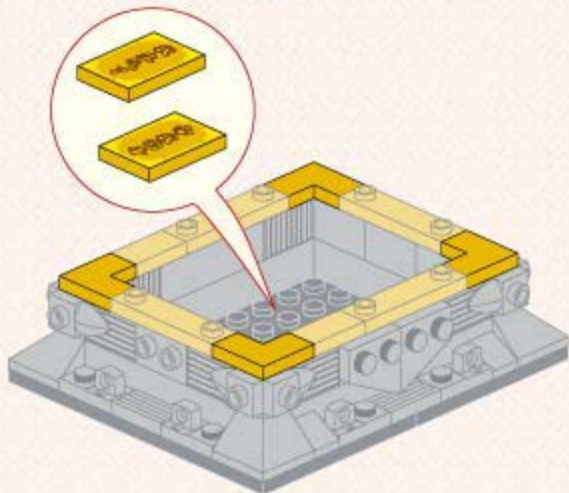

14

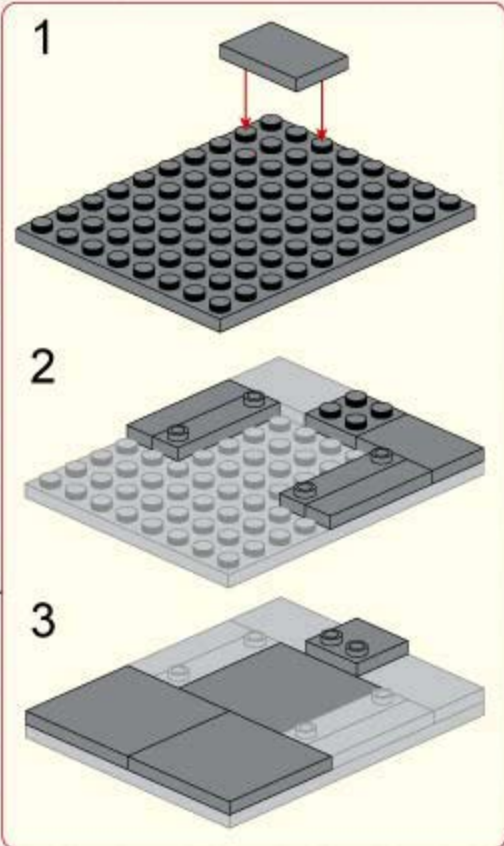
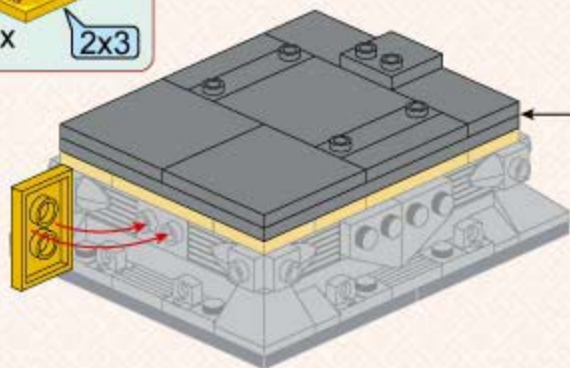
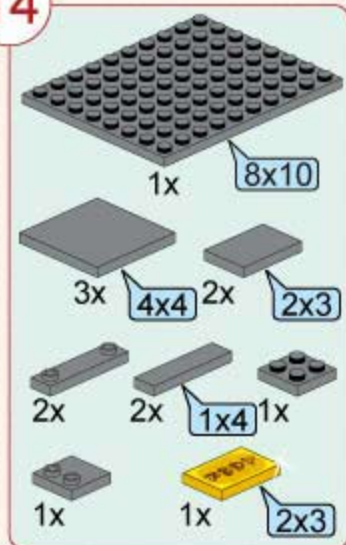



15

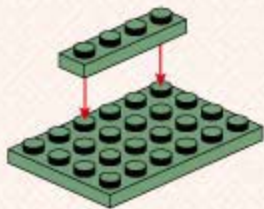

16

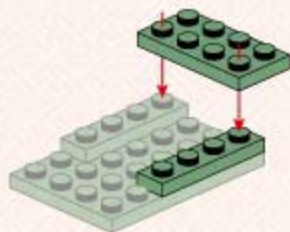
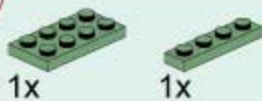

17

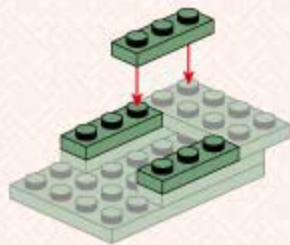

18



19

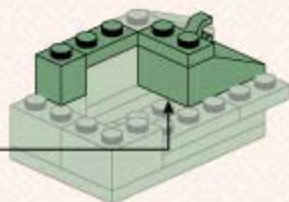
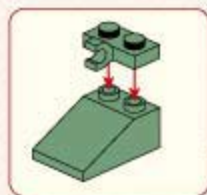
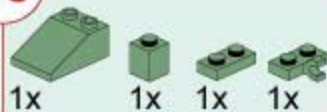

20

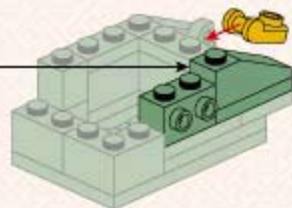
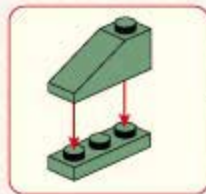
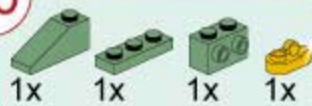

21



22

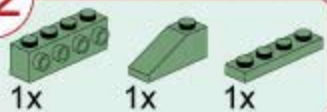

23

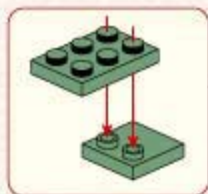

24

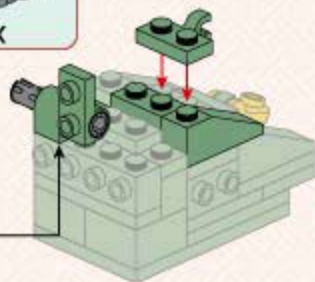
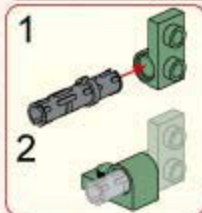
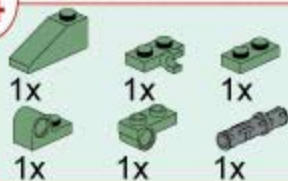

25

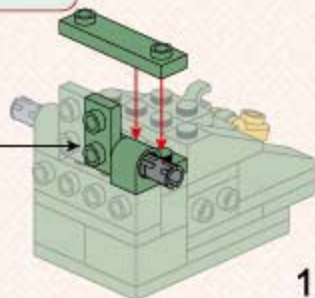
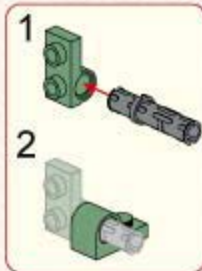

26



1x



1x



27



2x



1x



2x

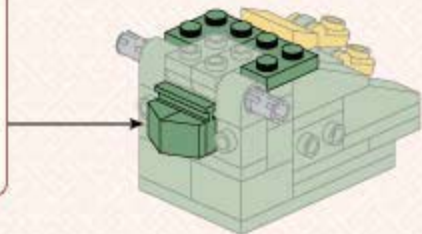
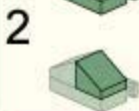

28



1x



1x



2x



1x

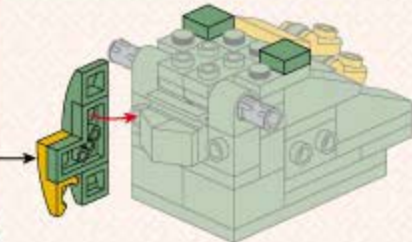
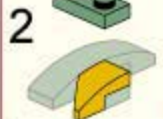

29



1x



1x



1x



1x

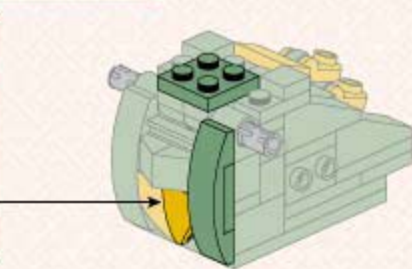
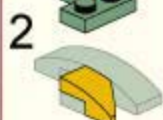

30

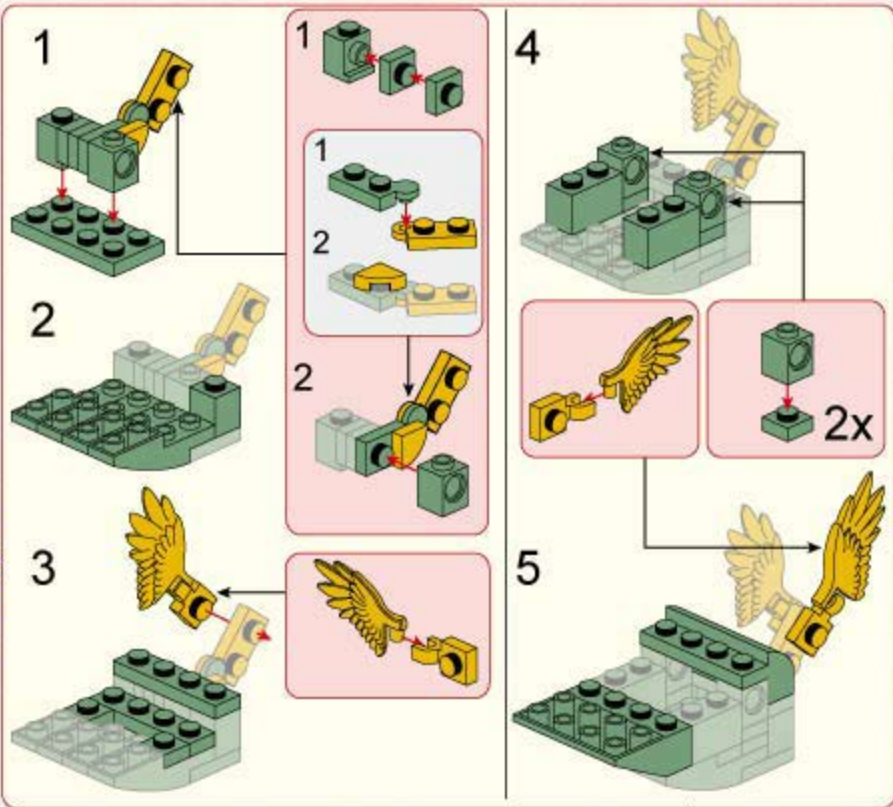
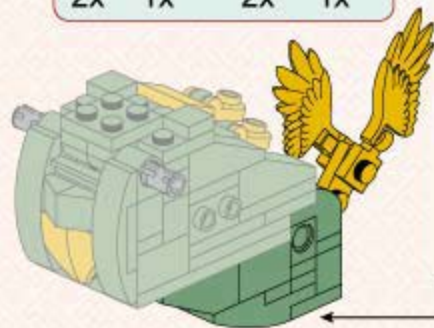
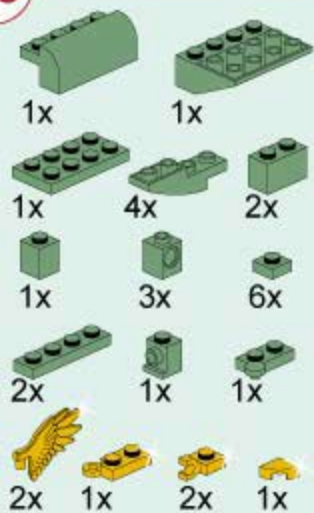



31

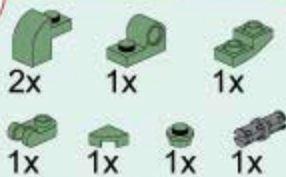

1

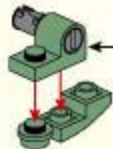

2



3

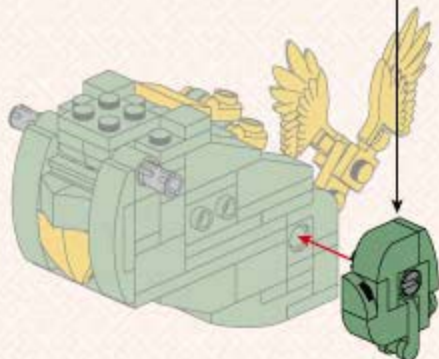

32

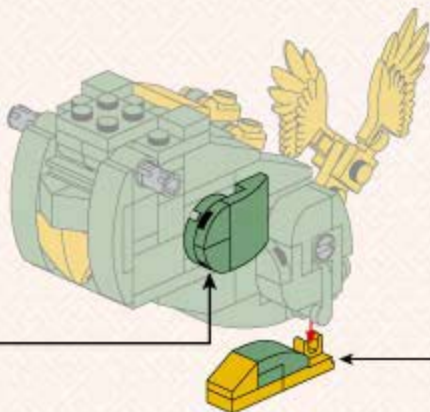
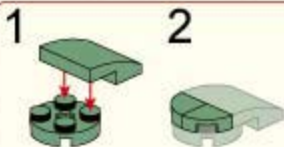
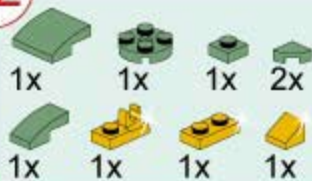

1

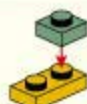

2

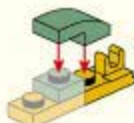

3



33

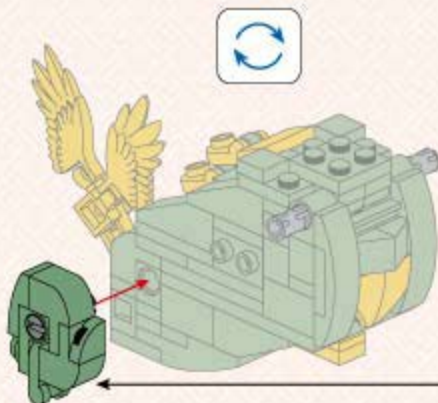
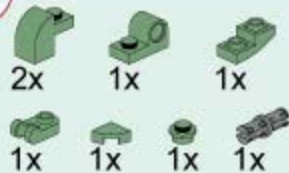

1

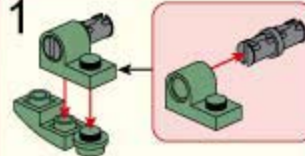

2



3

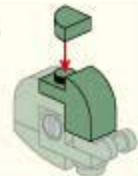

34

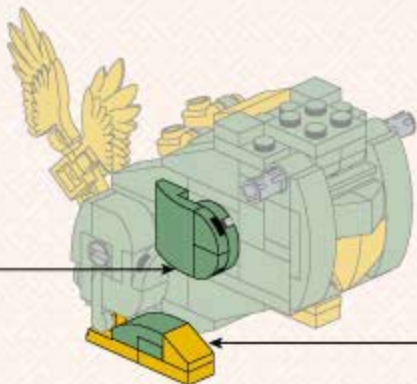
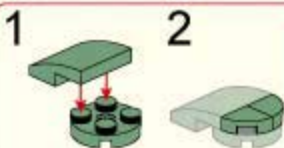
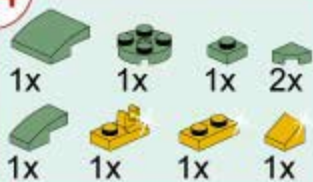

1

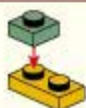

2



3



35

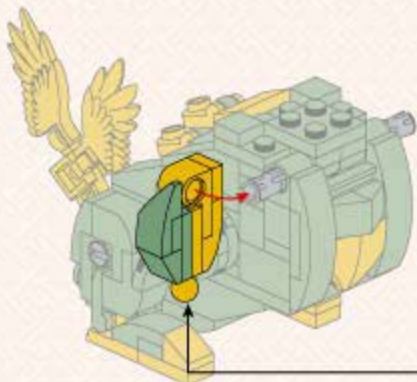
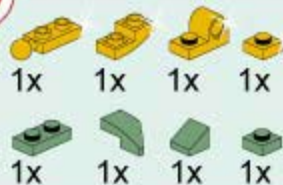

1



2



3



4

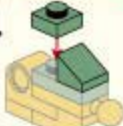

5



36

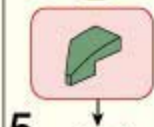
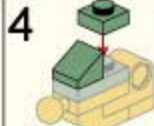
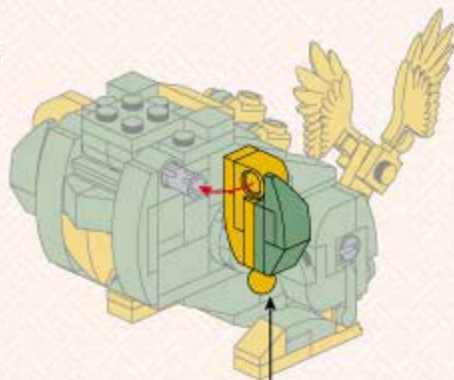
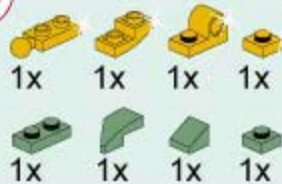

37

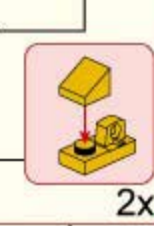
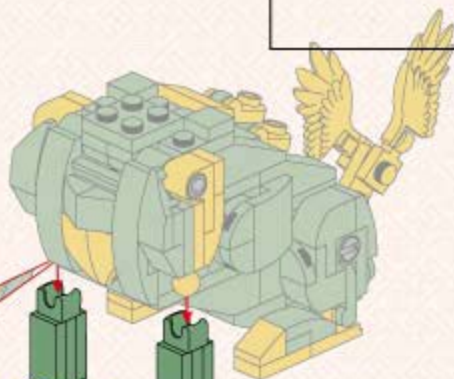

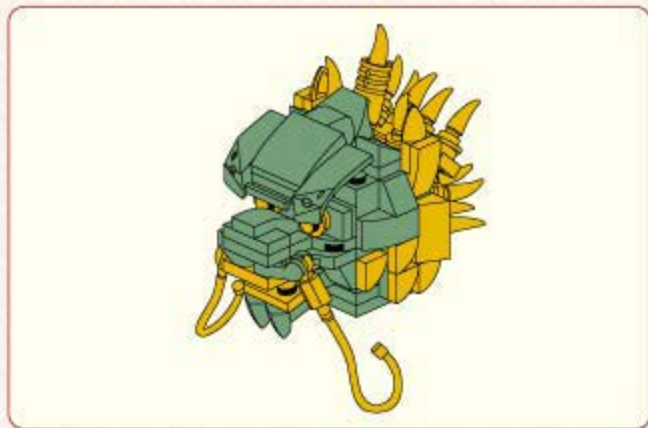

38



1x



2x

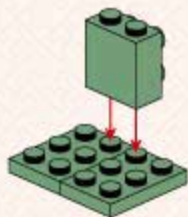

39



2x



1x



40



1x



1x



2x

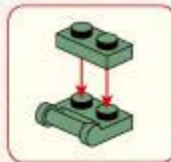

41



2x



2x



42



2x



2x



1x



43



1x



1x



1x



3x



1

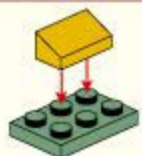

2



3



44



2x



8x

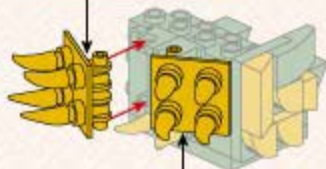
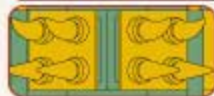

1



2



1



2



18

45

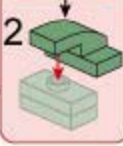
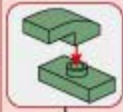
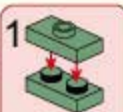
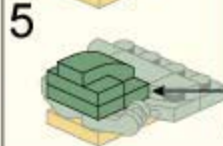
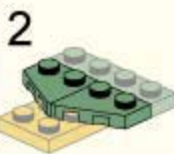
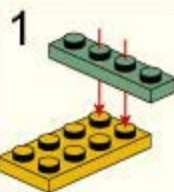
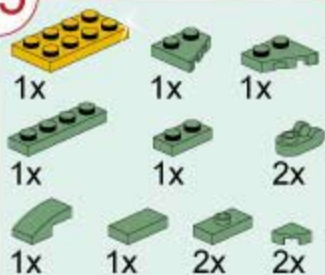

46

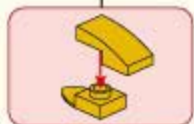
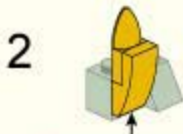
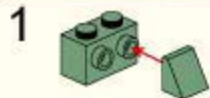
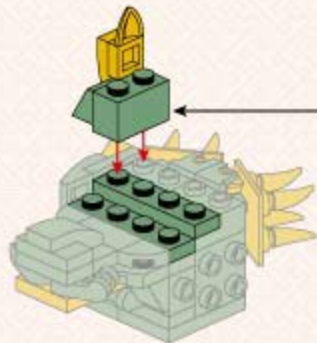
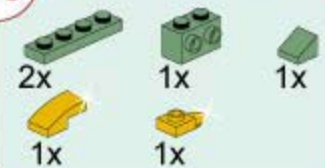

47



2x



1x



1x

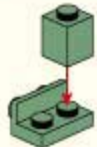

48



1x



2x



1x



1x



1x

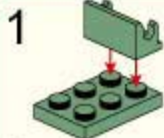
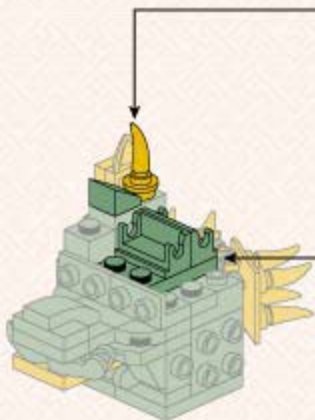

1

2



49

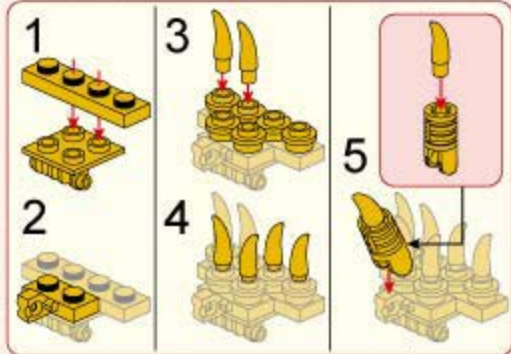
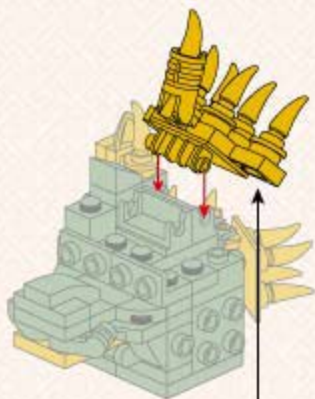

50

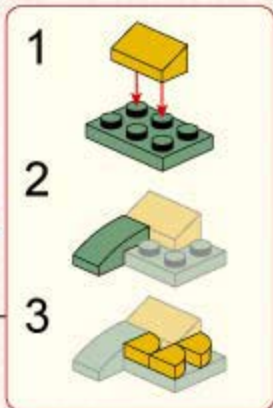
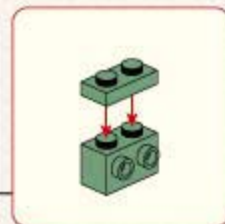
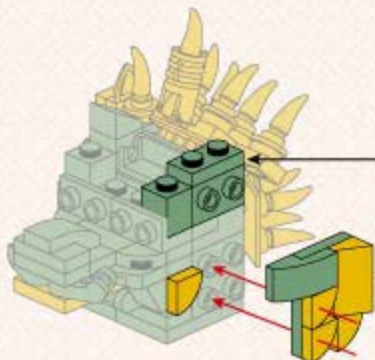
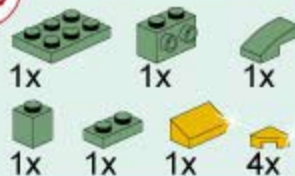

51

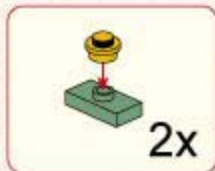

52

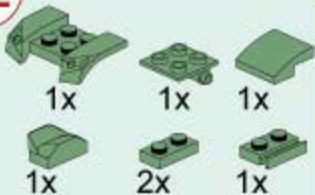

1



3



2



4

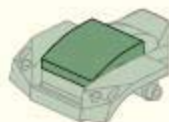

53

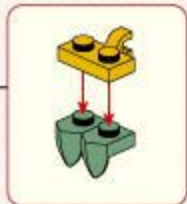
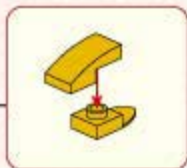
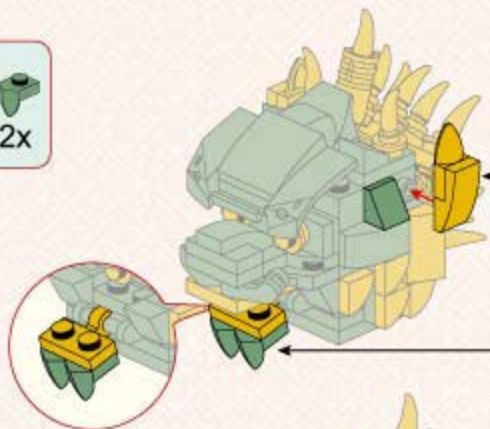

54

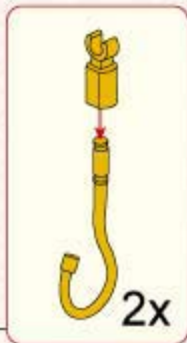
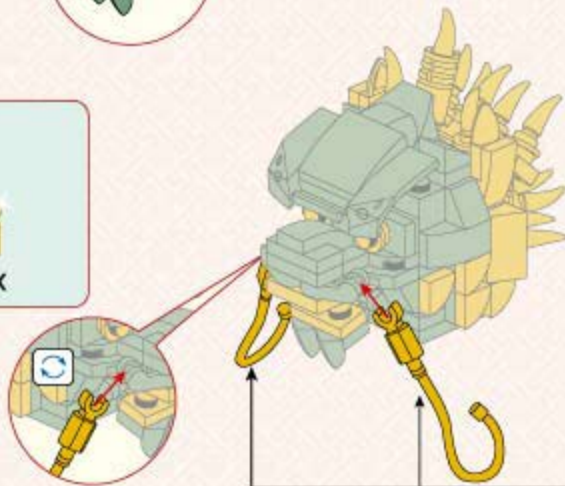

55

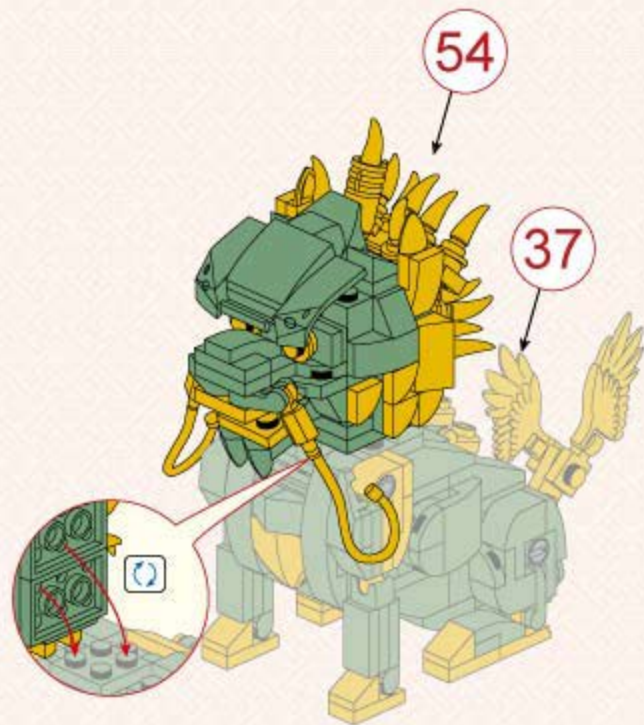

56



1

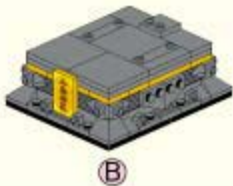

1

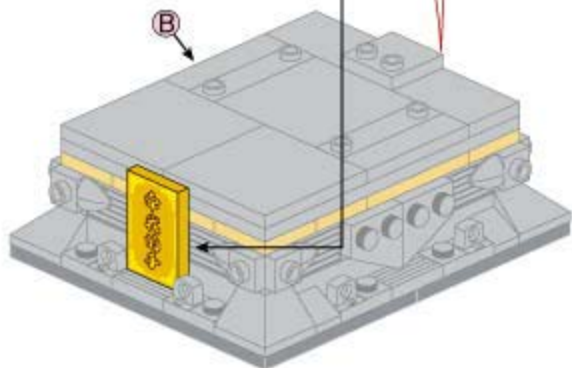
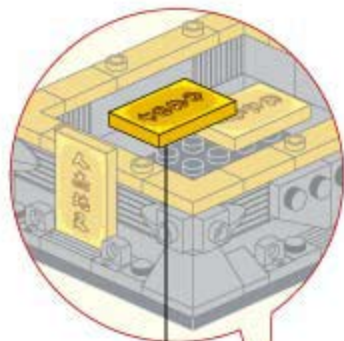

2

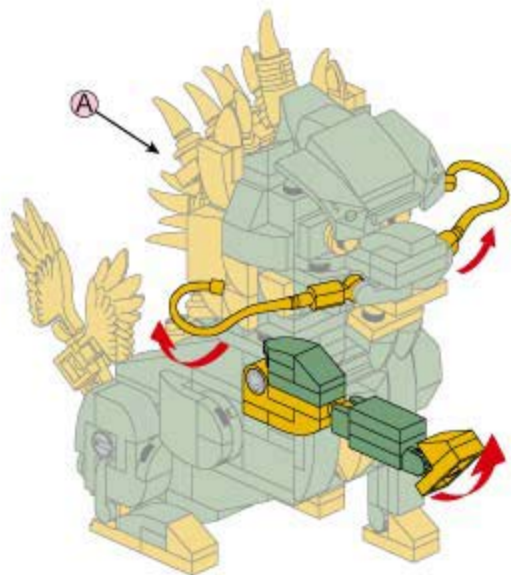

3



4

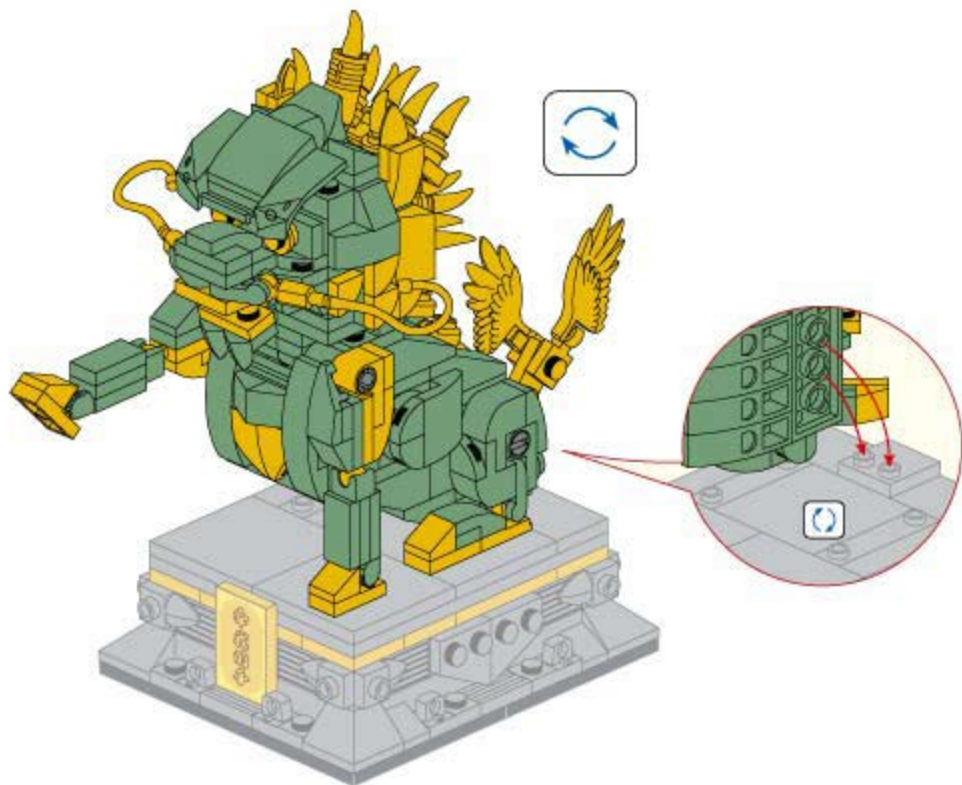

2



A



B

1

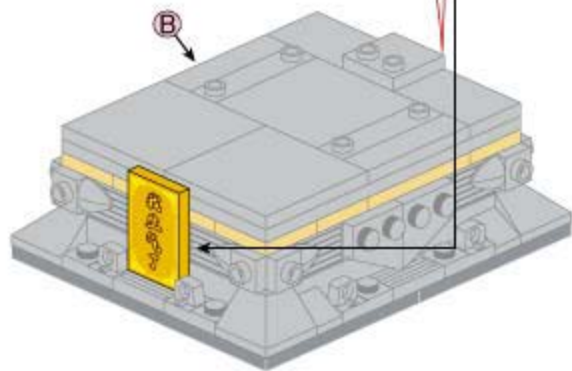
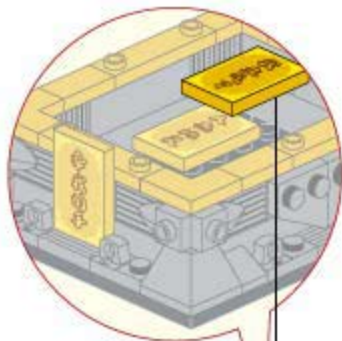

2

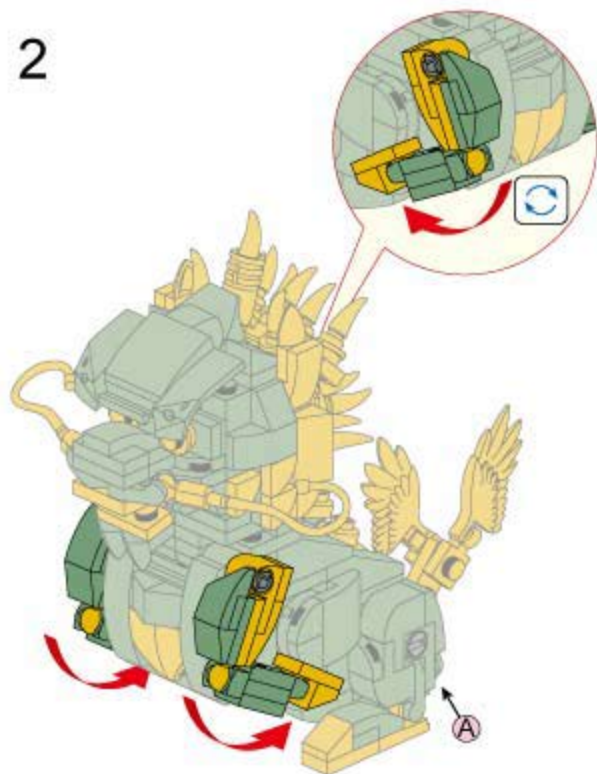

3

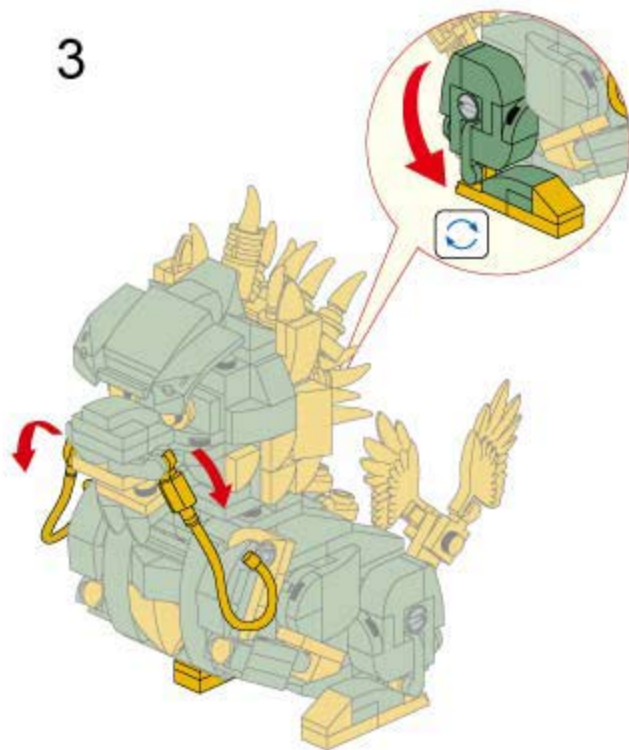

4

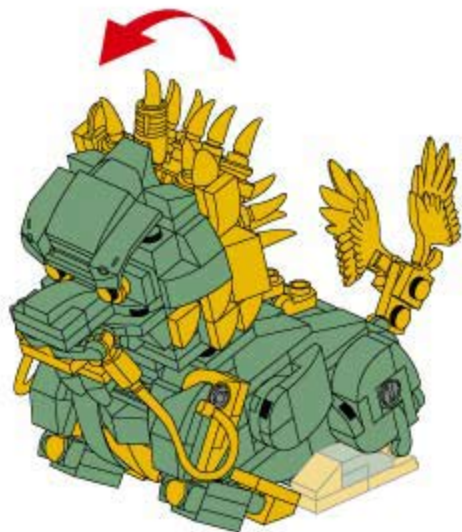

5



