

Keepplay

国玩系列



故宫宫廷文化



正版授权

K10119 迷你太和殿



太和殿是紫禁城内体量最大、等级最高的建筑物。

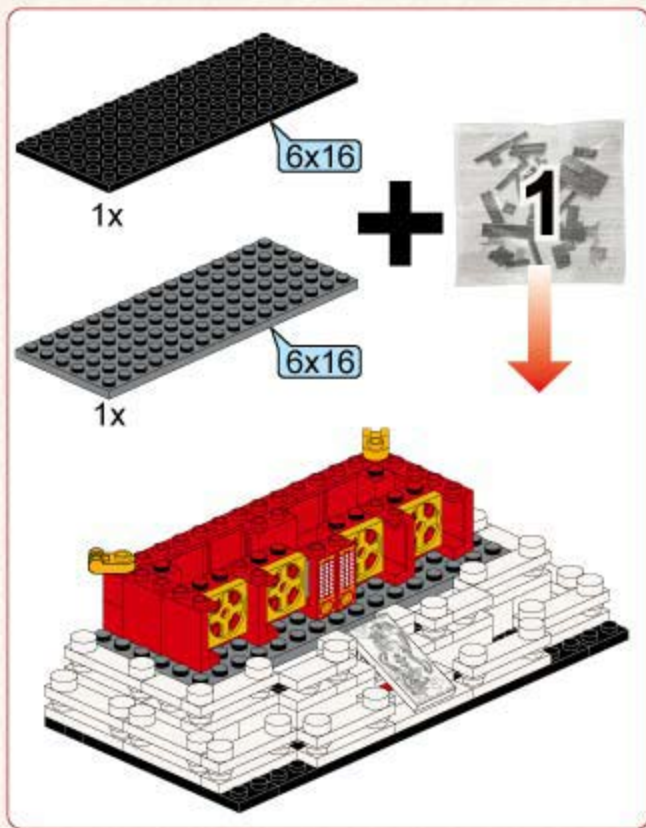

拆件器使用方法，仅为示例

Usage of Brick Separator, Just for the sample

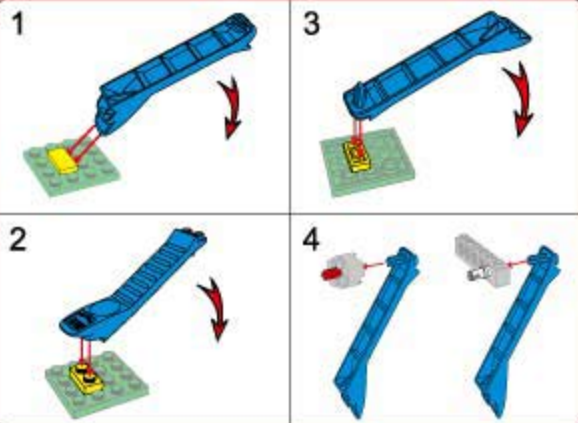

A1

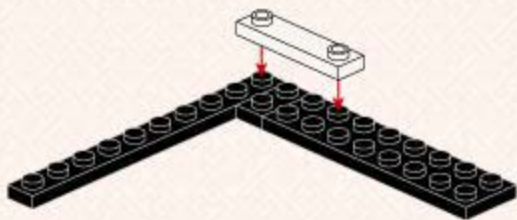
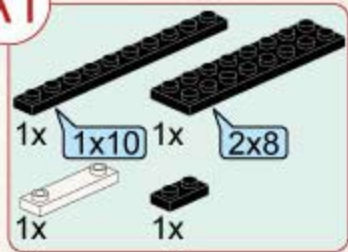

A2

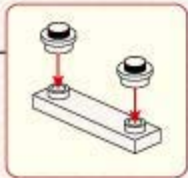
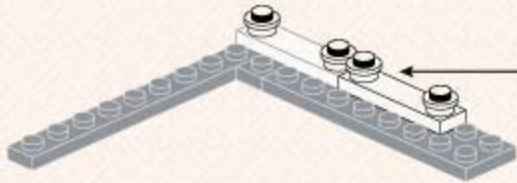
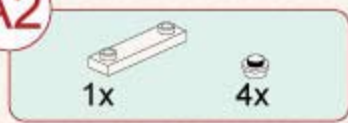

A3

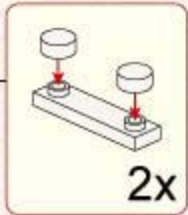
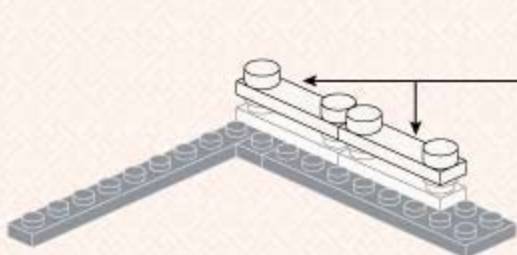

A4

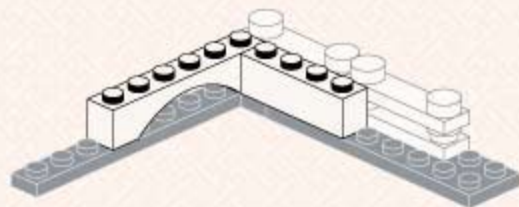
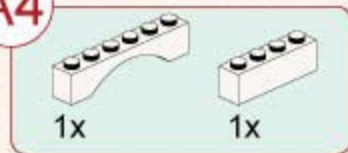

A5

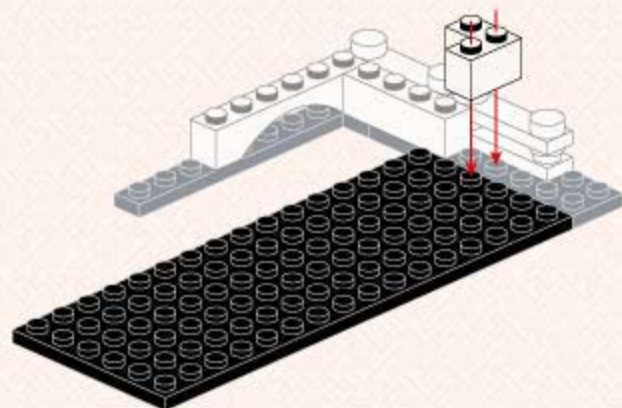
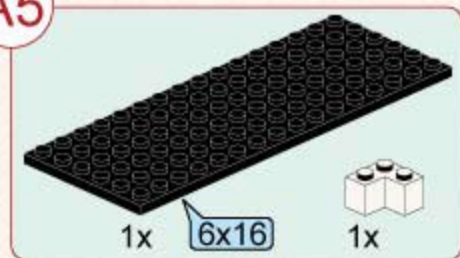



A6

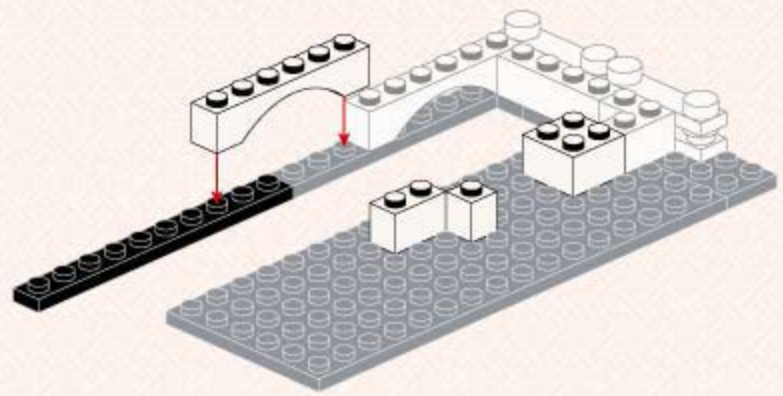
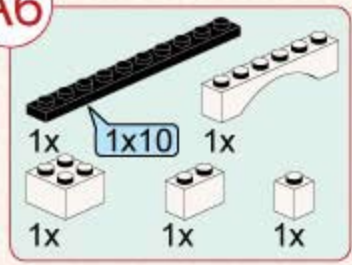

A7

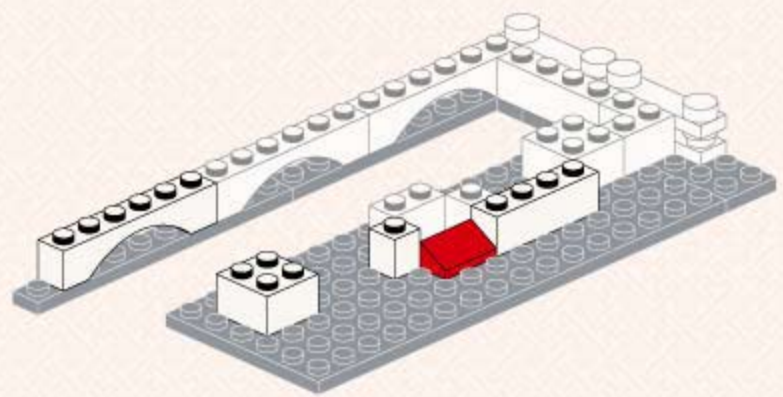
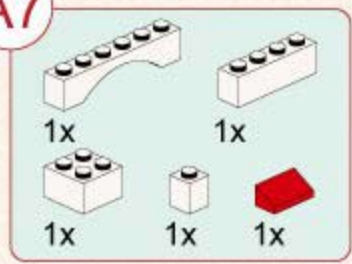

A8

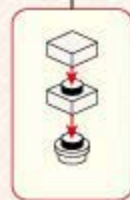
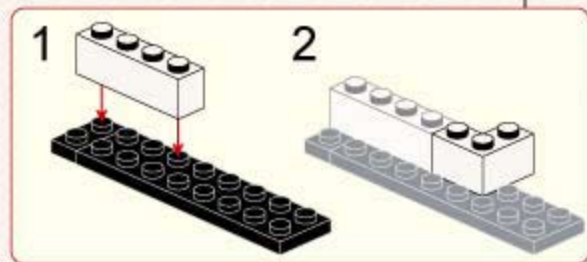
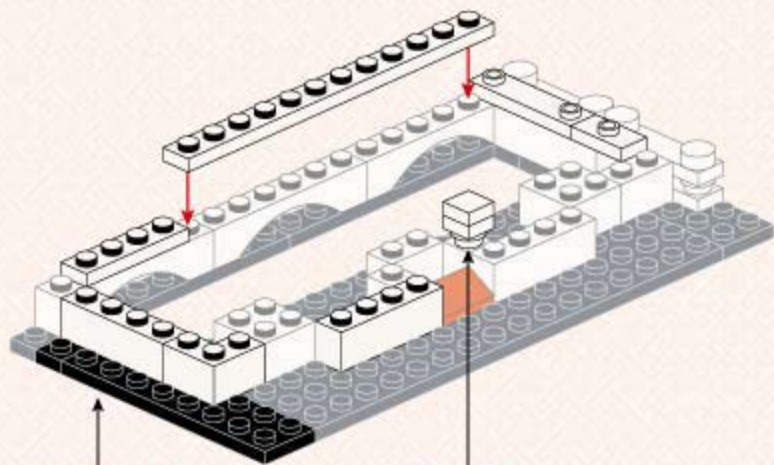
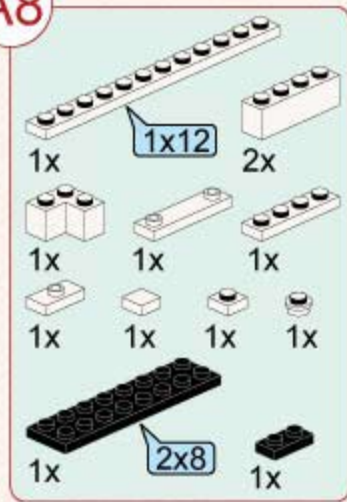

**A9**

1x **1x12** 1x 1x

1x **1x4** 3x 1x 5x

1x 2x

**1:1**

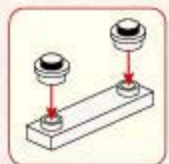

**A10**

6x 1x 3x

1x 8x 4x

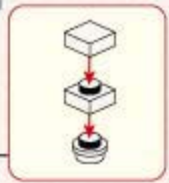
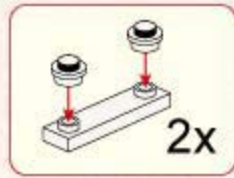
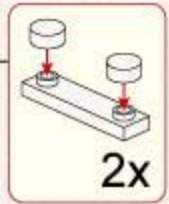
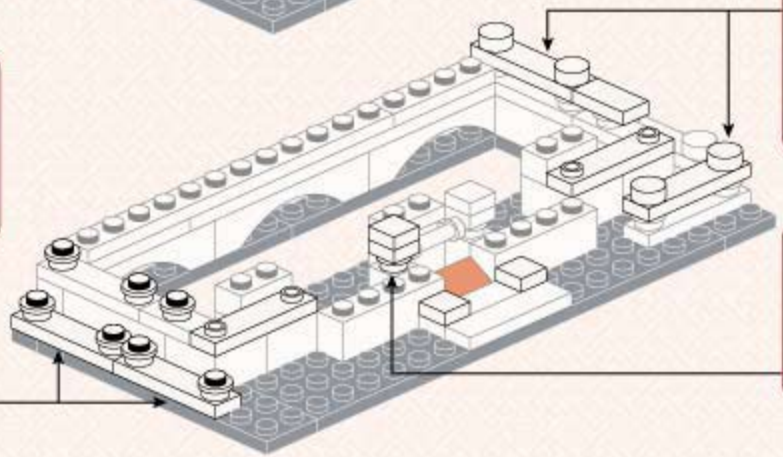



A11

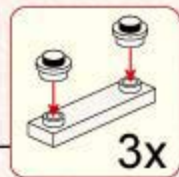
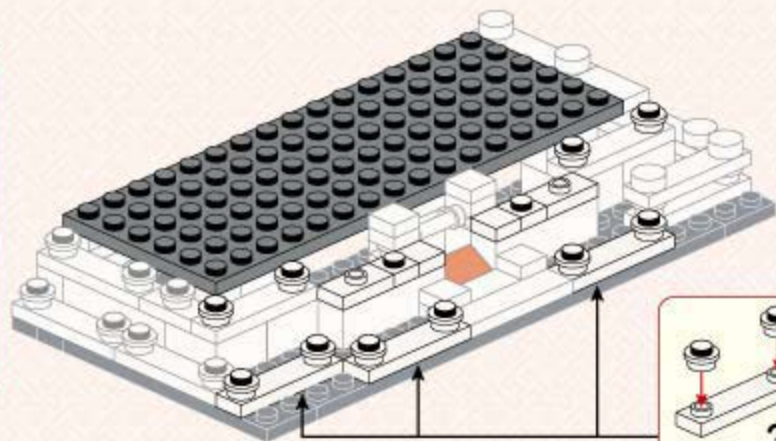
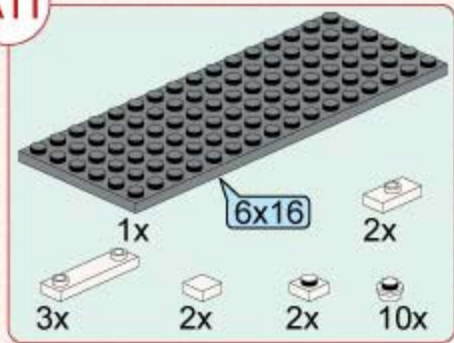

A12

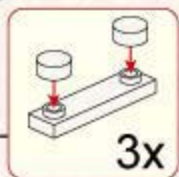
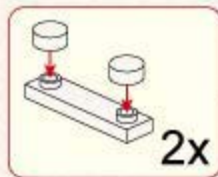
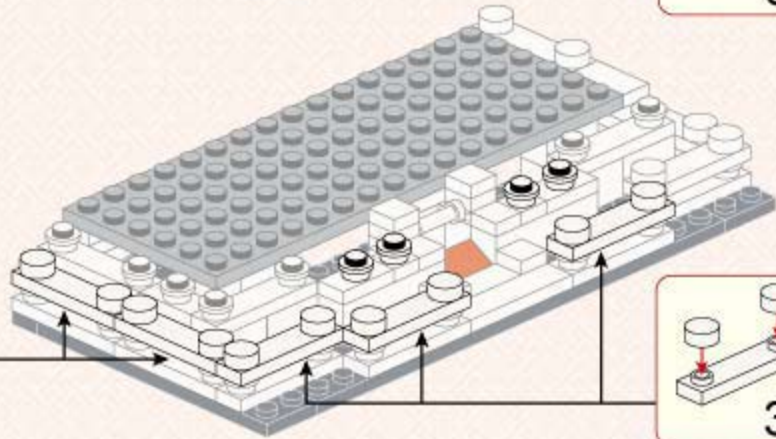



A13

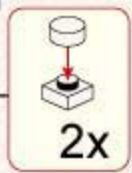
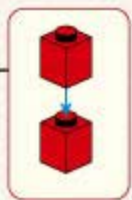
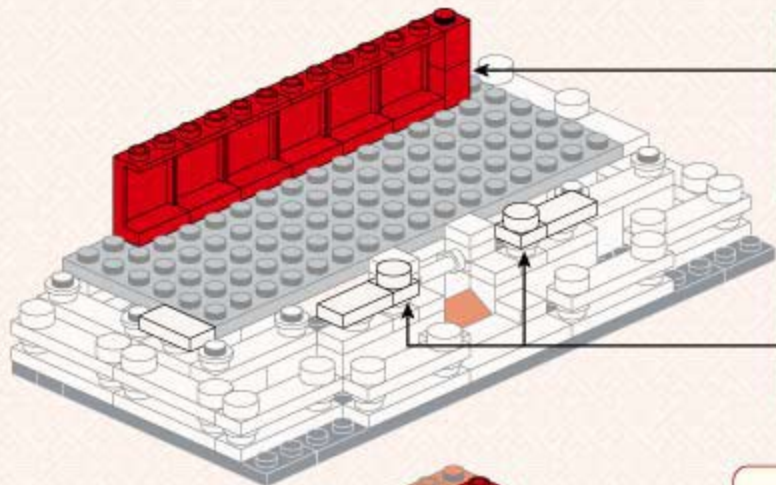

A14

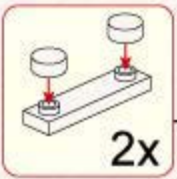
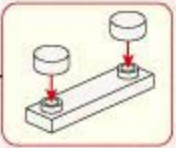
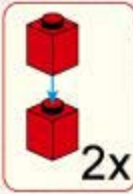
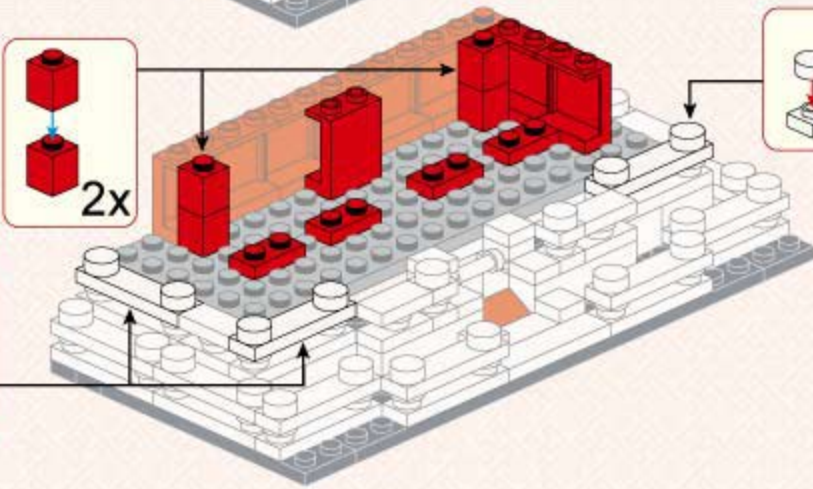
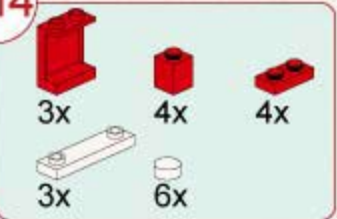



A16



4x



1x



2x

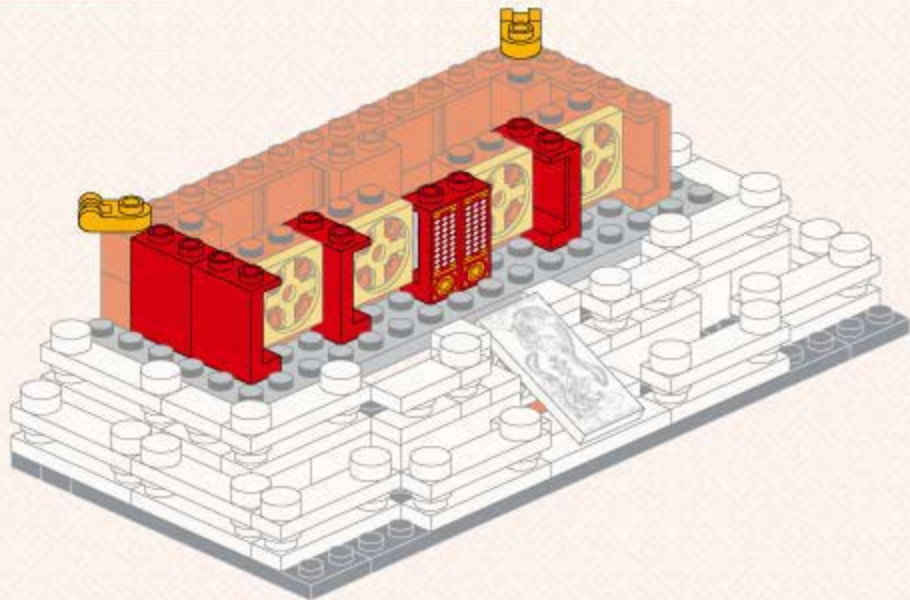



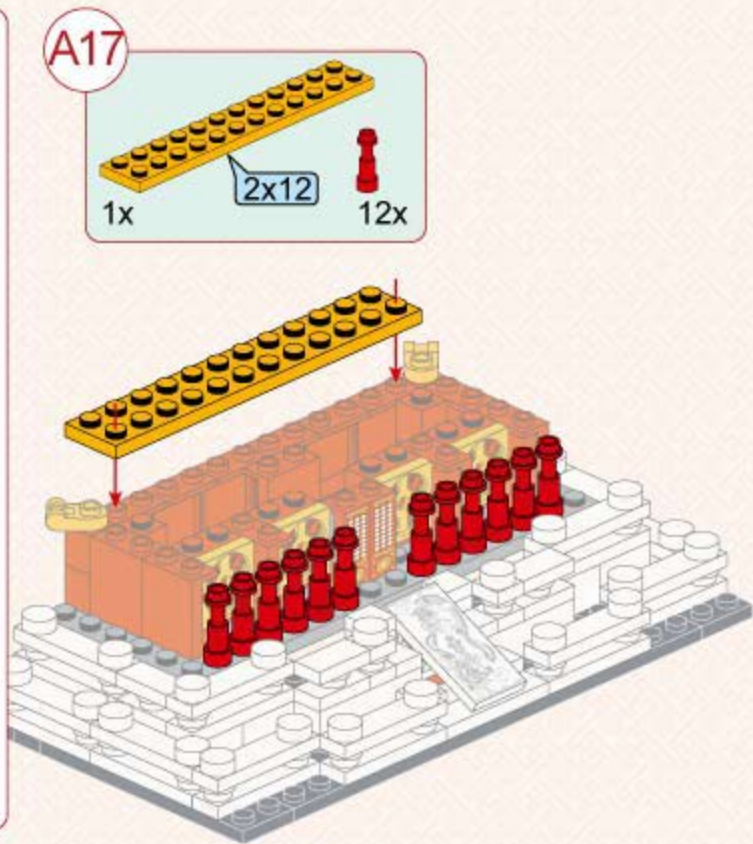
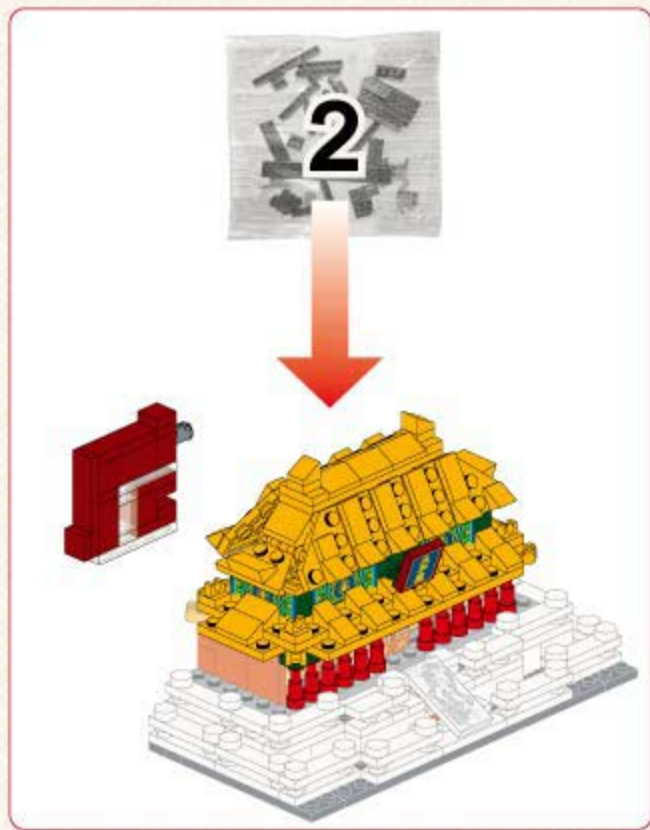

A18

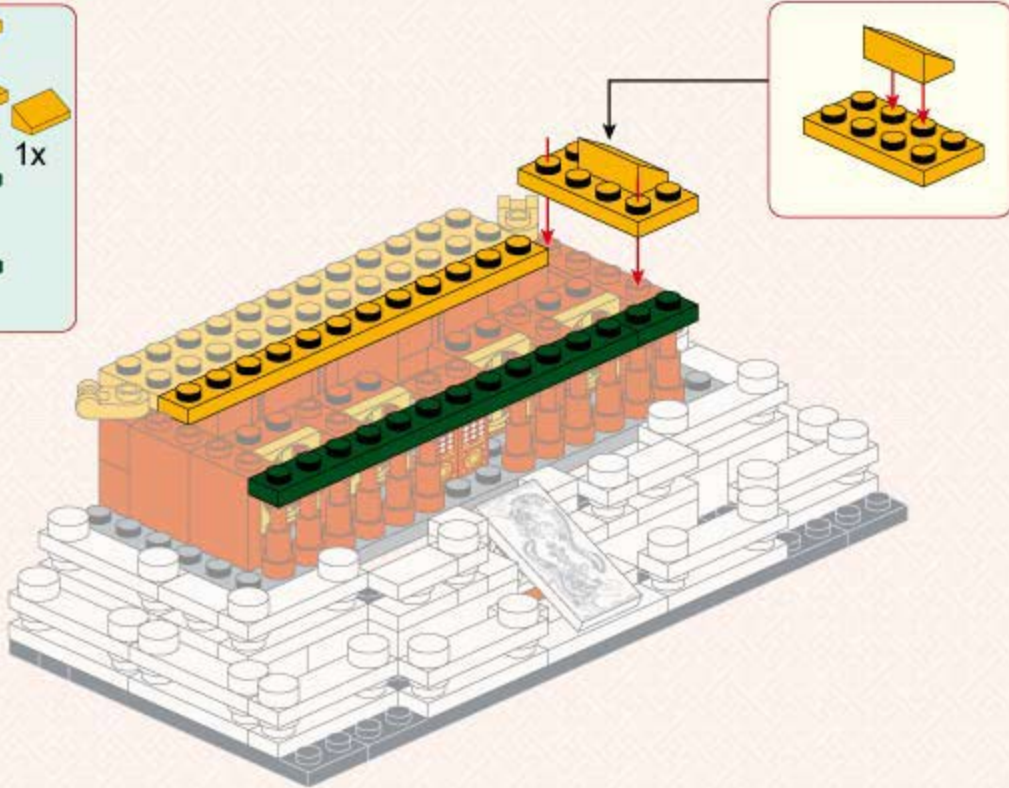
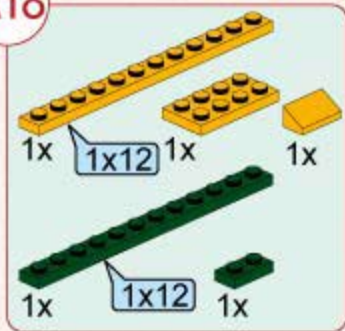

A19

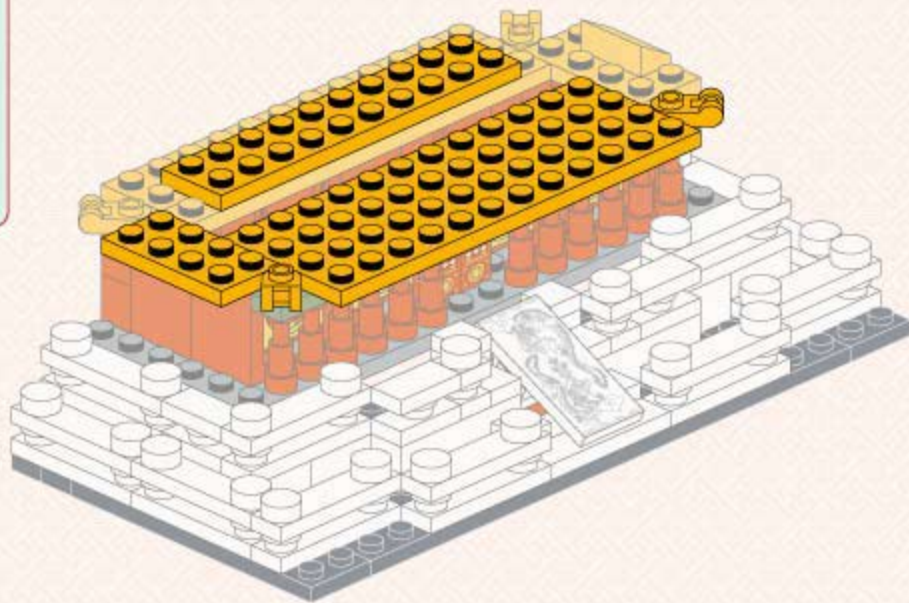
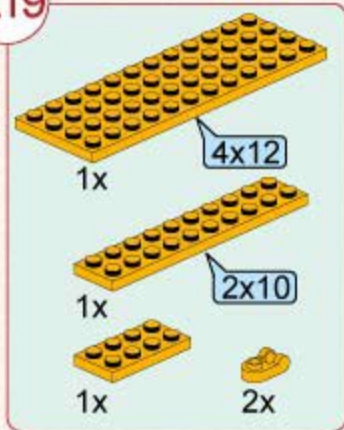



A20



2x10

1x



2x



6x

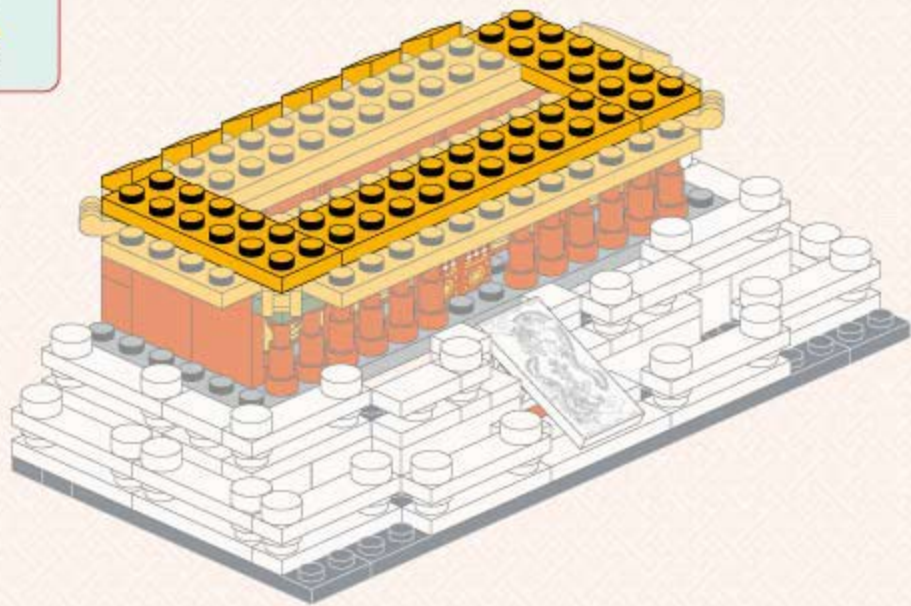

A21

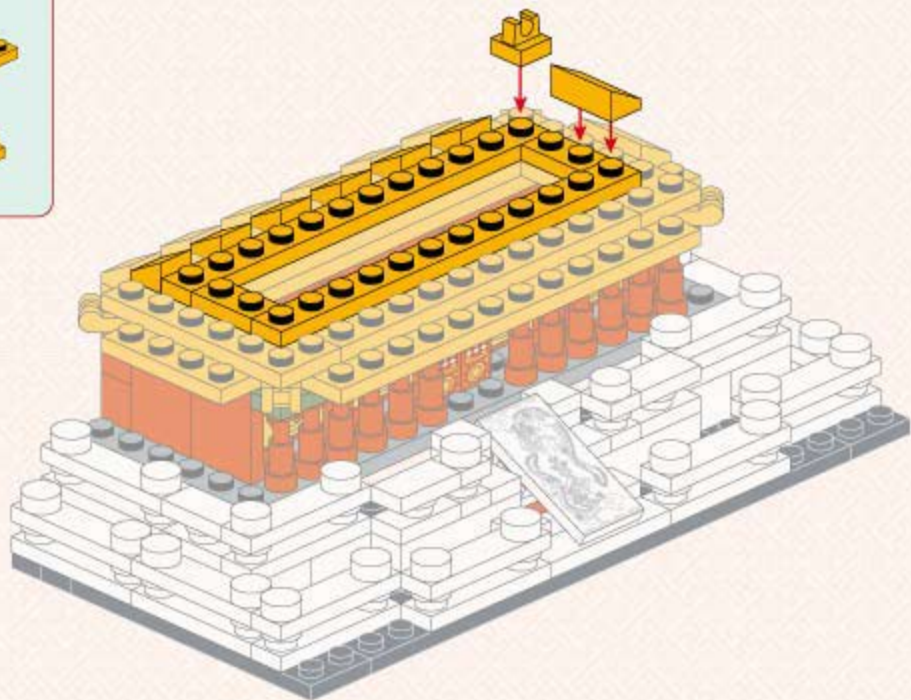
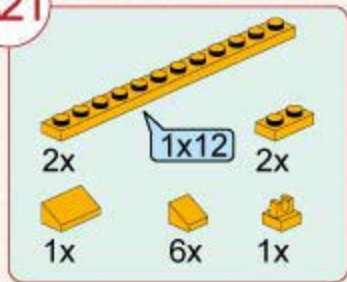

A22

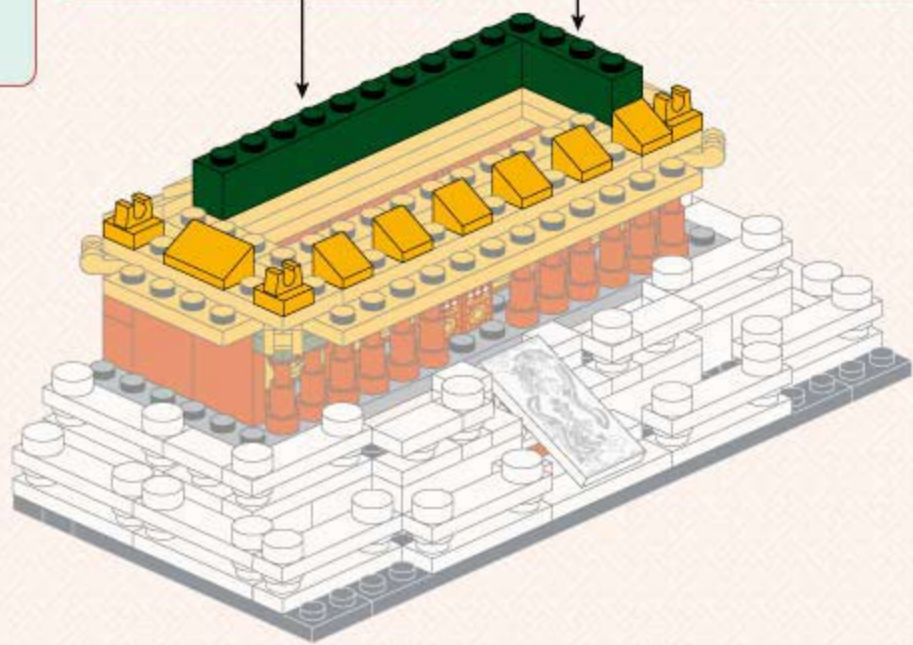
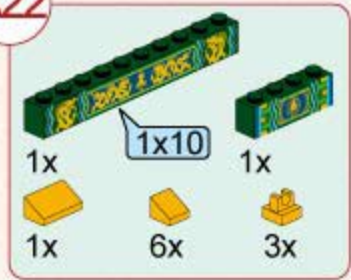



A23

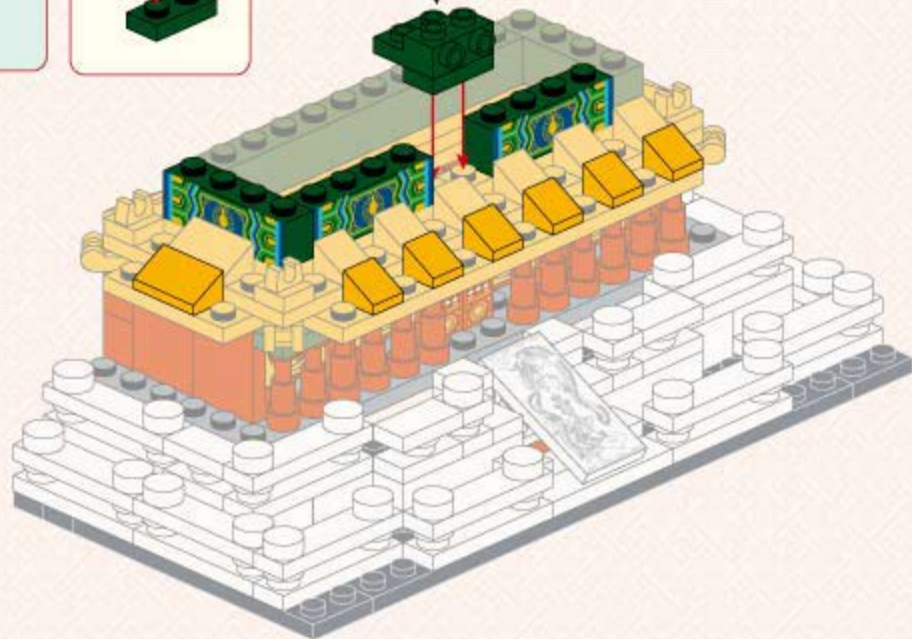
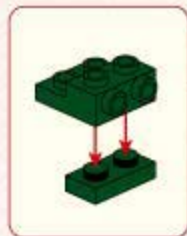
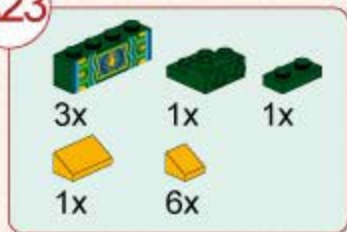

A24

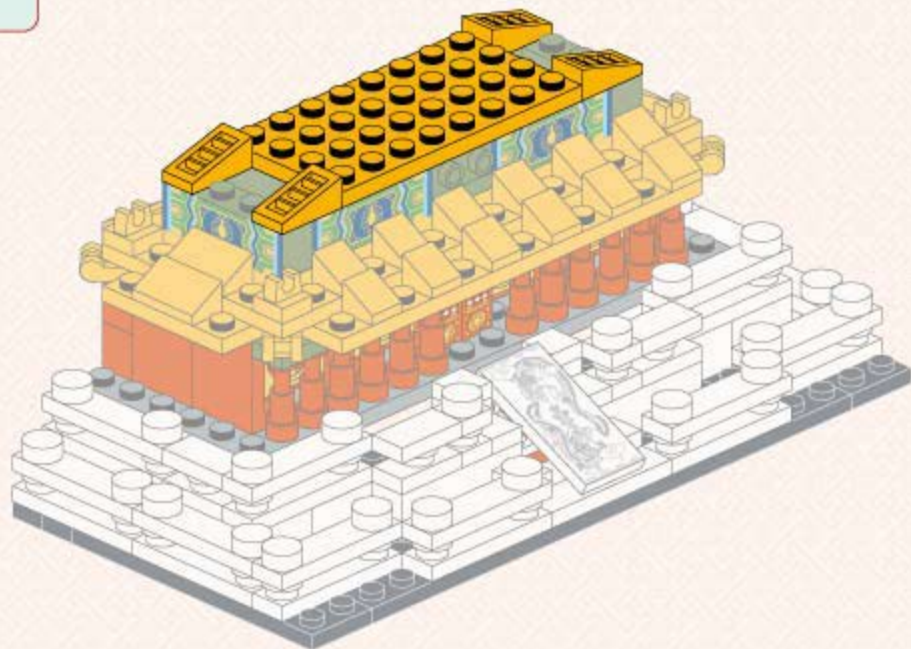
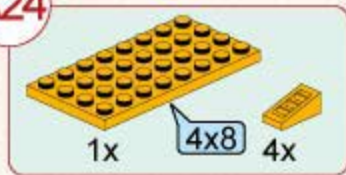

A25



2x



2x



4x

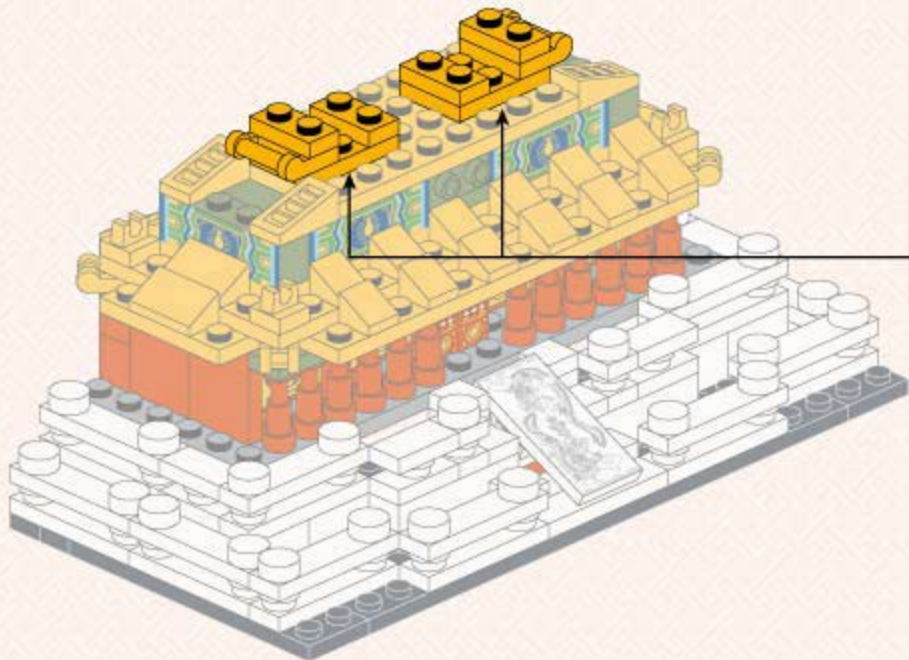

1

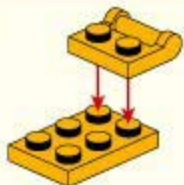

2



2x



A26

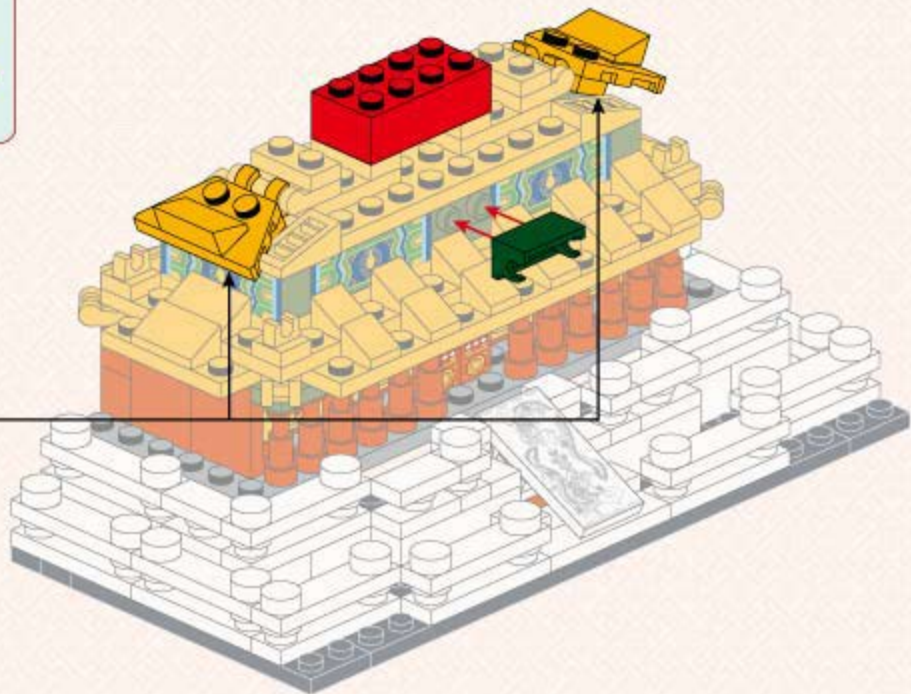
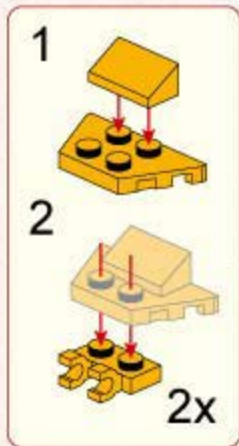
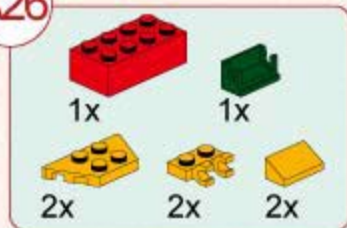

A27

- 1x (1x8 yellow Technic beam)
- 2x8 (2x8 yellow Technic beam)
- 2x (2x yellow Technic beam)
- 6x (6x yellow Technic beam)
- 2x (2x yellow Technic beam)
- 1x (1x yellow Technic beam)
- 2x (2x yellow Technic beam)
- 2x (2x yellow Technic beam)
- 2x (2x yellow Technic beam)
- 4x (4x yellow Technic beam)
- 1x (1x yellow Technic beam)

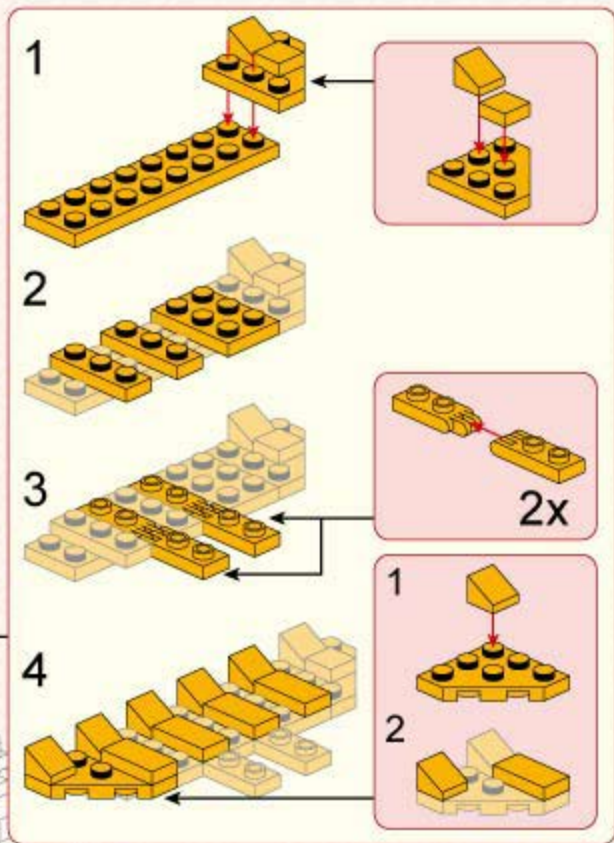
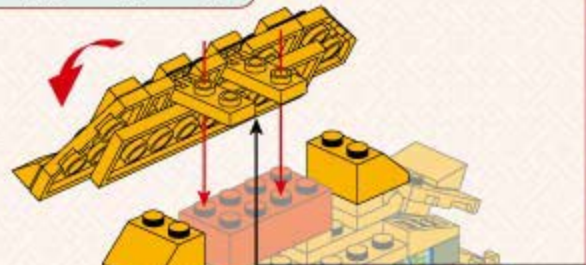

A28

- 1x 1x8 yellow Technic beam
- 2x 2x4 yellow Technic beam
- 1x 2x2 yellow Technic beam
- 2x 1x2 yellow Technic beam
- 2x 1x3 yellow Technic beam
- 2x 1x4 yellow Technic beam
- 4x 1x2 yellow Technic Technonut
- 6x 1x2 yellow Technic Technonut
- 1x 1x2 yellow Technic Technonut

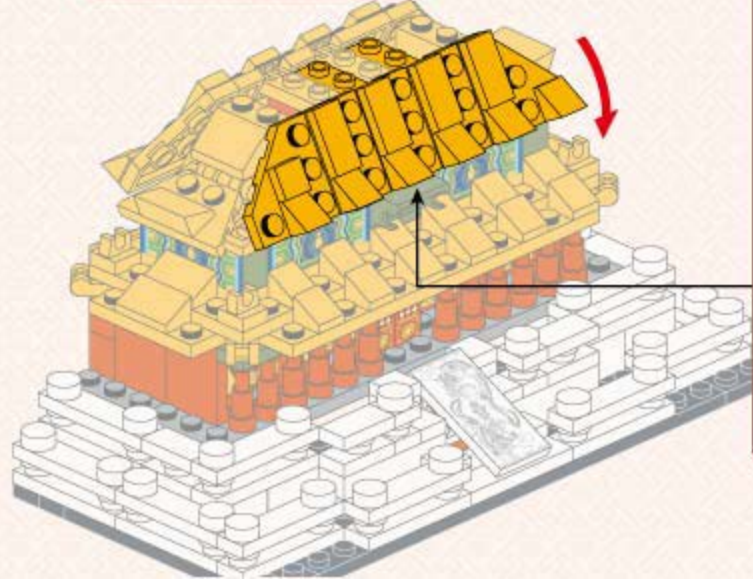

1

2

3

4

2x

1

2



A29

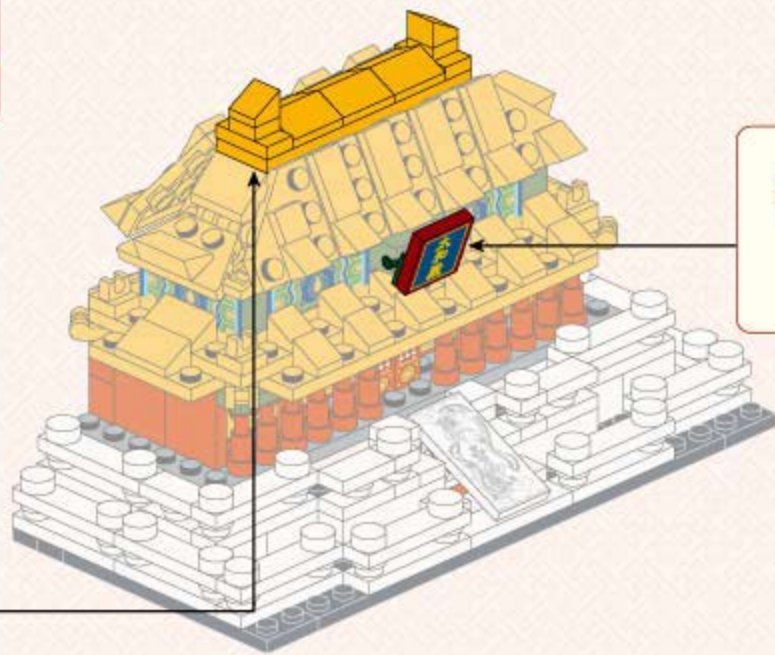
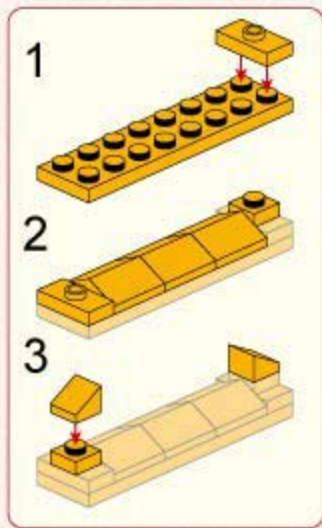
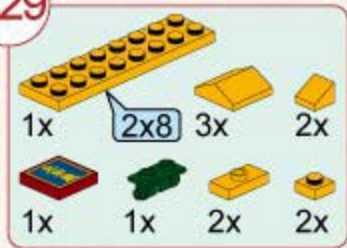



B6

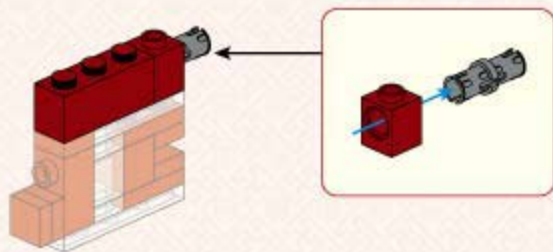

B7



B8

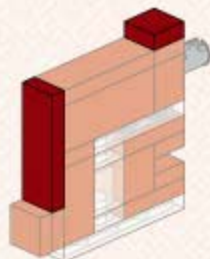



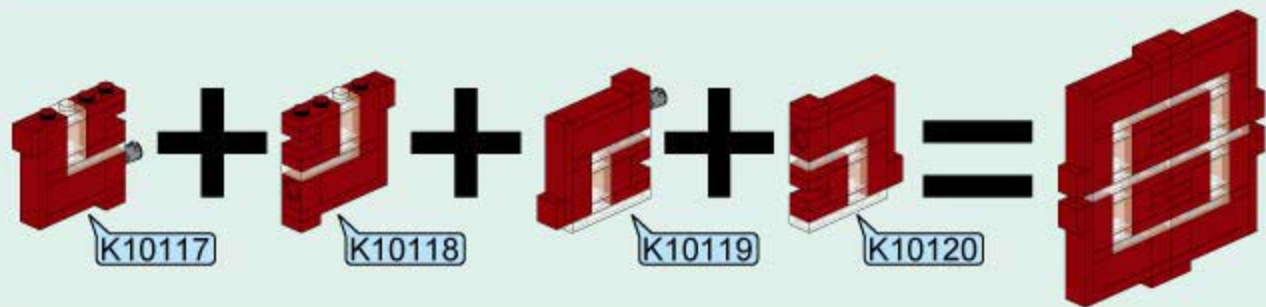

1

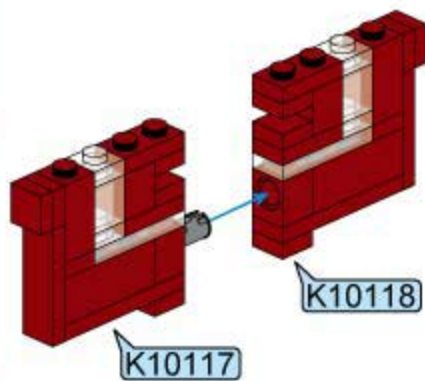

2

