

Keepplay

国玩系列

Keepplay

故宫宫廷文化

正版授权

K10124 精巧太和殿



俗称“金銮殿”，是紫禁城内体量最大、等级最高的建筑物，建筑规制之高，装饰手法之精，堪称中国古代建筑之首。

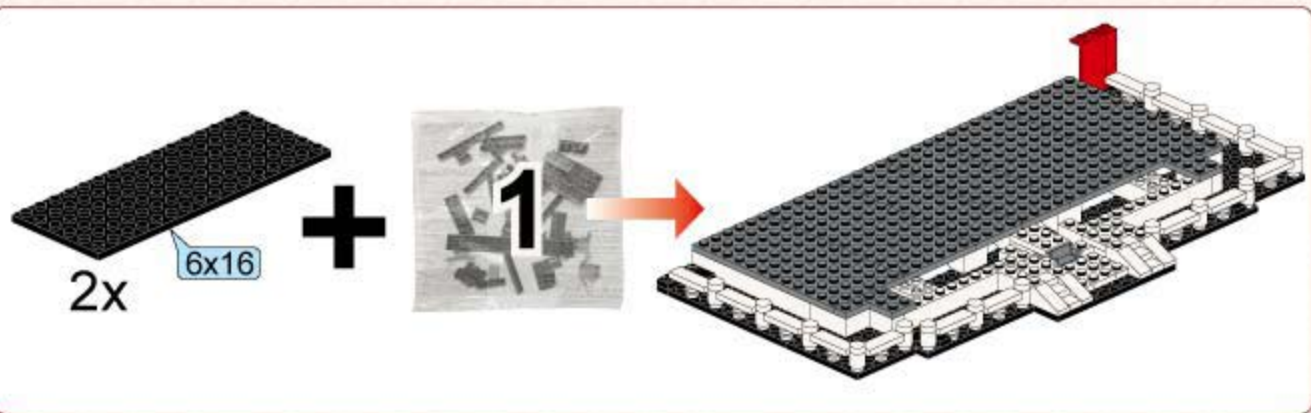

拆件器使用方法，仅为示例

Usage of Brick Separator, Just for the sample

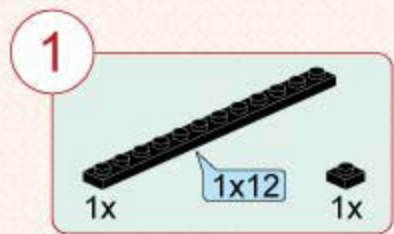
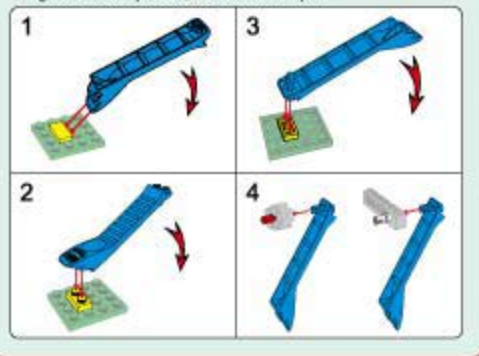

2



1x 4x10 1x

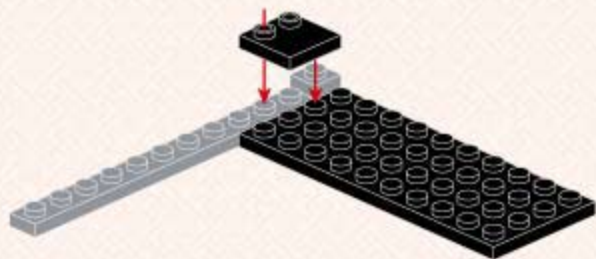

3



6x

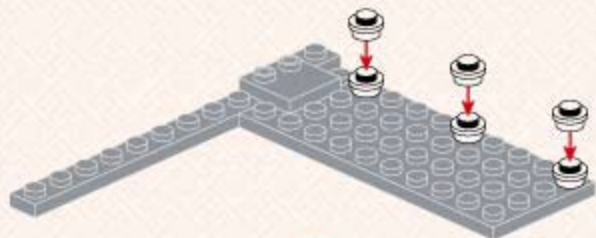

4



1x



2x



2x



2x

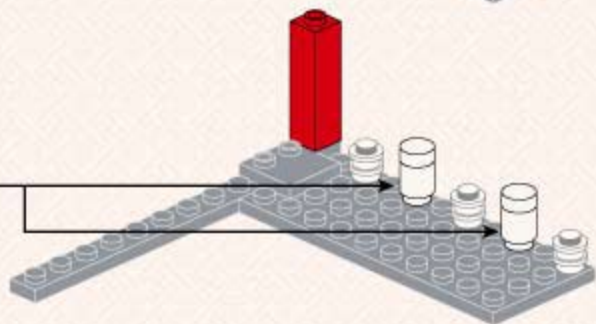

5

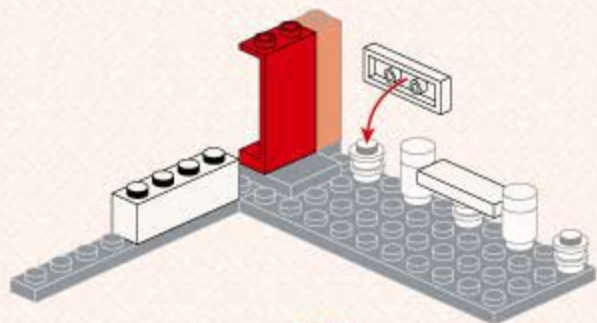
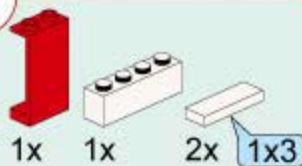

6

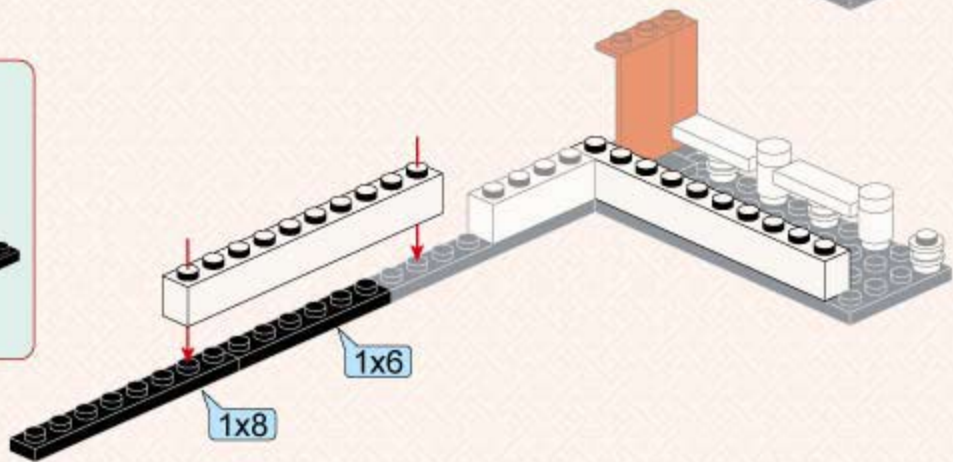
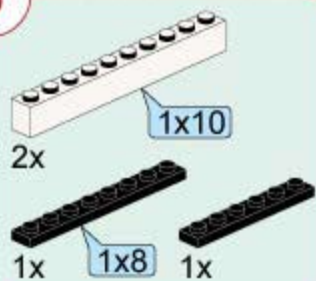

7

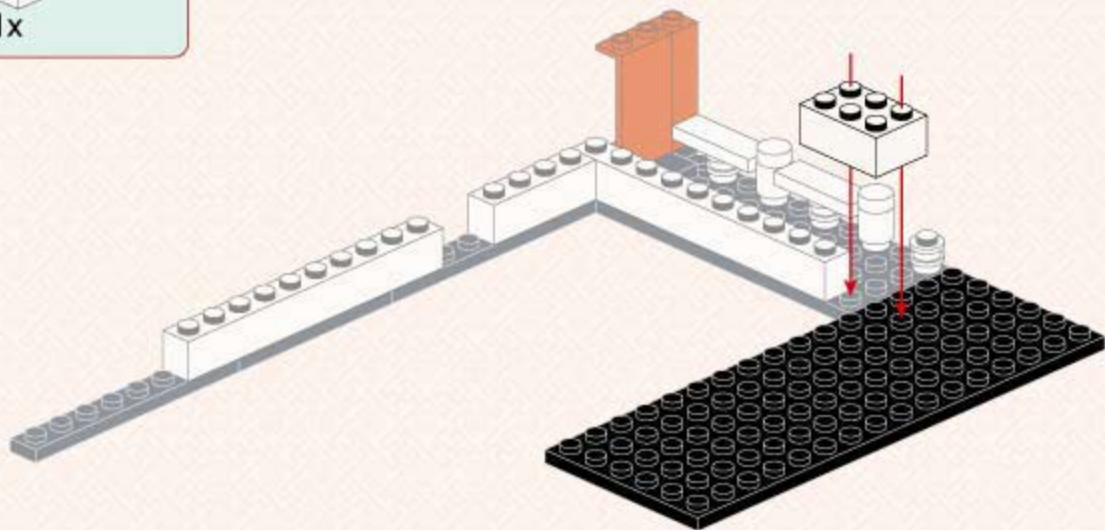
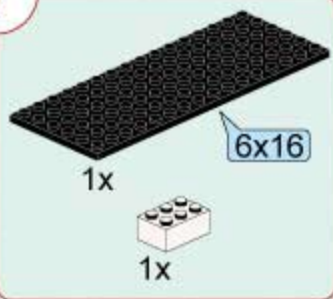

8

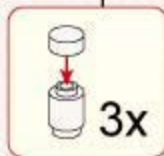
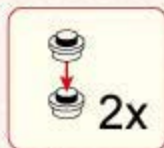
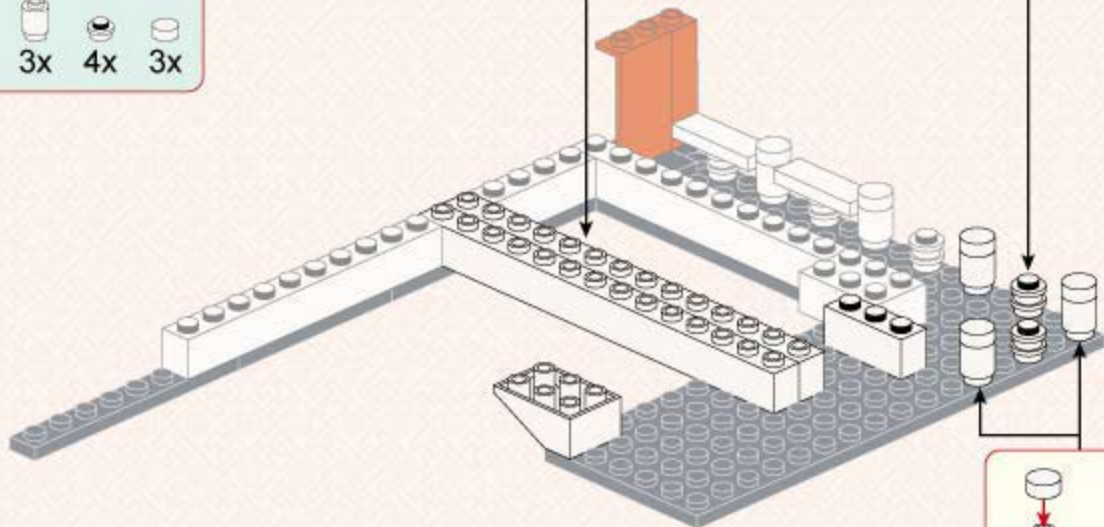
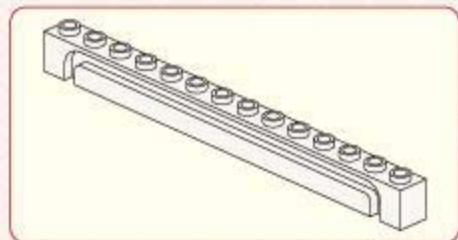
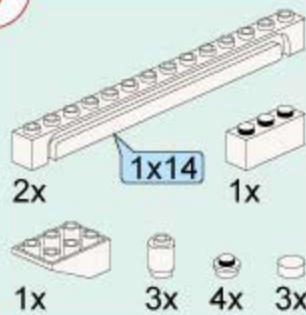

9



2x



1x



3x

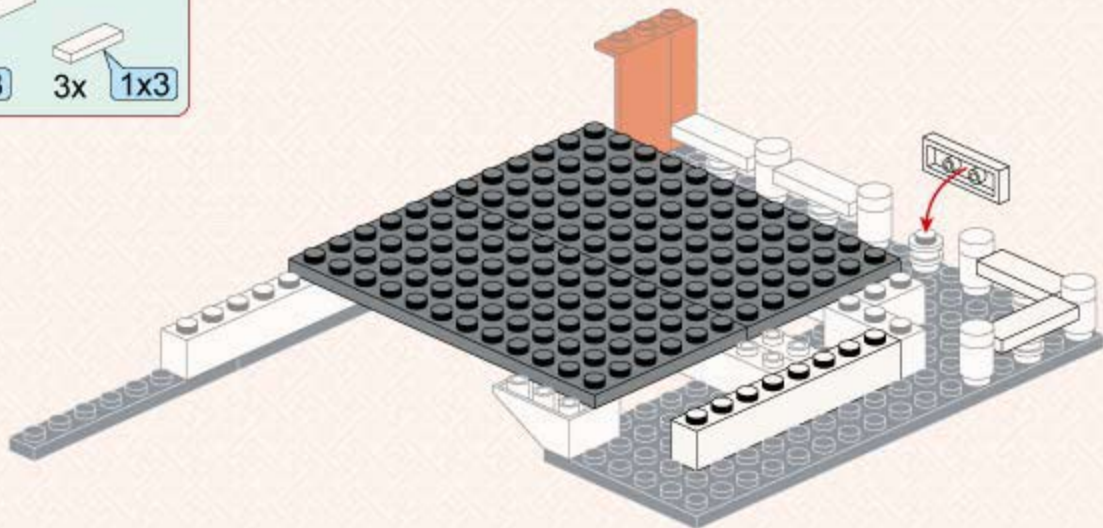

10

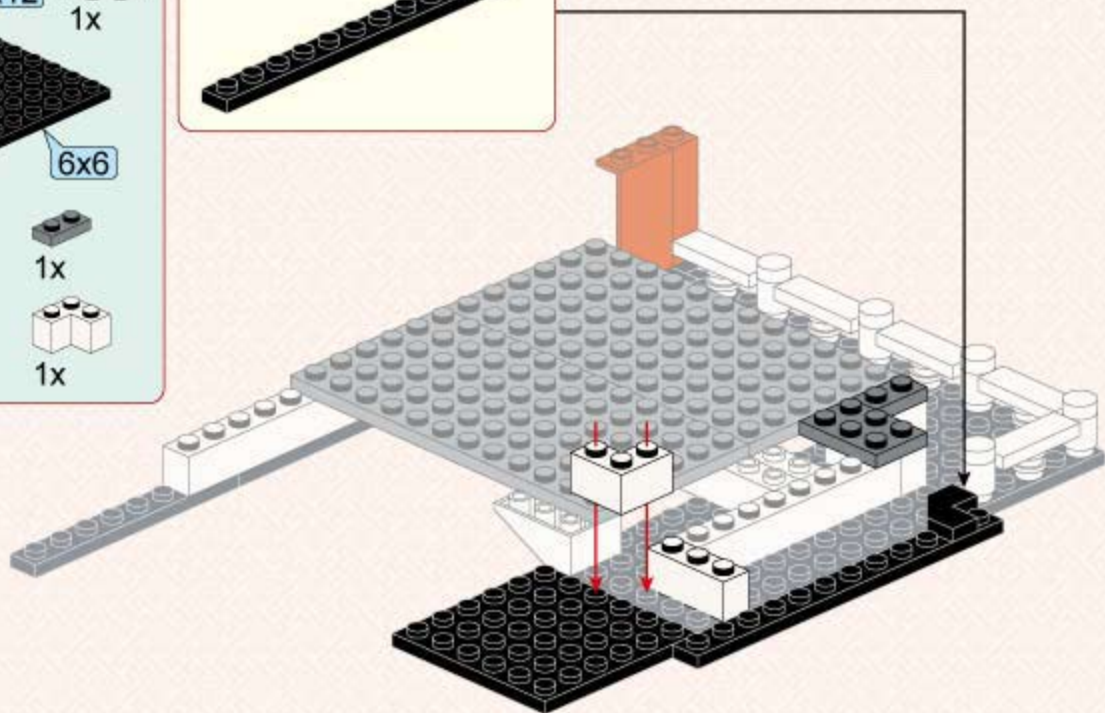
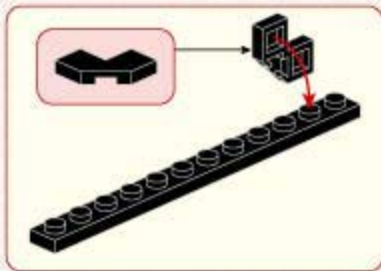
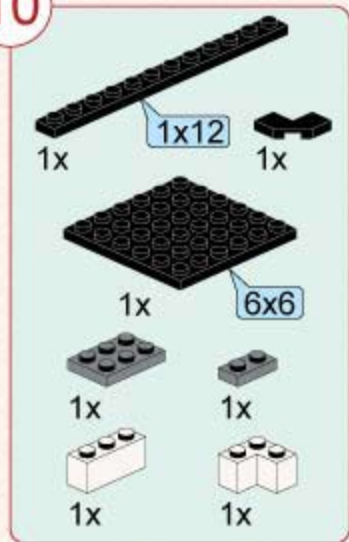



11

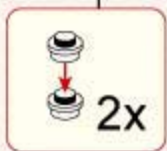
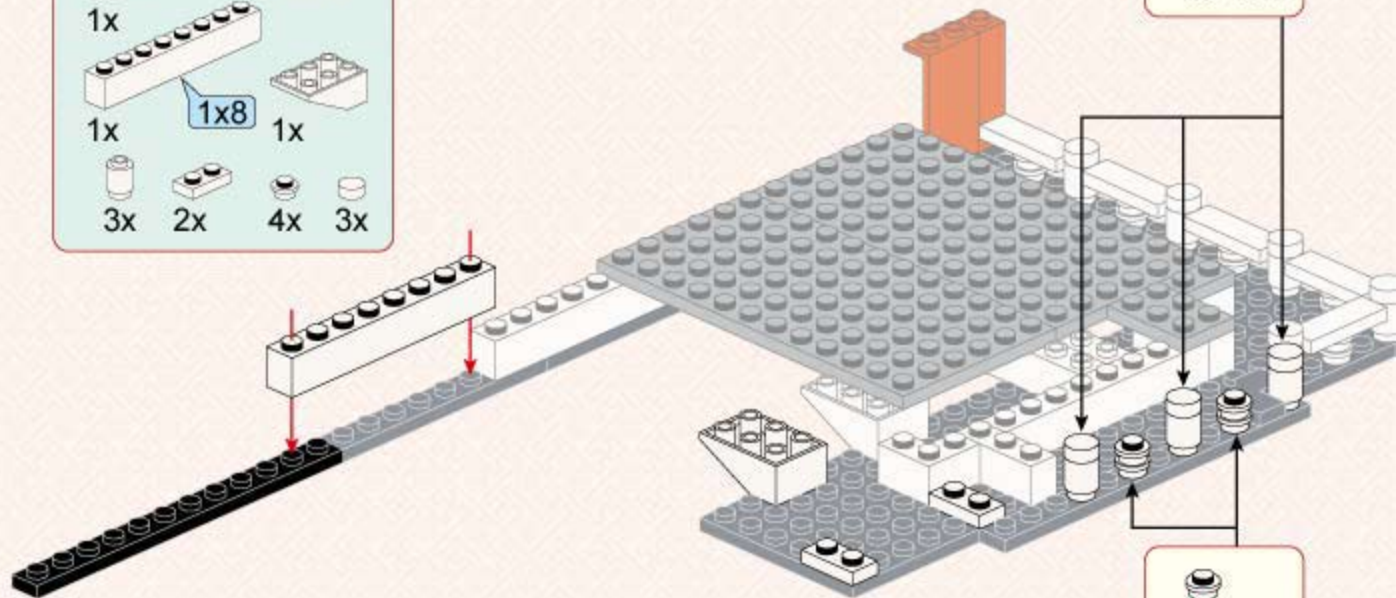
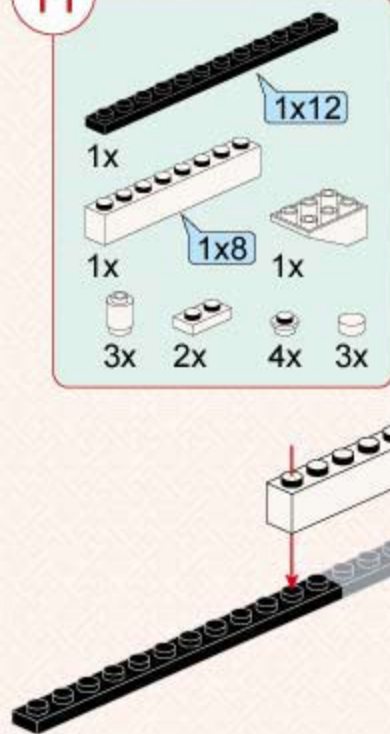

12

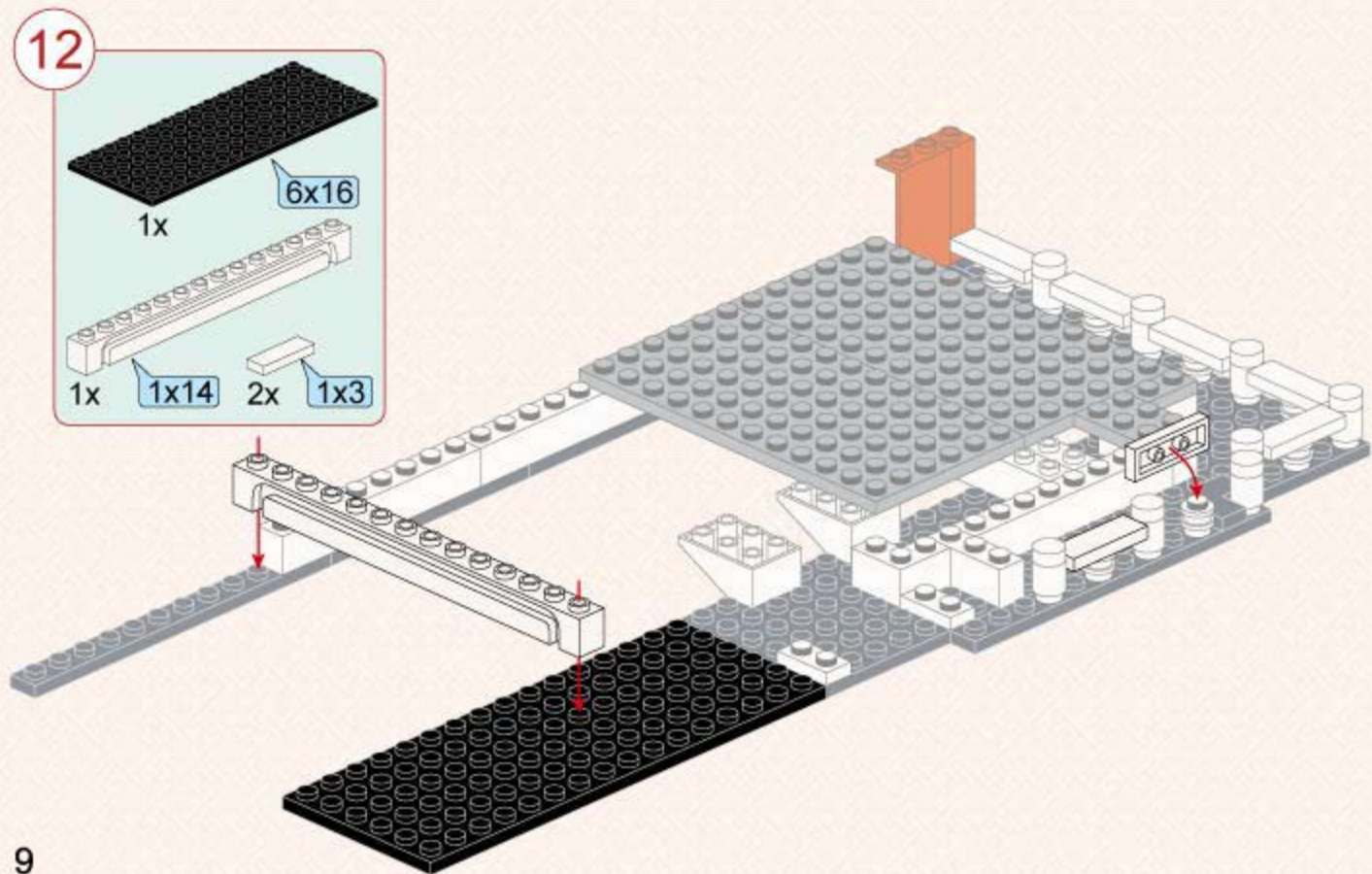

13

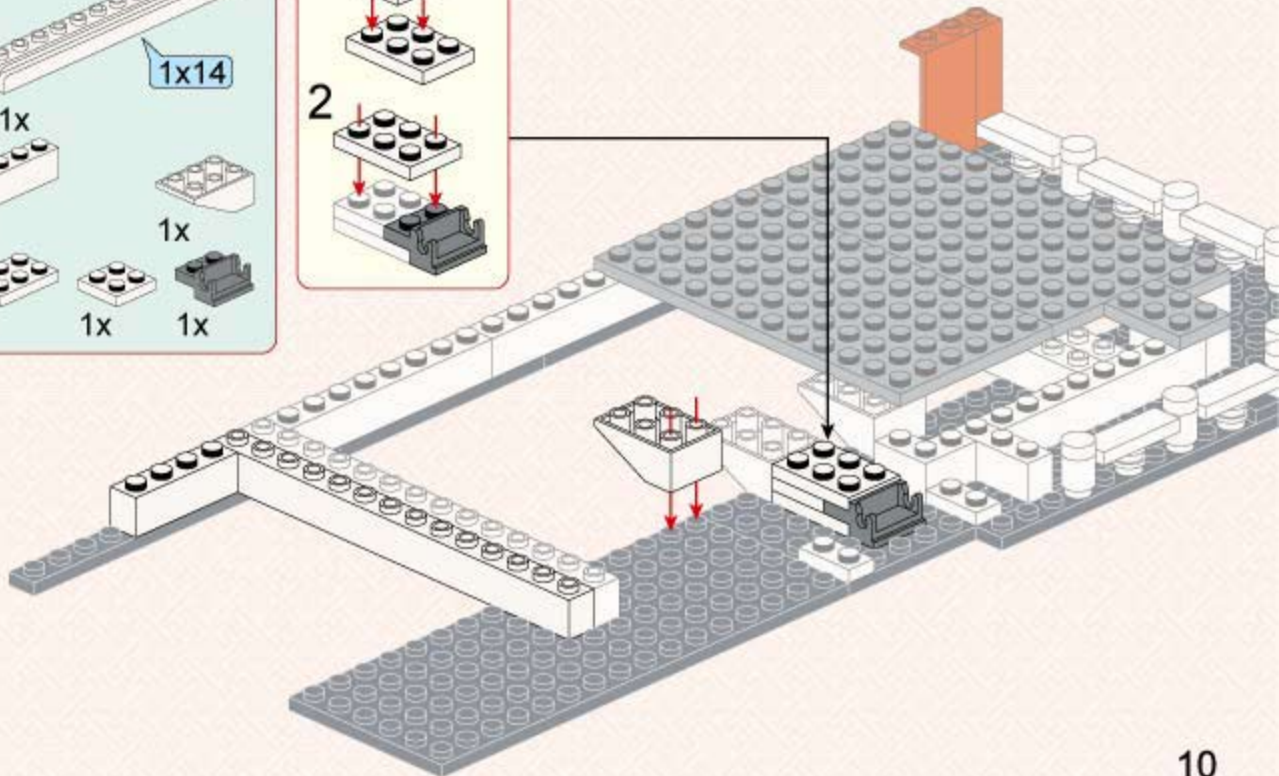
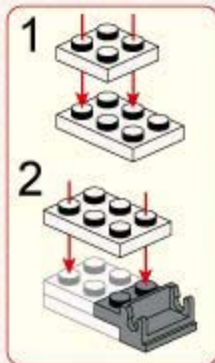
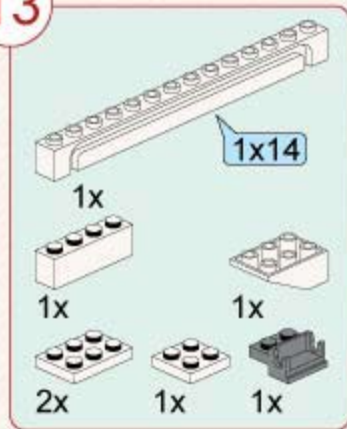

14

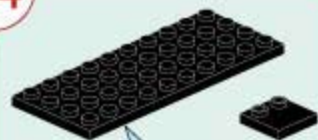

1x 4x10 1x



1x 1x12 1x



2x 4x12 1x

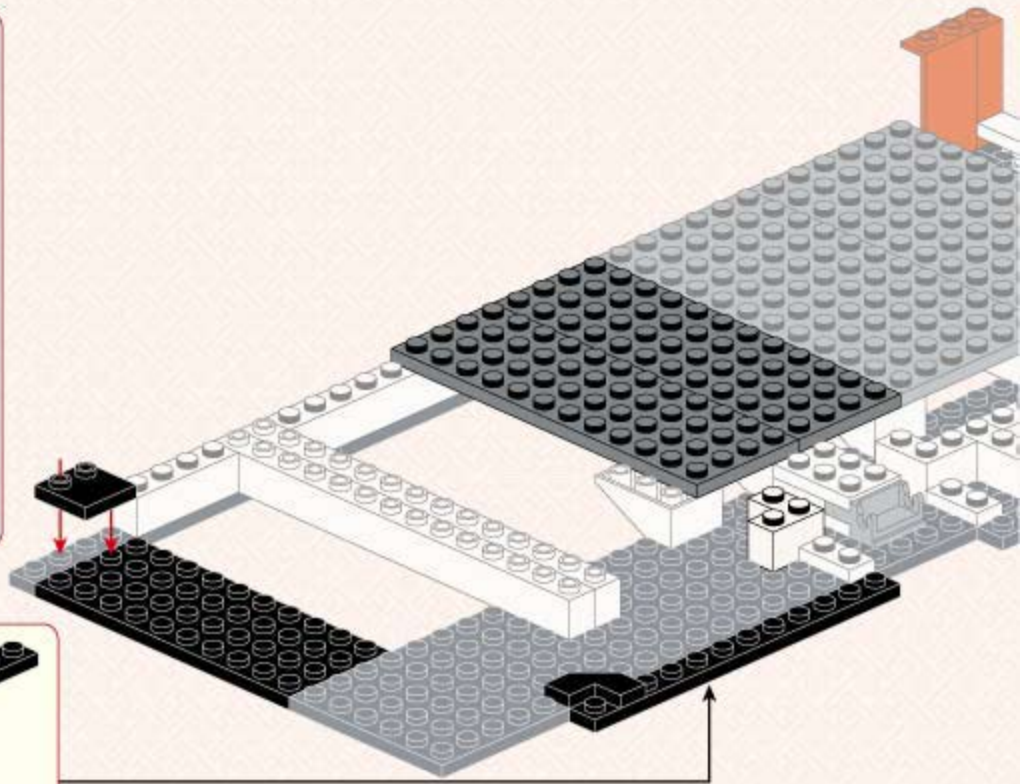

15

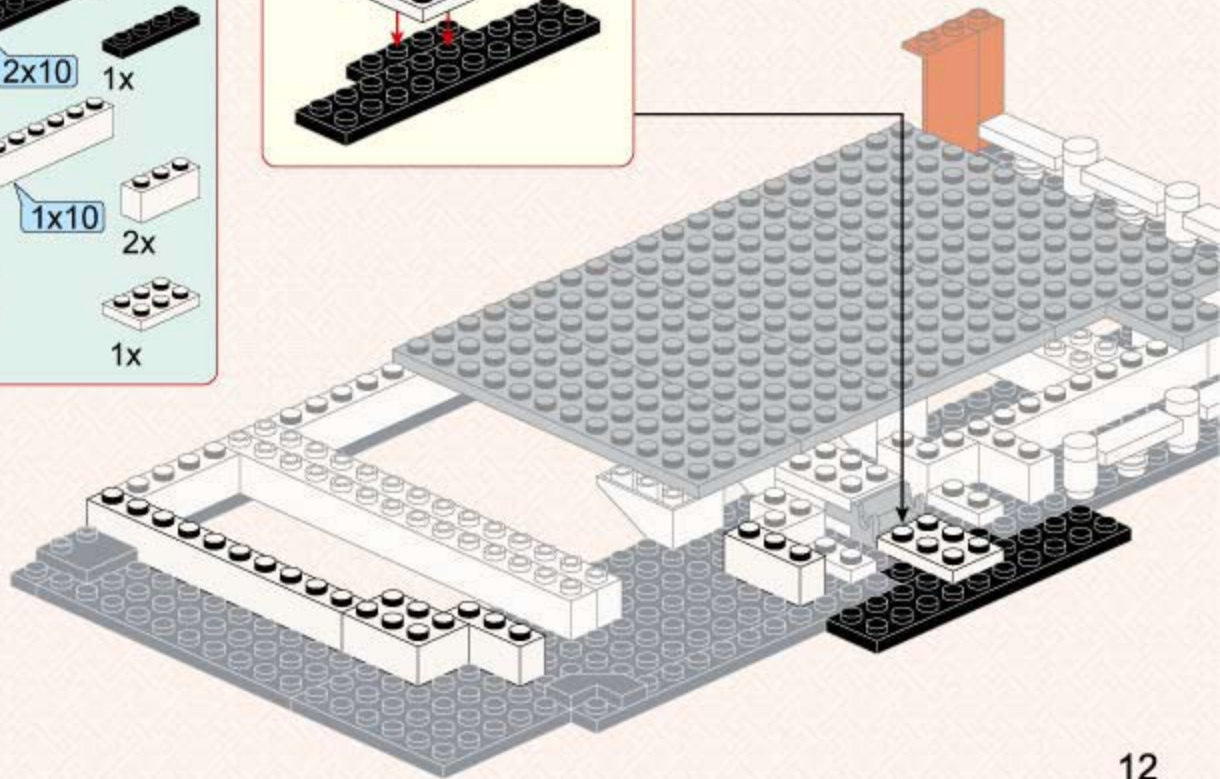
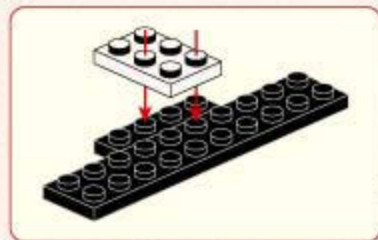
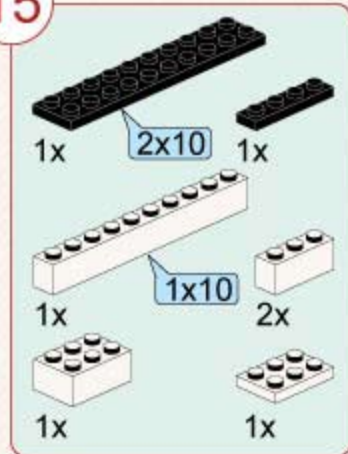

16



6x12

2x



1x8

1x



4x

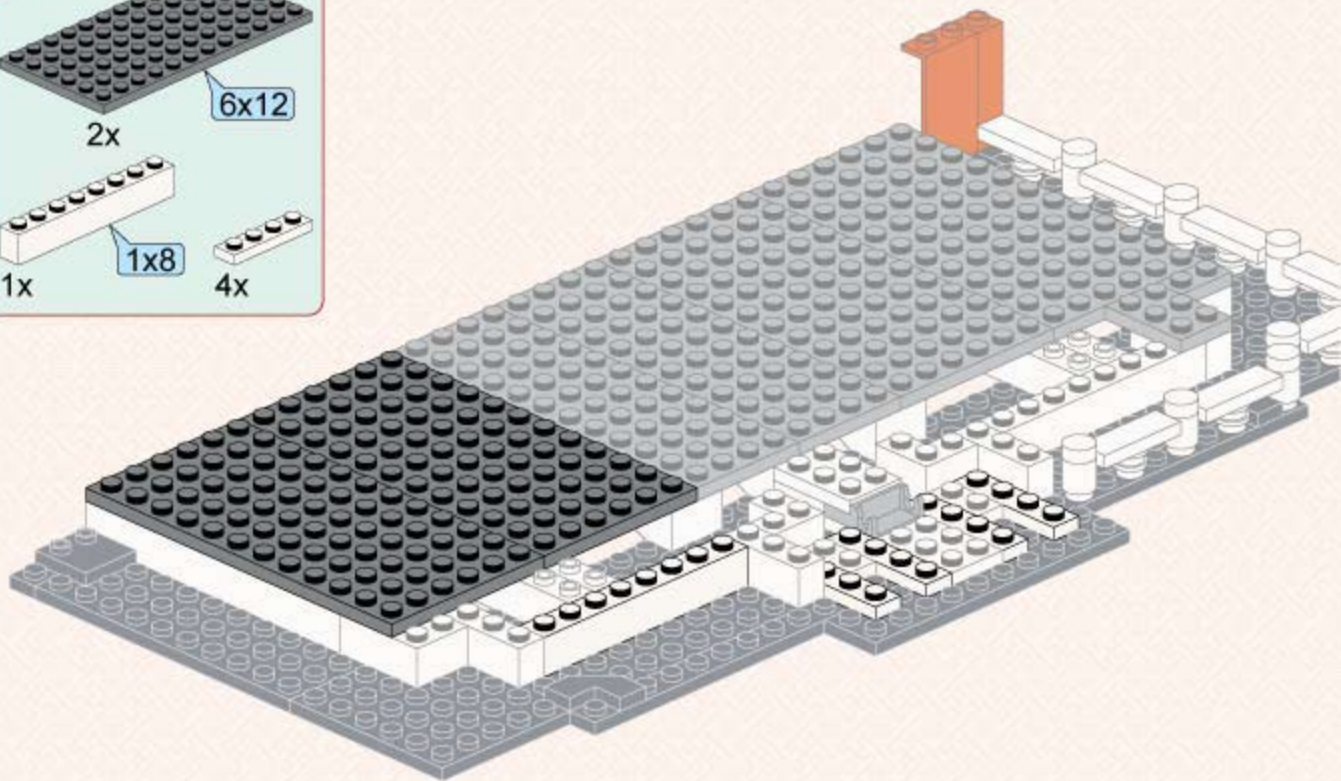

17



1x



1x



1x



2x



2x



14x



7x

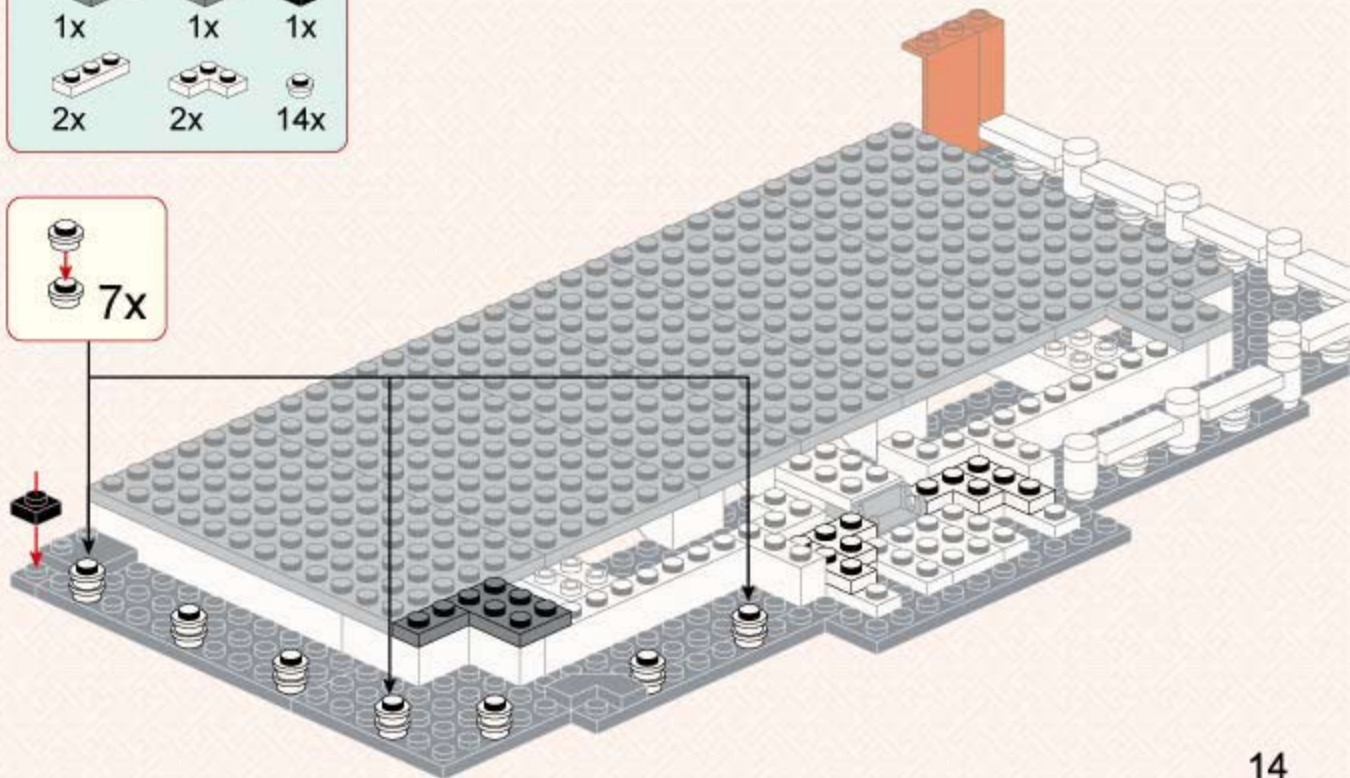

18



2x



8x



6x



8x

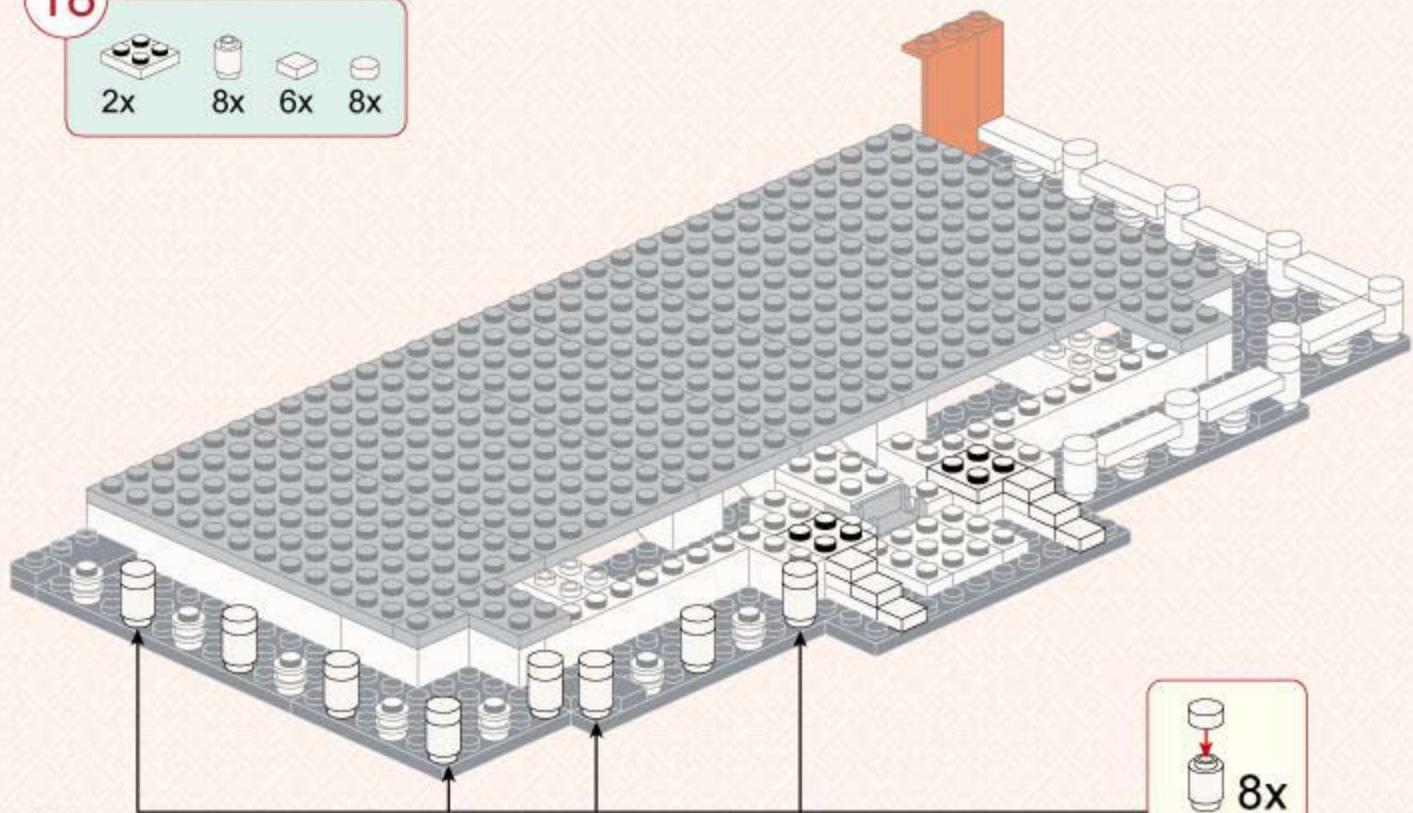

8x

15



19



4x



7x

1x3

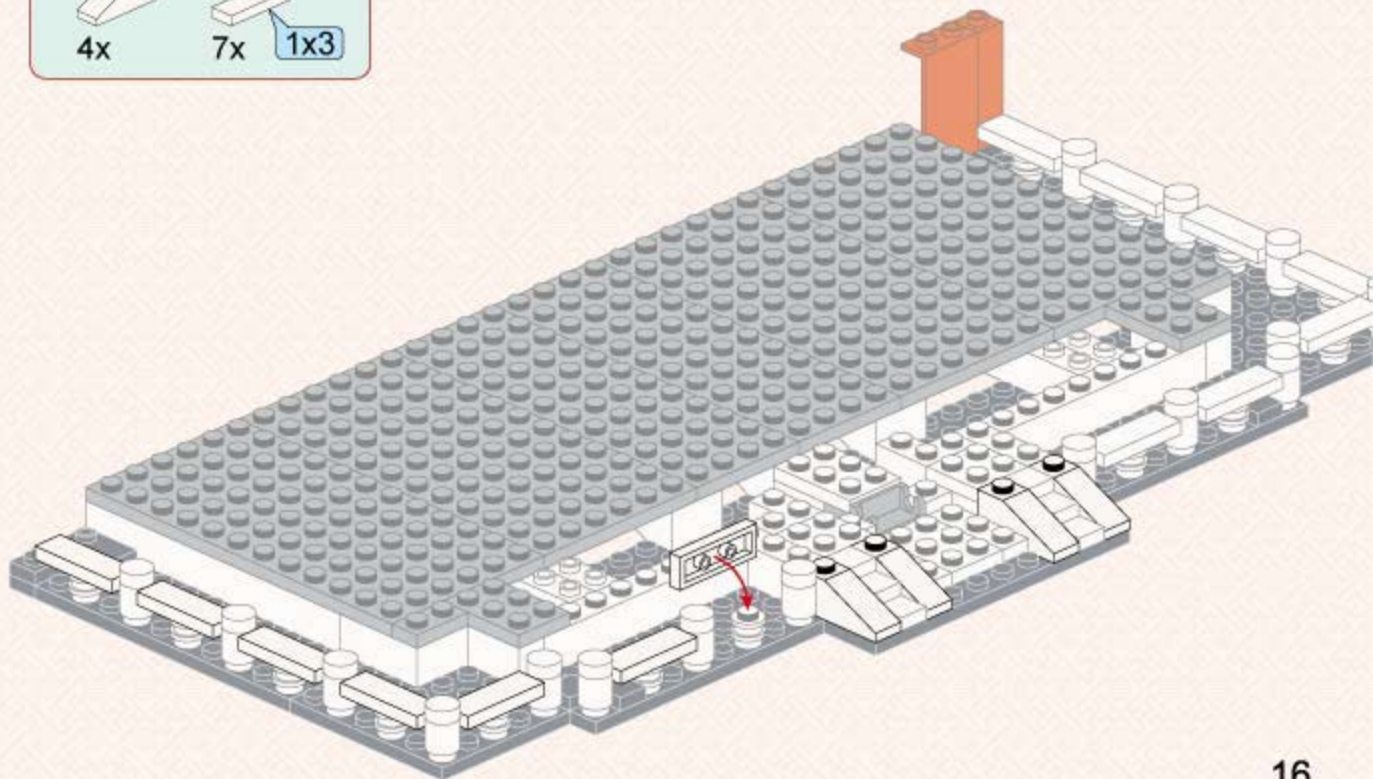



2

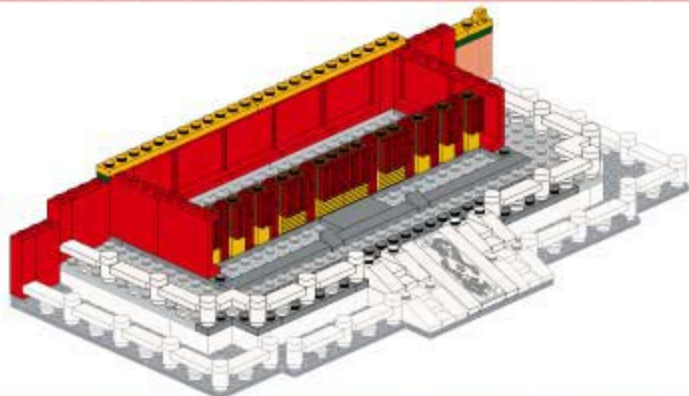

20

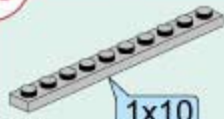

1x

1x10



6x



1x



1x



1x

1



2

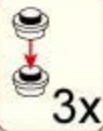

3x

21

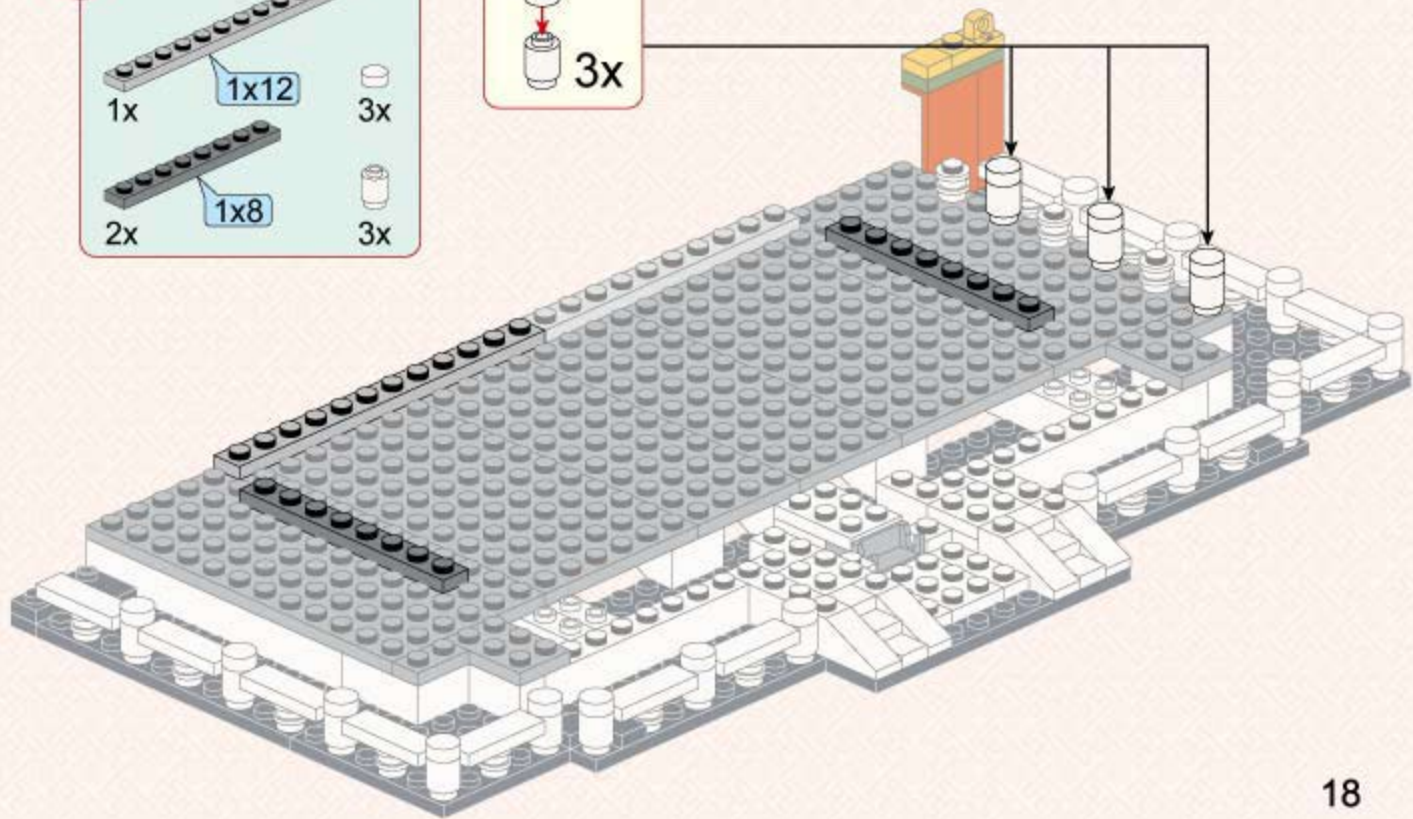
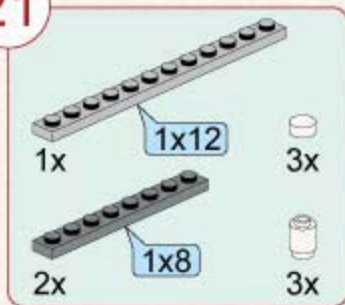

22

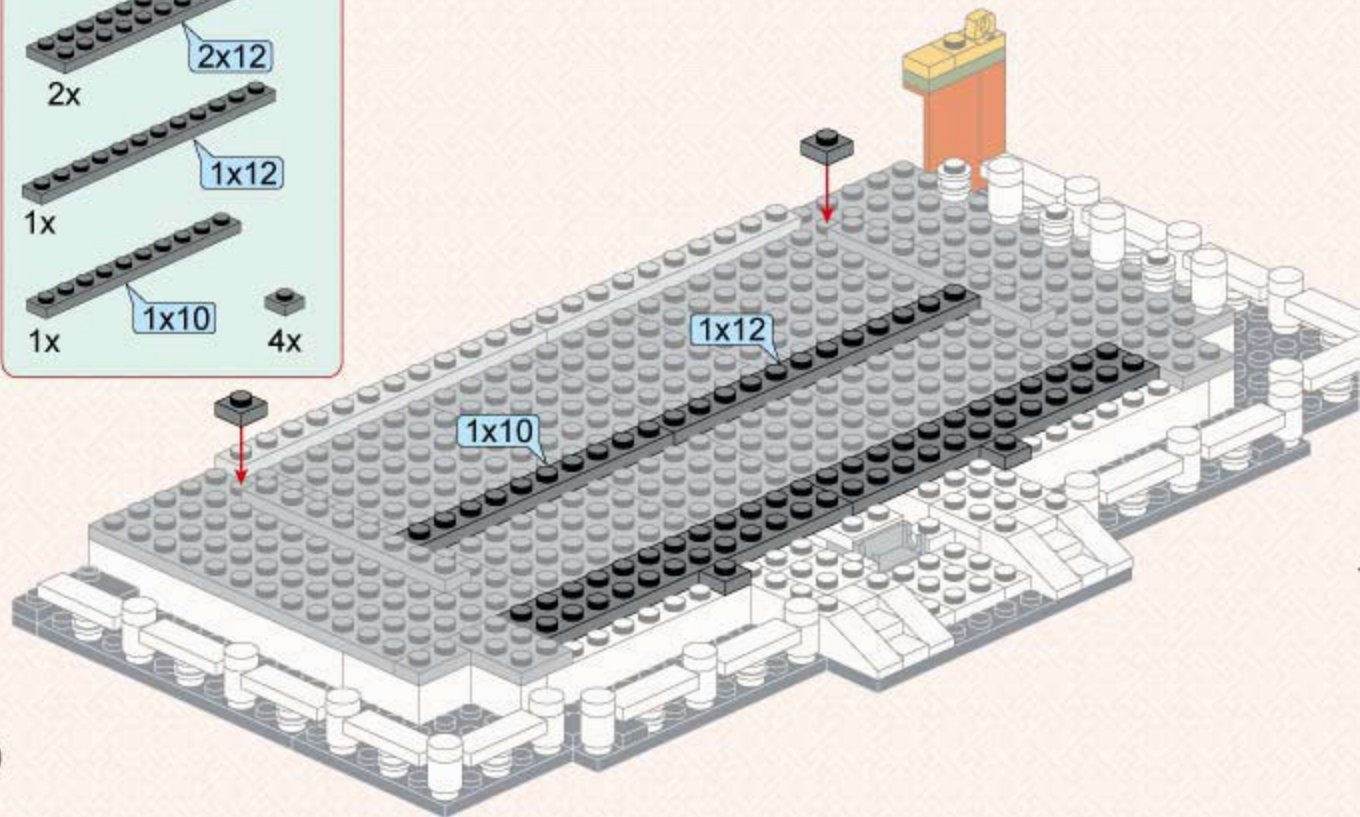
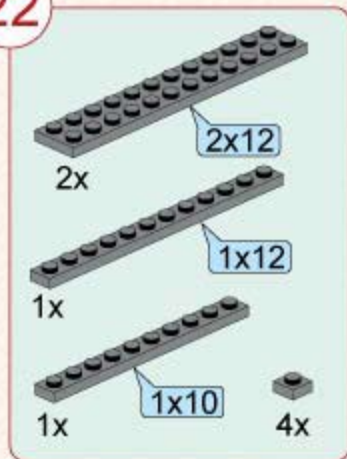

23

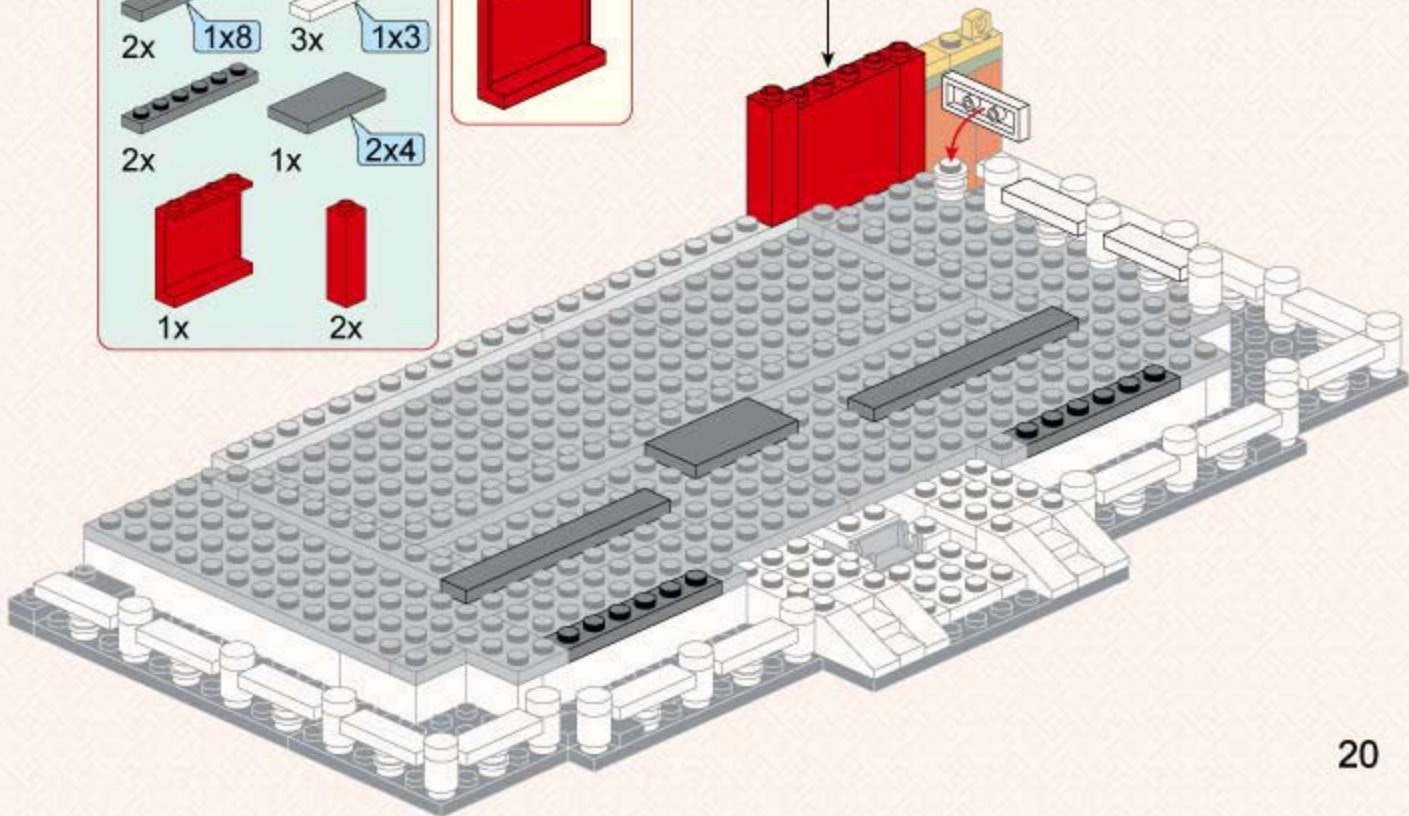
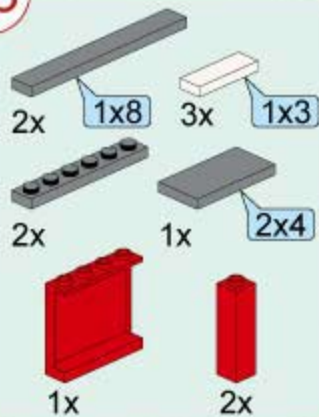

24



6x



1x

1x6



2x



2x



18x



1x



6x



3x

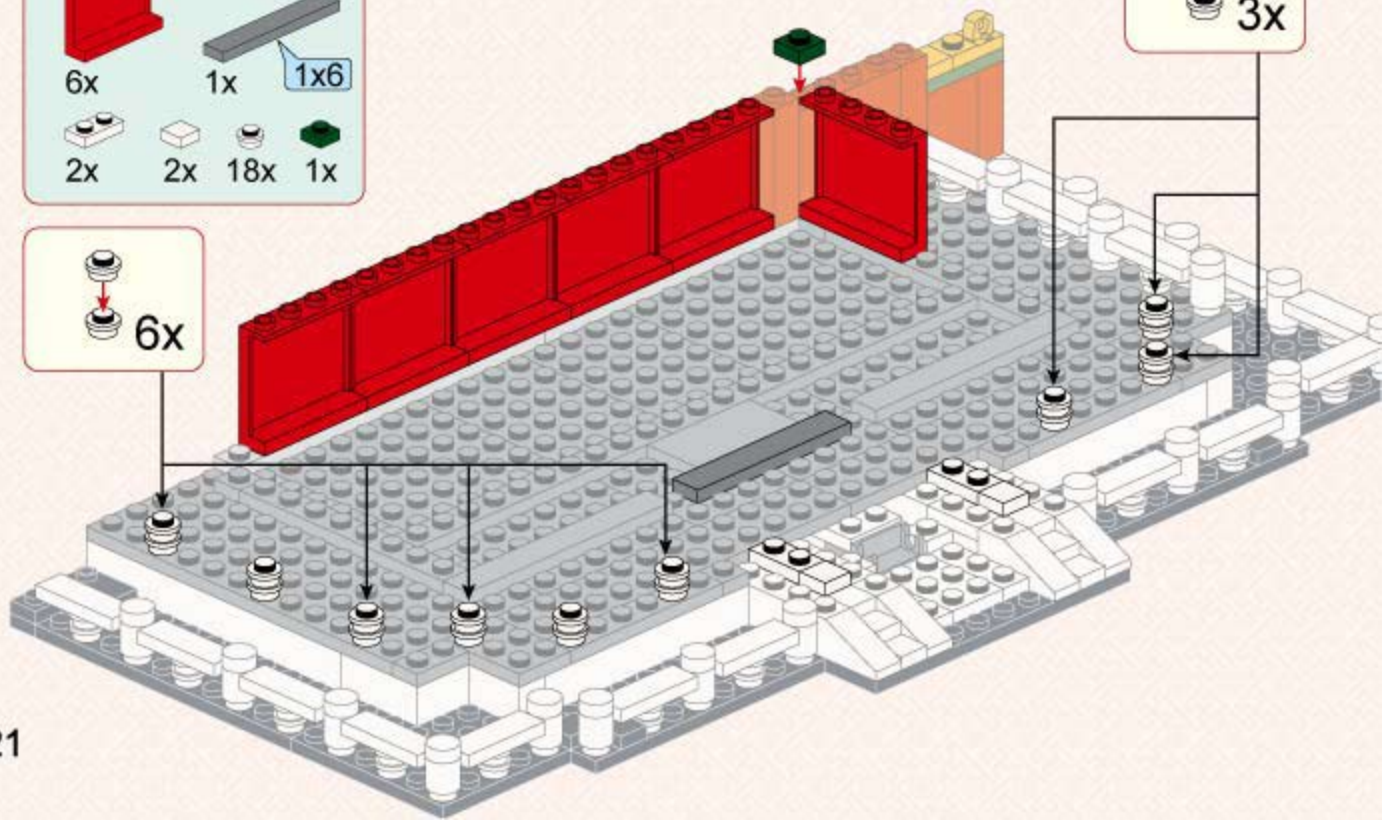

25



1x



4x



6x



1x



1x

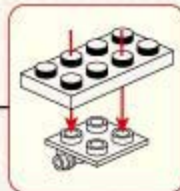
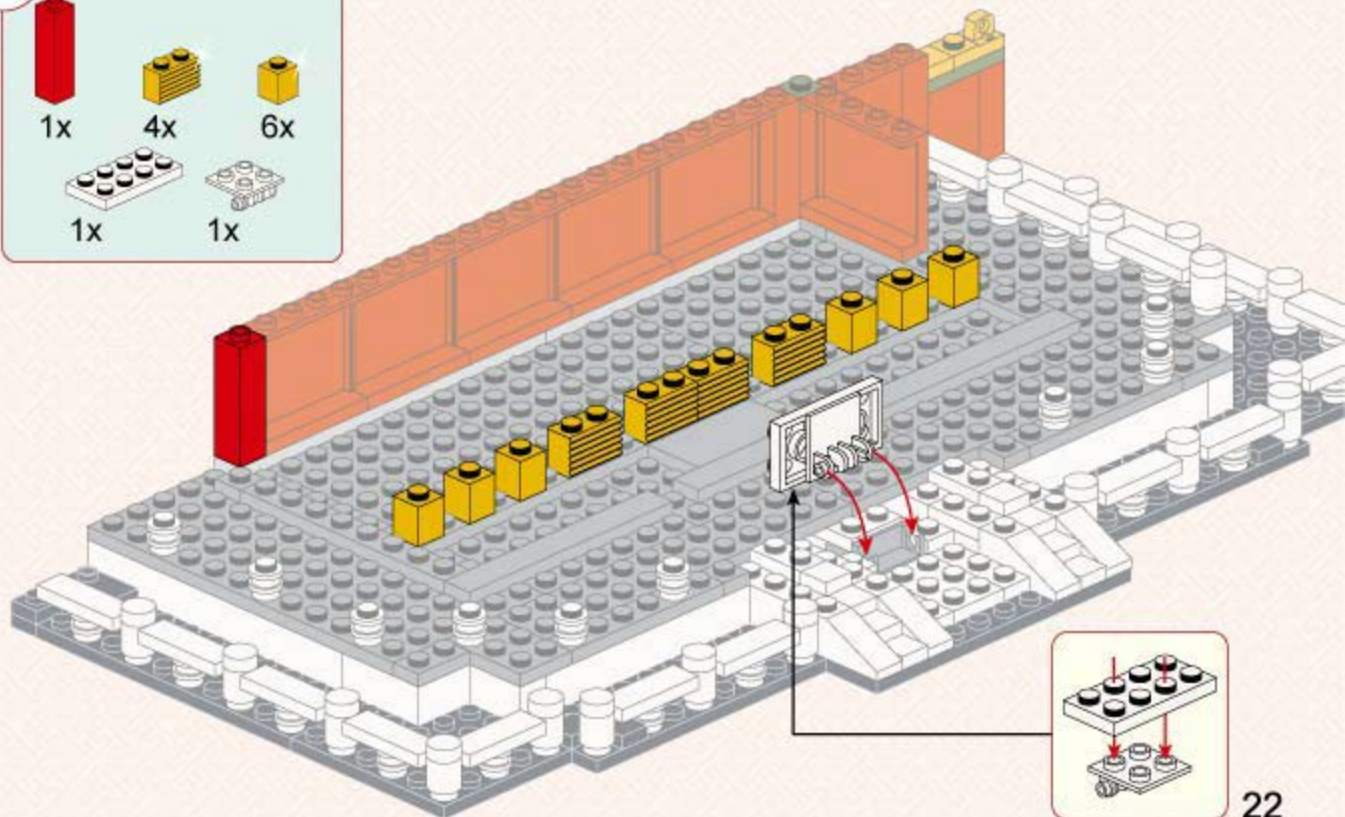

22

26



1x



2x



9x



2x



9x



3x

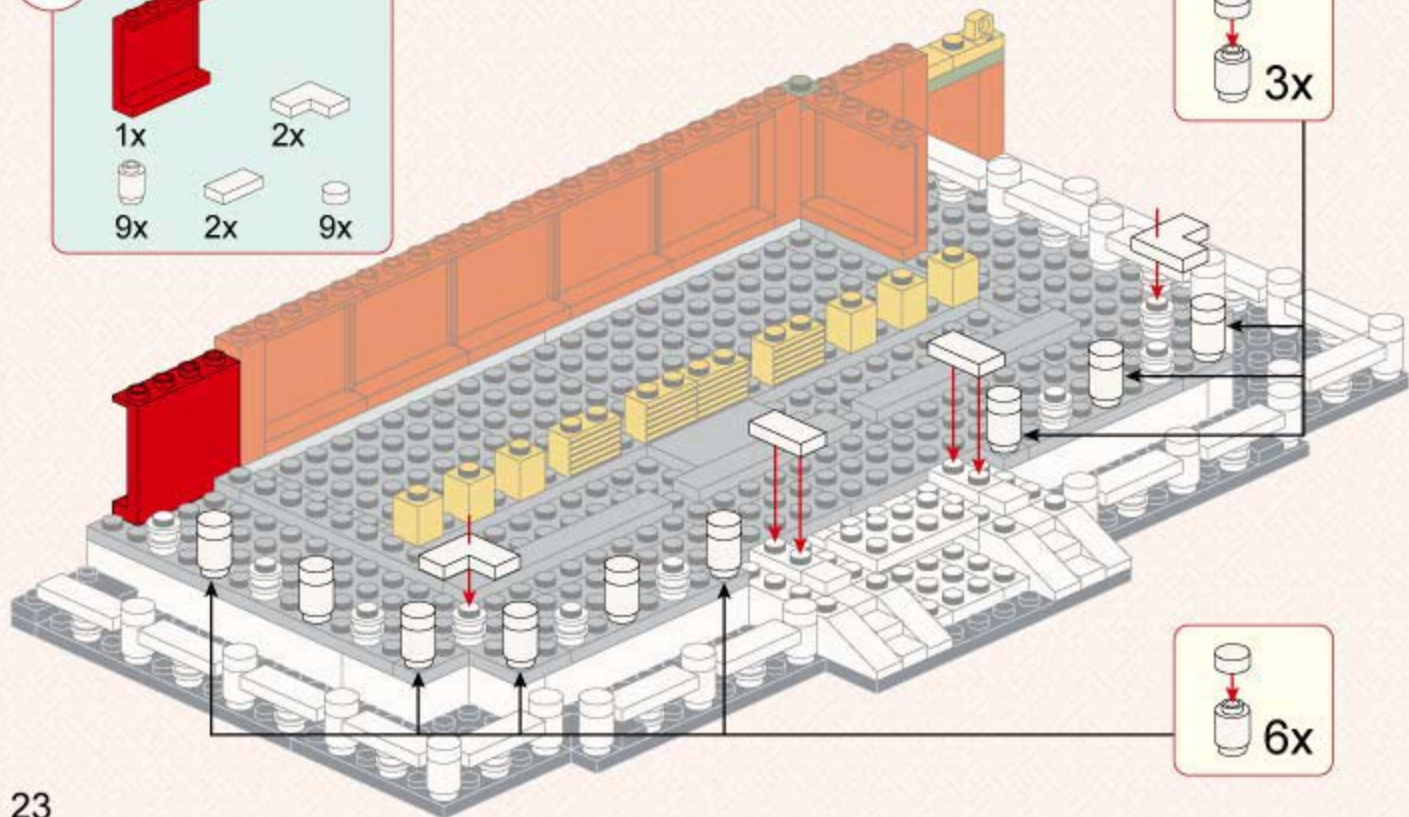

6x



27



1x 8x 8x 8x



7x 1x3 2x 1x

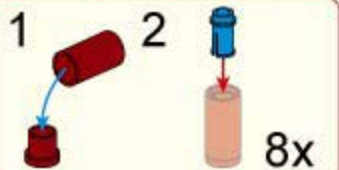

1

2

8x

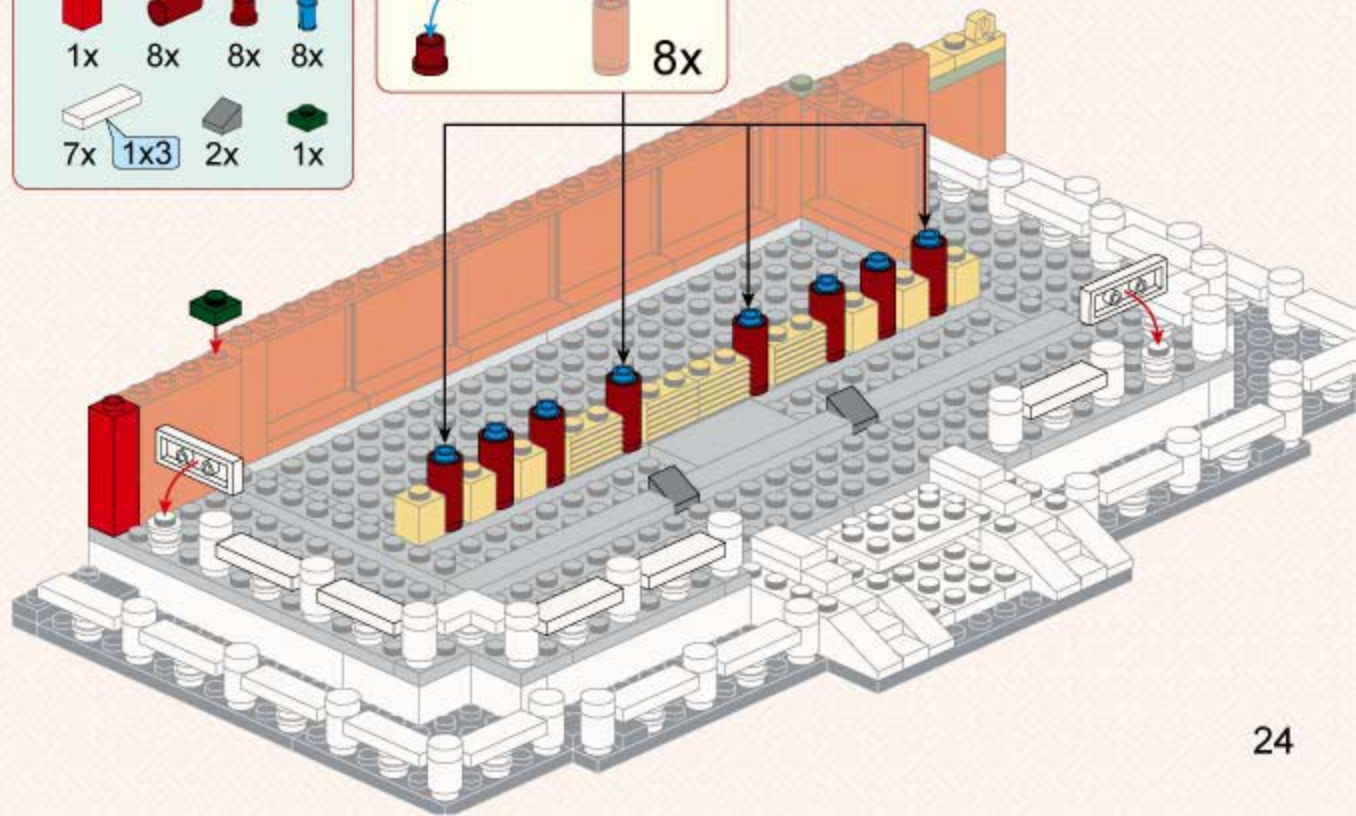

28

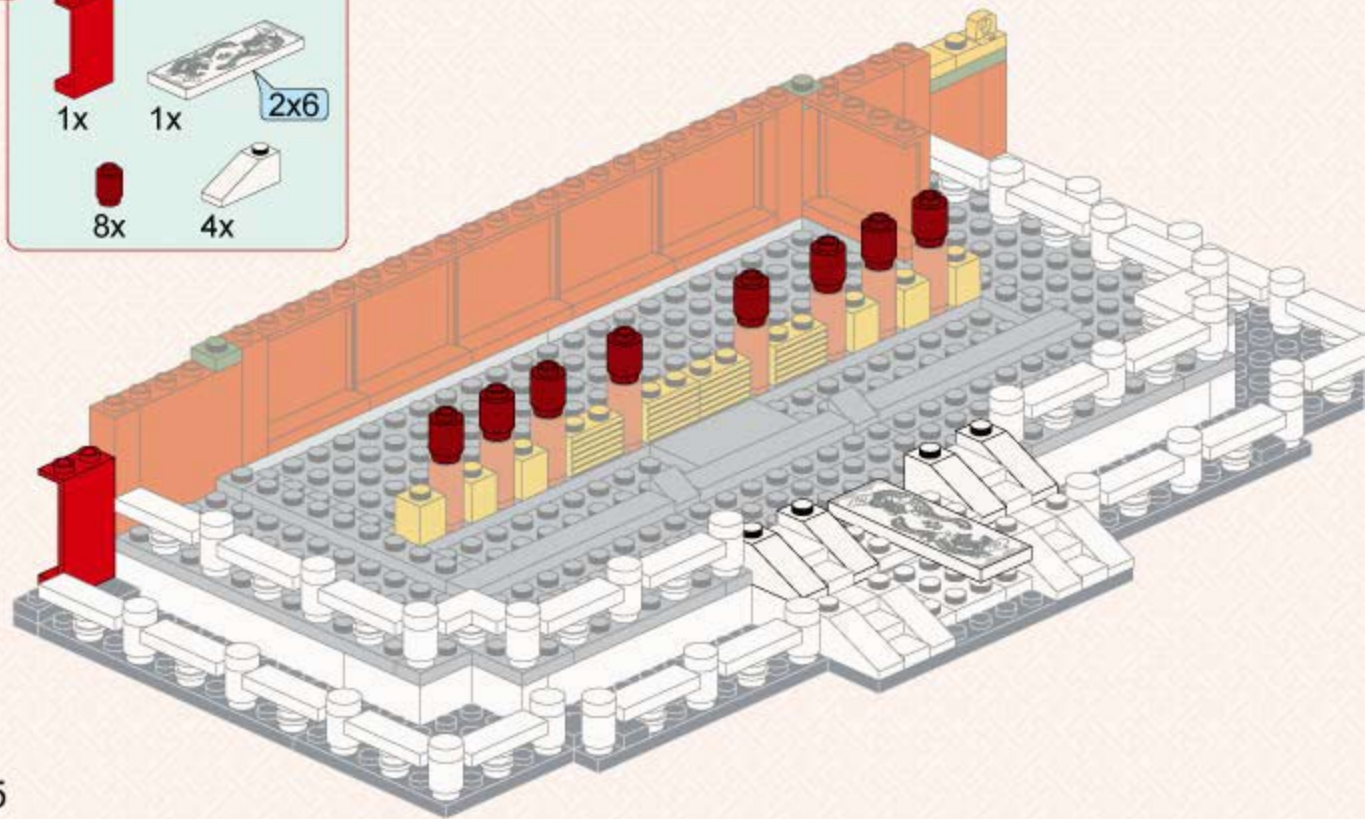
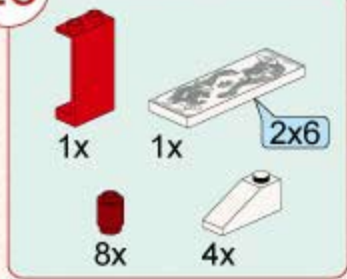

29

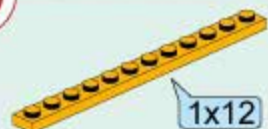

2x



2x



6x



6x

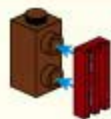

3x

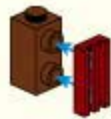
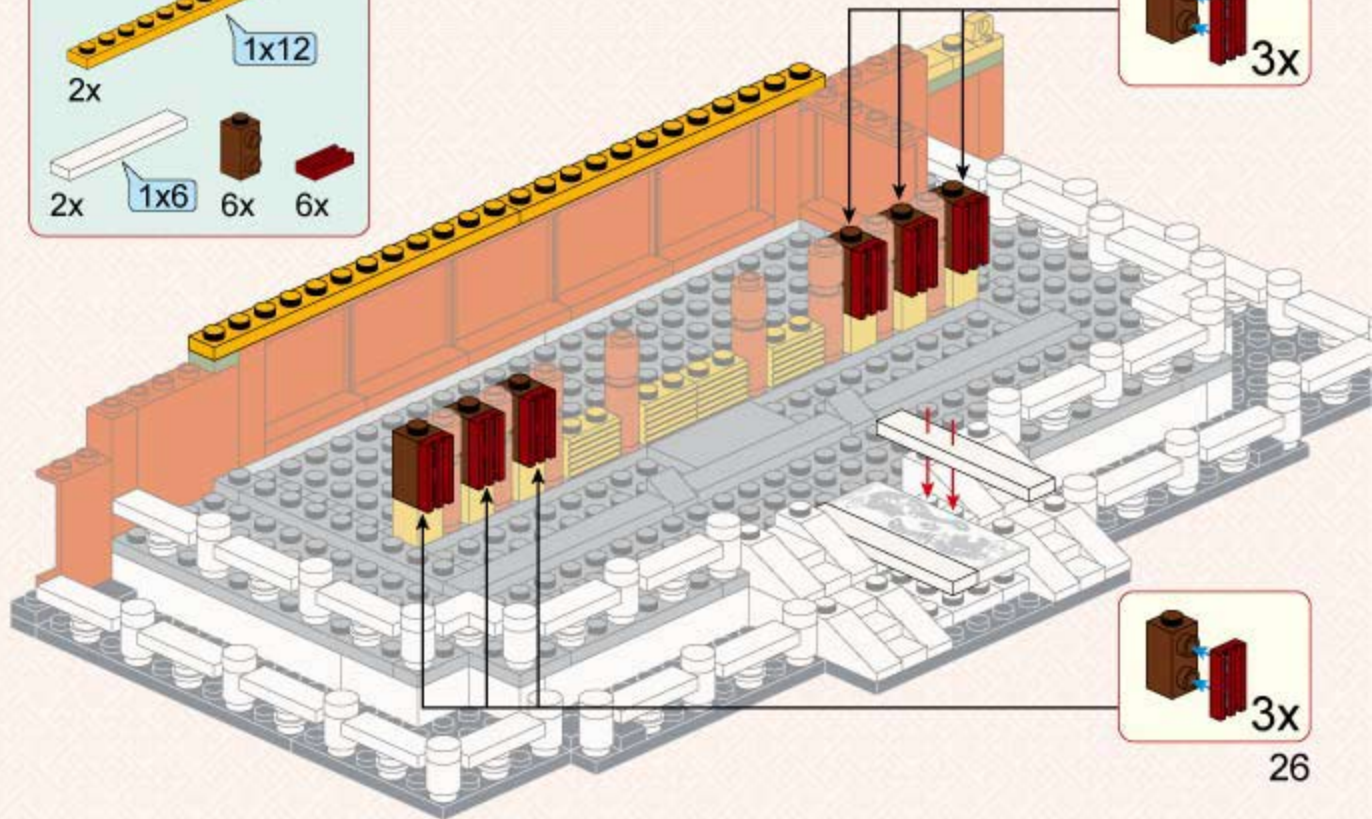

3x

26

30



3x



1x



4x



8x

1

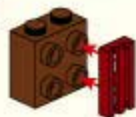

2

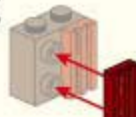

4x

27

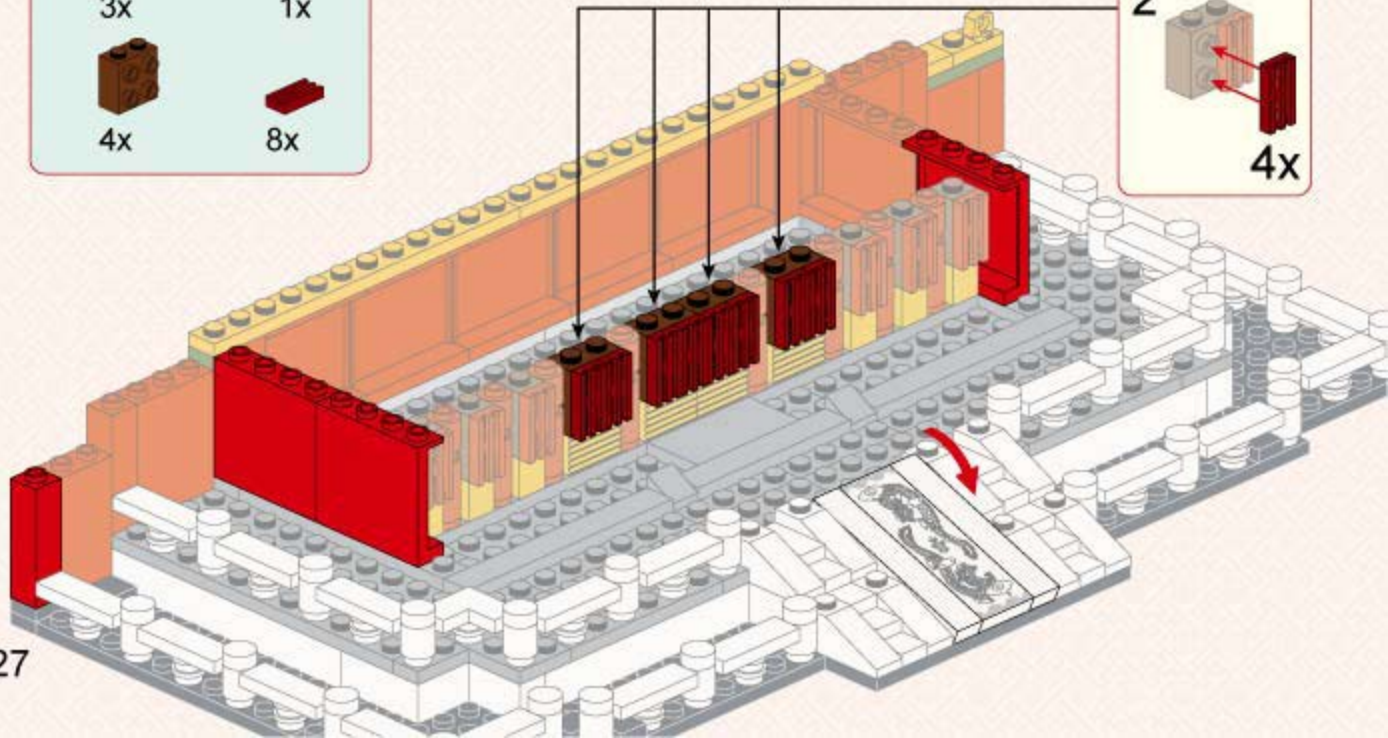

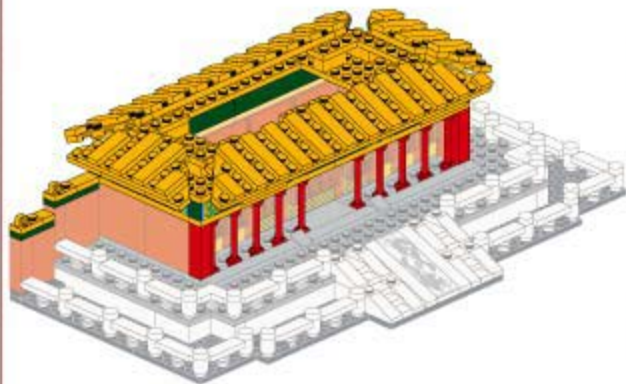

31

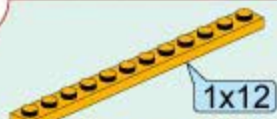

1x

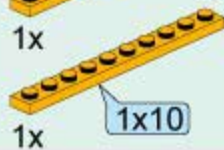

1x

10x

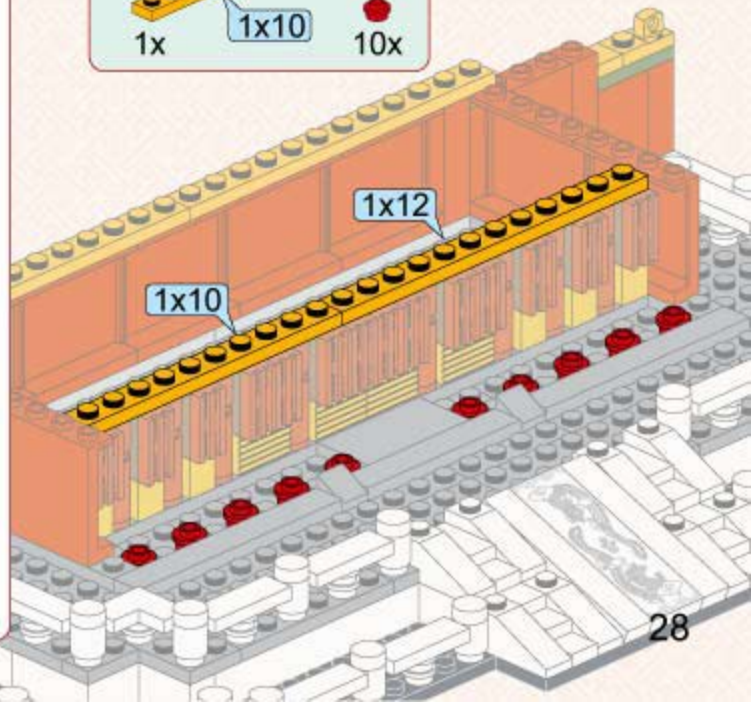

32



10x

④



10x



1x



1x



1x



10x

1

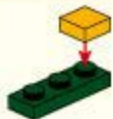

2

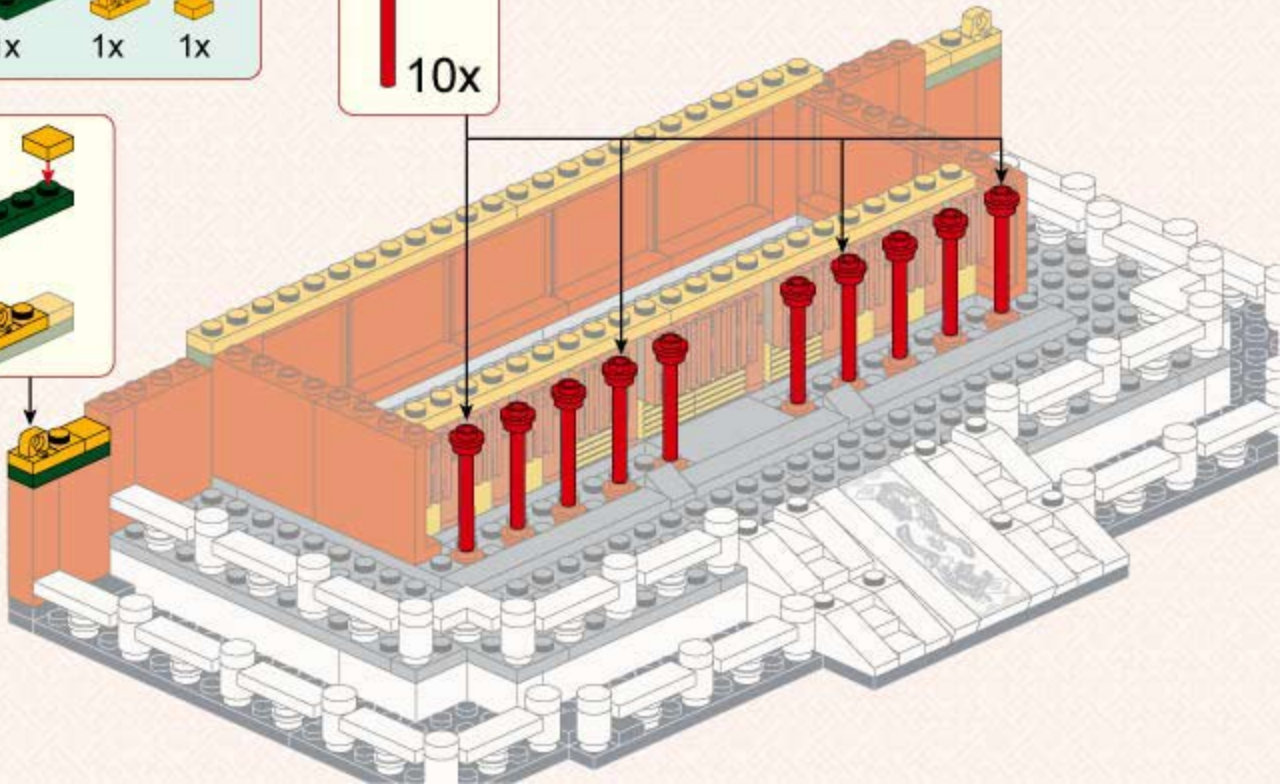

33



2x



2x



2x



2x

1

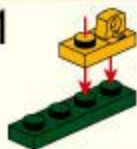

2

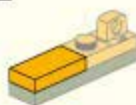

1

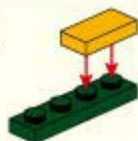

2

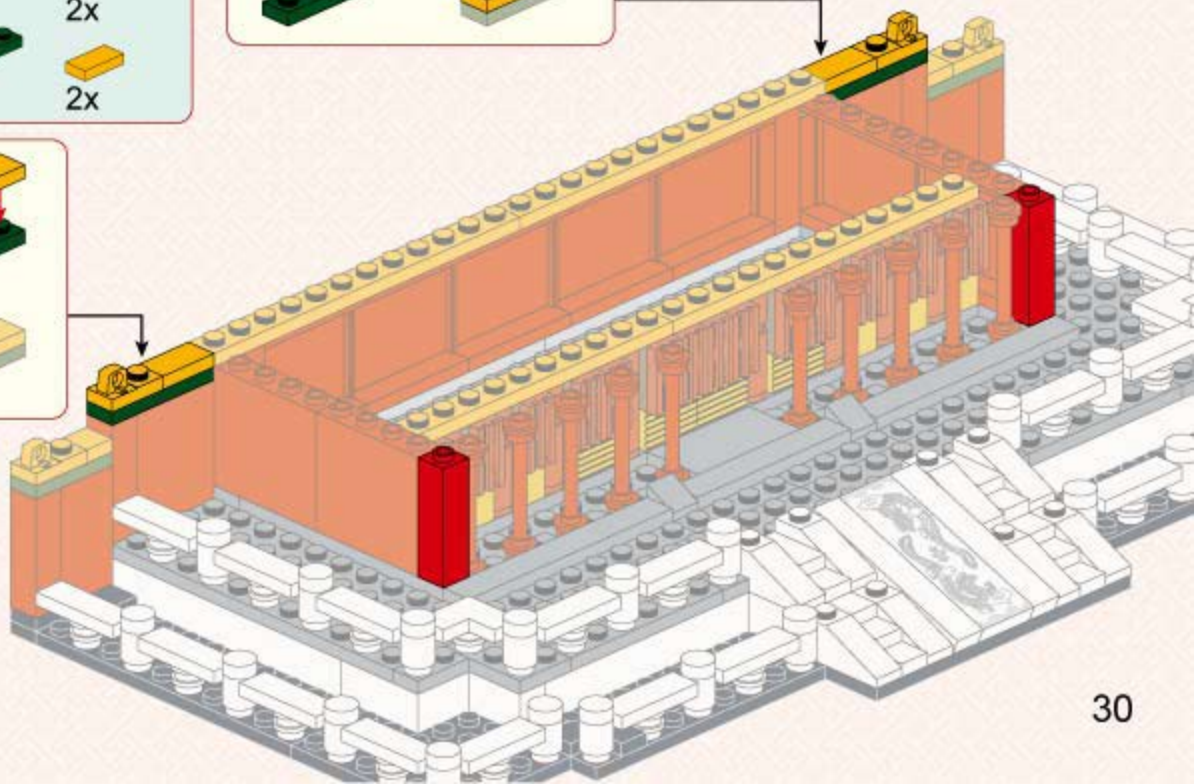

34

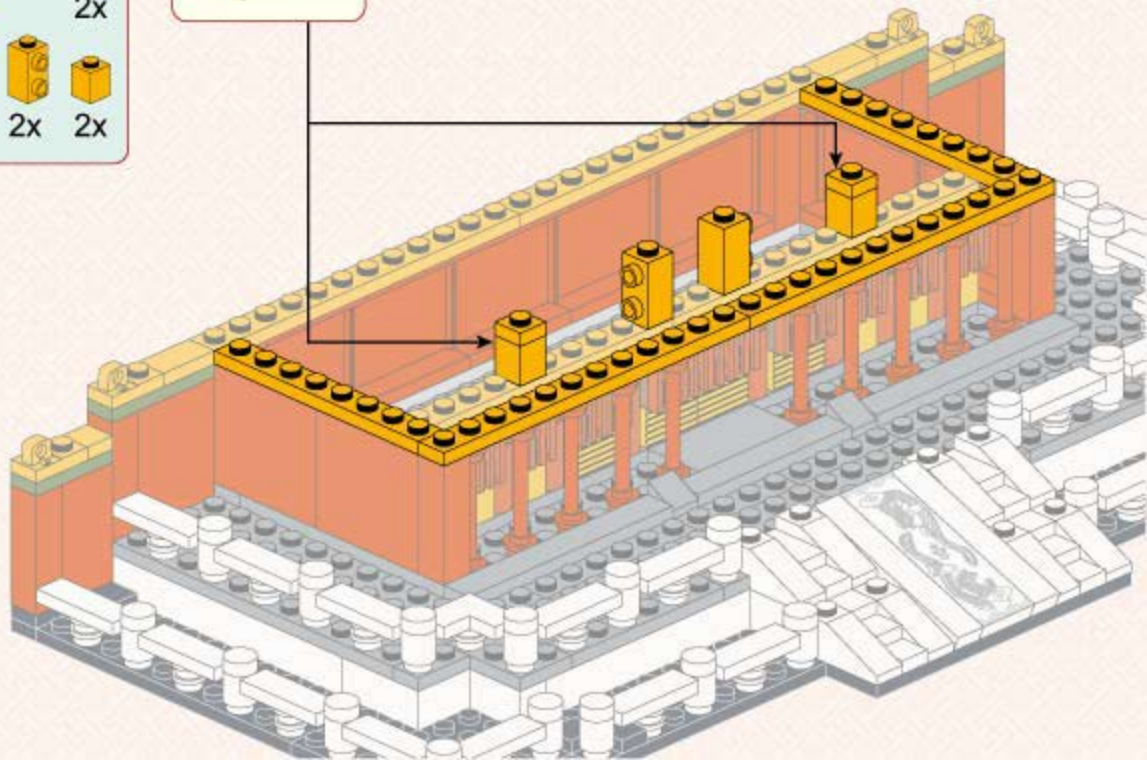
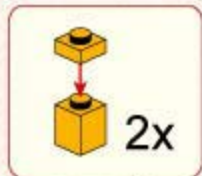
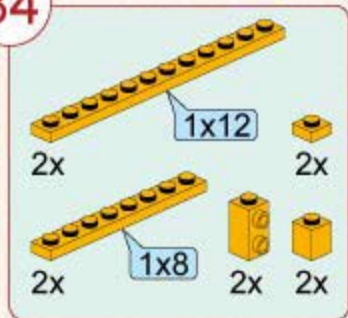



35

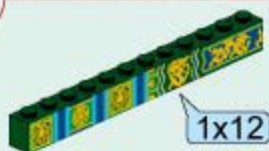

1x

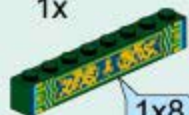

2x



1x

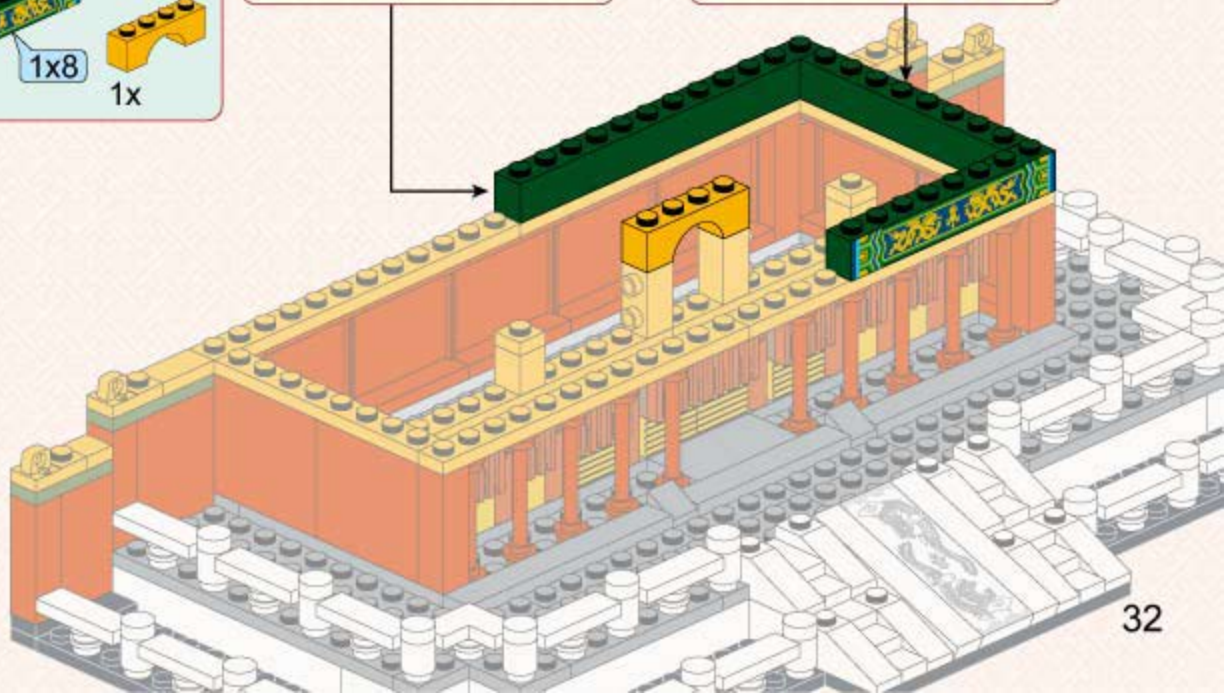

32

36

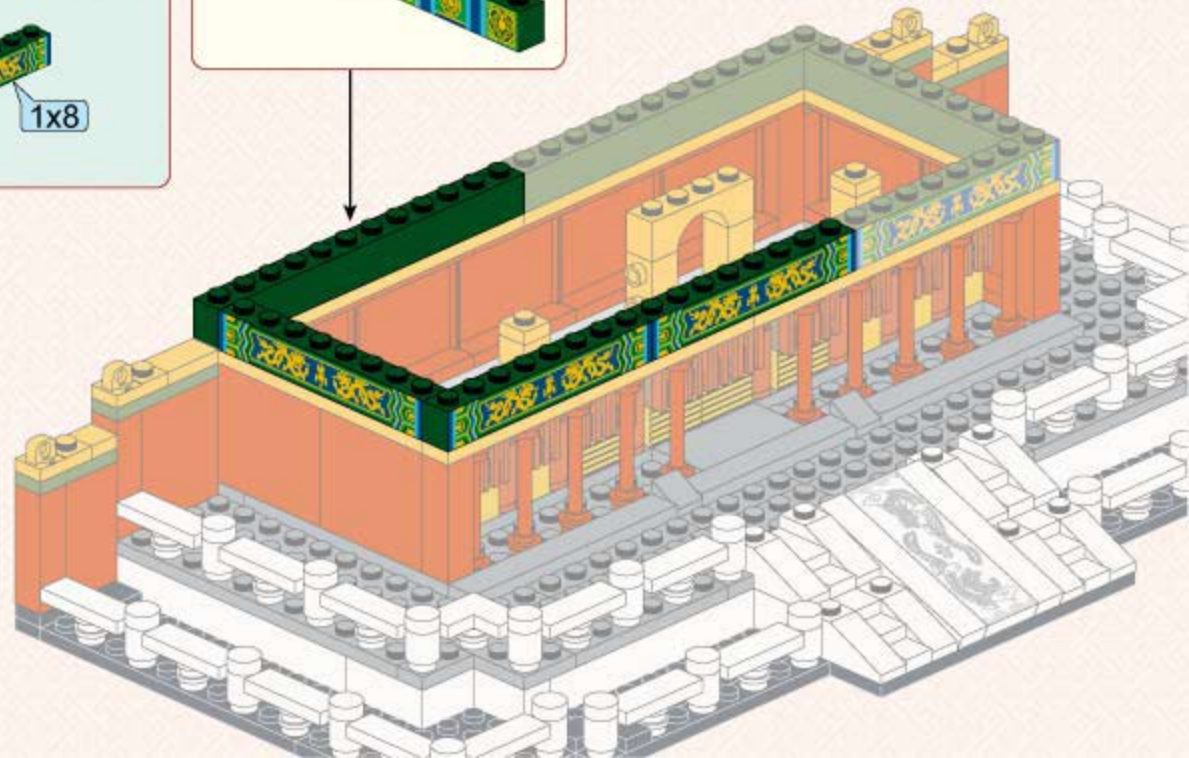
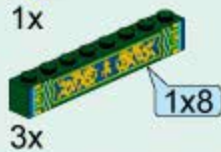
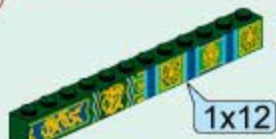

37



2x

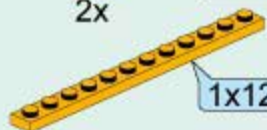

2x



8x

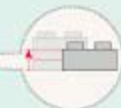

1:1

1

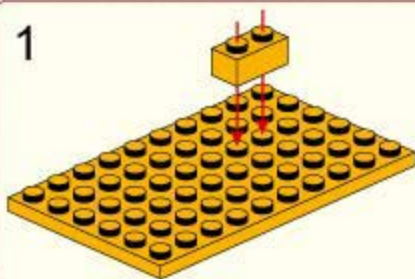

2

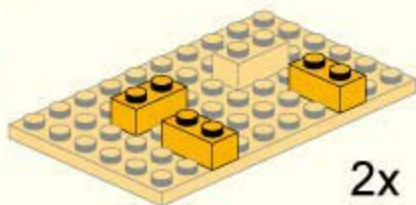

2x

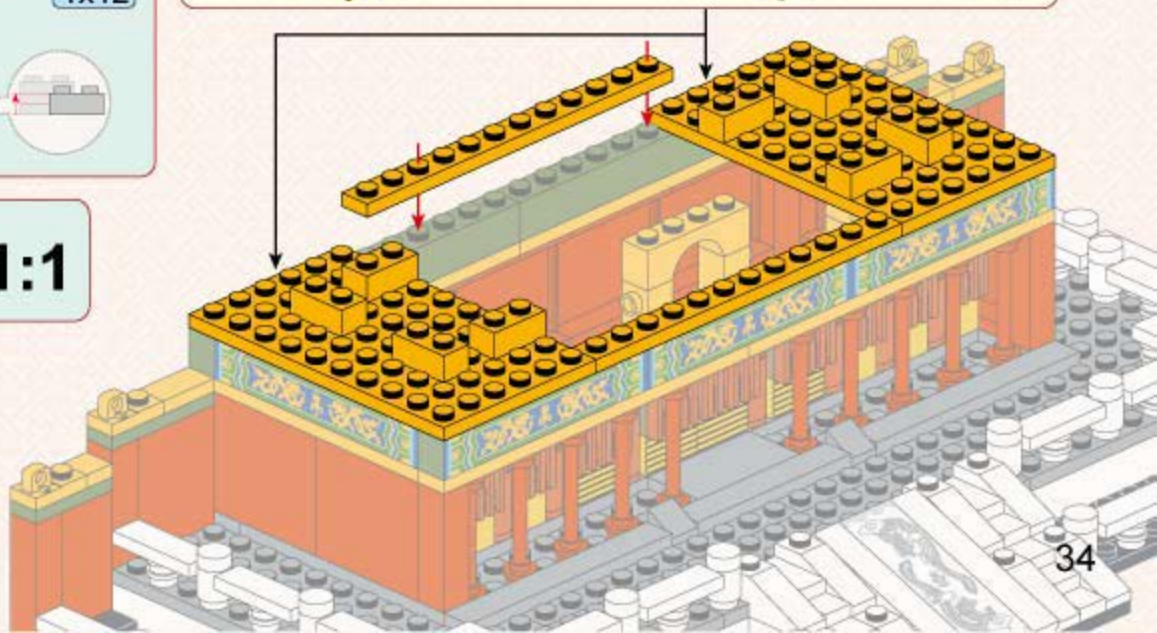

38

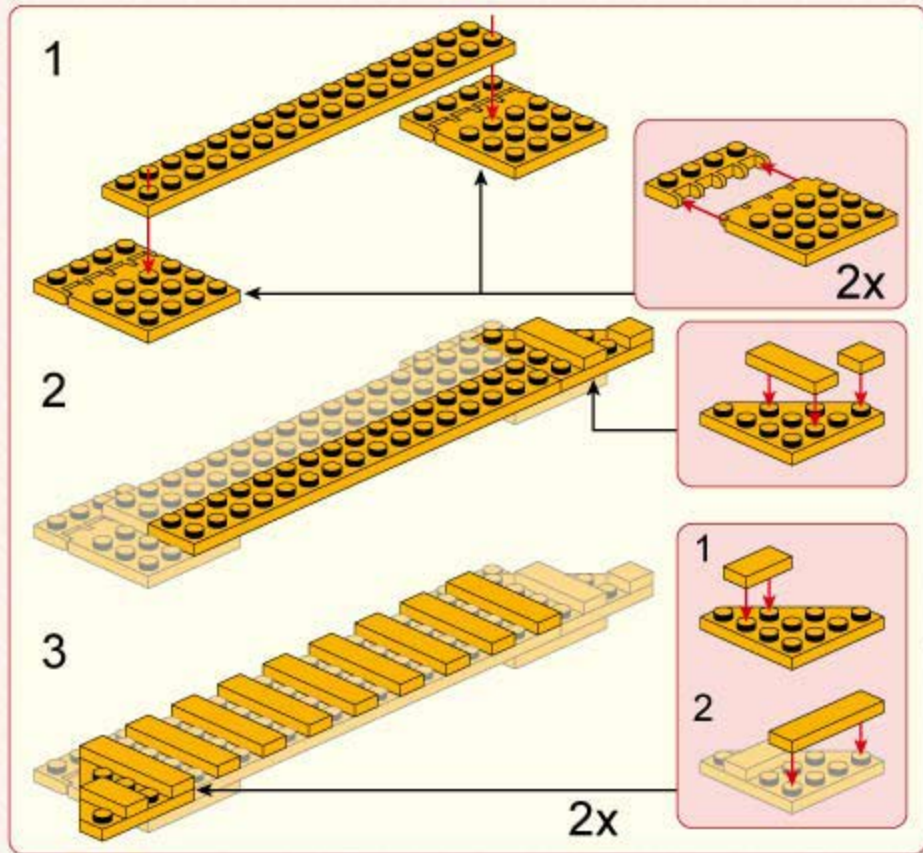
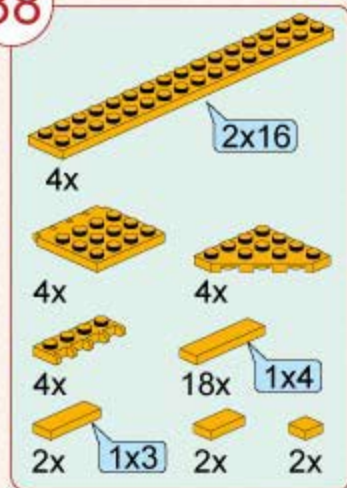

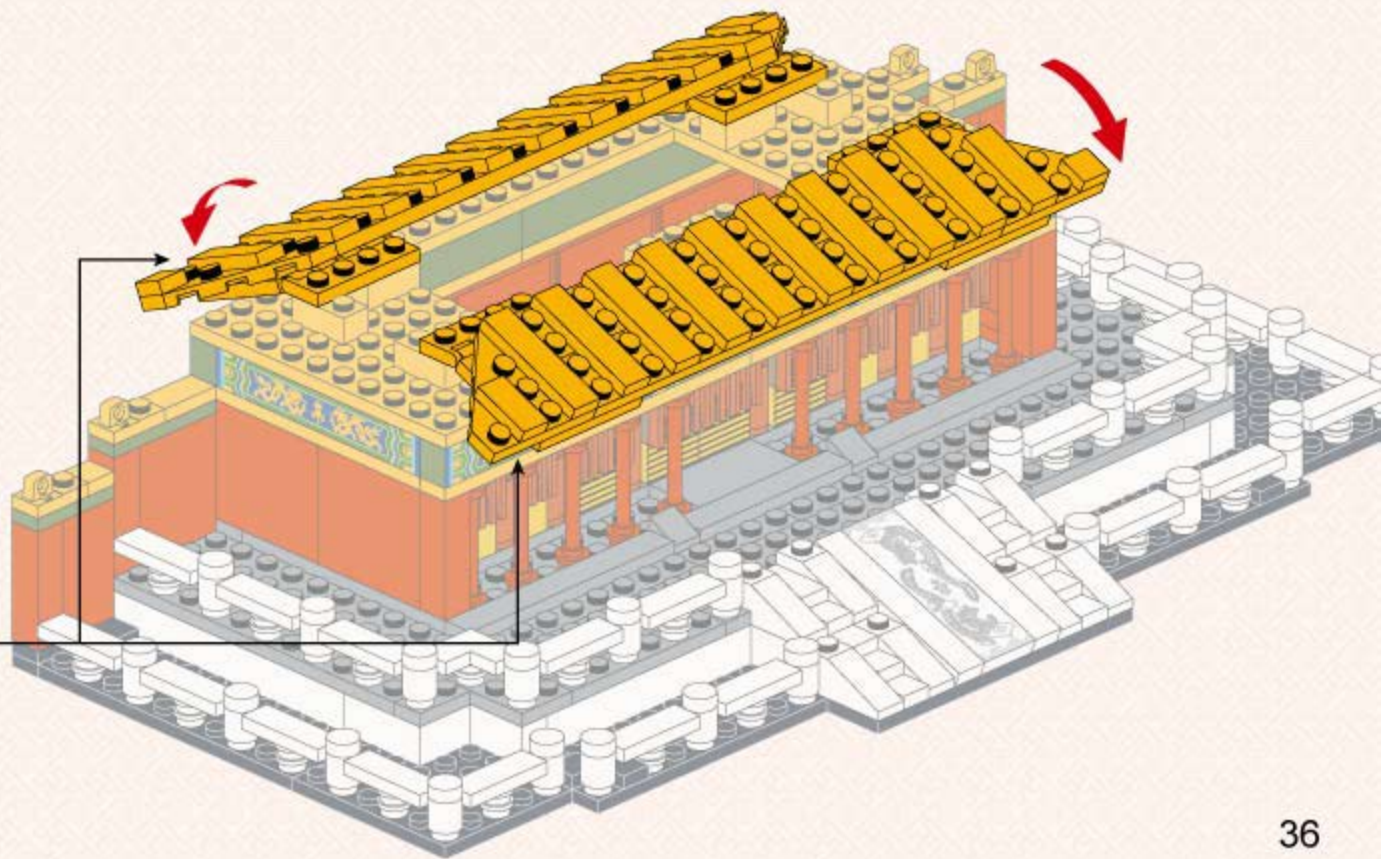

39

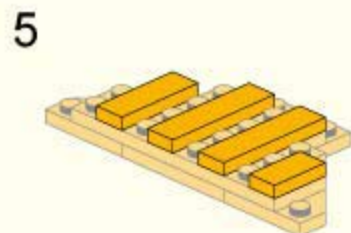
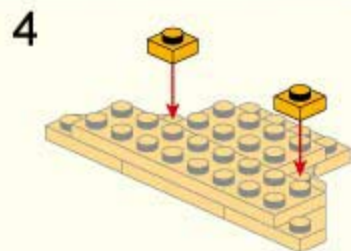
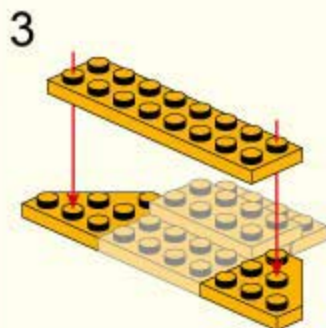
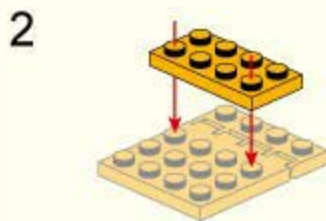
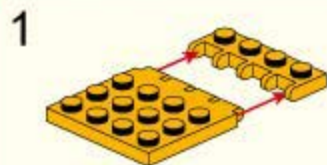
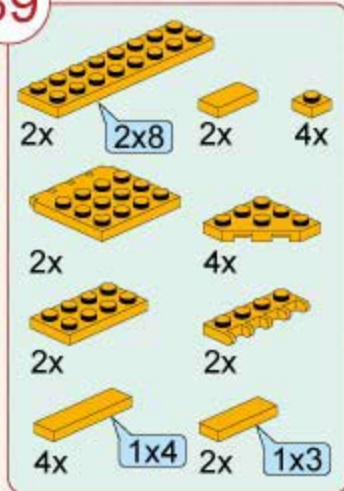

2x

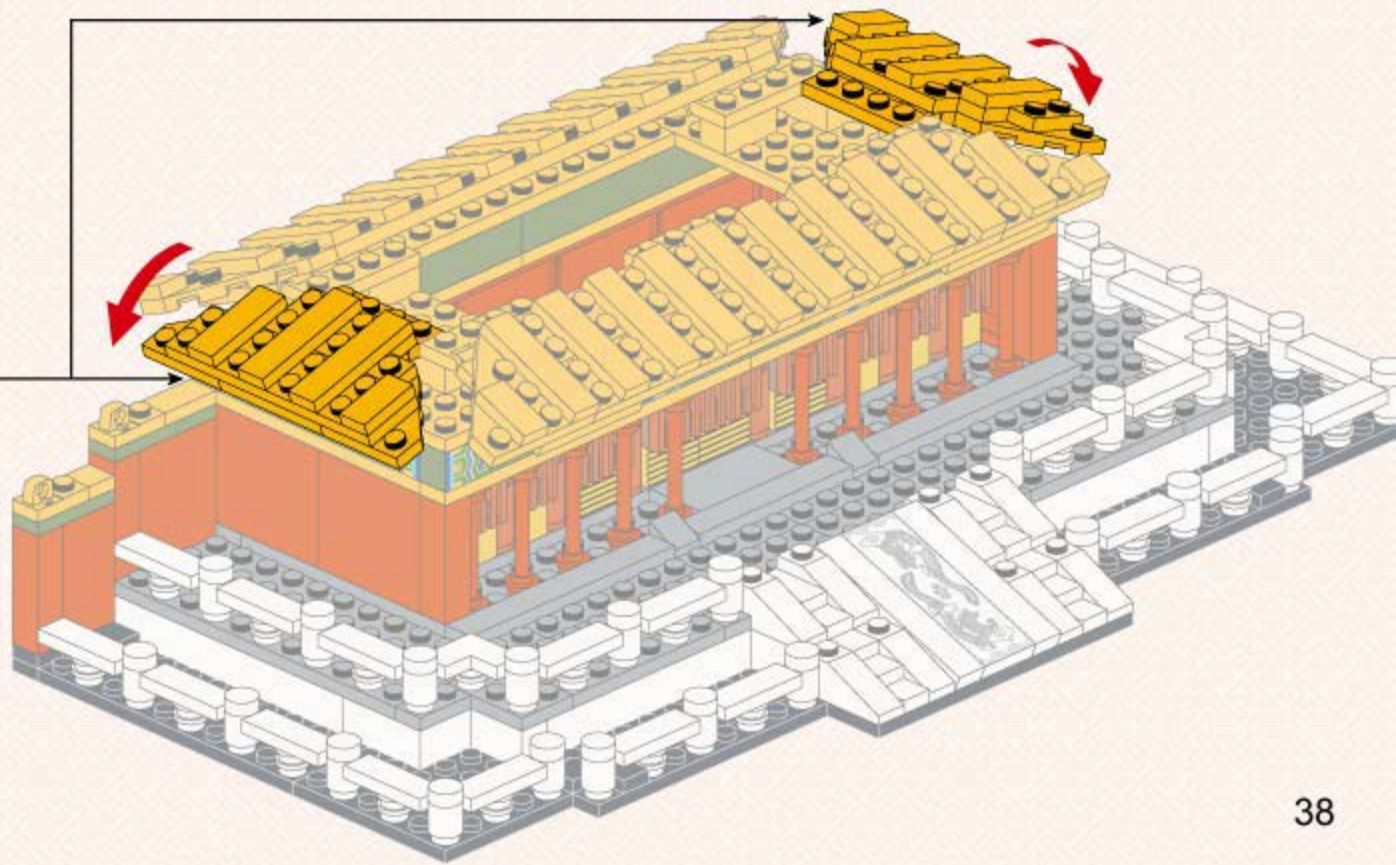



40



1x



2x

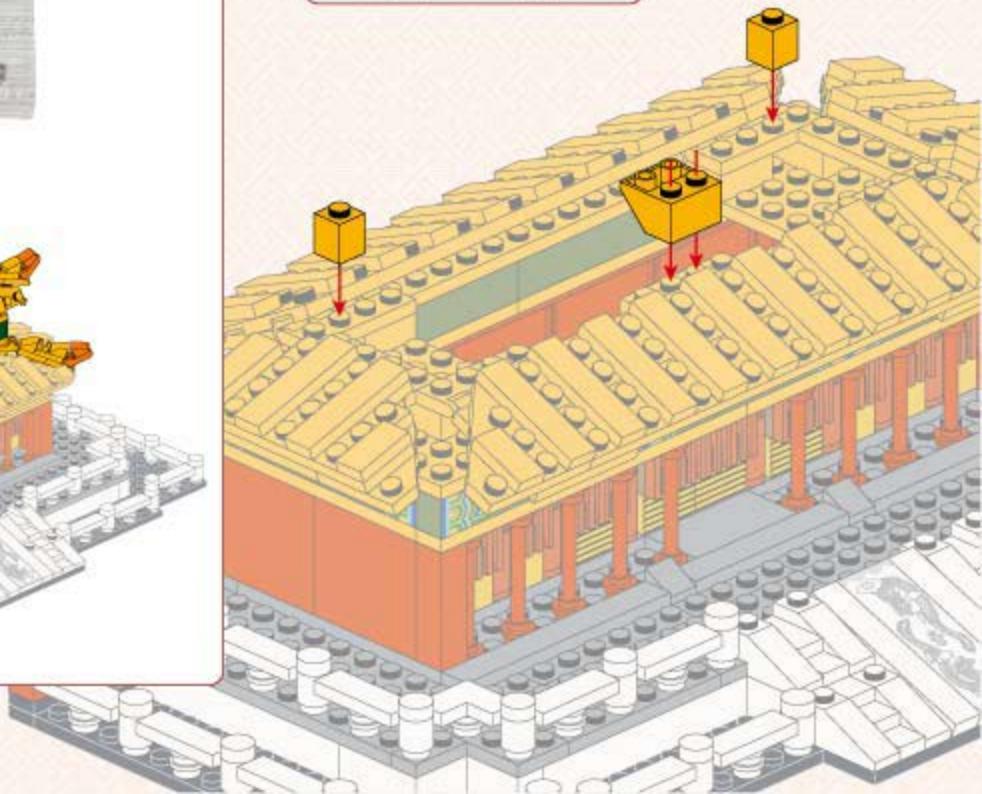



41

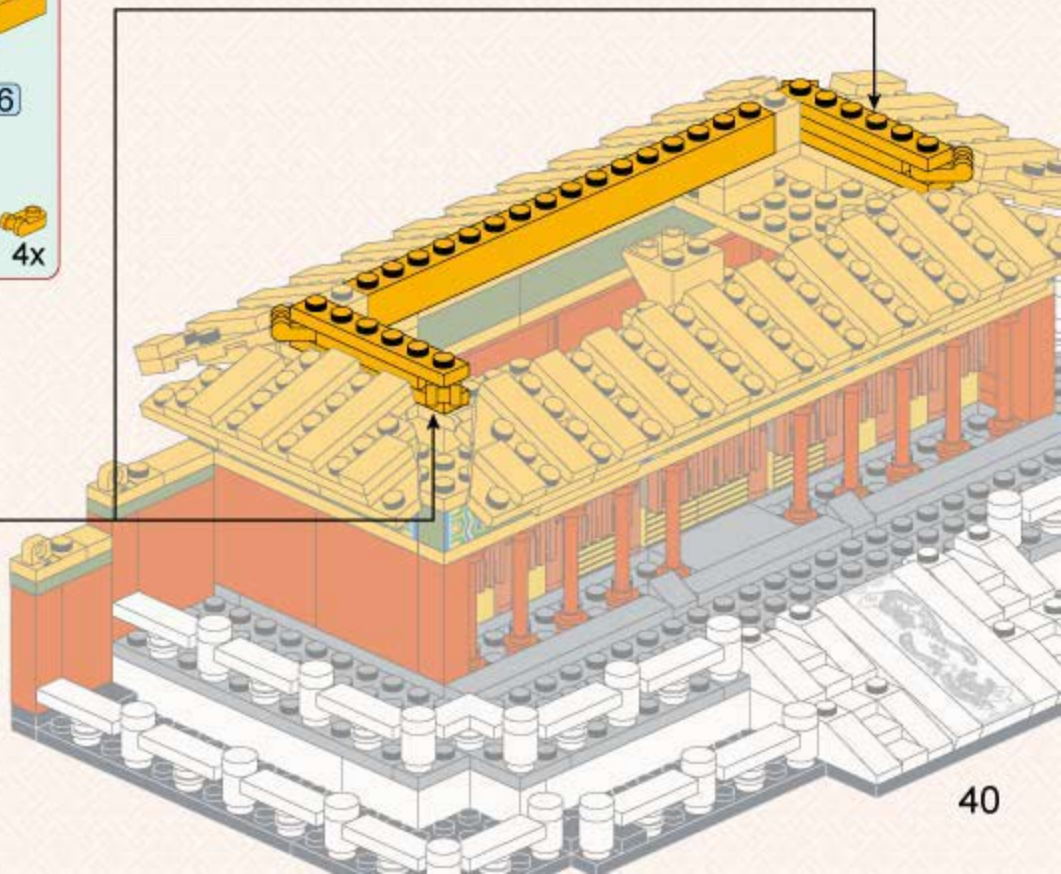
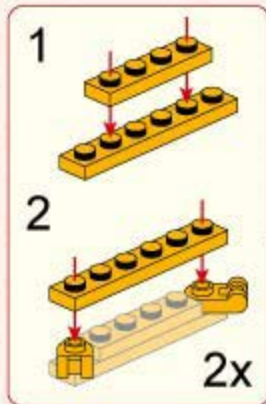
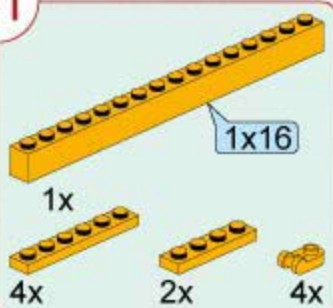

40

42

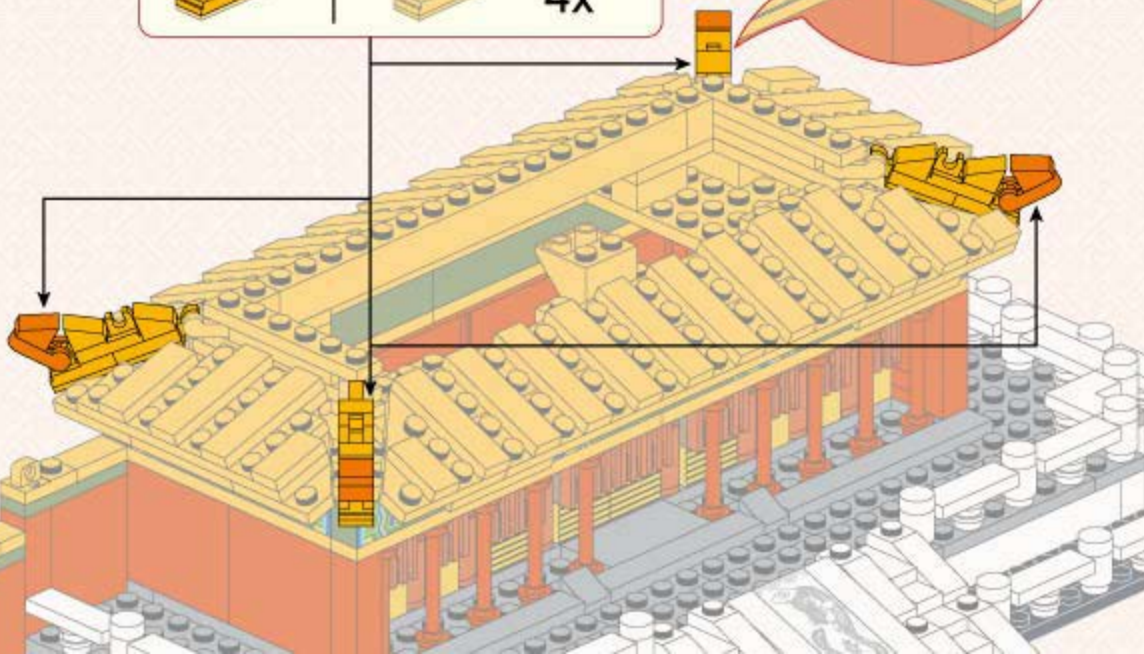
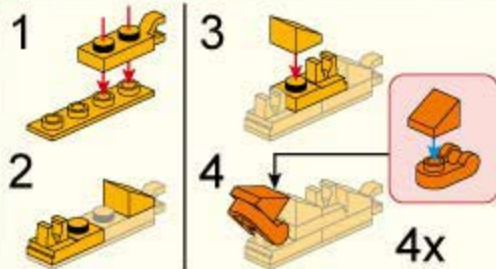
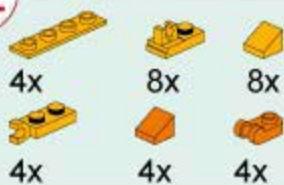

43



1x

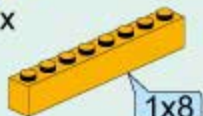

2x

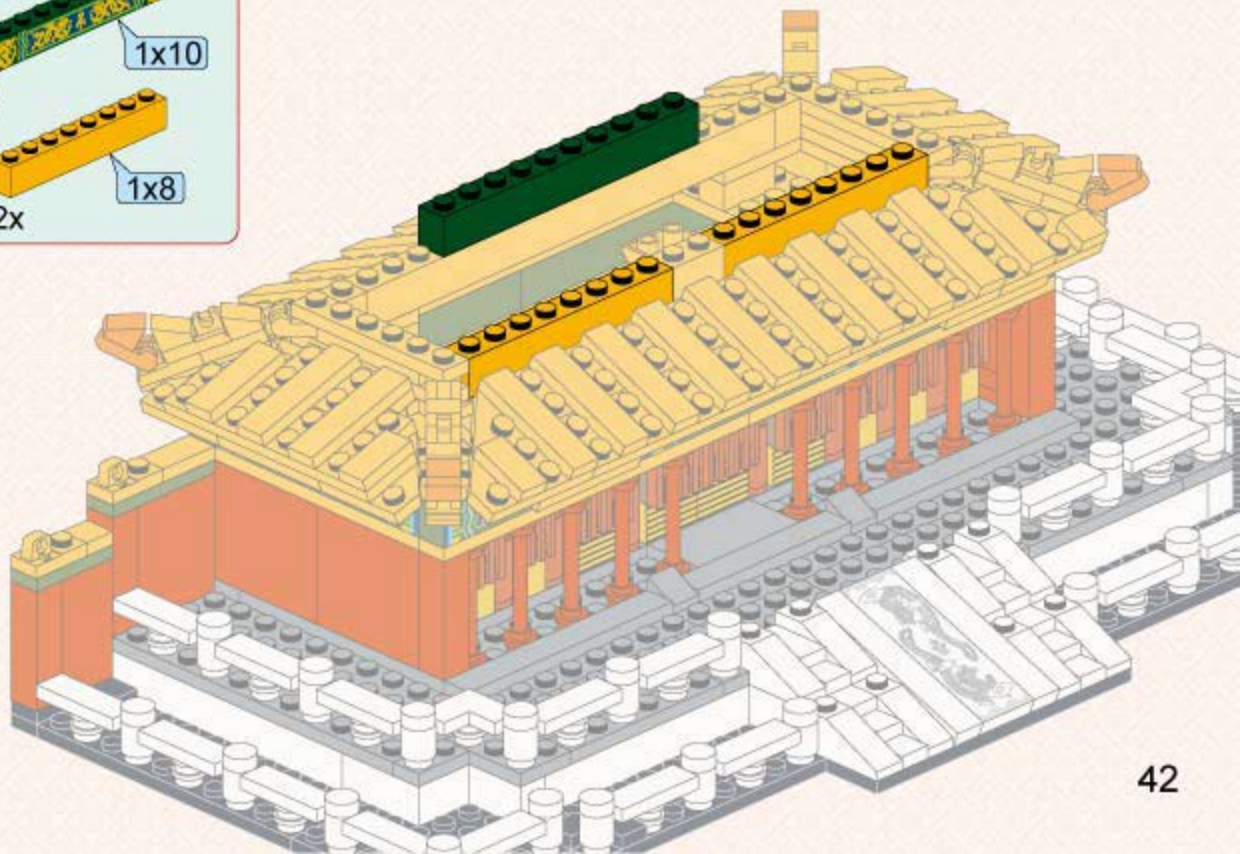

42

44

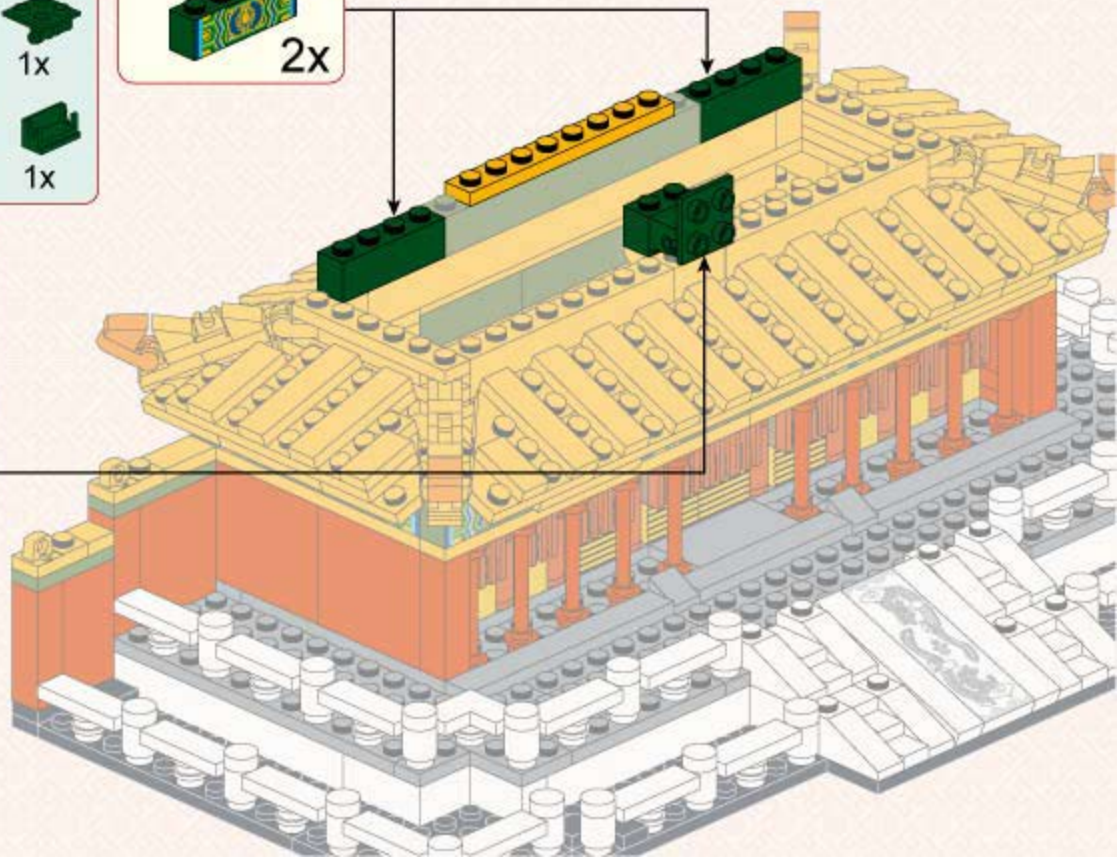
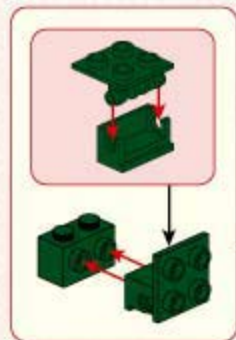
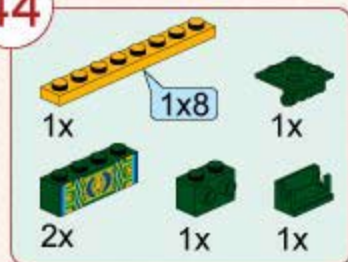

45



2x



2x

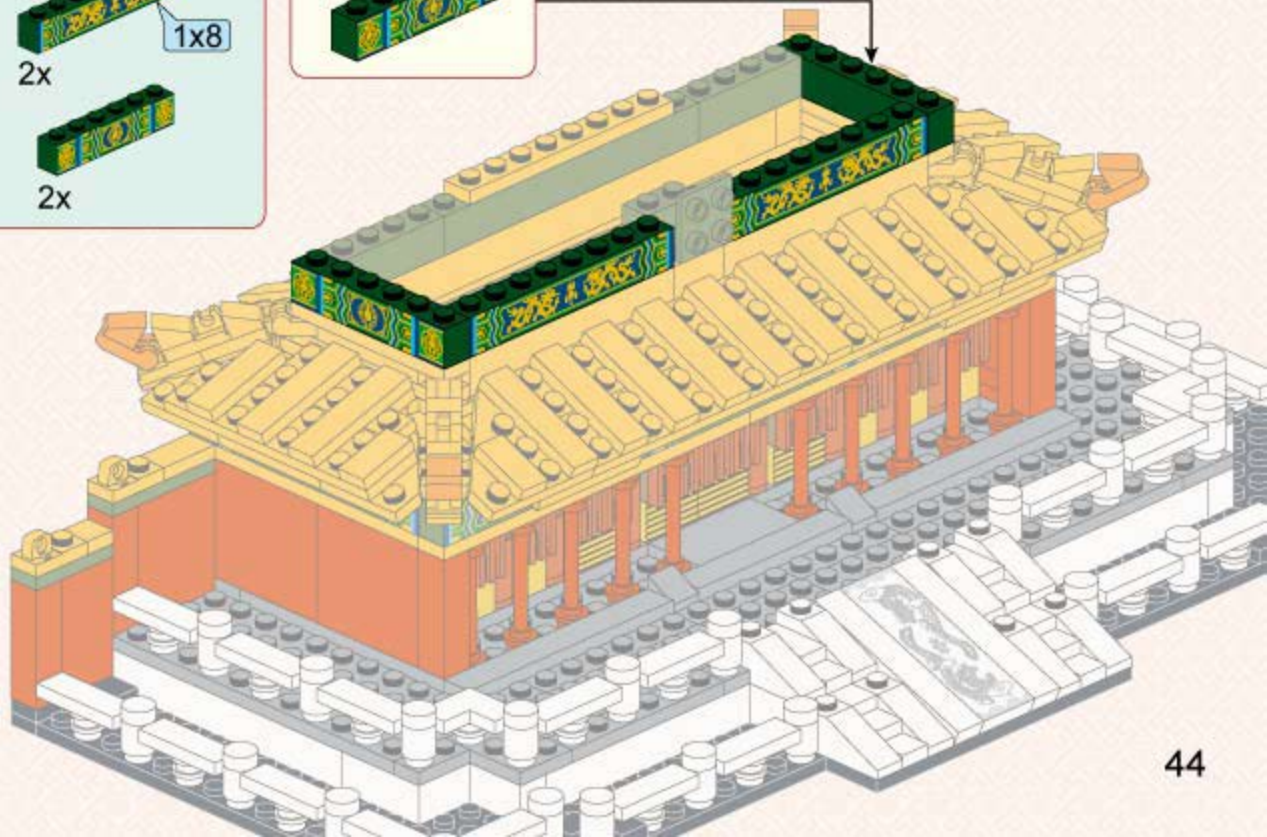

46

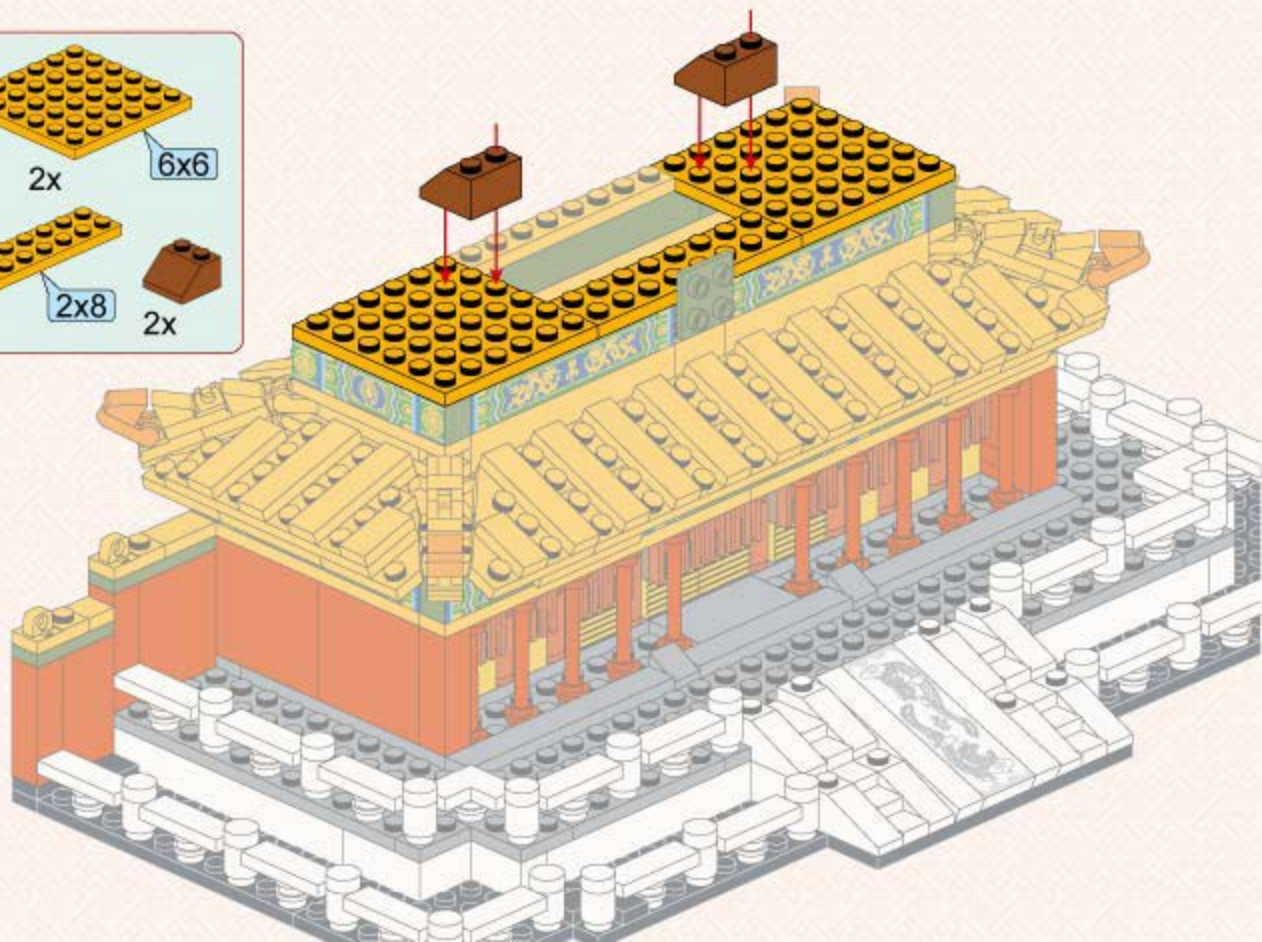
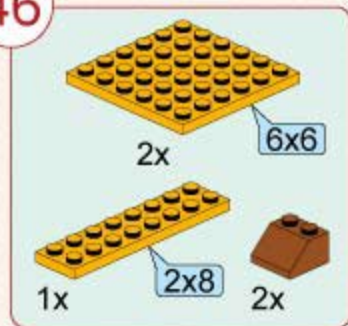

47



2x



2x



2x



2x



2x

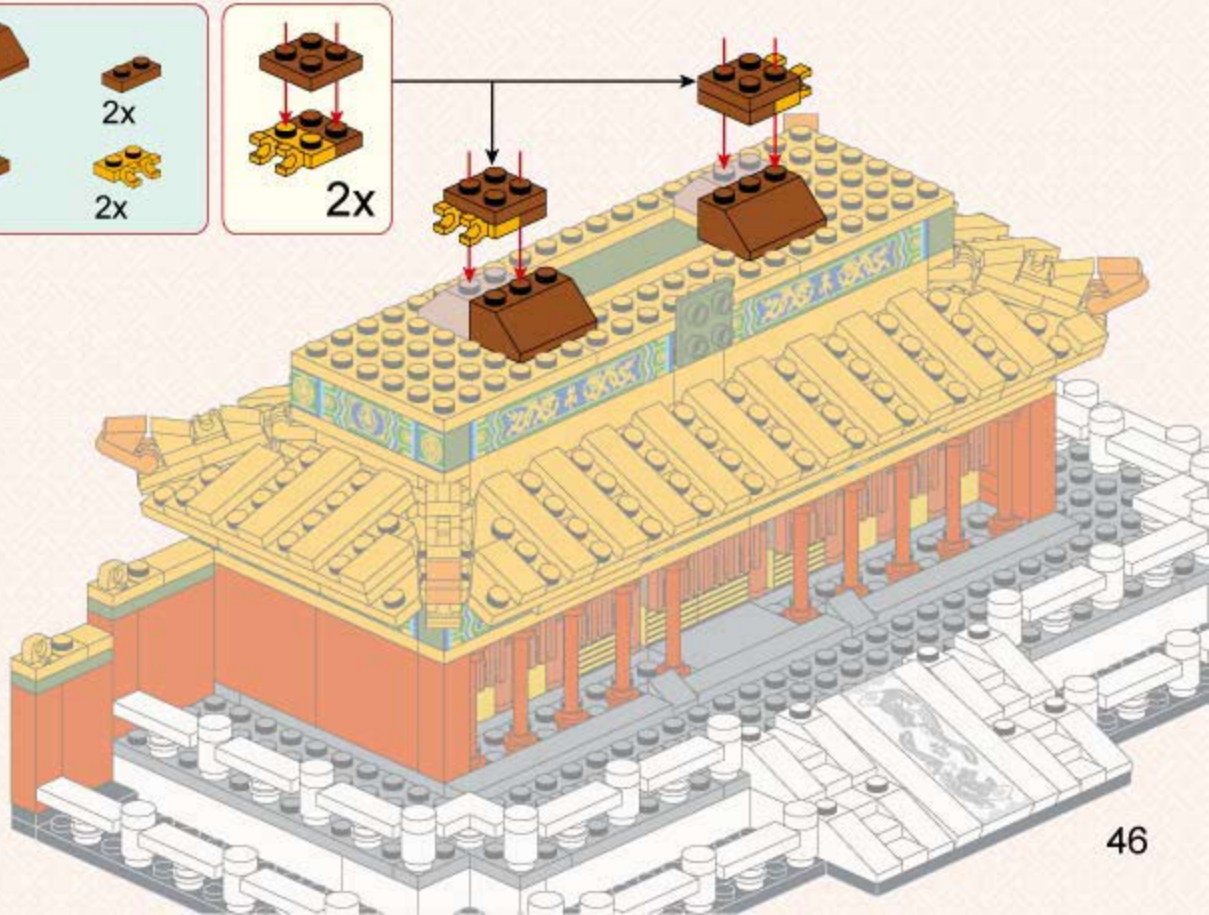
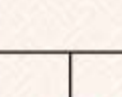

48



4x



4x



2x



2x



4x



1x

2x3



4x

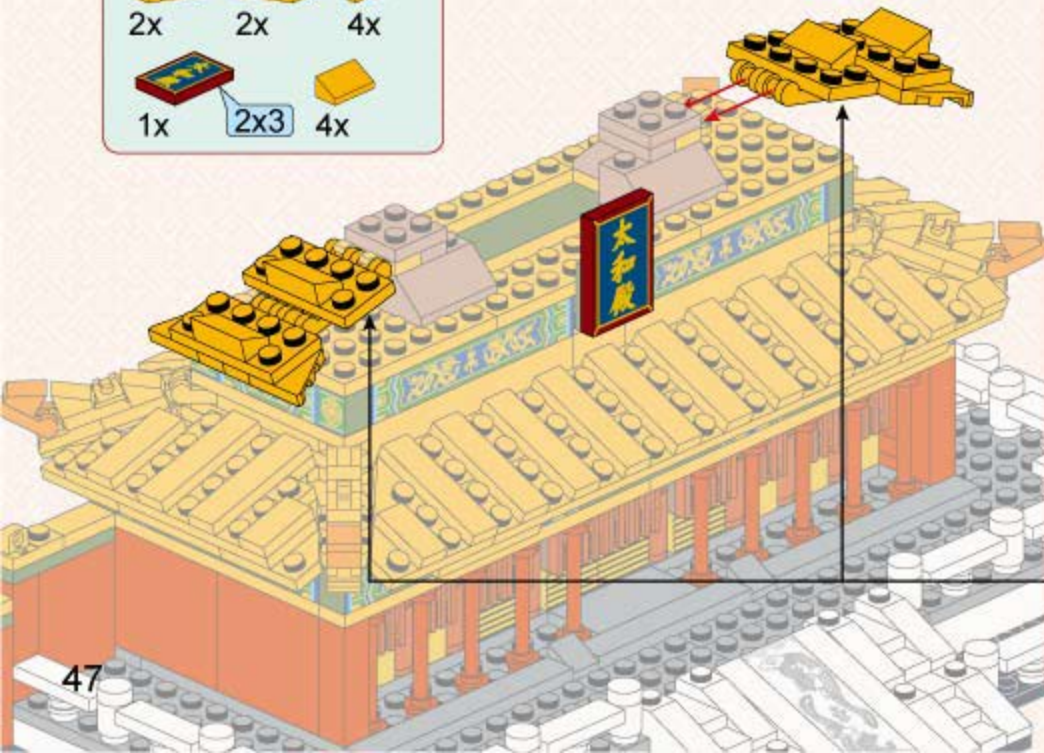

1

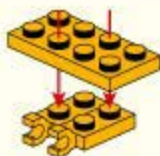

2

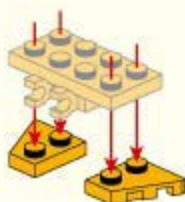

3

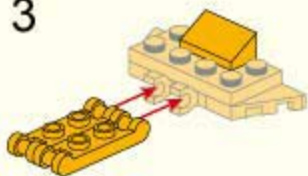

4



2x



49



2x



2x

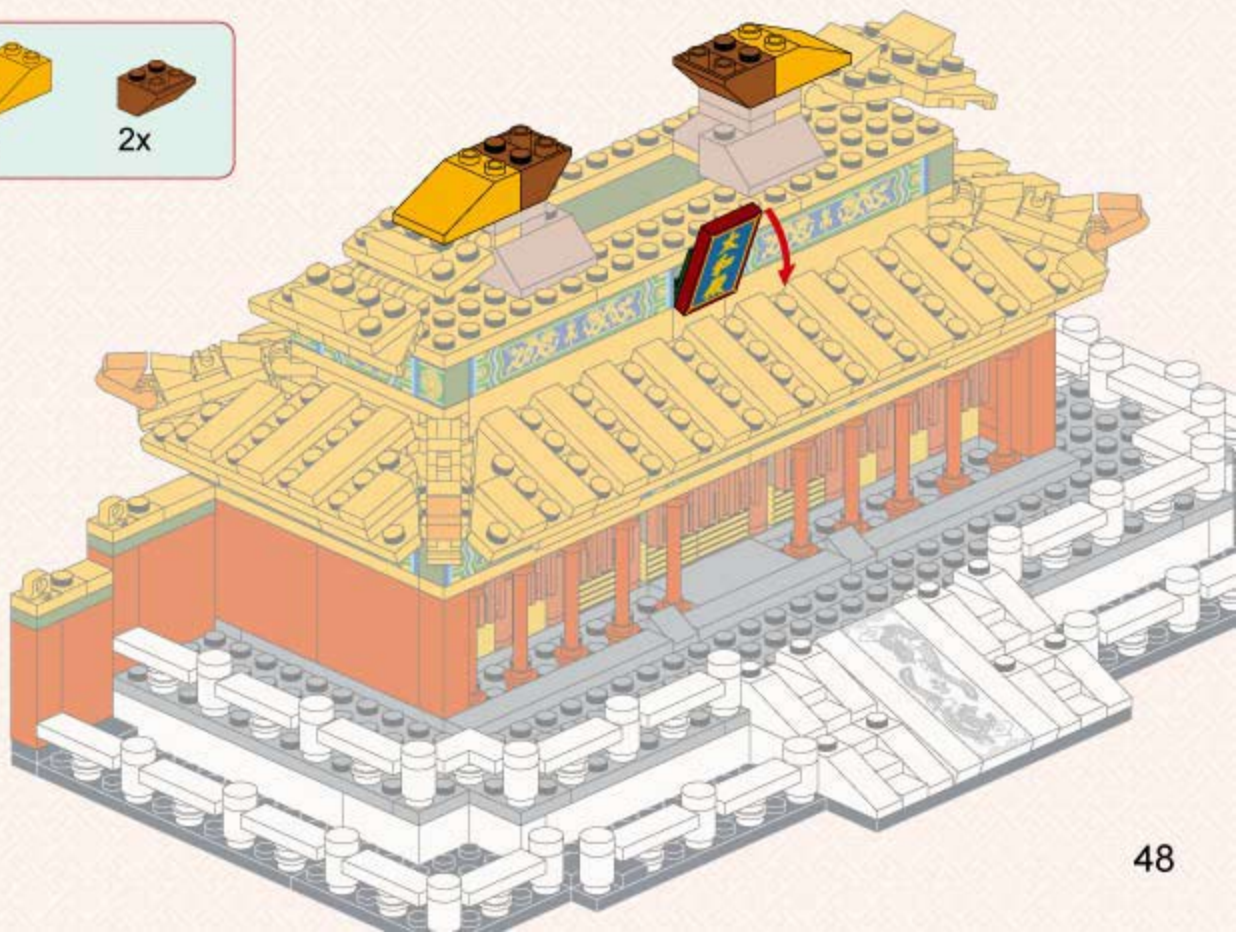

48

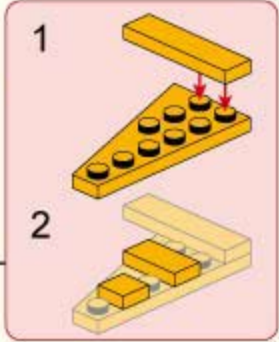
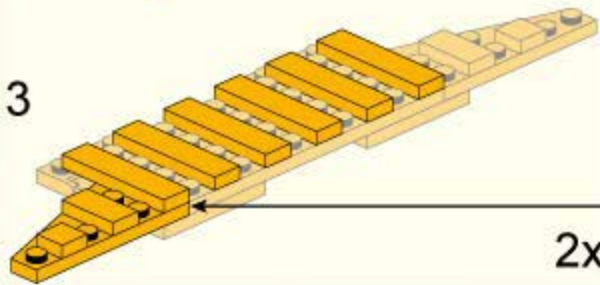
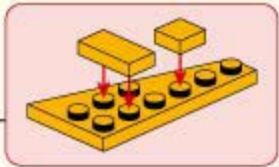
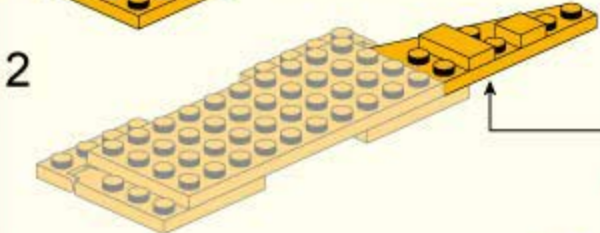
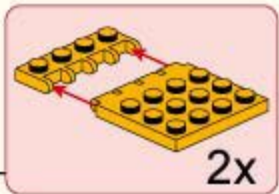
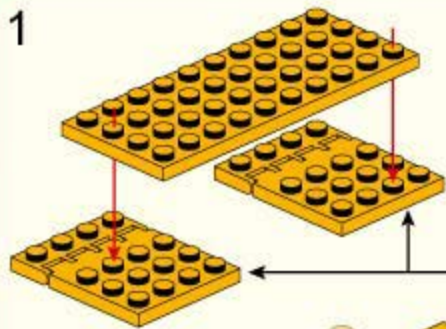
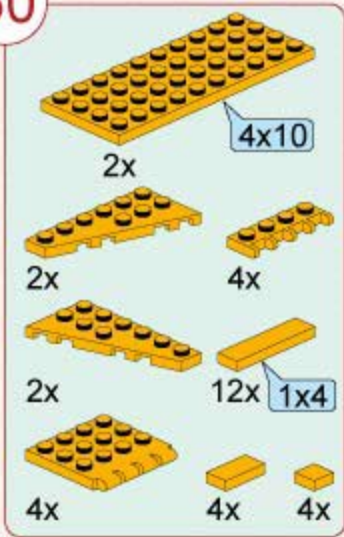

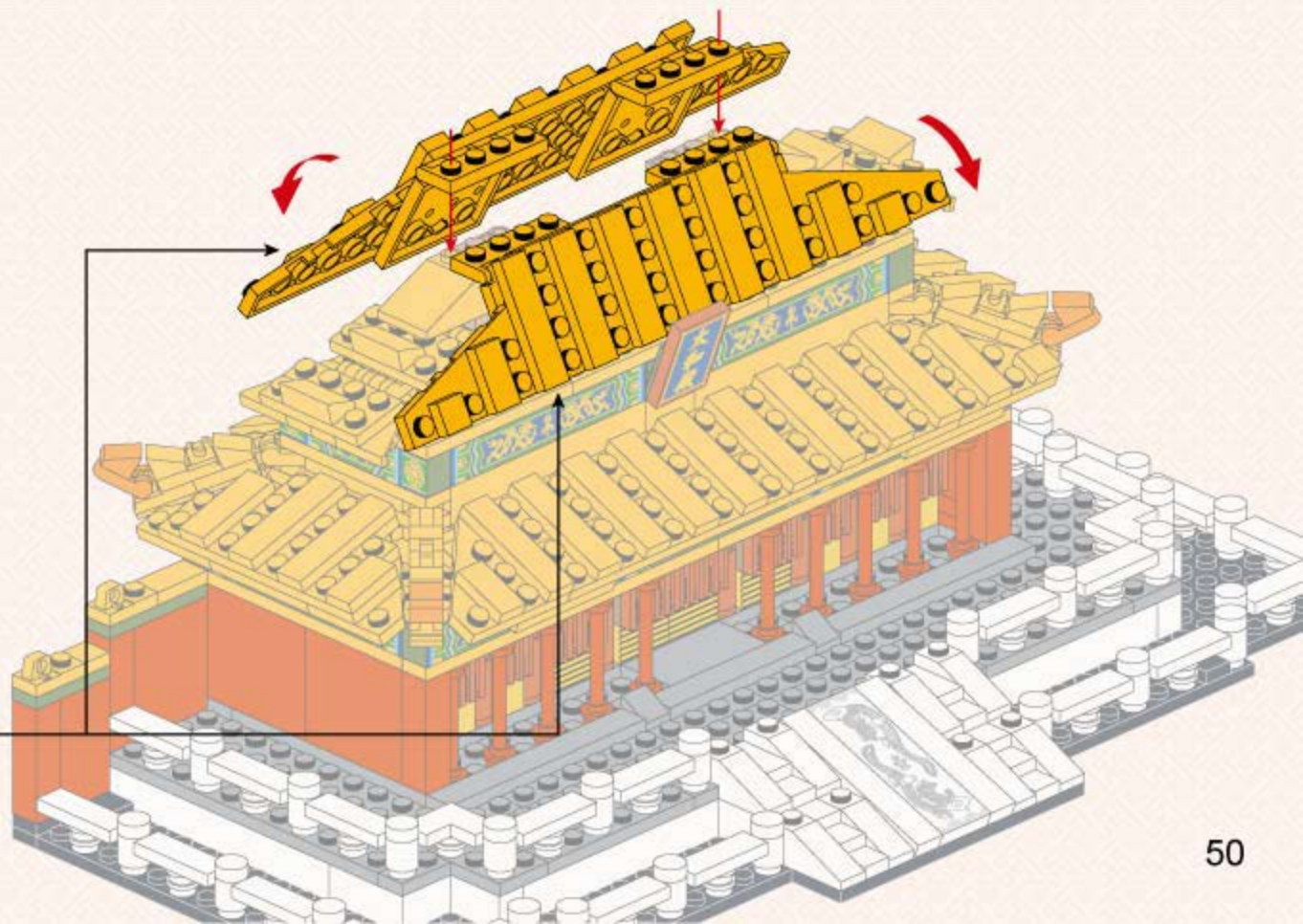

51

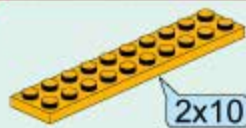

1x

2x10



3x



4x

1

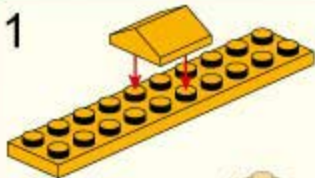

2

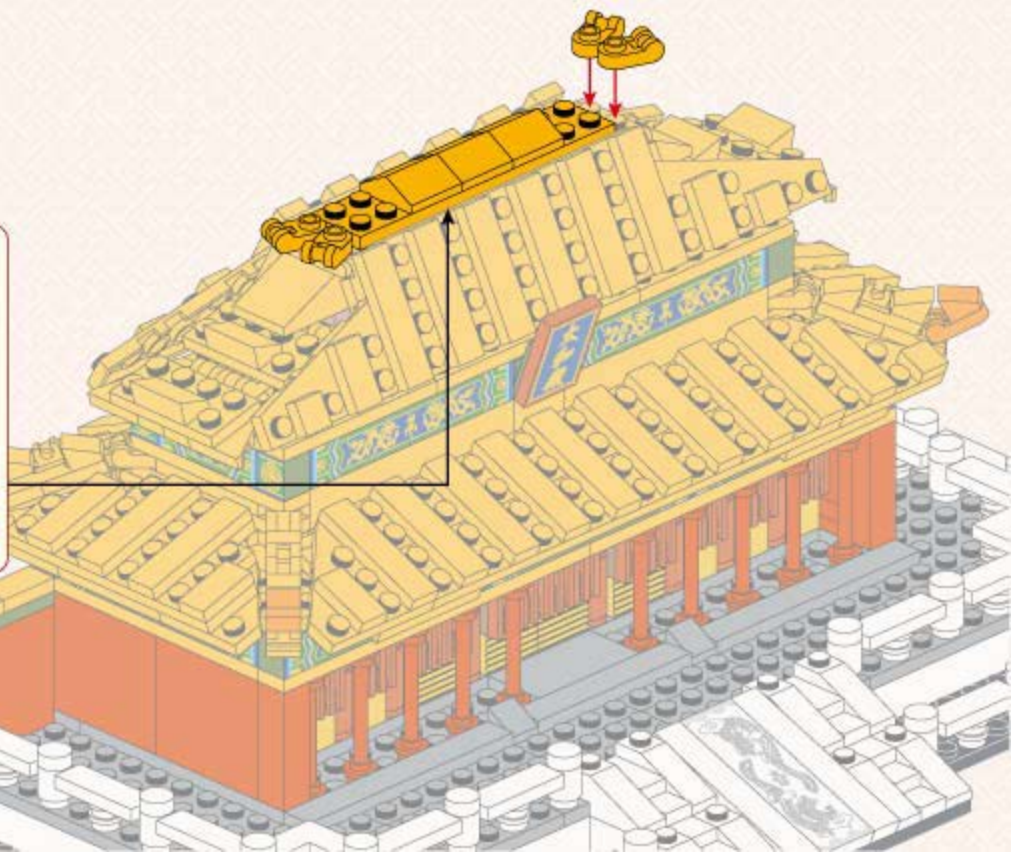
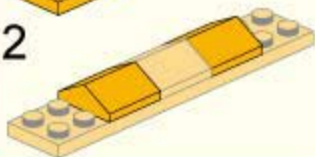

52



4x



4x



4x



4x



4x



4x



4x



4x



4x



2

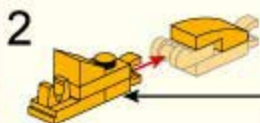

3

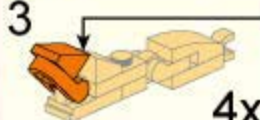

4x



2

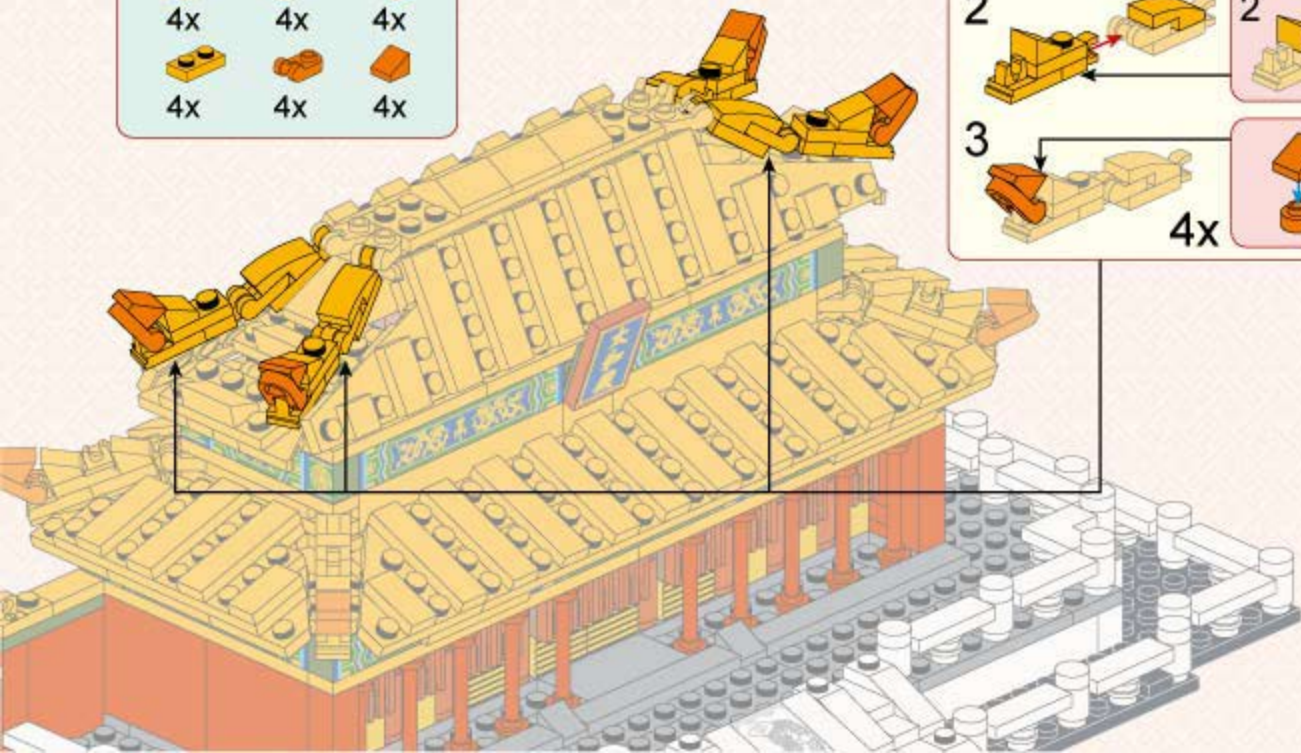

53



6x



2x

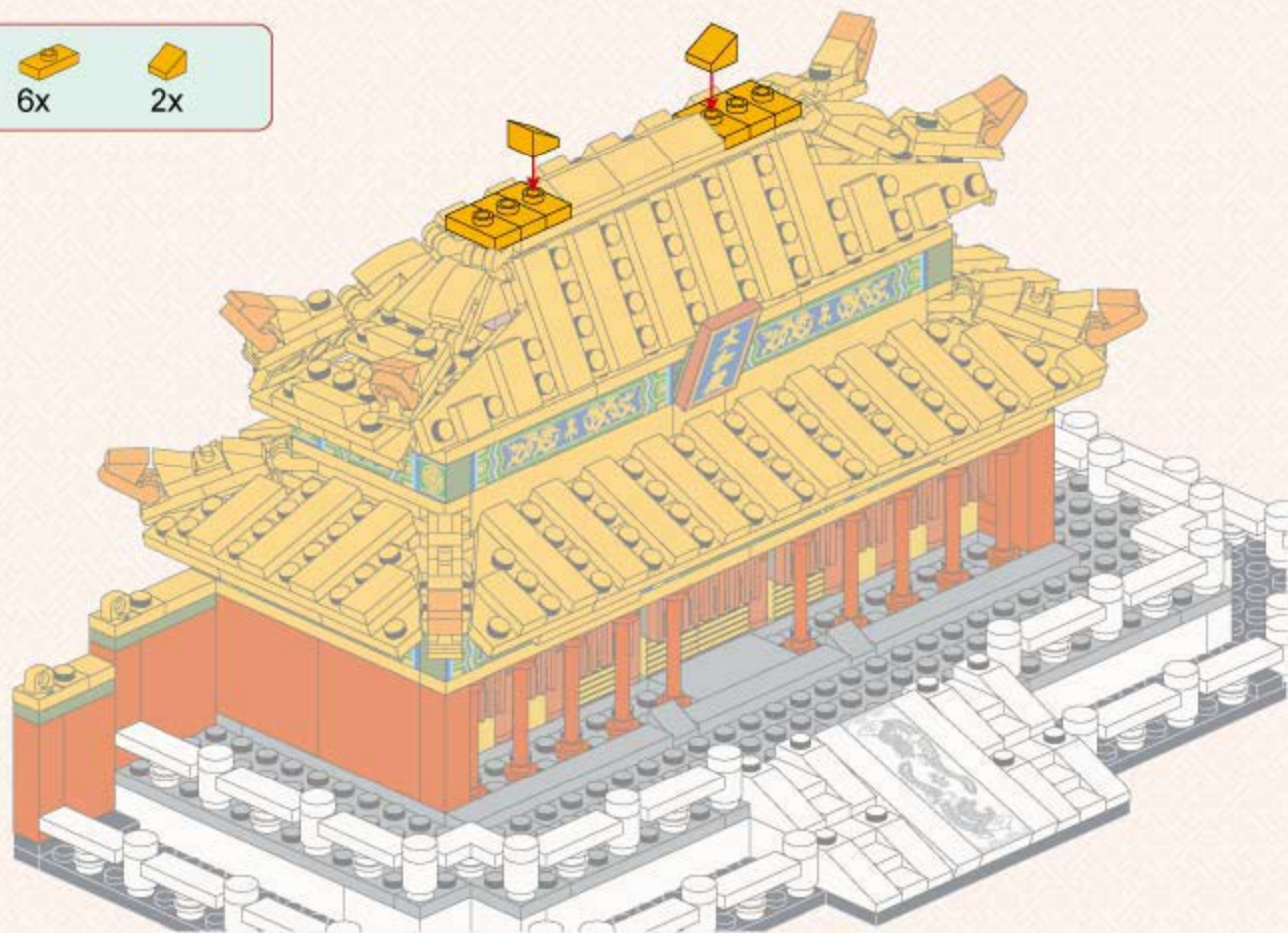

53

54



2x



4x



2x



2x

1



2



3

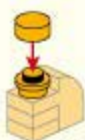

2x

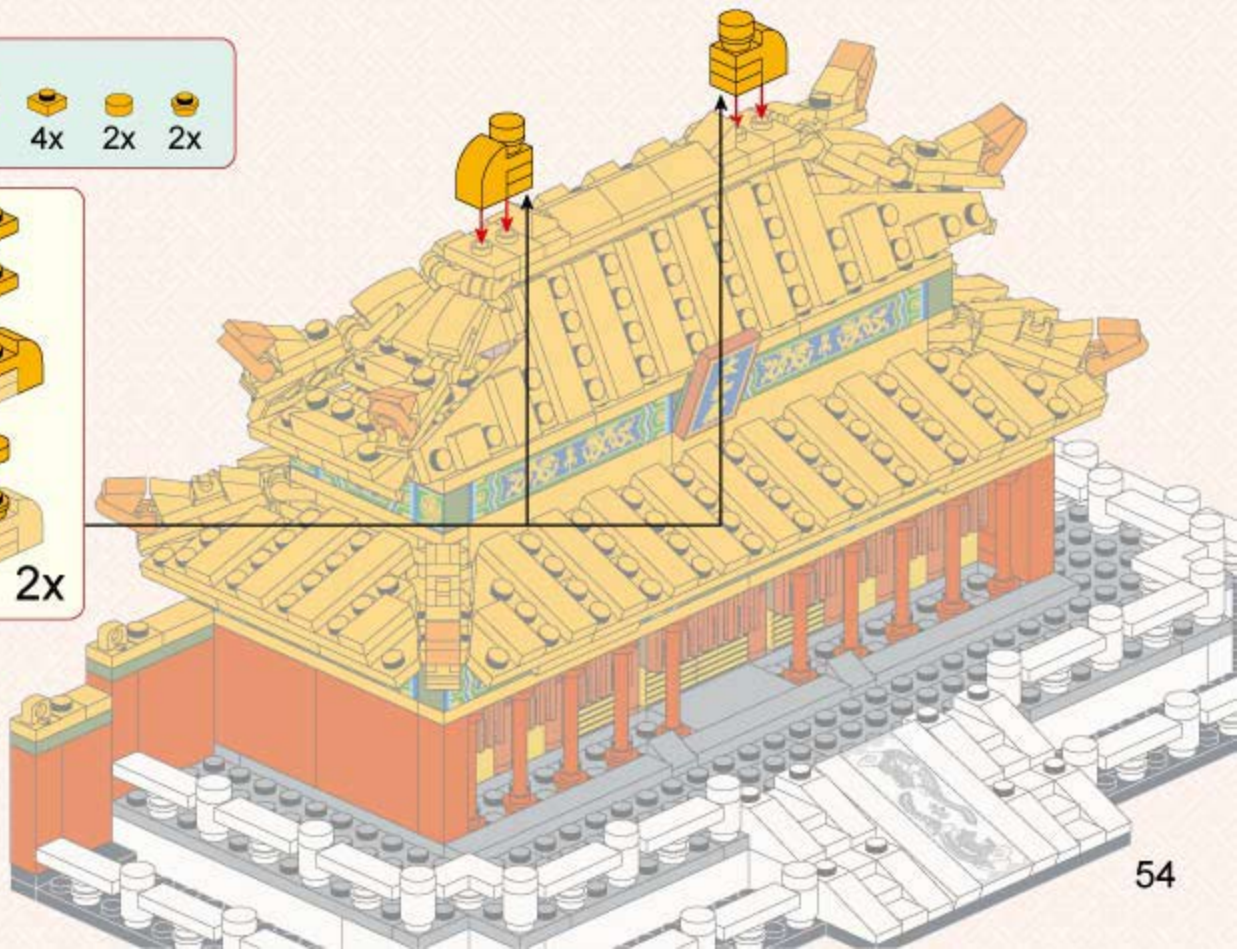

54

