

# Keep Play

## 国玩系列



图片仅供参考，请以实物为准。

### 新中式街景

New Chinese Style Streetscape

K18001 开运火锅店



拆件器使用方法，仅为示例

Usage of Brick Separator, Just for the sample

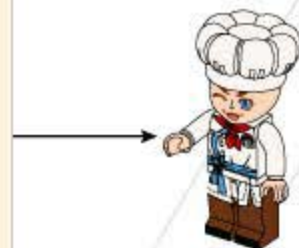
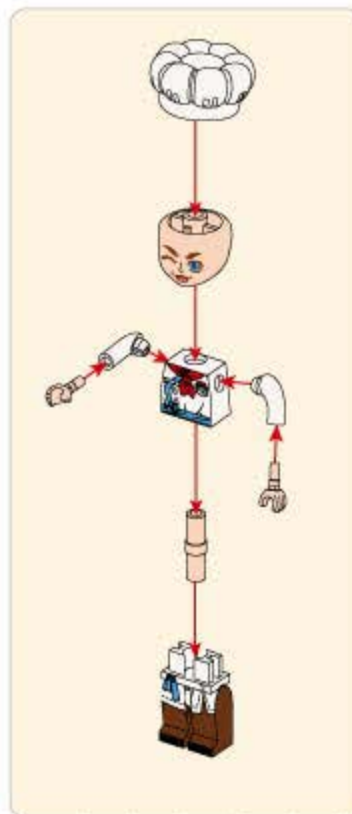
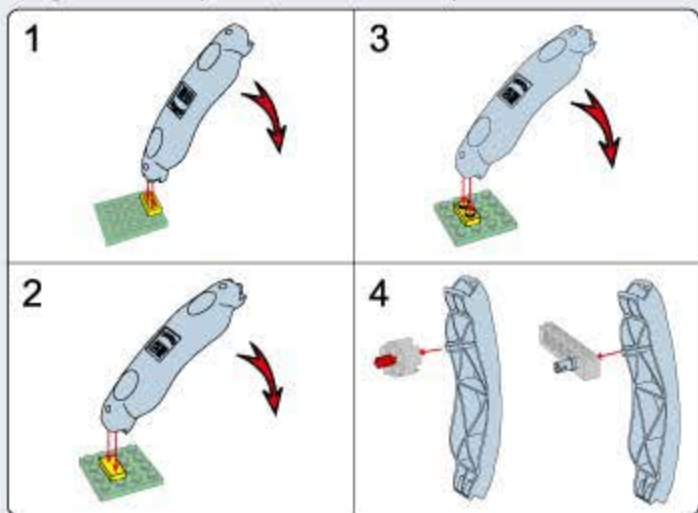

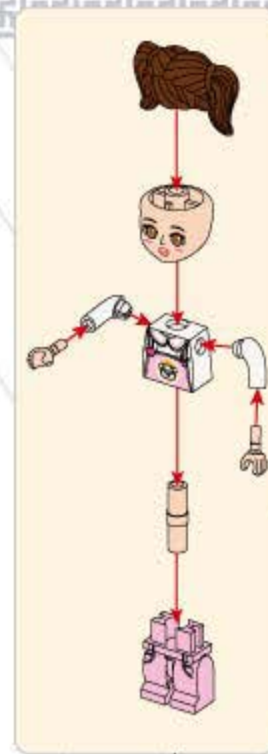
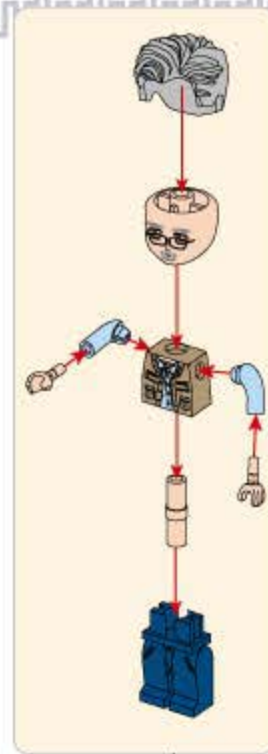
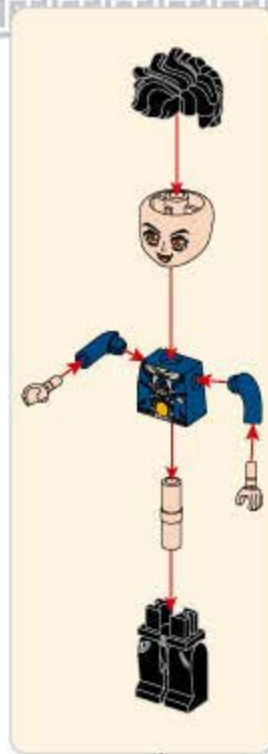
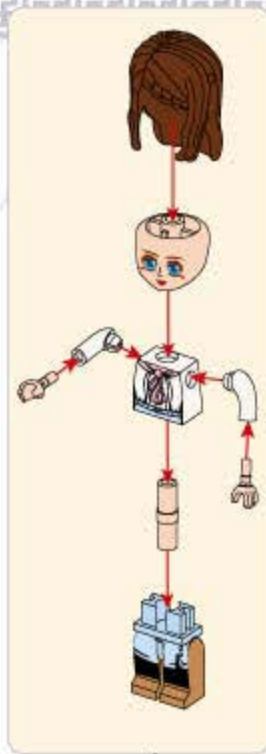
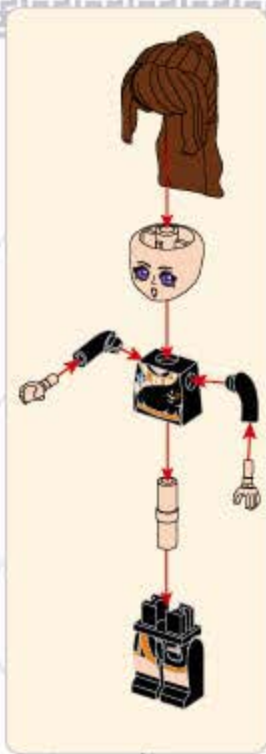

1

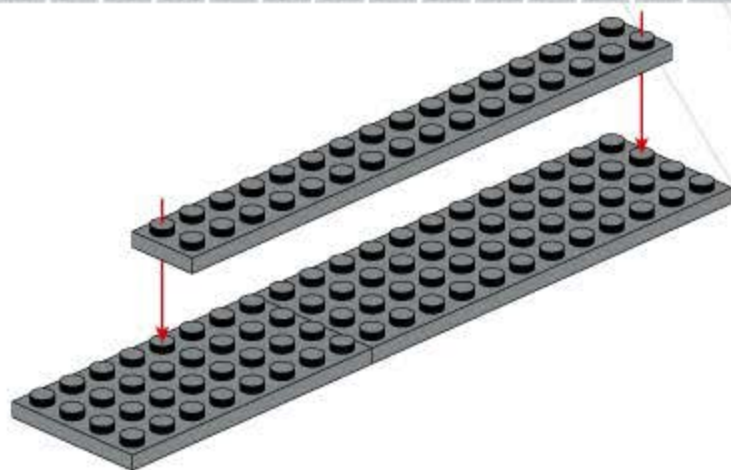
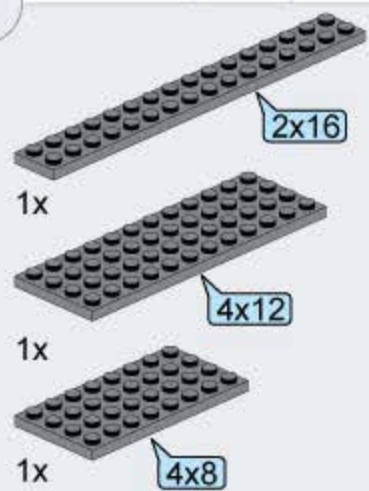

2

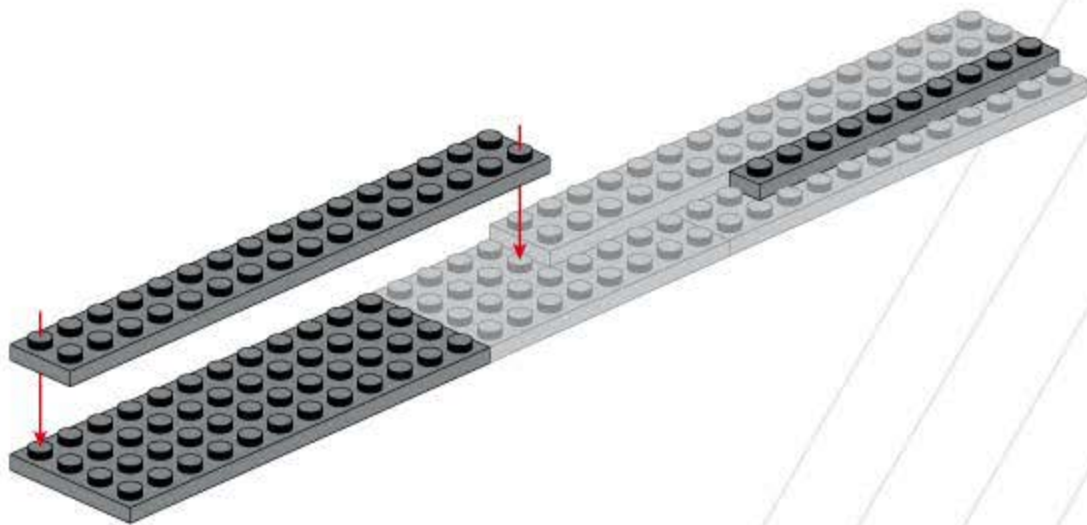
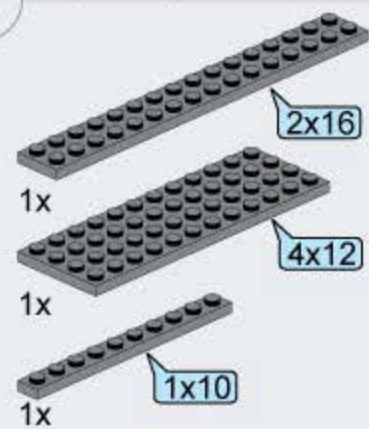

3

3

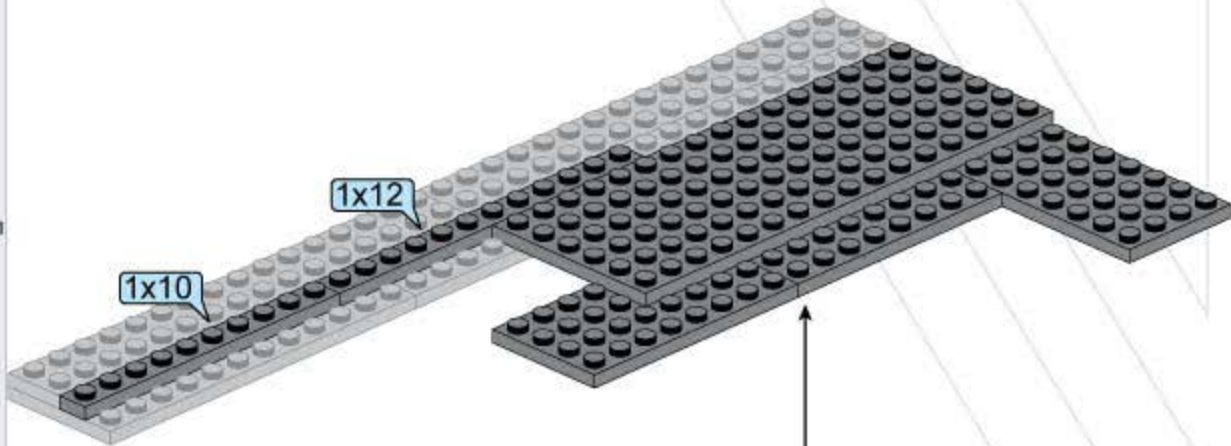
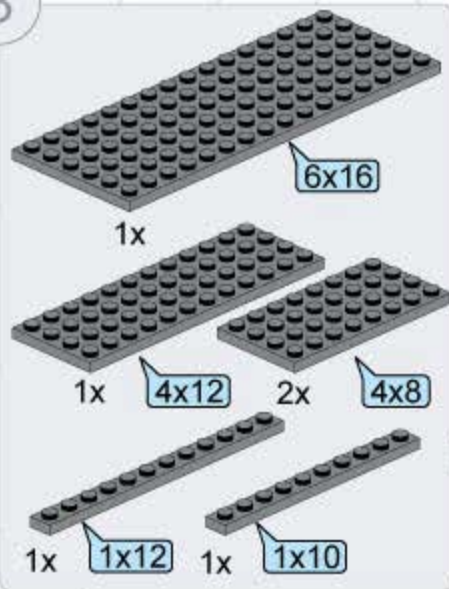

1

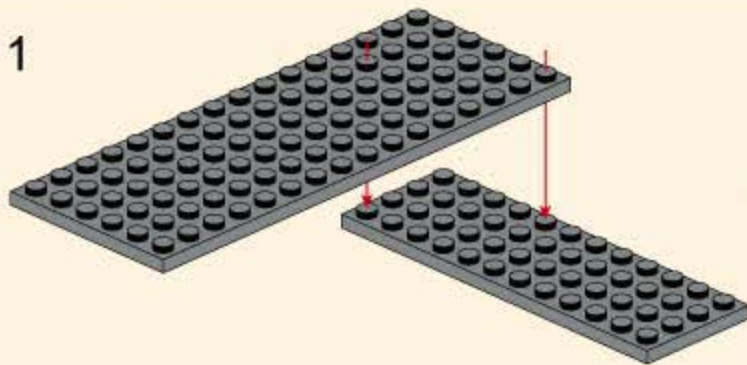

2

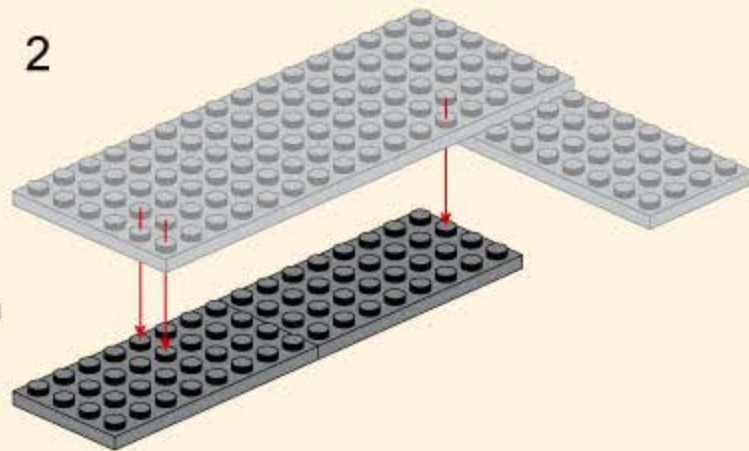

4

4

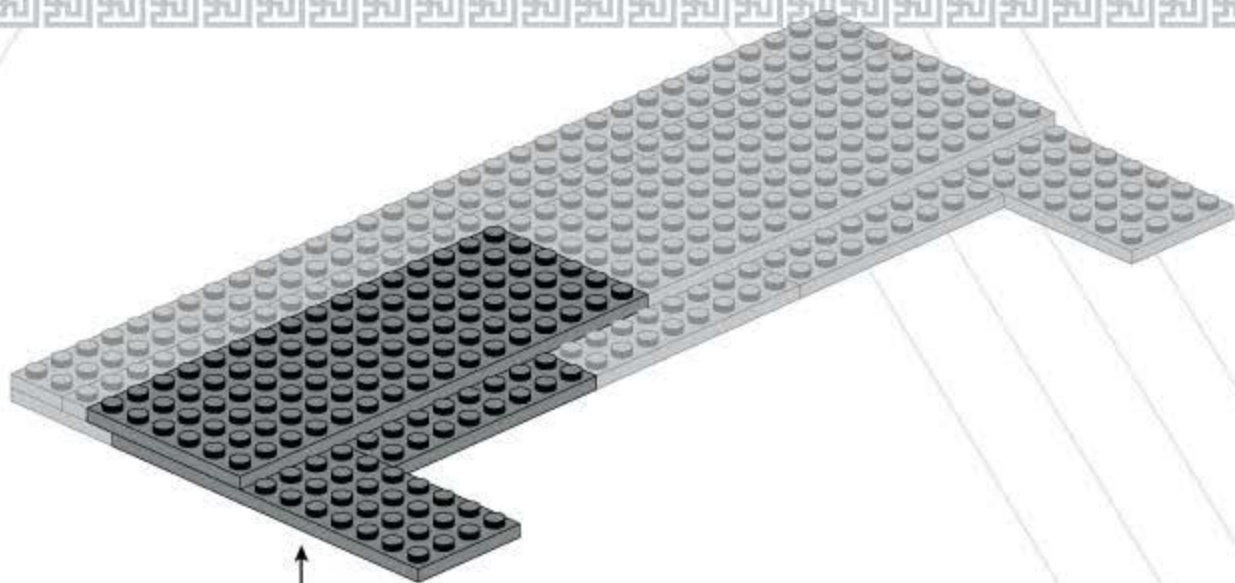
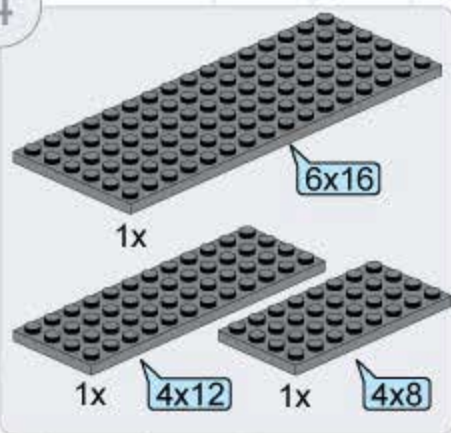

1

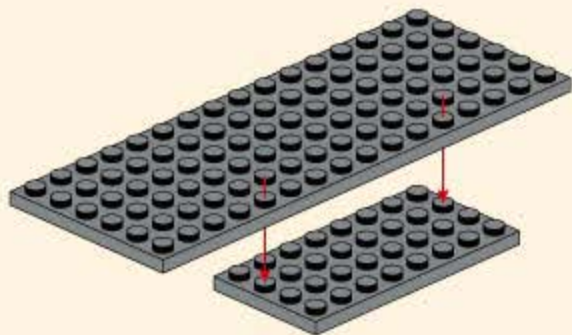

2

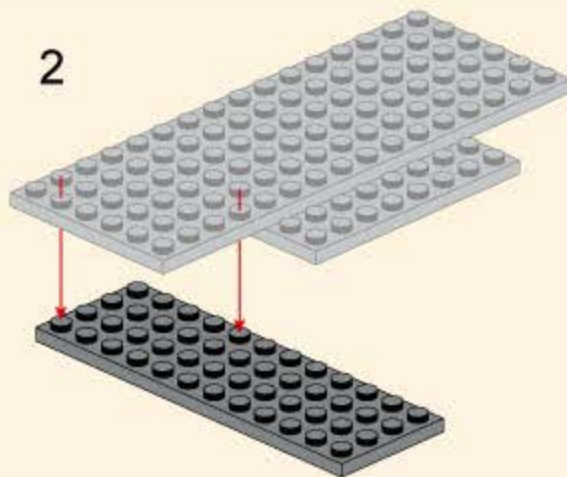

5

5

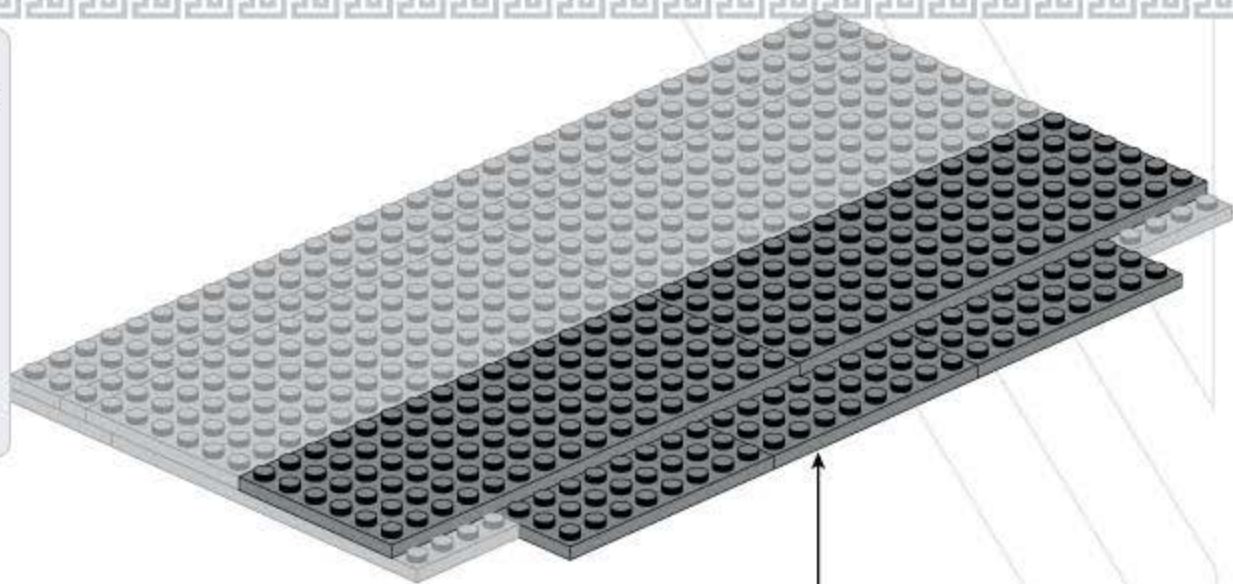
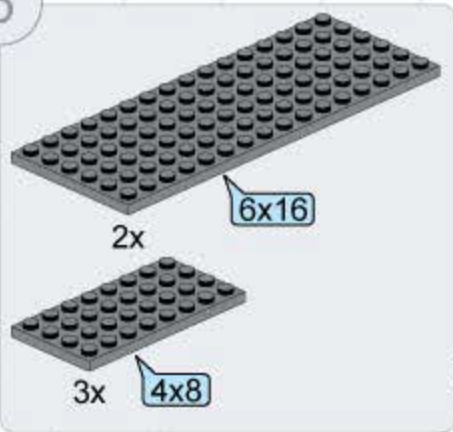

1

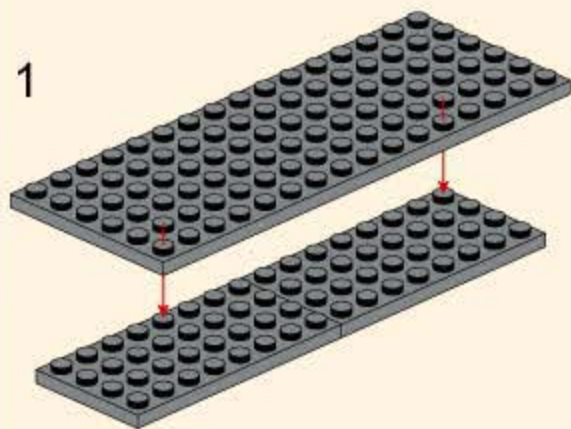

2

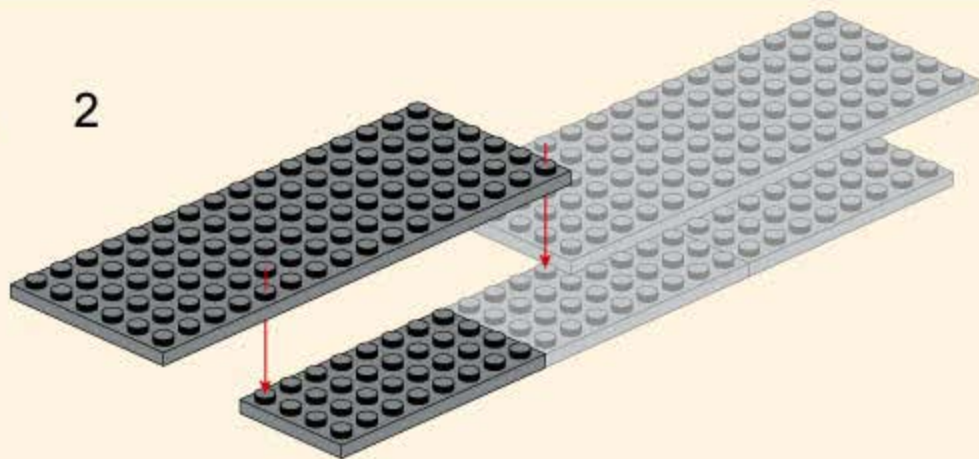

6



2x

2x16



2x

4x12

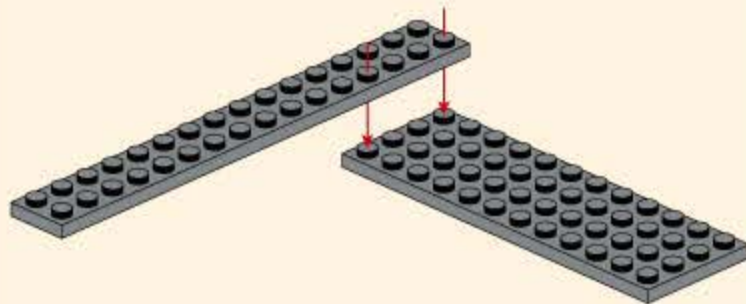
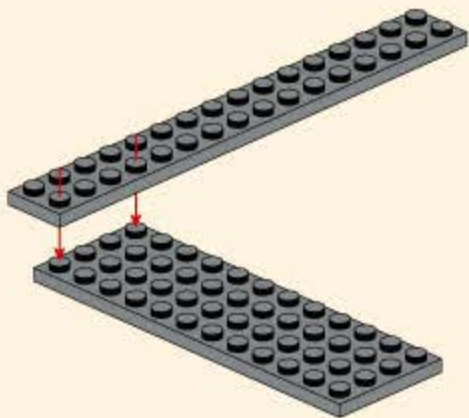
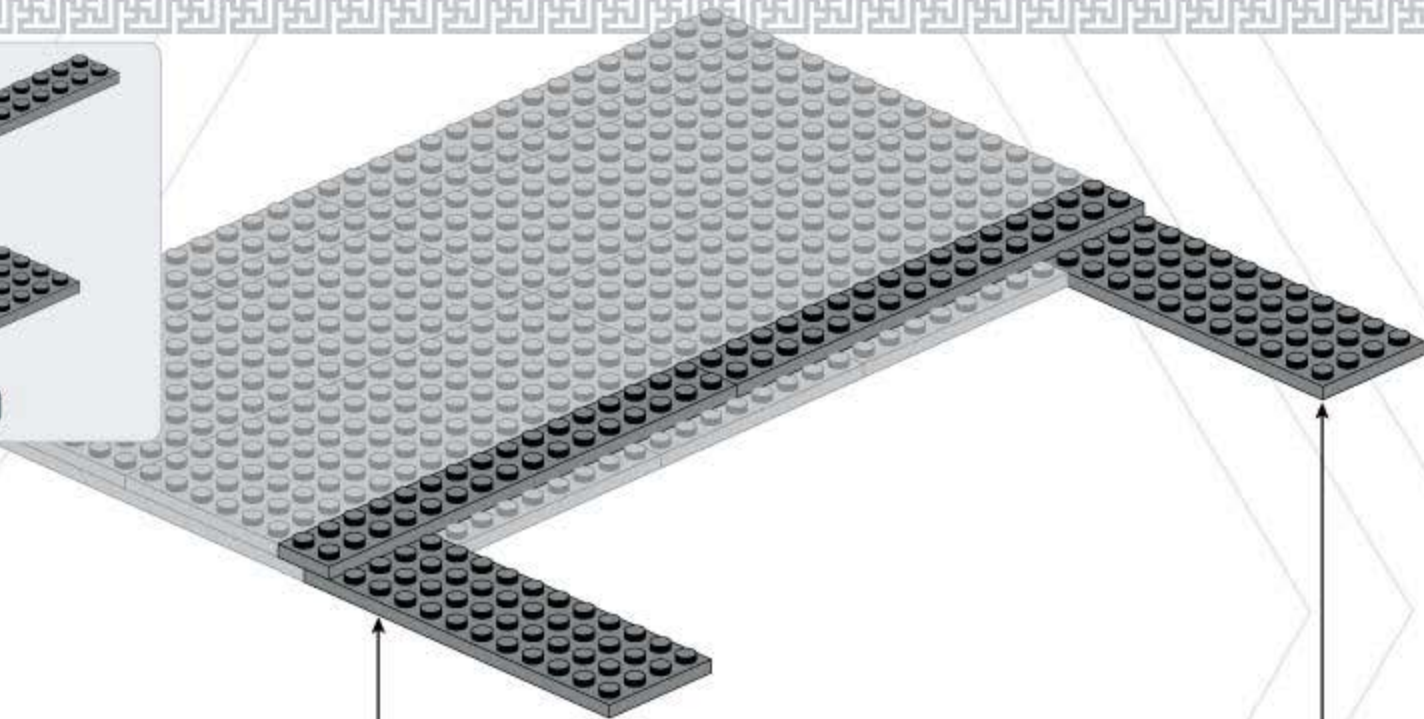

7



7

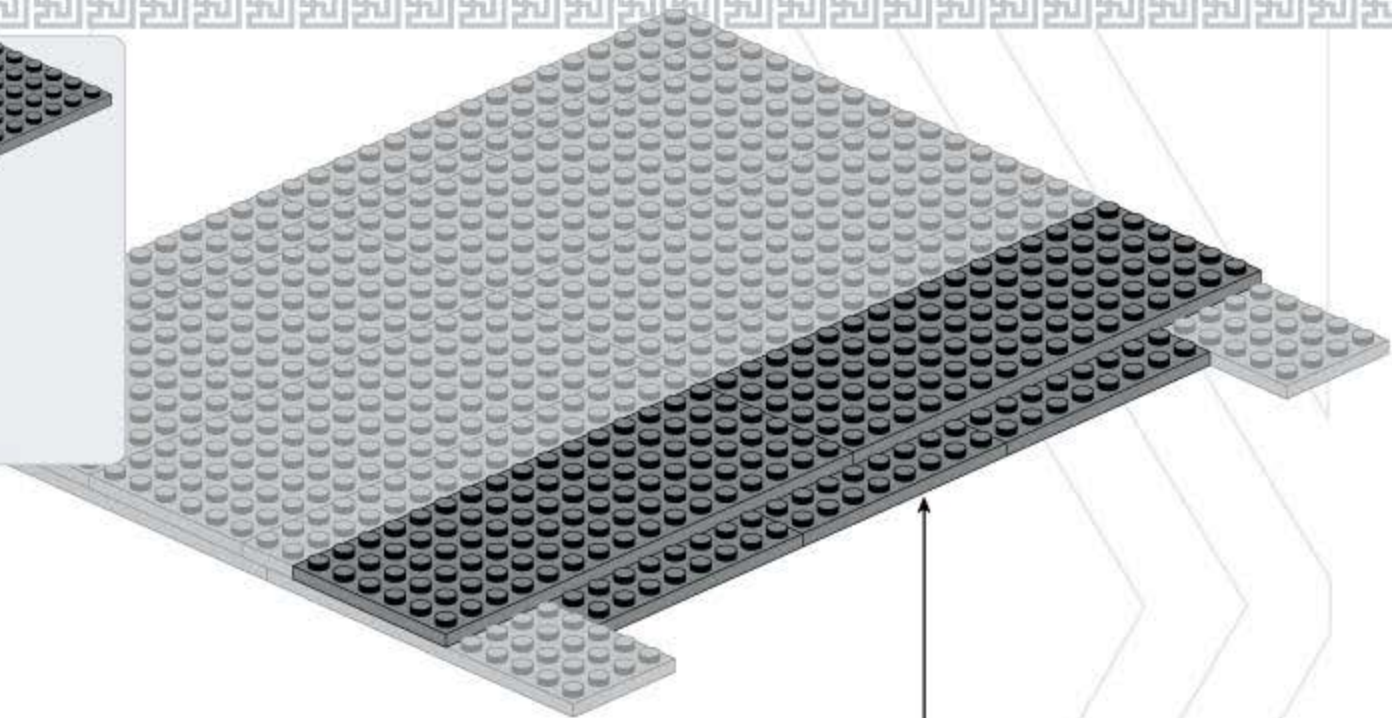
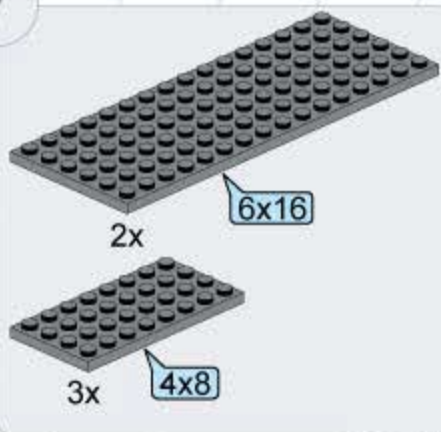

1

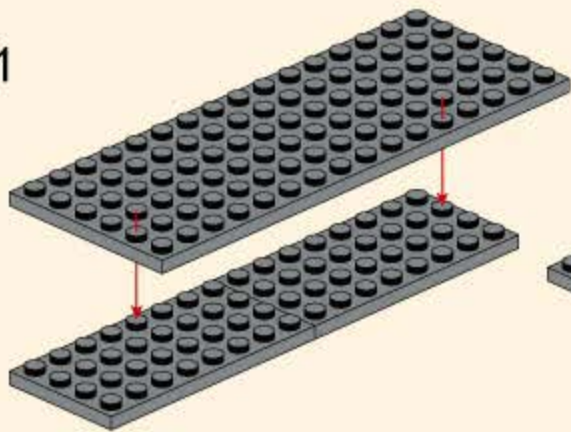

2

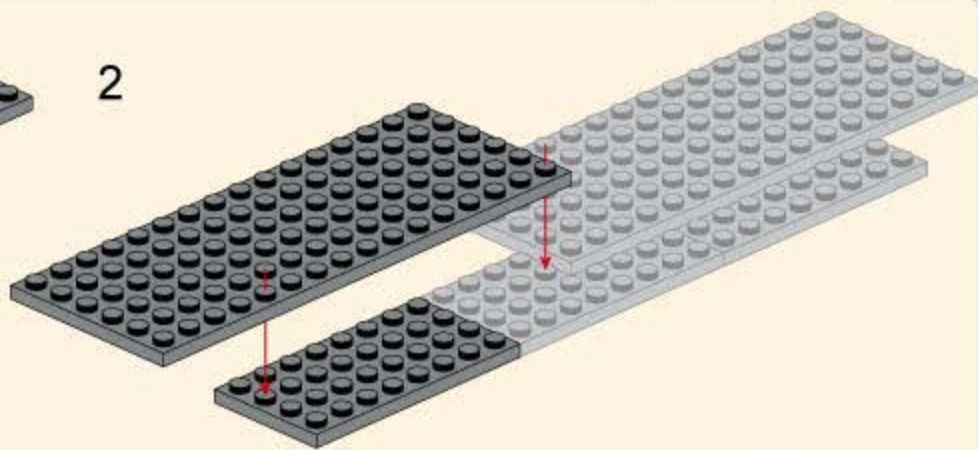

8

8

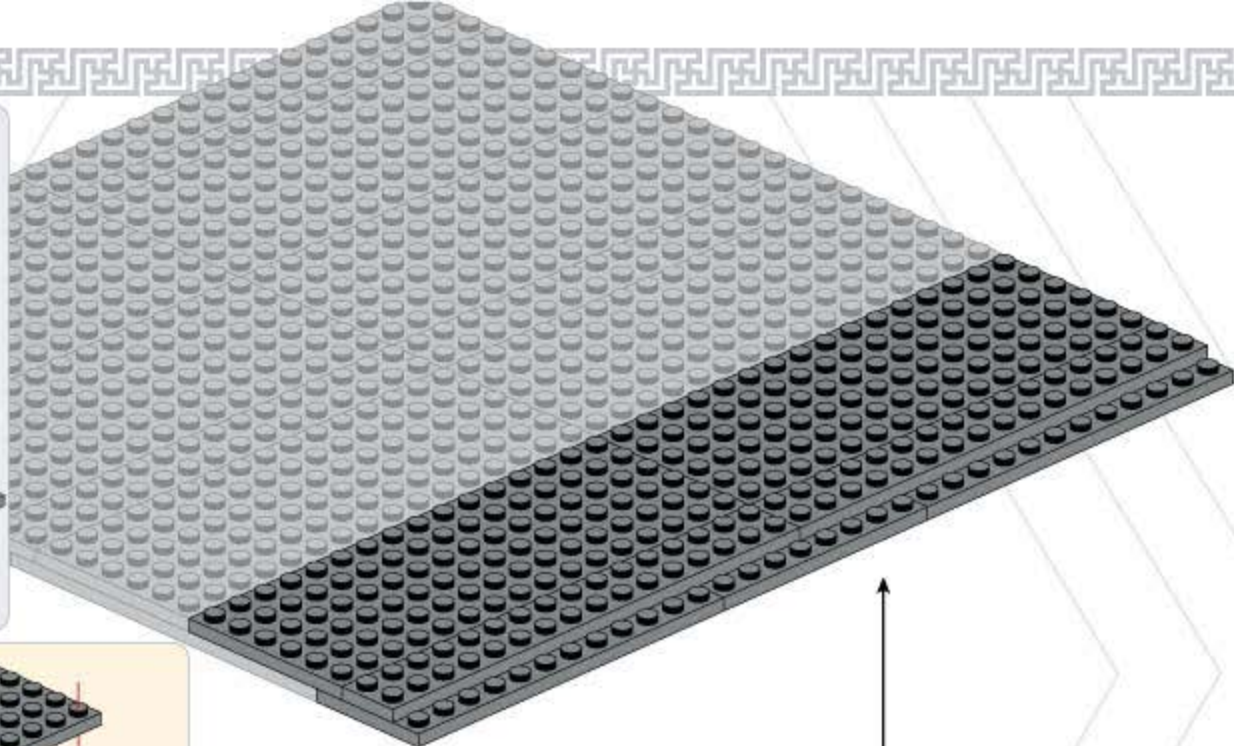
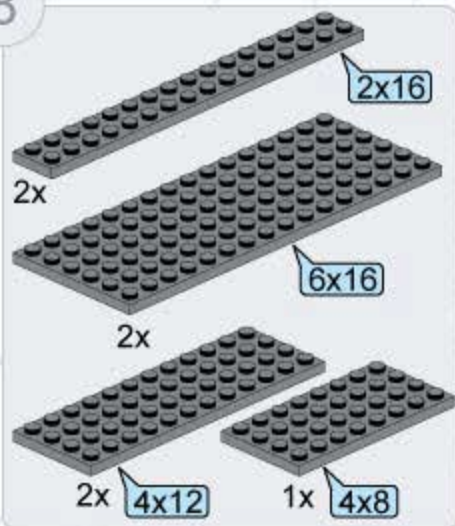

1

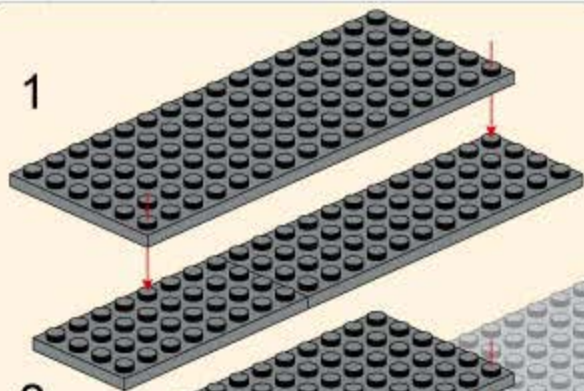

2

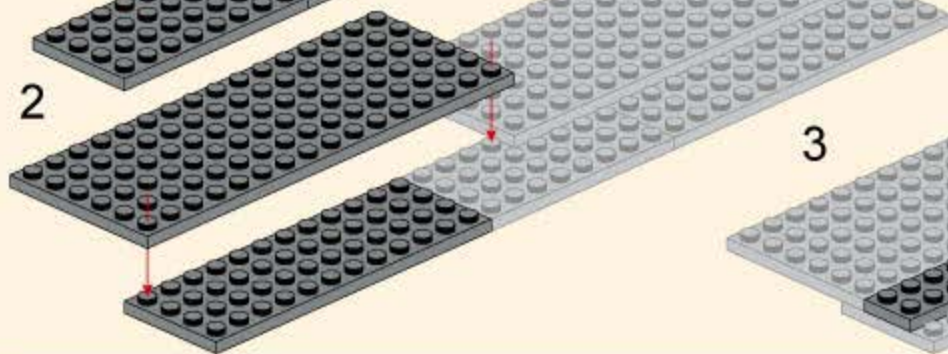

3

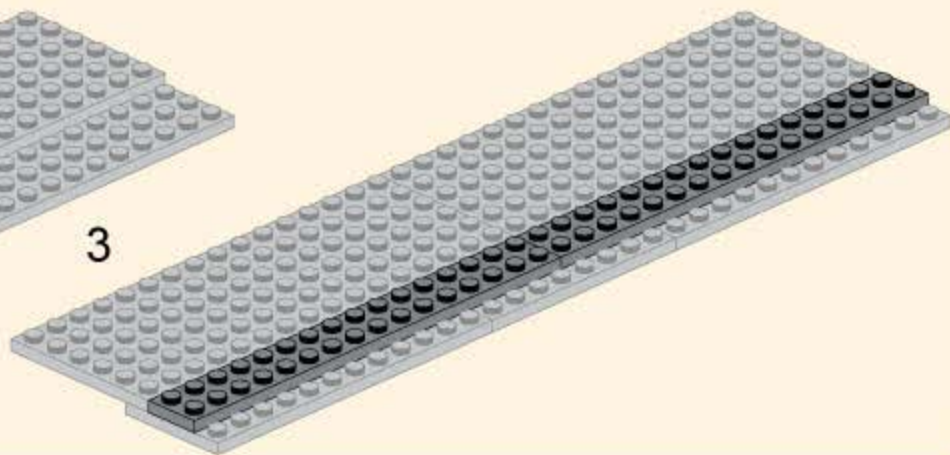

9

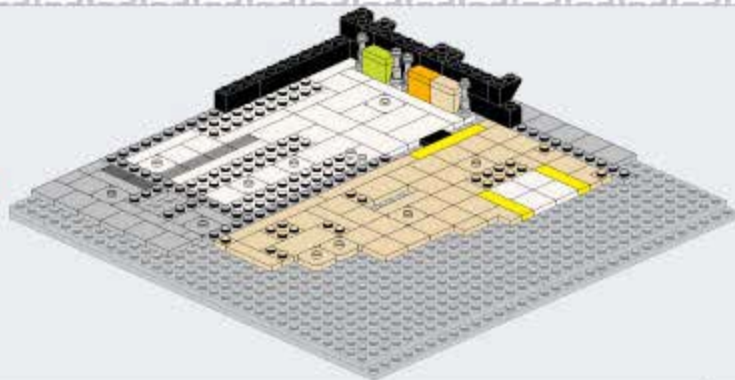

9

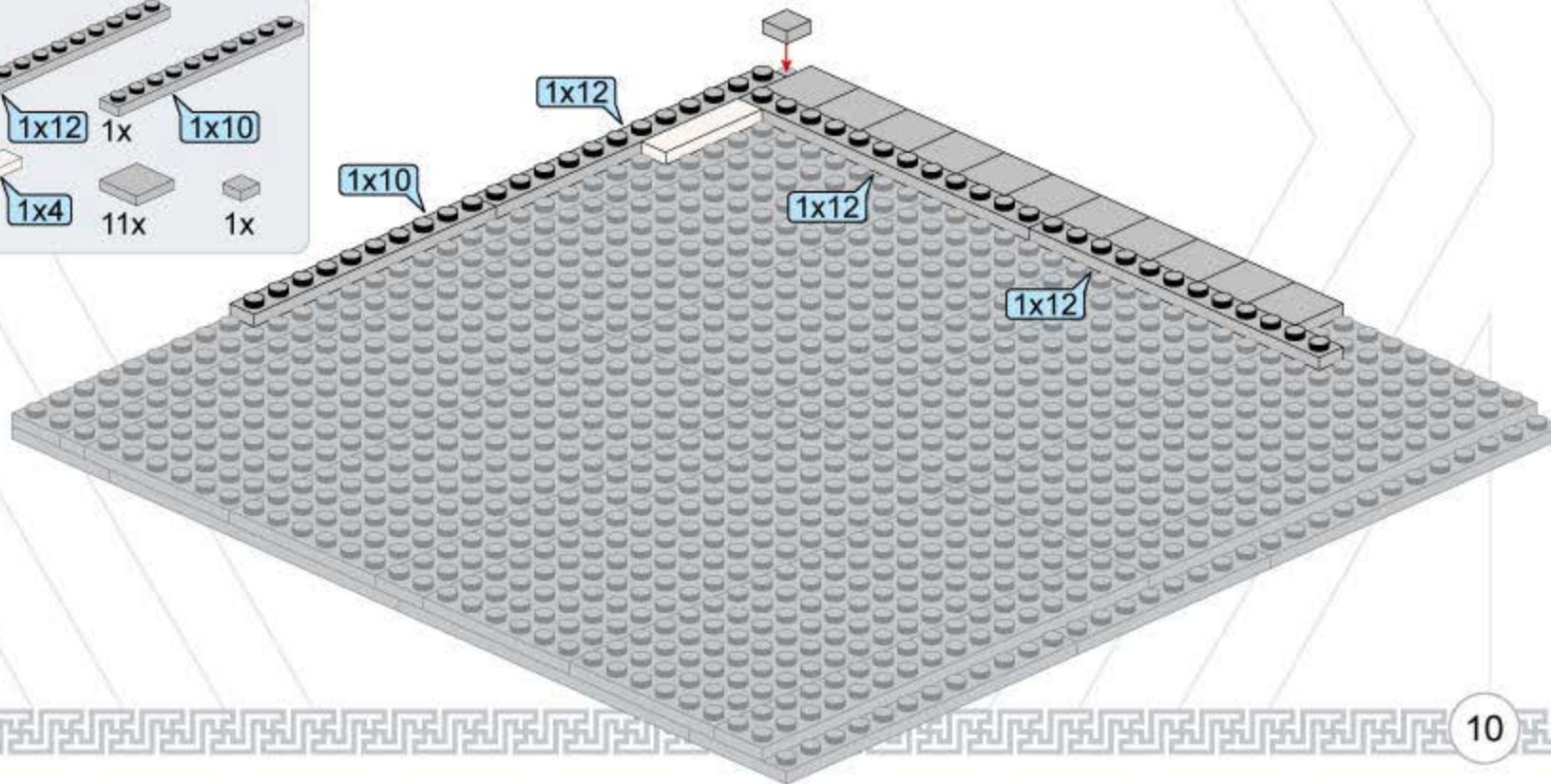
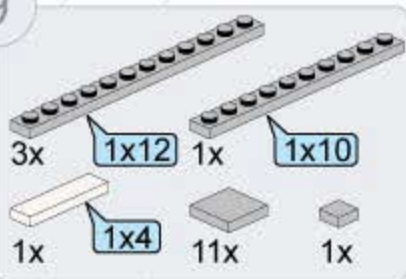

10

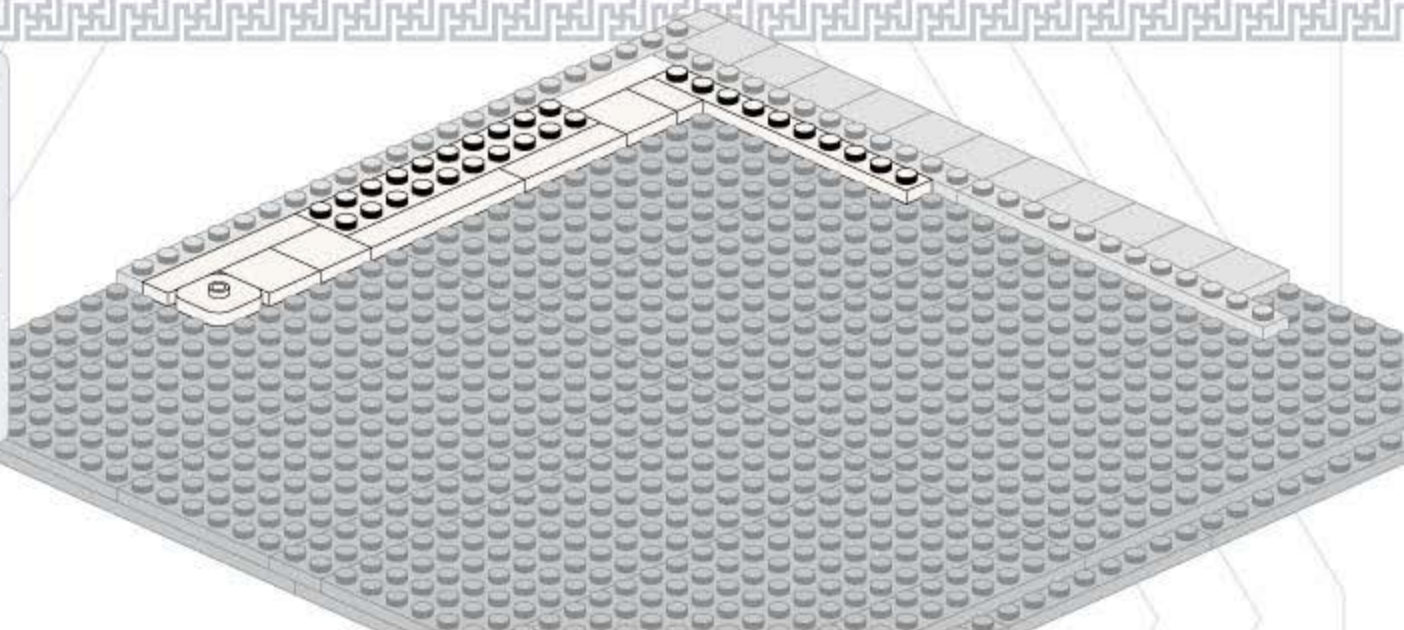
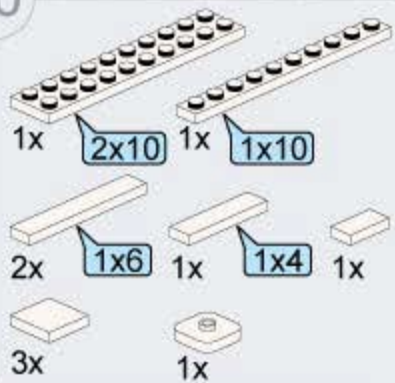

11

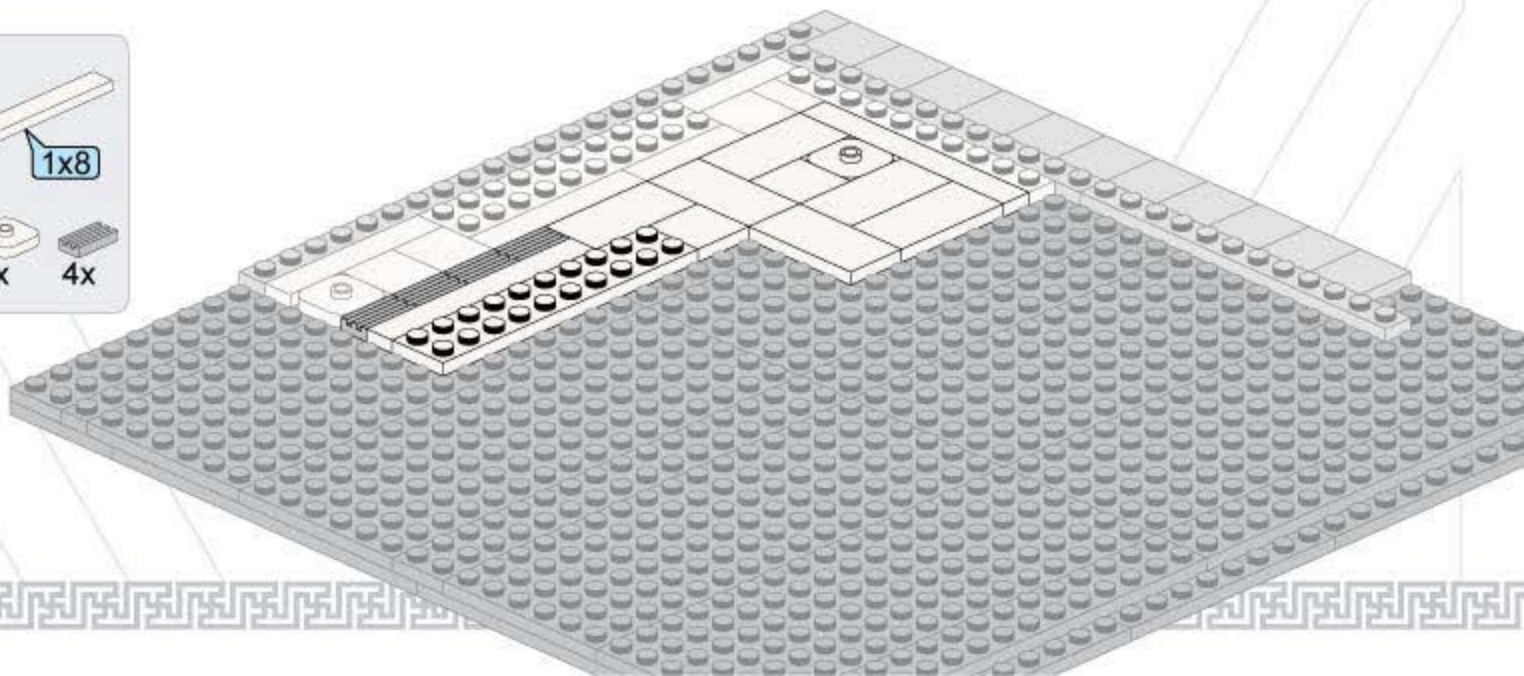
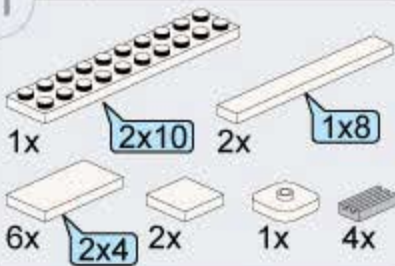

11

12

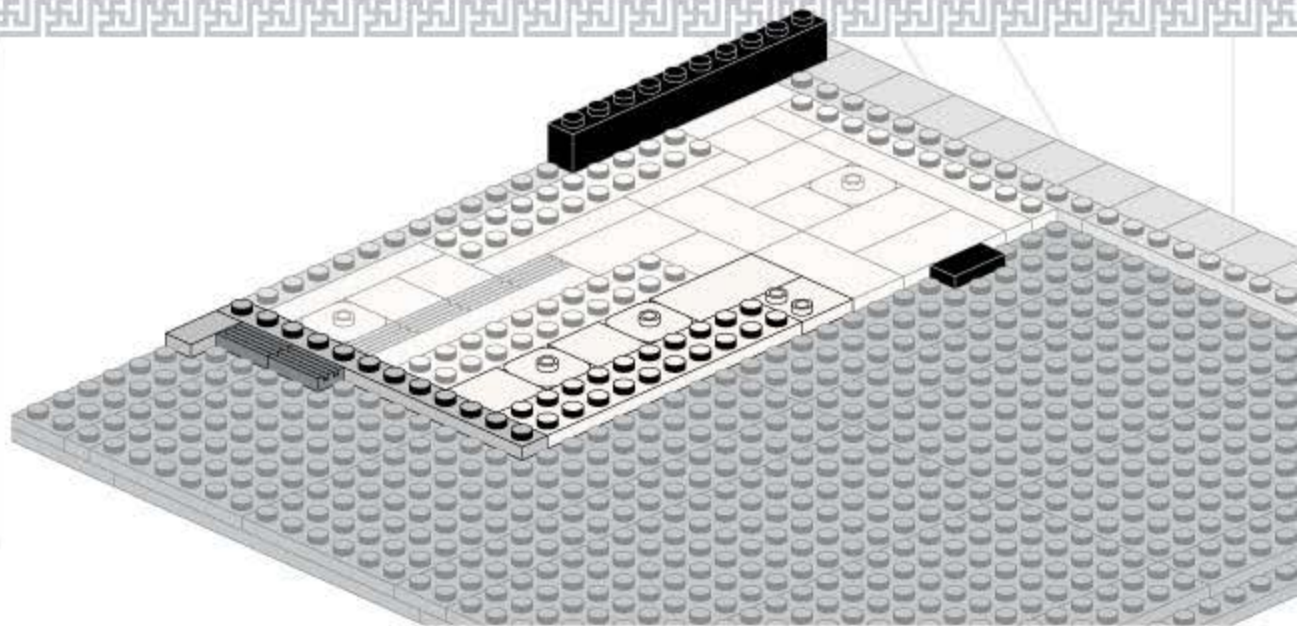
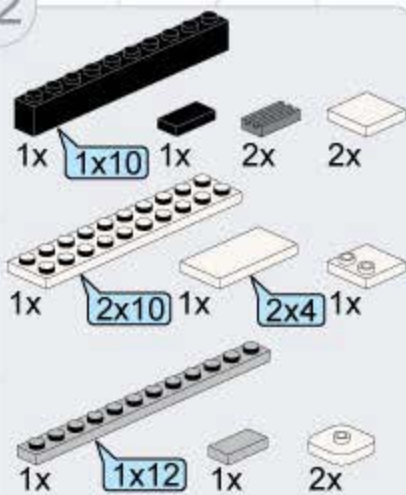

13

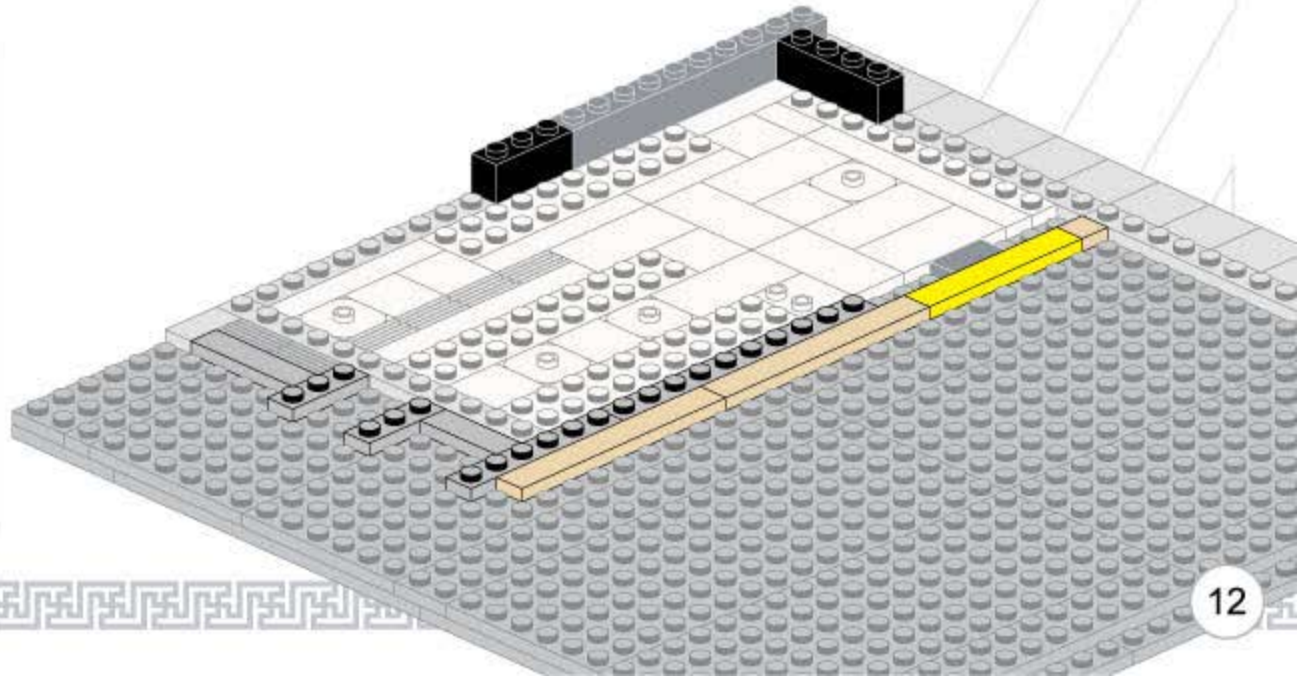
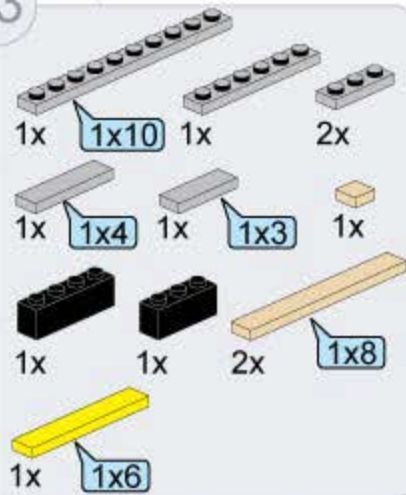

14

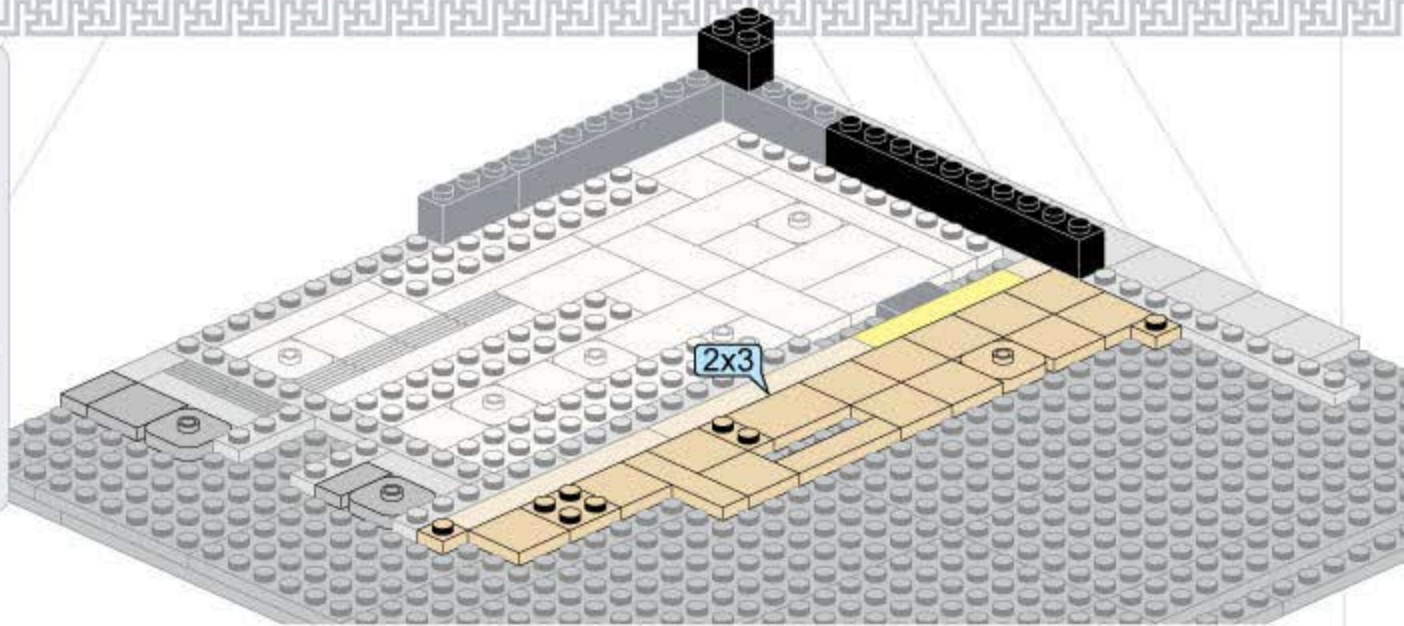
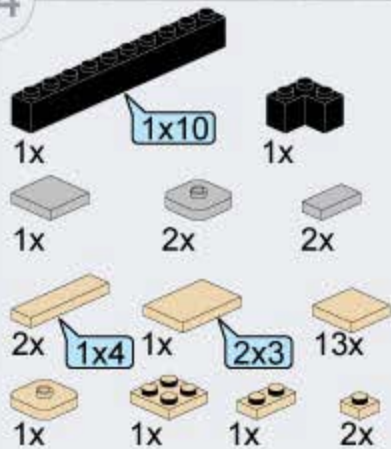

15

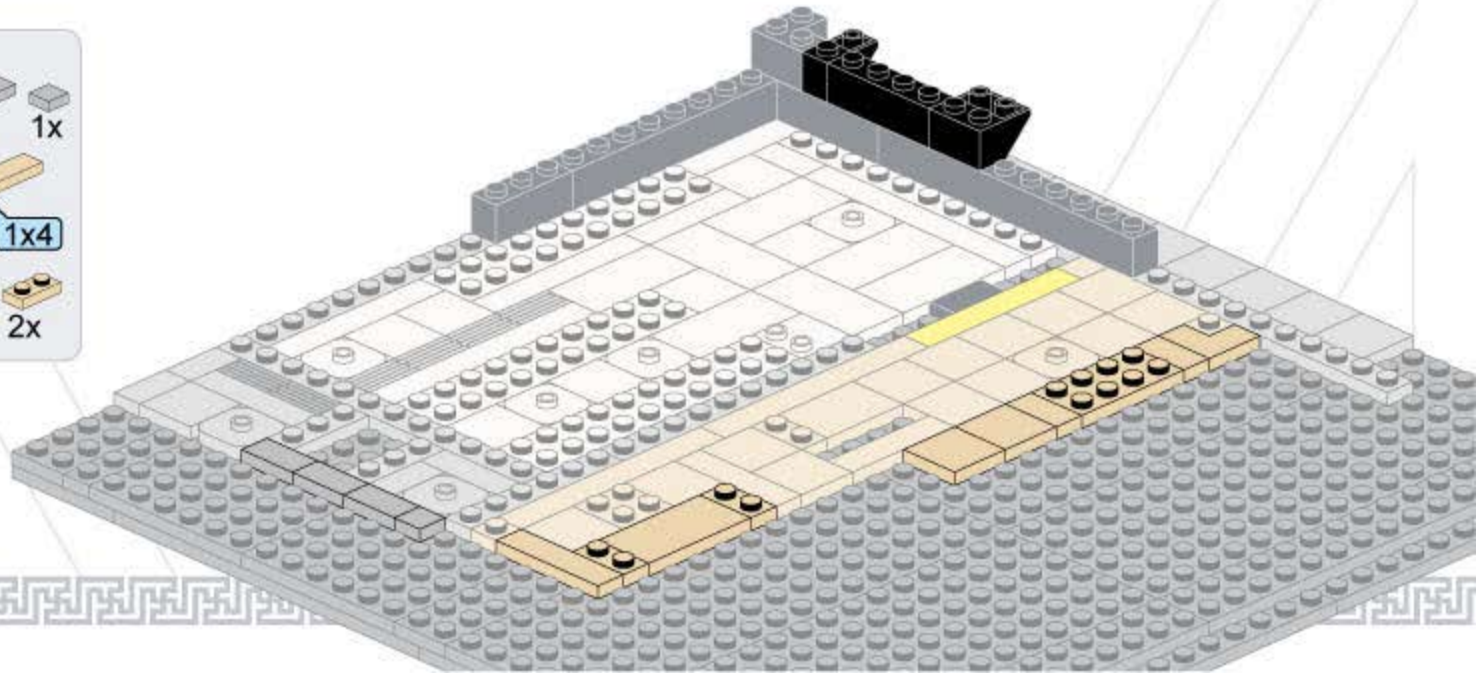
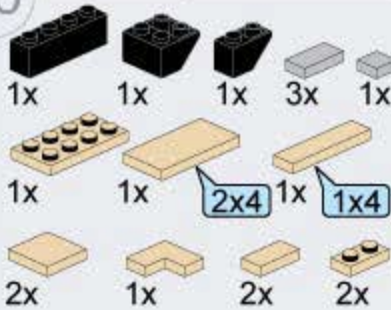

13

16

- 1x
- 3x
- 6x
- 1x
- 2x
- 1x4
- 4x
- 1x
- 1x
- 1x
- 1x
- 1x

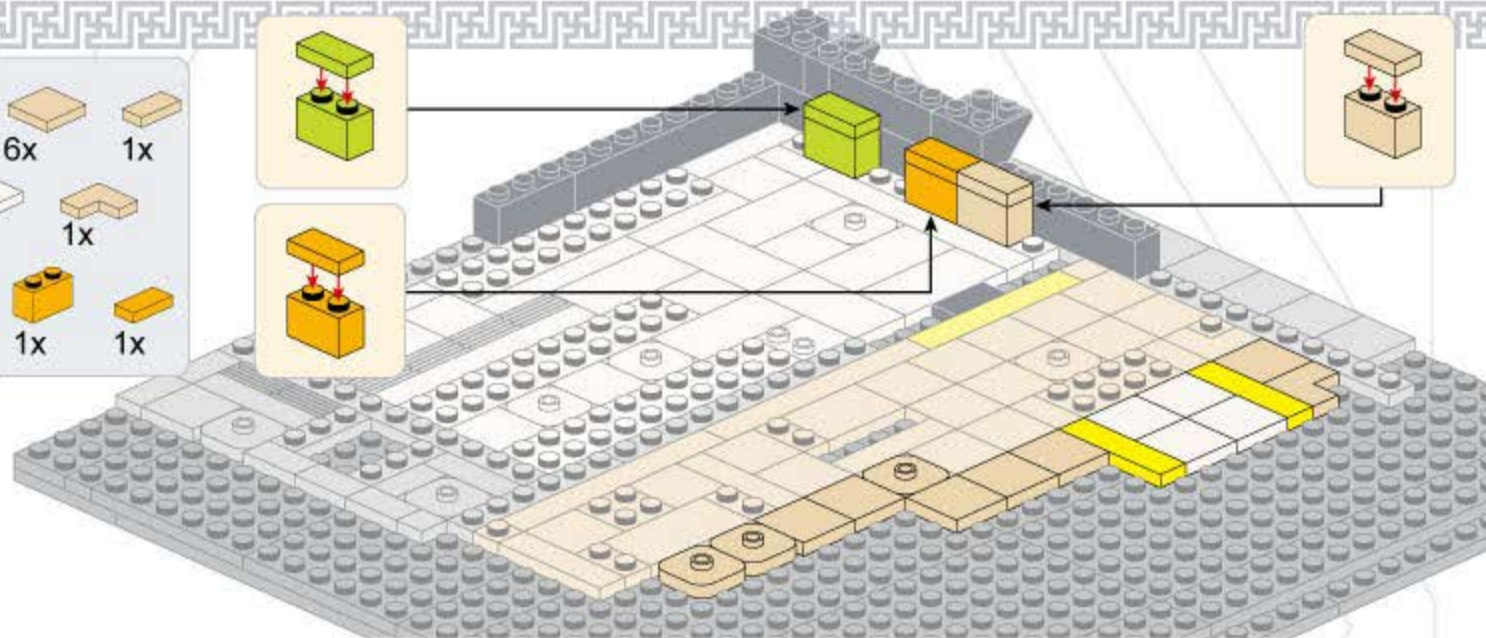
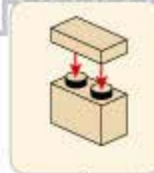
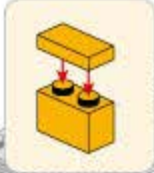
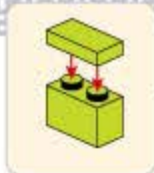

17

- 1x
- 1x
- 4x
- 6x
- 2x
- 1x
- 1x
- 1x

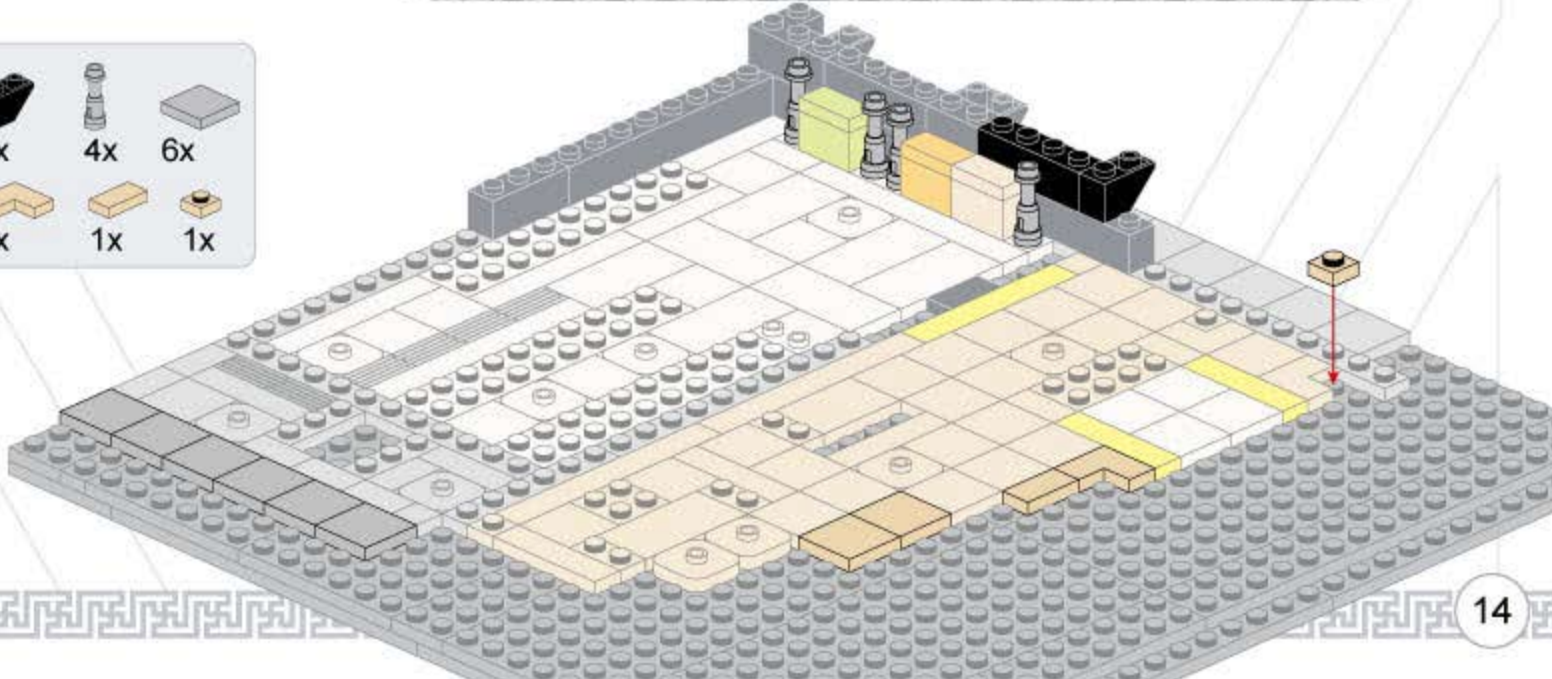



18

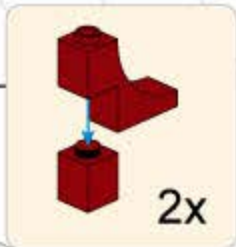
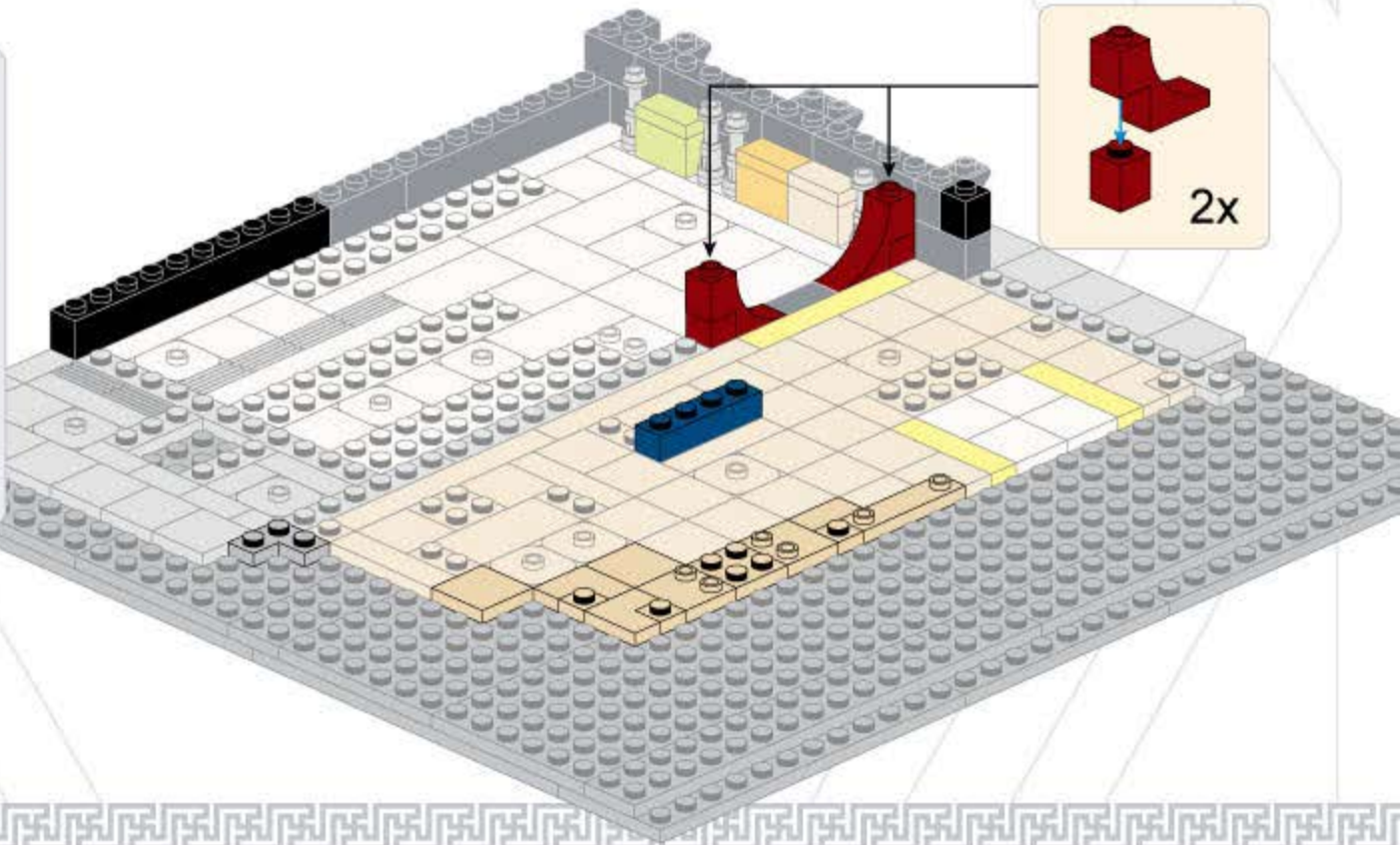

15





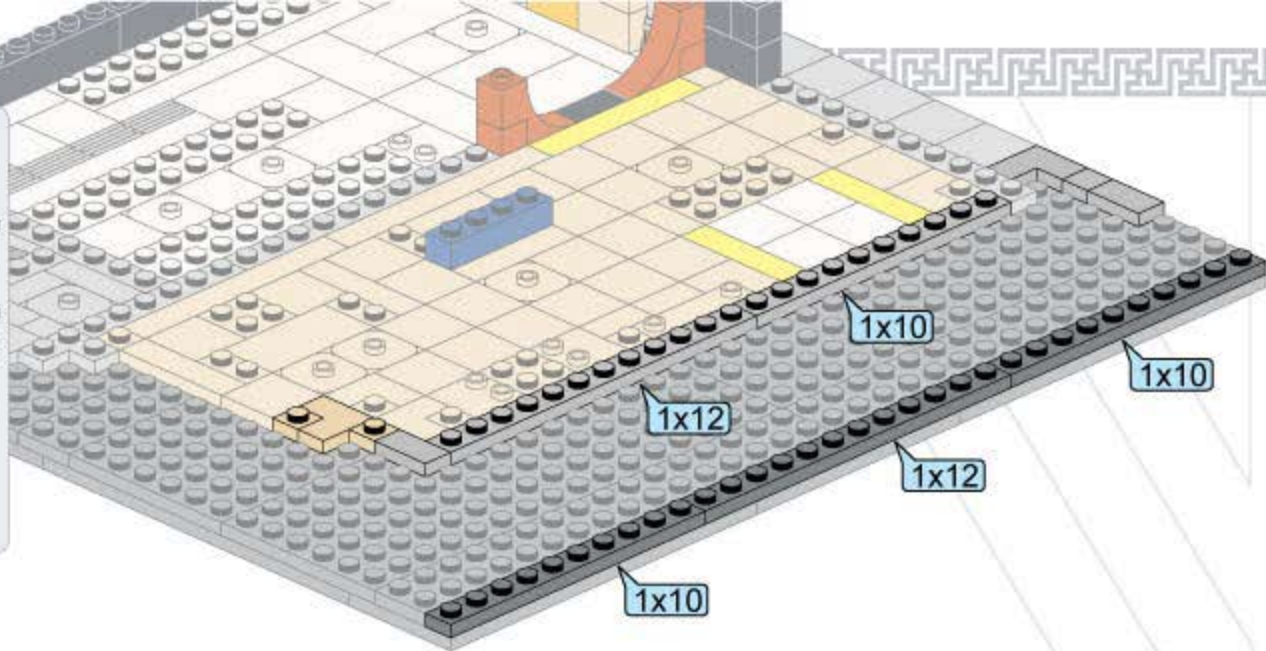
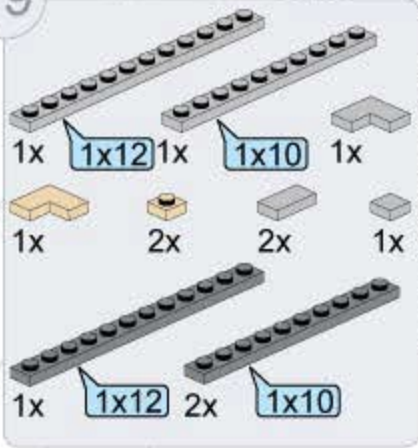



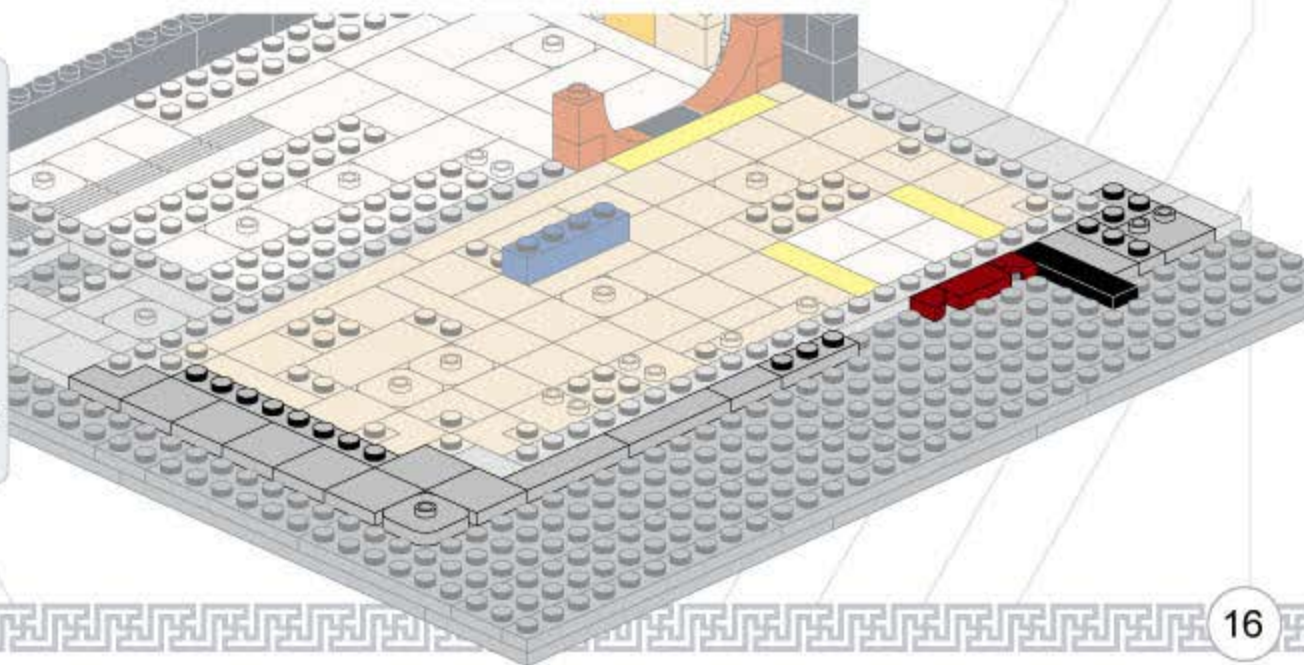
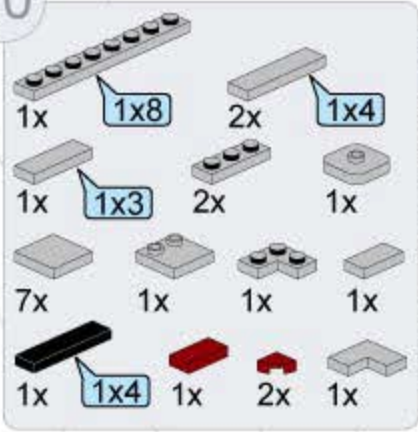

19



20







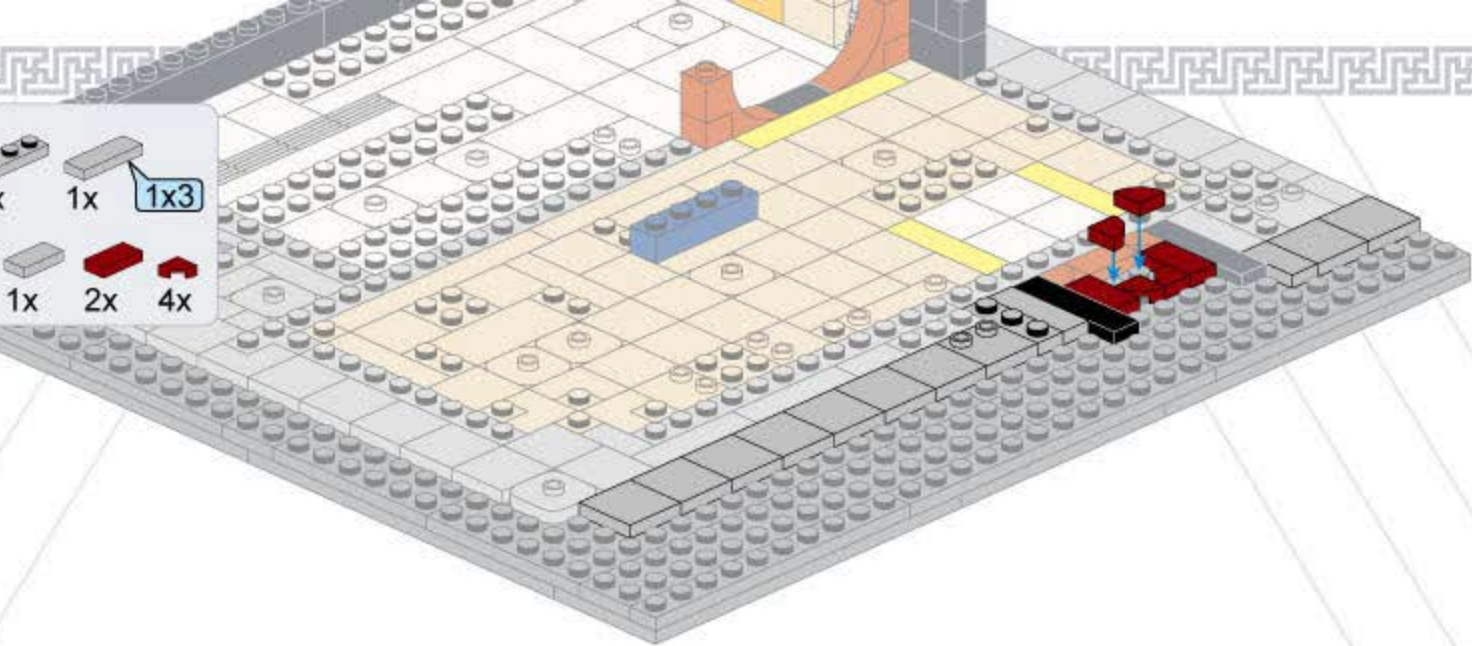

21

- 1x 
- 1x4 
- 1x 
- 1x 
- 9x 
- 1x 
- 1x 
- 2x 
- 4x 



22

- 13x 
- 5x 
- 2x 
- 3x 
- 1x 
- 2x 

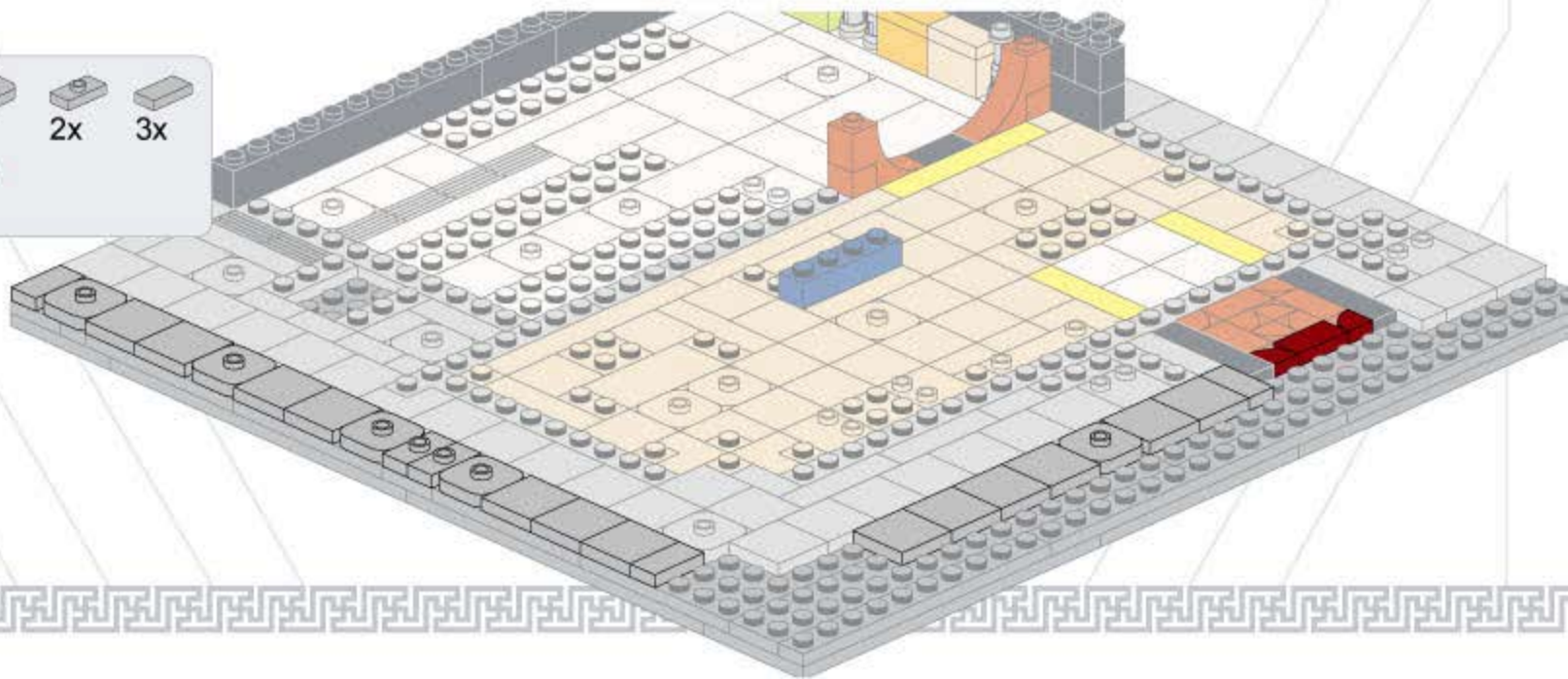





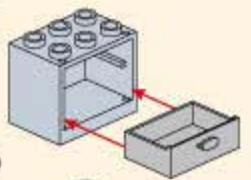
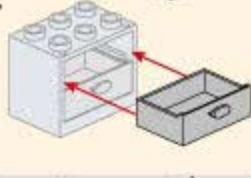

23

- 1x  1x4
- 2x 
- 1x 
- 6x 
- 1x 
- 2x 

- 
- 

24

- 1x  1x8
- 2x 
- 1x 
- 1x 
- 1x 
- 2x 
- 1x 

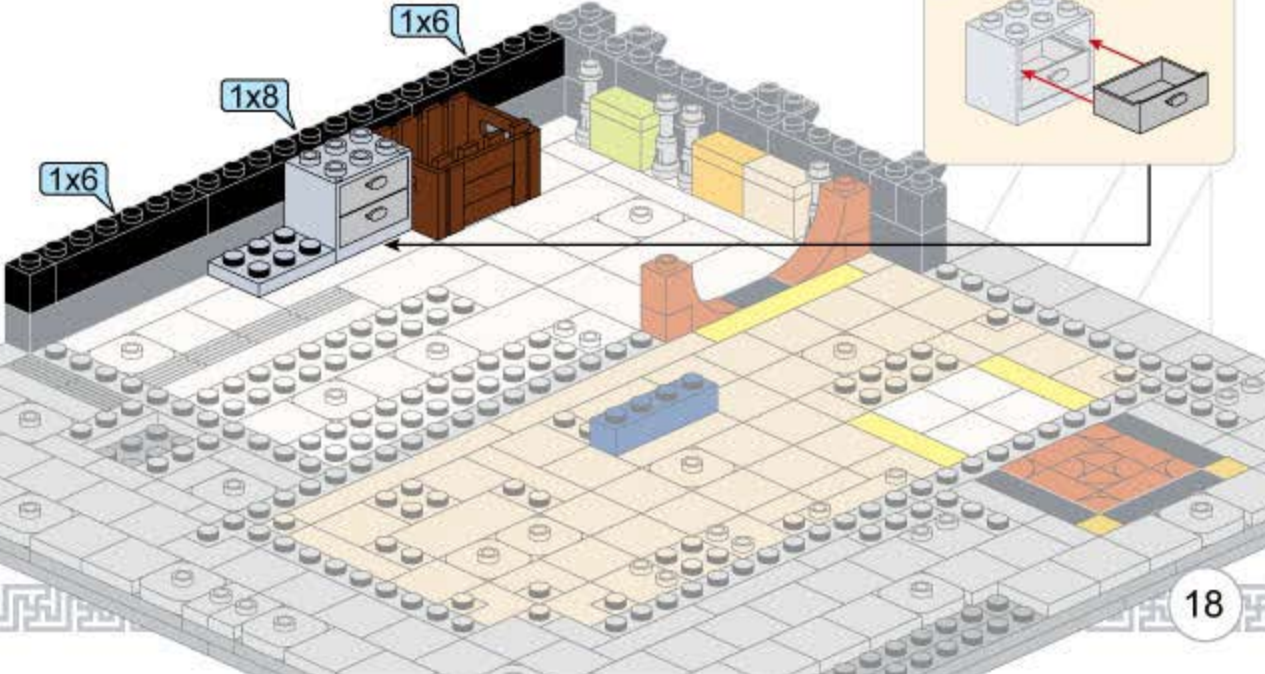

25

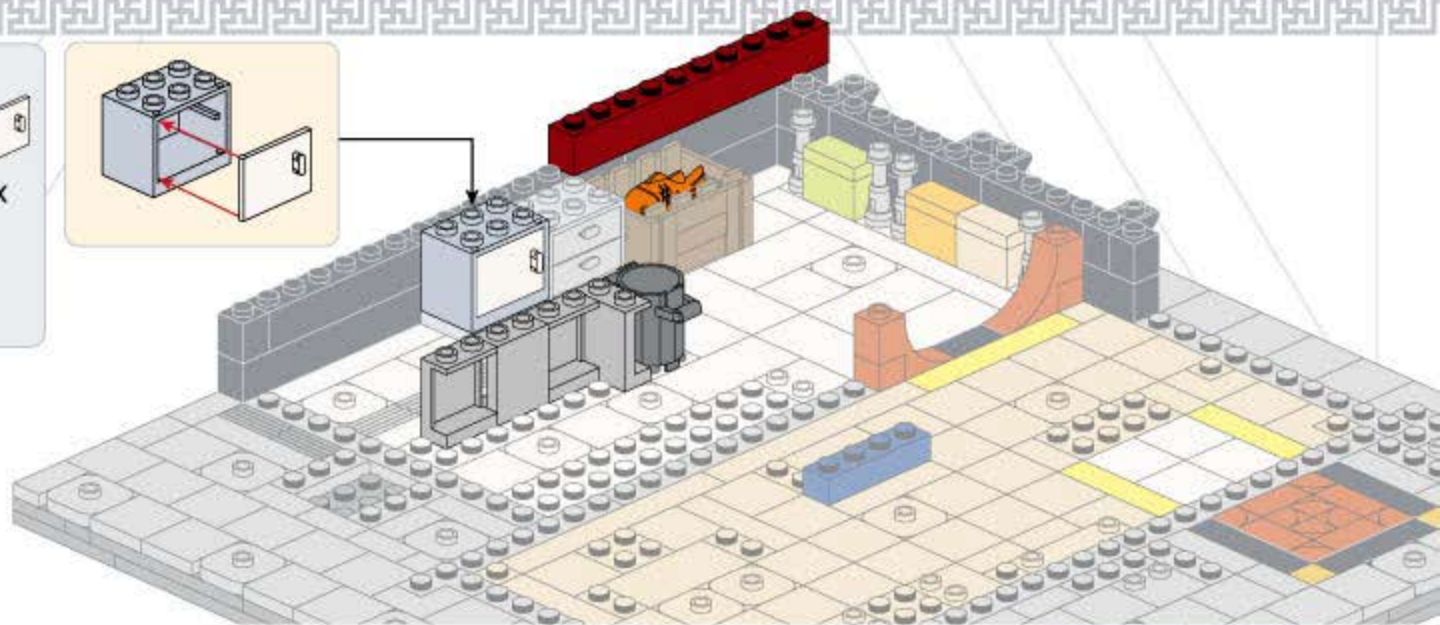
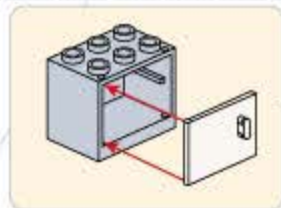
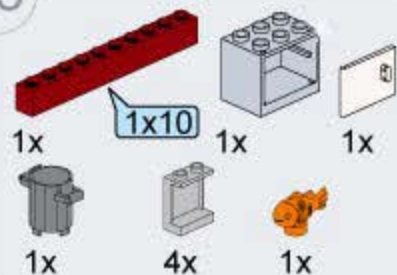

26

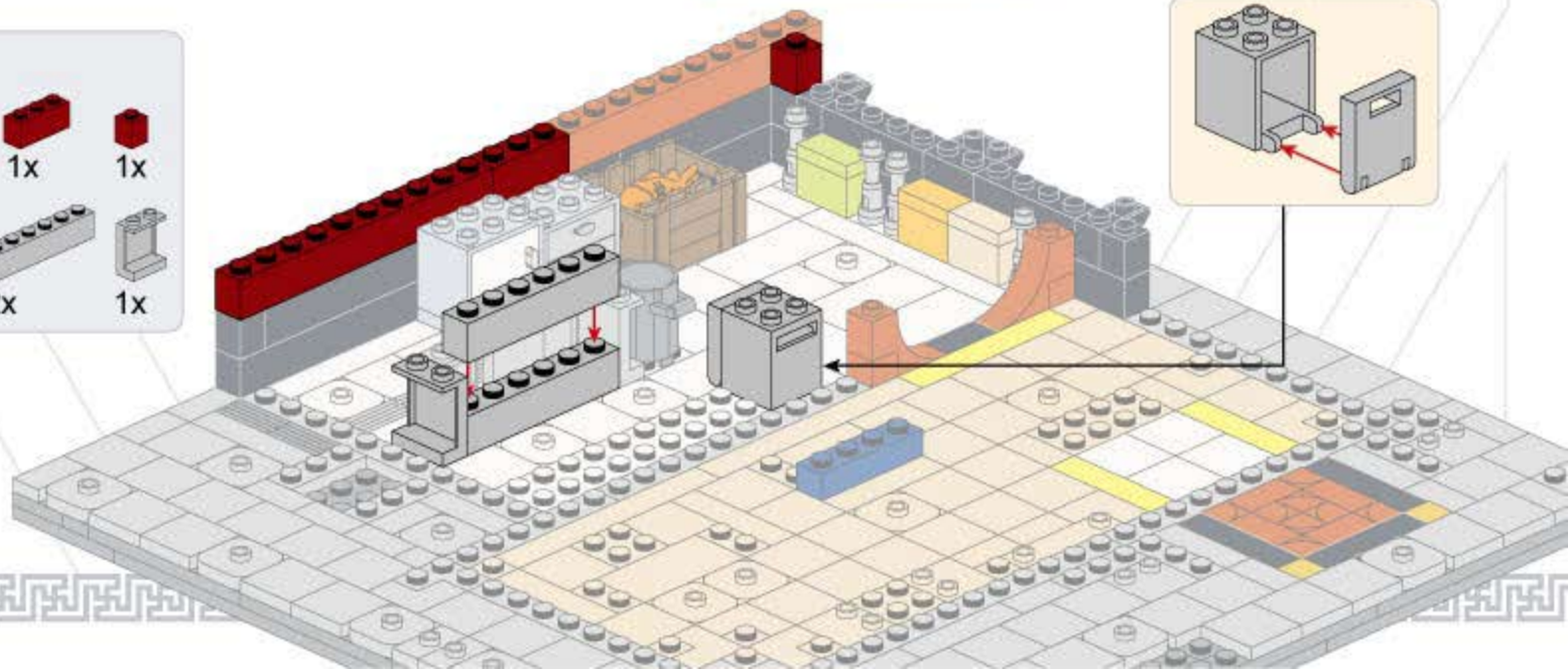
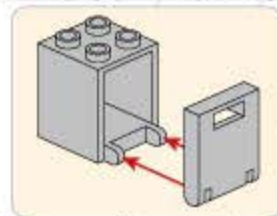
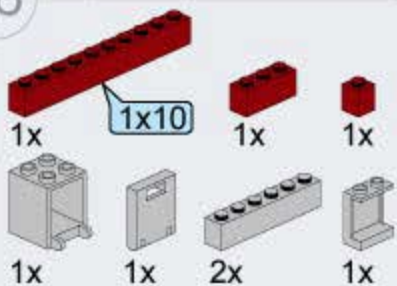

27

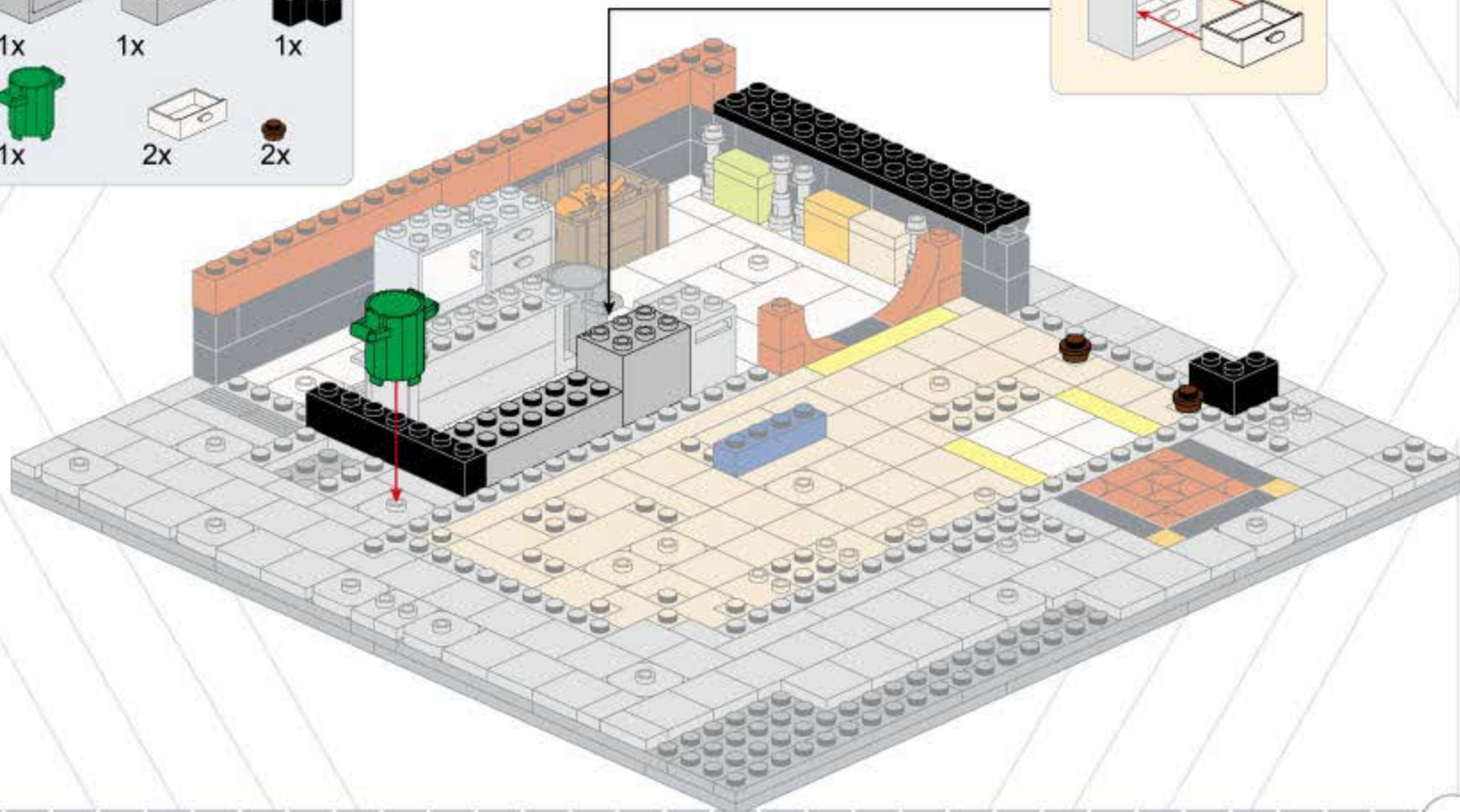
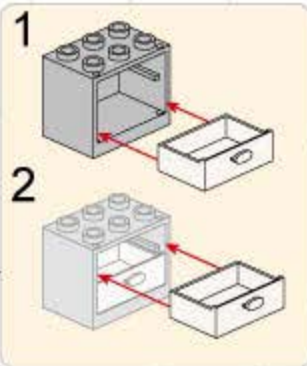
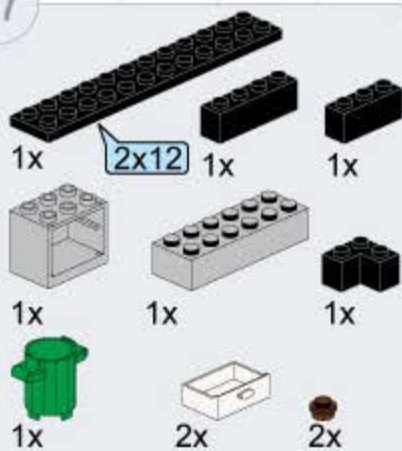

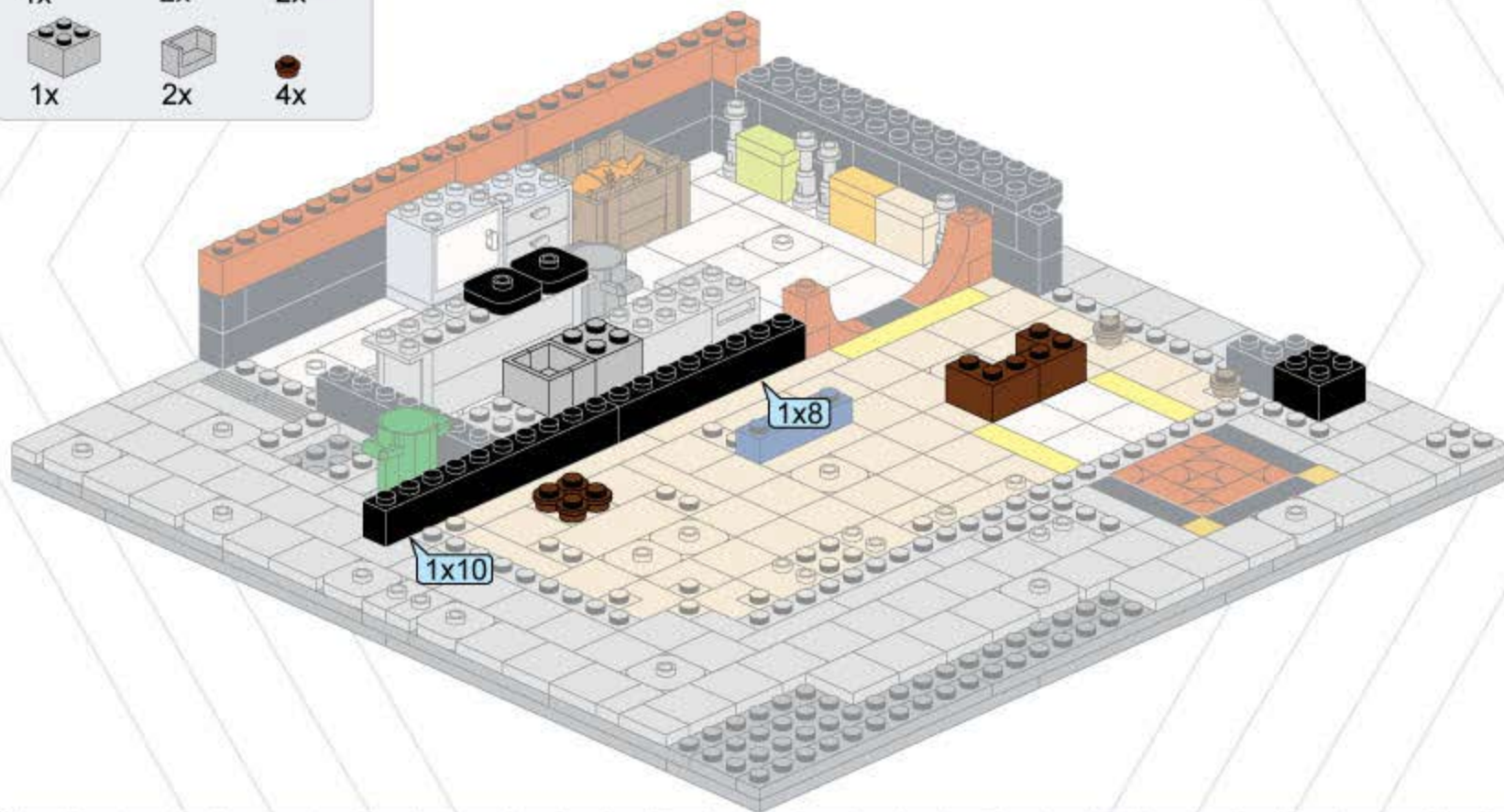
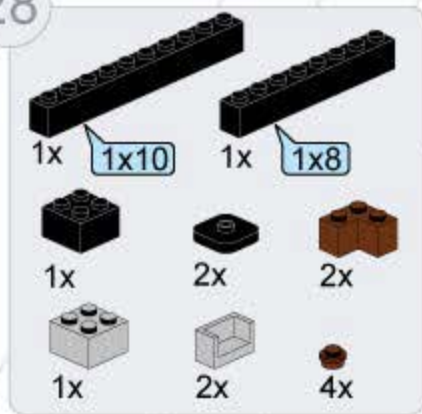



4





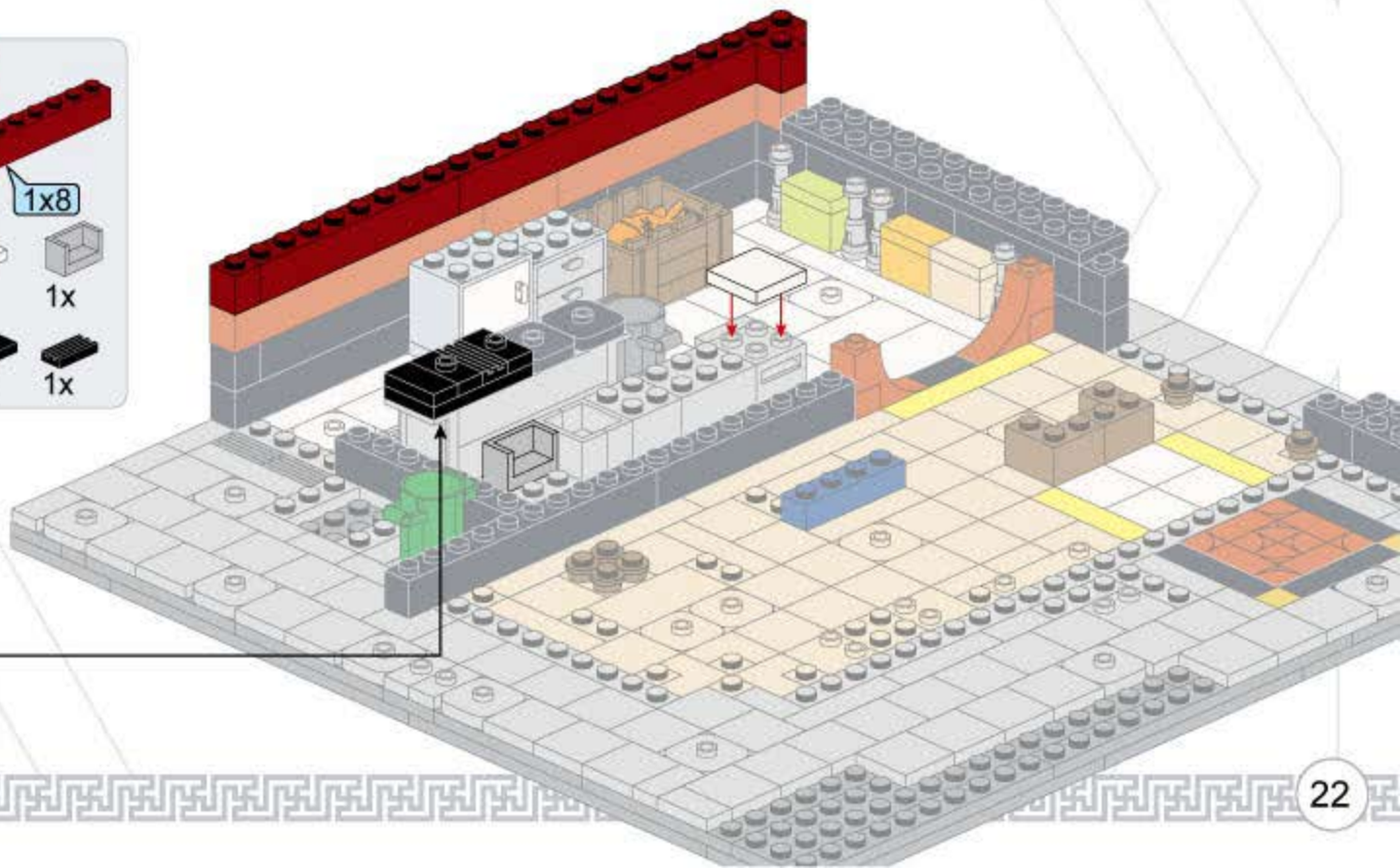
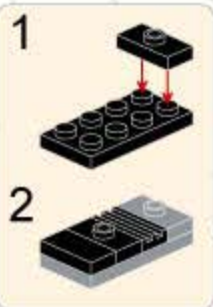
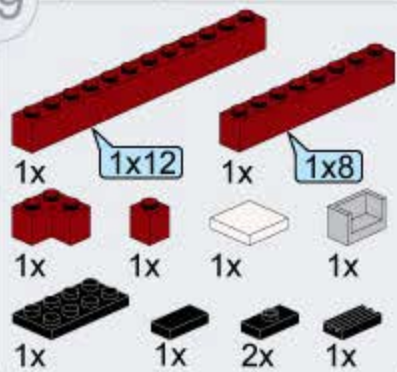











29



22

30

- 2x  1x10
- 1x  1x2
- 1x  1x1
- 1x  1x1
- 2x  1x2
- 7x  1x1
- 3x  1x1
- 1x  1x1
- 1x  1x1
- 1x  1x2
- 2x  1x1
- 1x  1x1
- 1x  1x1
- 6x  1x1

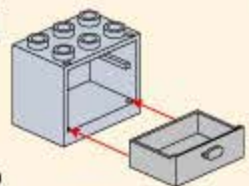
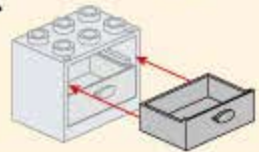
- 1 
- 2 

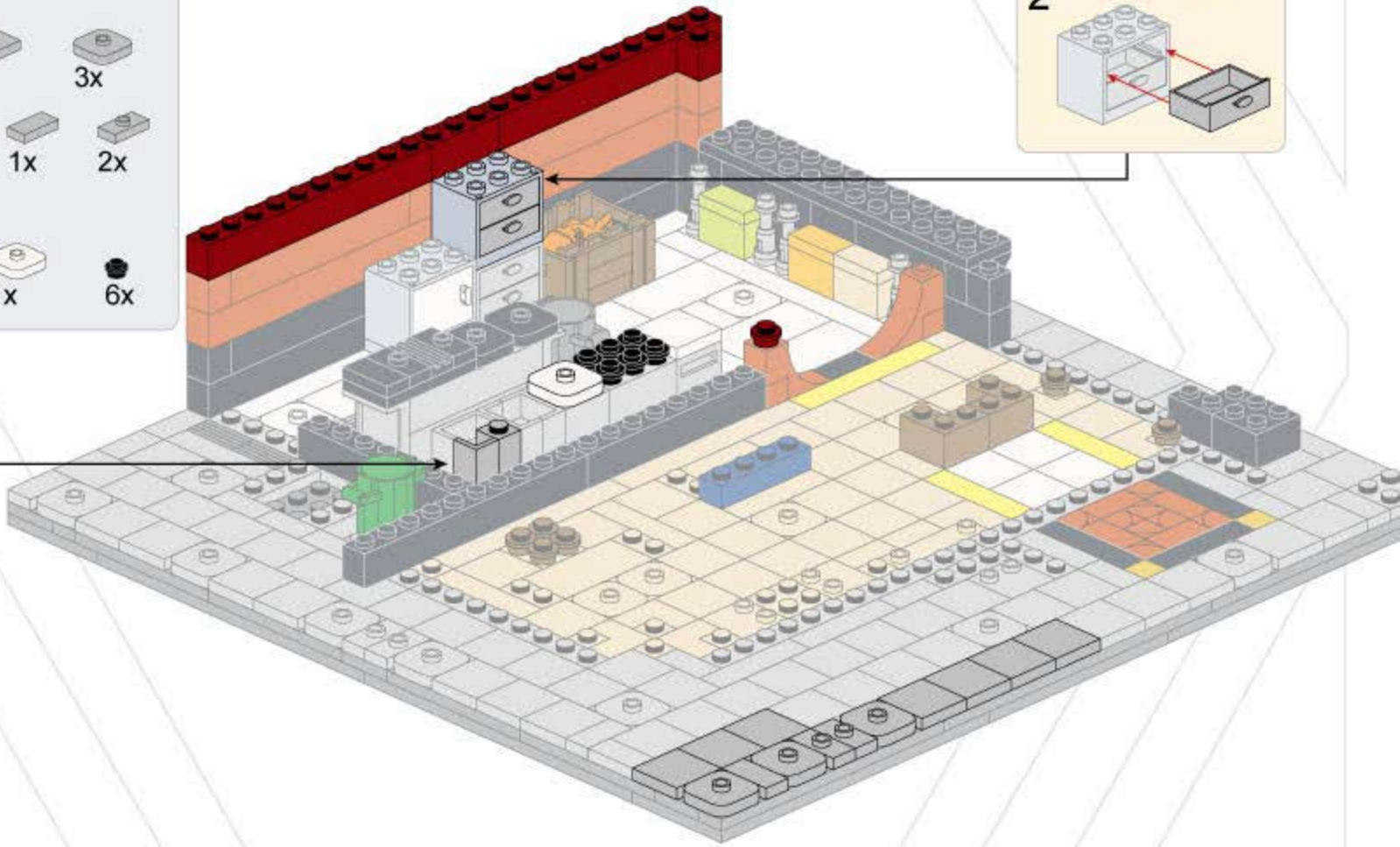

23



31

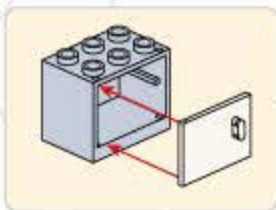
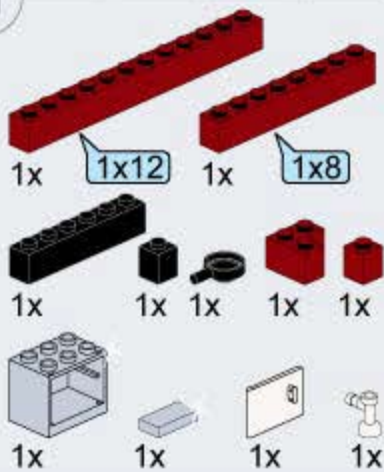

24



- 1x 
- 1x 
- 1x 
- 1x 
- 1x 
- 1x 
- 1x 
- 1x 
- 1x 

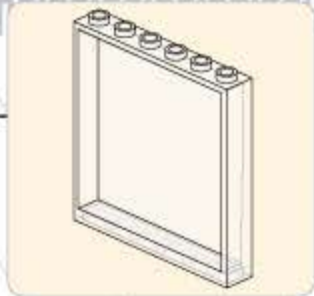
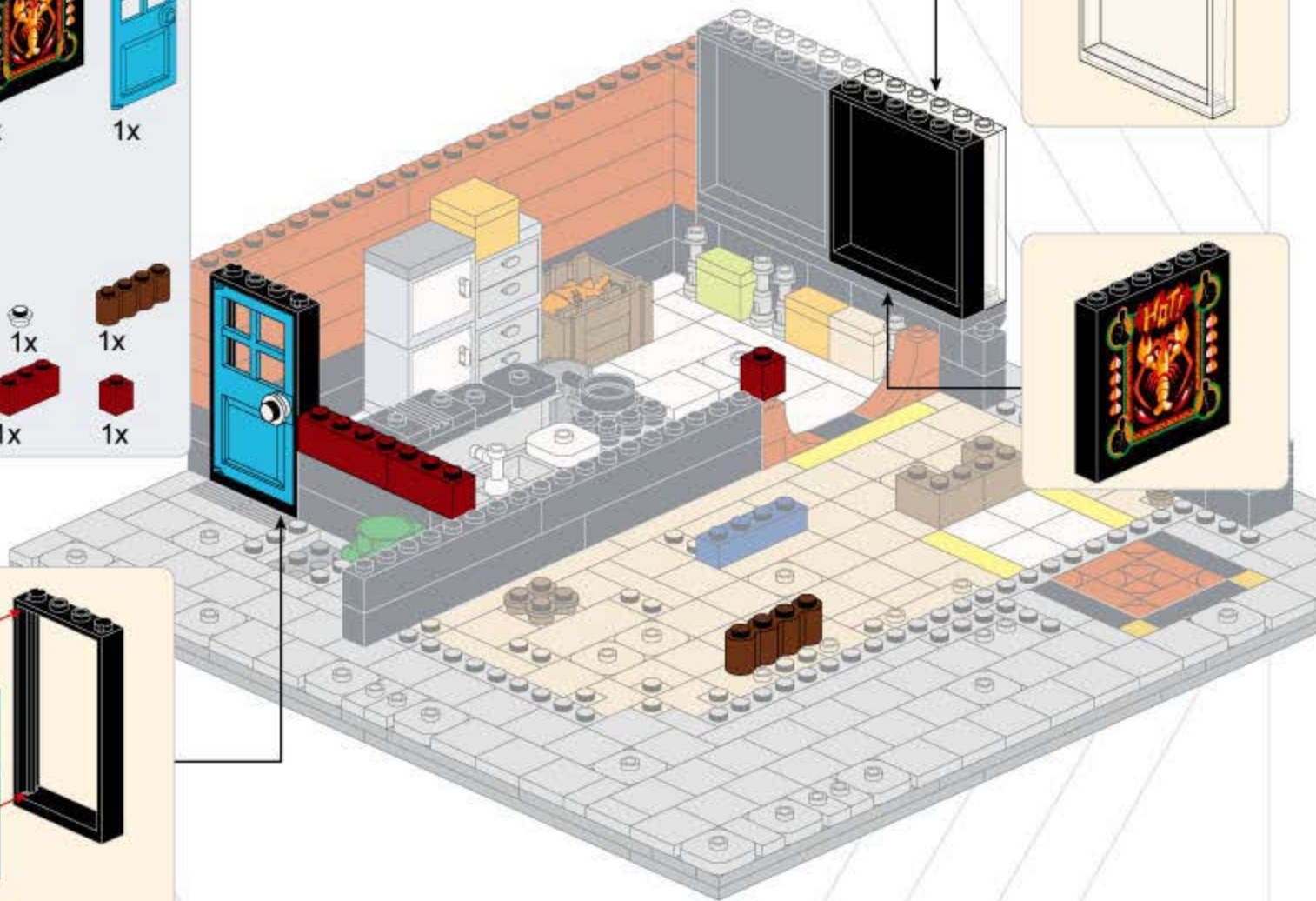



2x



2x



1x



1x

1x16



1x



1x



1x



1x



2x

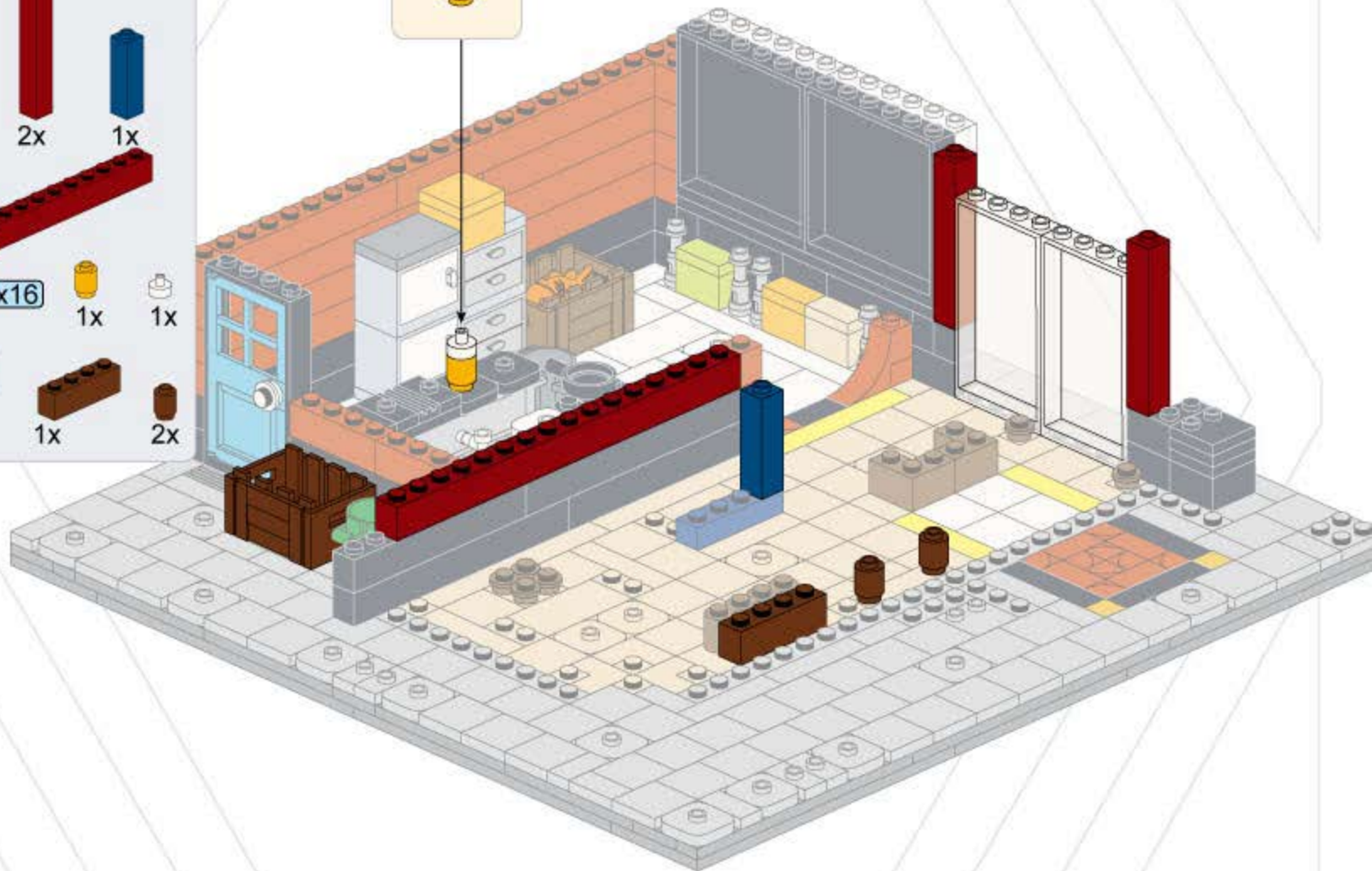

35

- |    |    |    |    |
|----|----|----|----|
|    |    |    |    |
| 1x | 1x | 3x | 4x |
|    |    |    |    |
| 2x | 3x | 1x | 2x |
|    |    |    |    |
| 1x | 1x | 1x | 1x |
|    |    |    |    |
| 1x | 1x | 1x | 4x |



- 1
- 2
- 3
- 4

- 1
- 2
- 3



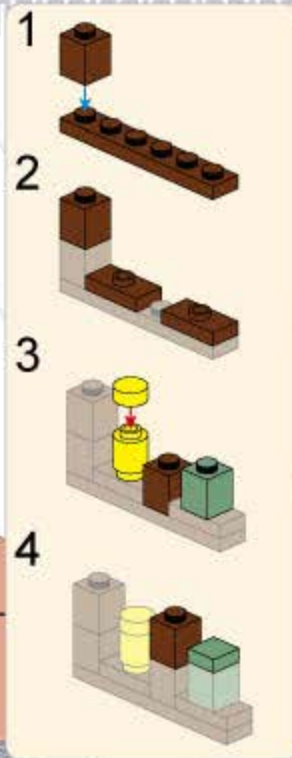
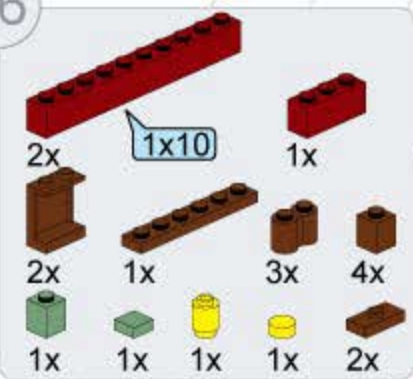

37

- 6x [Black 1x2 Technic Brick]
- 2x [Black 1x6 Technic Brick]
- 1x [Blue 1x2 Technic Brick]
- 1x [Blue 1x1 Technic Brick]
- 2x [Brown 1x2 Technic Brick]
- 1x [Brown 1x6 Technic Brick]
- 4x [Brown 1x4 Technic Brick]
- 2x [Brown 1x2 Technic Brick]
- 1x [Grey 1x2 Technic Brick]
- 1x [White 1x2 Technic Brick]
- 1x [White 1x1 Technic Brick]
- 1x [White 1x1 Technic Brick]
- 8x [Yellow 1x2 Technic Brick]
- 4x [Green 1x2 Technic Brick]
- 2x [Green 1x1 Technic Brick]

- 1 [Brown 1x2 Technic Brick] on top of [Brown 1x6 Technic Brick]
- 2 [Blue 1x2 Technic Brick] on top of [Brown 1x2 Technic Brick]
- 3 [Blue 1x2 Technic Brick] and [White 1x1 Technic Brick] on top of [Grey 1x2 Technic Brick]
- 4 [Blue 1x2 Technic Brick] and [White 1x1 Technic Brick] on top of [Grey 1x2 Technic Brick]

- 1 [Black 1x6 Technic Brick] on top of [Brown 1x6 Technic Brick]
- 2 [Black 1x6 Technic Brick] on top of [Yellow 1x2 Technic Brick]
- 3 [Green 1x2 Technic Brick] on top of [Black 1x6 Technic Brick]

- 1 [Black 1x6 Technic Brick] on top of [Brown 1x6 Technic Brick]
- 2 [Black 1x6 Technic Brick] on top of [Yellow 1x2 Technic Brick]
- 3 [Green 1x2 Technic Brick] on top of [Black 1x6 Technic Brick]

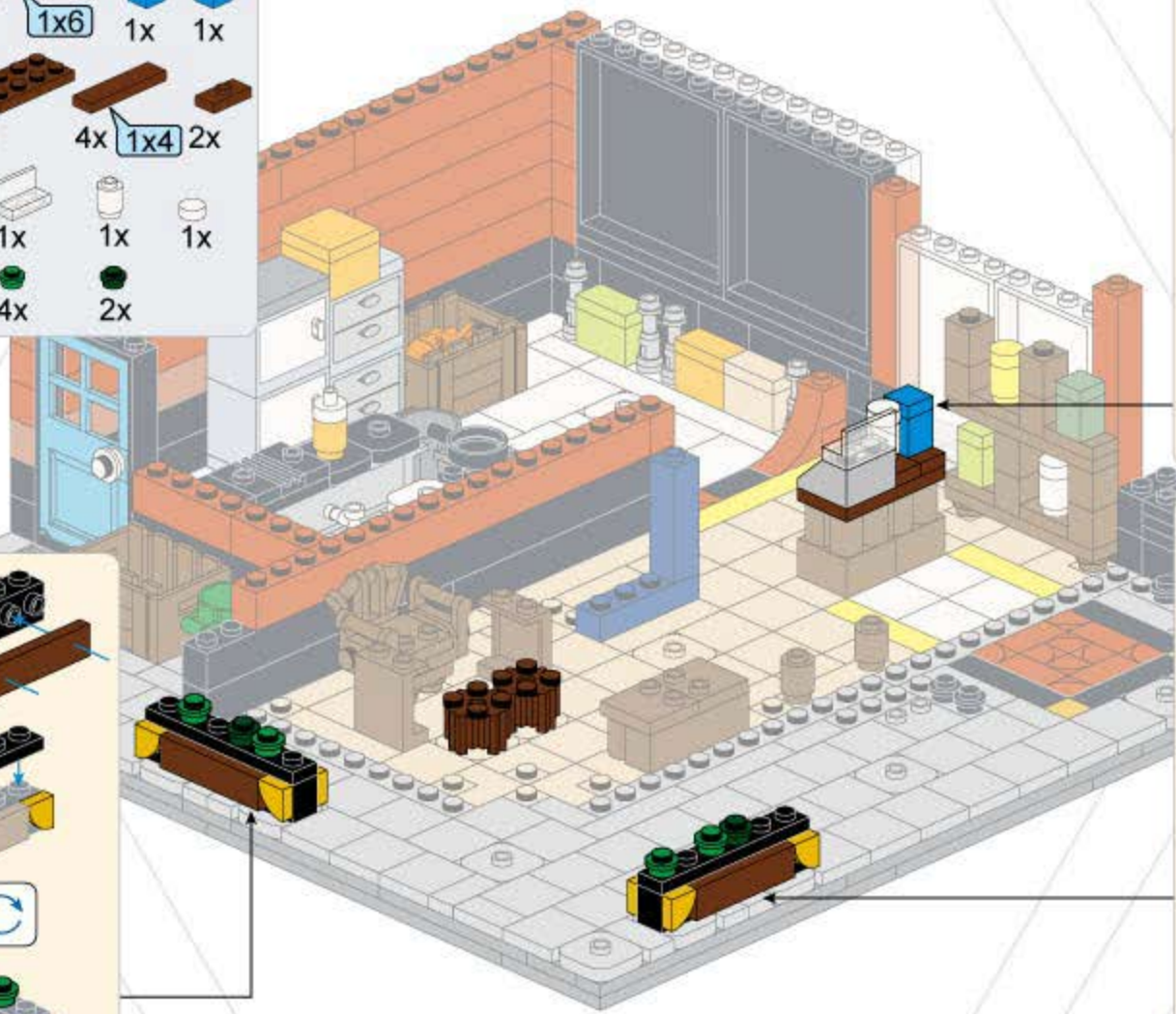



38



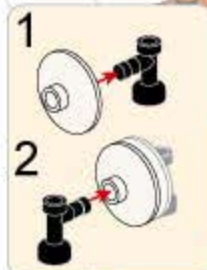
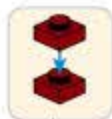



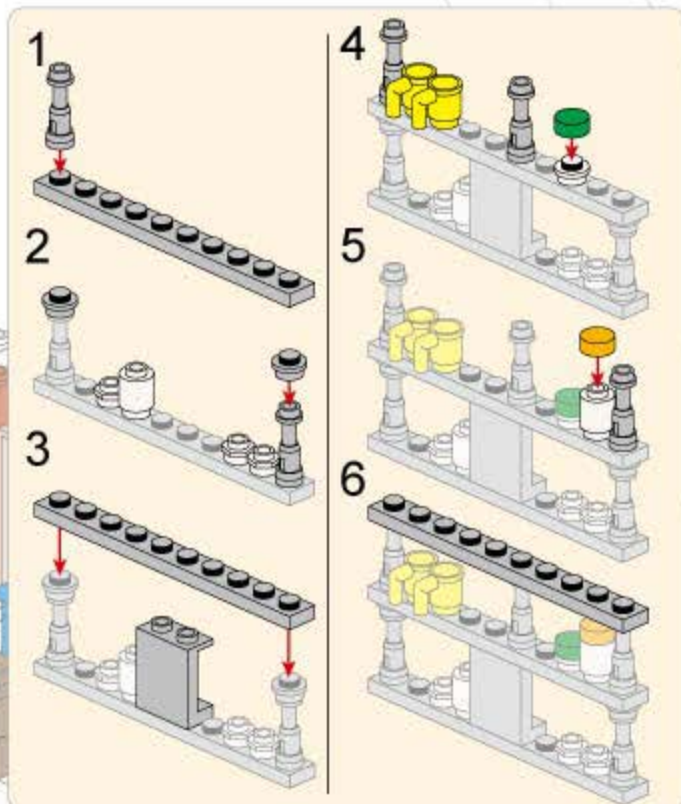





- |    |    |    |    |
|----|----|----|----|
|    |    |    |    |
| 3x | 1x | 5x | 2x |
|    |    |    |    |
| 2x | 2x | 1x | 3x |
|    |    |    |    |
| 1x | 2x | 2x | 2x |
|    |    |    |    |
|    |    | 1x |    |



31





- 1x 
- 1x 
- 1x 
- 1x 
- 1x 
- 2x 
- 2x 
- 1x 
- 2x 
- 2x 
- 2x 
- 2x 

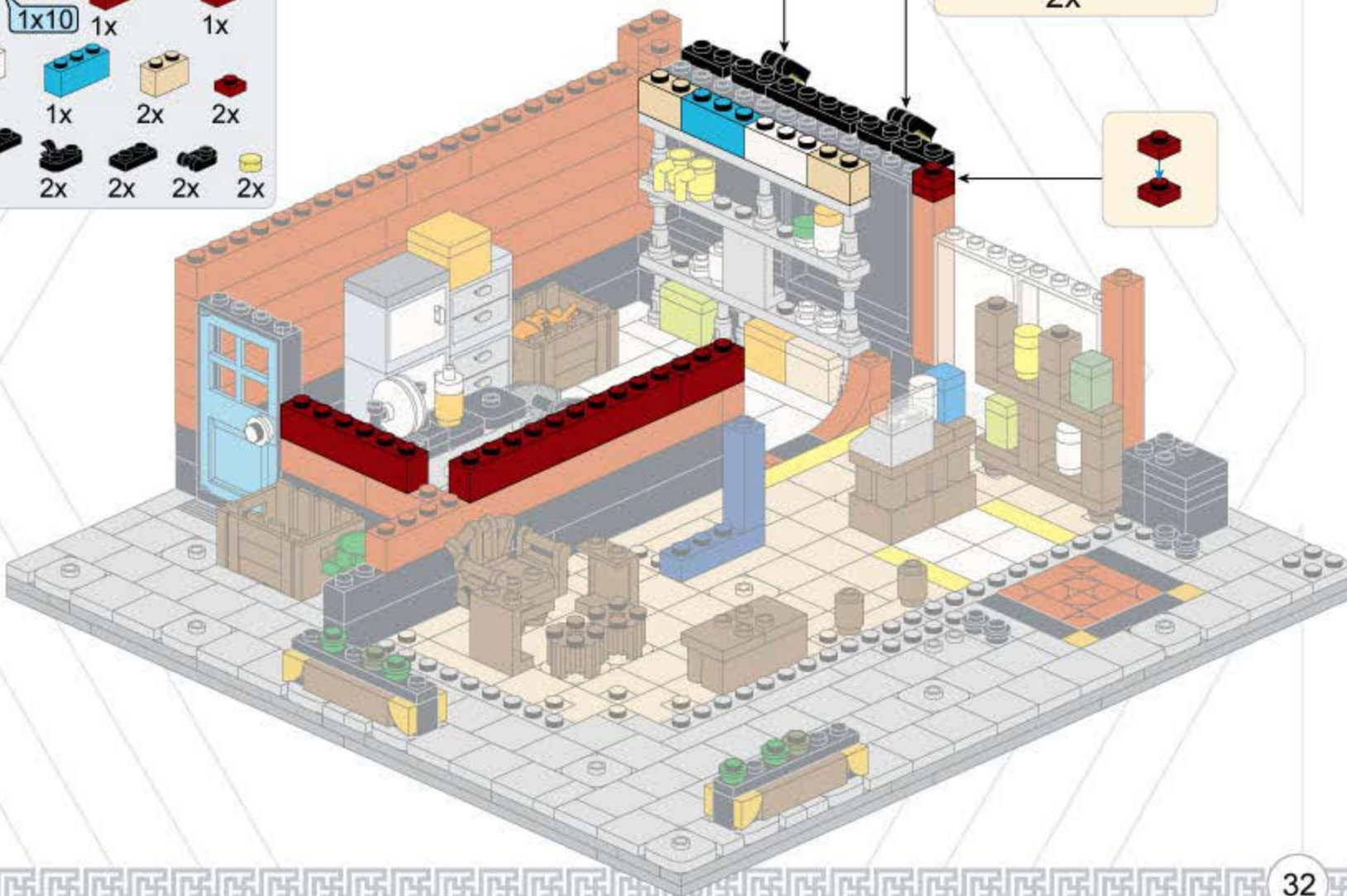
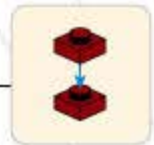
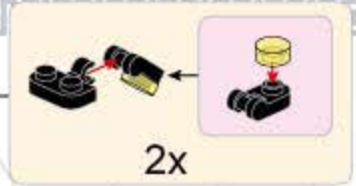

- 1x [Red 1x6 Technic Brick]
- 1x [Red 1x3 Technic Brick]
- 1x [Red 1x2 Technic Brick]
- 1x [Red 1x2 Technic Brick]
- 4x [Red 1x2 Technic Brick]
- 1x [Red 1x1 Technic Brick]
- 1x [Red 1x1 Technic Brick]
- 1x [Red 1x1 Technic Brick]
- 2x [Red 1x1 Technic Brick]
- 4x [Black 1x4 Technic Brick]
- 4x [White 1x4 Technic Brick]
- 1x [White 1x2 Technic Brick]
- 1x [Grey 1x2 Technic Brick]

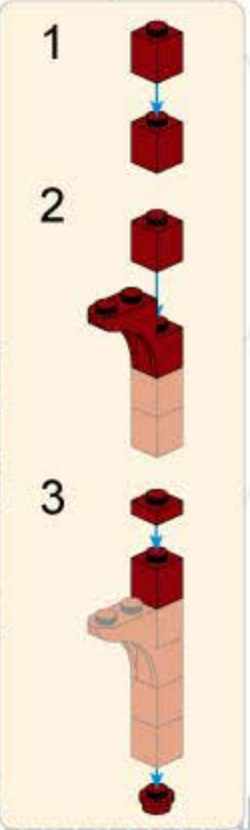
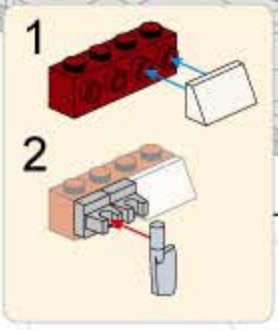
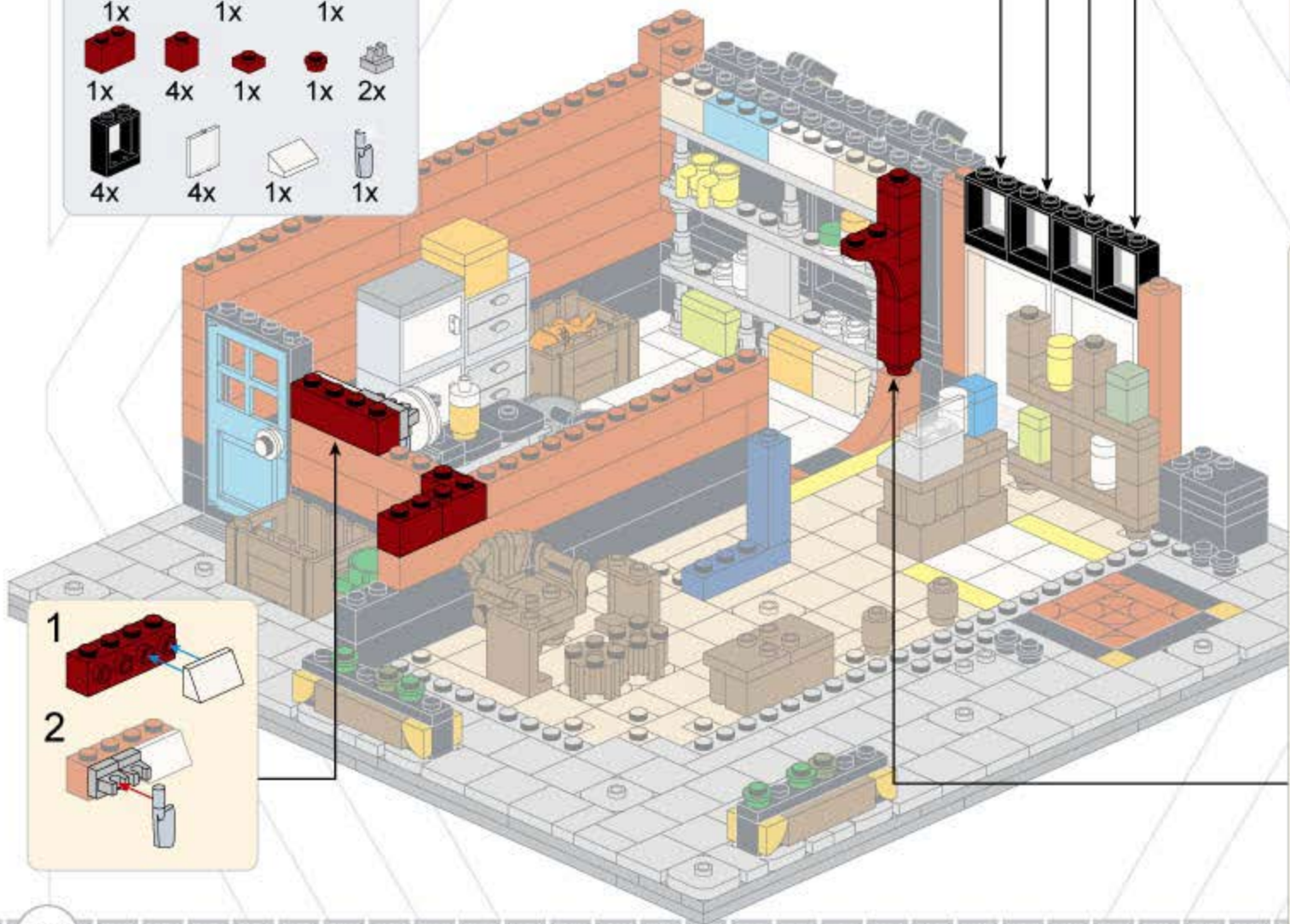
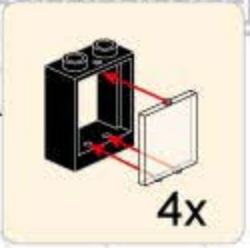

41

- 1x
- 1x
- 1x
- 1x
- 2x
- 2x
- 3x
- 1x
- 1x
- 1x
- 1x
- 1x

- 1
- 2
- 3
- 4



- 1
- 2

- |    |        |    |        |
|----|--------|----|--------|
|    |        |    |        |
| 1x | 1x     | 1x | 1x     |
|    |        |    |        |
| 1x | 1x     | 1x | 1x     |
|    |        |    |        |
| 4x | 4x     | 1x | 1x4 1x |
|    |        |    |        |
| 1x | 2x4 1x | 1x | 4x     |

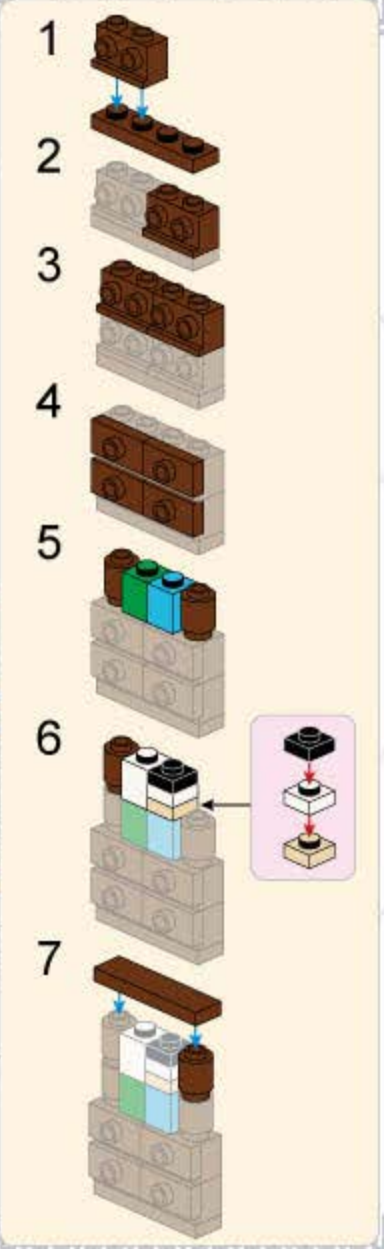
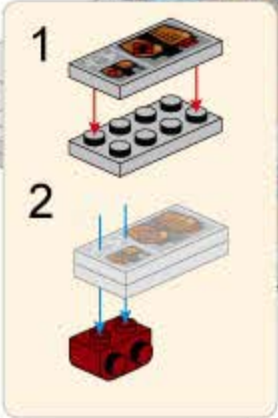
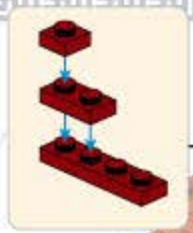

43

- 2x
- 2x
- 1x
- 1x
- 1x
- 1x
- 1x
- 1x
- 1x
- 1x
- 1x
- 1x
- 2x

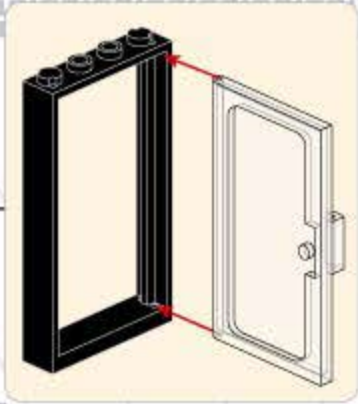
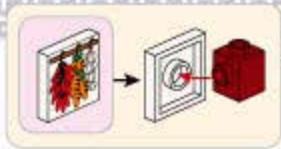

- 1
- 2
- 3

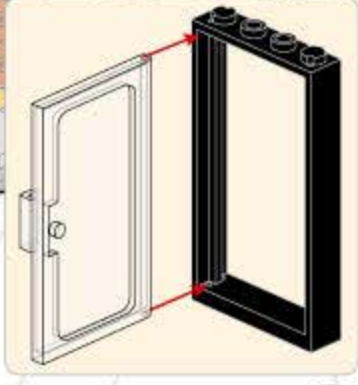

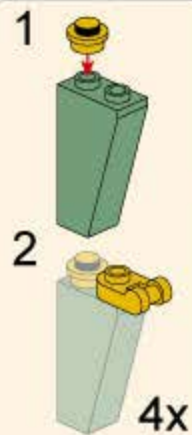
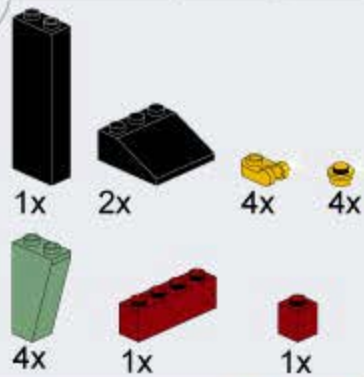

45

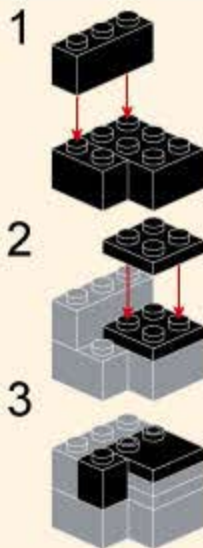
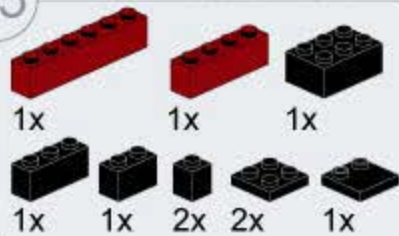

46



1



2



1



2







47

- 1x [Black 1x3 Technic Beam]
- 1x [Black 1x6 Technic Beam]
- 2x [Tan 1x2 Technic Pin]
- 1x [White 1x3 Technic Beam]
- 1x [Blue 1x3 Technic Beam]
- 2x [Brown 1x2 Technic Pin]
- 1x [Red 1x6 Technic Beam]
- 1x [Red 1x2 Technic Pin]
- 2x [Red 1x2 Technic Pin]
- 1x [Red 1x2 Technic Pin]
- 1x [Red 1x3 Technic Beam]
- 2x [Grey 1x2 Technic Pin]

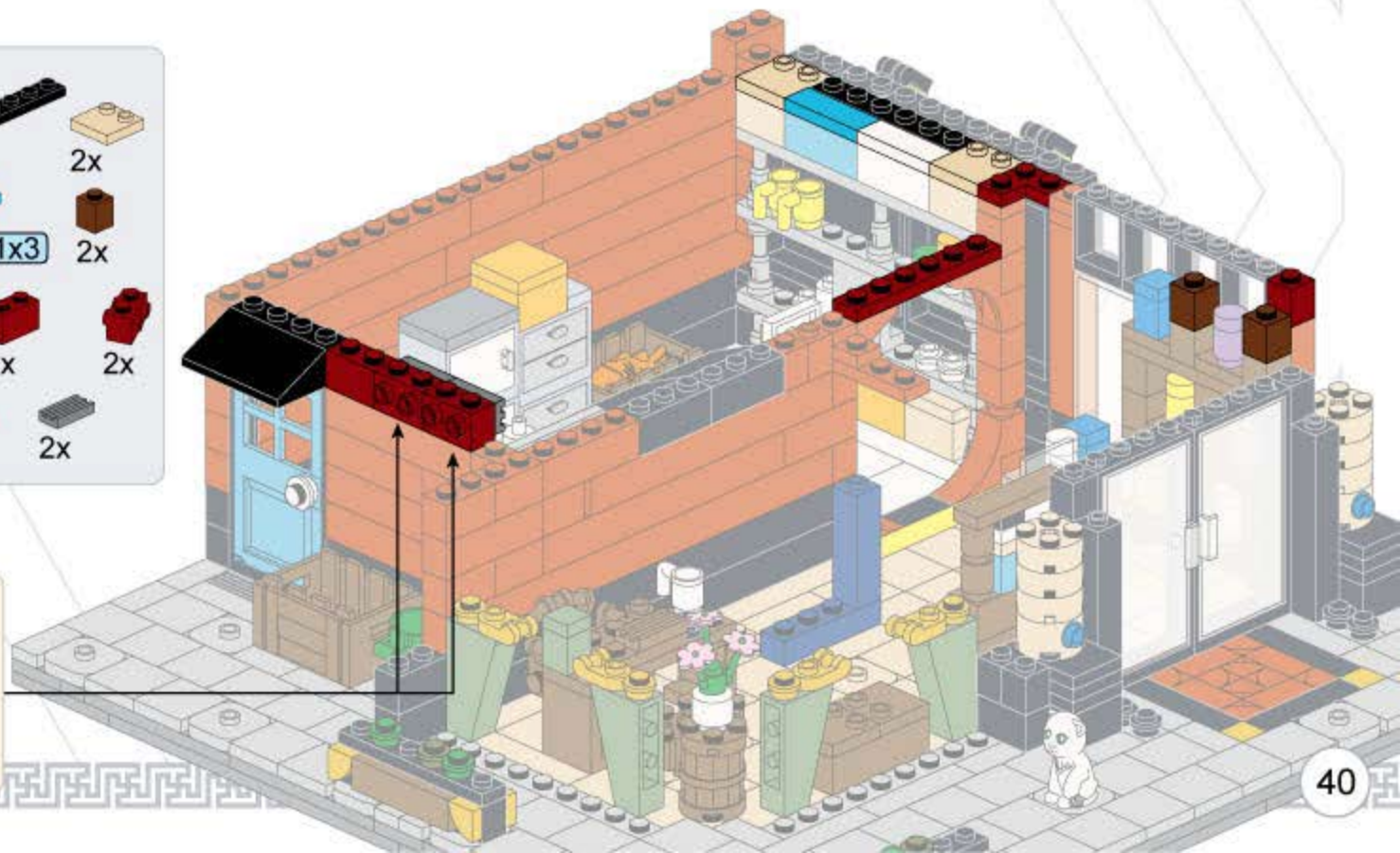
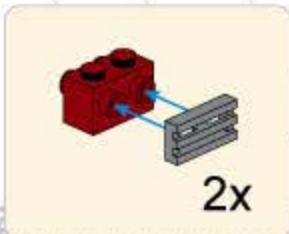

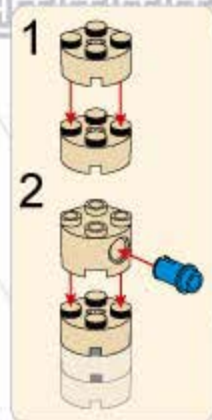
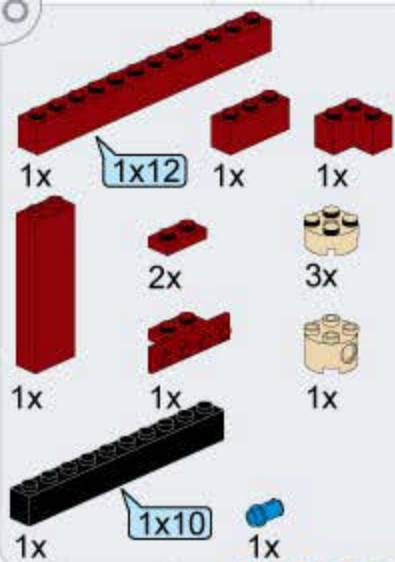

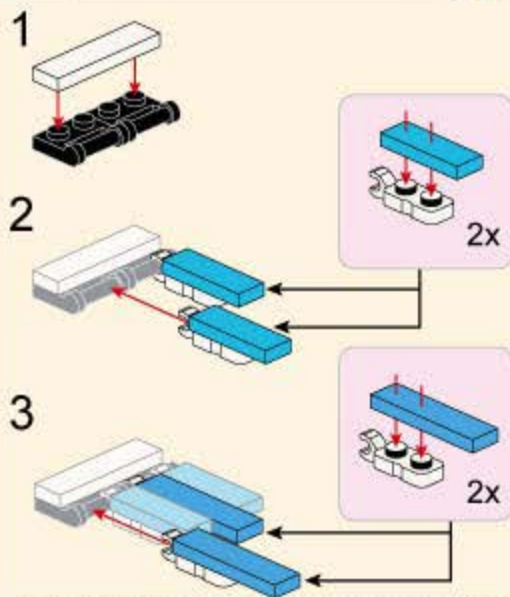
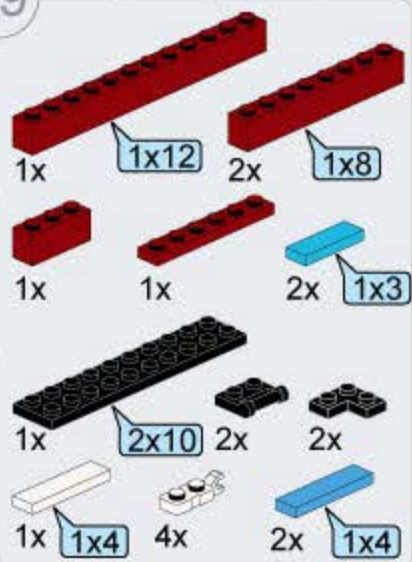

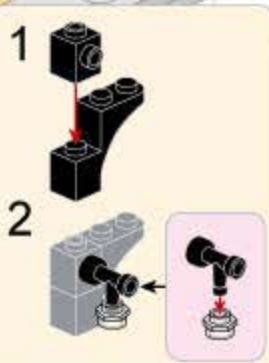
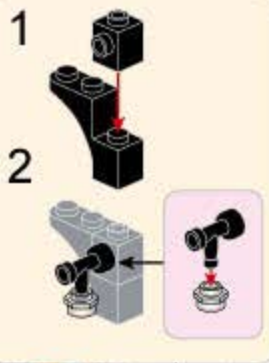
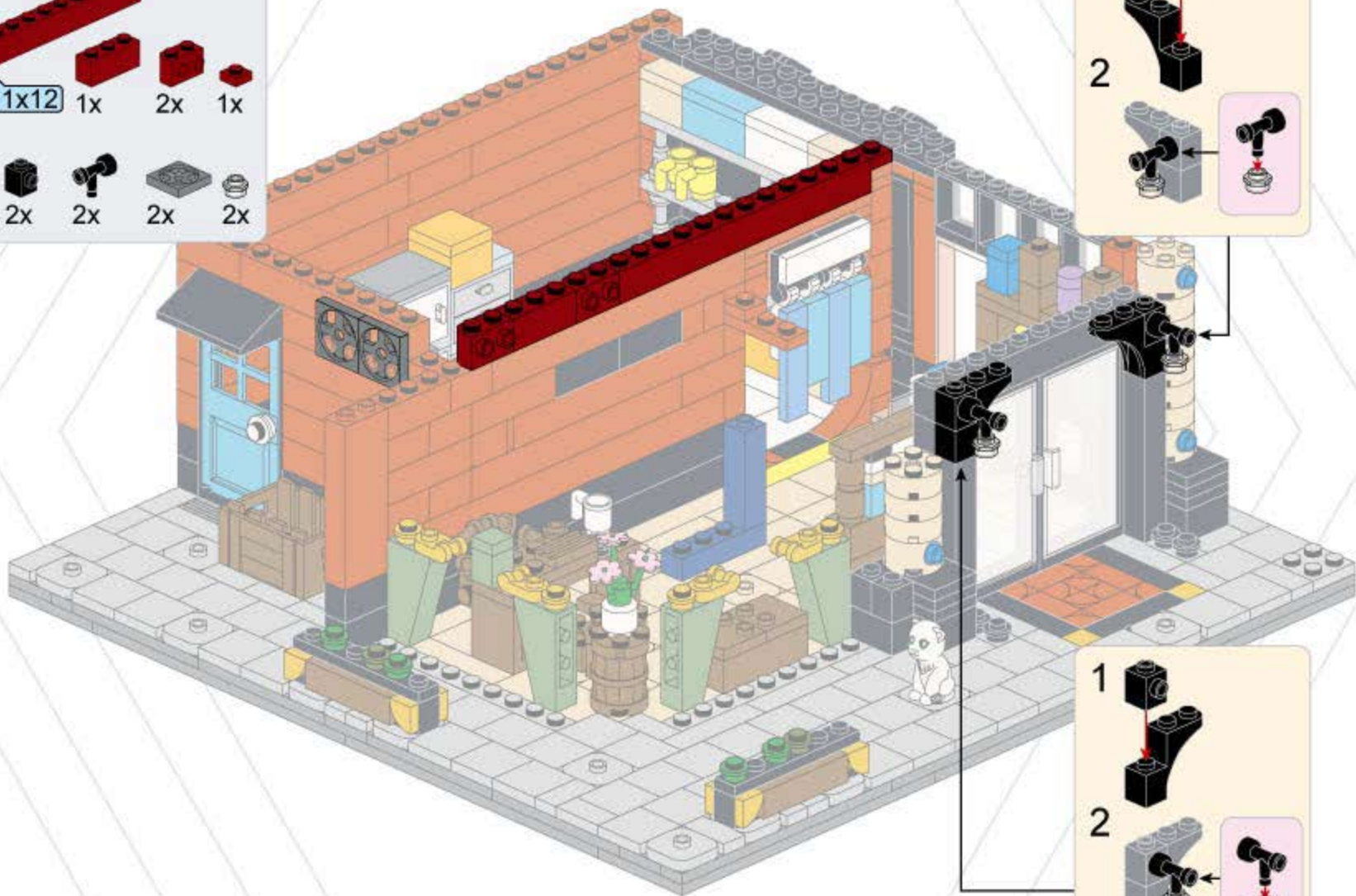
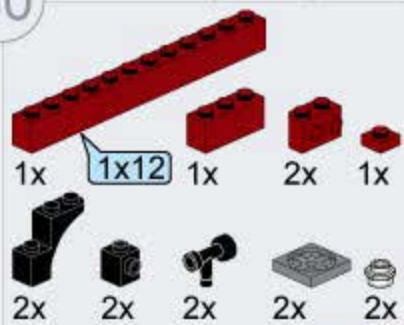

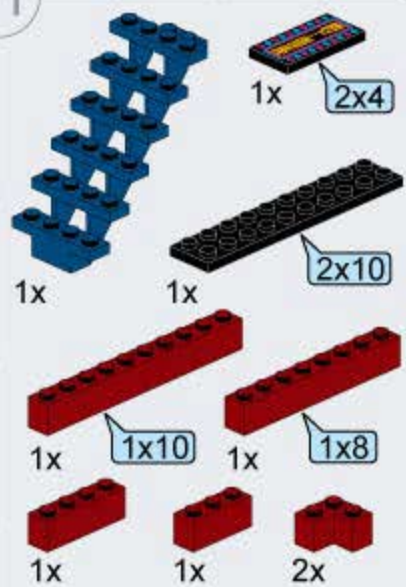

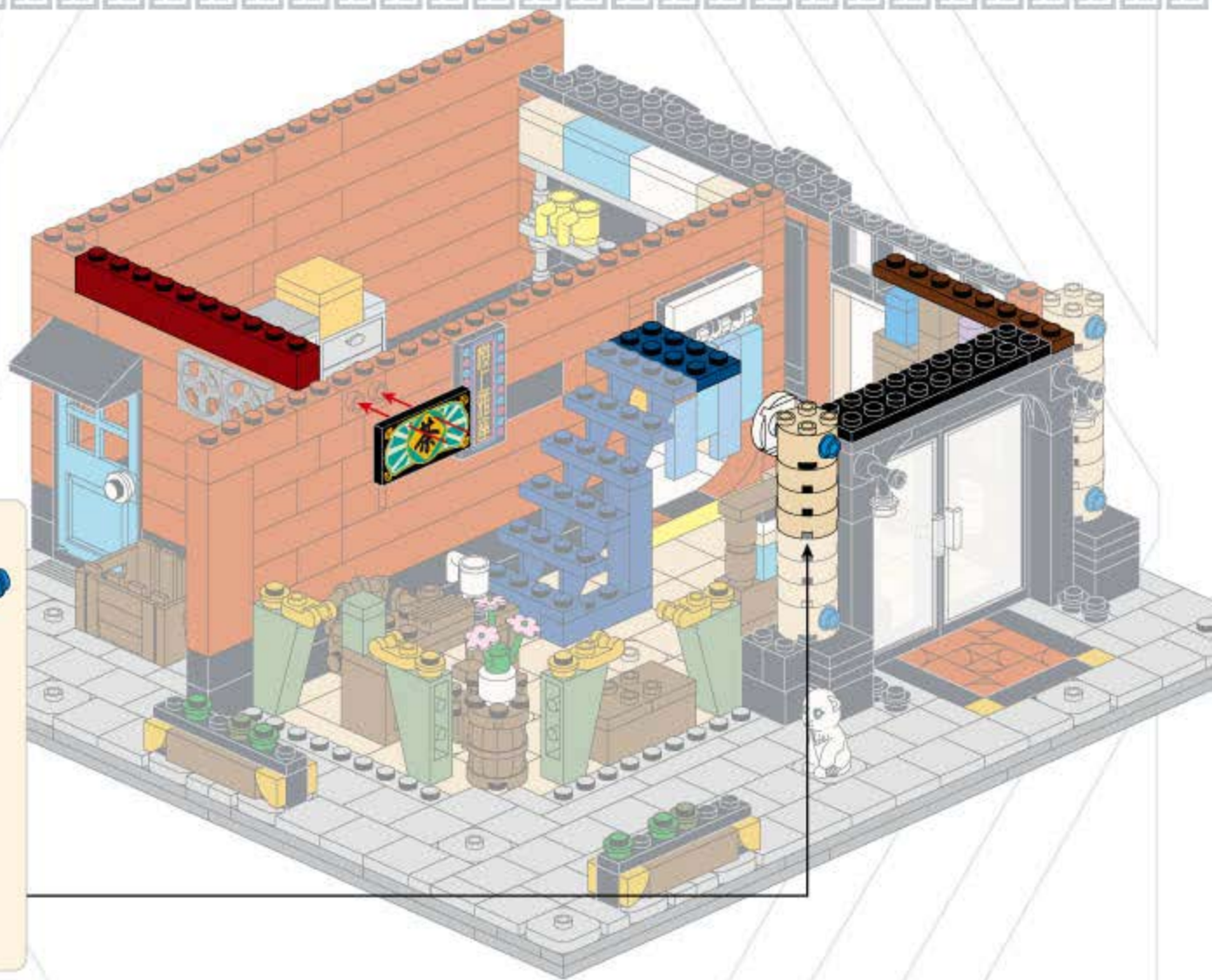
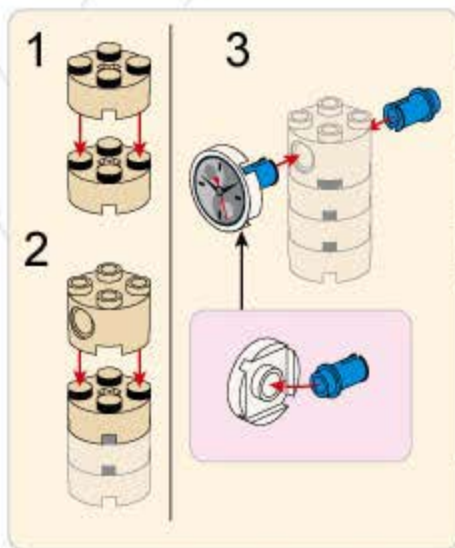

















53

- 1x 
- 1x 
- 1x 
- 1x 
- 1x 
- 1x 
- 1x 
- 1x 
- 1x 
- 1x 
- 2x 
- 2x 
- 2x 
- 4x 
- 6x 

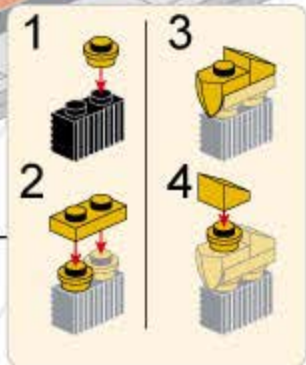
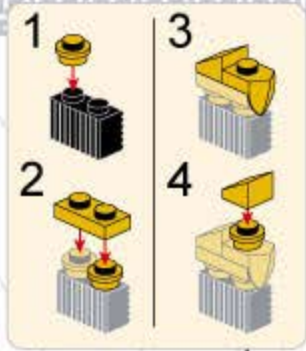
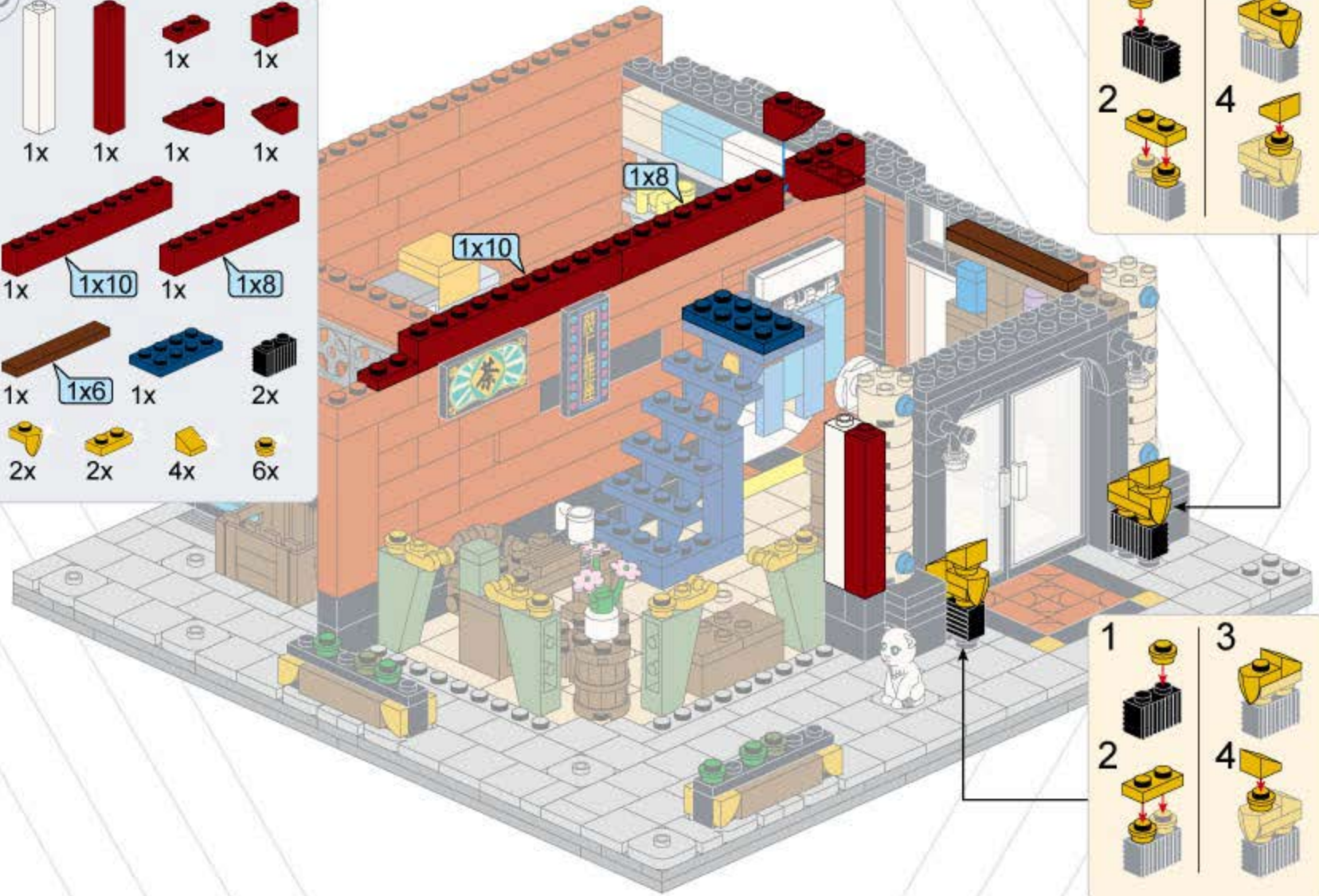

54

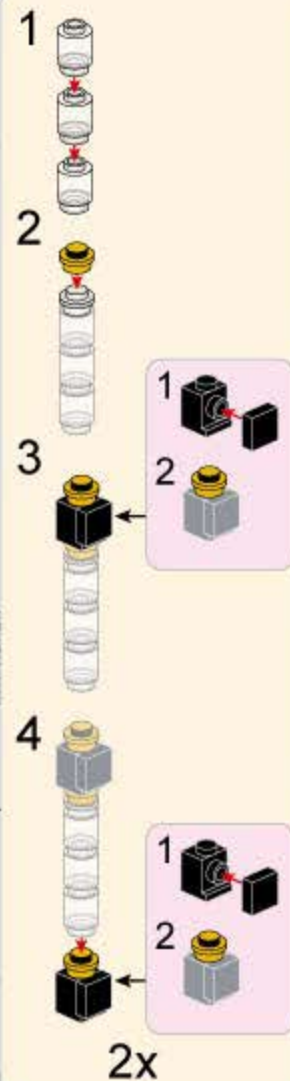
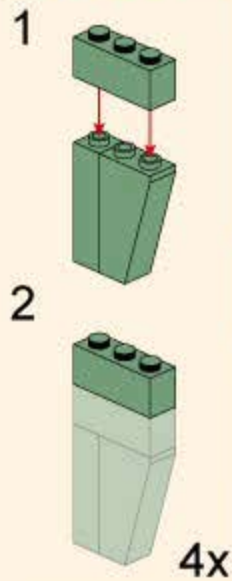
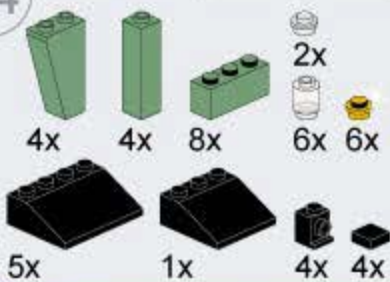

47



7



55

- 2x [Black 1x3 Technic Beam]
- 1x [Red 1x2 Technic Beam]
- 1x [Red 1x2 Technic Beam]
- 3x [Blue 1x2 Technic Beam]
- 2x [Blue 1x3 Technic Beam]

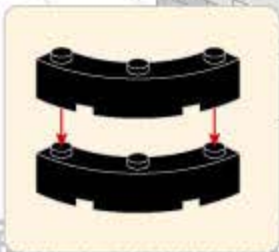
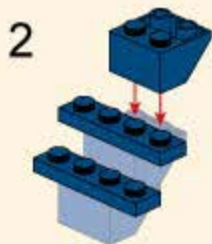
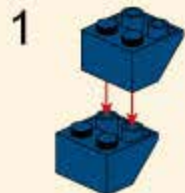

56

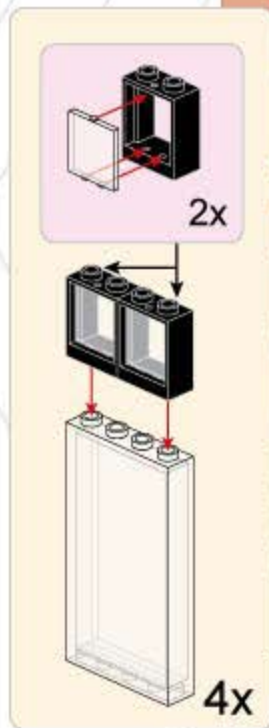
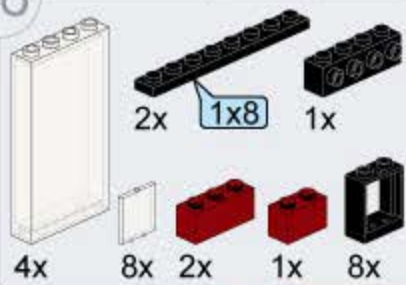

49

57



1x



1x

1x8



1x

1x12



1x

1x10



1x



1x



1x



1x12

1x10

1x8

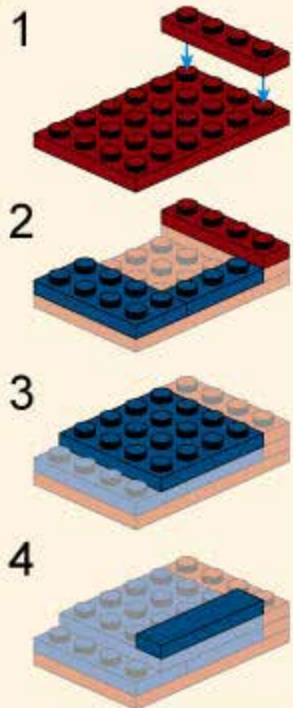
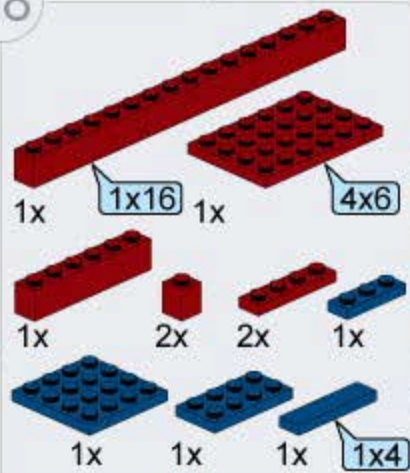

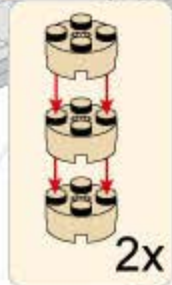
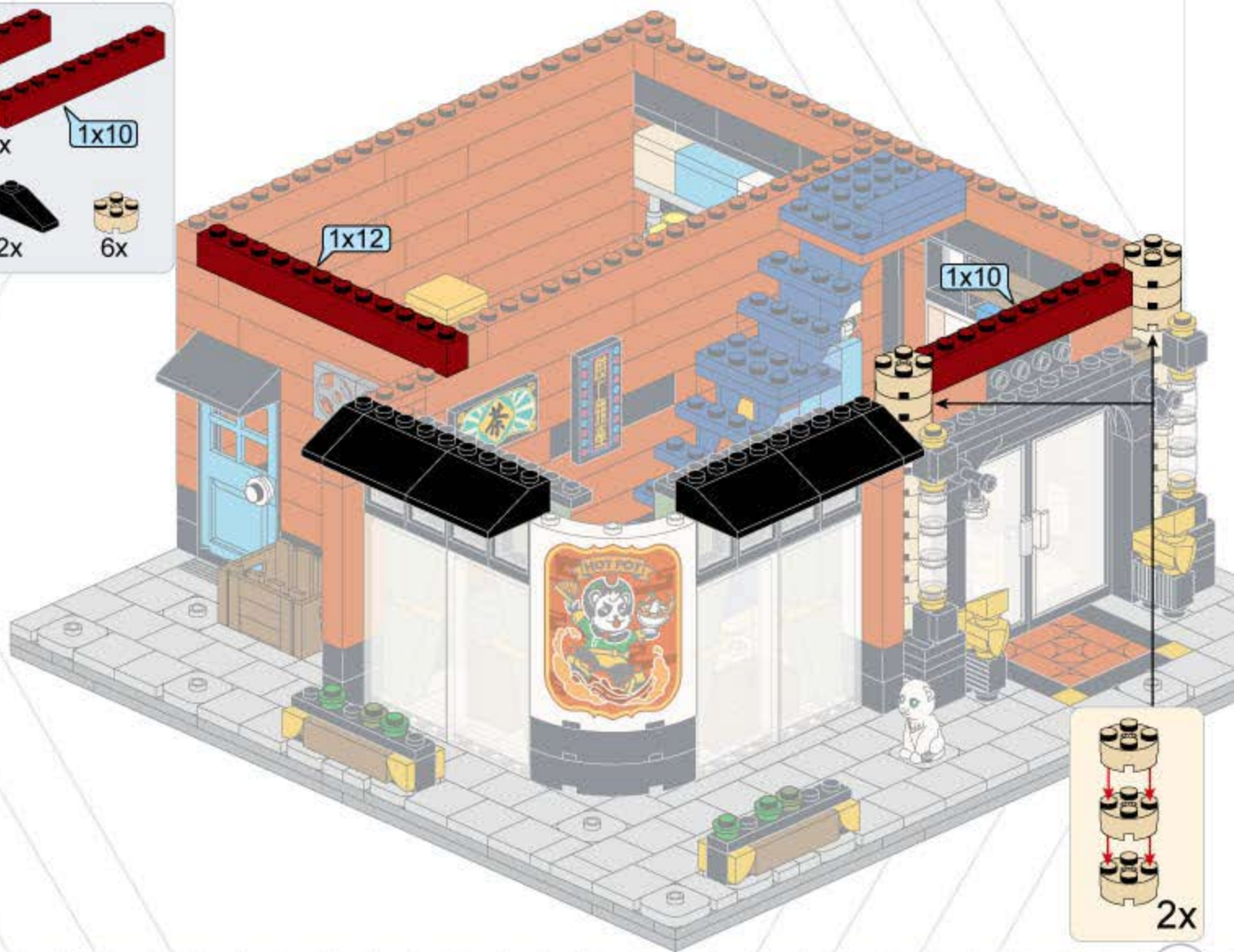
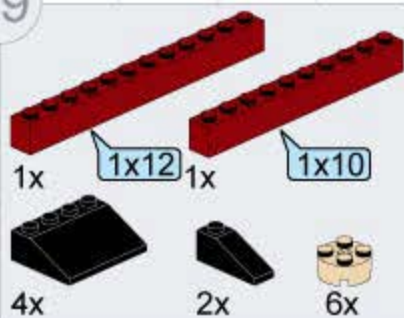

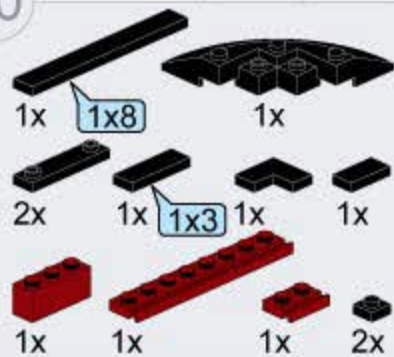

61

- 2x [Black Technic Beam 1x6]
- 2x [Black Technic Beam 1x4]
- 1x [Black Technic Pin Long]
- 1x [Black Technic Pin Short]
- 1x [Black Technic Pin Round]
- 2x [Black Technic Beam 1x10]
- 3x [Black Technic Beam 1x3]
- 1x [Black Technic Pin Round]
- 1x [Black Technic Pin Round]
- 1x [Black Technic Pin L-shaped]
- 1x [Yellow Technic Pin Round]





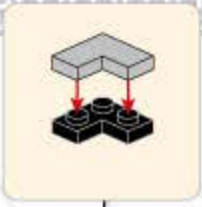









- 1x
- 1x8
- 1x
- 2x
- 1x
- 1x
- 1x
- 2x
- 1x8
- 1x
- 1x
- 1x
- 4x
- 2x
- 1x
- 1x









63

- 2x  1x  2x 
- 1x  2x  1x  3x 
- 1x  1x  1x  4x  1x 

-  2x

- 1 
- 2  
- 3 

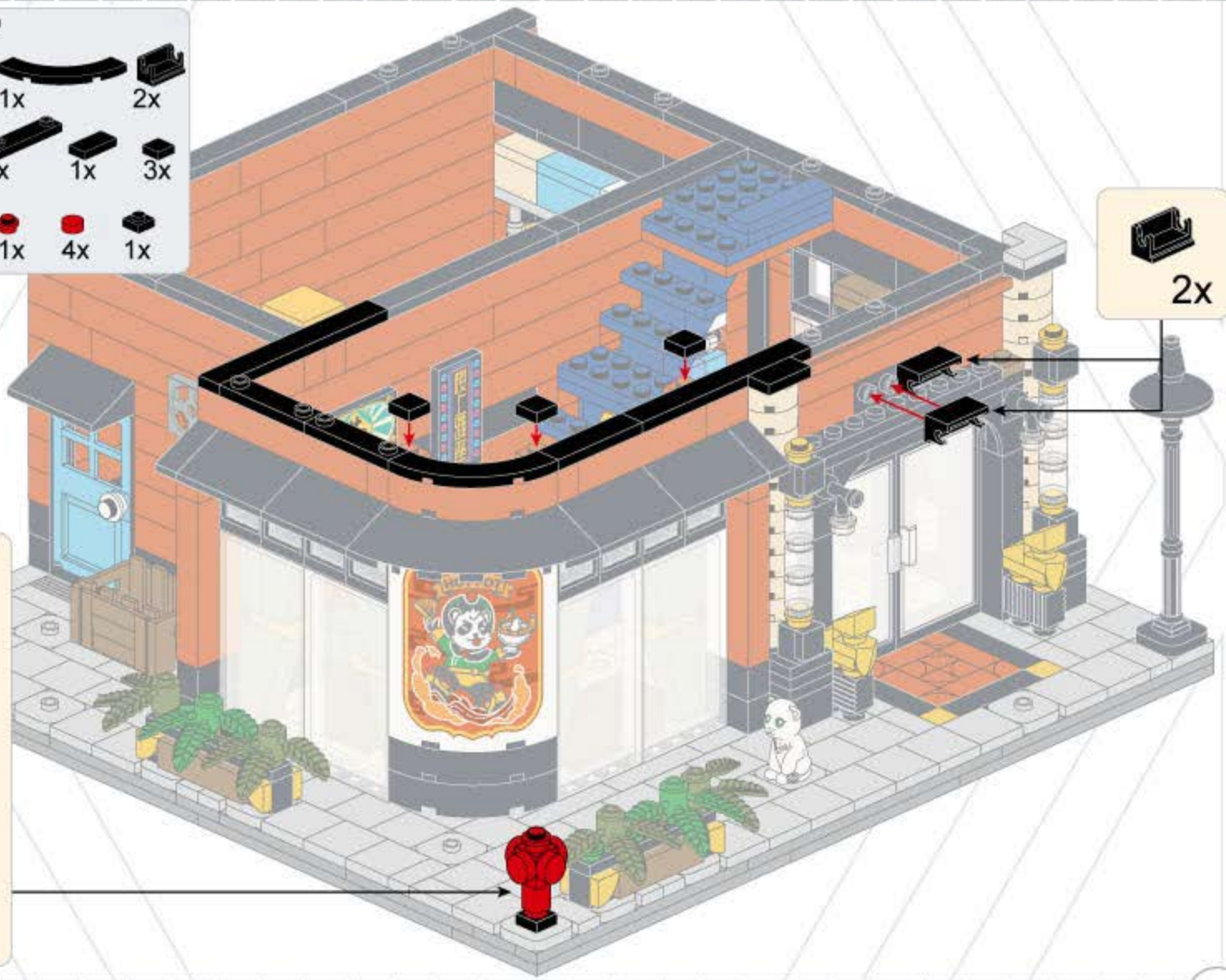

- 1x 2x10 1x 1x10 2x
- 1x 1x6 1x 2x4 2x
- 2x 4x 2x 6x 4x
- 1x 2x6 1x 2x
- 2x 2x 2x 2x

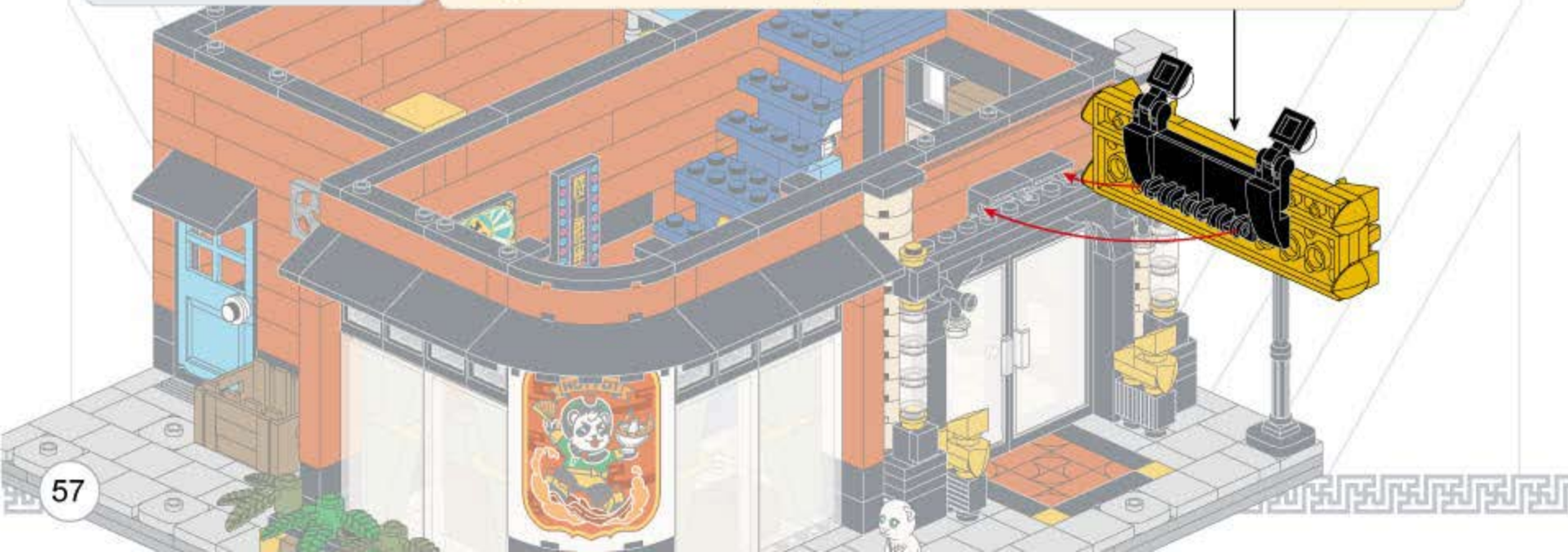
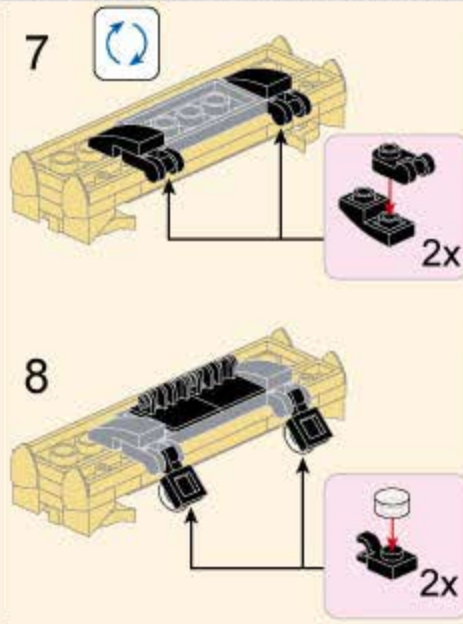
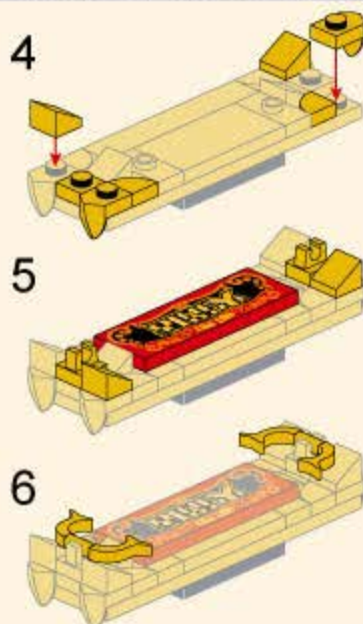
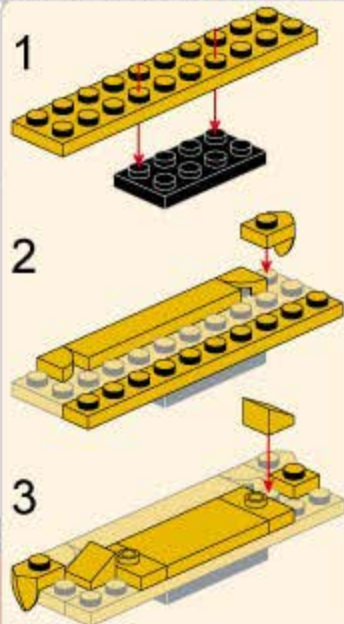

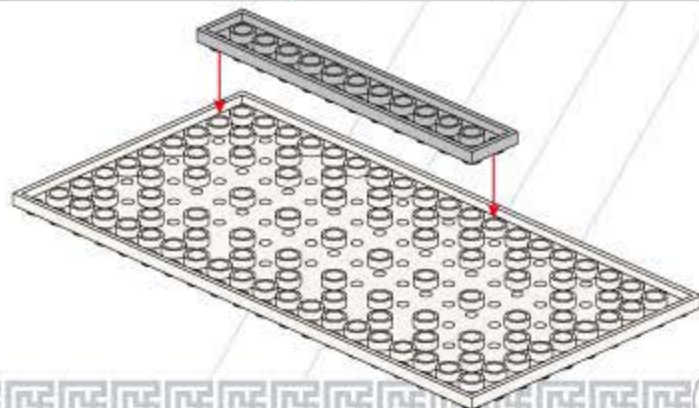
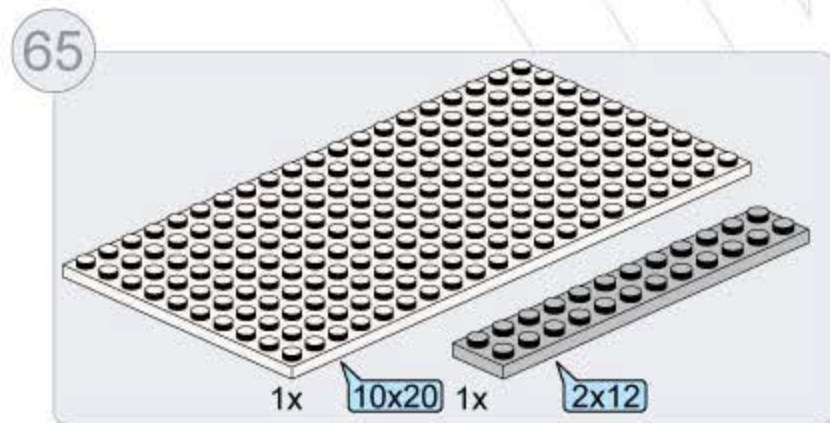
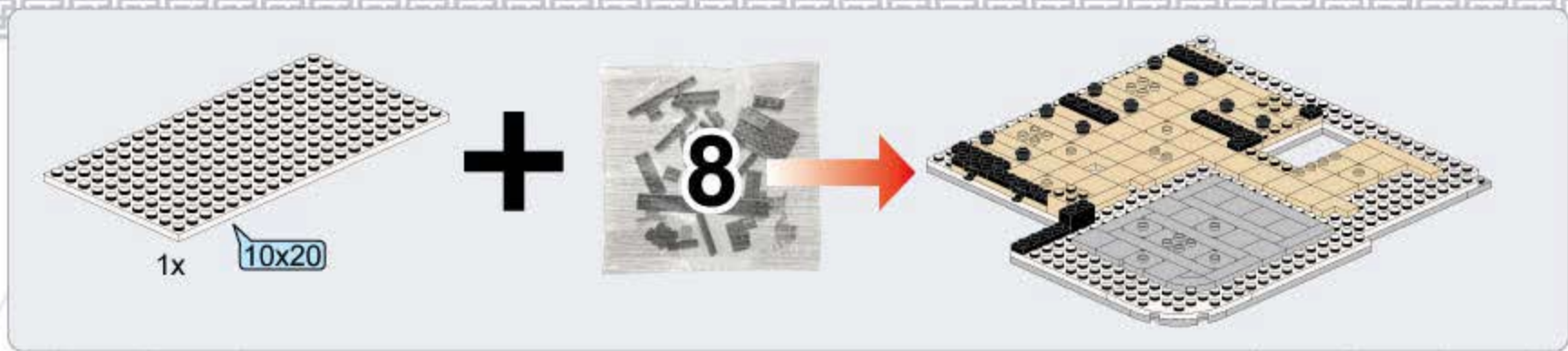

66

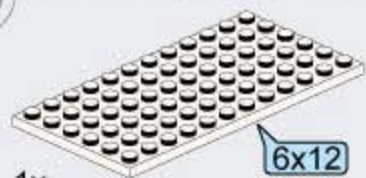

1x

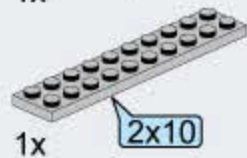

1x

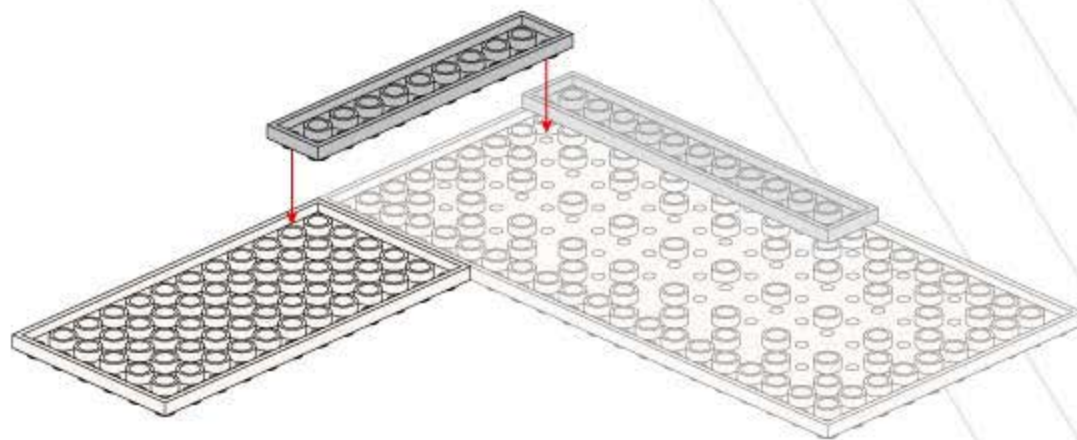

67

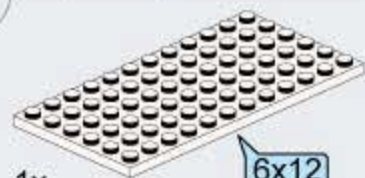

1x

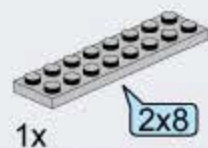

1x

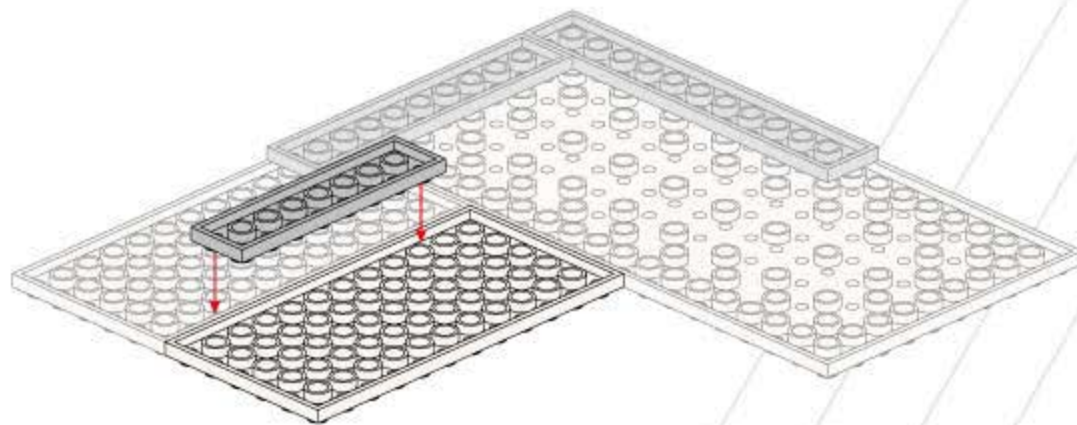

59

68

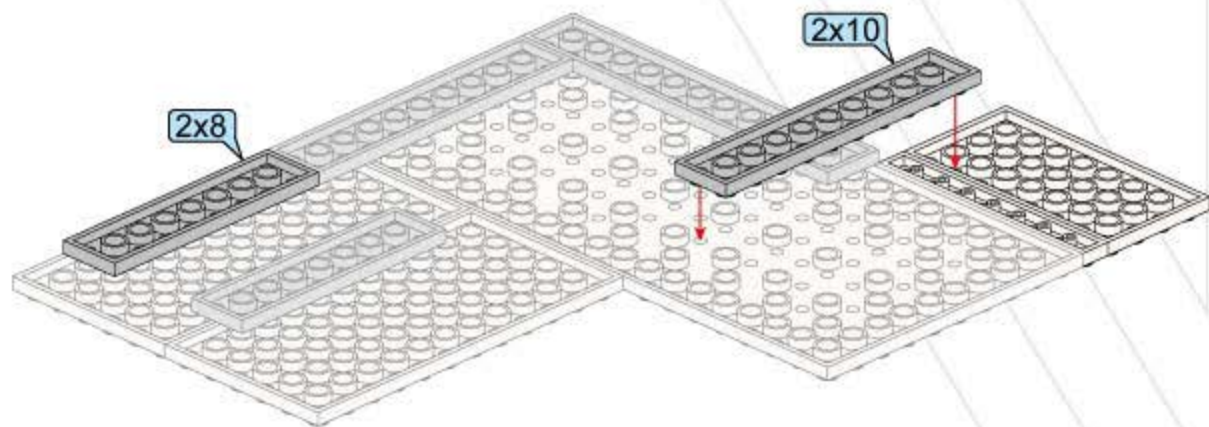
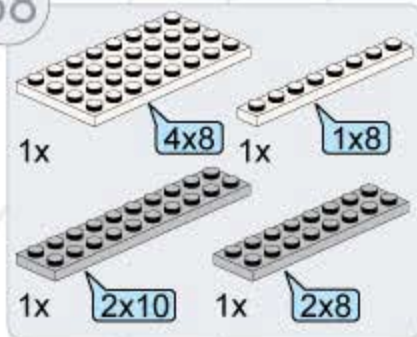

69

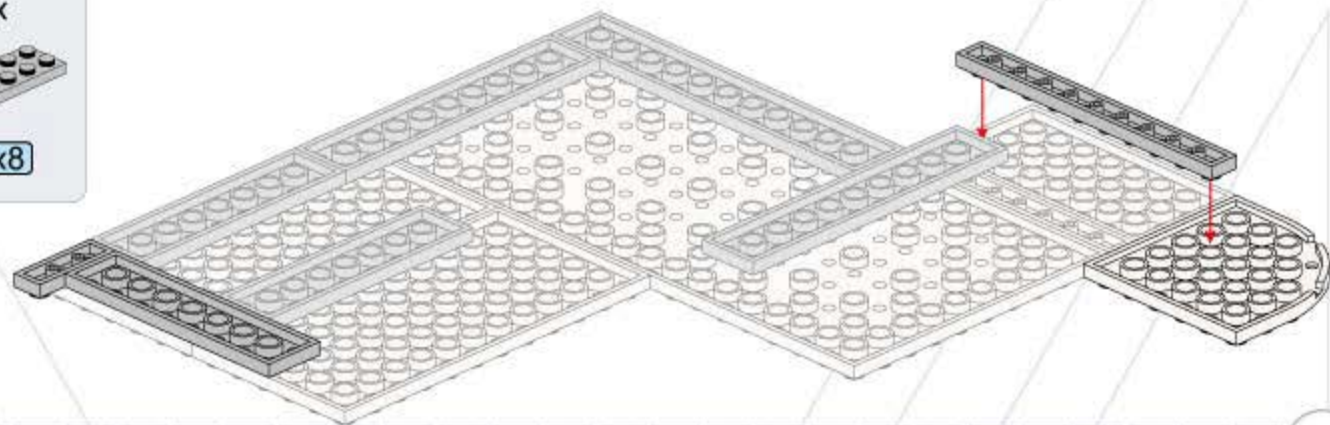
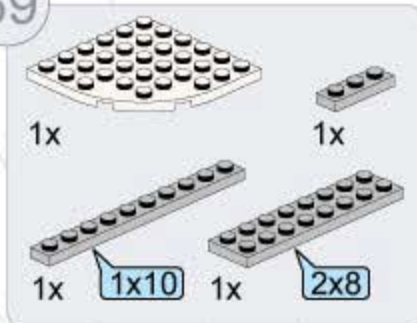

60

70

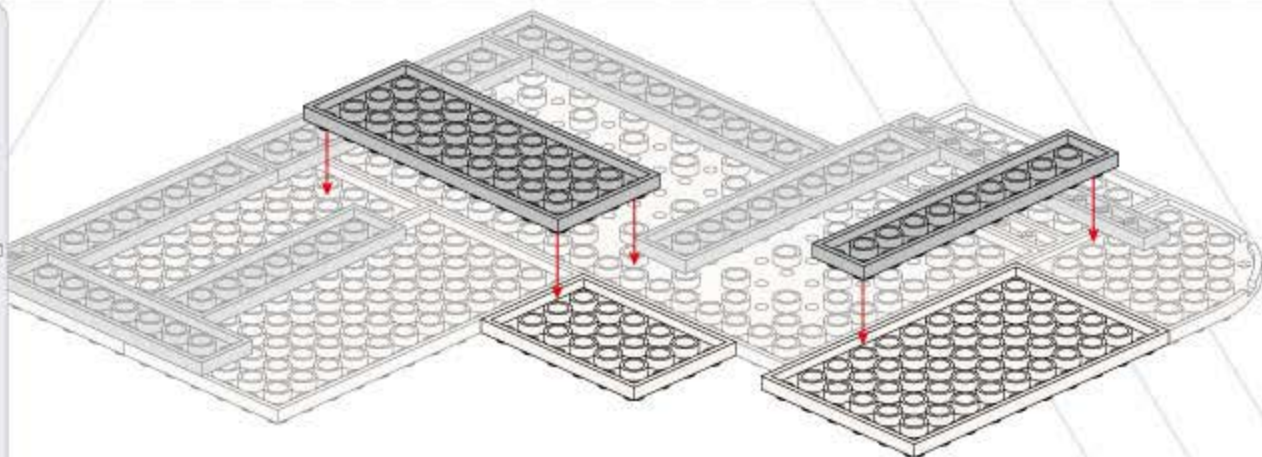
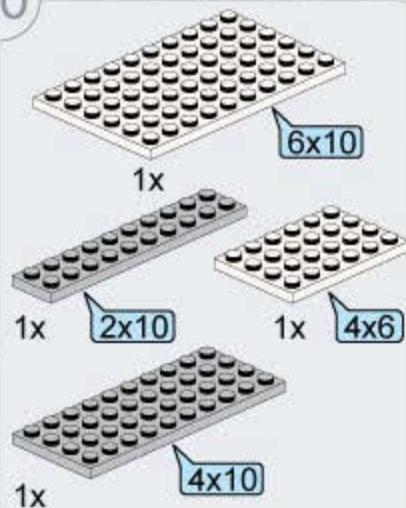

71

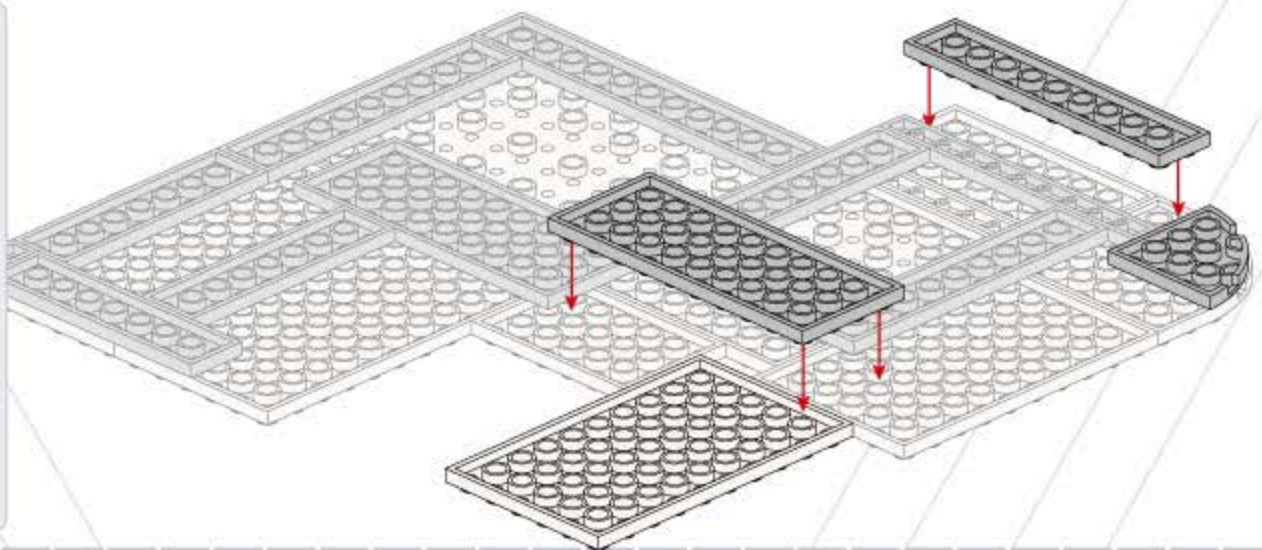
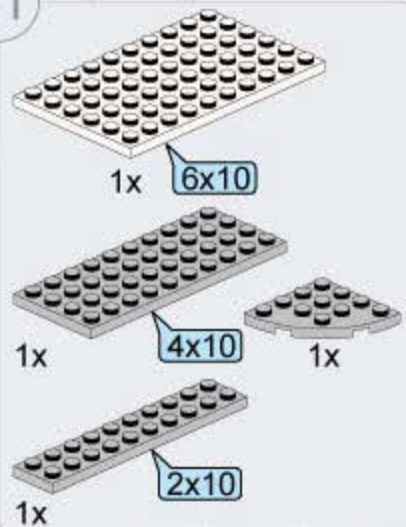

61

72

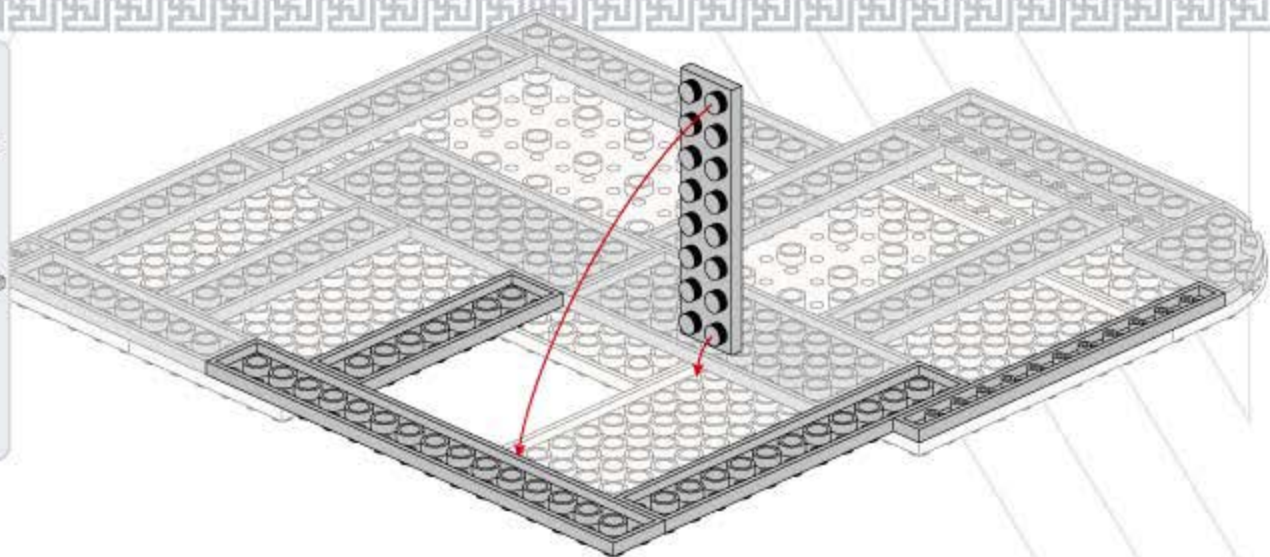
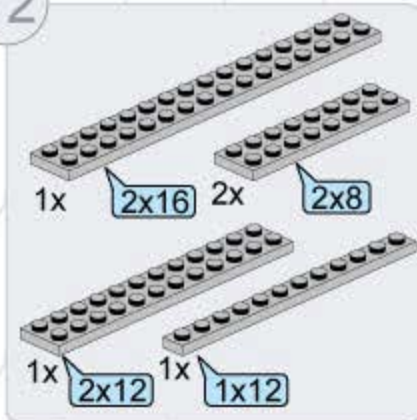

73

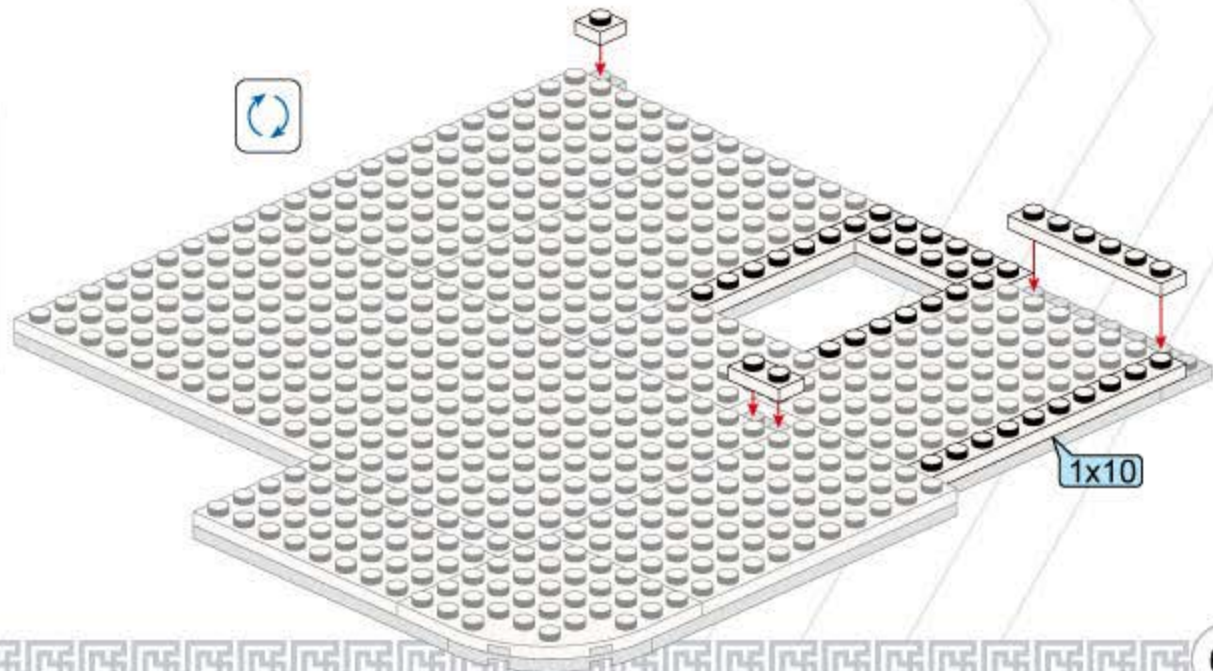
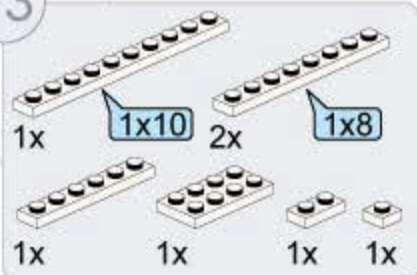

74

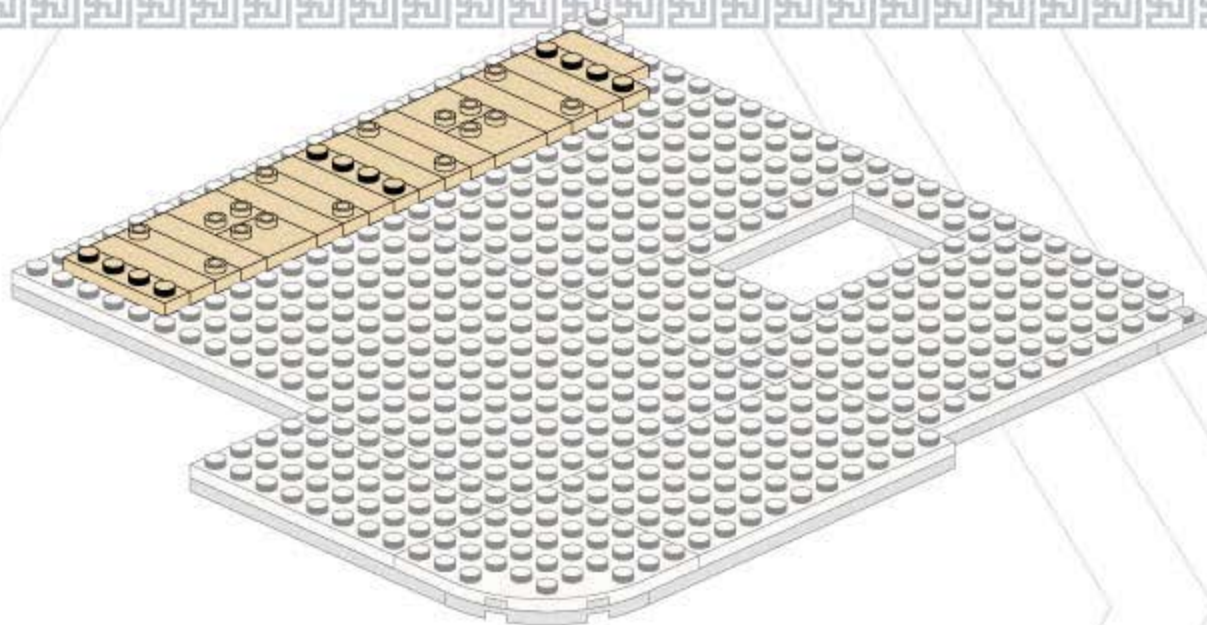
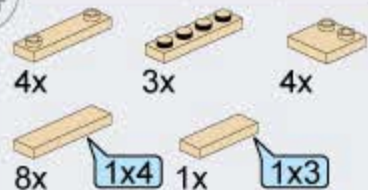

75

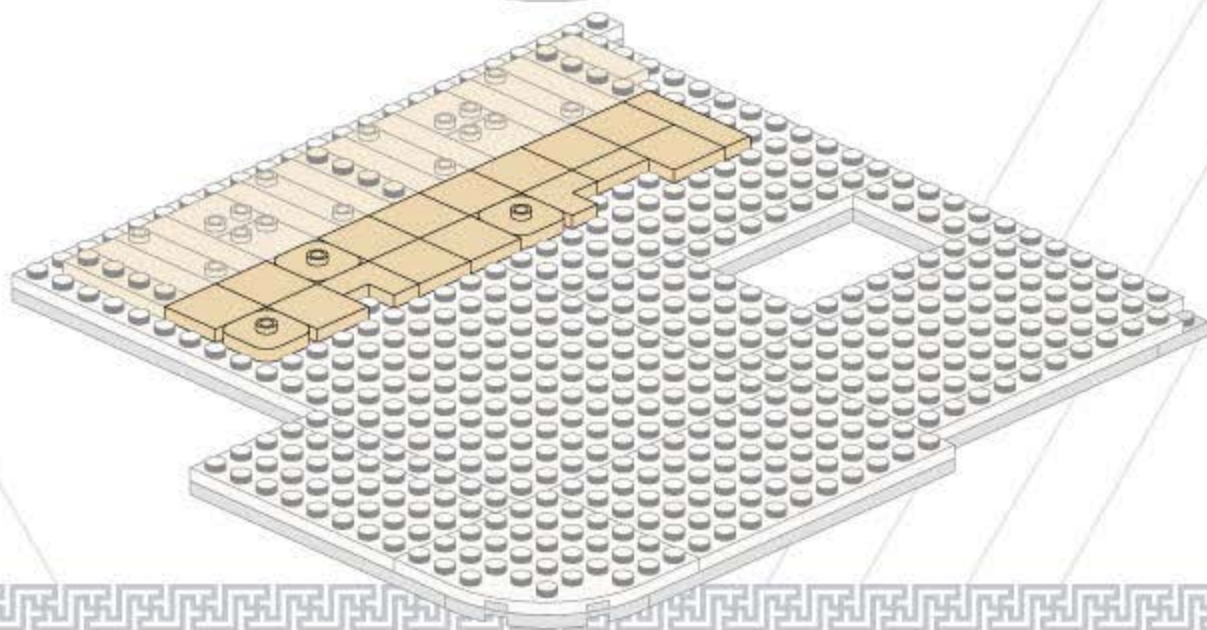
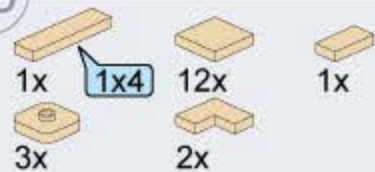



76

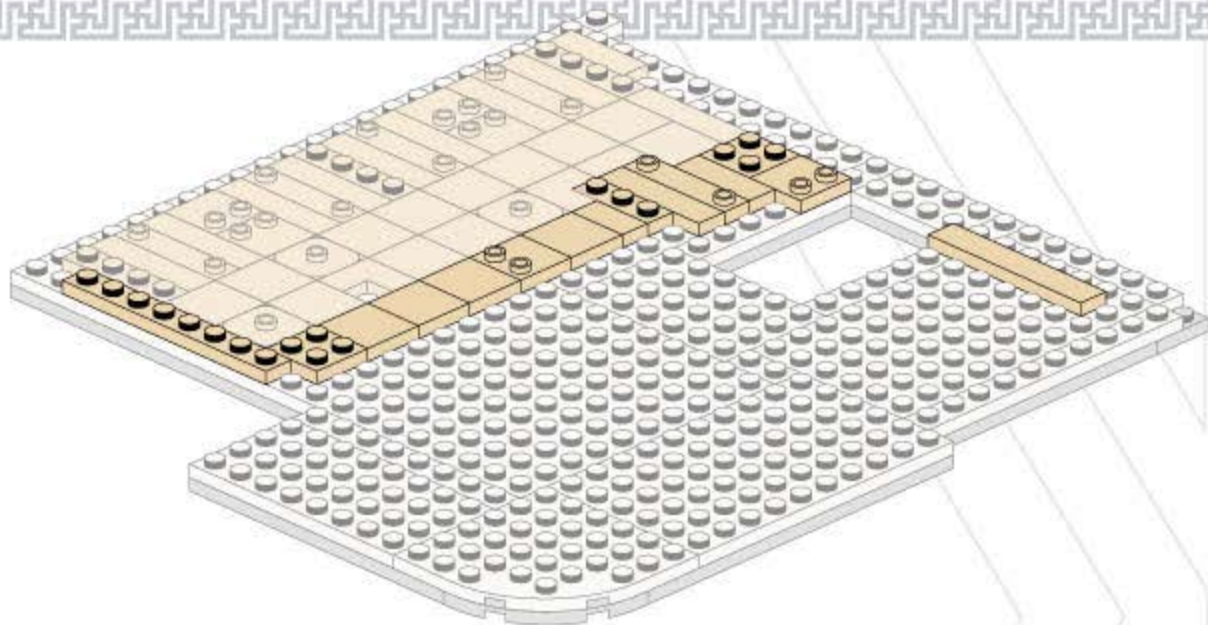
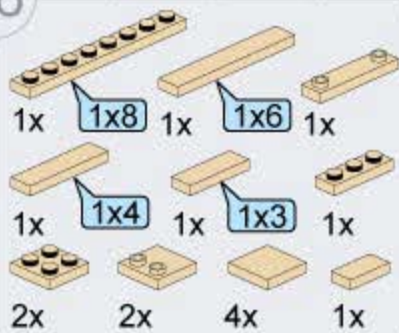

77

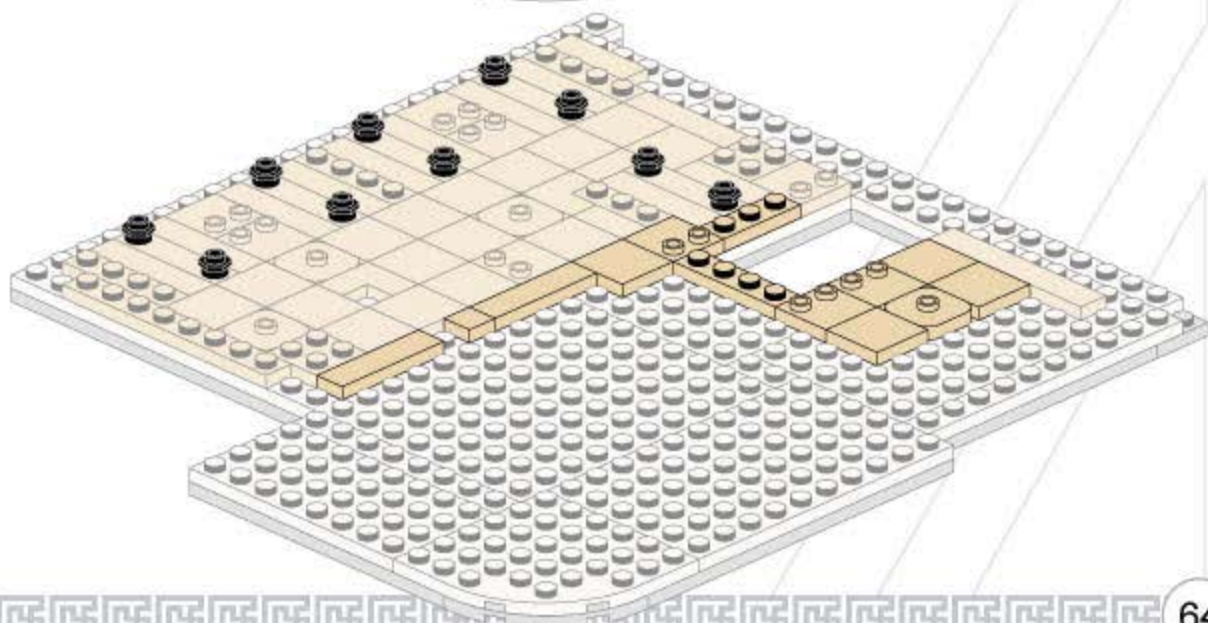
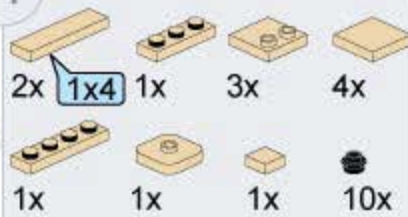

78

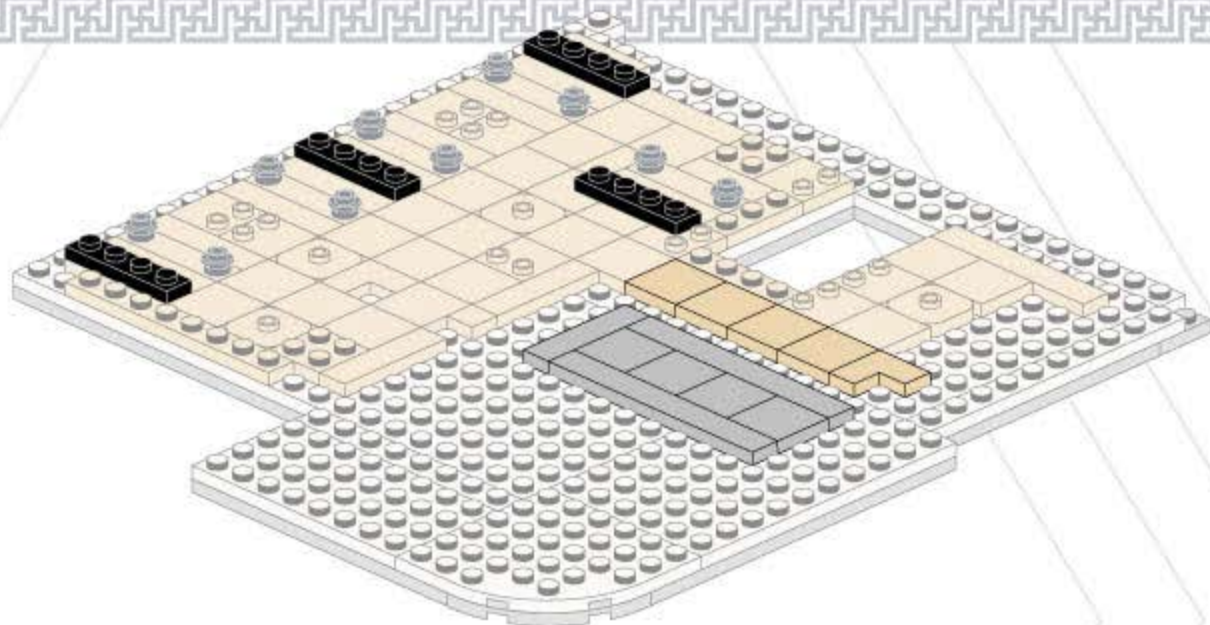
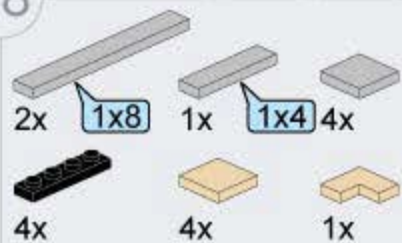

79

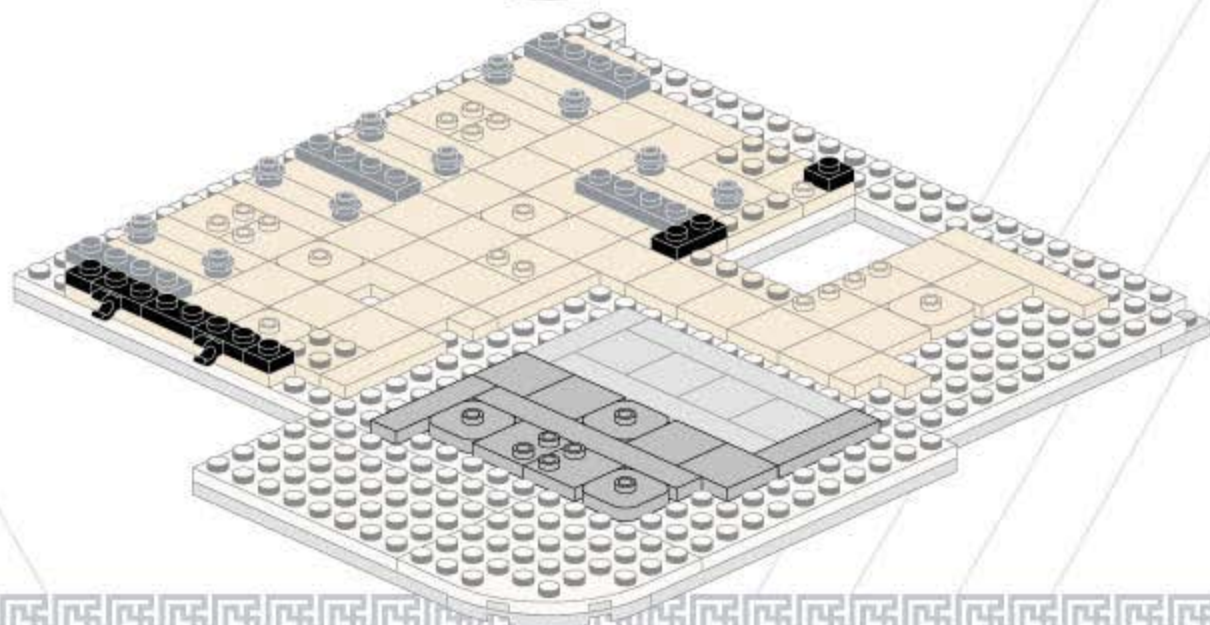
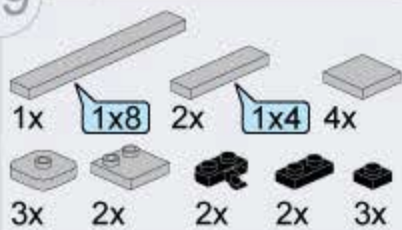

80

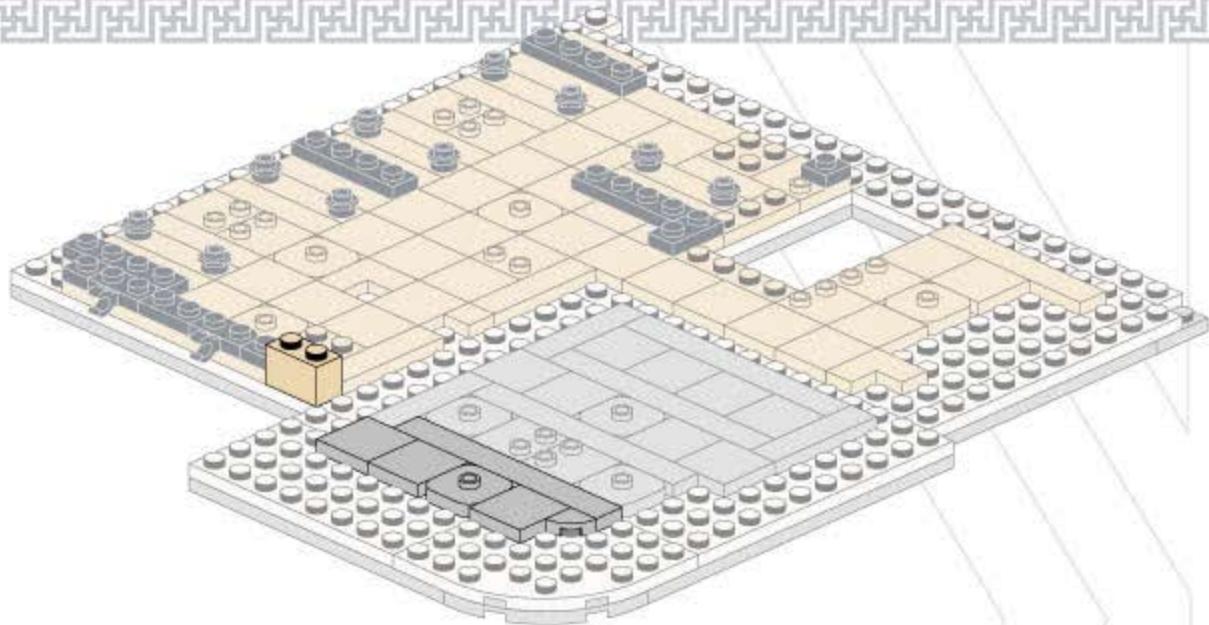
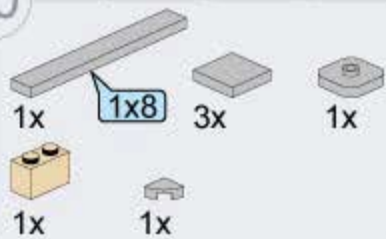

81

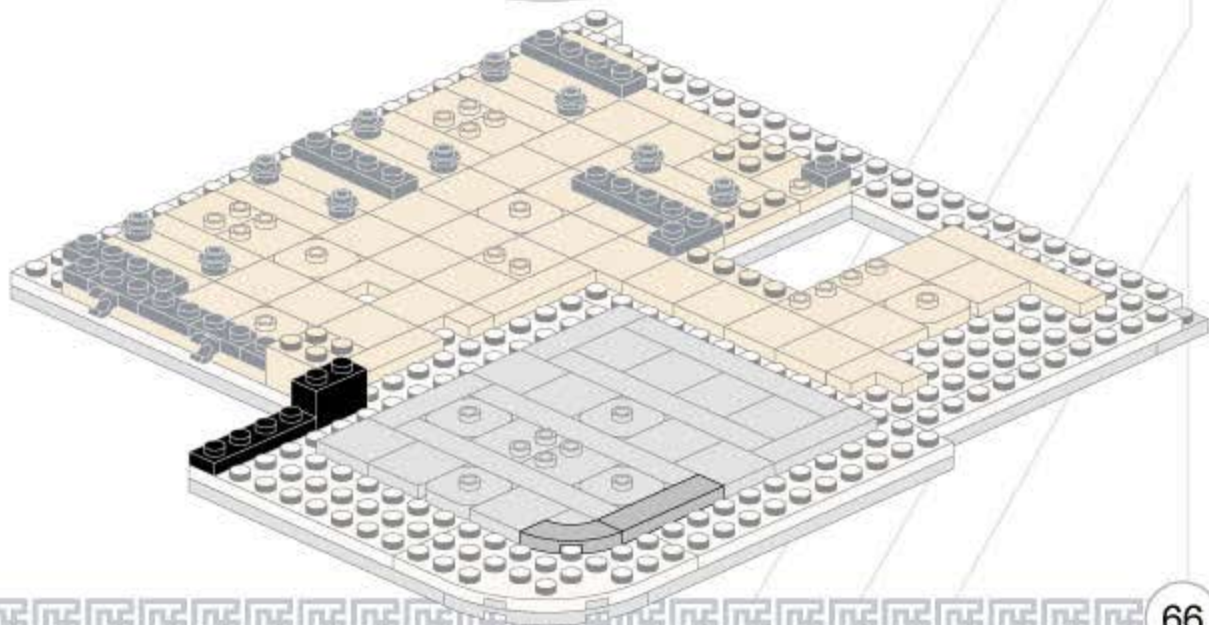
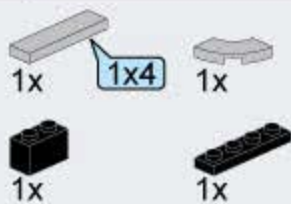

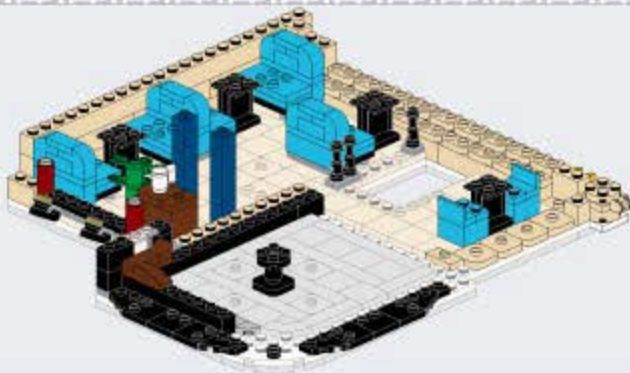

82

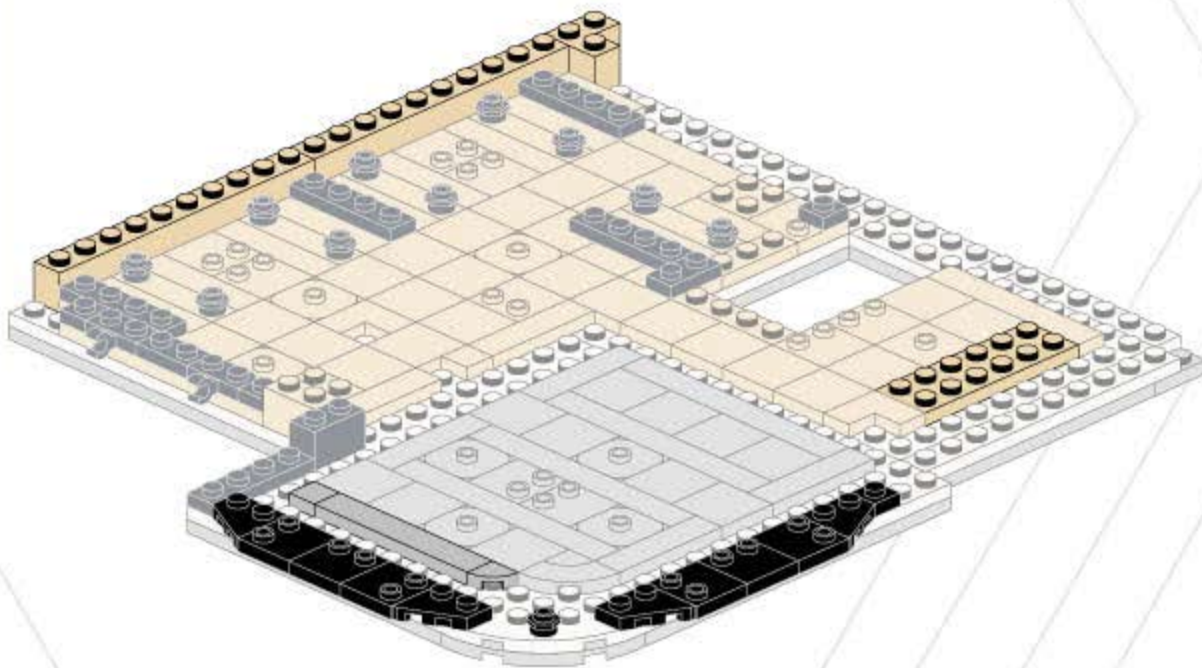
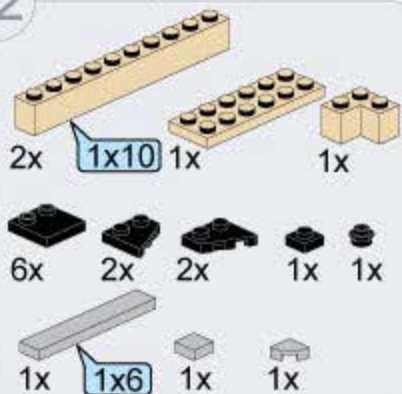

83

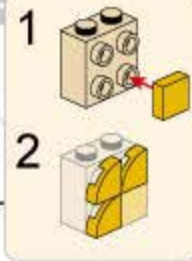
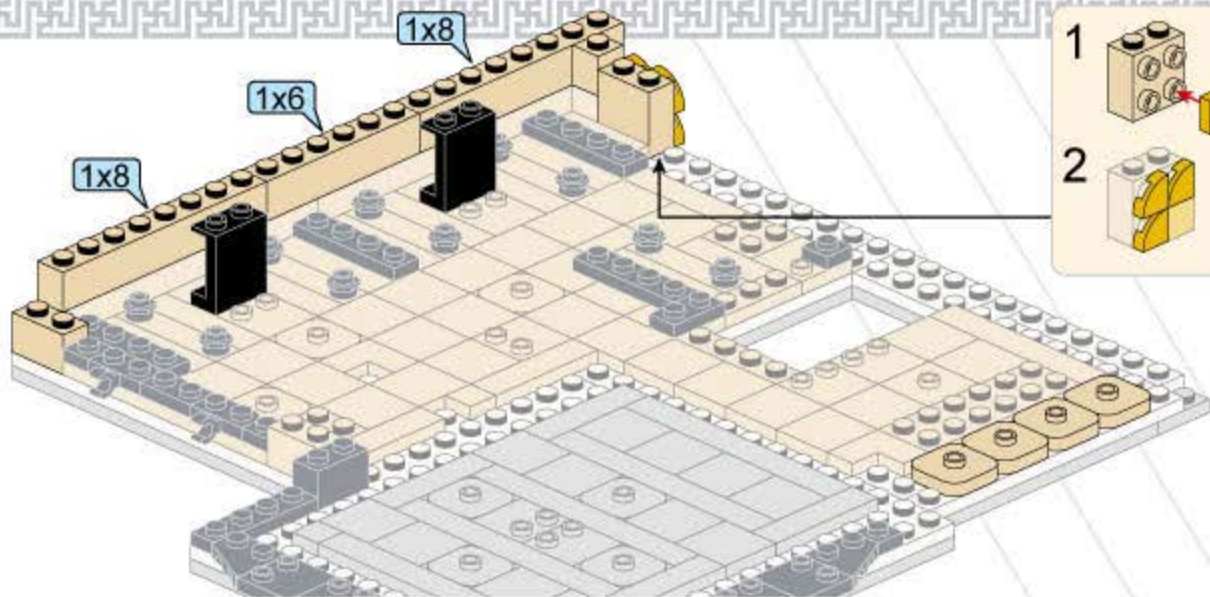
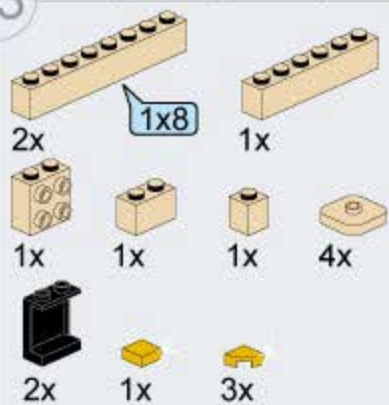

84

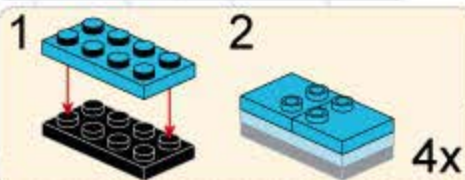
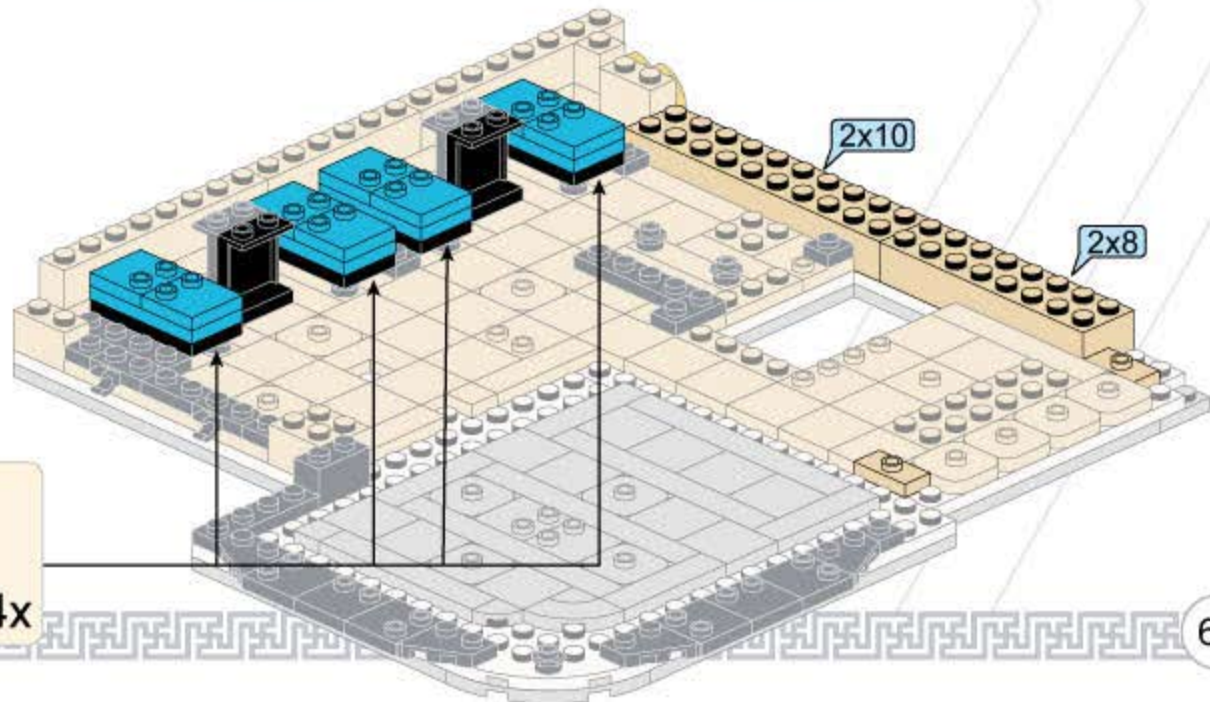
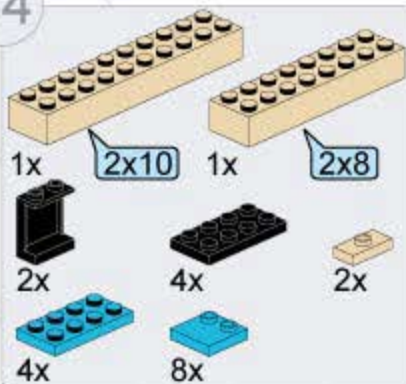

85

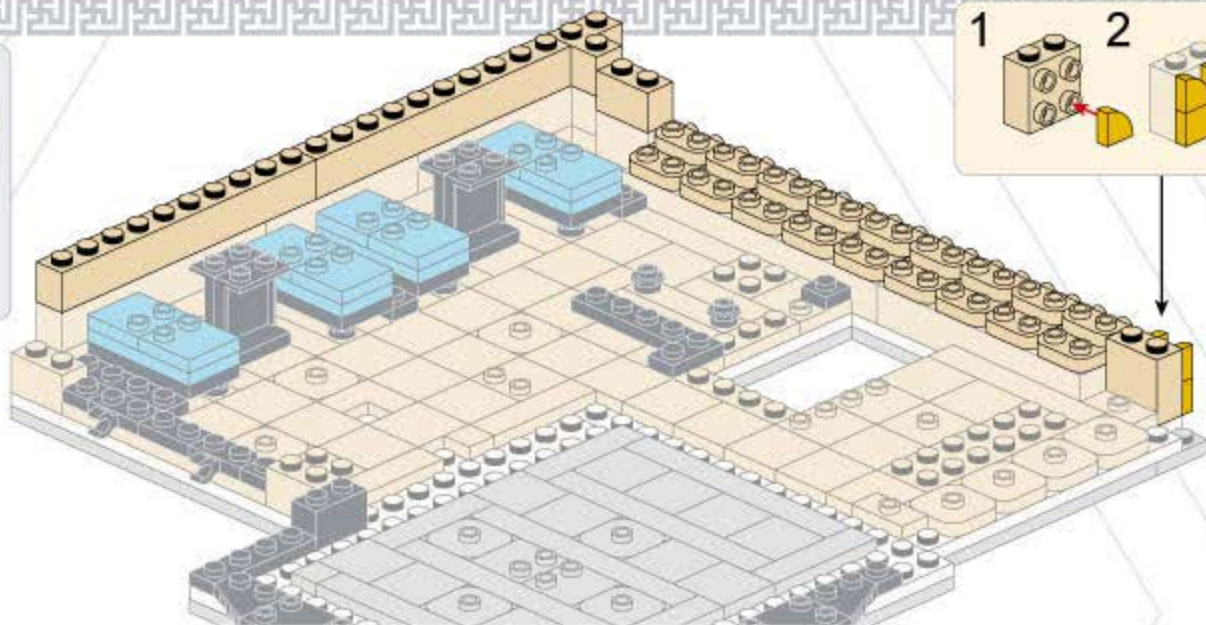
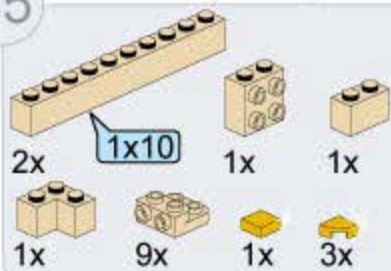

86

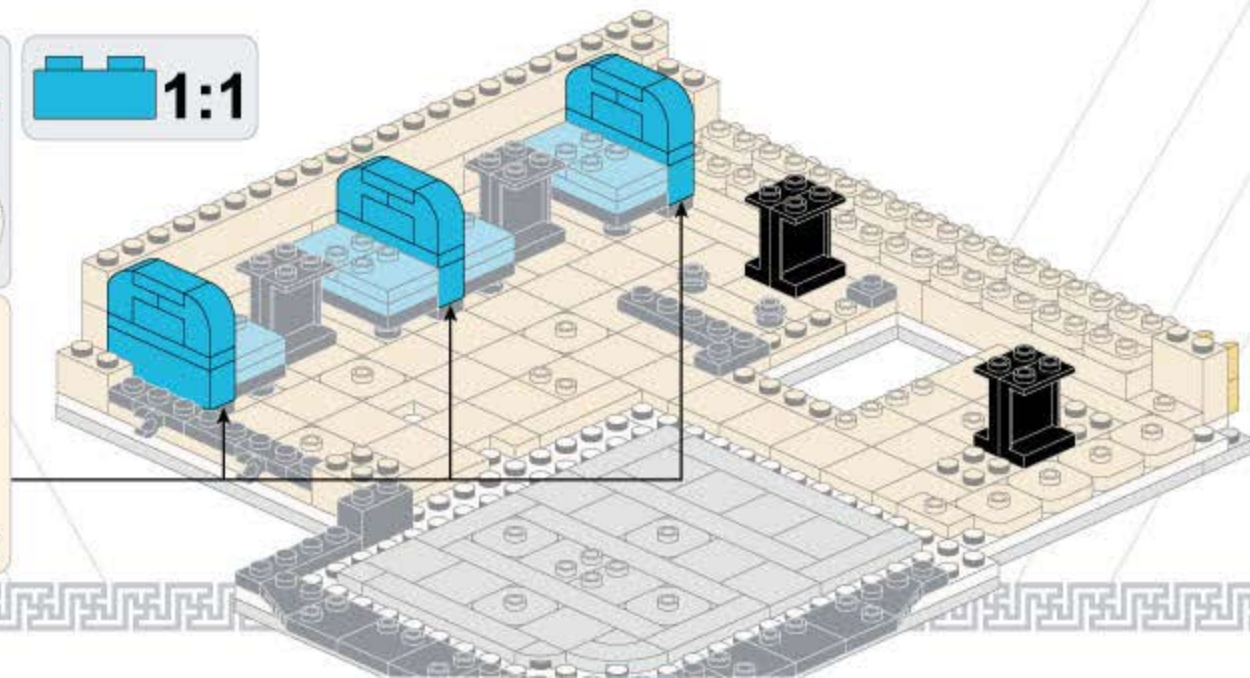
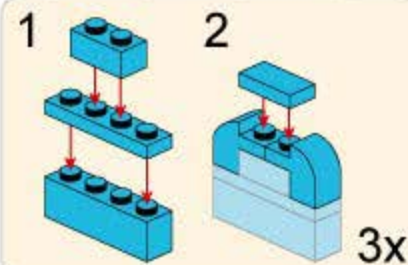
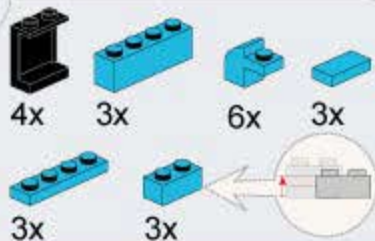

69

87

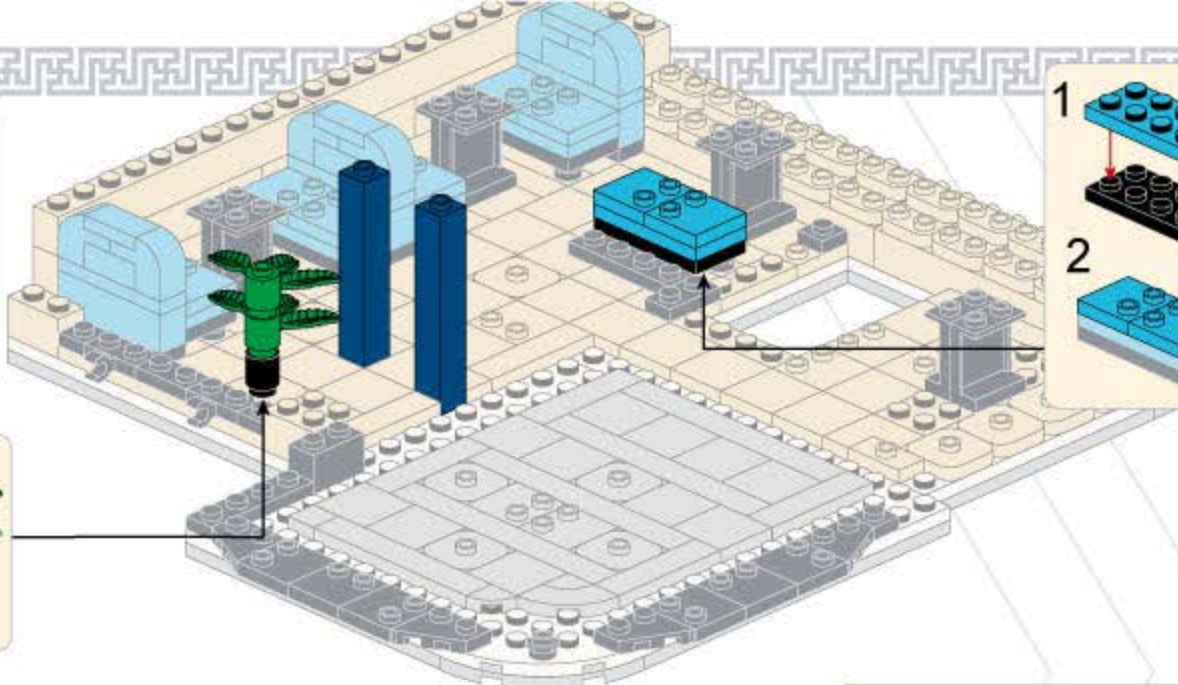
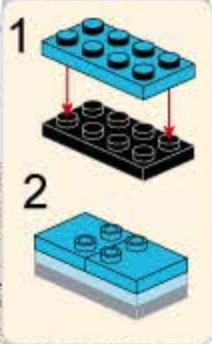
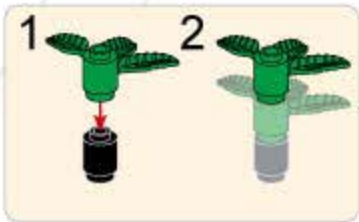
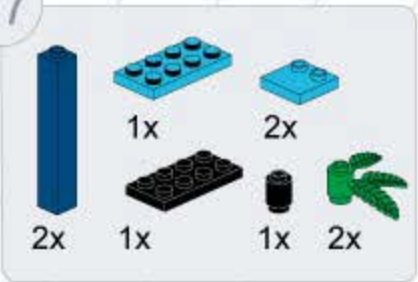

88

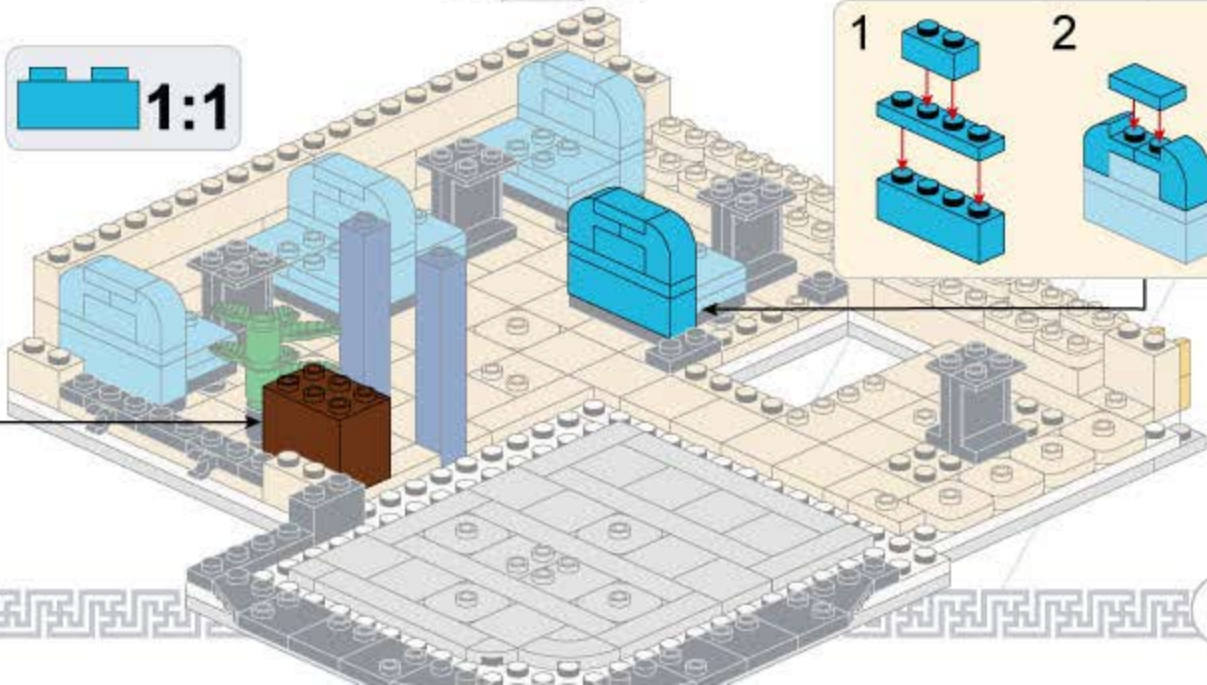
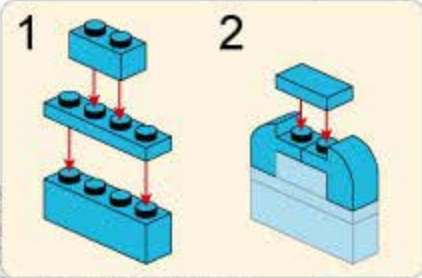
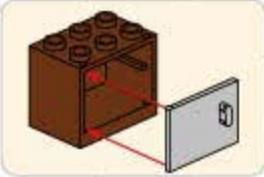
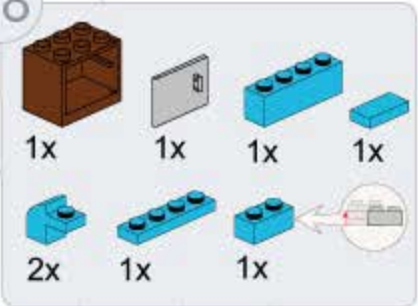

89

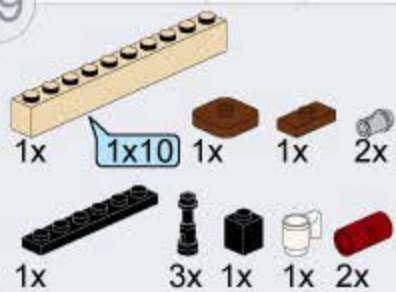

2x



90

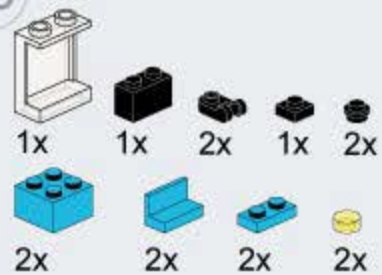

2x

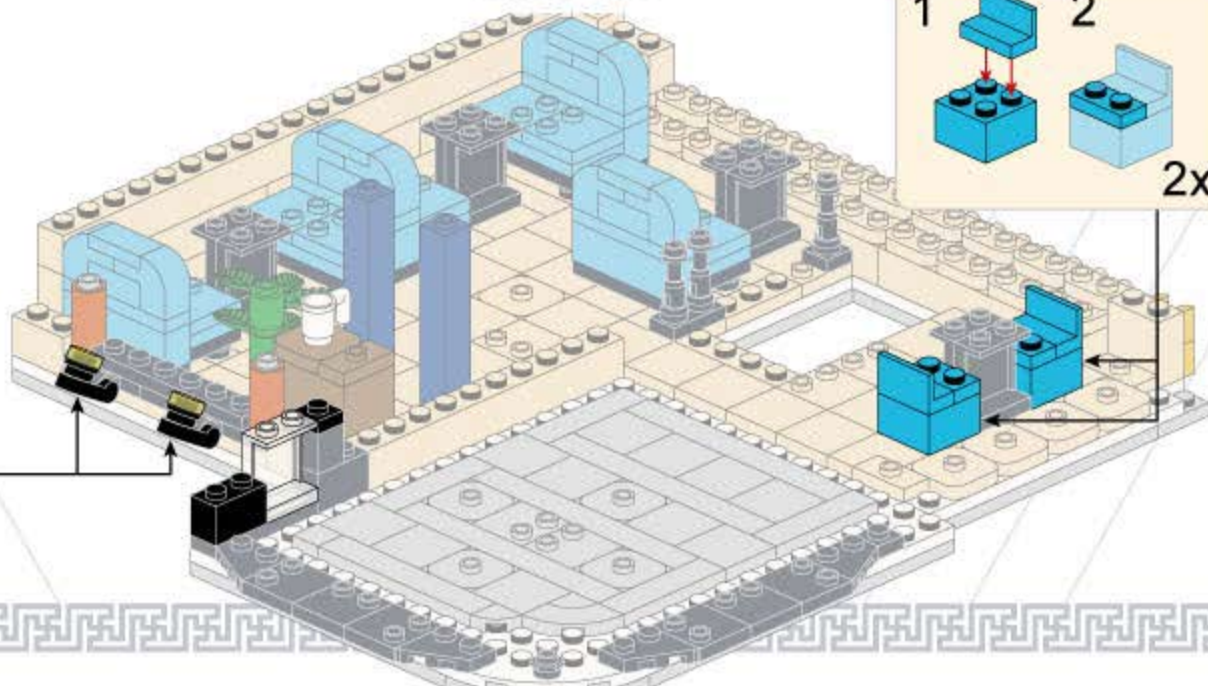
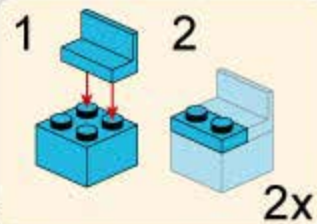

71



91

- 1x 1x12
- 1x 1x8
- 2x 1x1
- 1x 1x2
- 1x 1x3
- 1x 1x4
- 1x 1x5
- 1x 1x6
- 1x 1x7
- 1x 1x8
- 1x 1x9
- 1x 1x10
- 1x 1x11
- 1x 1x12

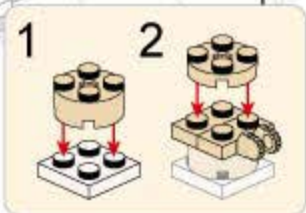
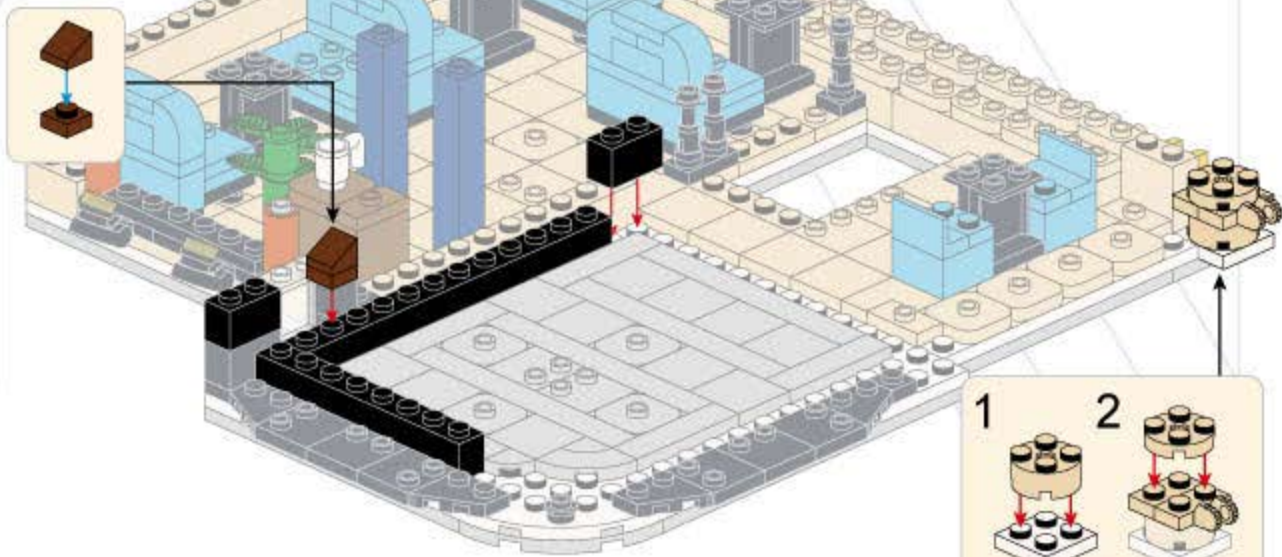

92

- 1x 1x1
- 1x 1x2
- 1x 1x3
- 1x 1x4
- 1x 1x5
- 1x 1x6
- 1x 1x7
- 1x 1x8
- 1x 1x9
- 1x 1x10
- 1x 1x11
- 1x 1x12

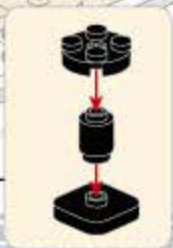
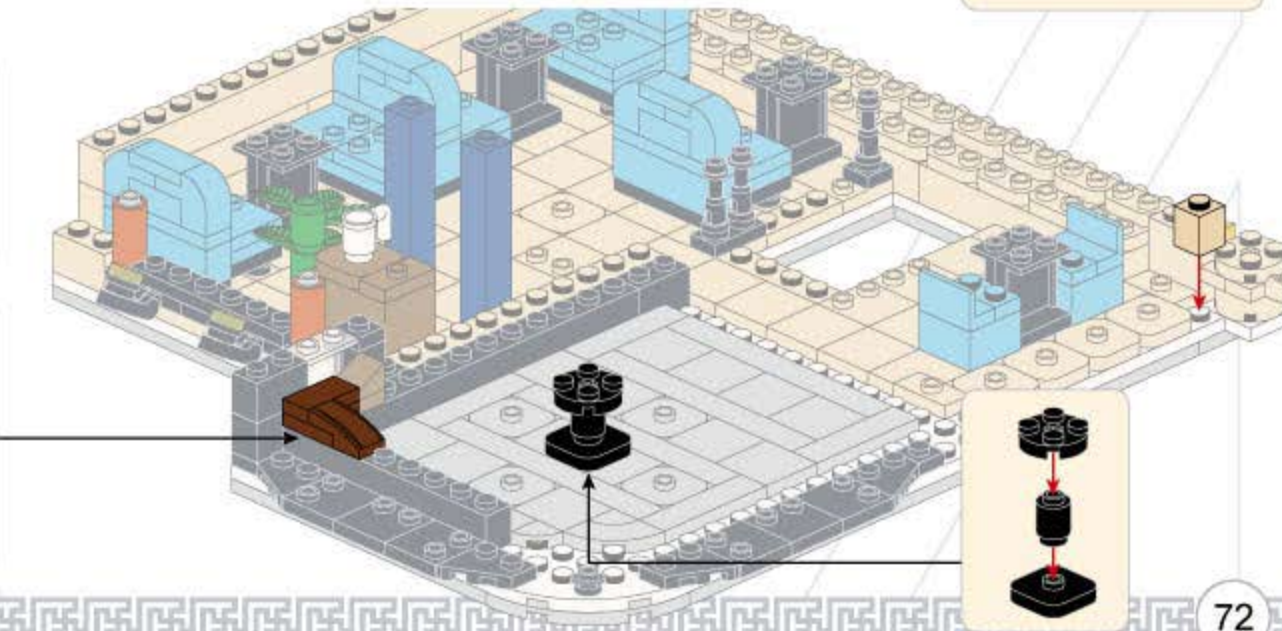
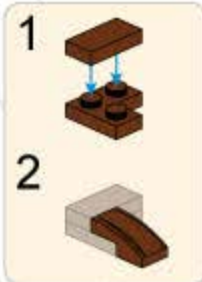

72



10



93

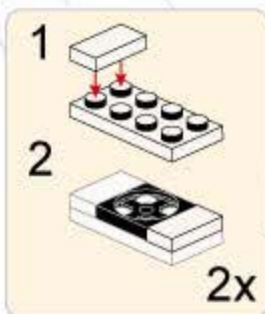
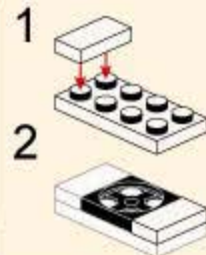
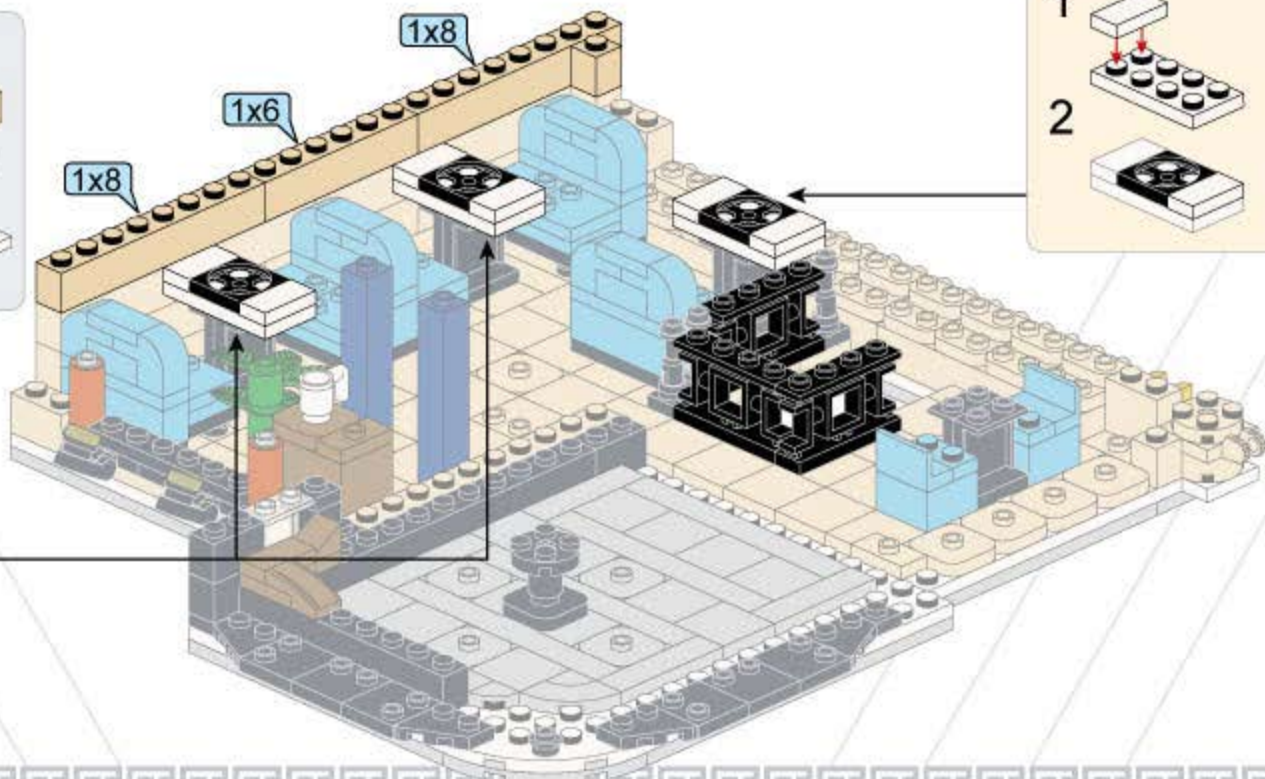
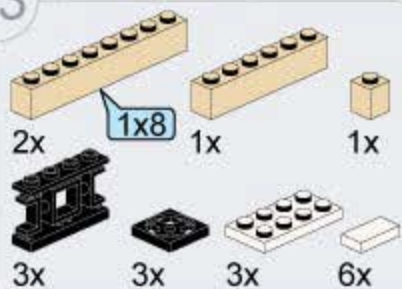

73

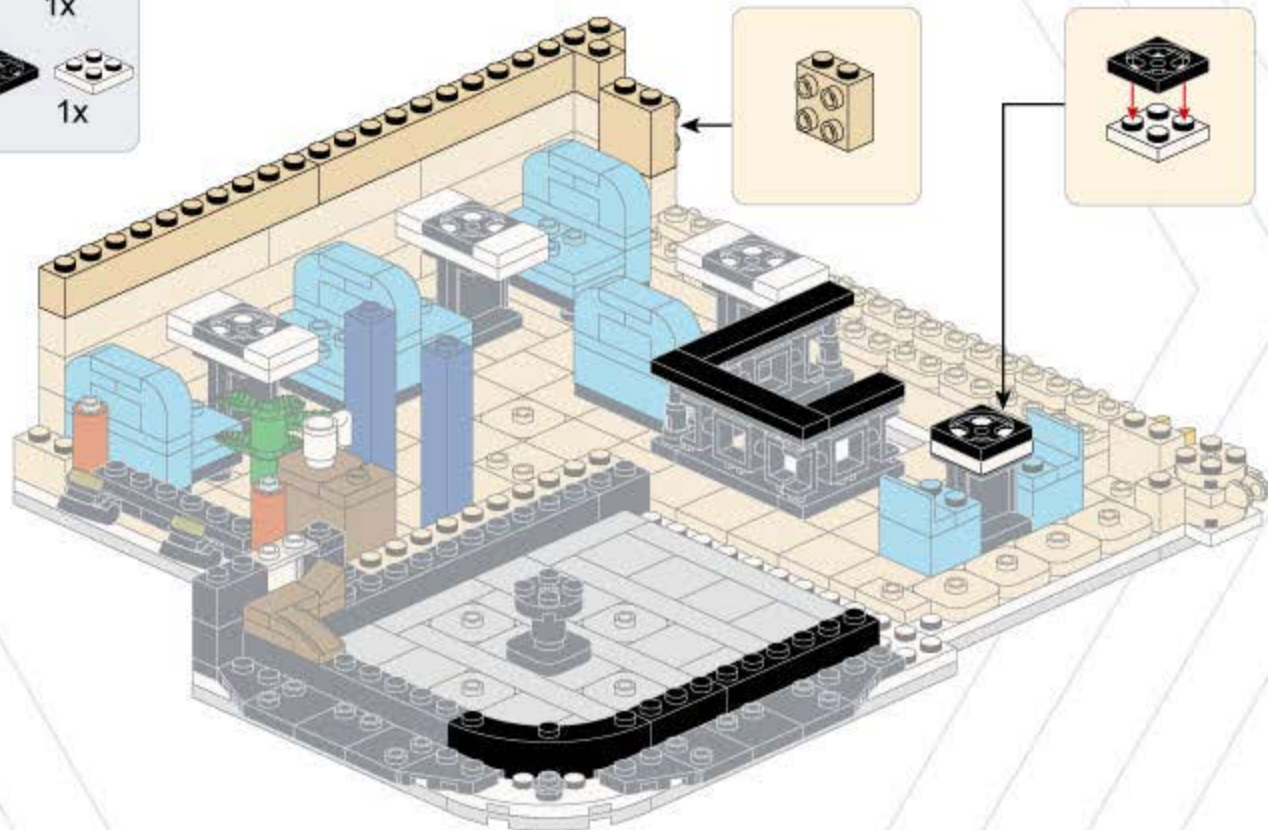
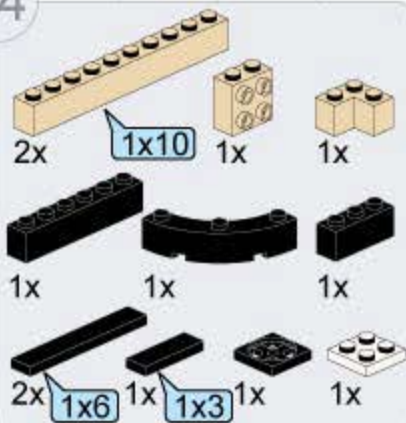

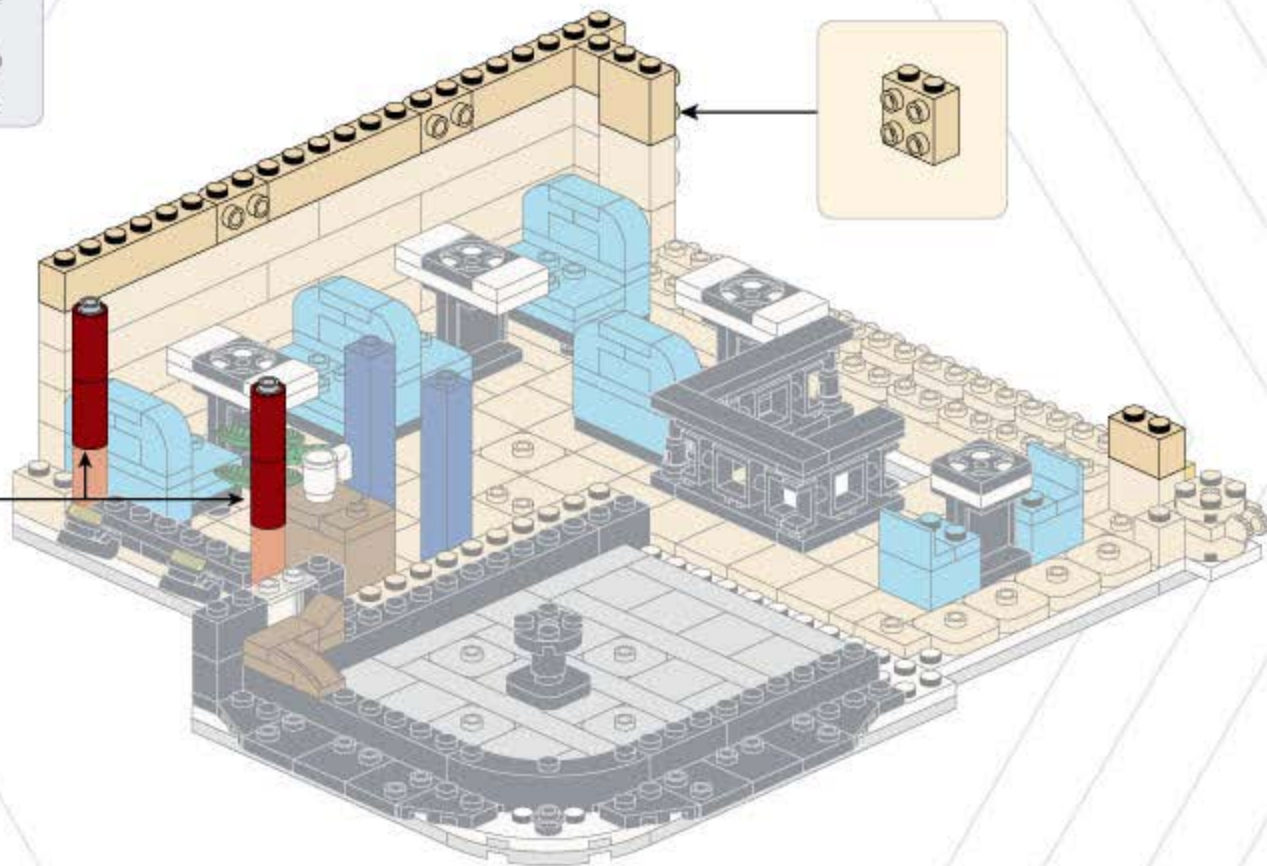
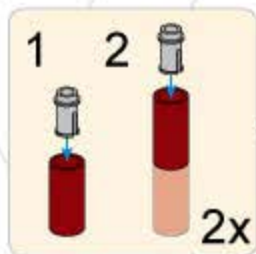
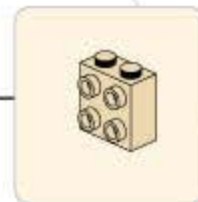
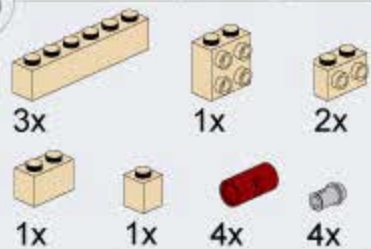

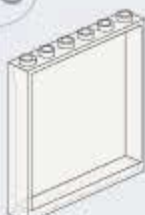

3x



1x



1x



3x



1x



2x



2x



2x



2x



2x



2x



1

2

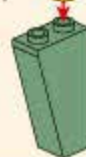

2x

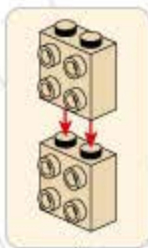
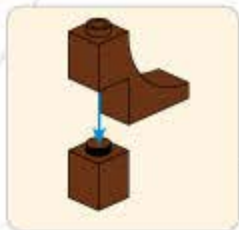
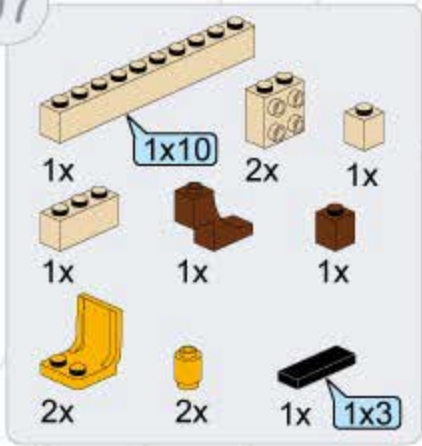

98



1x



1x



2x



1x



1:1



10x



1x



1x

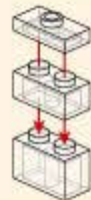
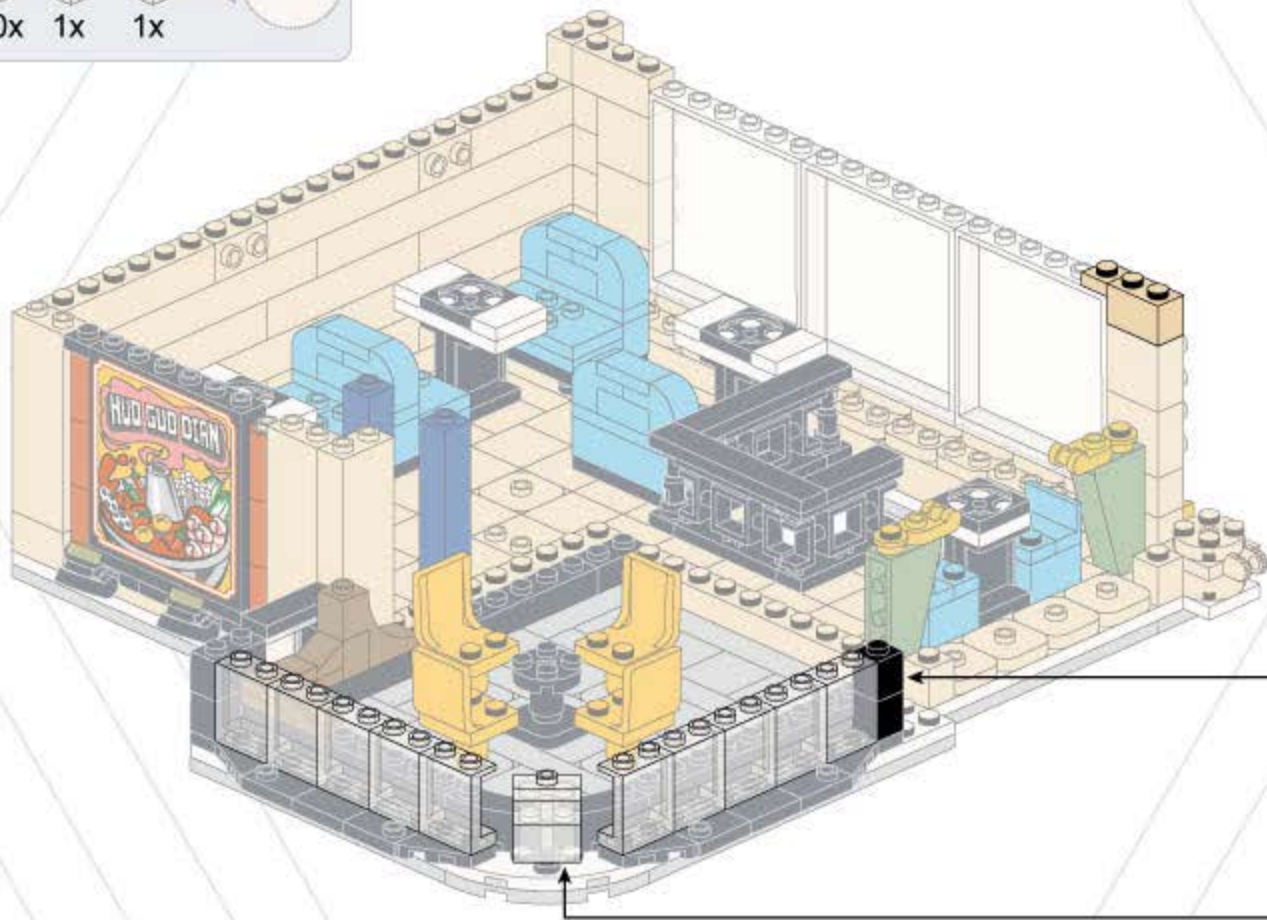
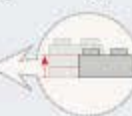

78

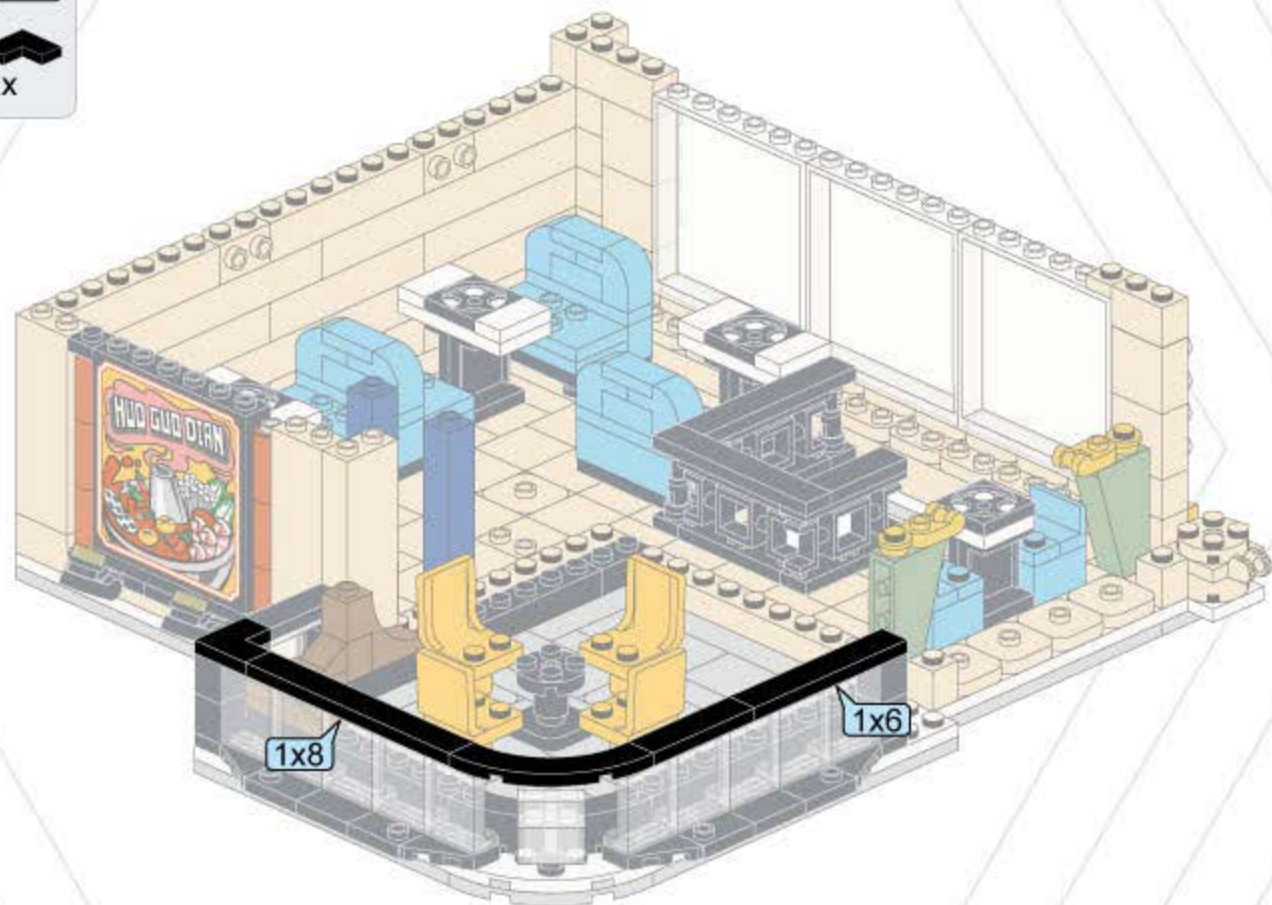
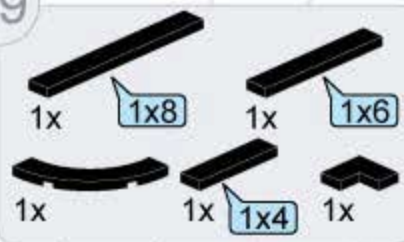





100



1x



2x



2x

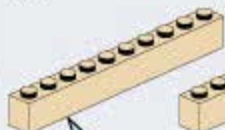

1x

1x10



1x



1x



1x



1x



1x

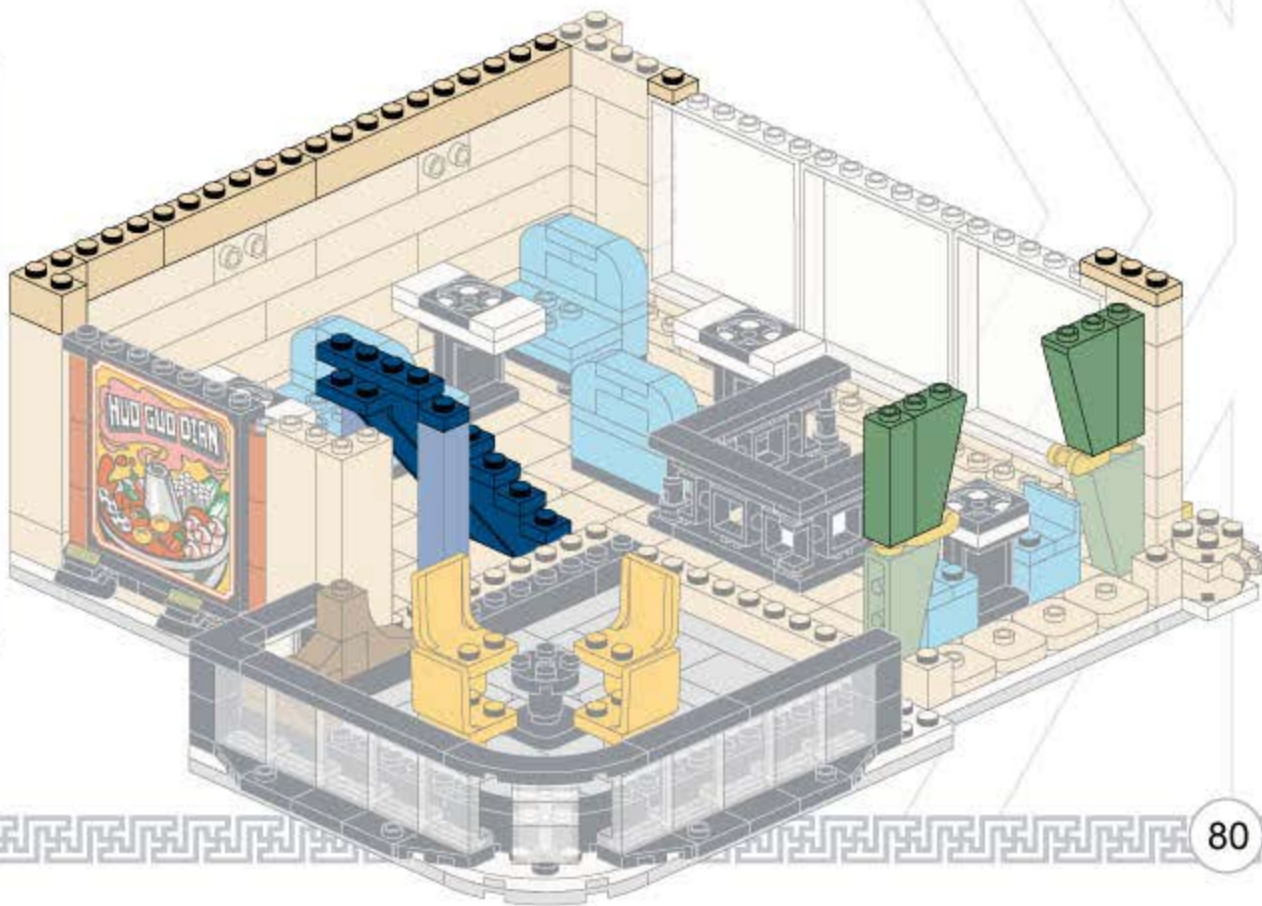

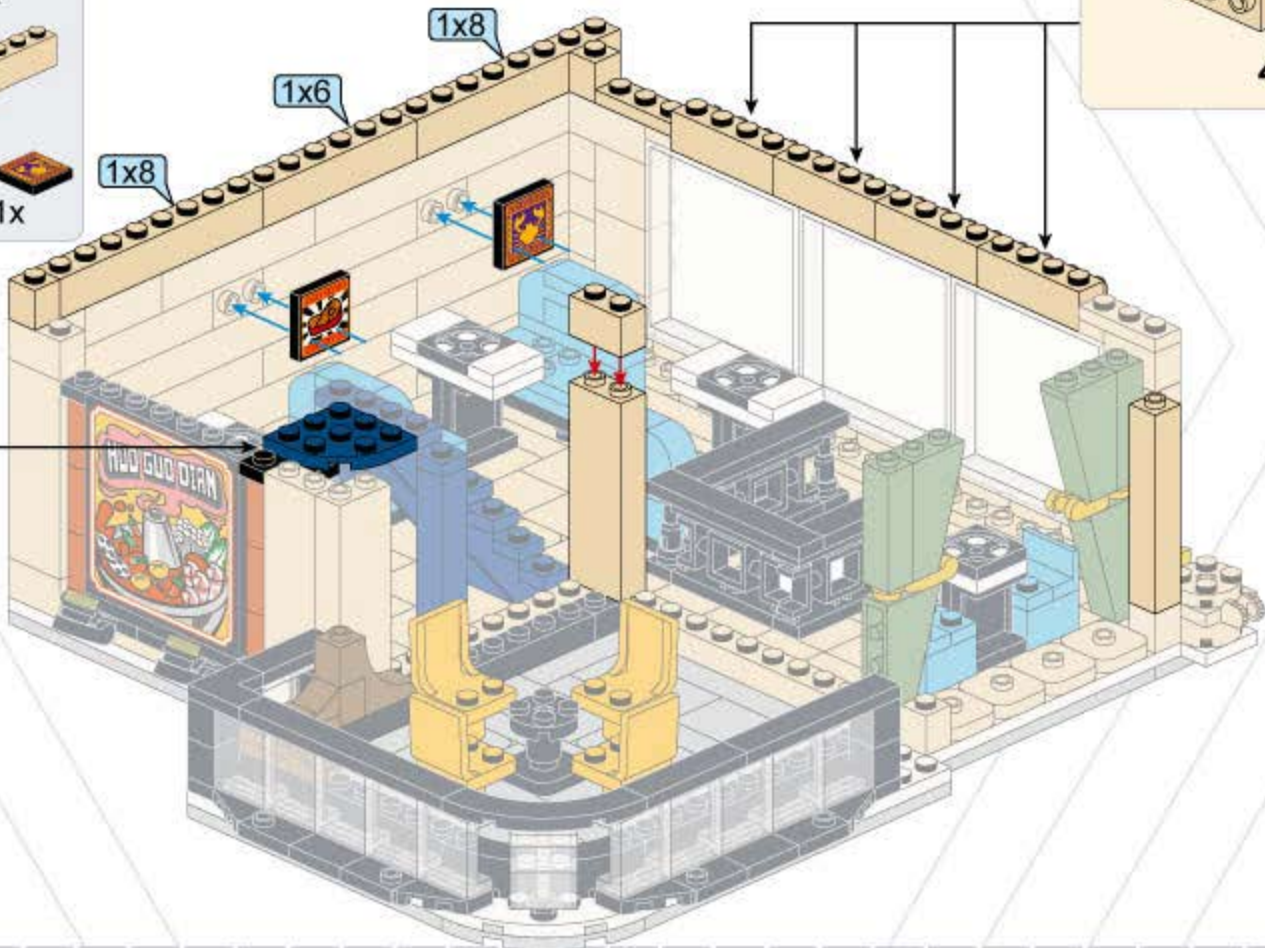
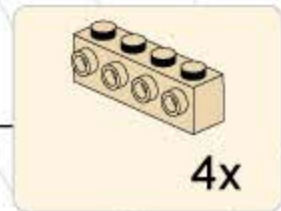
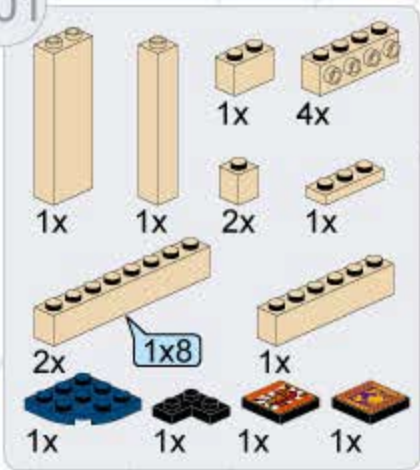

- 4x [1x4 white plate]
- 2x [1x4 white door]
- 2x [1x4 black frame]
- 1x [1x4 tan brick]
- 1x [1x1 tan brick]
- 1x [1x8 tan Technic beam]
- 2x [1x2 black Technic brick]
- 1x [1x1 tan Technic brick]
- 2x [1x1 tan Technic brick]

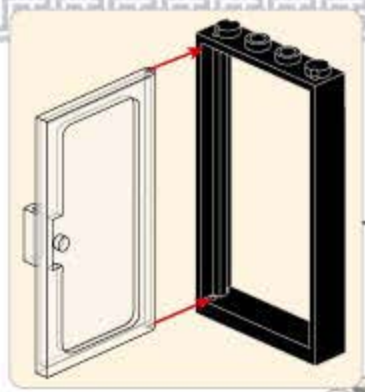

- 1x
- 7x
- 4x
- 1x
- 1x
- 1x
- 1x
- 1x
- 1x
- 2x
- 1x
- 1x
- 1x
- 2x
- 1x
- 2x
- 1x
- 2x
- 1x

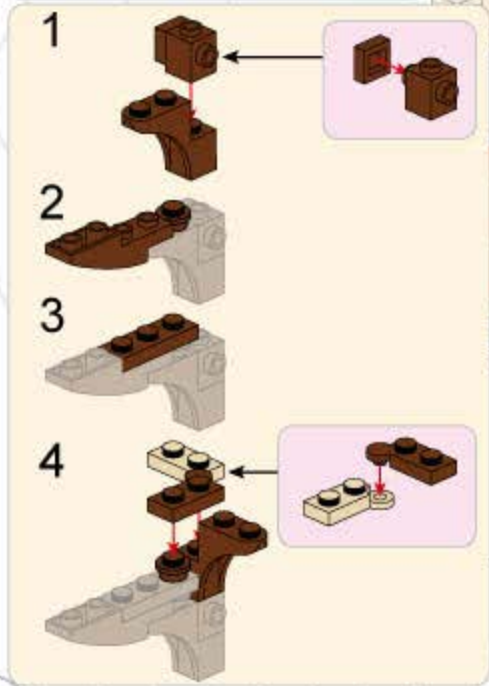
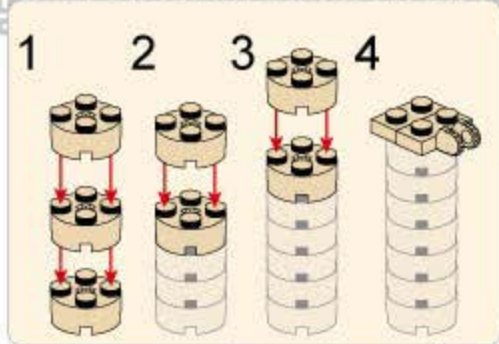
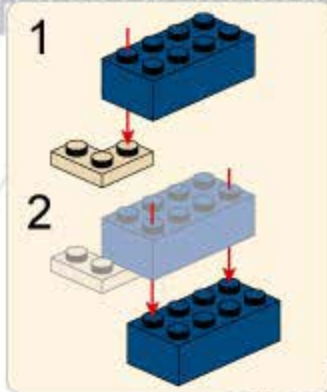

104

- 1x [Black 4x6 Plate]
- 2x [Black 1x8 Technic Beam]
- 1x [Black 1x1 Pin]
- 1x [Red and Green 2x4 Technic Plate]
- 8x [Green 1x1 Pin]
- 8x [White 1x1 Pin]
- 1x [Tan 1x2 Technic Brick with 2 Holes]
- 1x [Tan 1x2 Technic Brick with 2 Holes]
- 9x [Tan 1x2 Technic Brick with 2 Holes]
- 1x [Tan 1x2 Technic Brick with 2 Holes]
- 1x [Tan 1x3 Technic Brick with 3 Holes]
- 1x [Tan 1x3 Technic Brick with 3 Holes]
- 1x [Tan 1x3 Technic Brick with 3 Holes]
- 1x [Tan 1x3 Technic Brick with 3 Holes]

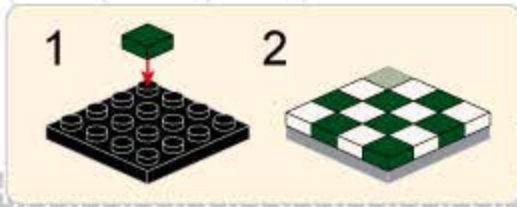
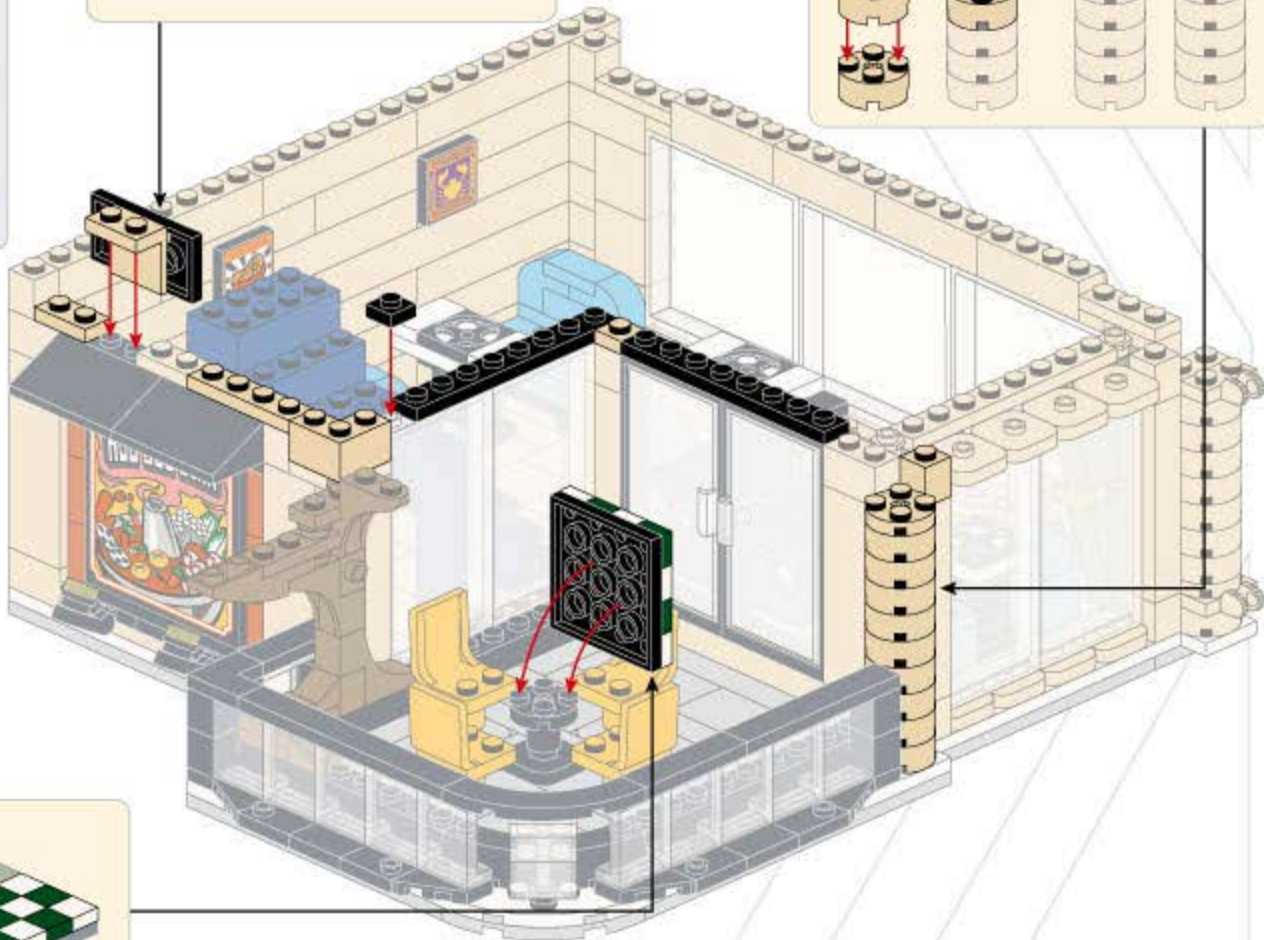
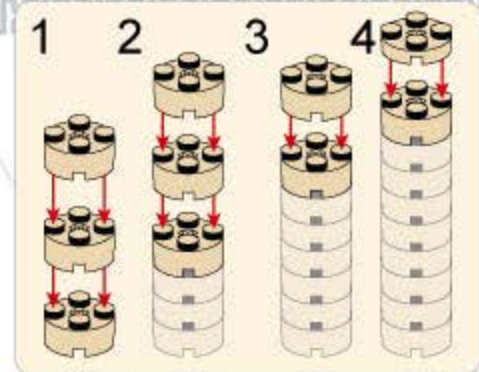
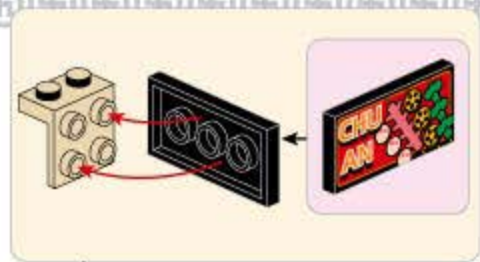







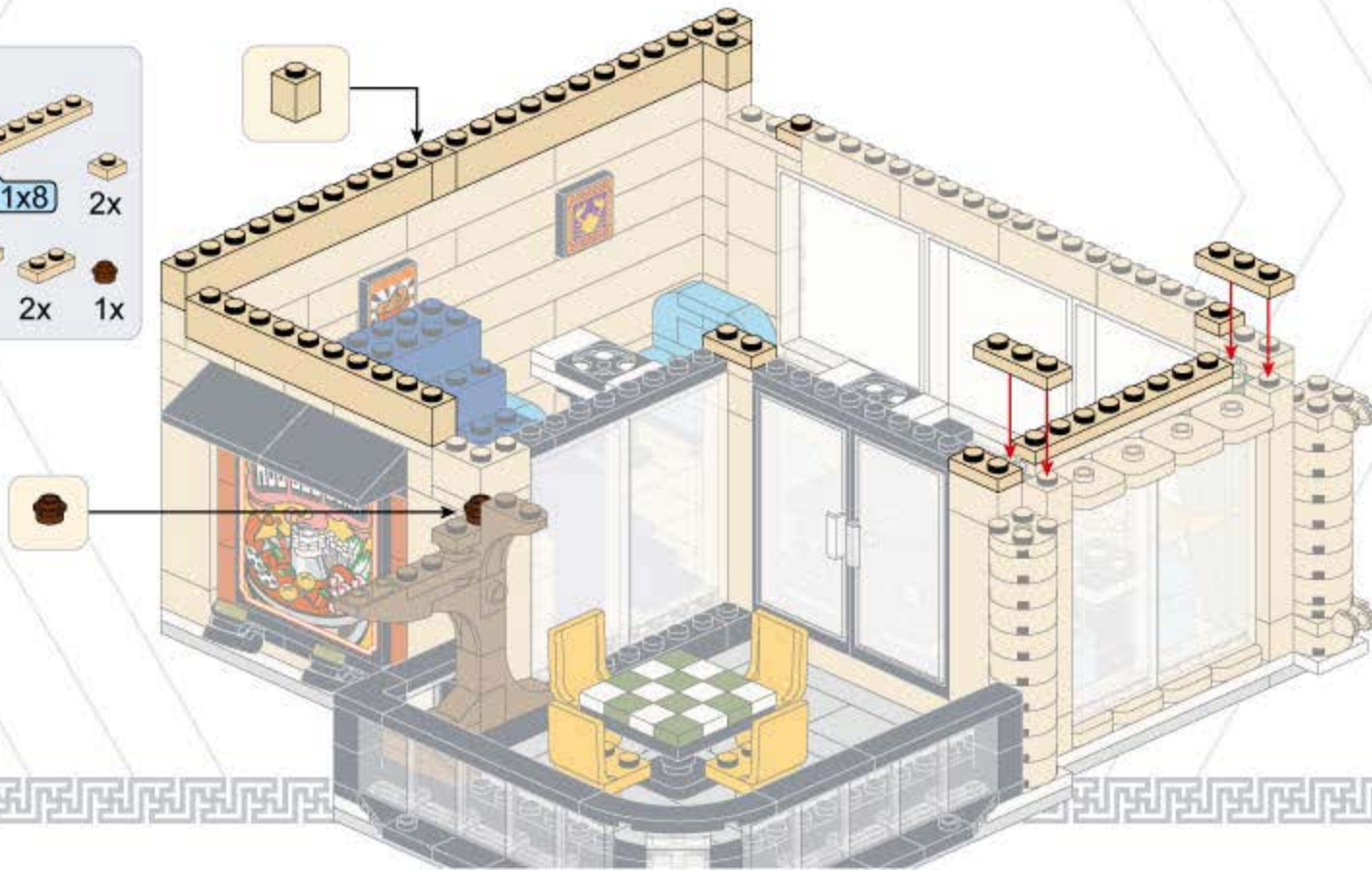
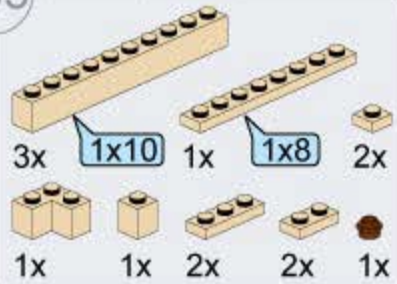









12



105



- 1x  1x10
- 1x  1x8
- 1x  1x4
- 1x  1x2
- 1x  1x3
- 1x  1x4
- 1x  1x2
- 2x  1x2
- 1x  1x4
- 1x  1x1
- 1x  1x4
- 4x  1x2
- 4x  1x2
- 2x  1x2
- 6x  1x2
- 1x  1x4
- 1x  1x1

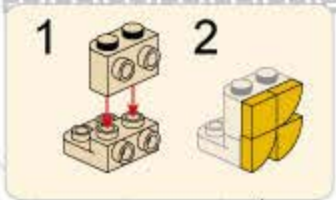
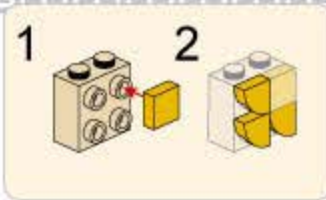

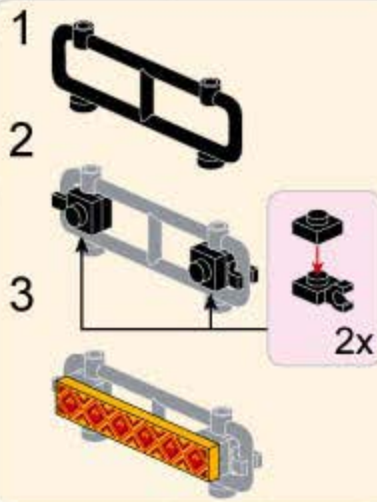
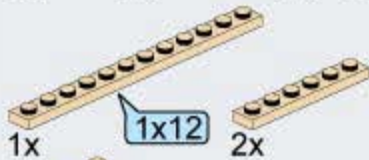



- 1x
- 1x
- 1x
- 2x
- 2x
- 2x
- 1x
- 1x
- 1x
- 1x
- 2x

- 1
  - 2
  - 3
- 2x

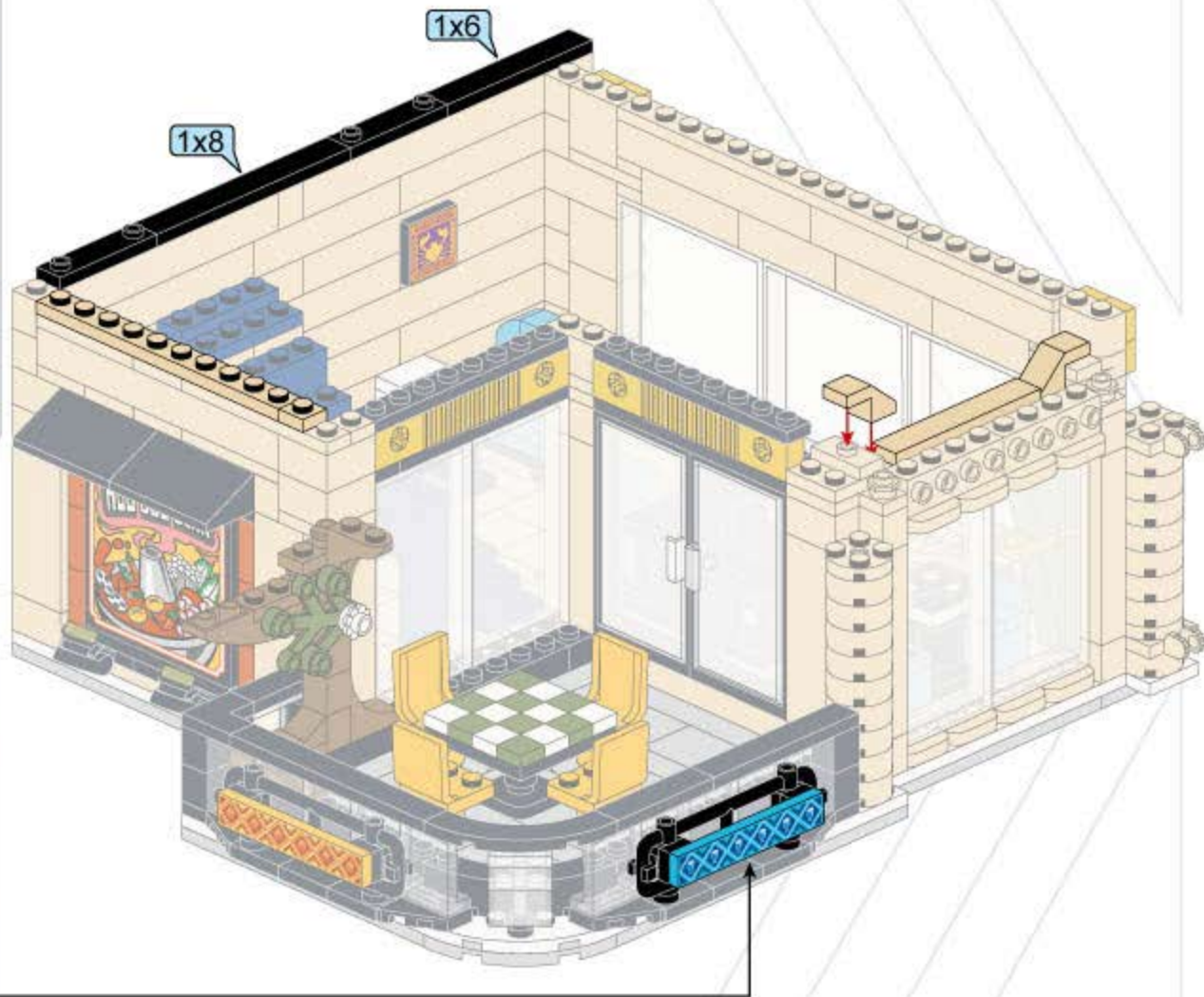

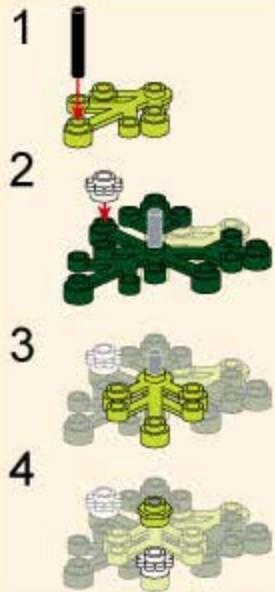
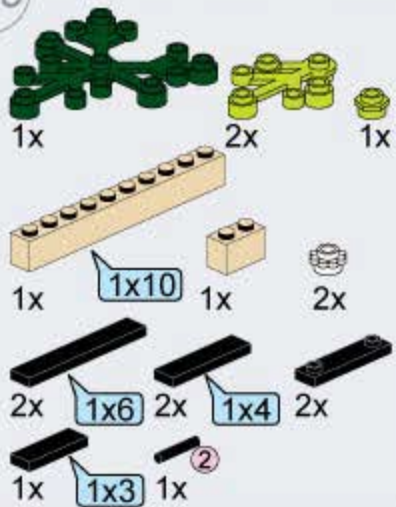

110

- 1x 1x12
- 1x 1x10
- 1x 2x8
- 1x 1x8
- 1x 1x4
- 2x 1x2
- 2x 1x3
- 2x 1x2
- 4x 1x2

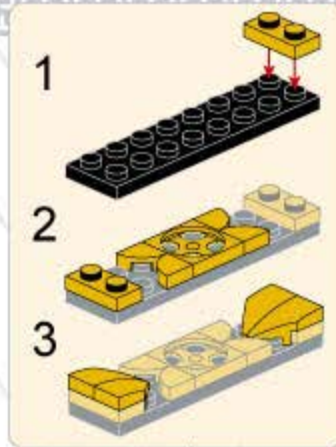

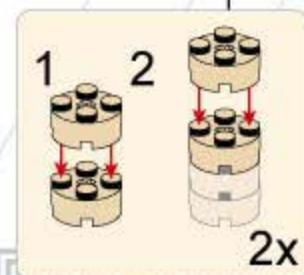
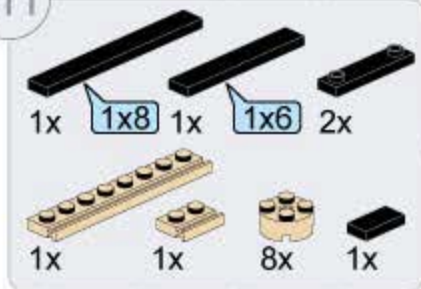

112

- 1x [2x8]
- 2x [L-shaped]
- 2x [1x2]
- 2x [1x1]
- 2x [4-way]
- 1x [3-way]
- 1x [1x1]
- 1x [1x1]
- 1x [Pin]

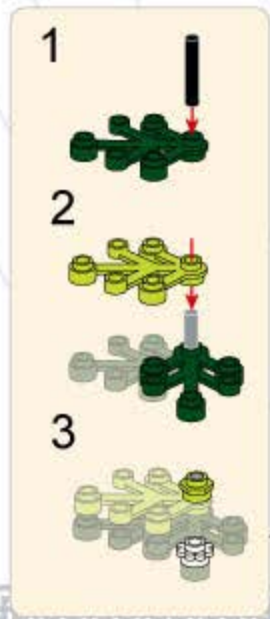

113



1



2

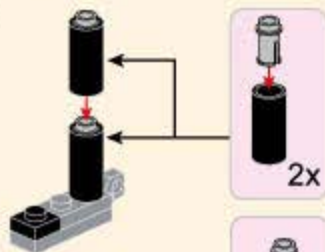

3

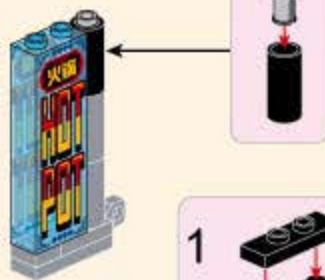

4

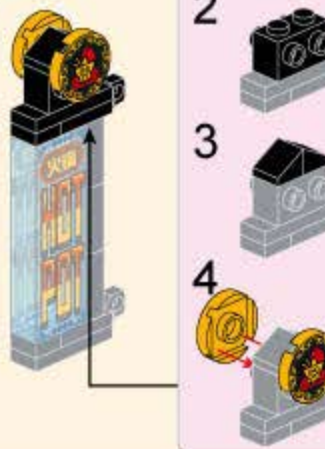

93

114



2x



4x

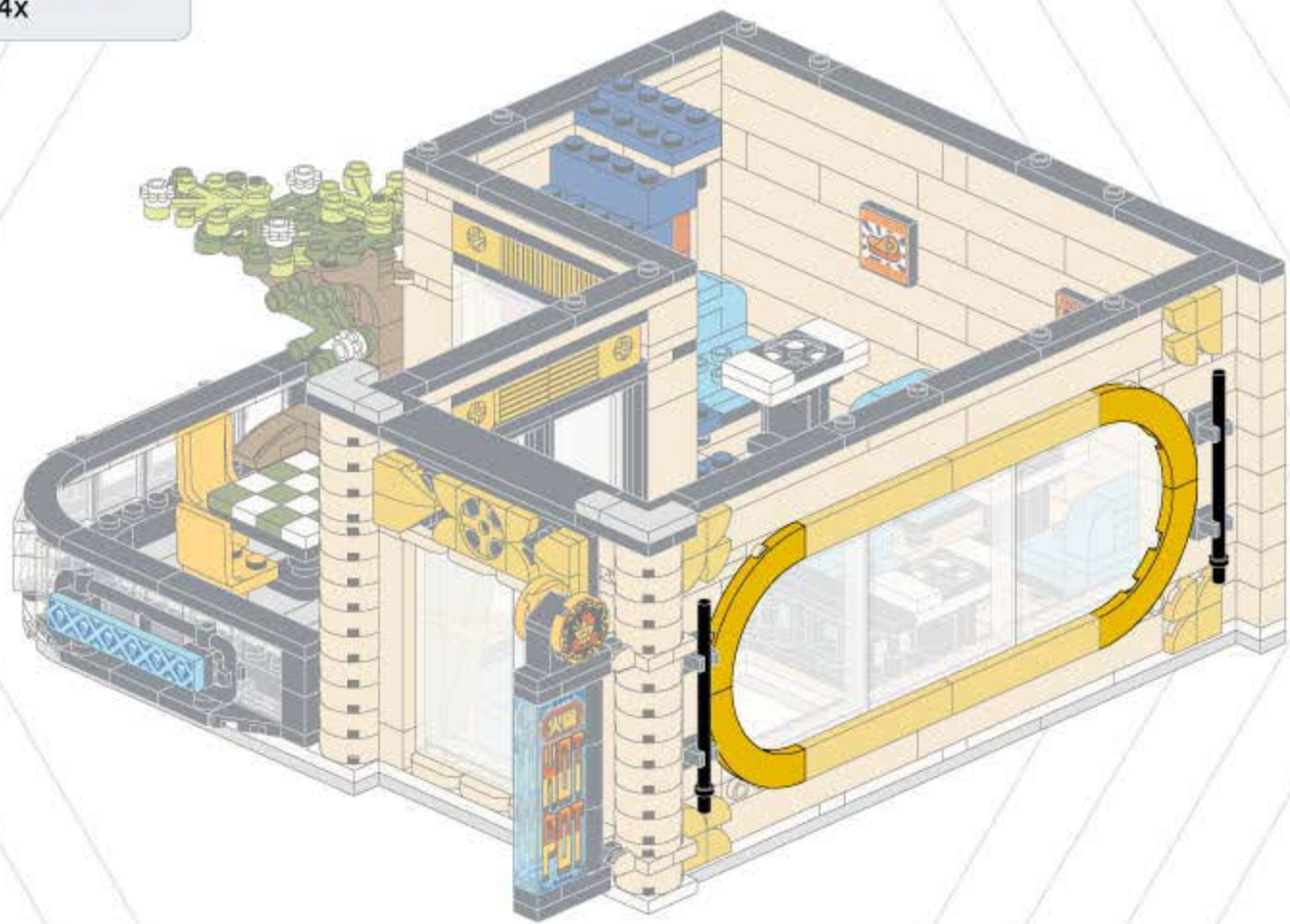

114

64





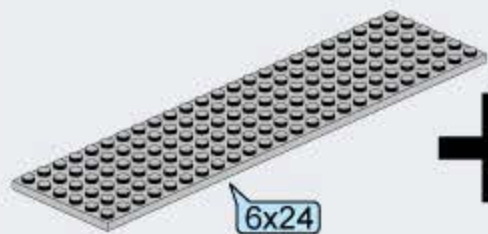

2x

+

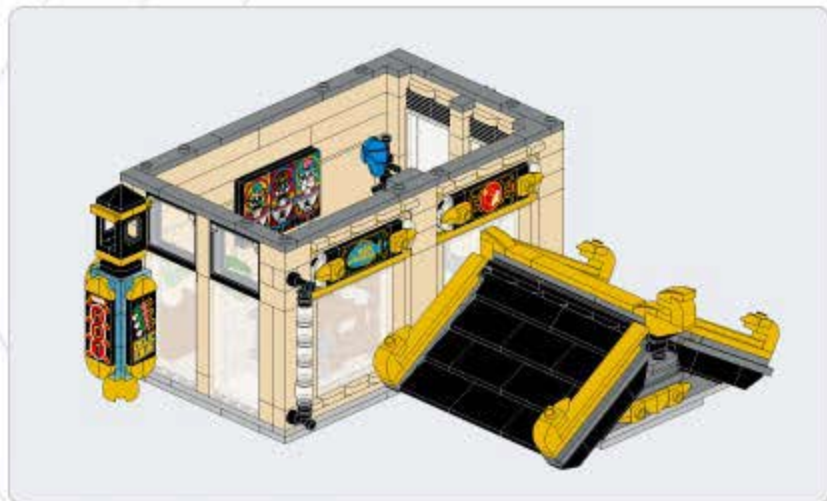
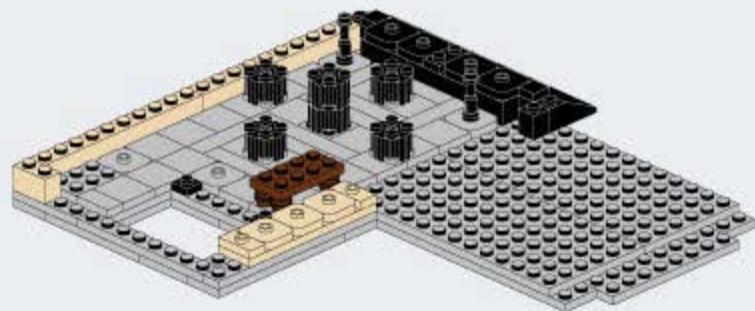

116

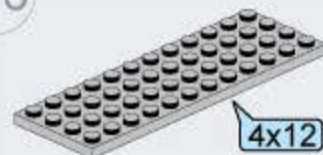

1x



1x



1x

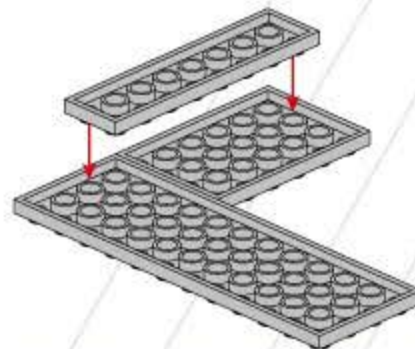

117

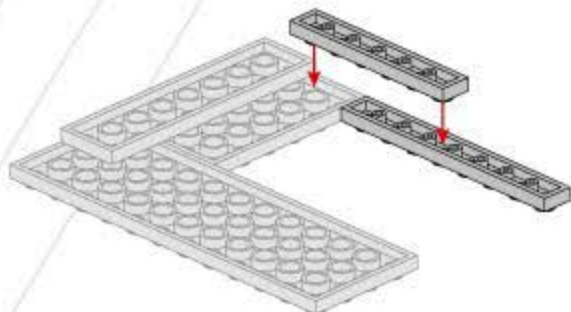
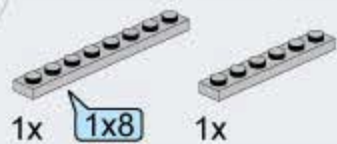

118

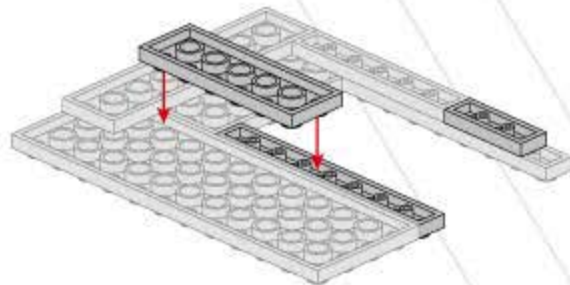
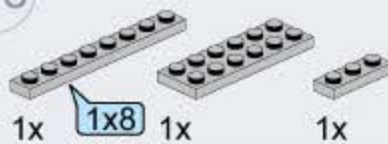

119

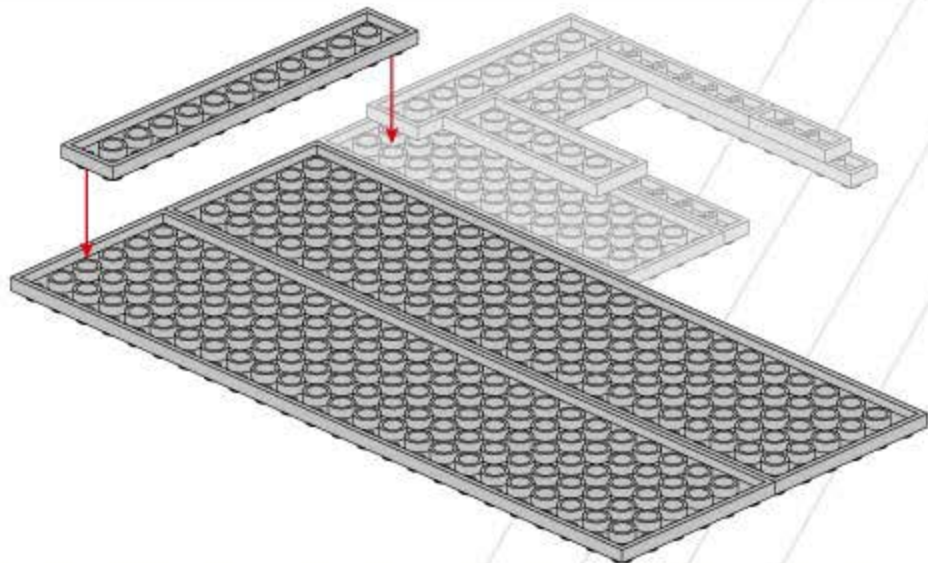
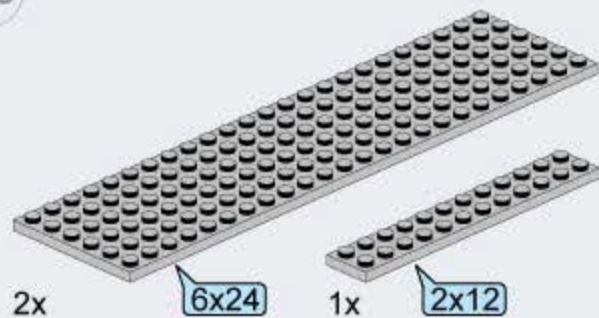

120

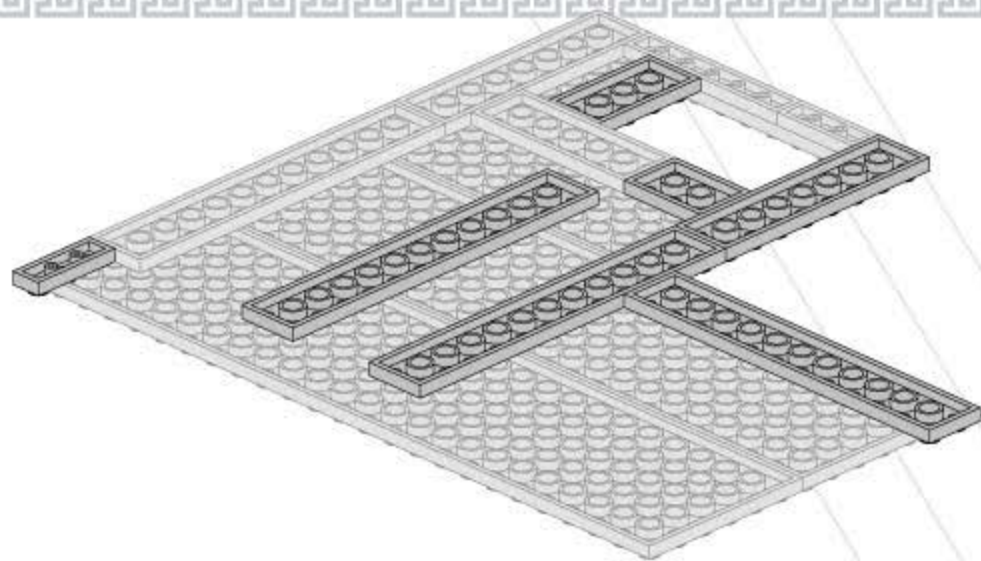
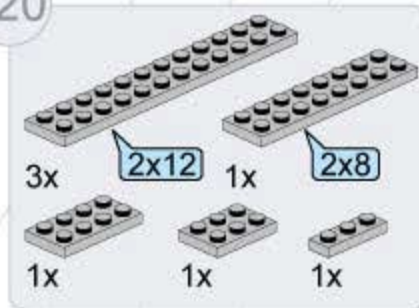

121

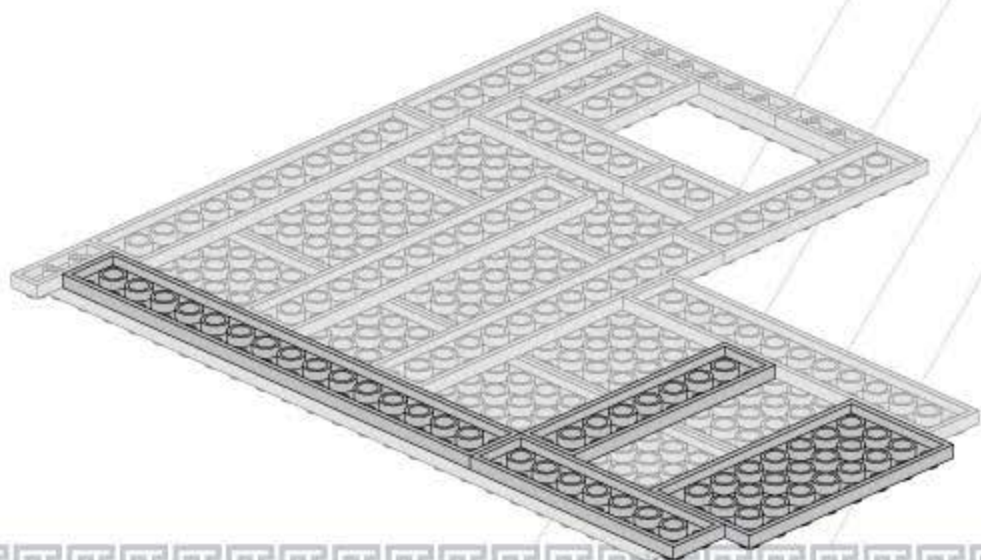
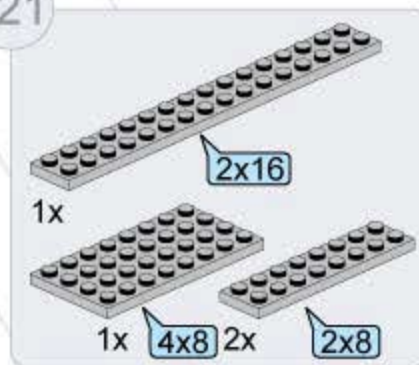

122

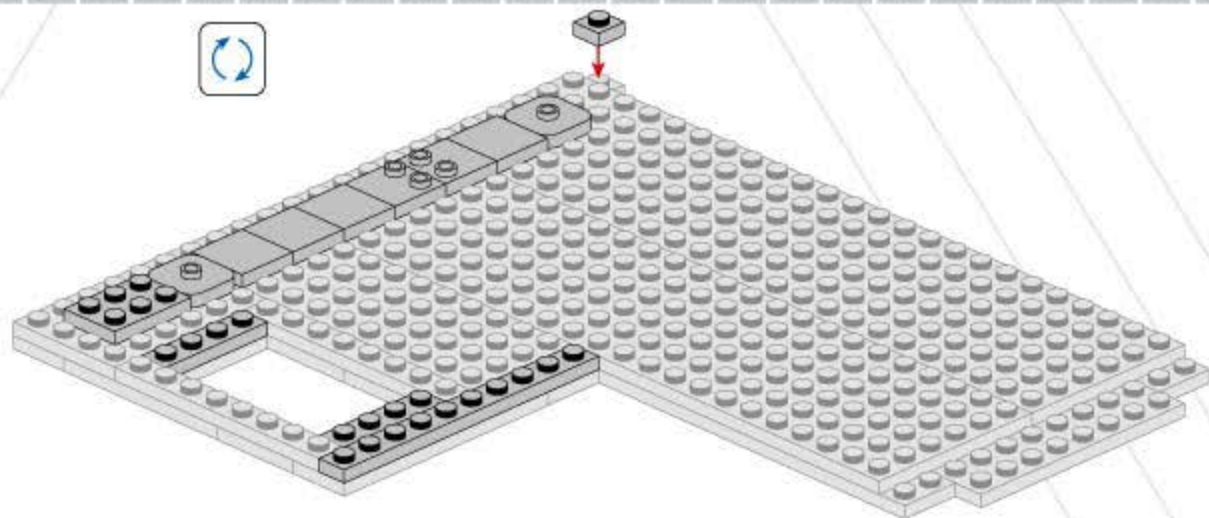
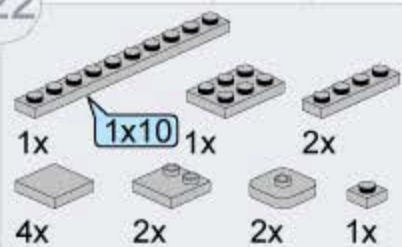

123

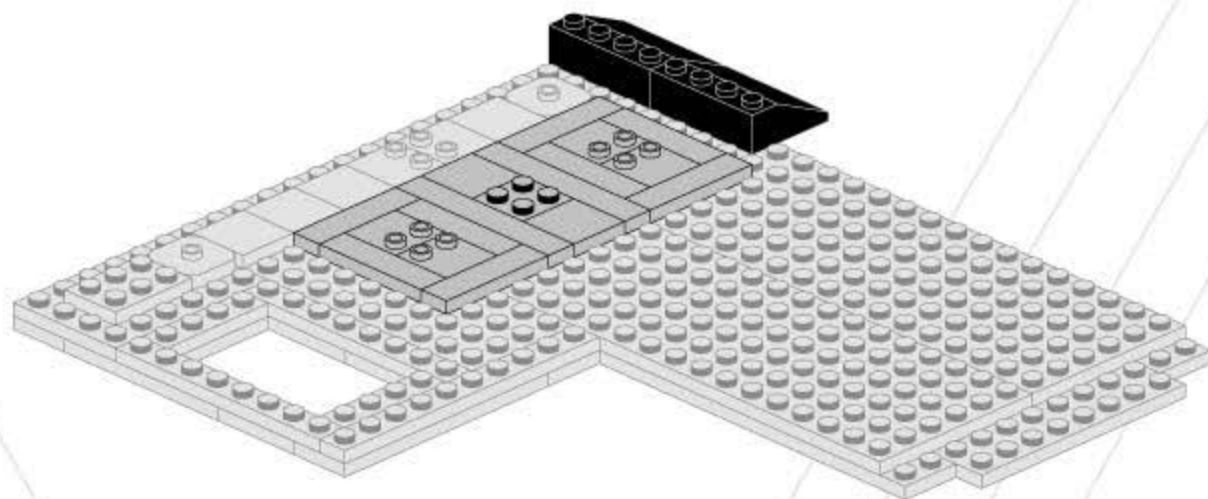
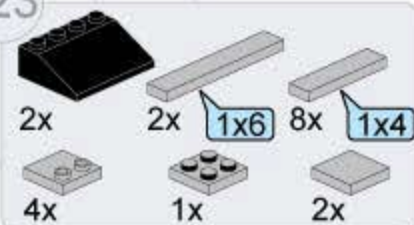



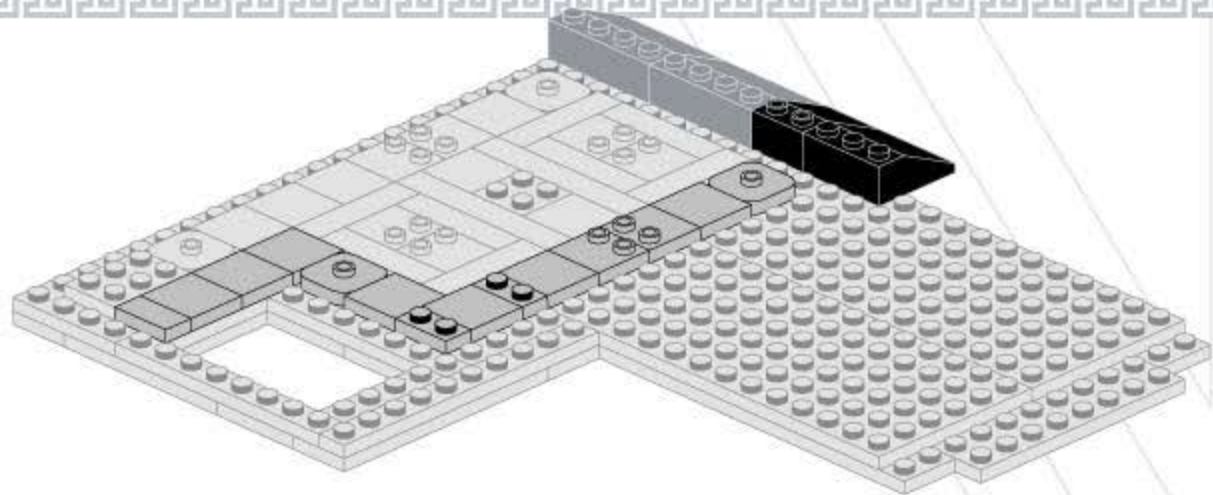
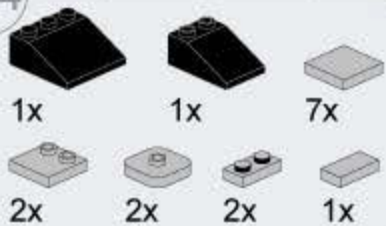

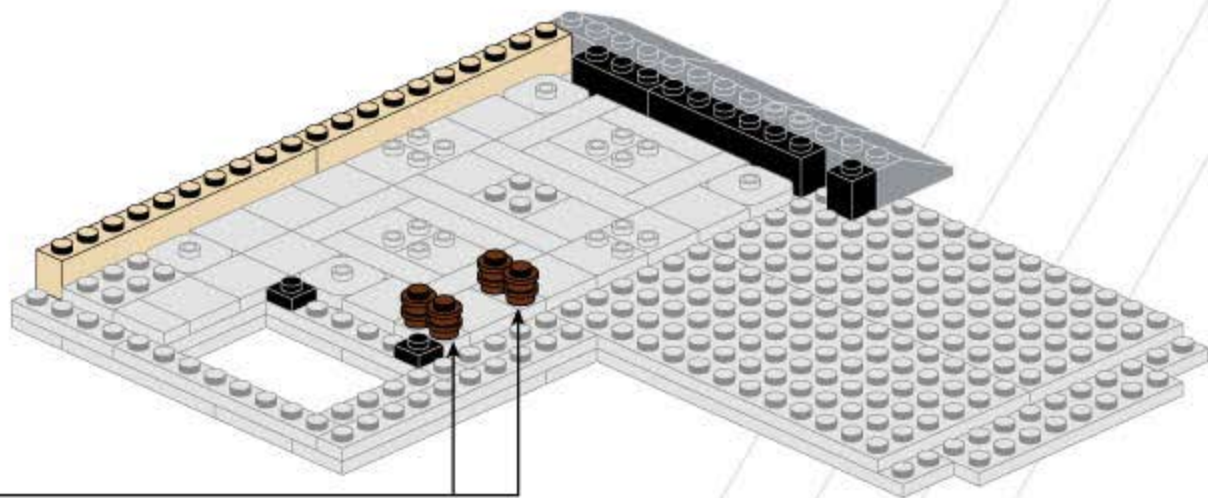
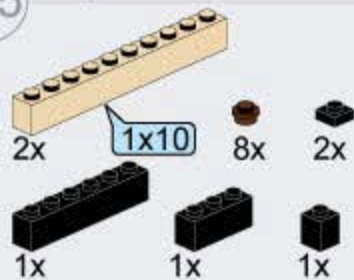

124



125







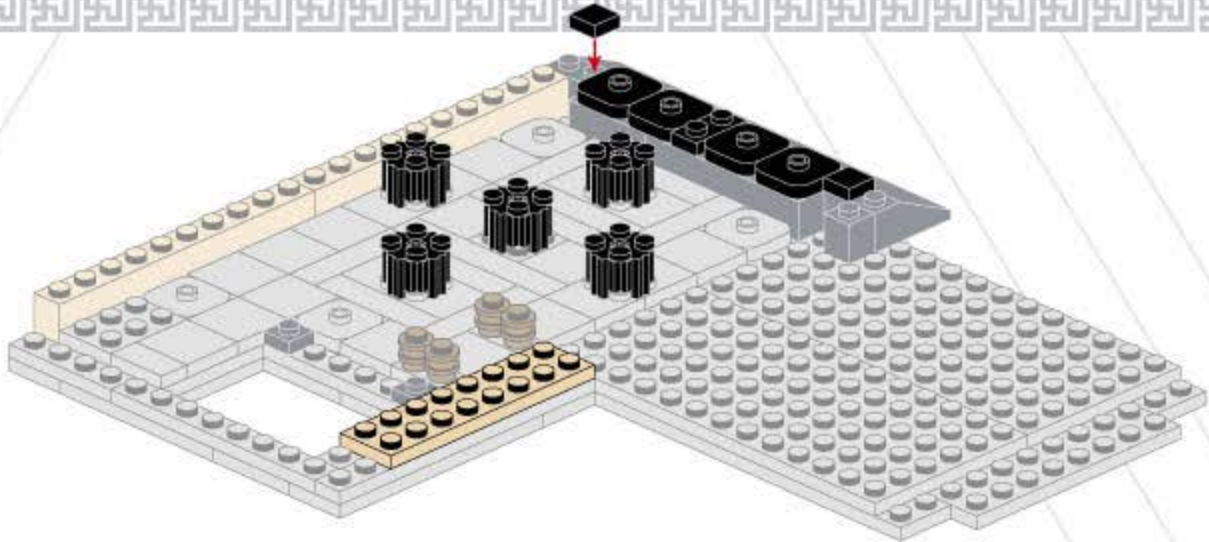

126

1x  2x8  5x  4x  1x  2x 



127

2x  1x  1x  1x  3x  2x 

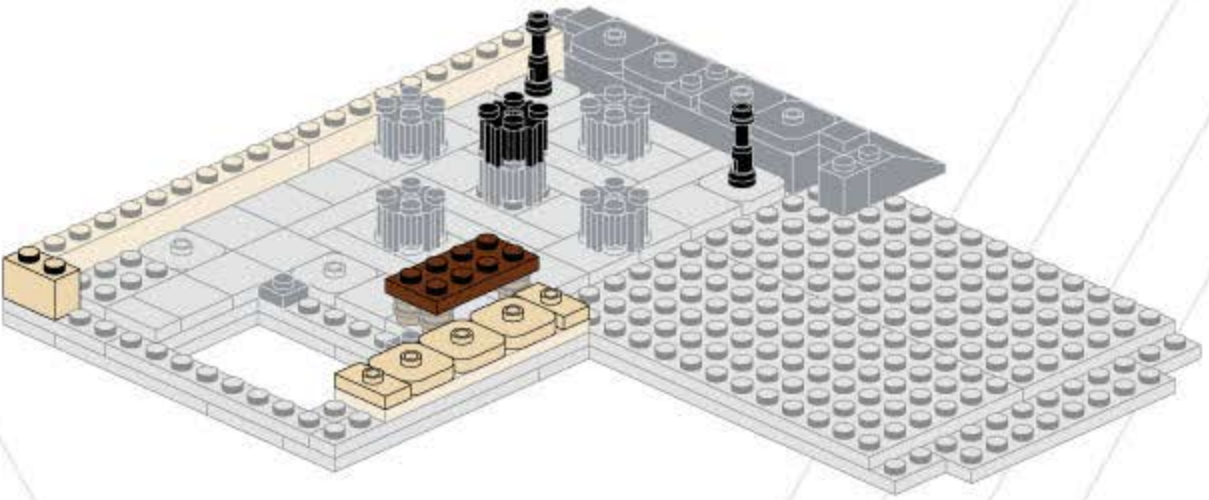

101



128



3x



2x



4x

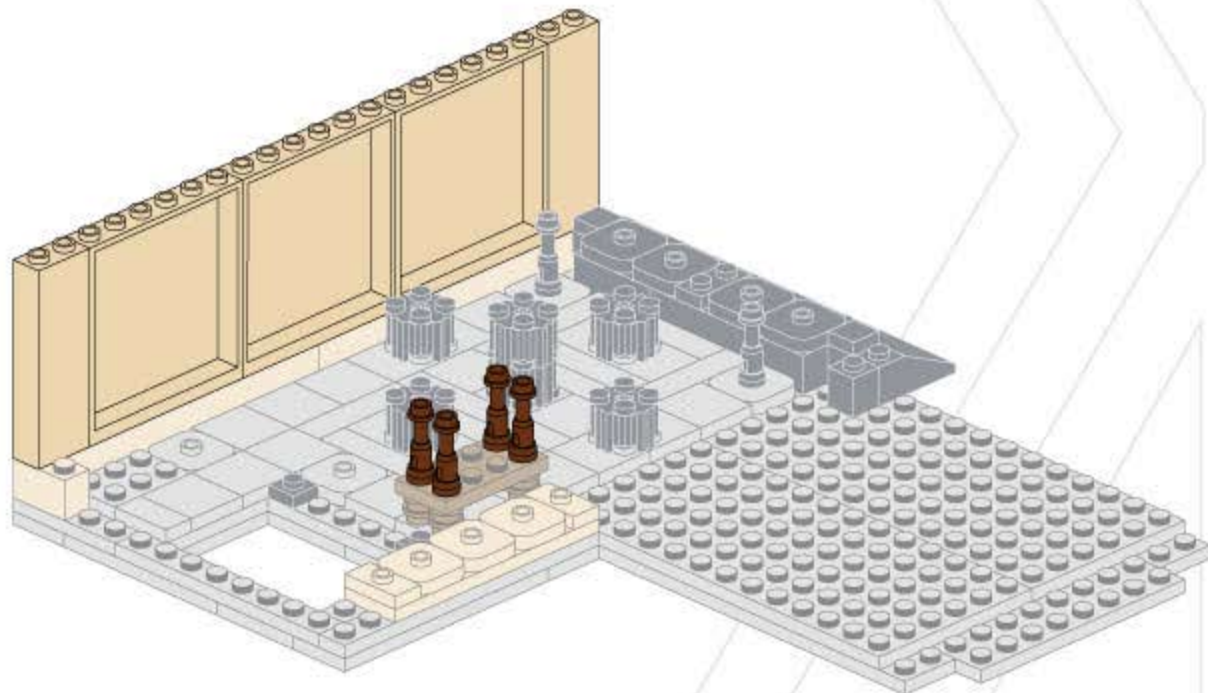

- 1x
- 2x
- 1x
- 1x
- 2x
- 2x
- 1x
- 1x
- 1x
- 1x

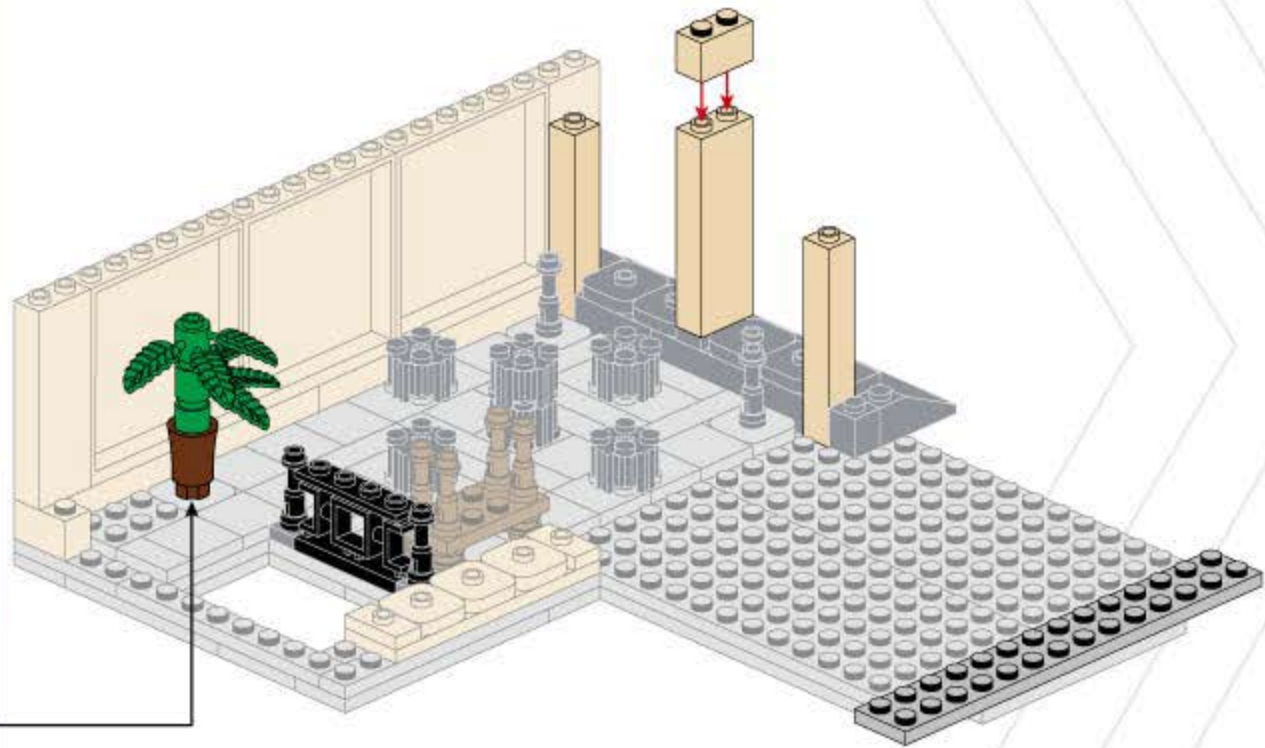
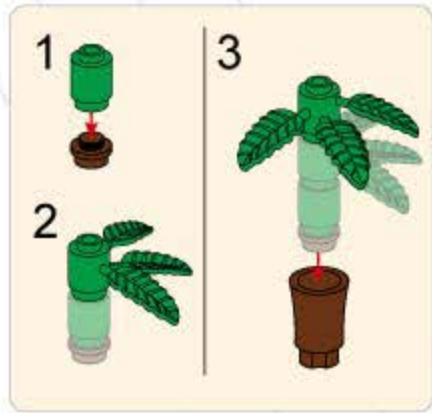



130

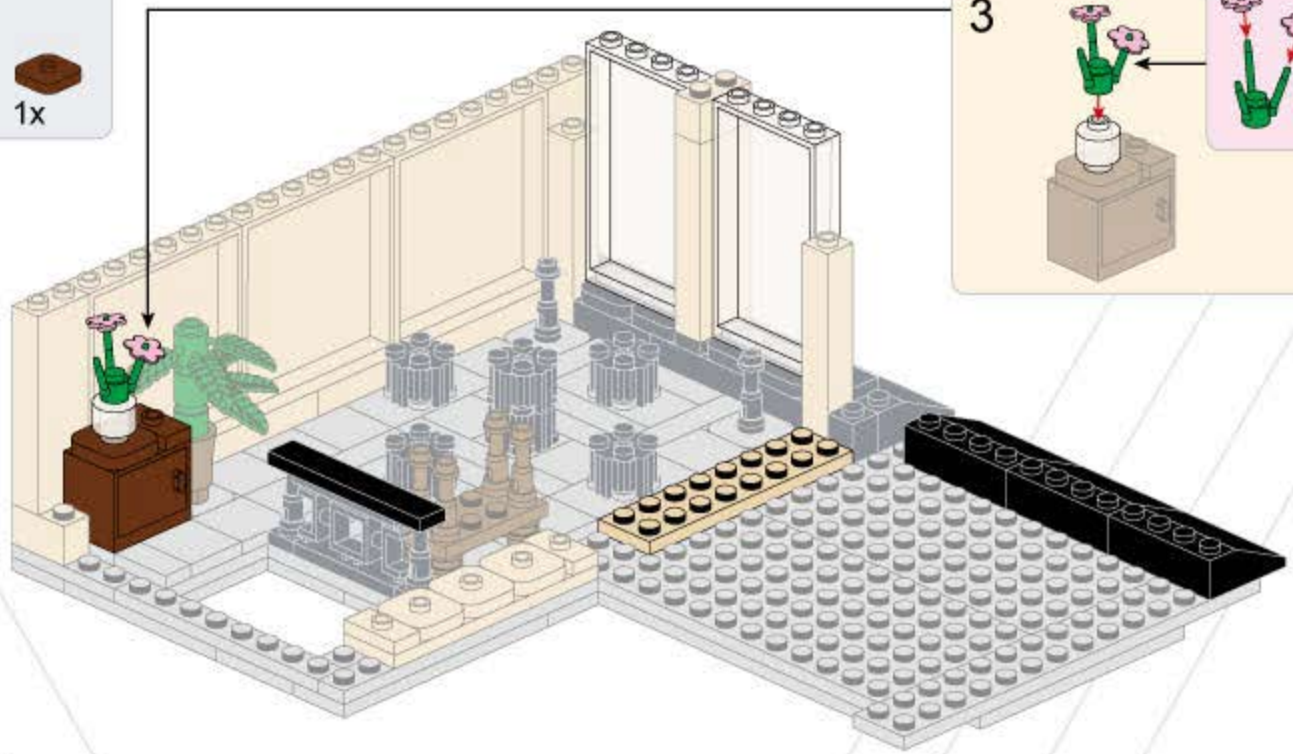
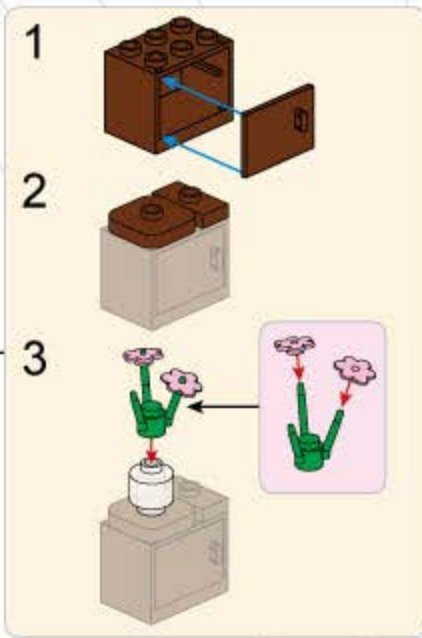
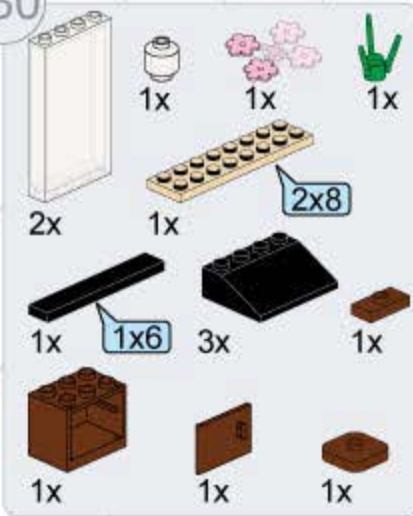

- 1x 1x10 (tan)
- 1x 1x8 (tan)
- 2x 1x1 (tan)
- 3x 1x1 (tan)
- 1x 1x1 (tan)
- 2x 1x2 (tan)
- 1x 1x2 (tan)
- 3x 1x1 (tan)
- 1x 1x1 (black)
- 1x 1x1 (yellow)
- 2x 1x1 (grey)
- 1x 1x1 (green)
- 1x 1x1 (red)
- 1x 1x1 (pink)

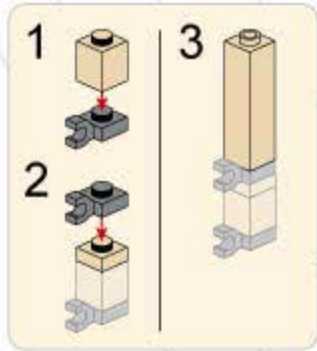
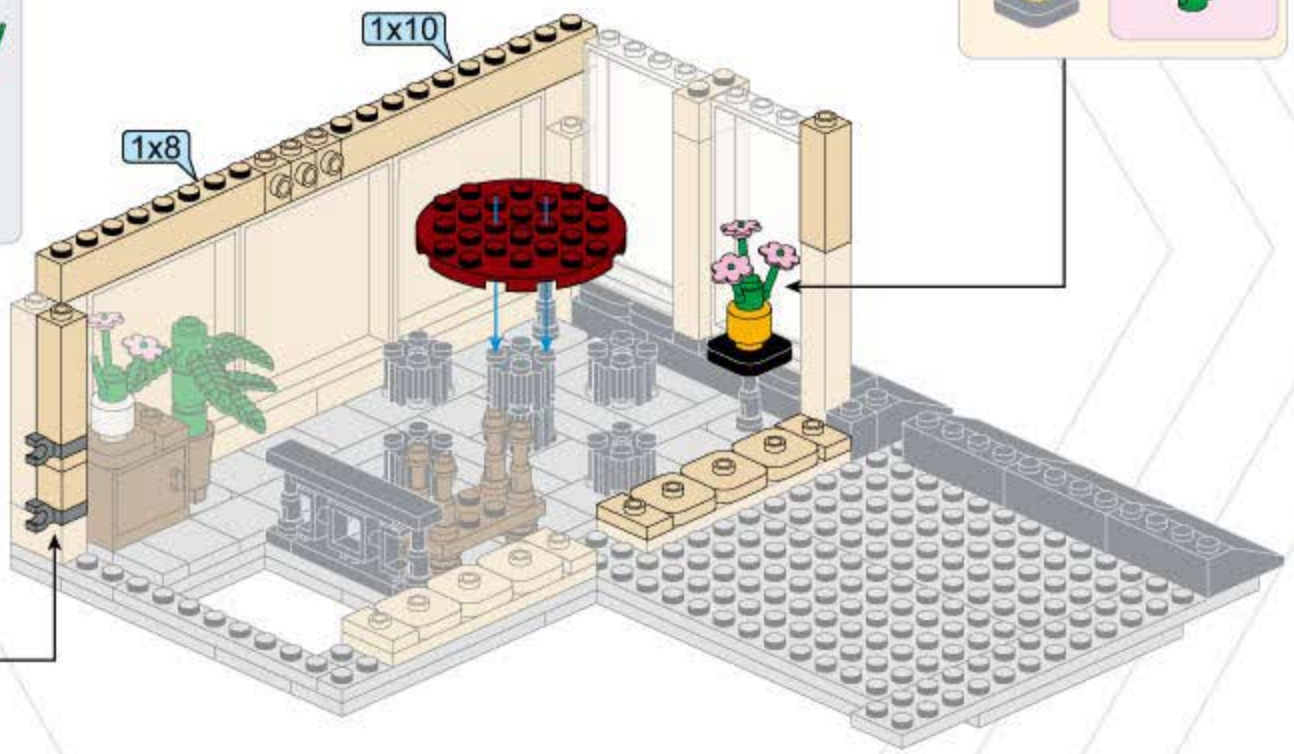
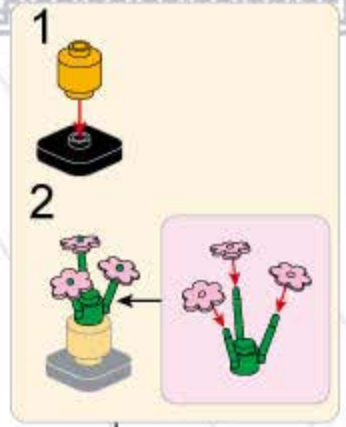

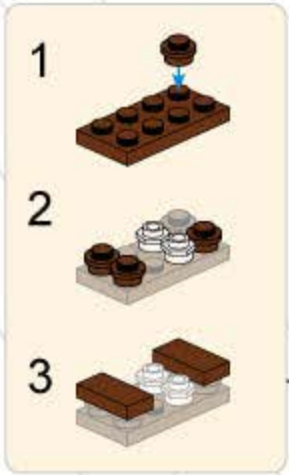
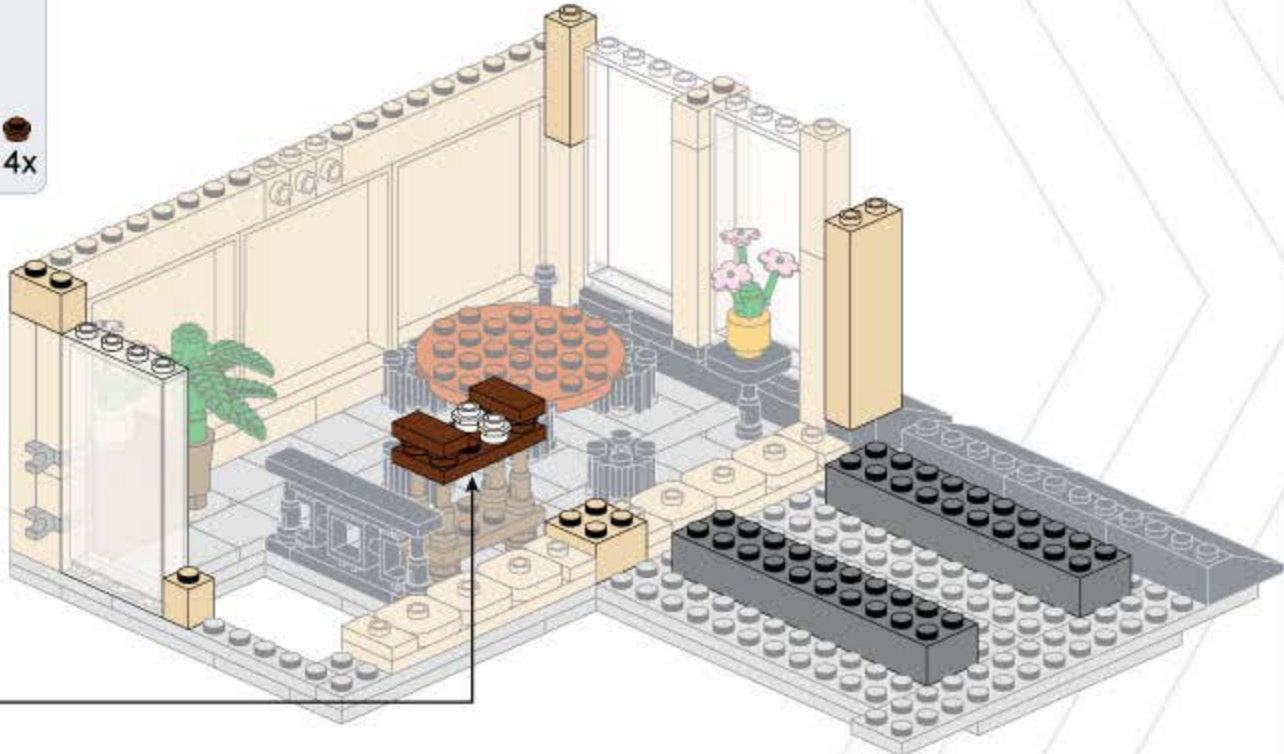
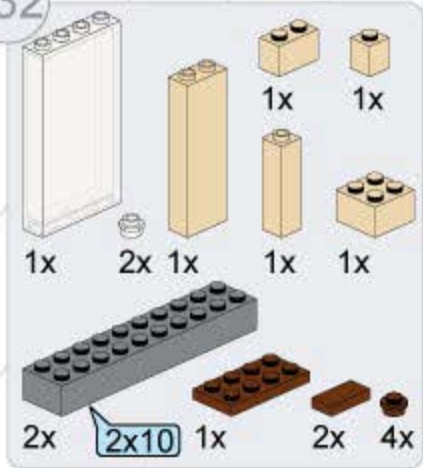

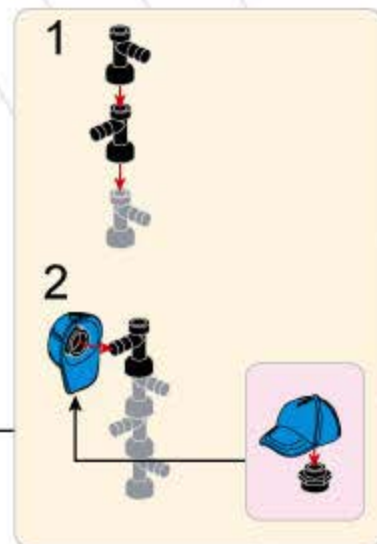
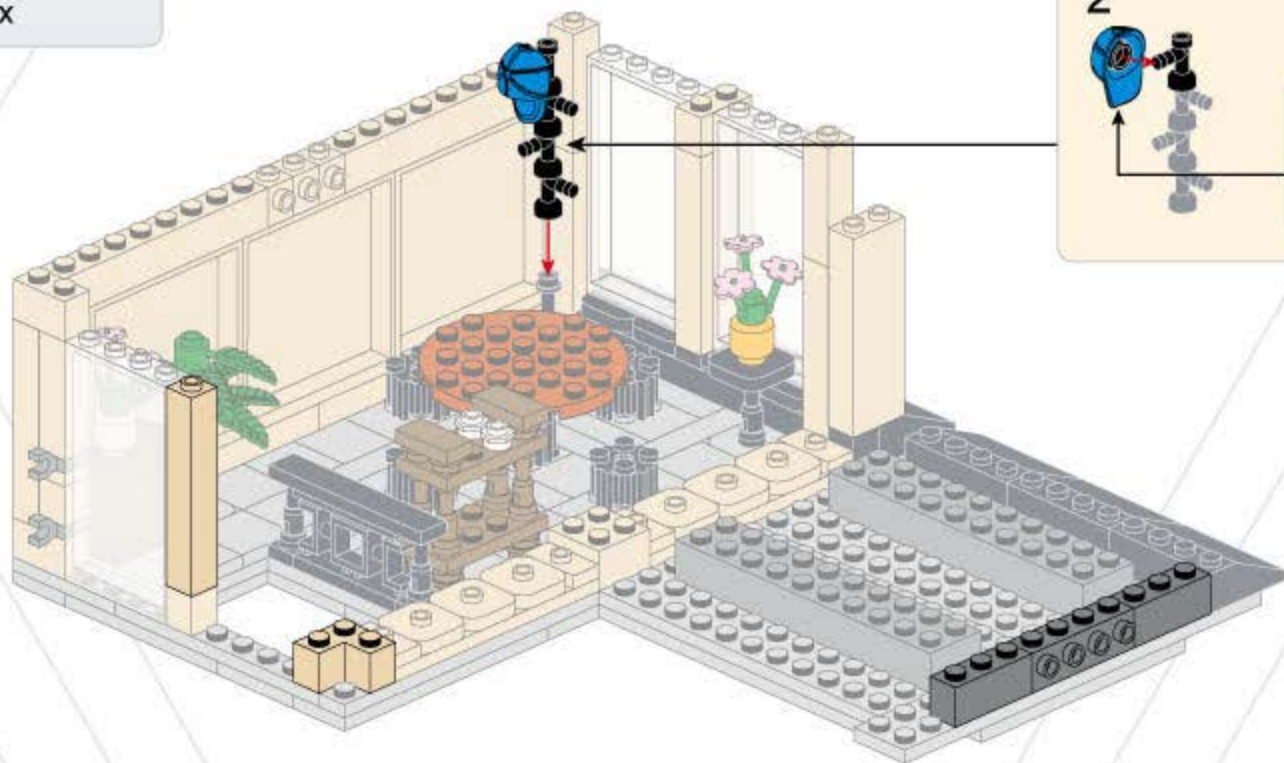
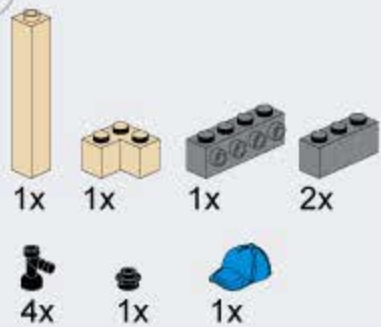

- 1x [White 1x10 Technic Beam]
- 3x [Black 1x3 Technic Slope]
- 1x [Black 4x6 Technic Plate]
- 1x [Black 2x4 Technic Plate]
- 1x [Black 2x4 Technic Plate]
- 1x [Black 2x4 Technic Plate]
- 1x [Yellow 1x1 Technic Bump]
- 2x [Yellow 1x2 Technic Bump]
- 2x [Yellow 1x2 Technic Bump]

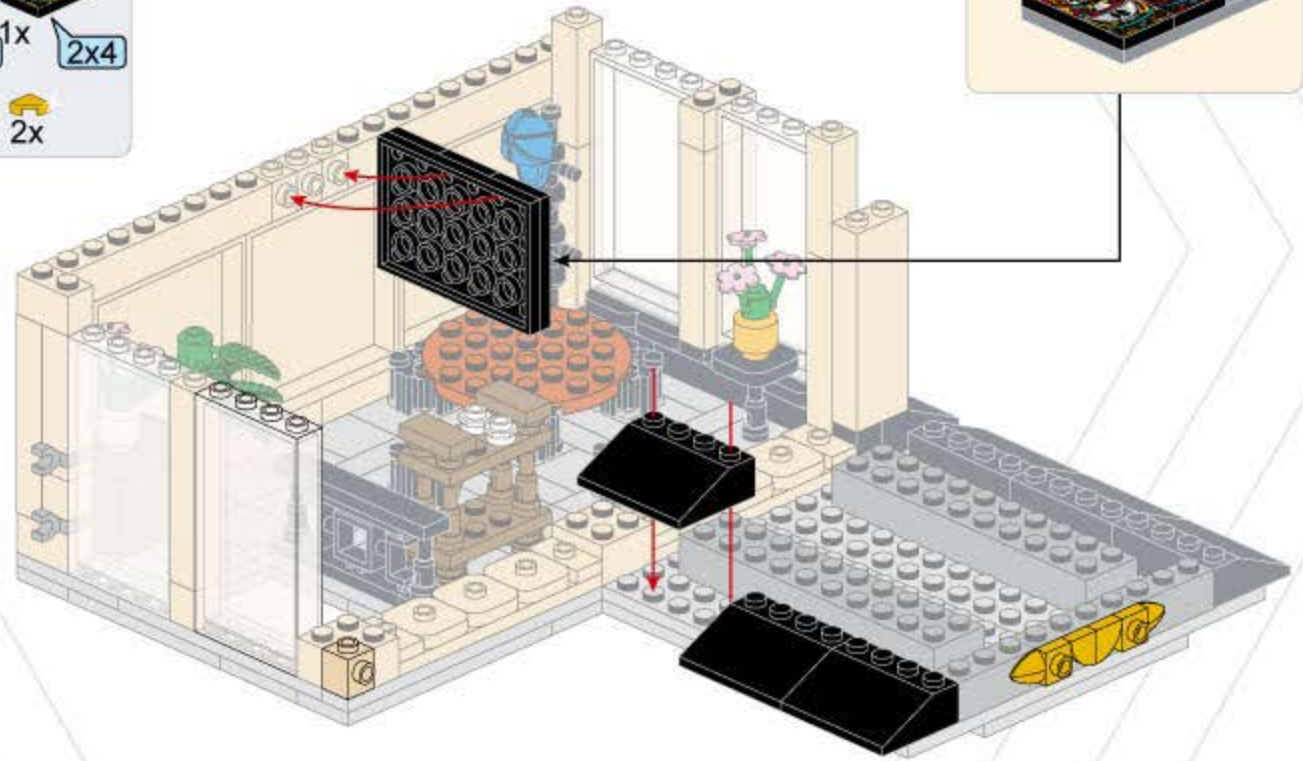
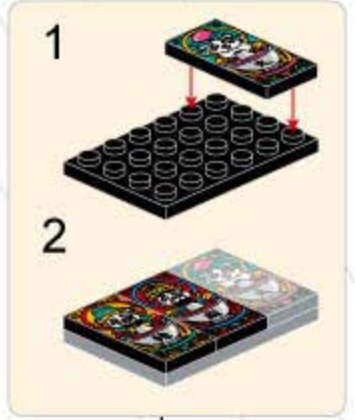



15

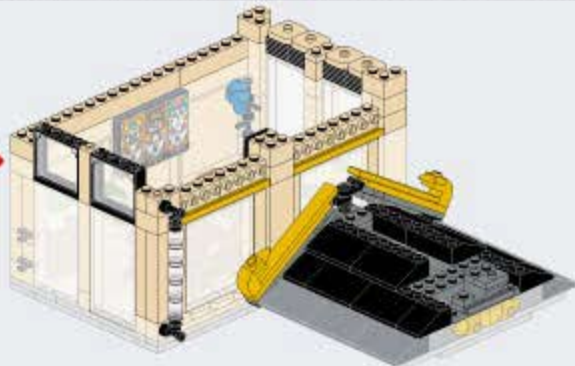

135

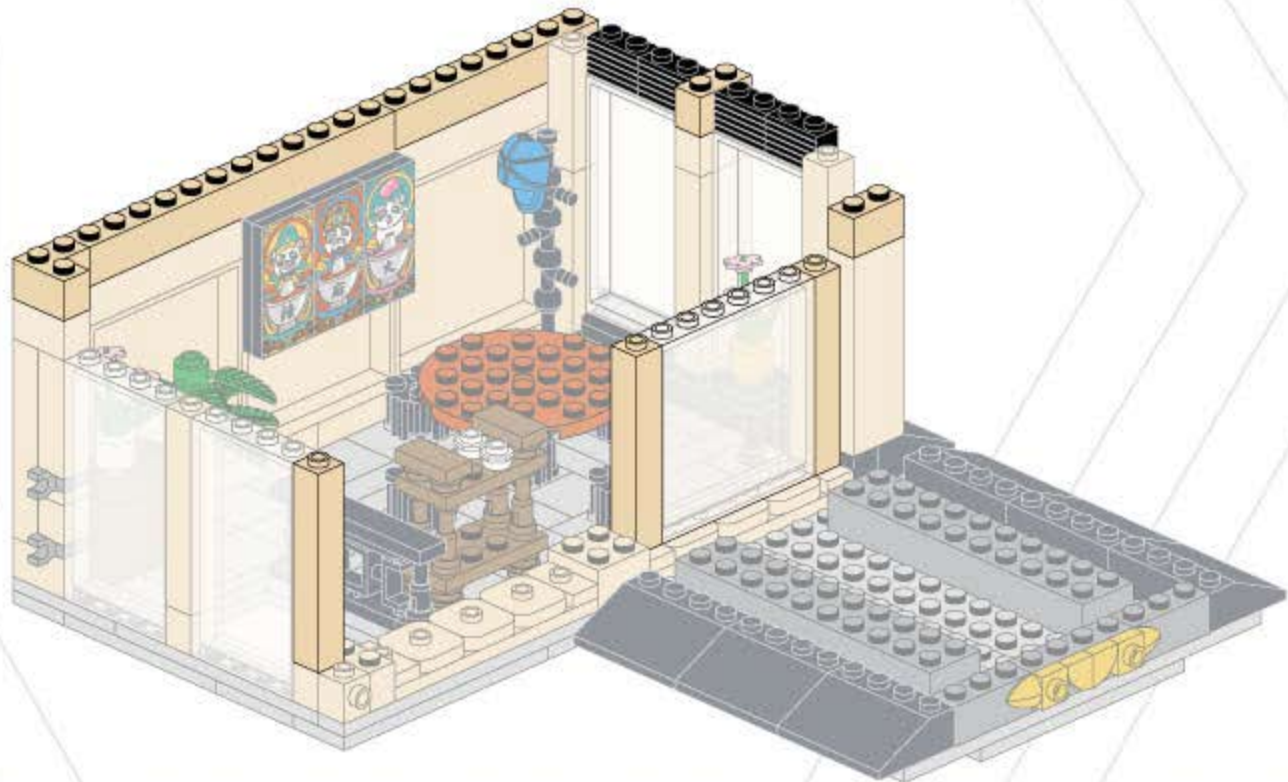
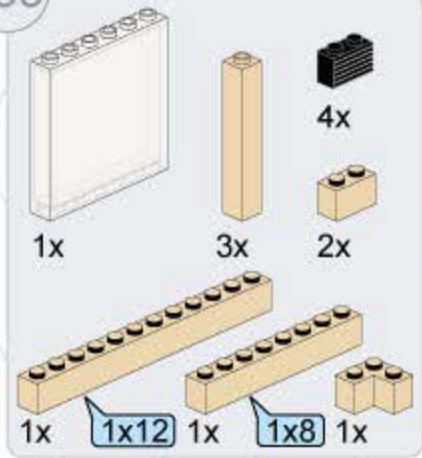

- 2x (Orange 1x4 Technic Brick)
- 1x (Orange 1x2 Technic Brick)
- 1x (Orange 1x8 Technic Beam)
- 2x (Black 2x2 Technic Window Frame)
- 2x (Black 1x2 Technic Sloped Brick)
- 1x (Black 1x2 Technic Sloped Brick)
- 2x (White 2x2 Technic Window Panel)
- 1x (Grey 1x2 Technic Technic Brick)

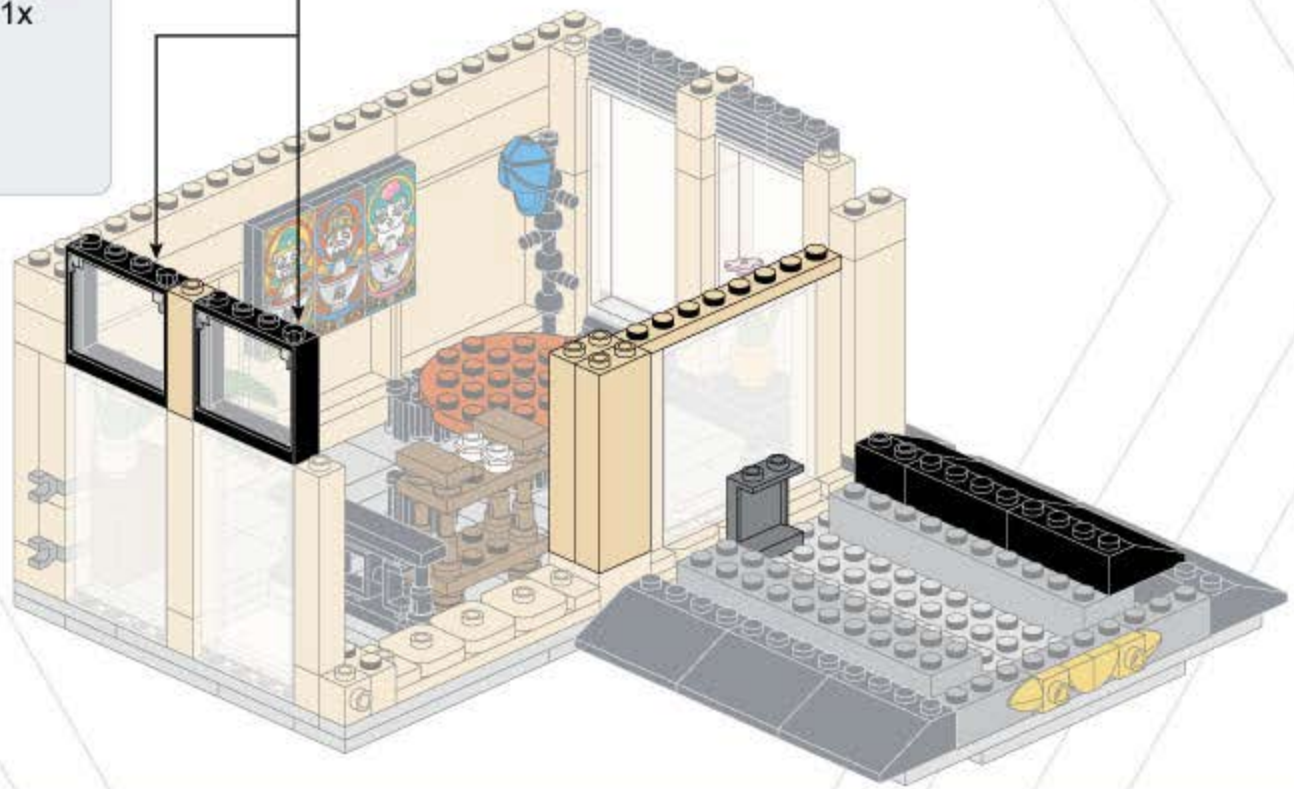
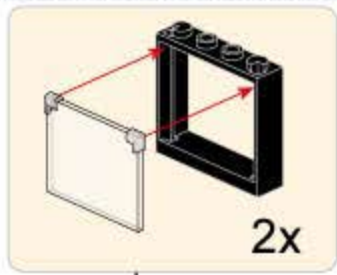

- 1x [1x8 tan Technic brick with holes]
- 2x [1x tan Technic axle]
- 1x [1x tan Technic 2-way connector]
- 1x [1x tan Technic 2-way connector]
- 1x [1x tan Technic 1x8 Technic beam]
- 1x [1x tan Technic 1x2 Technic brick]
- 4x [1x tan Technic Technic pin]
- 1x [1x tan Technic Technic pin]
- 1x [1x yellow Technic 1x8 Technic beam]
- 1x [1x black Technic Technic pin]
- 3x [1x grey Technic 1x3 Technic brick]
- 1x [1x grey Technic 1x4 Technic brick]

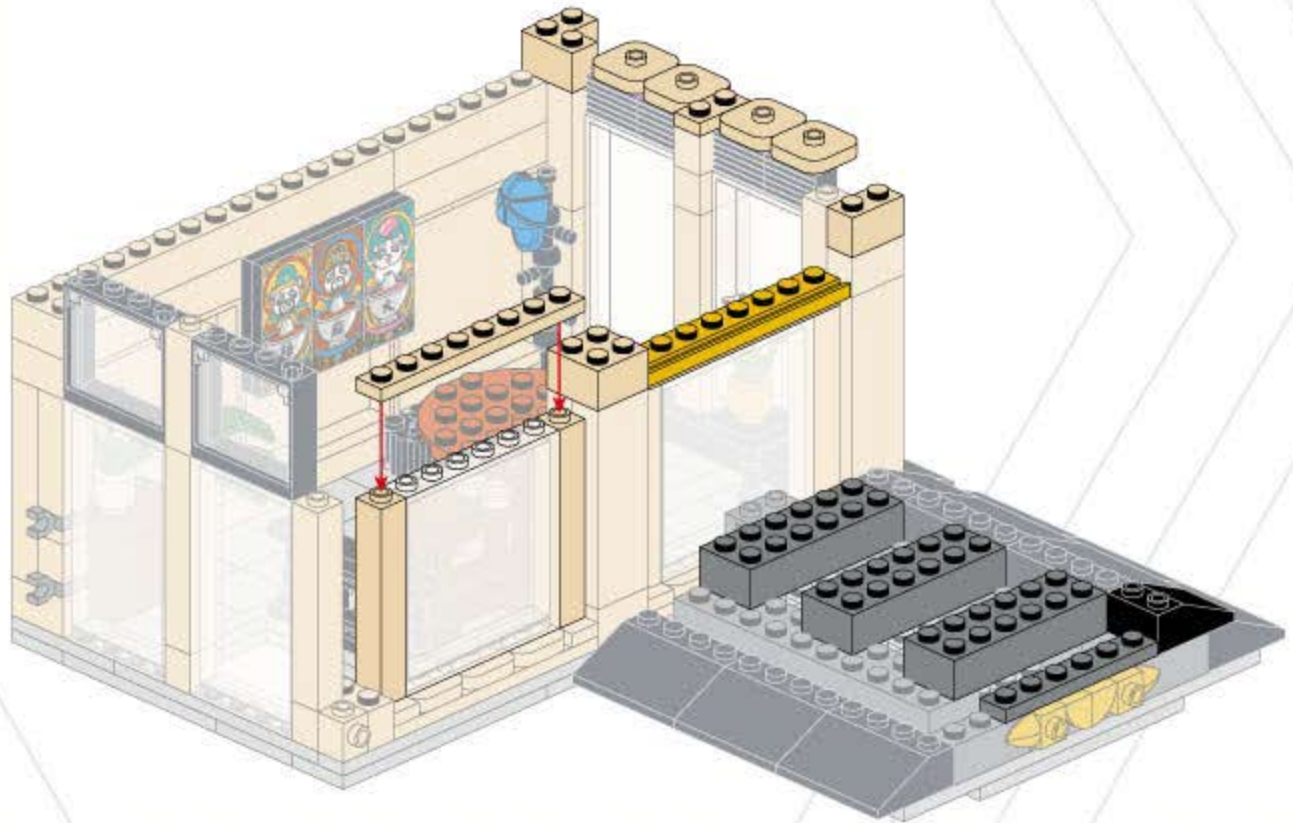



- 1x [1x tan 1x4 Technic brick]
- 2x [2x tan 1x3 Technic brick]
- 1x [1x tan 1x2 Technic brick]
- 1x [1x tan 1x2 Technic brick]
- 1x [1x yellow 1x6 Technic Technic beam]
- 1x [1x black 1x4 Technic Technic beam]
- 2x [2x black 1x2 Technic Technic beam]
- 1x [1x black 1x4 Technic Technic beam]
- 1x [1x tan 1x2 Technic Technic beam]
- 2x4 [2x4 tan 1x2 Technic Technic beam]

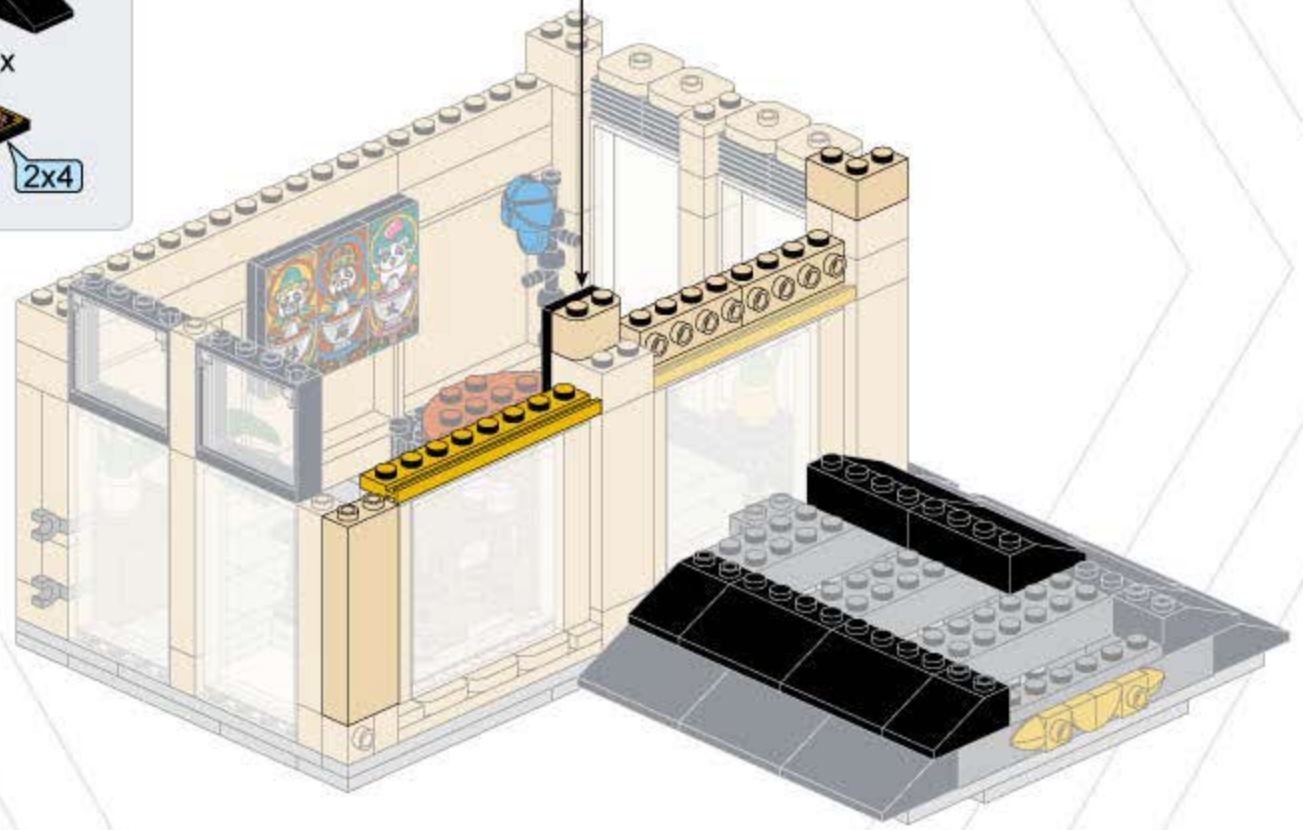

- 2x
- 1x
- 1x
- 2x
- 1x
- 1x
- 2x

- 
- 
- 

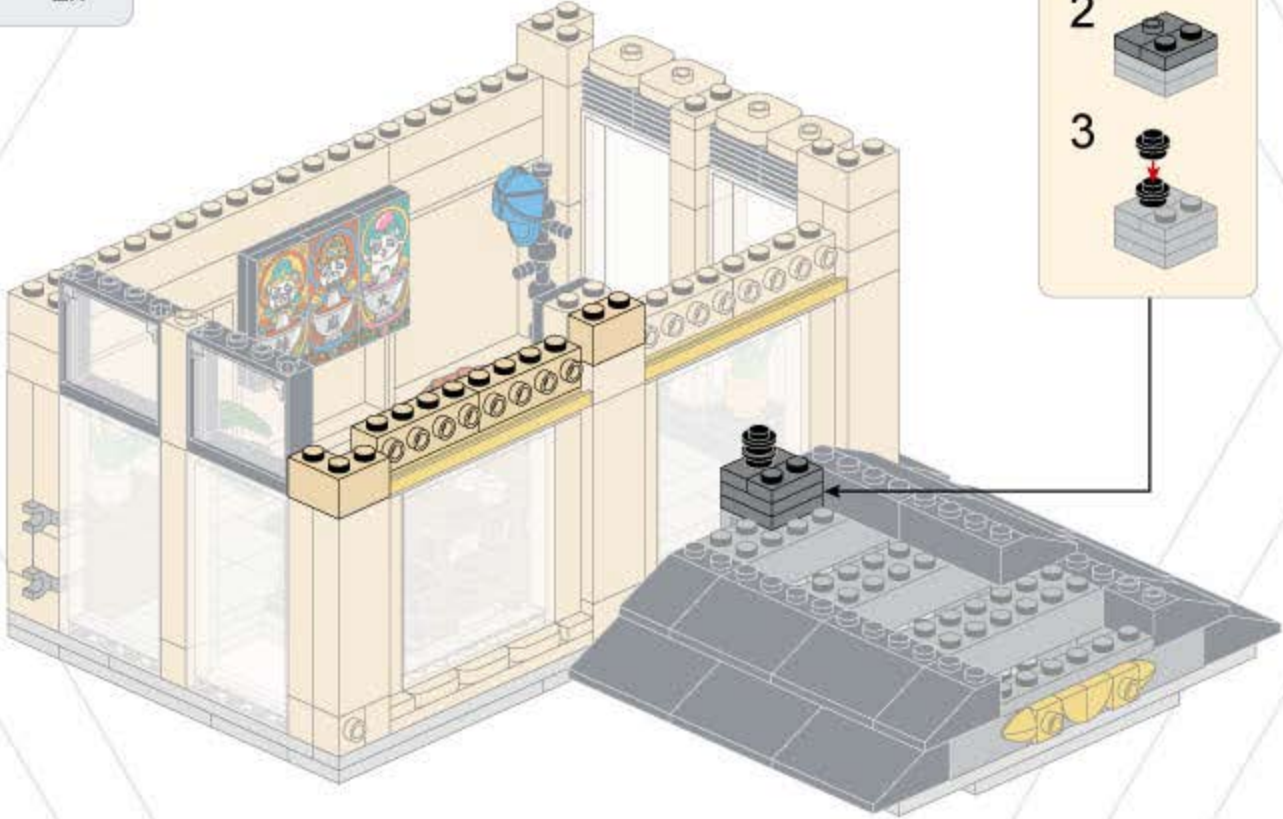

140

- |    |    |    |    |  |
|----|----|----|----|--|
|    |    |    |    |  |
| 2x | 2x | 4x | 5x |  |
|    |    |    |    |  |
| 1x | 1x | 1x | 1x |  |
|    |    |    |    |  |
| 1x | 2x | 2x |    |  |

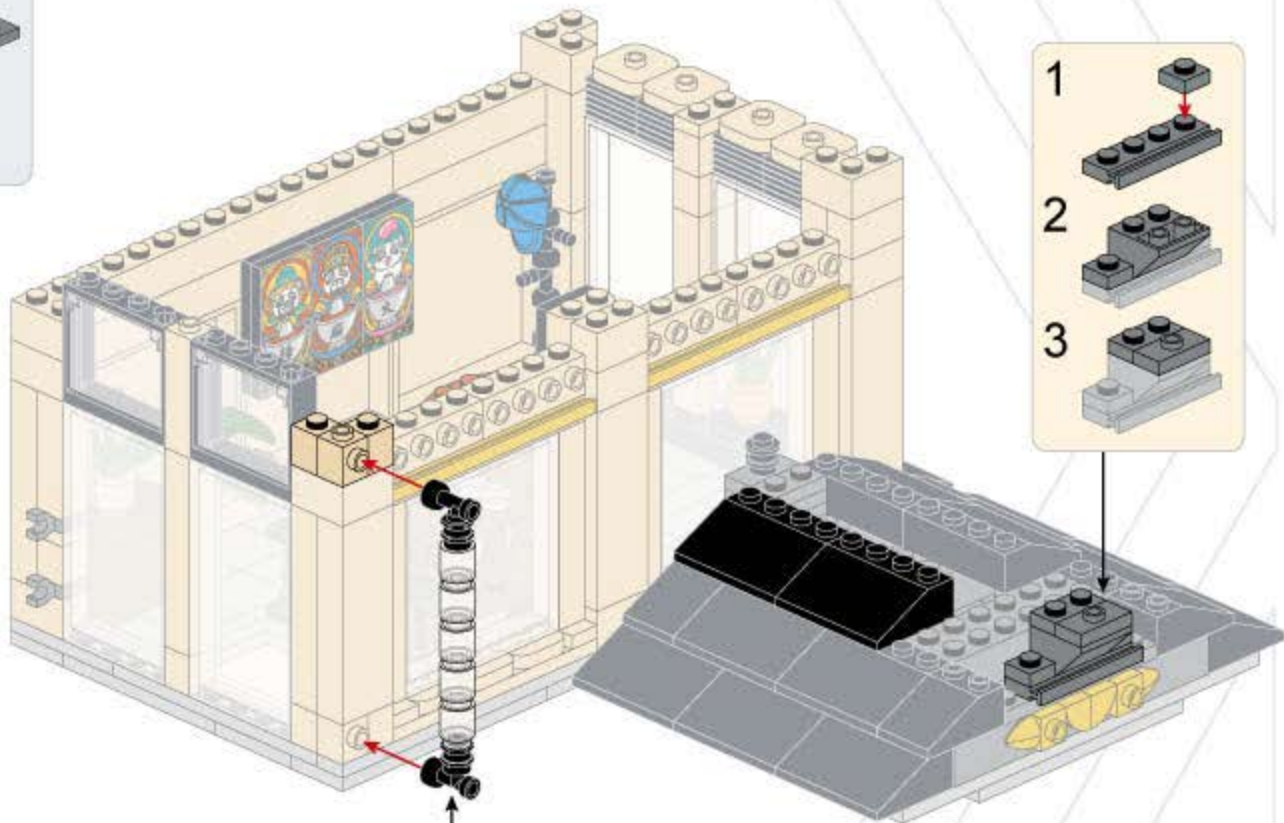

- 1
- 2
- 3

- 1
- 2
- 3
- 4
- 5

- 1x 1x8 (yellow)
- 1x 1x8 (yellow)
- 1x 1x2 (yellow)
- 1x 1x2 (yellow)
- 1x 1x8 (grey)
- 1x 1x8 (grey)
- 1x 1x3 (grey)
- 1x 1x2 (black)
- 1x 1x2 (black)
- 1x 1x2 (black)

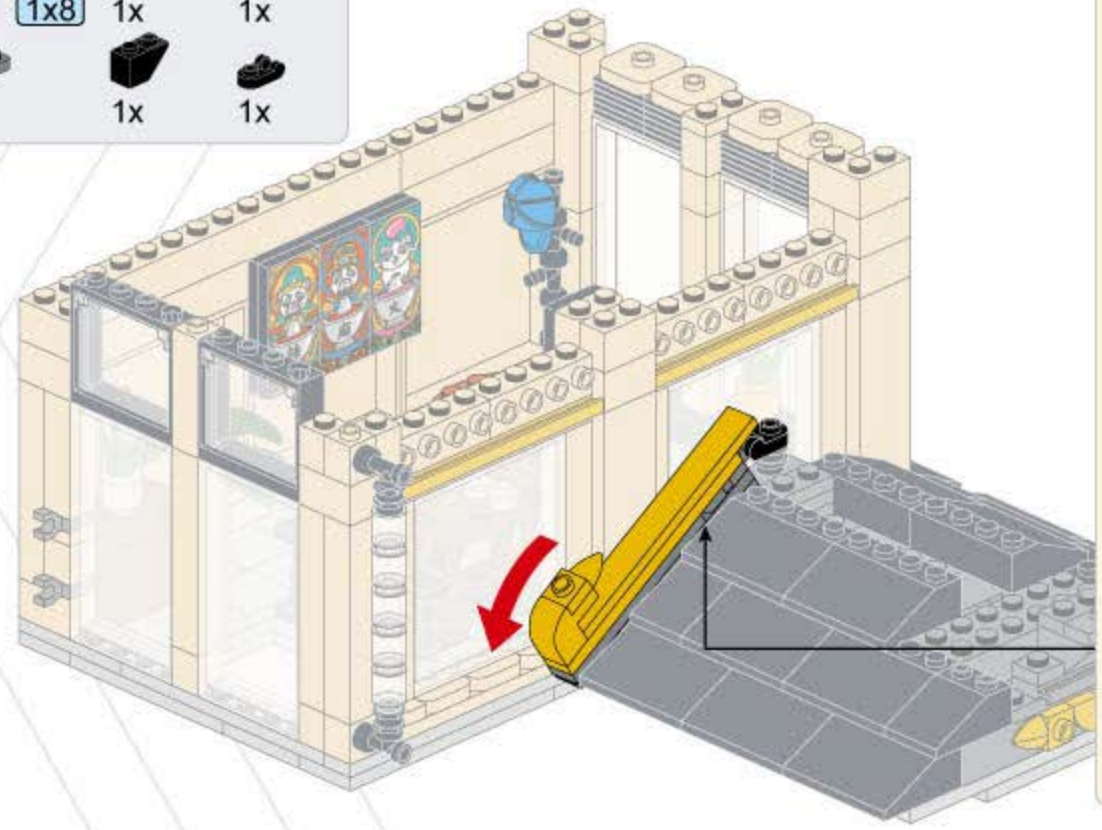

1. Two grey 1x8 Technic beams are shown. Red arrows indicate that a grey Technic pin should be inserted into the 4th hole of the top beam and the 5th hole of the bottom beam.
2. A second grey 1x8 Technic beam is added to the top of the first beam. Red arrows indicate that a grey Technic pin should be inserted into the 4th hole of the top beam and the 5th hole of the second beam.
3. A grey 1x3 Technic beam is added to the right end of the second beam. Red arrows indicate that a grey Technic pin should be inserted into the 3rd hole of the second beam and the 1st hole of the 1x3 beam.
4. A yellow 1x8 Technic beam is added to the top of the second beam. A yellow Technic pin is shown being inserted into the 4th hole of the second beam and the 1st hole of the yellow beam. A callout box shows a yellow Technic pin being inserted into a yellow Technic hole.
5. A black 1x2 Technic brick and a black 1x2 Technic brick with a hole are added to the bottom of the assembly. Red arrows indicate that the black Technic pins from step 1 should be inserted into the holes of these bricks.

142

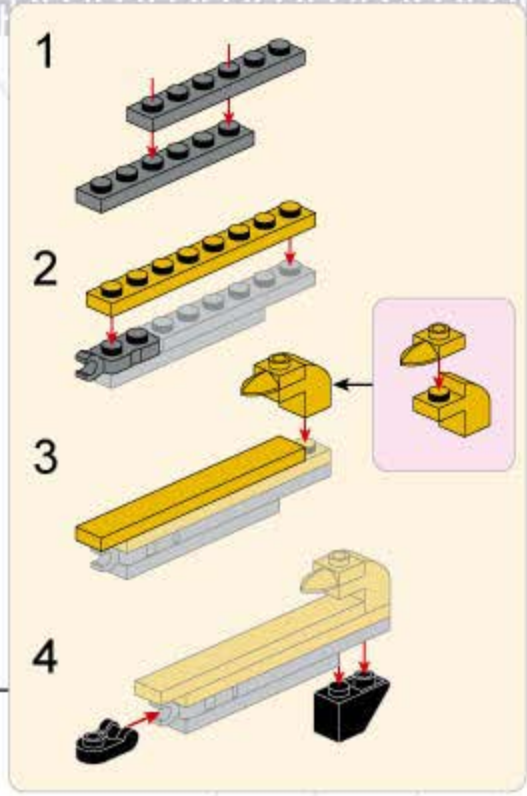
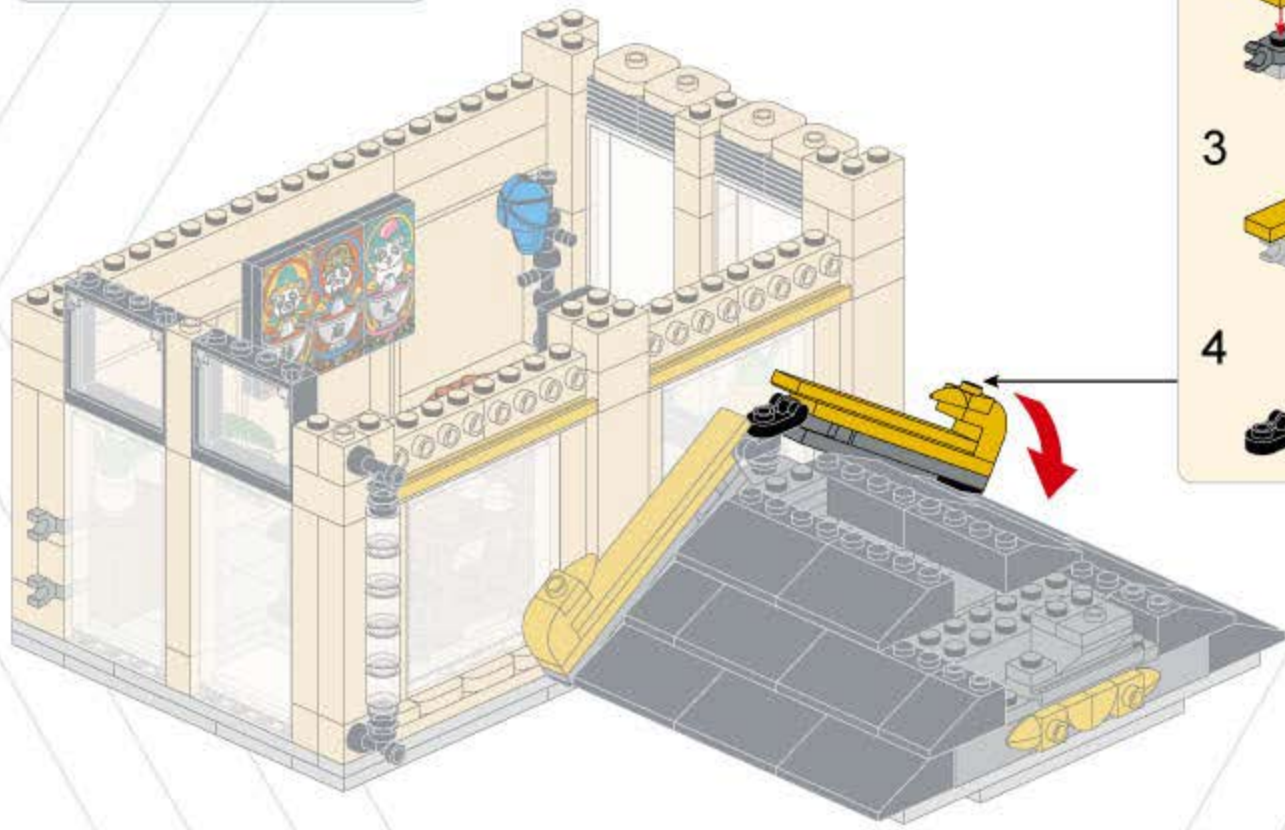
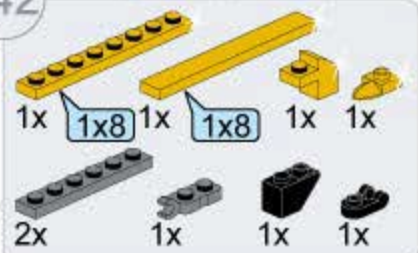



16

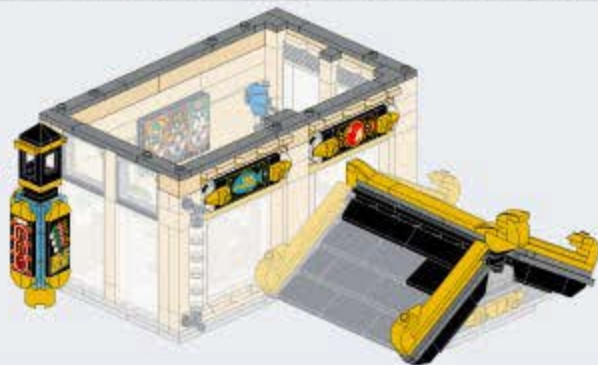

143

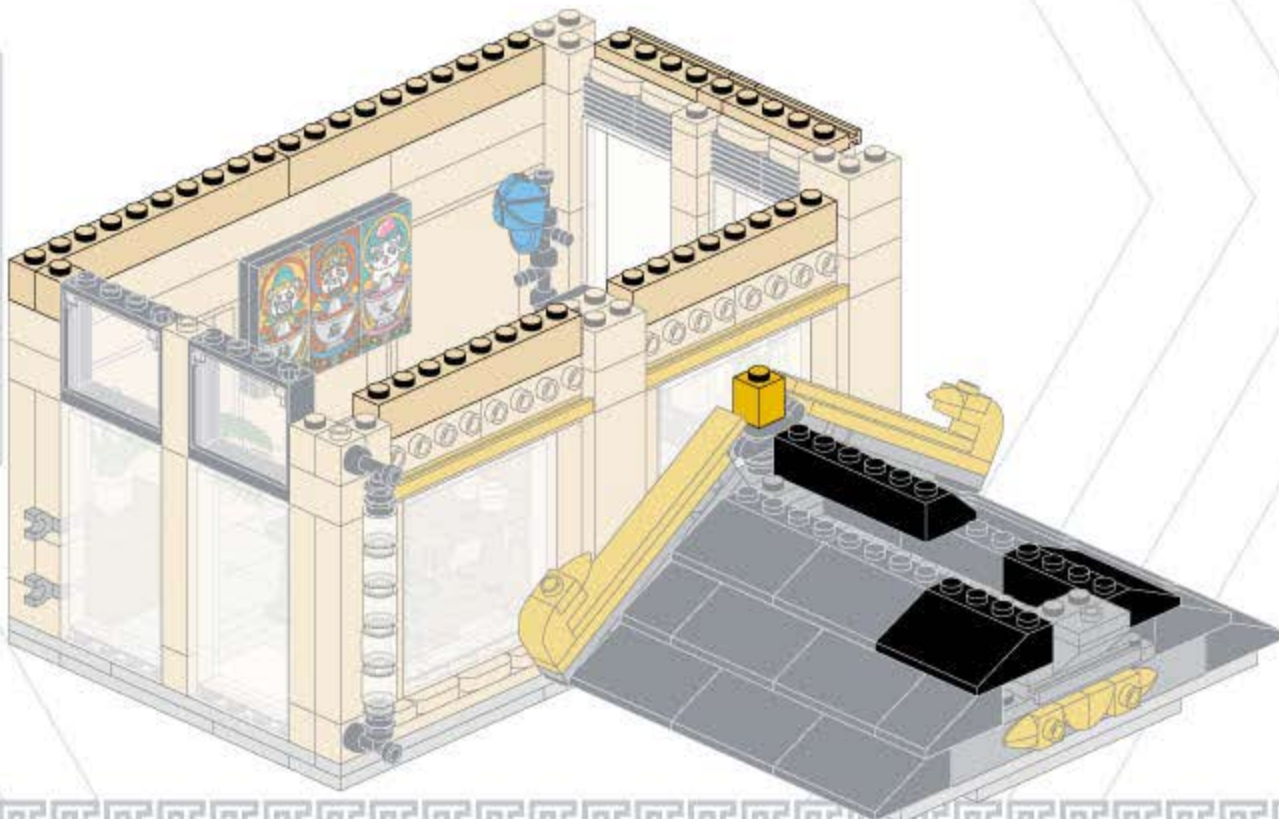
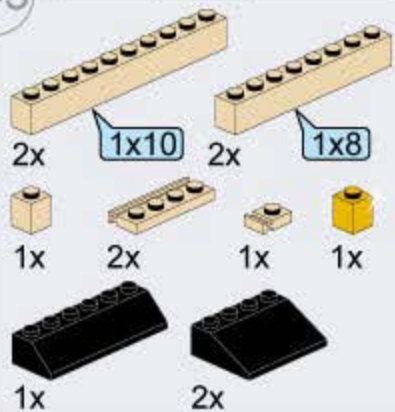

117

144

- 3x [Black 1x6 Technic Beam]
- 1x [Black 1x4 Technic Beam with Red Circle]
- 2x [Black 1x2 Technic Beam]
- 1x [Tan 1x8 Technic Beam]
- 1x [Tan 1x4 Technic Beam]
- 2x [Yellow 1x2 Technic Beam]
- 4x [Tan 1x2 Technic Beam]

- 1 [Assembly Step 1: A white Technic pin is inserted into the 4th hole of a tan 1x8 Technic beam.
- 2 [Assembly Step 2: A black 1x4 Technic beam with a red circle is placed on top of the tan 1x8 beam, with the white pin from step 1 passing through its 4th hole.
- 3 [Assembly Step 3: Two yellow 1x2 Technic beams are placed on top of the black 1x4 beam, with their 1st holes aligned with the 1st hole of the black beam.

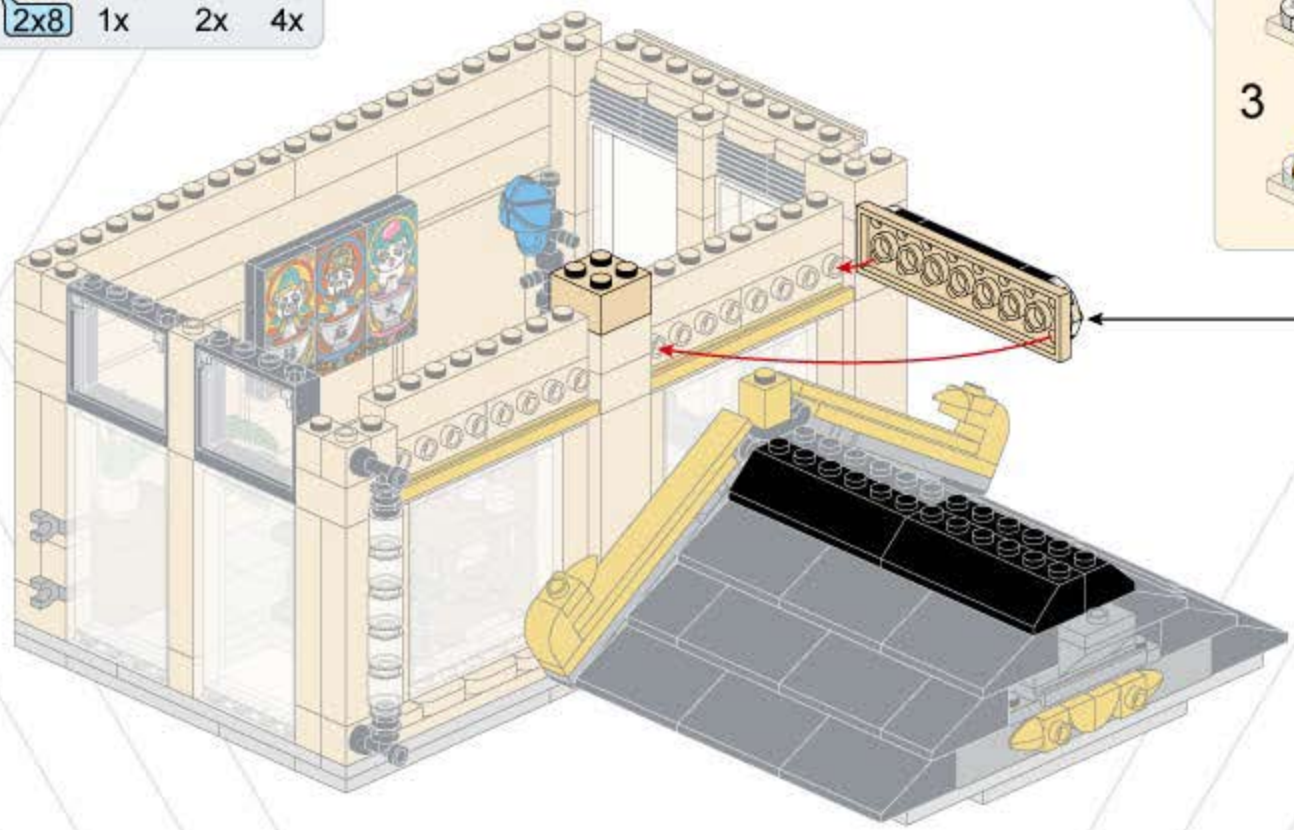

- 1x 2x8
- 1x 2x4
- 2x
- 1x 1x6
- 1x
- 1x 1x3
- 2x
- 4x

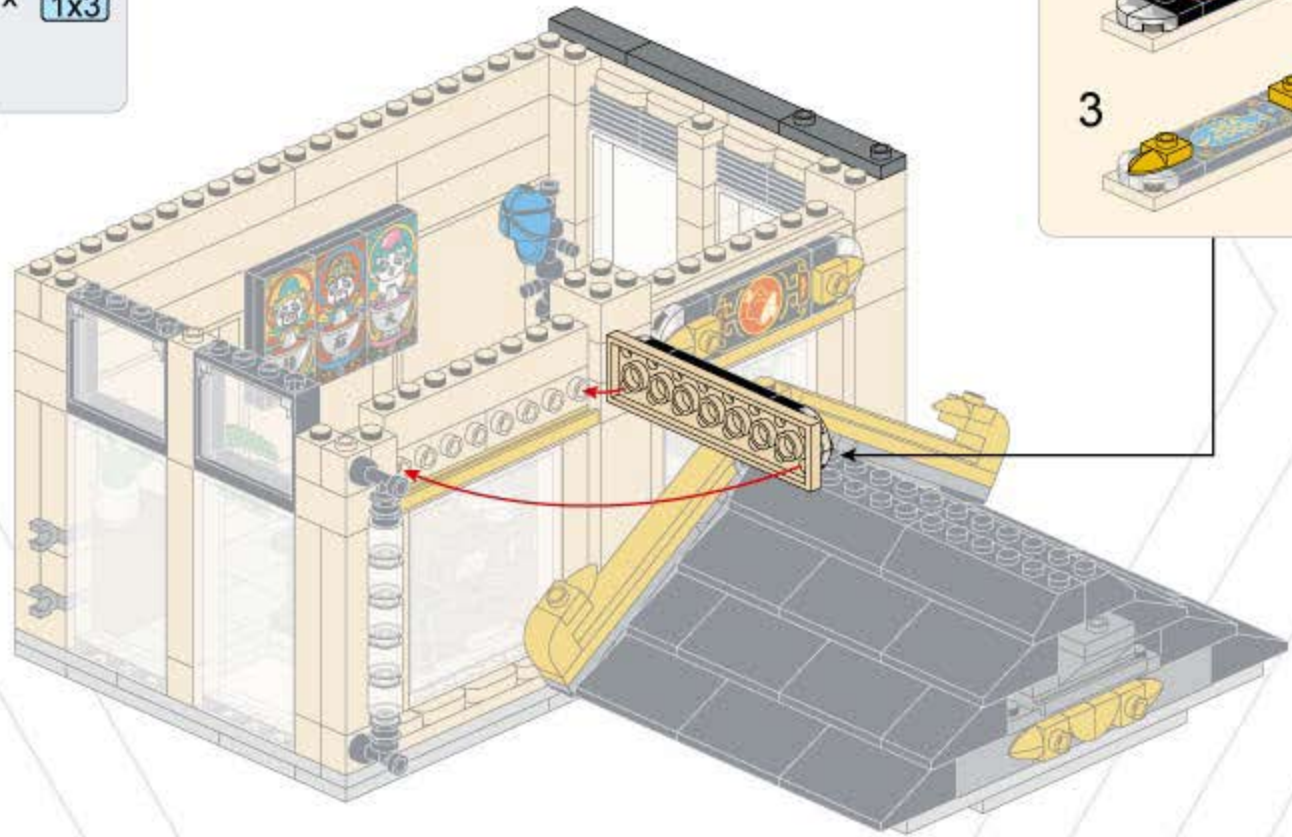
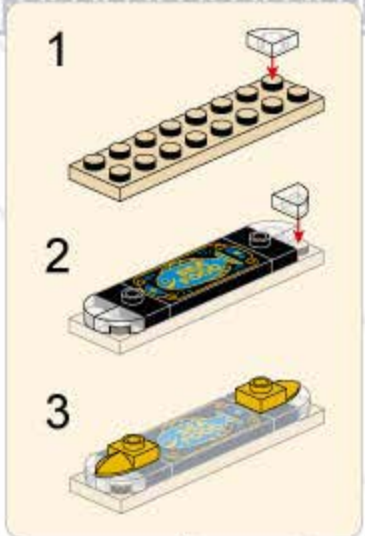



- 2x Yellow Technic Beam 1x5
- 1x Tan Technic Connector 3-Way
- 6x Black Technic Pin
- 1x Grey Technic Beam 1x8
- 1x Grey Technic Beam 1x6
- 1x Grey Technic Beam 1x3
- 2x Grey Technic Beam 1x2
- 1x Grey Technic Beam 1x1
- 1x Grey Technic Beam 1x1
- 1x Grey Technic Beam 1x1
- 1x Grey Technic Beam 1x1

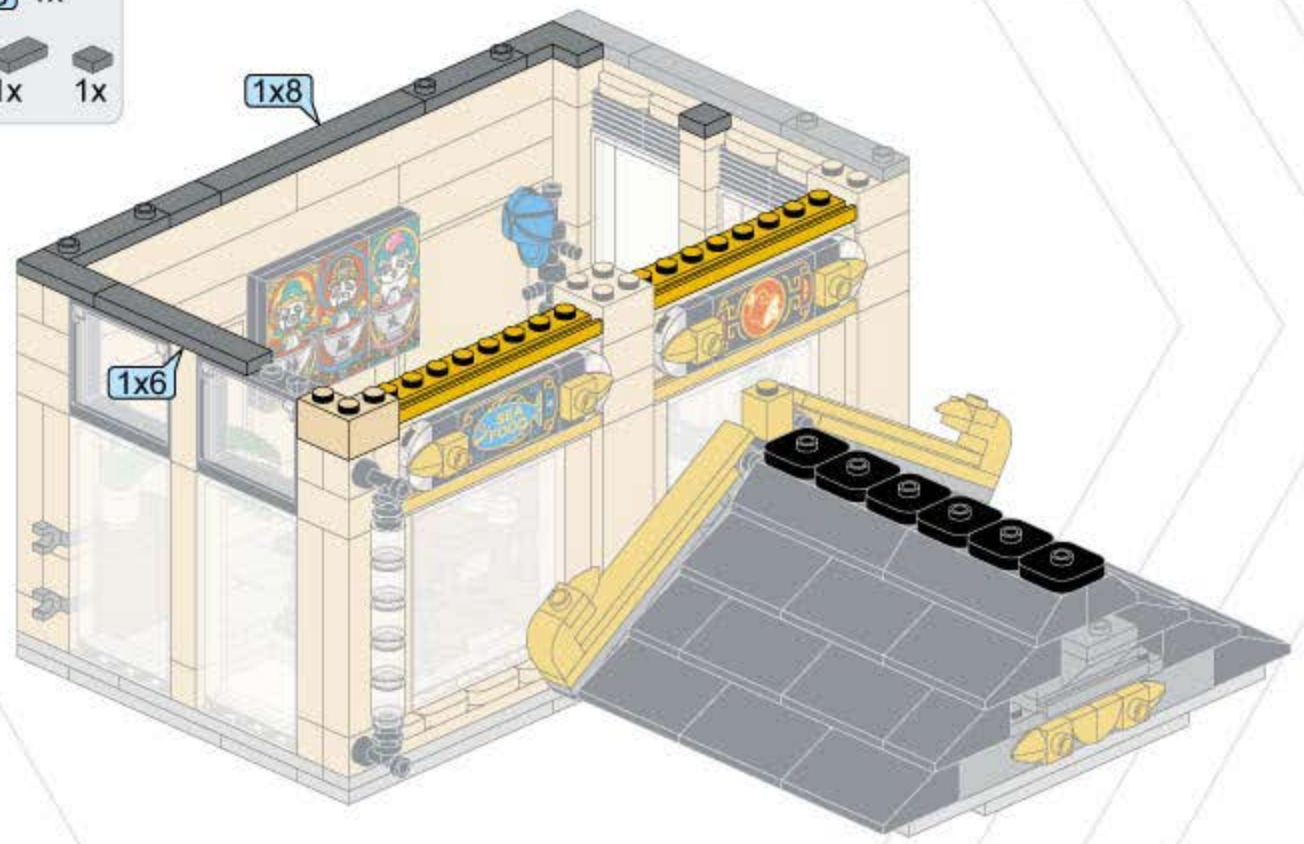

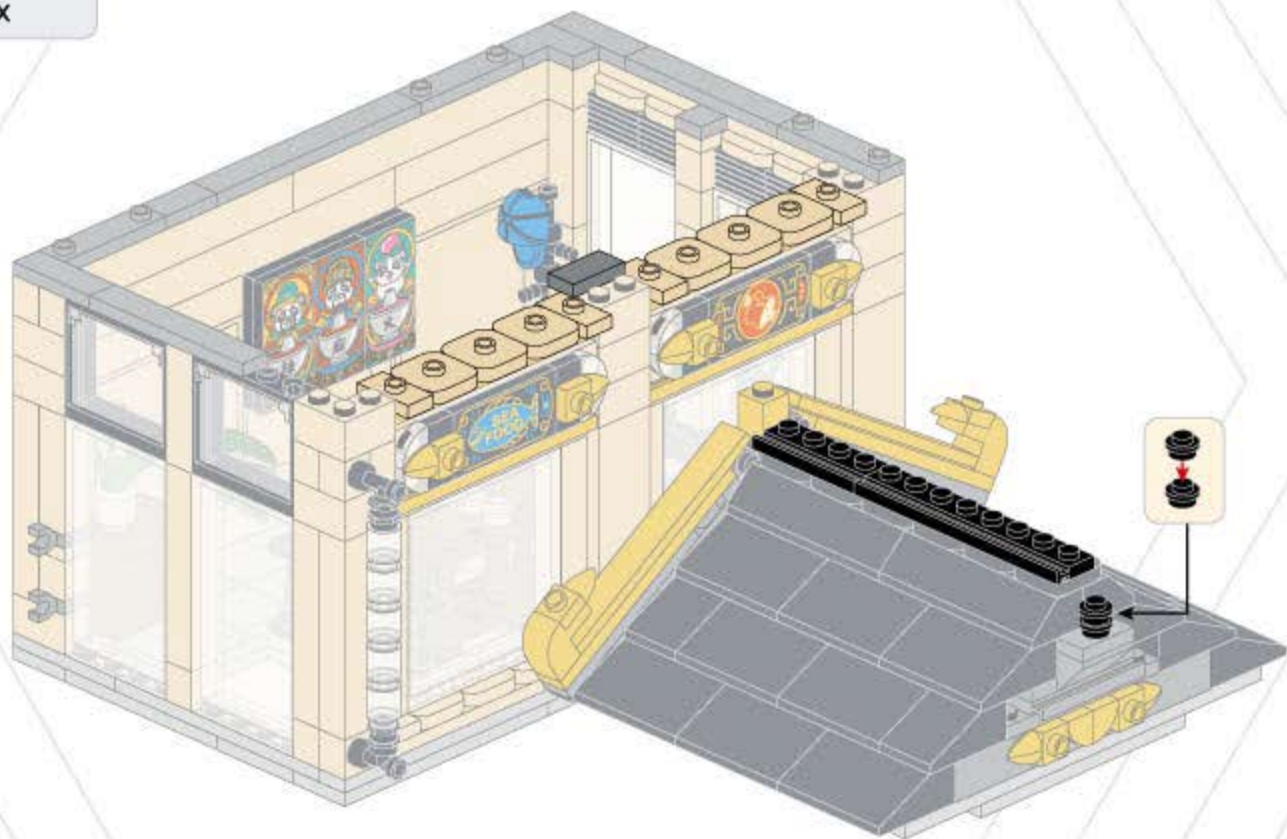
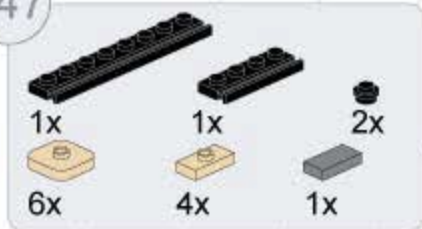

148

- 1x [Black 1x4 Technic Brick]
- 2x [Black 1x2 Technic Brick]
- 1x [Black 1x6 Technic Brick]
- 1x [Black 1x2 Technic Brick with Pin Hole]
- 2x [Grey 1x6 Technic Brick]
- 1x [Grey 1x4 Technic Brick]
- 1x [Grey 1x2 Technic Brick]
- 1x [Grey 1x2 Technic Brick with Pin Hole]
- 1x [Yellow 1x8 Technic Brick]
- 1x [Yellow 1x4 Technic Brick]
- 1x [Yellow 1x2 Technic Brick]
- 1x [Yellow 1x2 Technic Brick]

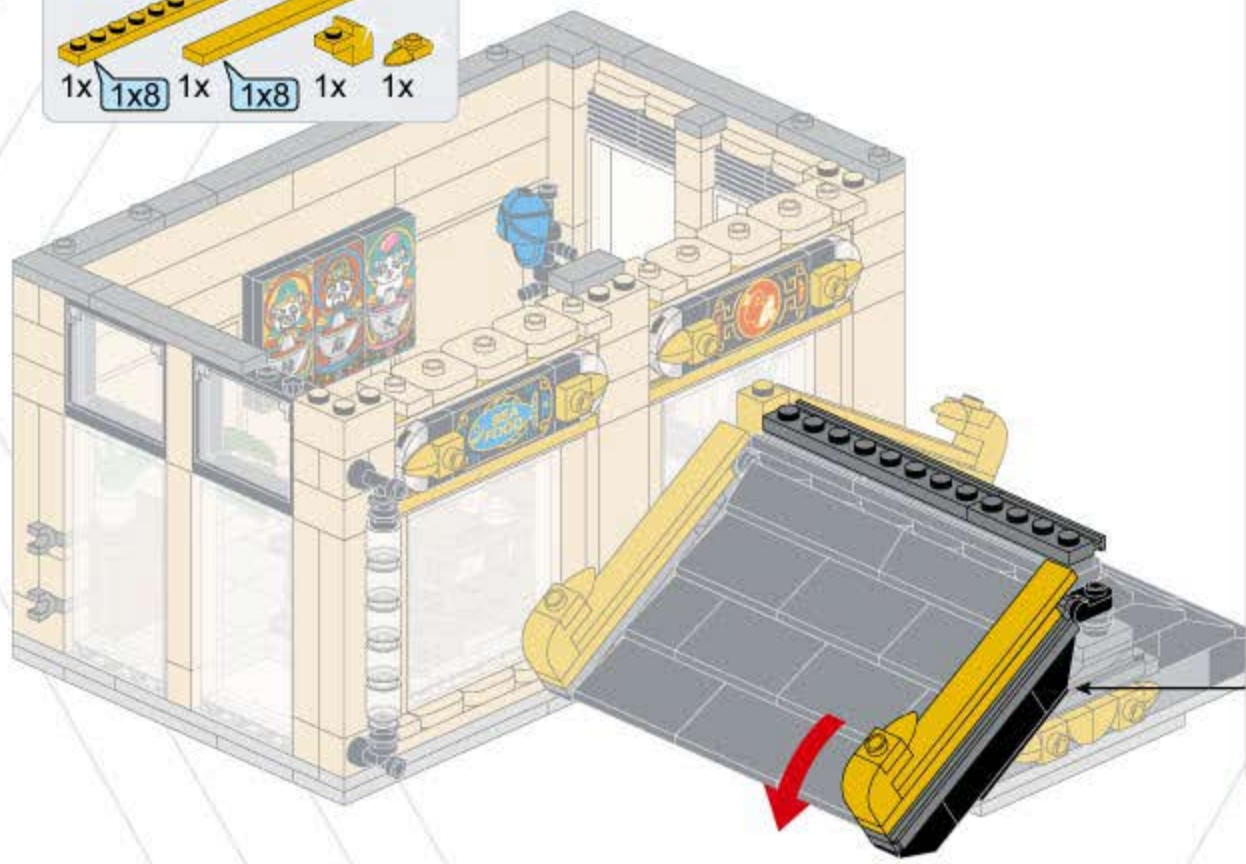

1. [Black 1x4 Technic Brick] is placed on top of [Black 1x2 Technic Brick with Pin Hole].
2. [Grey 1x6 Technic Brick] is placed on top of the assembly from step 1. A [Black 1x2 Technic Brick with Pin Hole] is attached to the end of the grey brick.
3. [Yellow 1x8 Technic Brick] is placed on top of the assembly from step 2. A [Yellow 1x2 Technic Brick] is attached to the end of the yellow brick.
4. [Yellow 1x2 Technic Brick] is placed on top of the assembly from step 3. A [Grey 1x2 Technic Brick with Pin Hole] is attached to the end of the yellow brick.

- 1x [Black 1x5 Technic Brick]
- 2x [Black 1x2 Technic Brick]
- 1x [Black 1x3 Technic Brick]
- 1x [Black 1x2 Technic Brick]
- 1x [Black 1x6 Technic Brick]
- 1x [Black 1x4 Technic Brick]
- 1x [Black 1x2 Technic Brick]
- 1x [Yellow 1x6 Technic Brick]
- 1x [Yellow 1x3 Technic Brick]
- 1x [Yellow 1x2 Technic Brick]
- 1x [Yellow 1x2 Technic Brick]
- 1x [Yellow 1x8 Technic Brick]
- 1x [Yellow 1x8 Technic Brick]
- 1x [Yellow 1x2 Technic Brick]
- 1x [Yellow 1x2 Technic Brick]

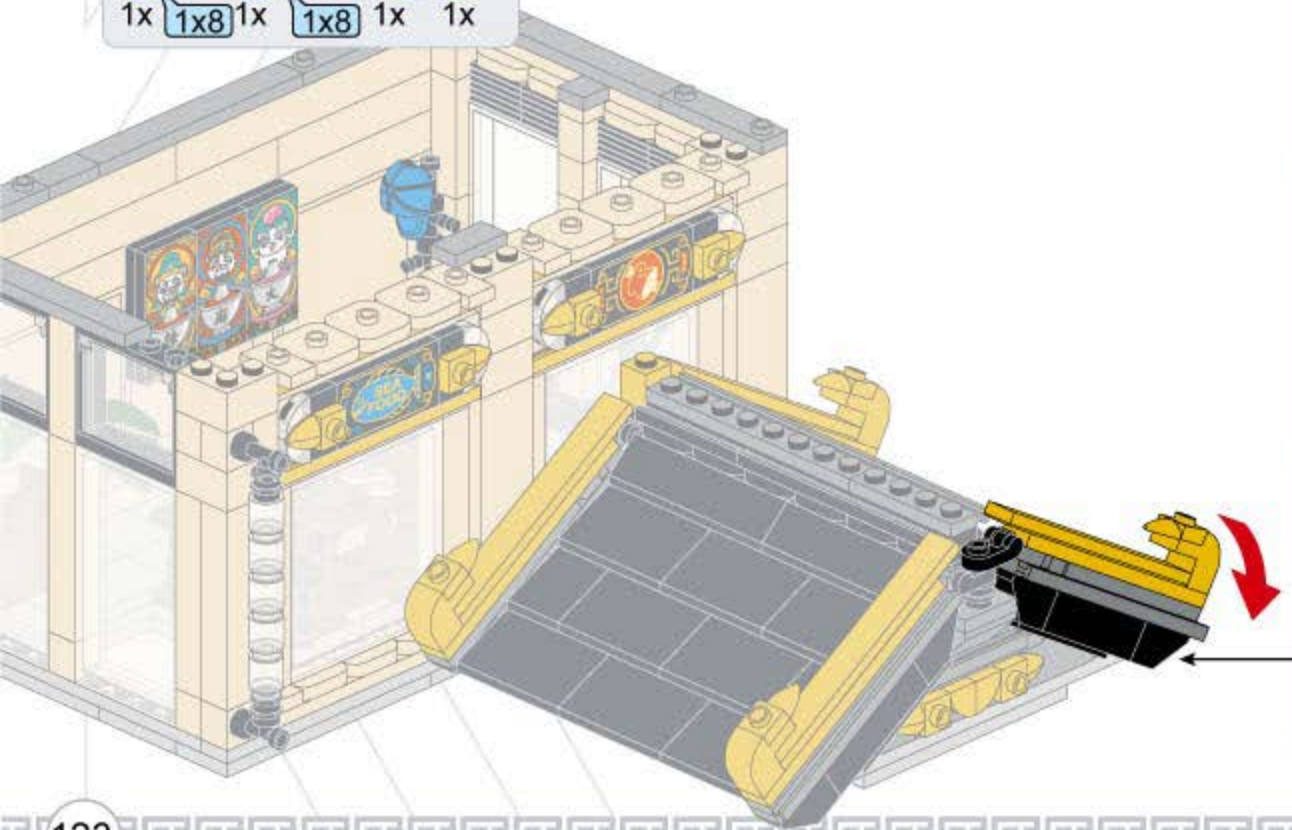

- 
- 
- 
-

150

- 1x 1x8 (grey)
- 1x 1x6 (grey)
- 2x 1x2 (grey)
- 1x 1x8 (yellow)
- 1x 1x2 (yellow)
- 1x L-shaped (grey)
- 1x 1x2 (yellow)
- 1x 1x2 (yellow)
- 3x 1x2 (yellow)
- 1x 1x2 (yellow)

- 1
- 2
- 3

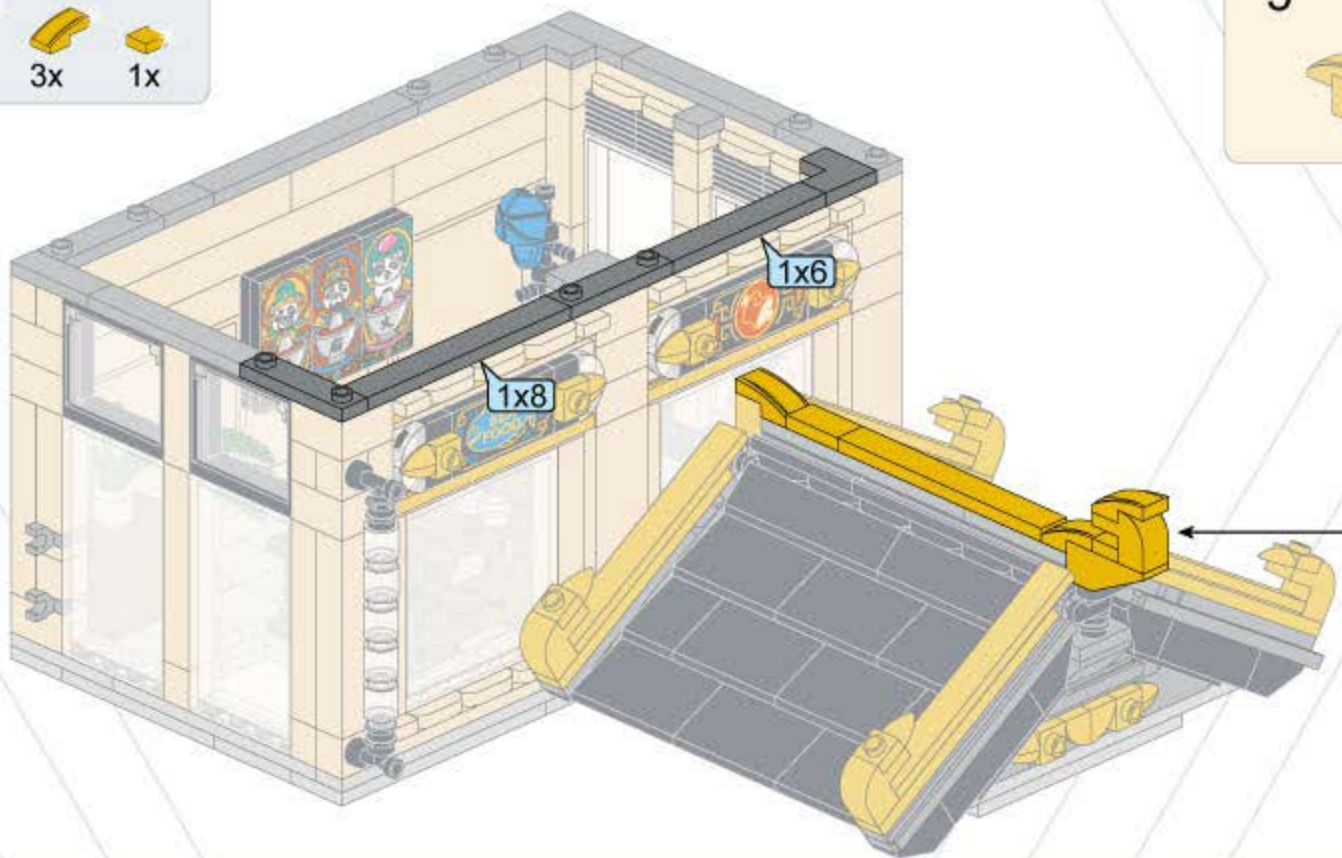

- 2x
- 1x
- 6x
- 2x
- 1x
- 1x
- 1x
- 1x
- 2x
- 1x
- 1x
- 2x
- 2x
- 9x
- 2x
- 6x
- 2x
- 2x
- 2x
- 1x
- 1x
- 2x
- 2x
- 12x

- 
- 
- 
- 
- 
- 

- 
- 
- 
- 

1

2

1

2

- 
- 
- 

1

2

1

2

3

4

14

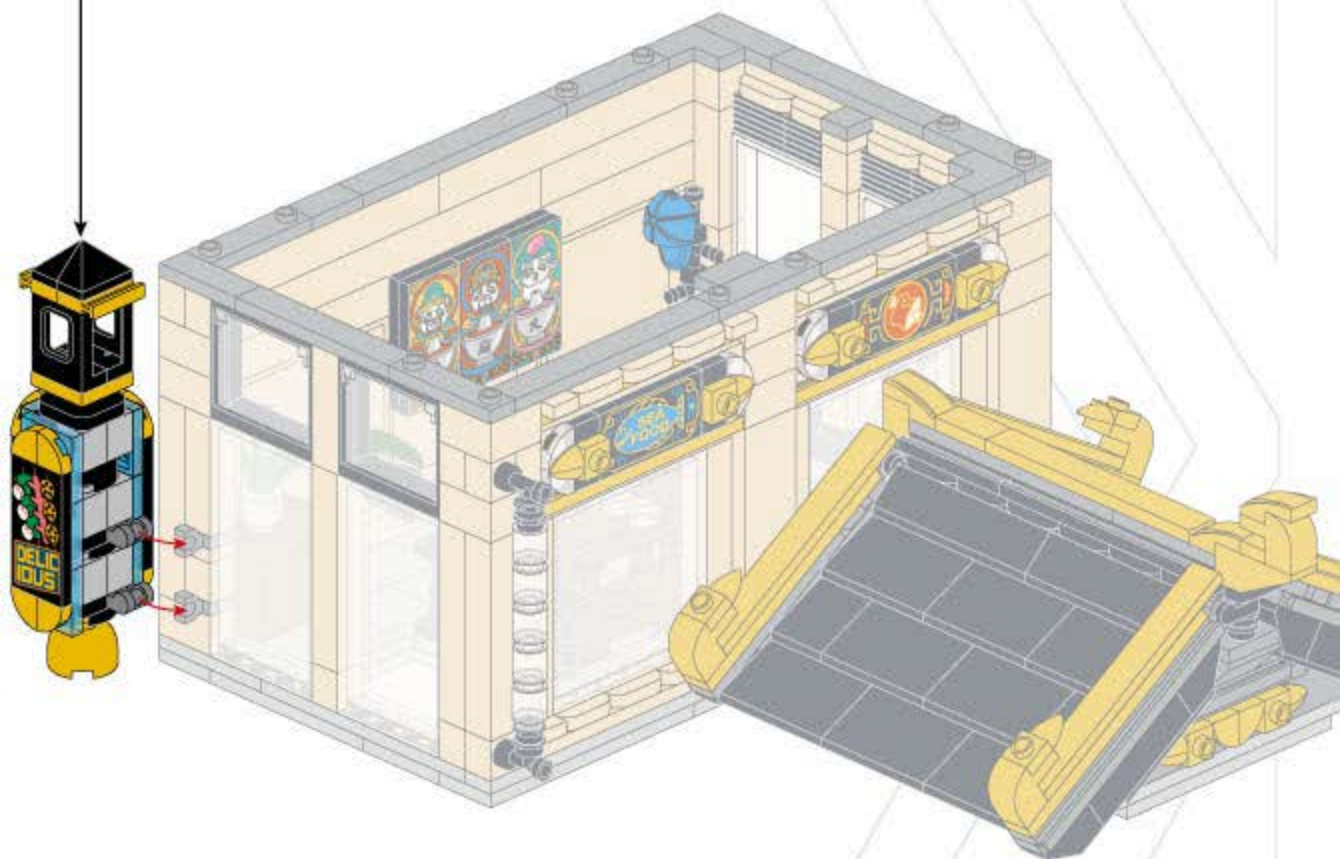
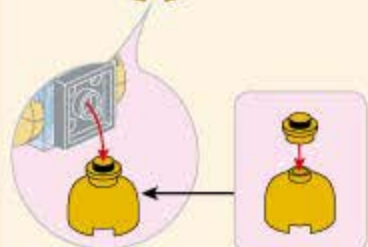

151

115





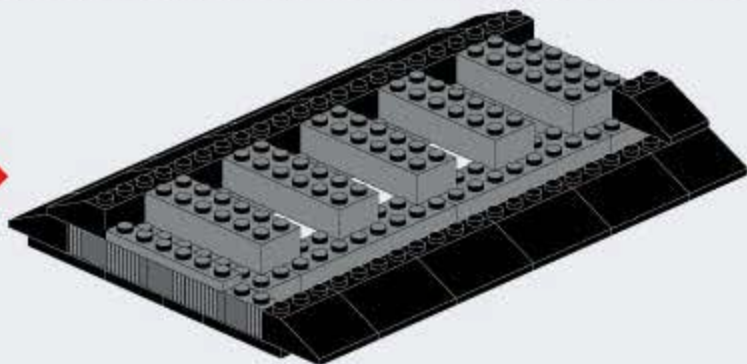

153

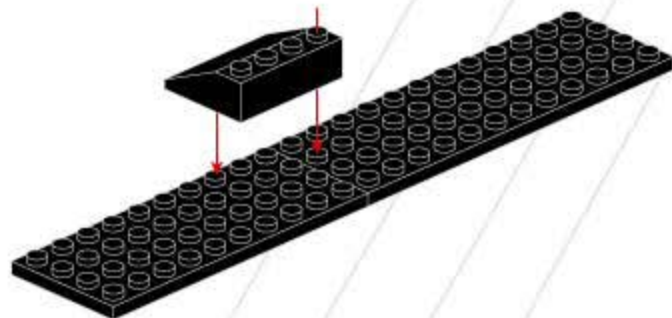

154

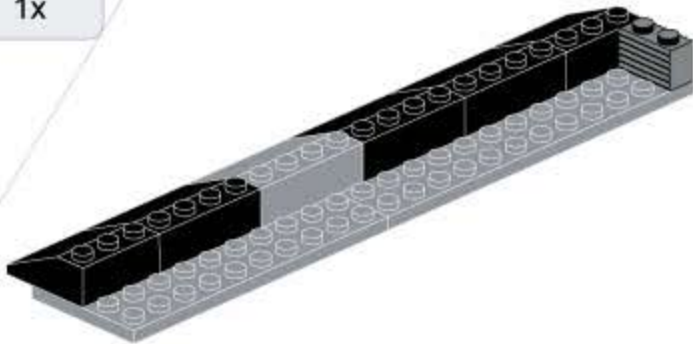

155

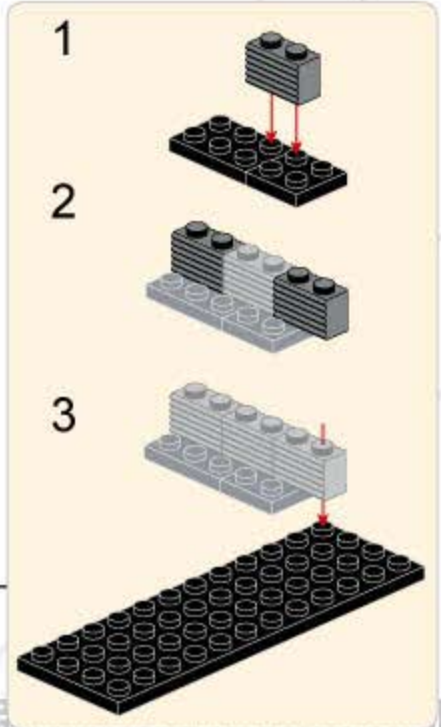
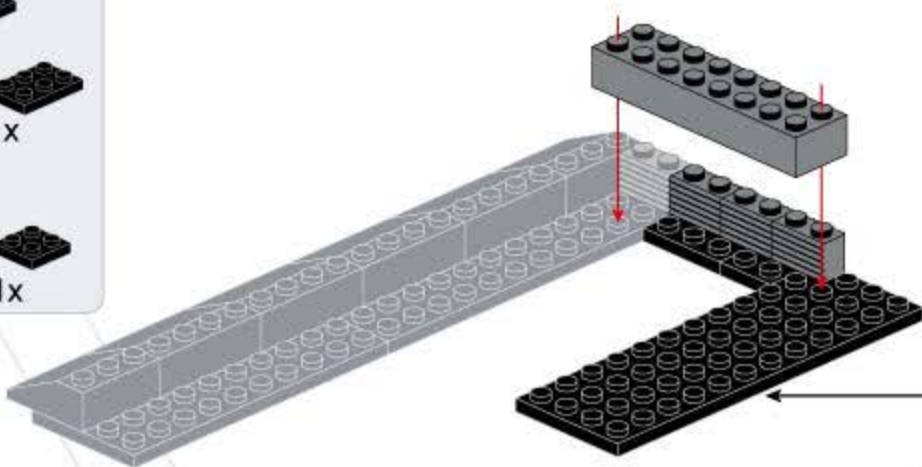
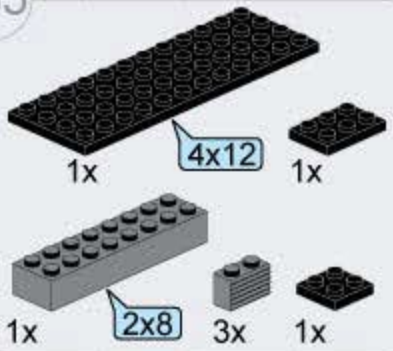

129

156

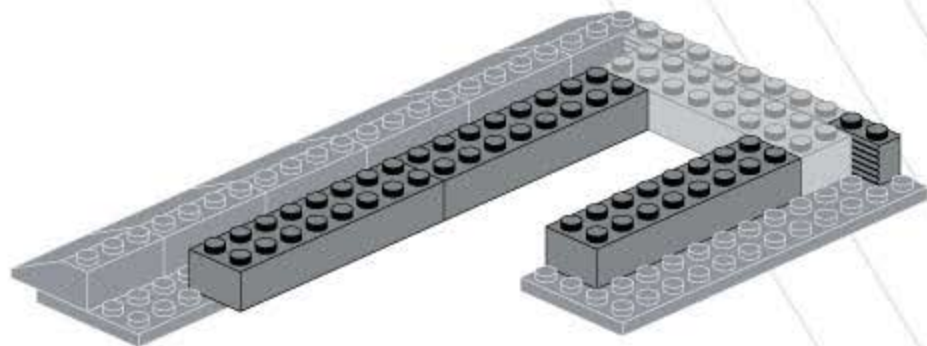
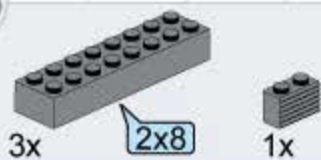

157

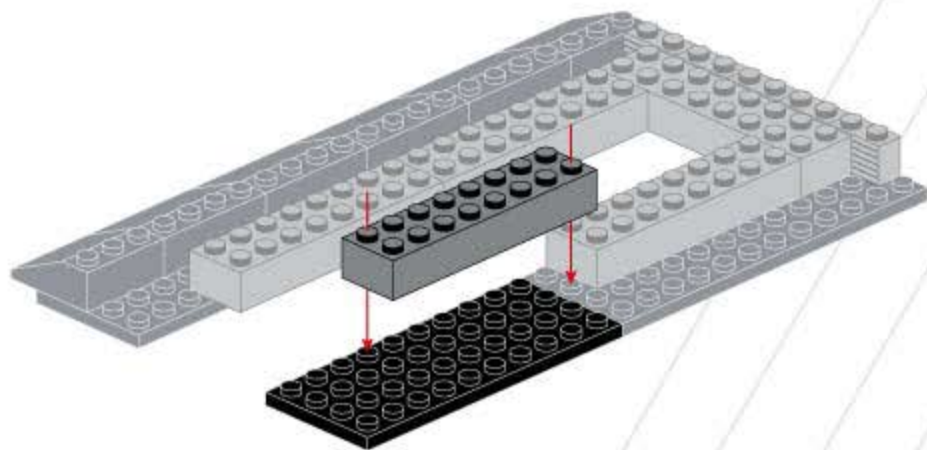
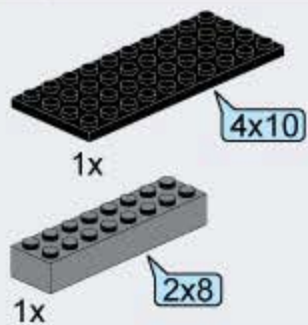

158

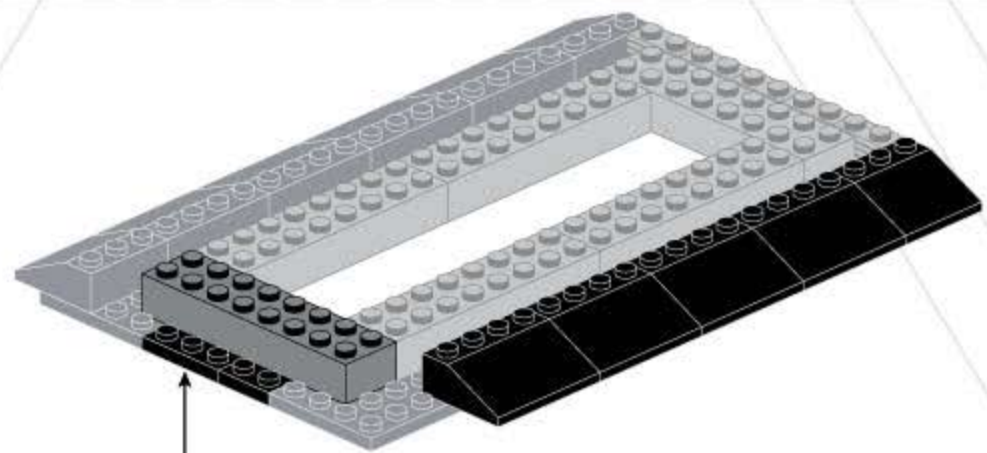
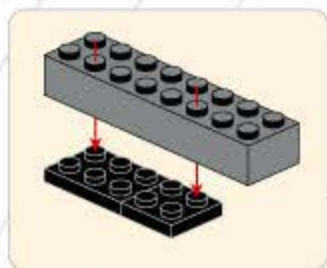
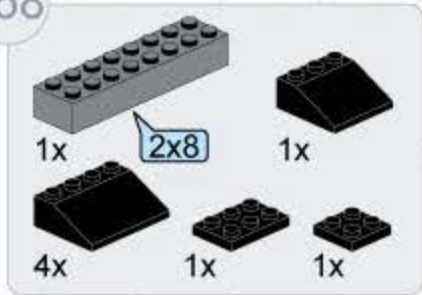

159

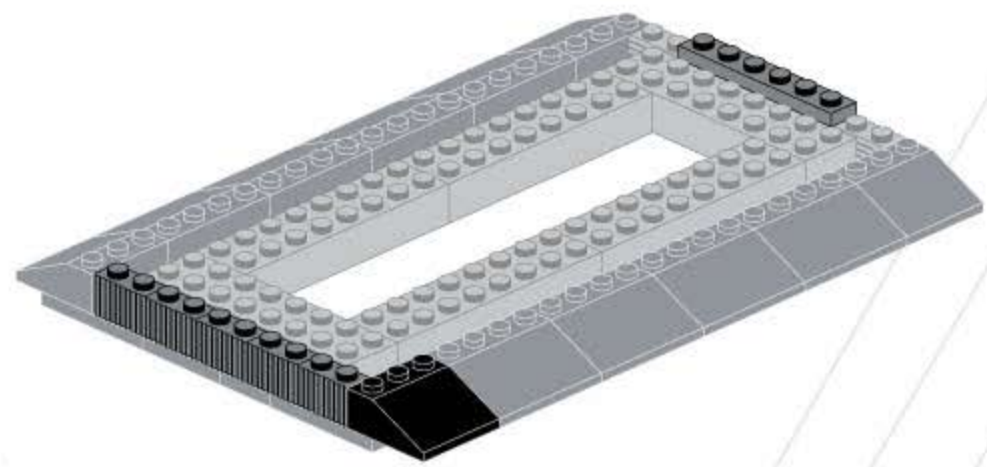
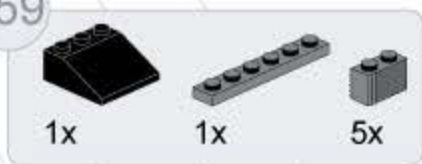

160



5x



1x

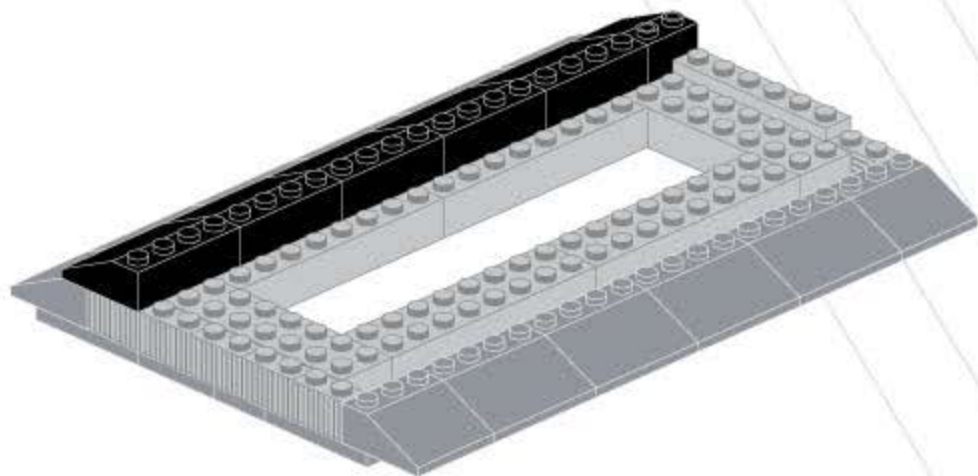

161



5x



1x



1x

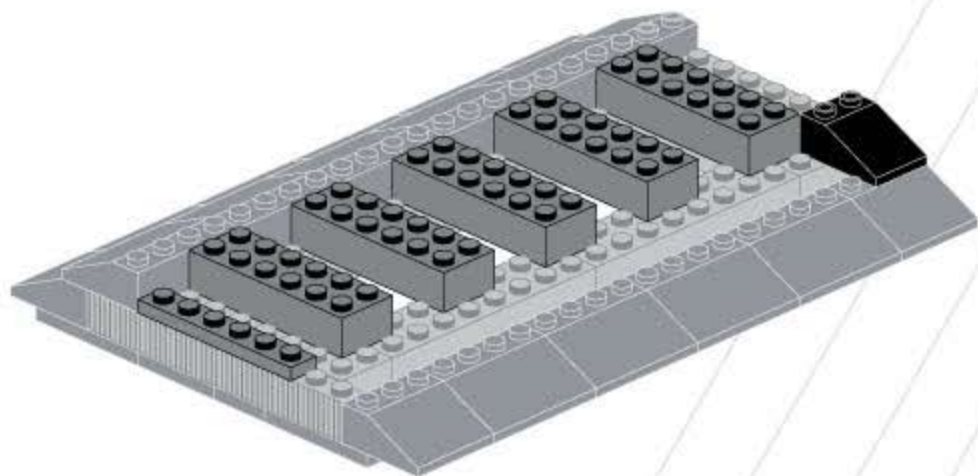

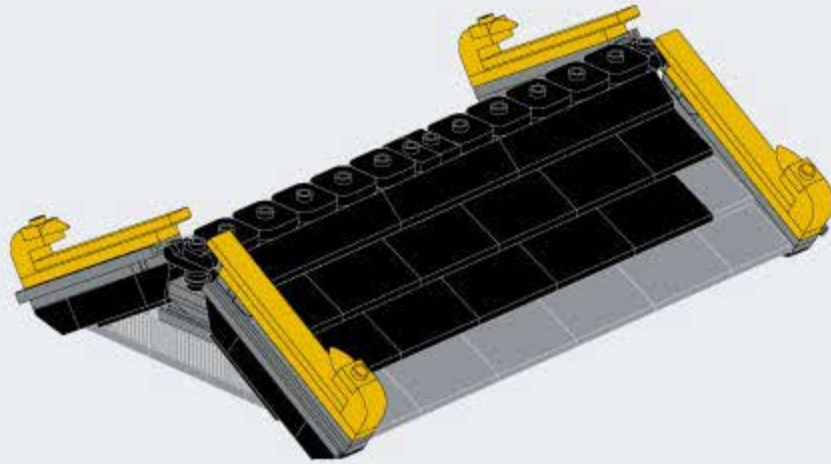

162



5x



2x



4x

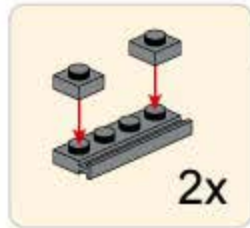

2x

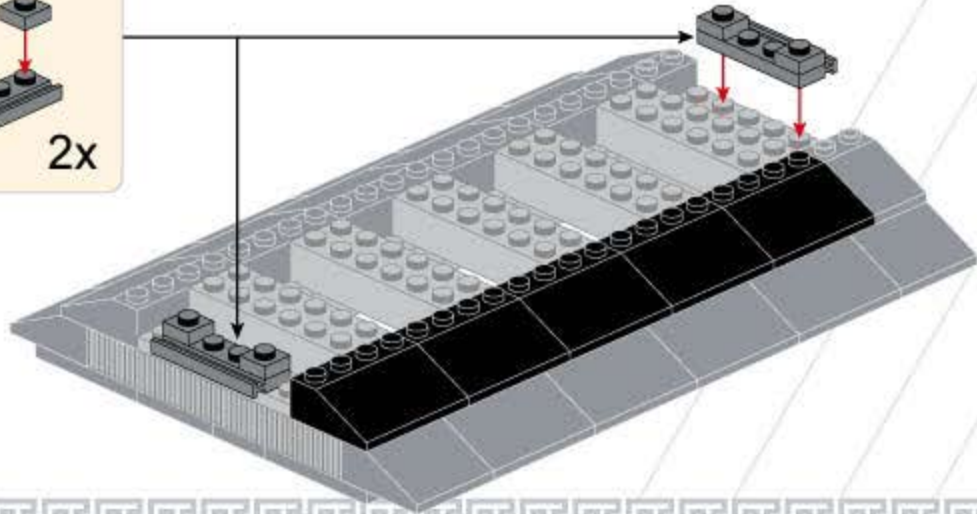

163

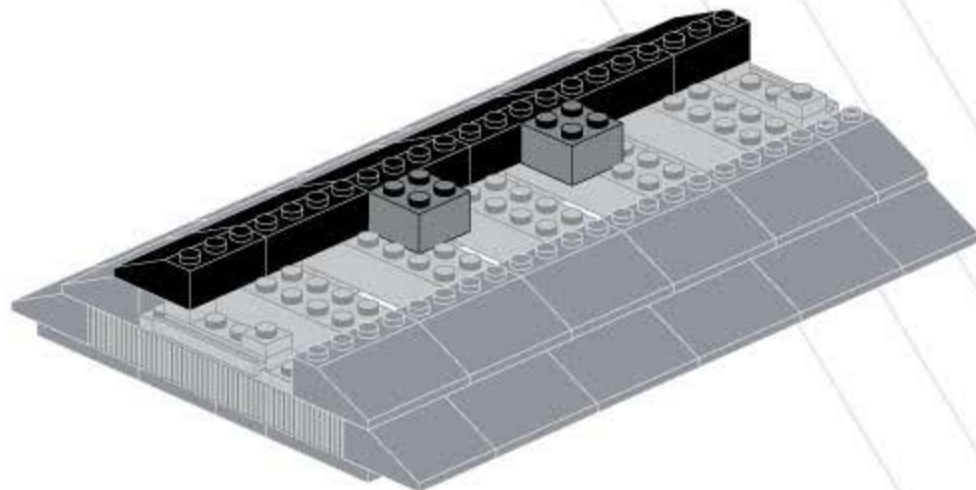

164

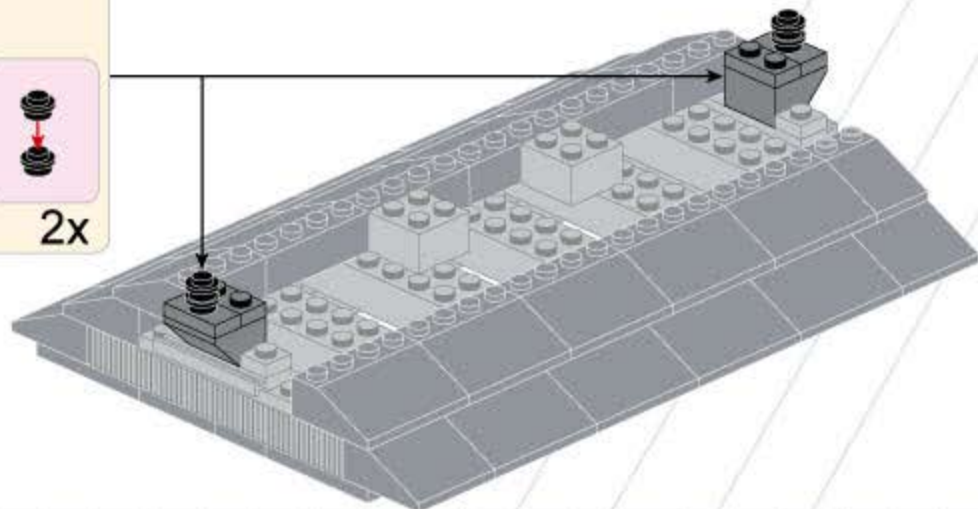
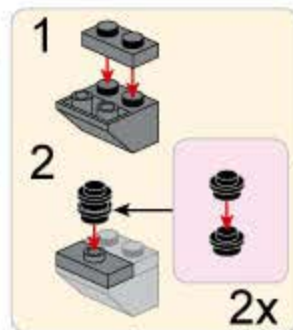

- 1x [grey 1x10 Technic brick]
- 1x [grey 1x6 Technic brick]
- 1x [grey 1x2 Technic brick]
- 4x [black 1x4 Technic wedge]
- 2x [black 1x3 Technic wedge]
- 2x [black 1x2 Technic wedge]
- 1x [black 1x4 Technic brick]
- 1x [black 1x2 Technic brick]
- 1x [black 1x1 Technic brick]
- 1x [yellow 1x2 Technic brick]
- 1x [yellow 1x10 Technic brick]
- 1x [yellow 1x2 Technic brick]
- 1x [yellow 1x8 Technic brick]
- 1x [yellow 1x8 Technic brick]
- 1x [yellow 1x2 Technic brick]

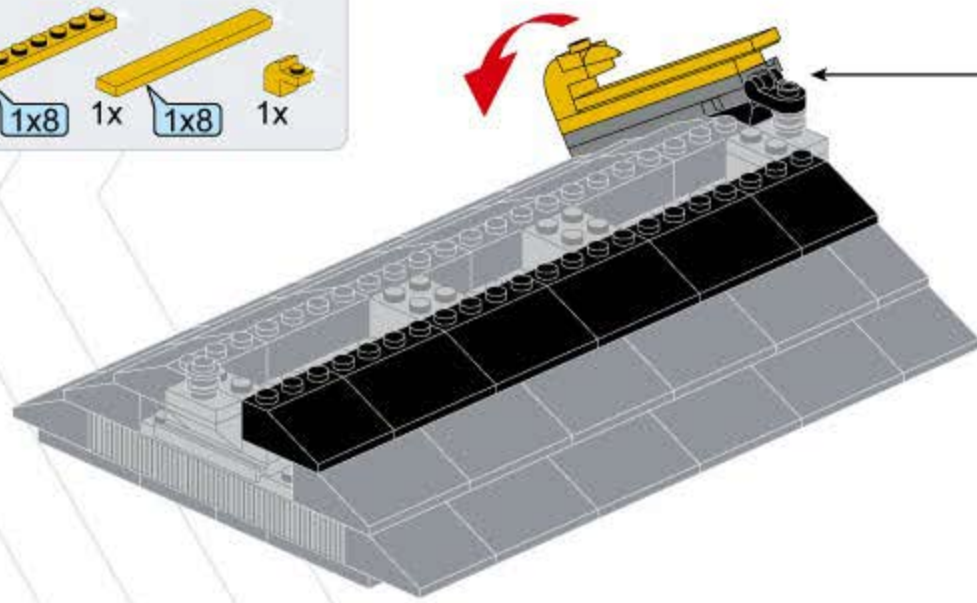

- 1 [grey 1x10 Technic brick] is placed on top of a black 1x6 Technic brick.
- 2 [grey 1x6 Technic brick] is placed on top of the grey 1x10 Technic brick. A callout shows a grey 1x2 Technic brick being placed on top of a black 1x2 Technic brick.
- 3 [grey 1x10 Technic brick] is placed on top of the grey 1x6 Technic brick. A callout shows a grey 1x2 Technic brick being placed on top of a black 1x2 Technic brick.
- 4 [yellow 1x10 Technic brick] is placed on top of the grey 1x10 Technic brick. A callout shows a yellow 1x2 Technic brick being placed on top of a yellow 1x2 Technic brick. Another callout shows a black 1x4 Technic brick being placed on top of the yellow 1x10 Technic brick.



- 2x [Black 1x10 Technic Beam]
- 1x [Black 1x6 Technic Beam]
- 2x [Black 1x2 Technic Beam]
- 1x [Black 1x3 Technic Beam]
- 1x [Black 1x1 Technic Pin]
- 1x [Black 1x1 Technic Pin]
- 1x [Black 1x1 Technic Pin]
- 1x [Black 1x1 Technic Pin]
- 1x [Grey 1x6 Technic Beam]
- 1x [Grey 1x6 Technic Beam]
- 1x [Yellow 1x2 Technic Pin]
- 1x [Yellow 1x2 Technic Pin]
- 1x [Yellow 1x8 Technic Beam]
- 1x [Yellow 1x8 Technic Beam]

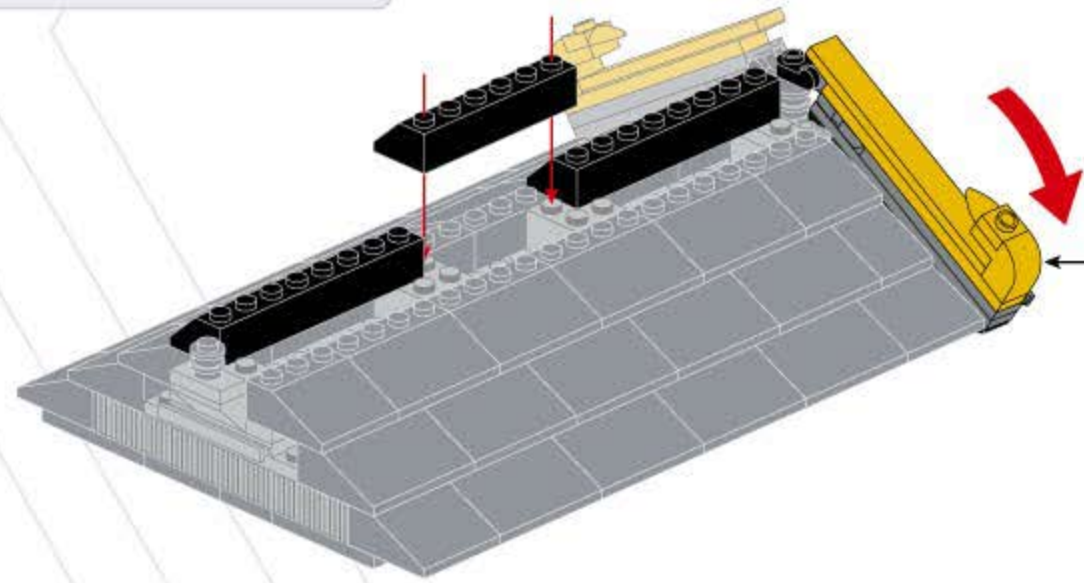

1

2

3

4

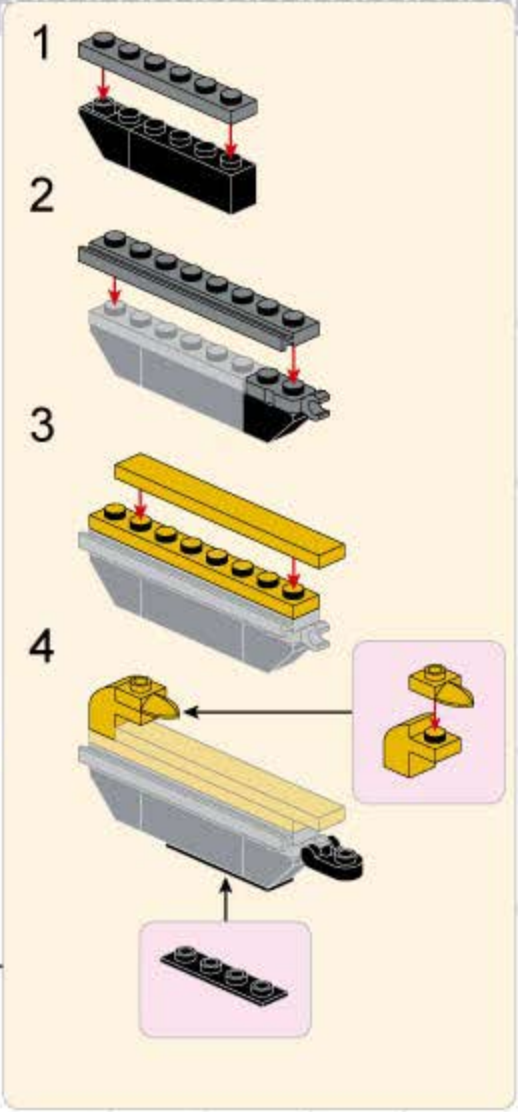
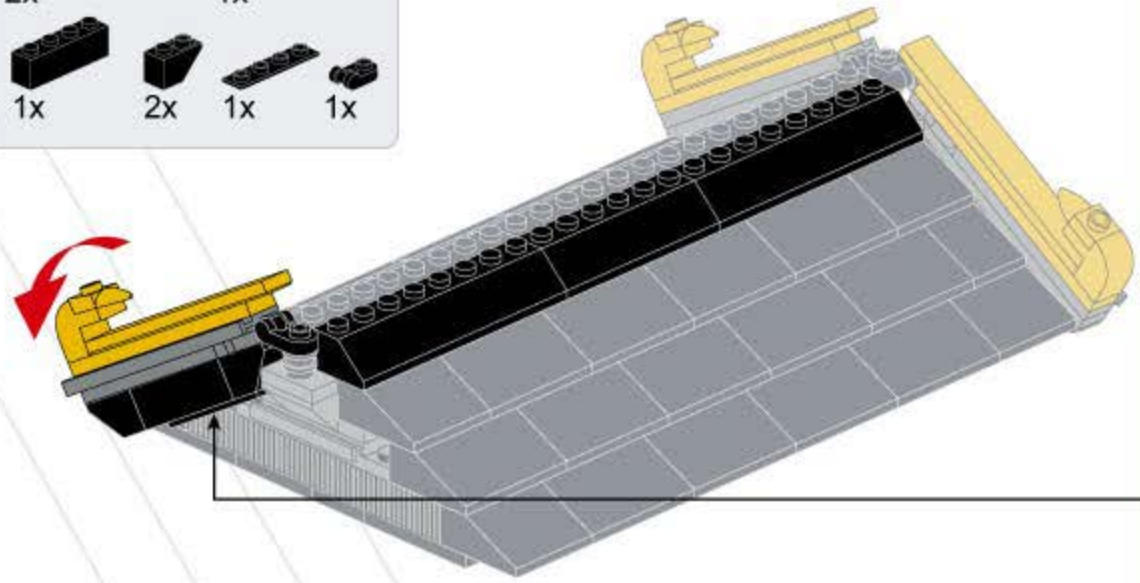
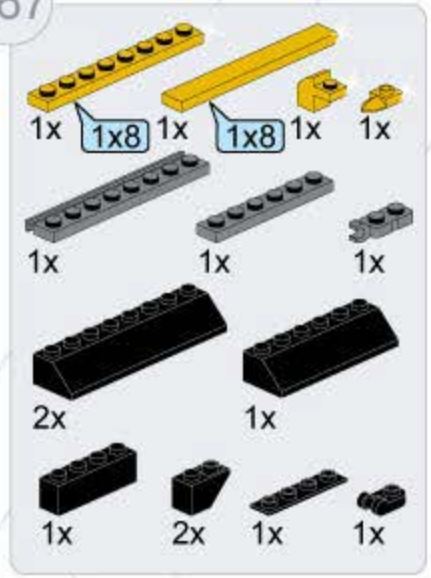





+

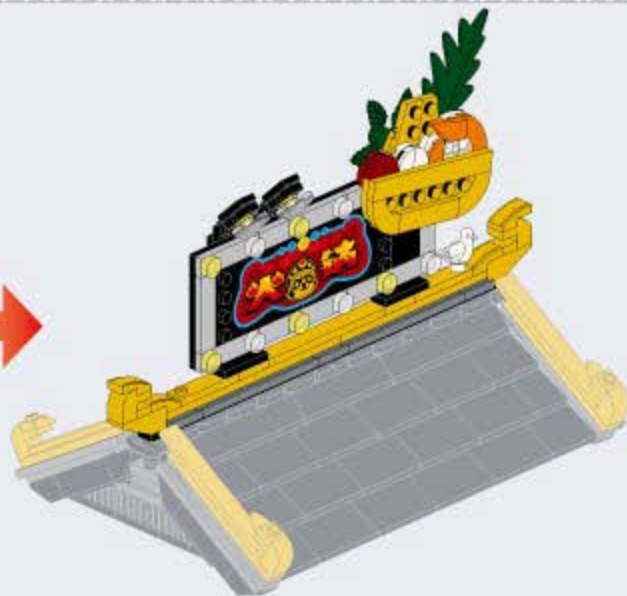

169



2x

1x12

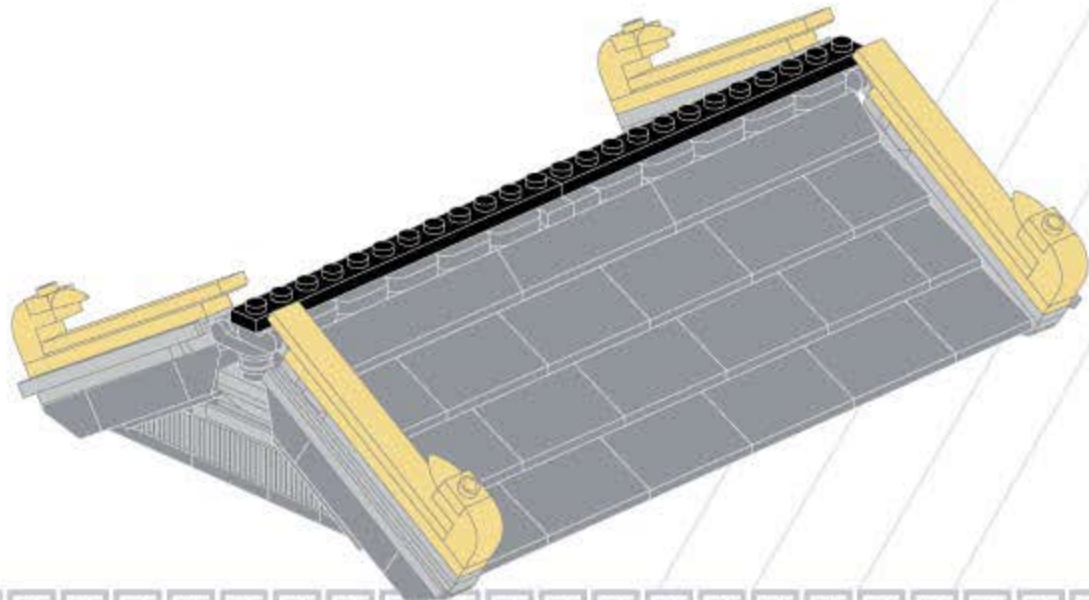

170



2x

3x

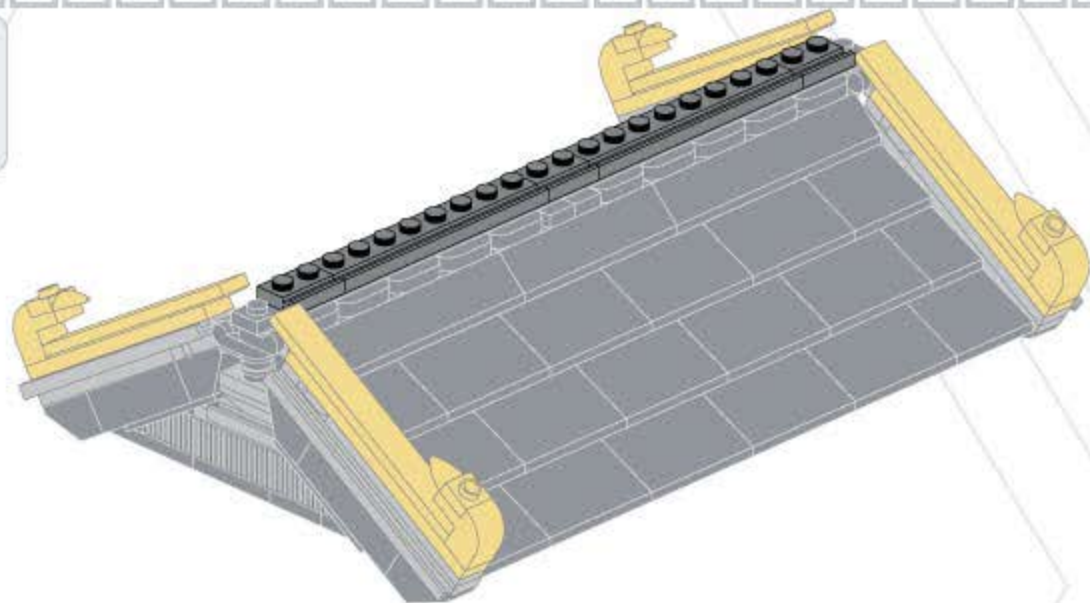

171

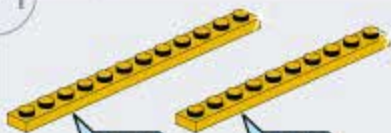

1x



1x12

1x

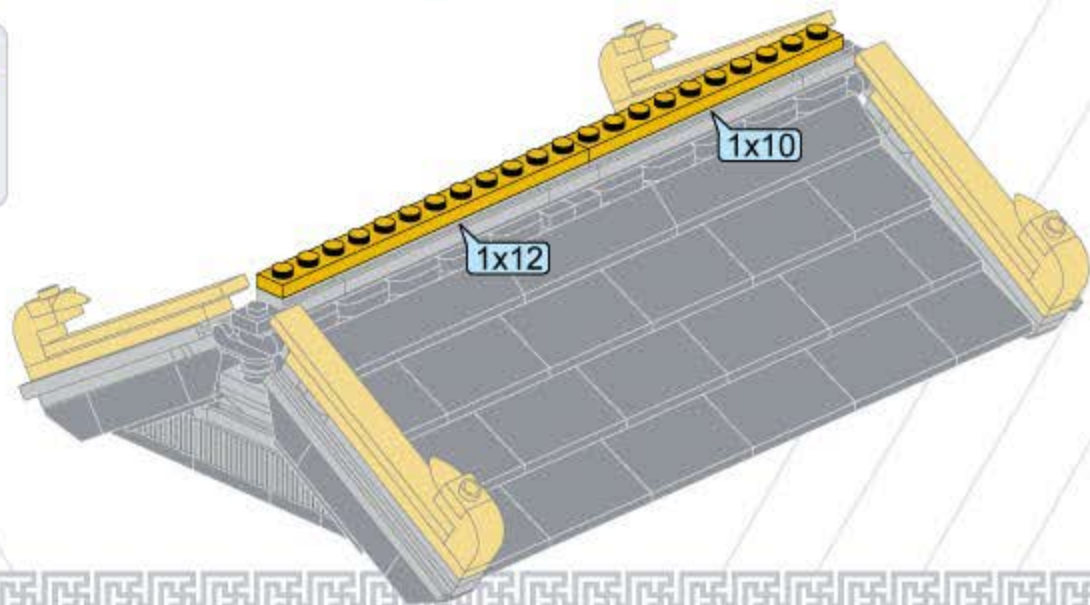
1x10





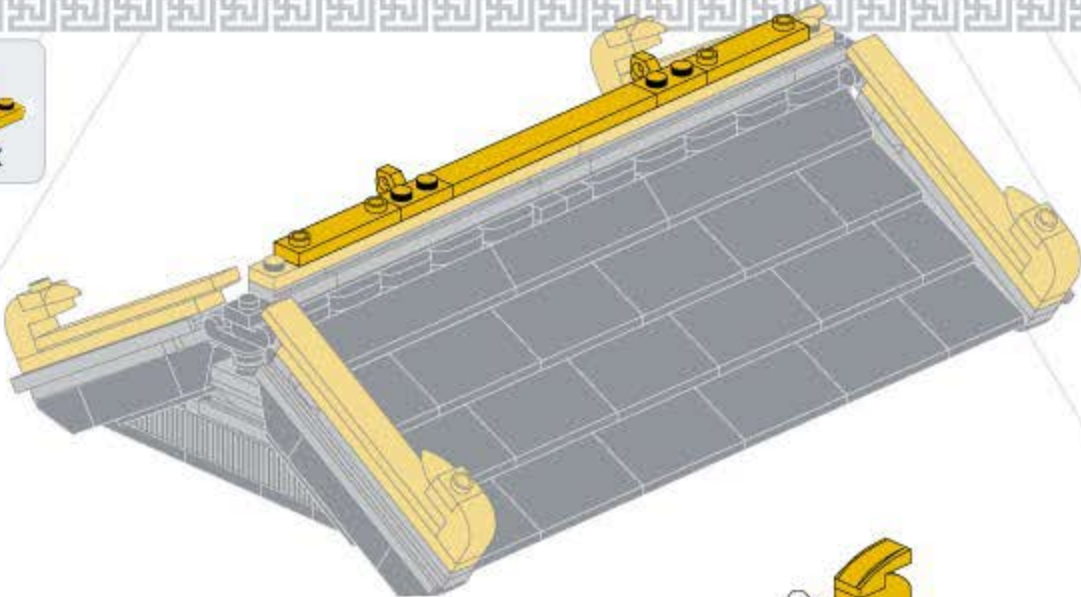

172



1x  1x8 2x  2x  2x

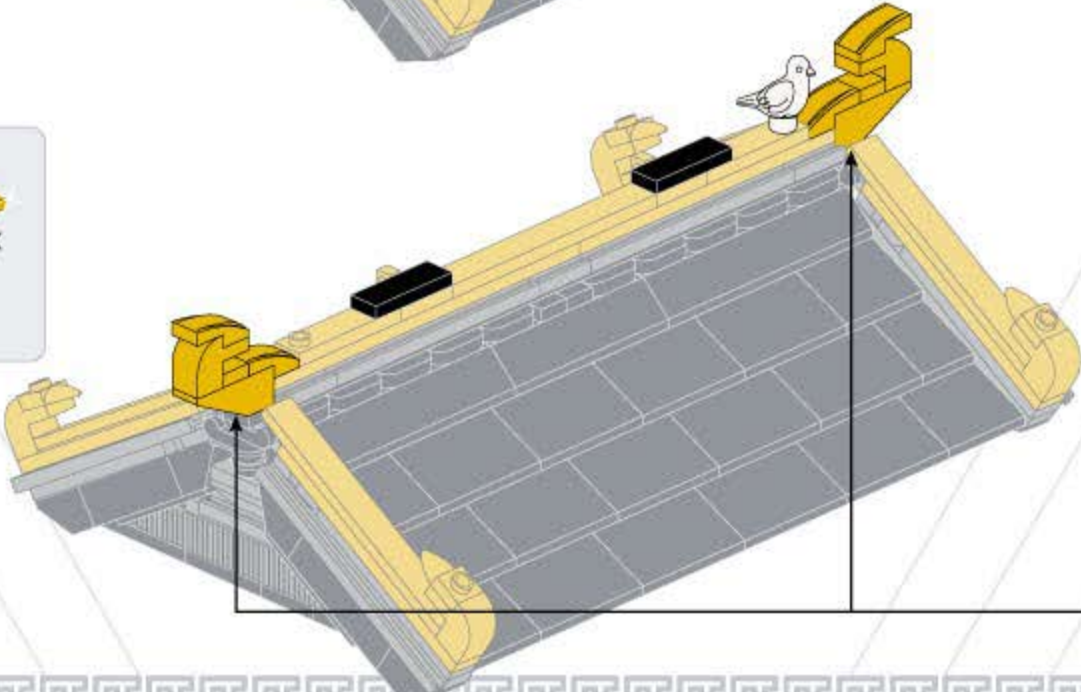

173

2x  2x  4x  2x  1x 2x  1x3



1  2  3  2x

141

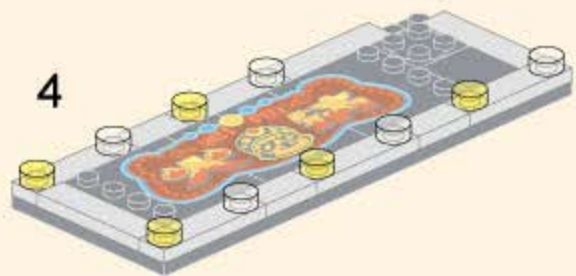
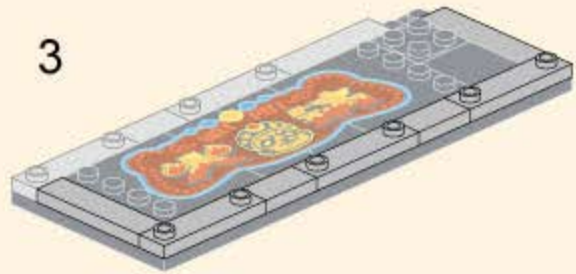



5

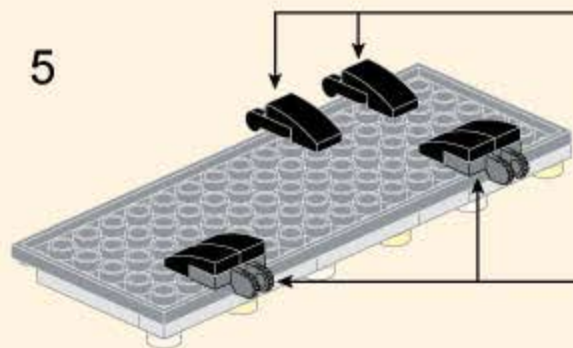







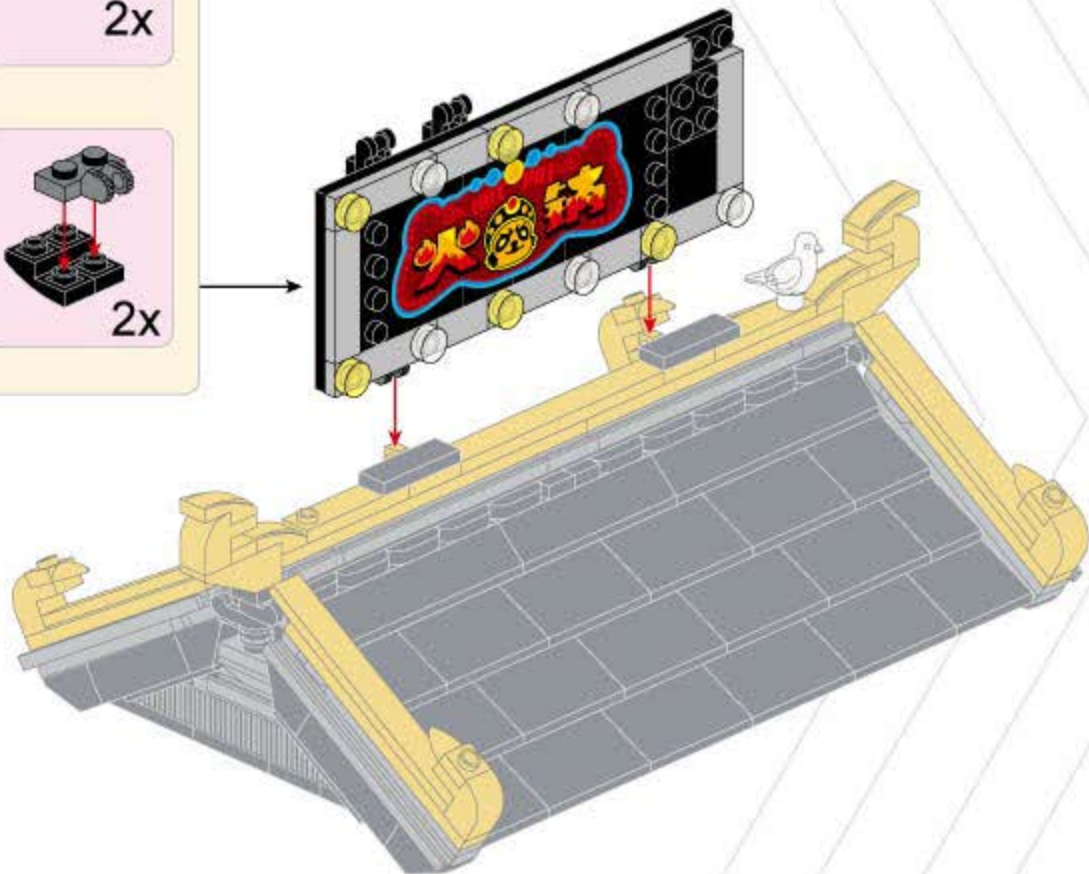











2x



2x





- 1x 1x8 
- 2x 
- 1x 
- 1x 
- 1x 
- 1x 
- 1x 1x4 
- 2x 
- 3x 
- 1x 
- 2x 
- 1x 
- 1x 
- 2x 
- 2x 
- 1x 
- 1x 
- 1x 
- 1x 

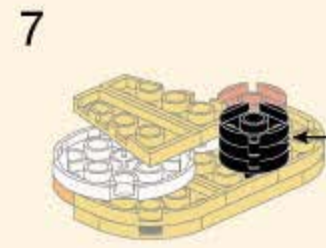
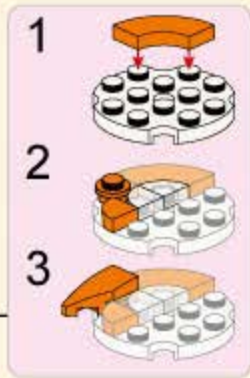
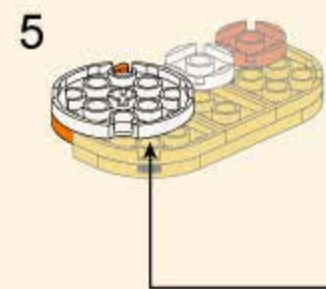
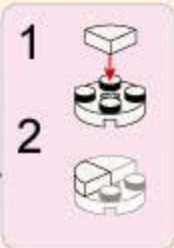
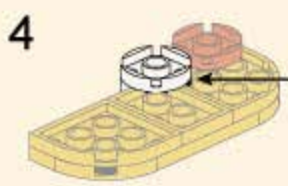
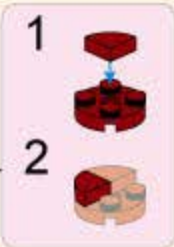
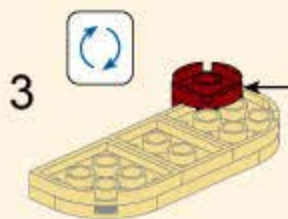
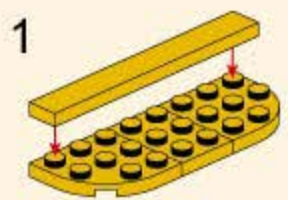

176

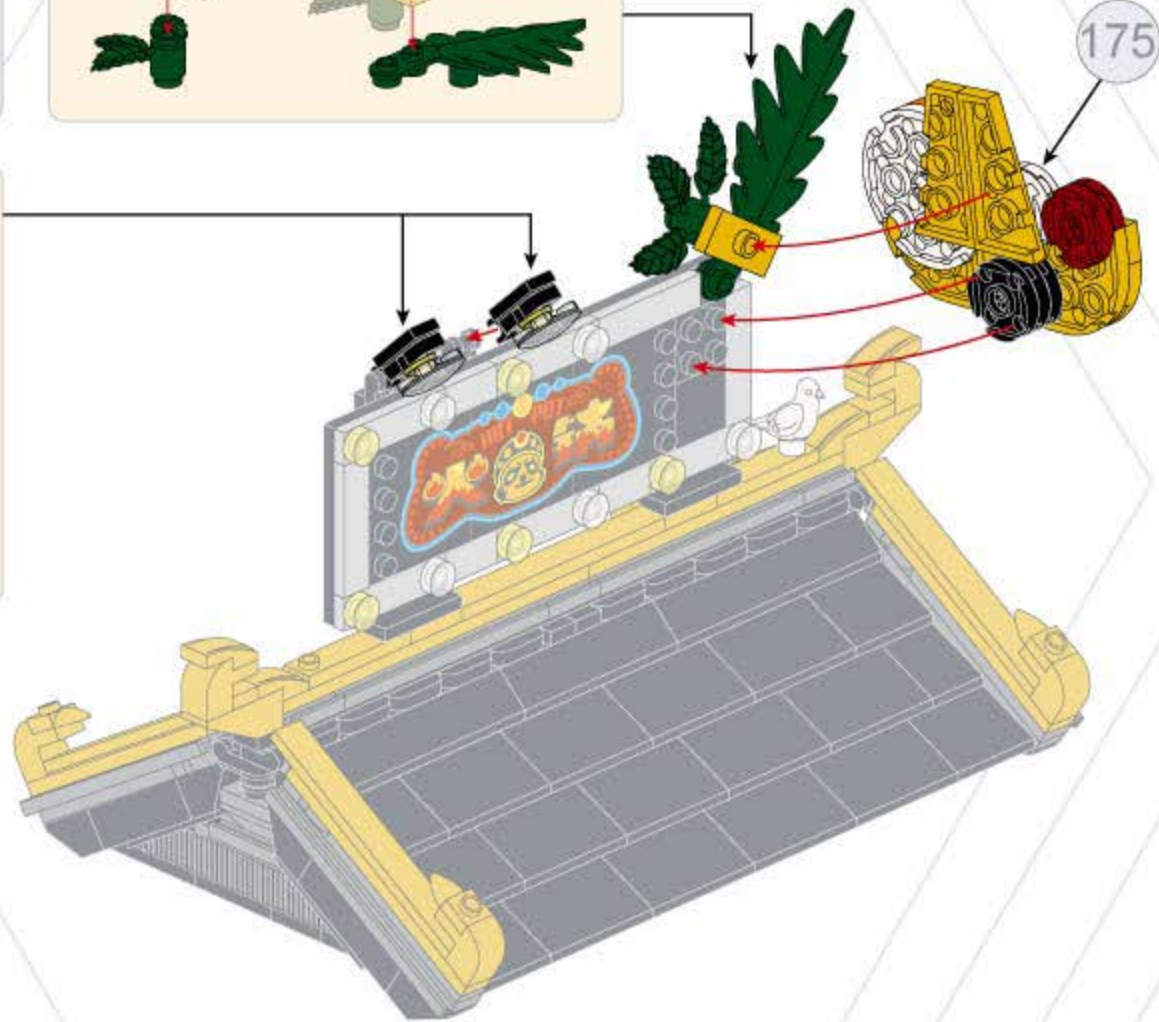
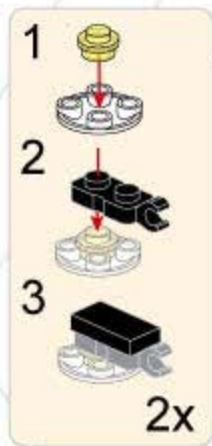
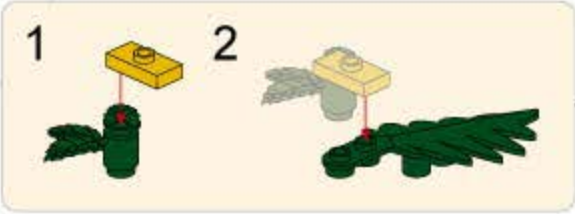
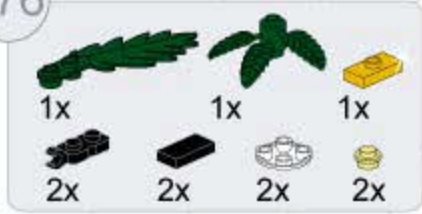

145



# Keeppley 国玩系列

## 精彩细节图

