

Keepplay

国玩系列



故宫宫廷文化



正版授权

K10112 镜像角楼



以紫禁城角楼水中倒影为灵感，
创新发展镜像角楼翻转玩趣。

图片仅供参考，请以实物为准。



拆件器使用方法, 仅为示例

Usage of Brick Separator, Just for the sample

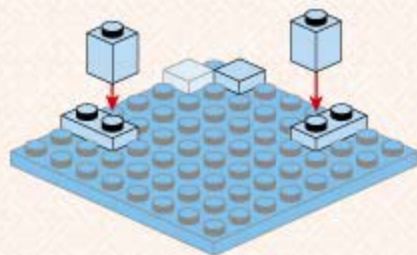
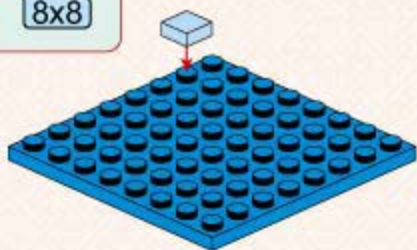
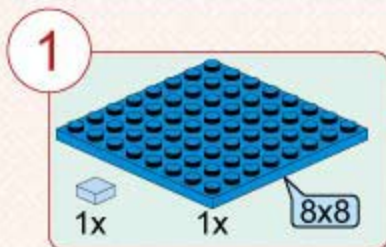
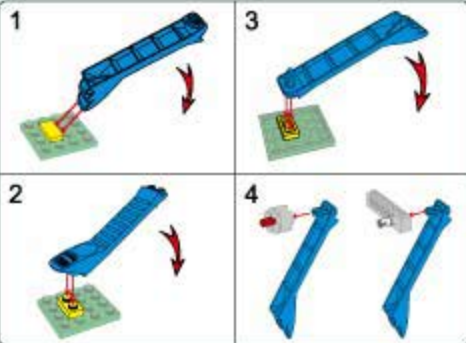

3

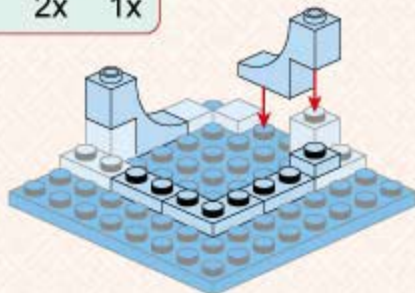
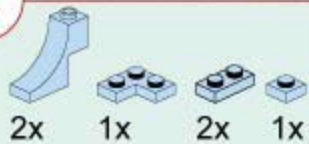

4

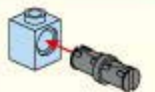

2x

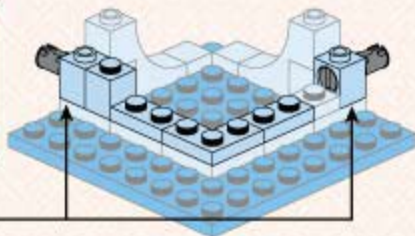

5

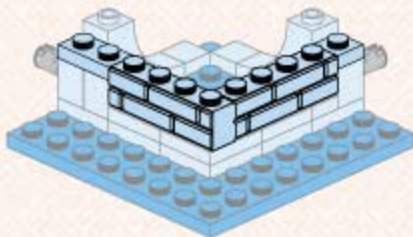
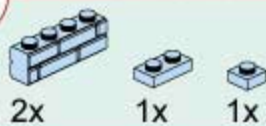

6



7

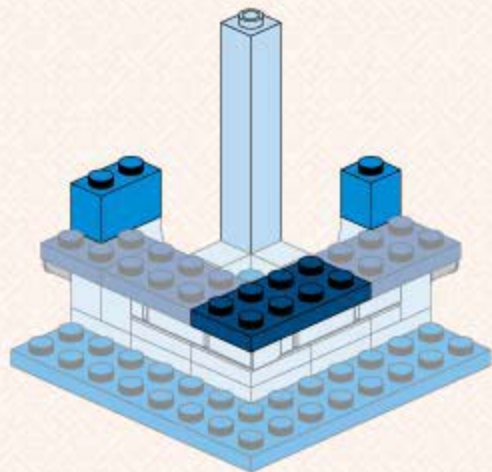
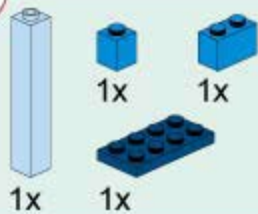

8

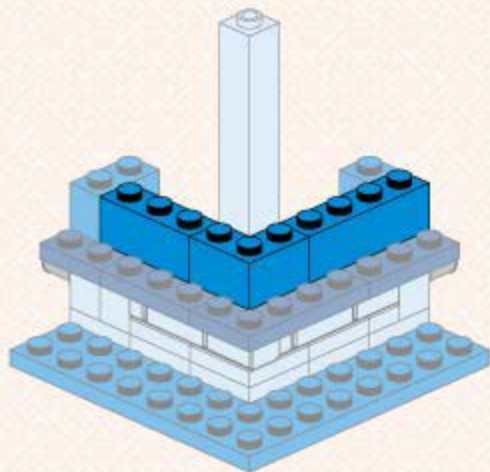
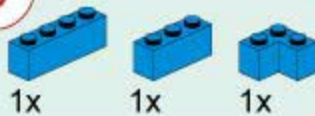

9



9x



9x



9x

10



6x

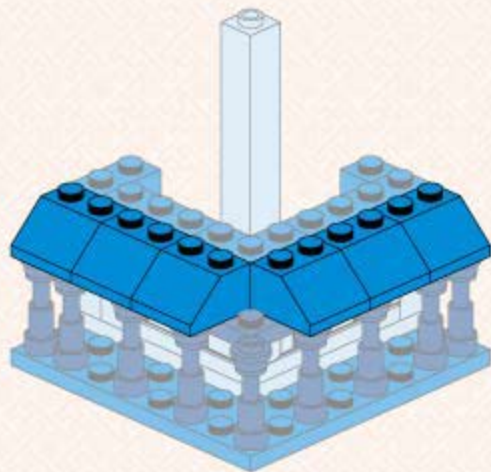
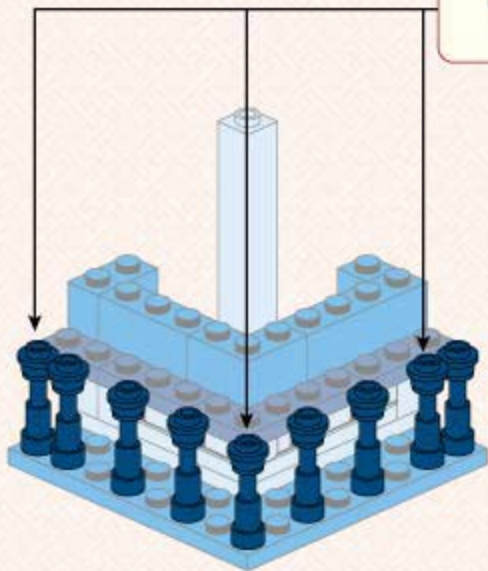

11

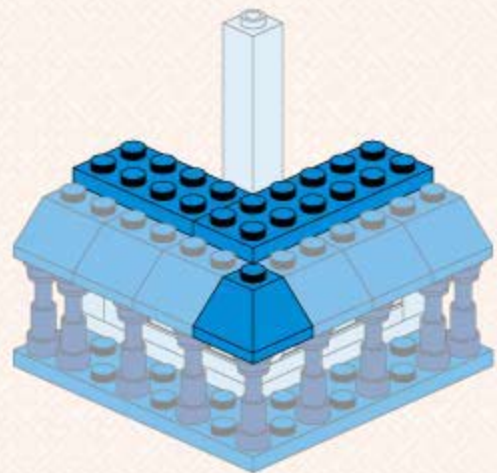
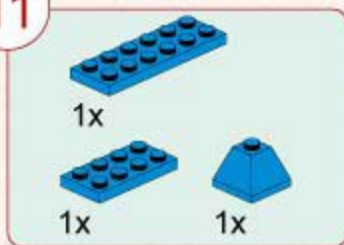

12

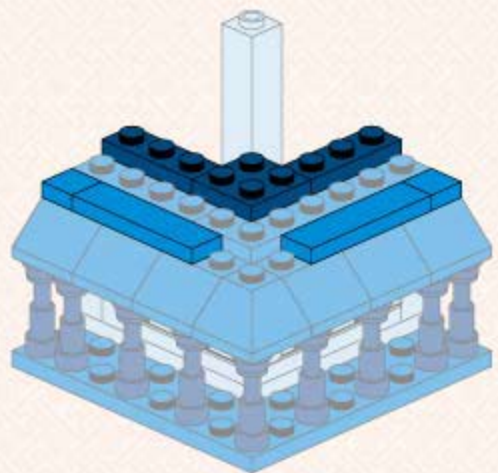
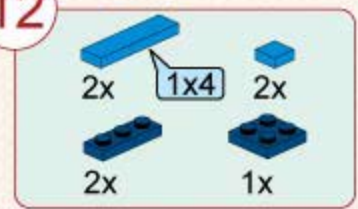

13



1x



2x



1x

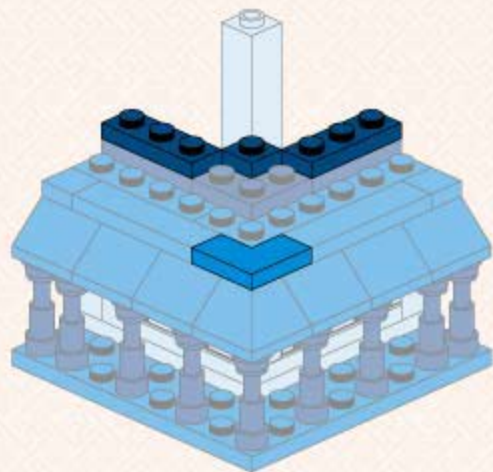

14



1x



3x



1x

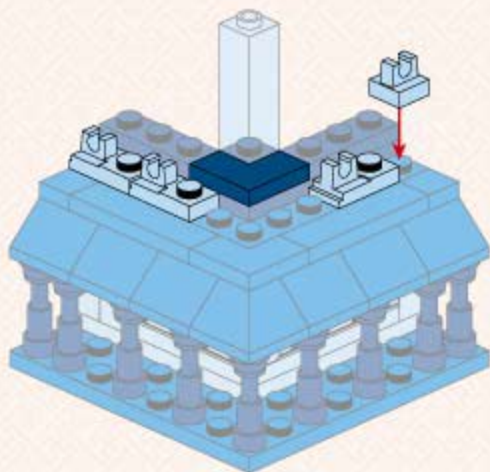

15

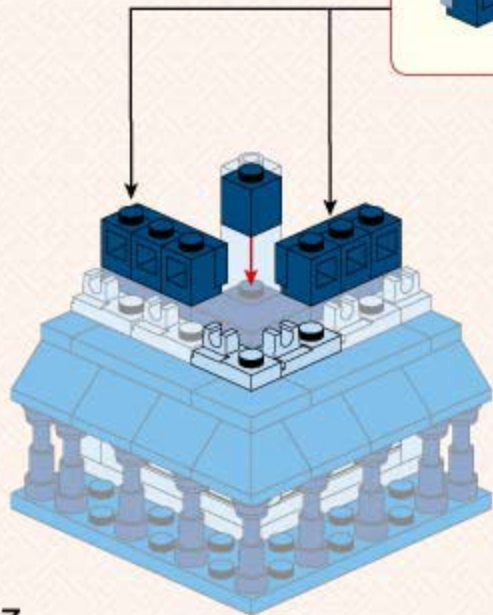
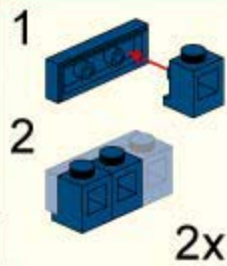

16

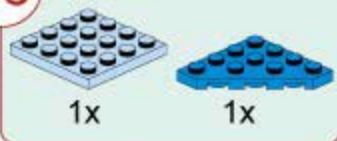

17

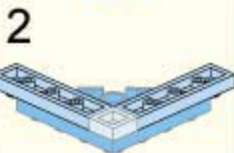
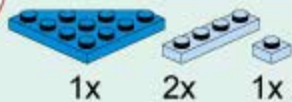

18



19



20

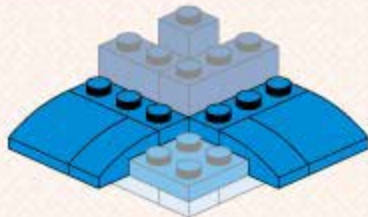

21

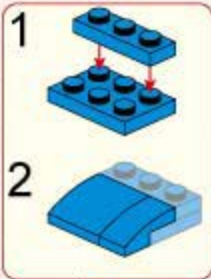
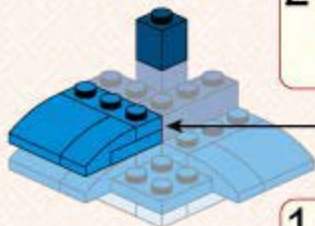
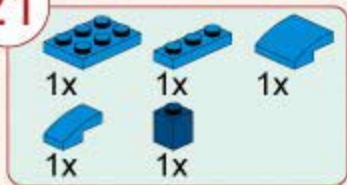

22

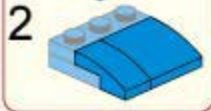
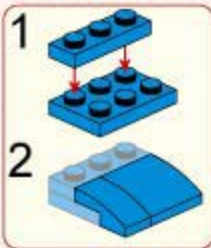
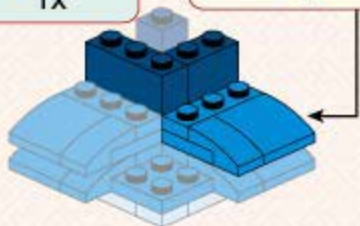
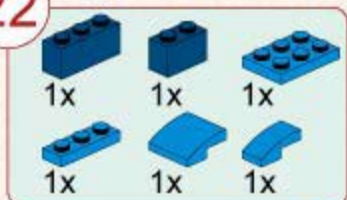

23

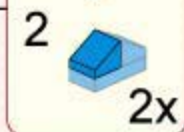
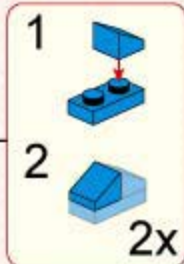
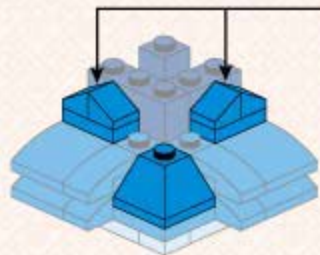

24

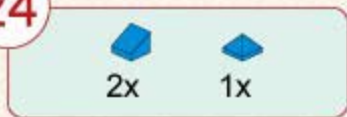

25

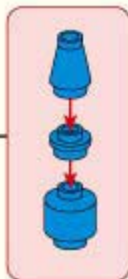
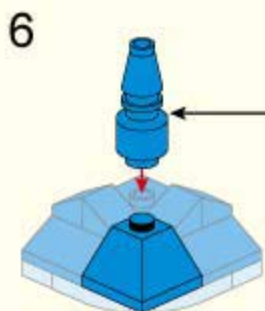
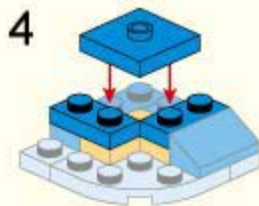
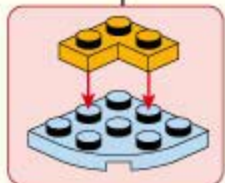
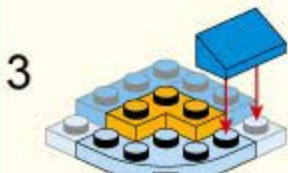
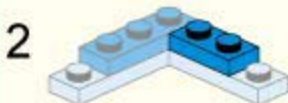
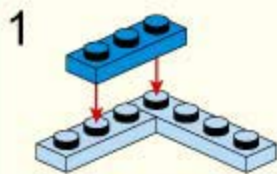
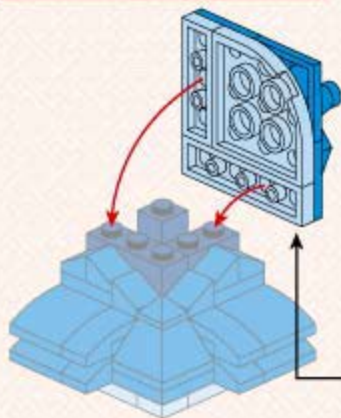
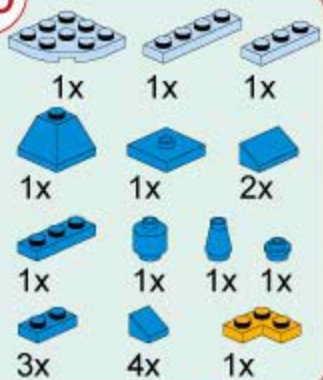

26

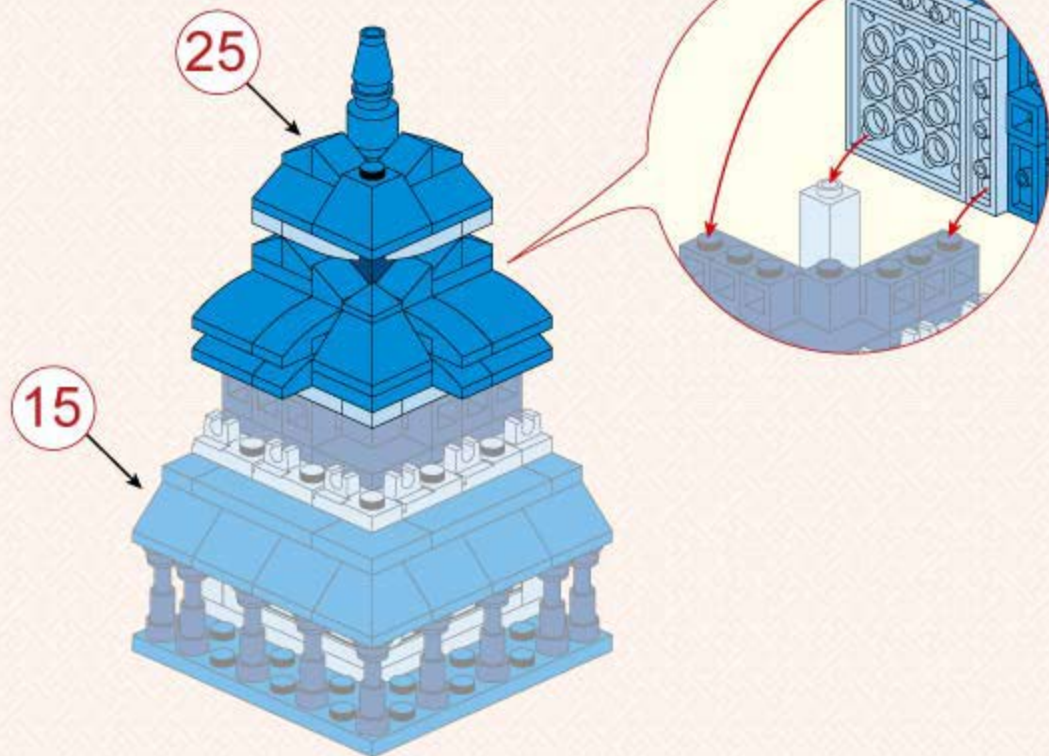



28

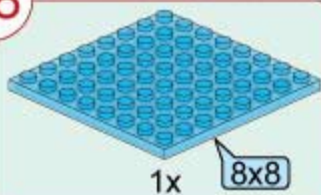

27

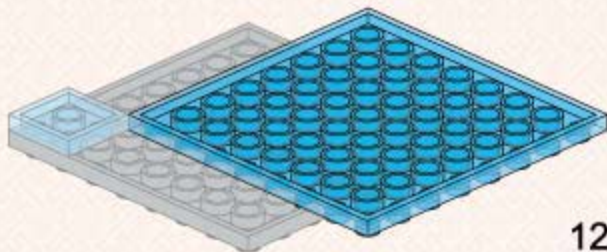
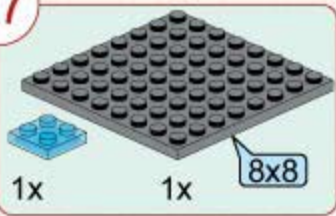

29



2x

30



2x



1x

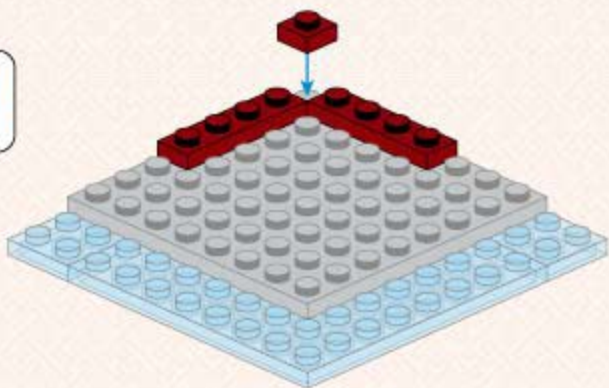
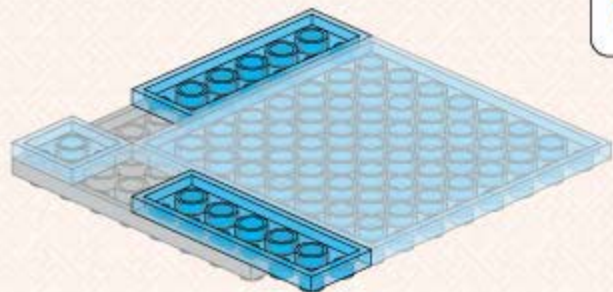

31



2x



2x



2x



2x



2x

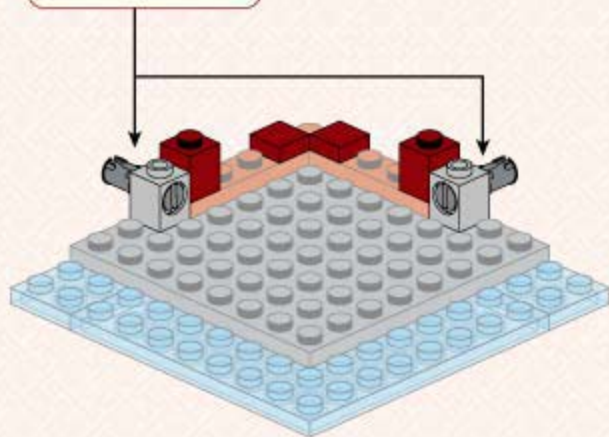

32



2x



1x



2x



1x

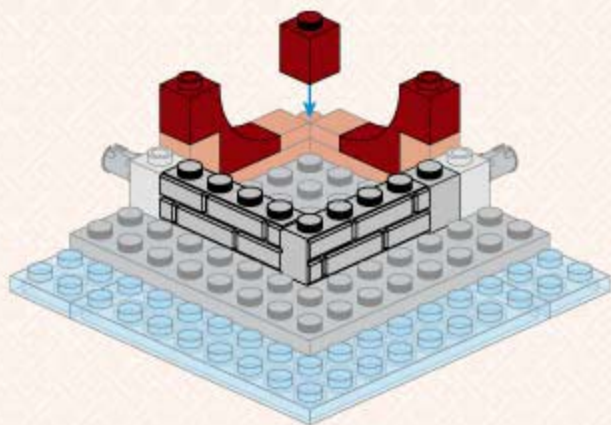

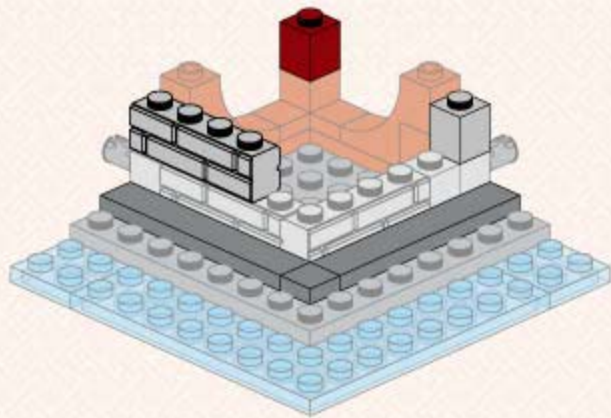
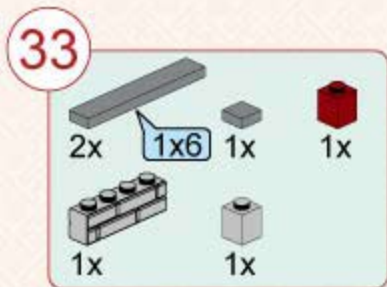
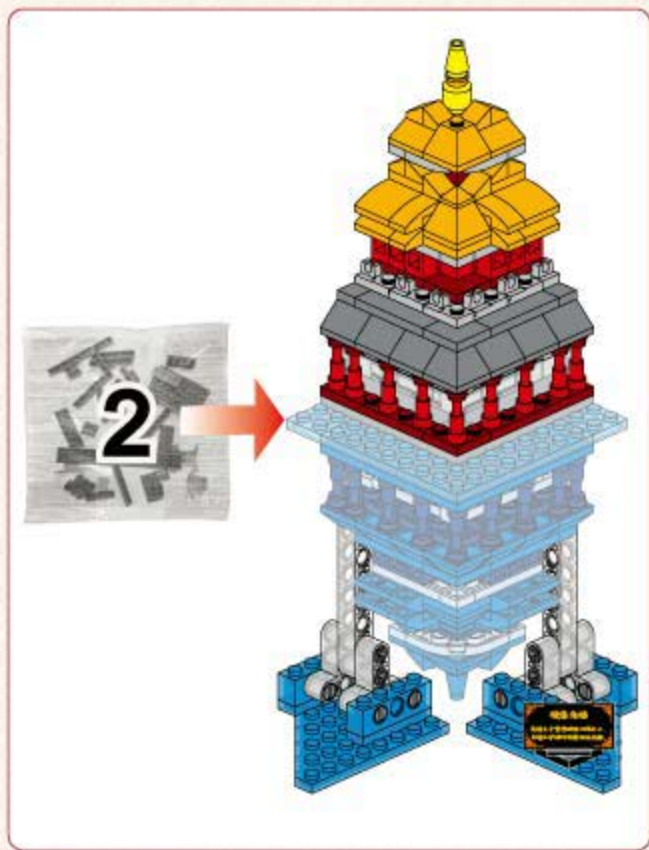

34

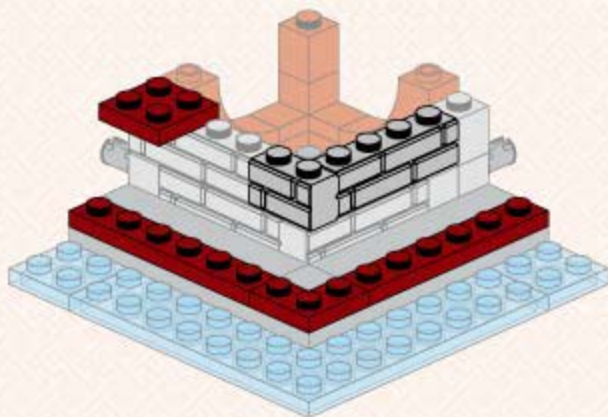
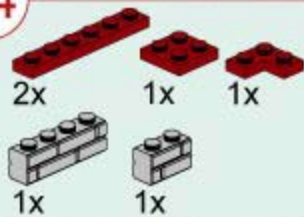

35

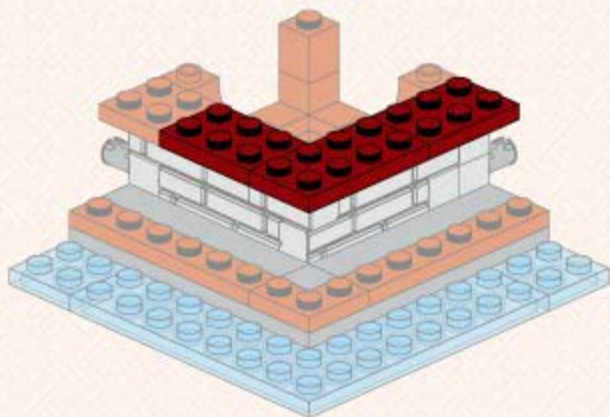

36



9x



9x



9x

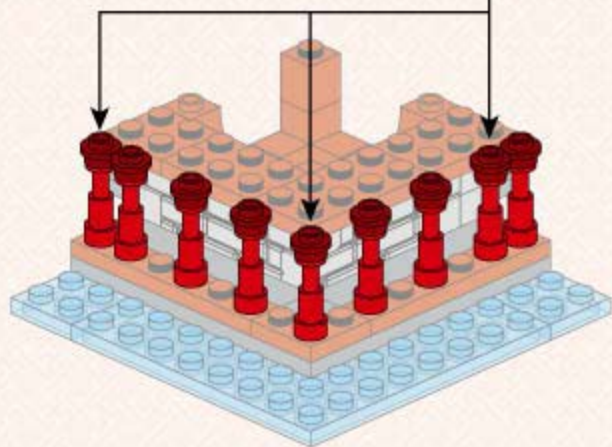

37



1x



1x



2x

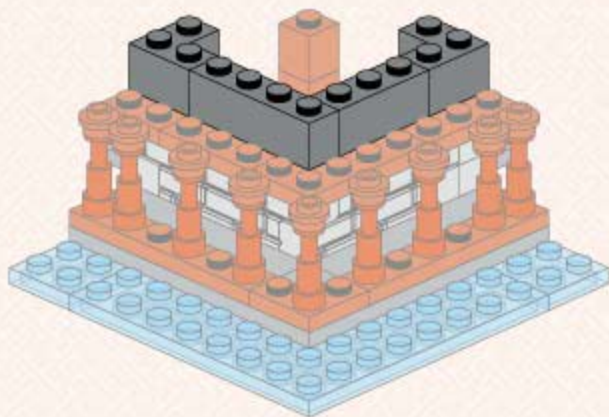

38



1x



6x

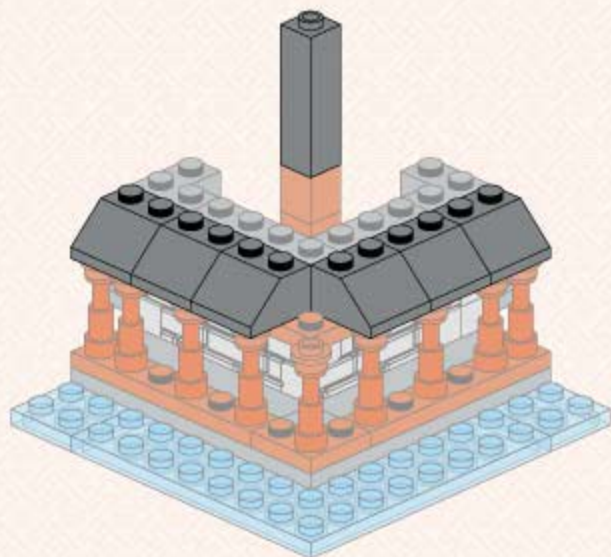

39



1x



1x



1x

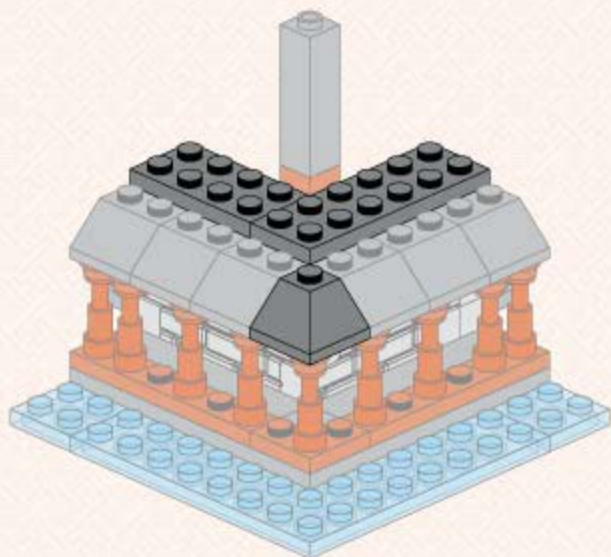

40

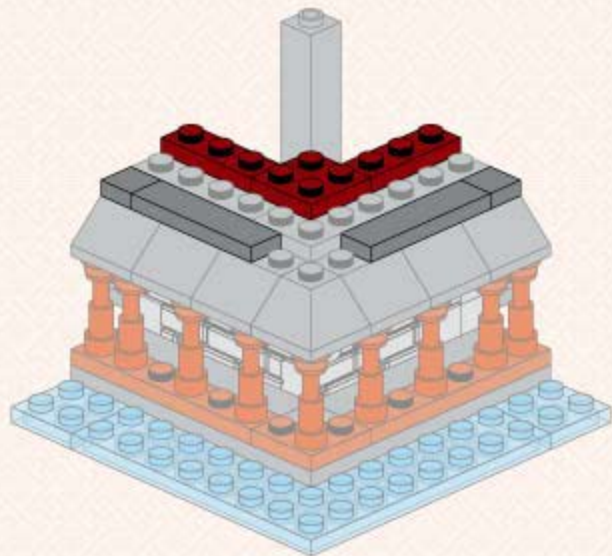
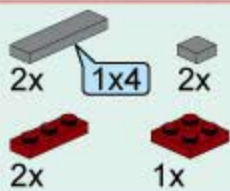

41

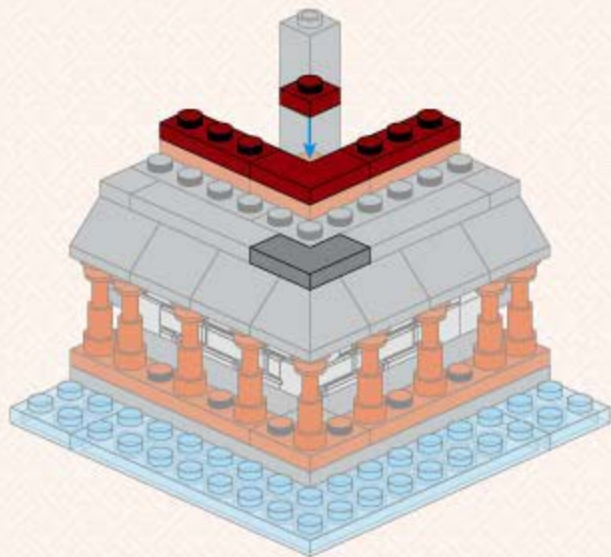

42



5x



1x

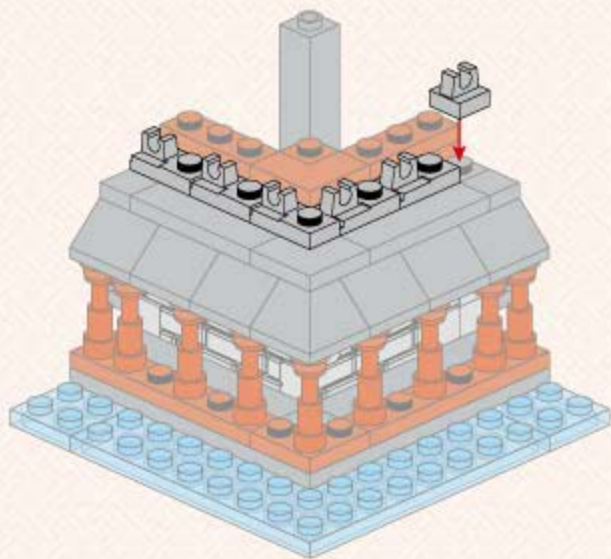

43



1x



6x



2x

1x3

1



2



2x

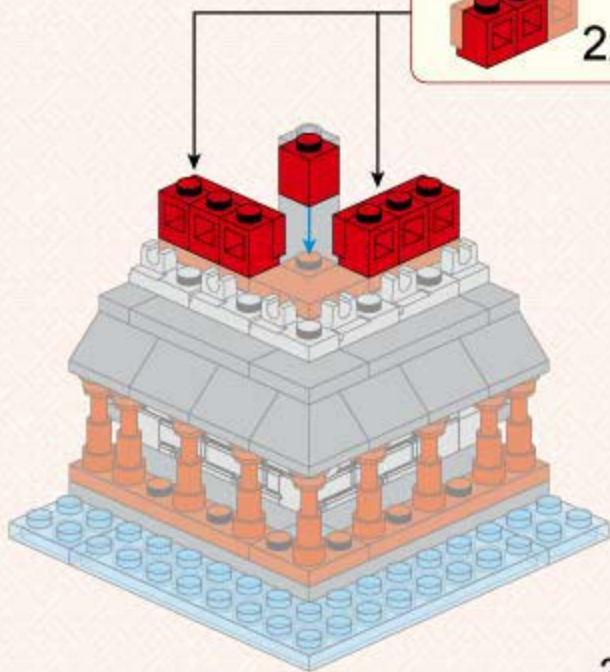

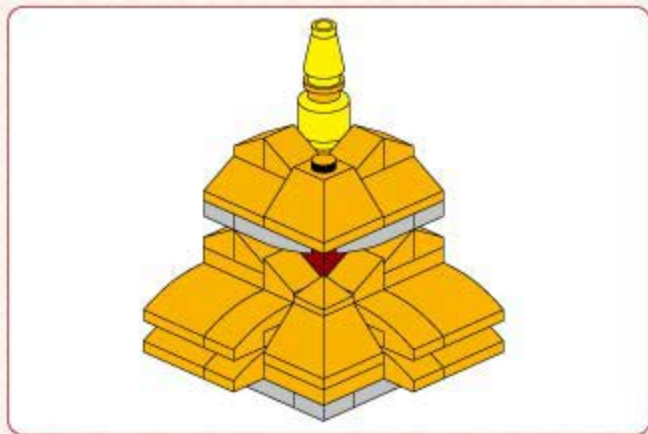

44

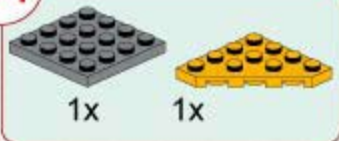

45

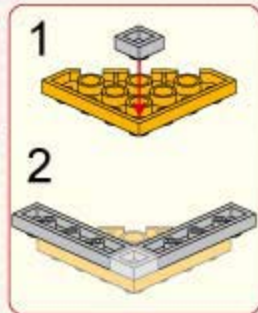
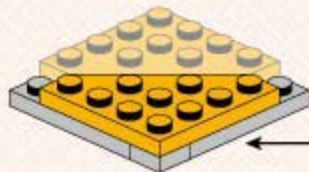
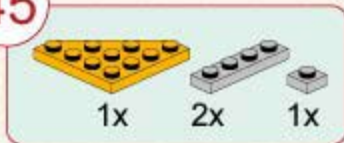

46

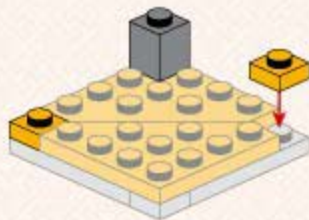

47



1x



1x

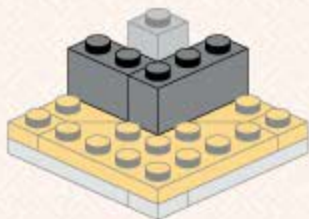

48



2x



2x



2x



49



1x



1x



1x



1x



1x

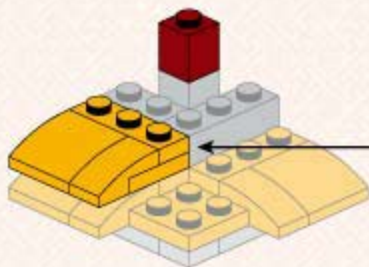

1

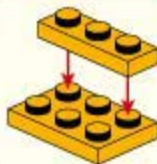

2



50



1x

1x

1x



1x



1x



1x

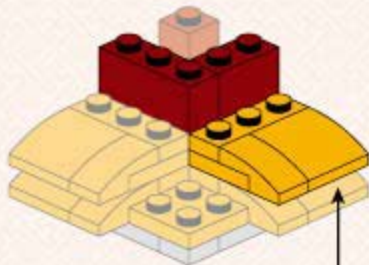

1

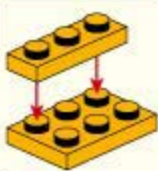

2



51



1x



2x



4x

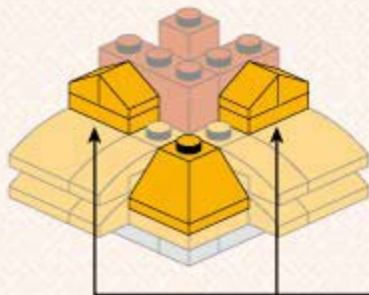

1



2



2x

52



2x



1x



53

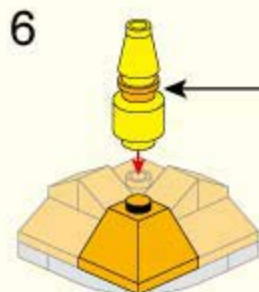
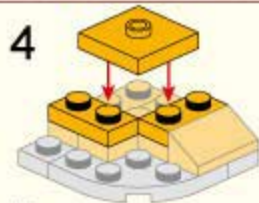
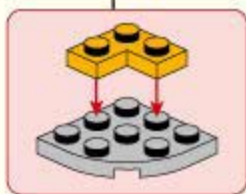
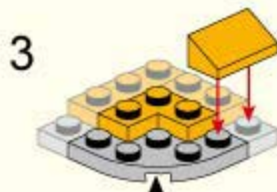
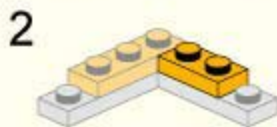
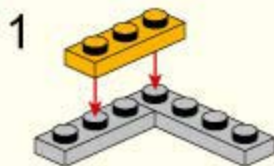
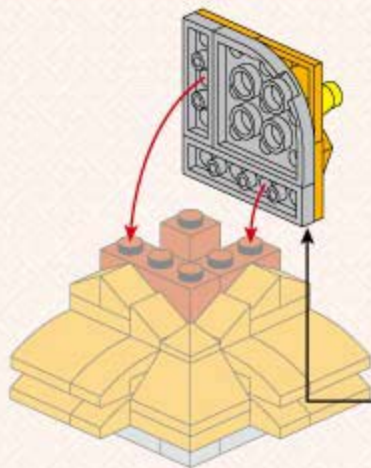
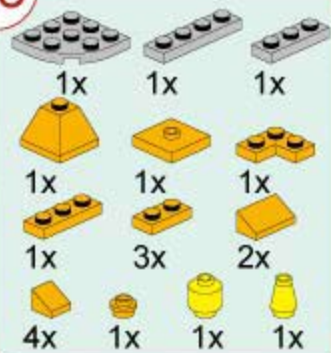

54

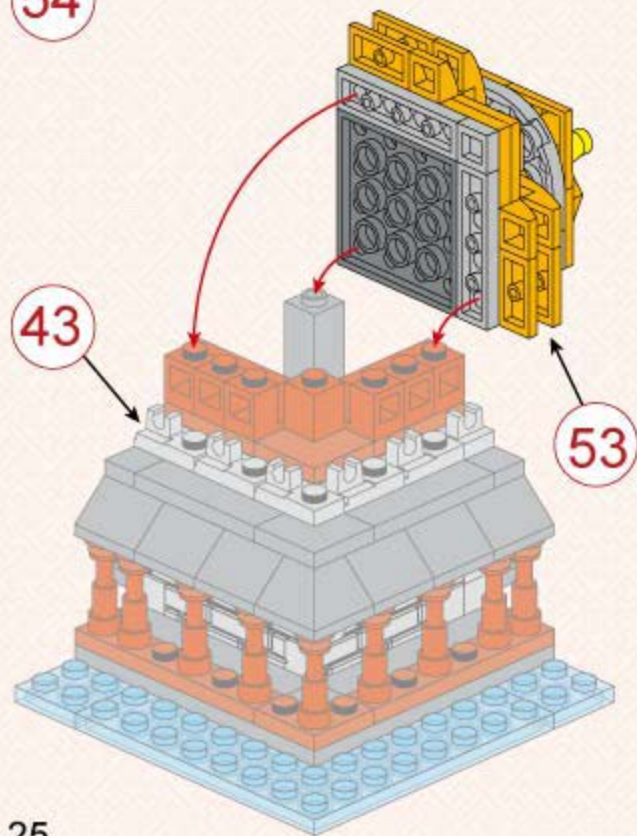

55



2x

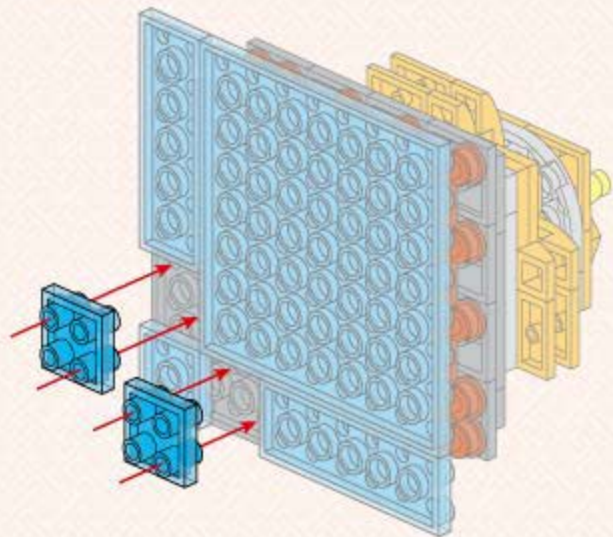

56

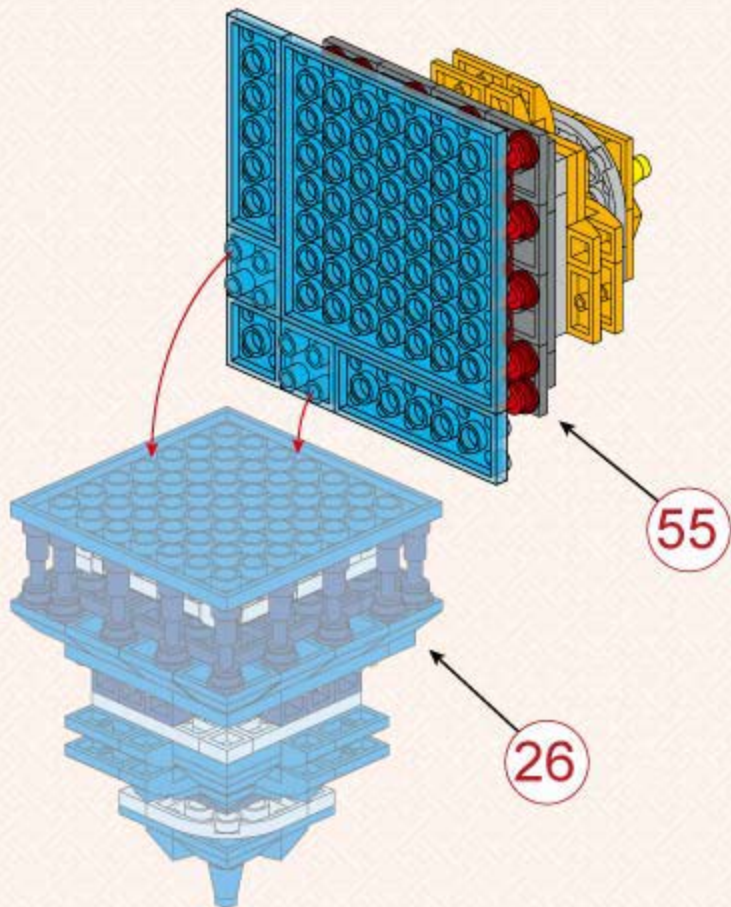

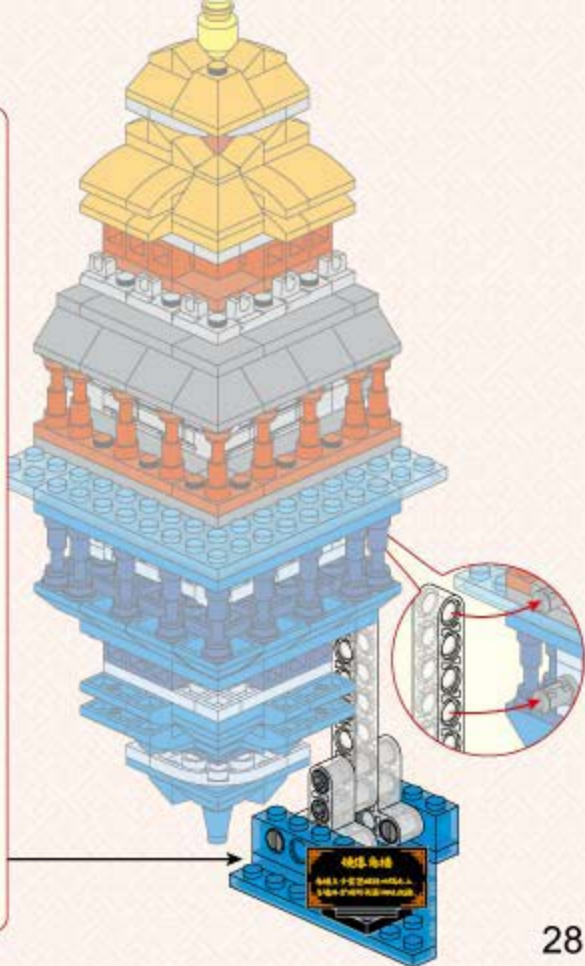
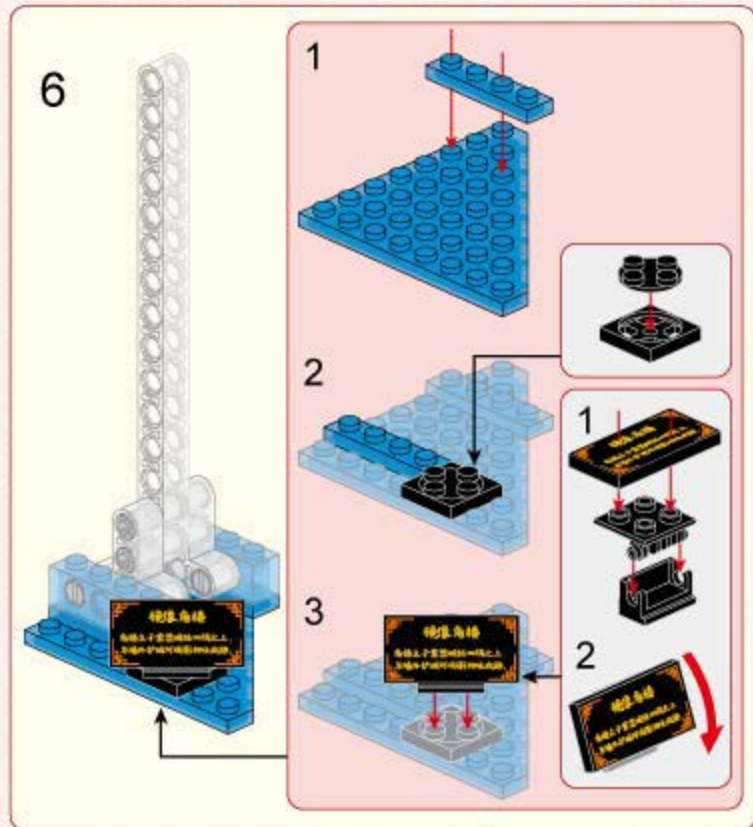

58

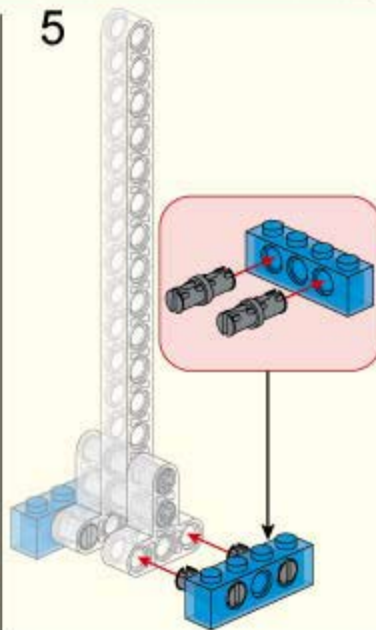
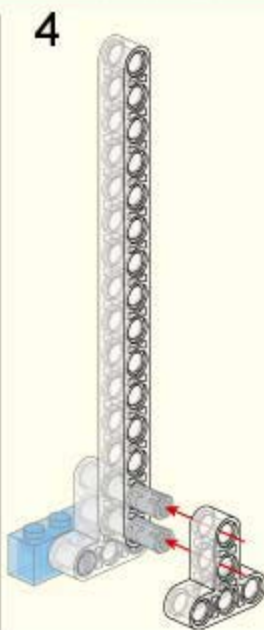
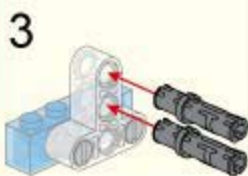
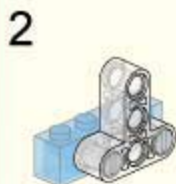
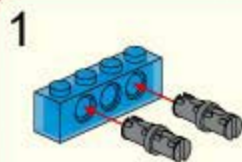
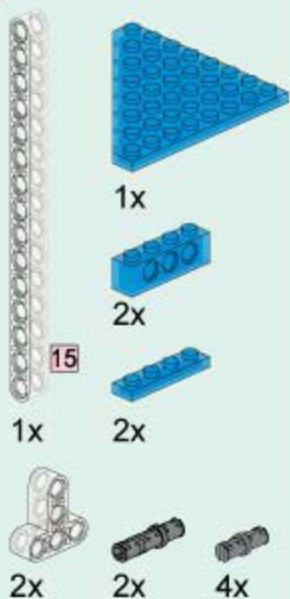

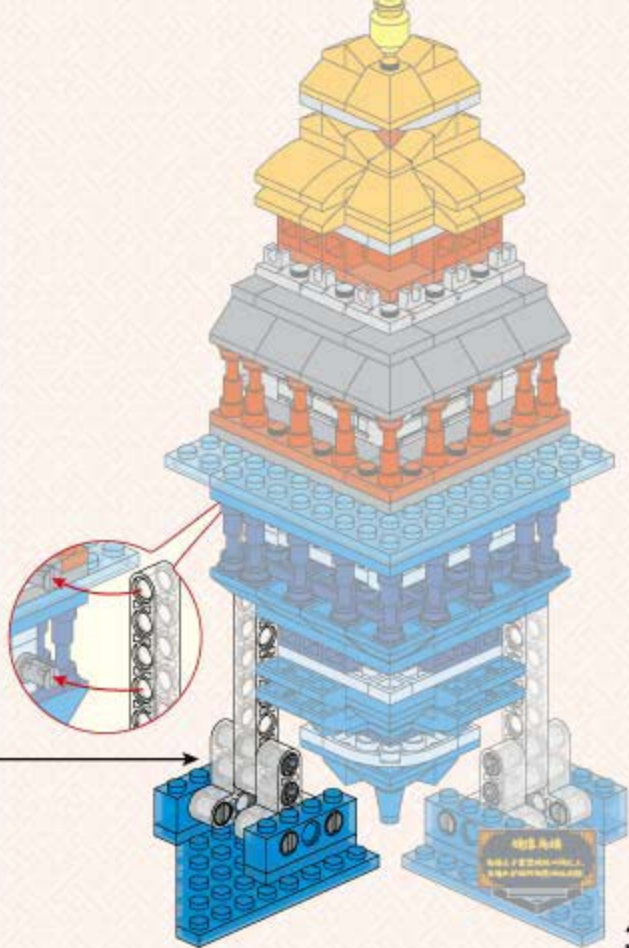
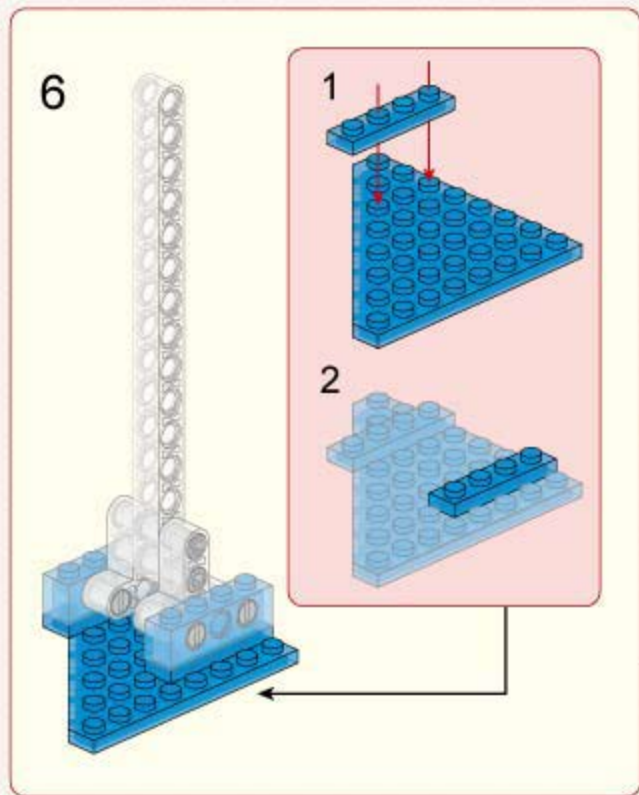

Keeppley 国玩系列



K10109 妙灵仙鹤



K10110 勤勉霸王



K10111 神威铜狮



K10113 四库全书



K10114 太和殿