

# 1415-5

## QMAN USER MANUAL

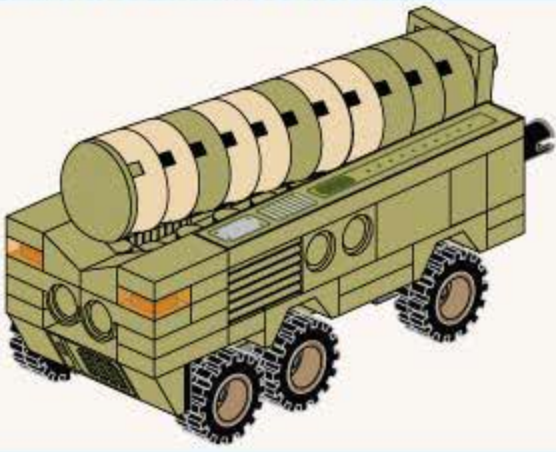

**1** 1x 2x

**2** 1x 1x

**3** 1x 1x

**4** 1x 2x

**5** 1x 1x 2x

**6** 1x 1x 2x

**7** 1x 2x 2x

**8** 1x 2x

**9** 1x 2x8 2x

**10** 1x 1x 4x 2x

**11** 2x 2x 2x

**12** 1x 2x 2x 2x

**13** 2x 1x8 2x

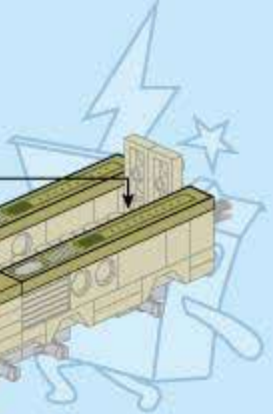

14 1x 2x

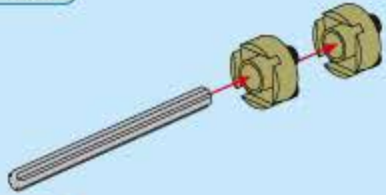

15 1x 1x



16 1x 1x

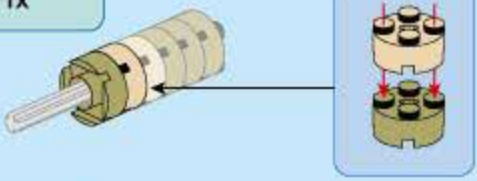

17 2x



18 1x 2x

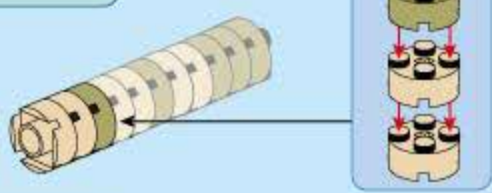

19 1x

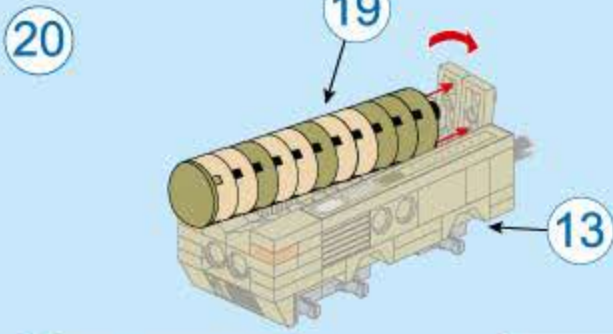
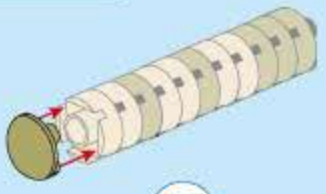

21 6x 6x

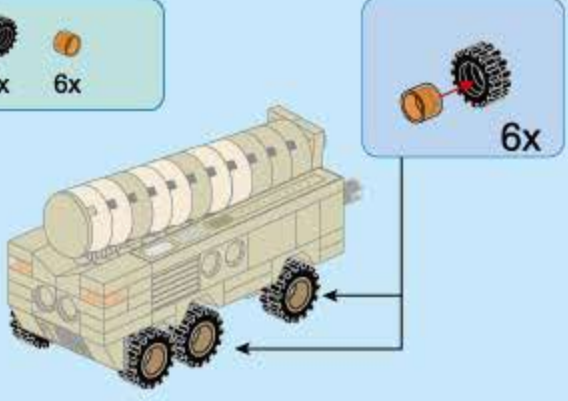

# 1415(8in1) QMAN USER MANUAL

