



2807

Ages: 6+

Minifigs: X3

PCS: 366

FIRE RESCUE



Internal Control Room



FIRE RESCUE

FIRE

2807

FIRE COMMAND TRUCK



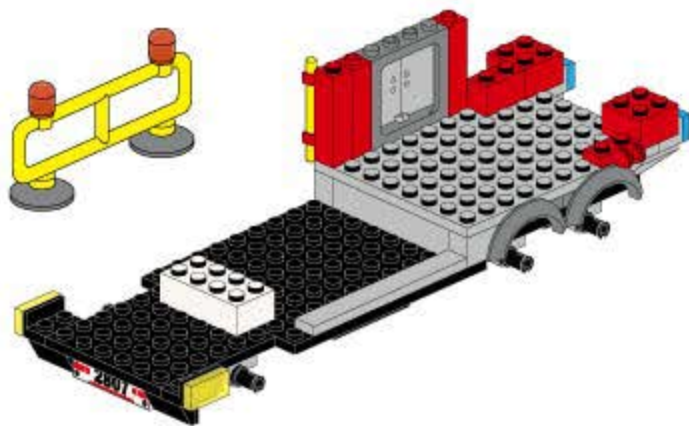

拆件器使用方法, 仅为示例

Usage of Brick Separator. Just for the sample

1

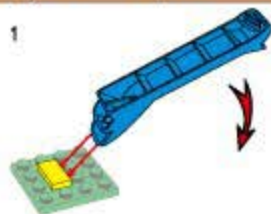

2



3

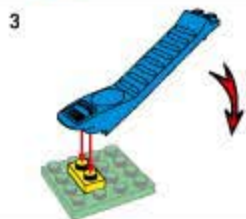

4

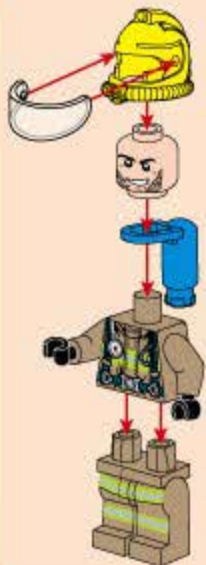
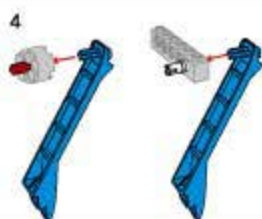

sketch map of fitting hand
或示意图

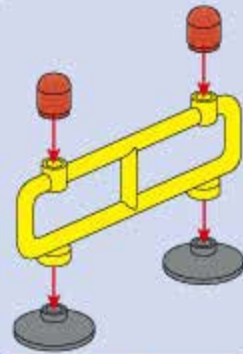

1

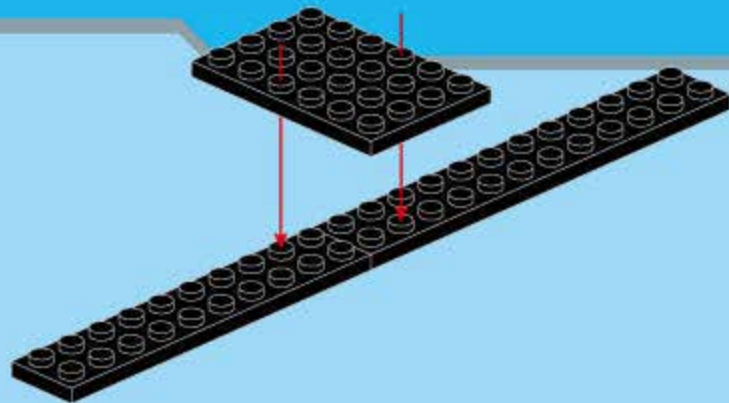
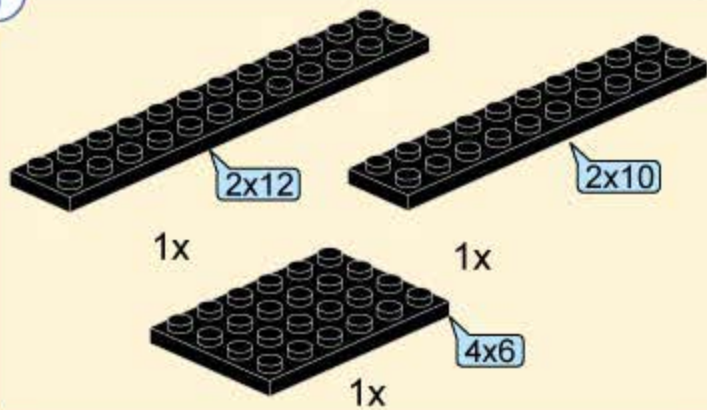

2

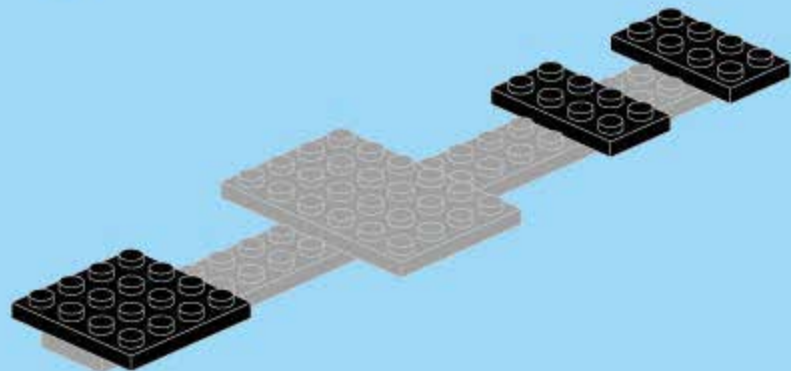
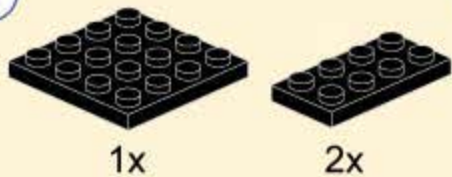

3

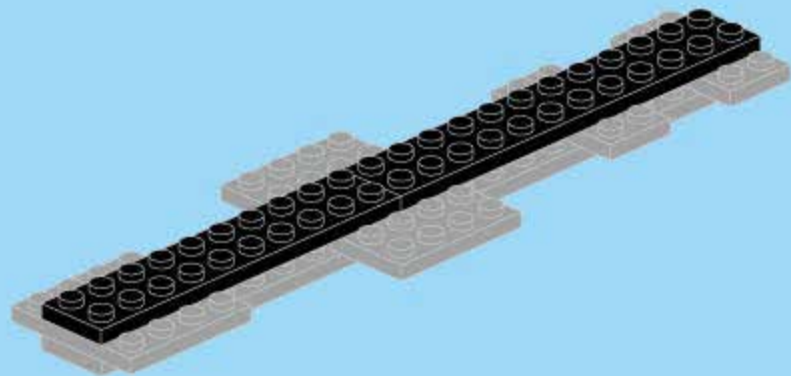
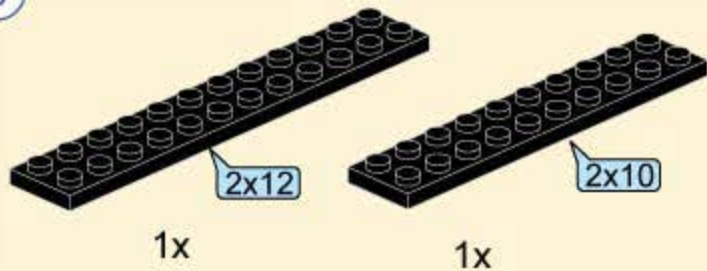

4

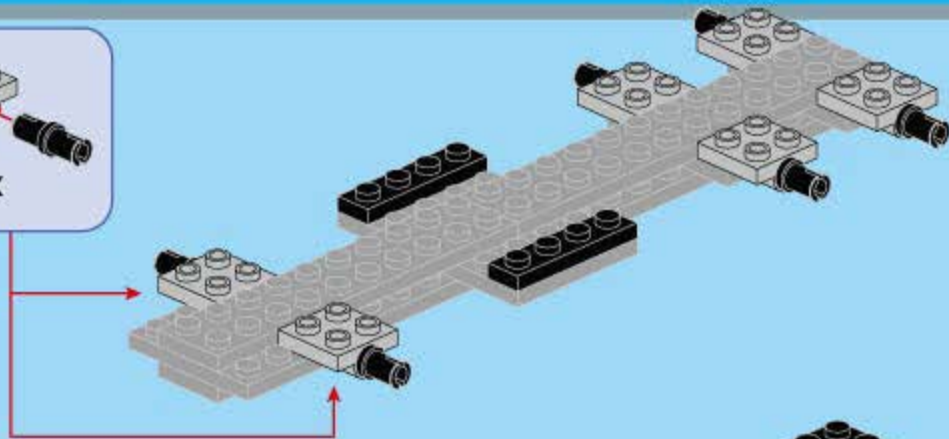
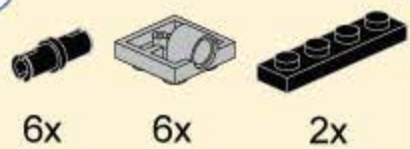

5

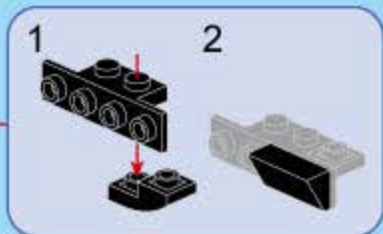
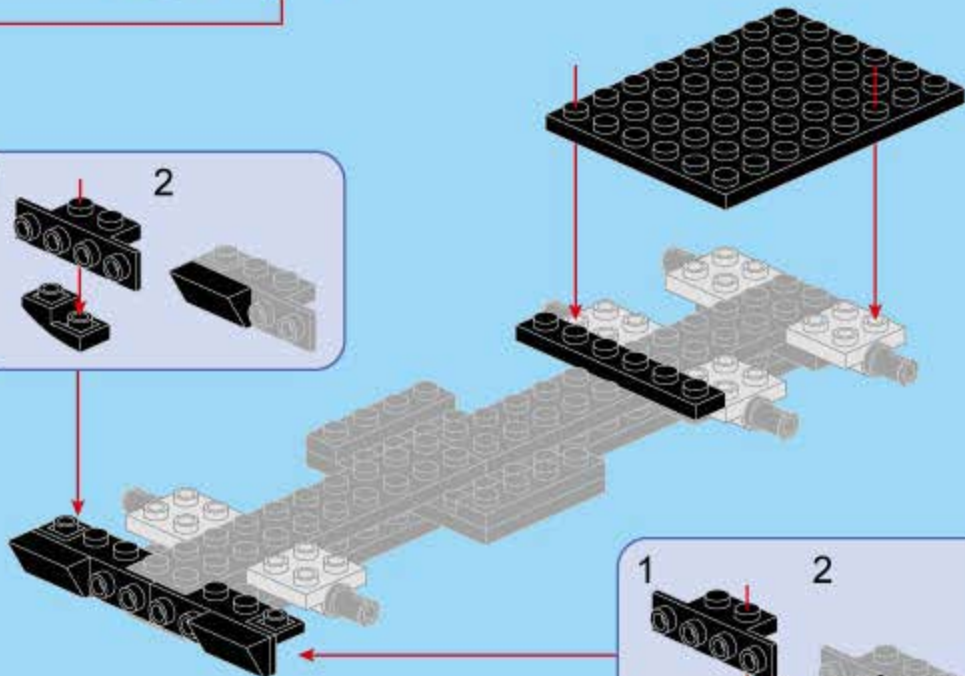
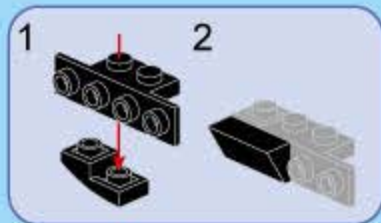
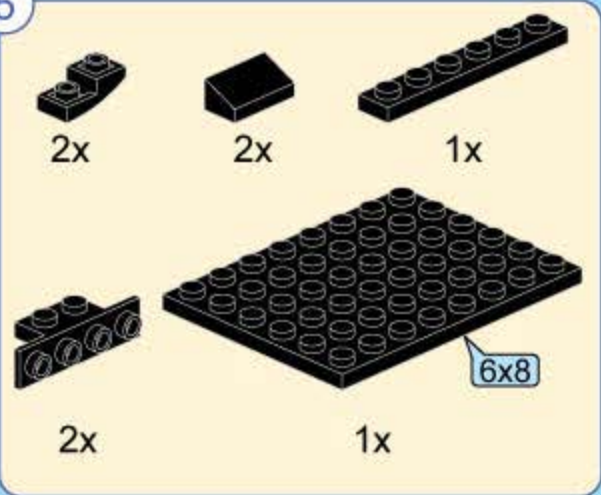

6

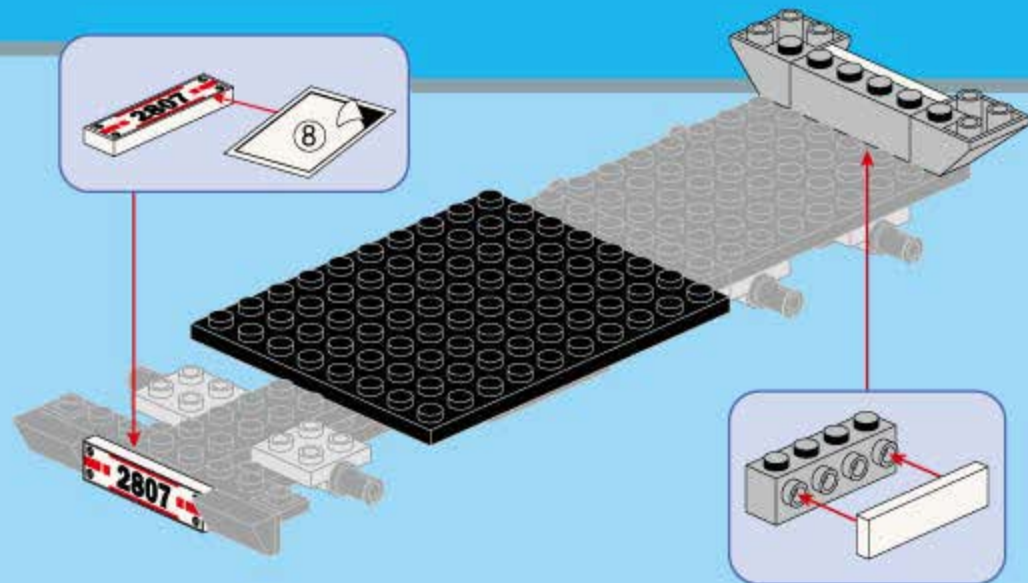
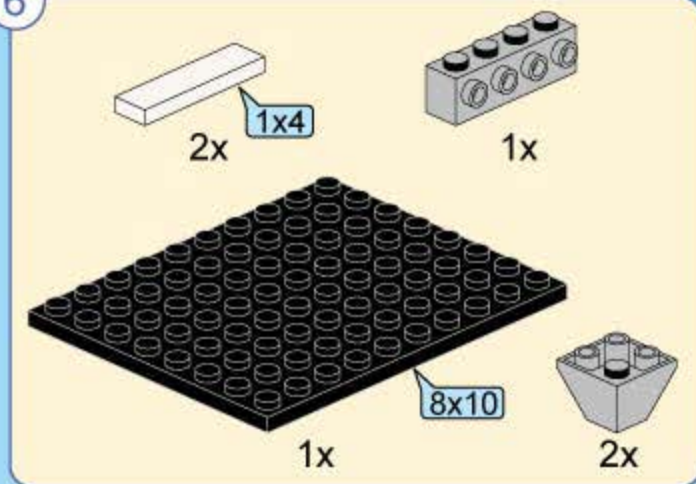

7

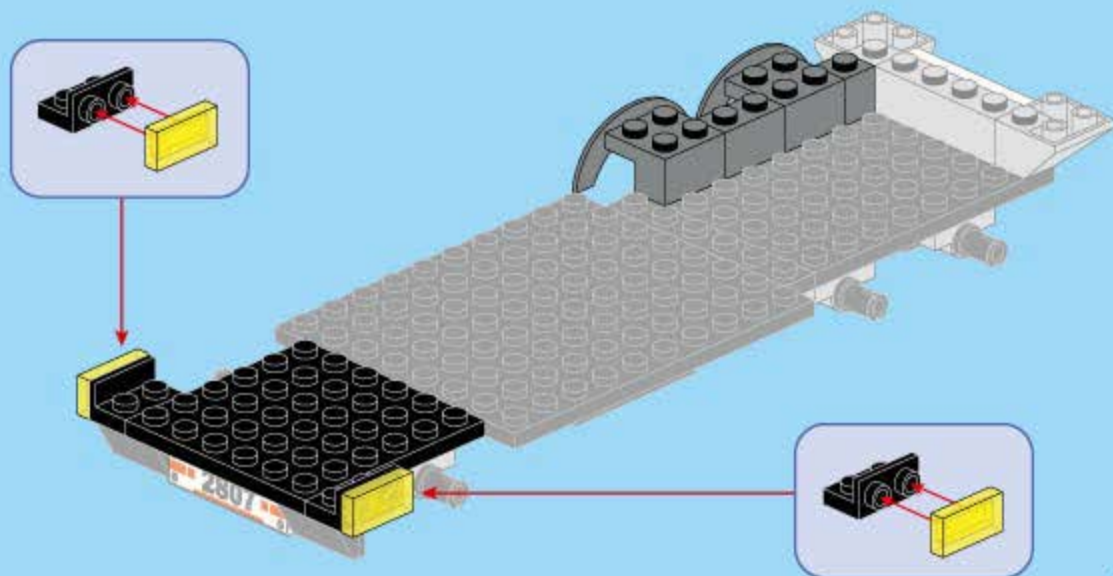
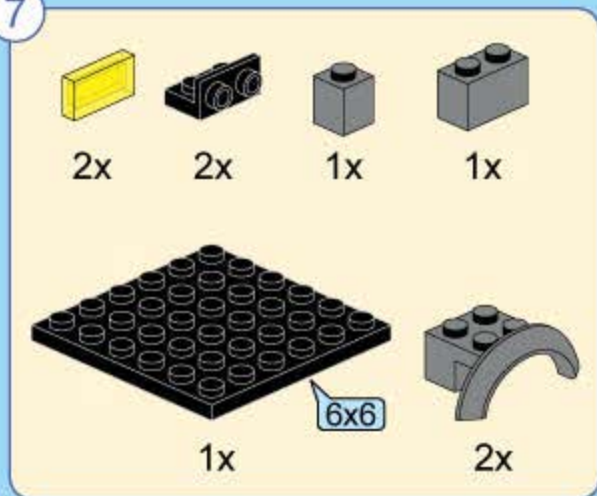

8

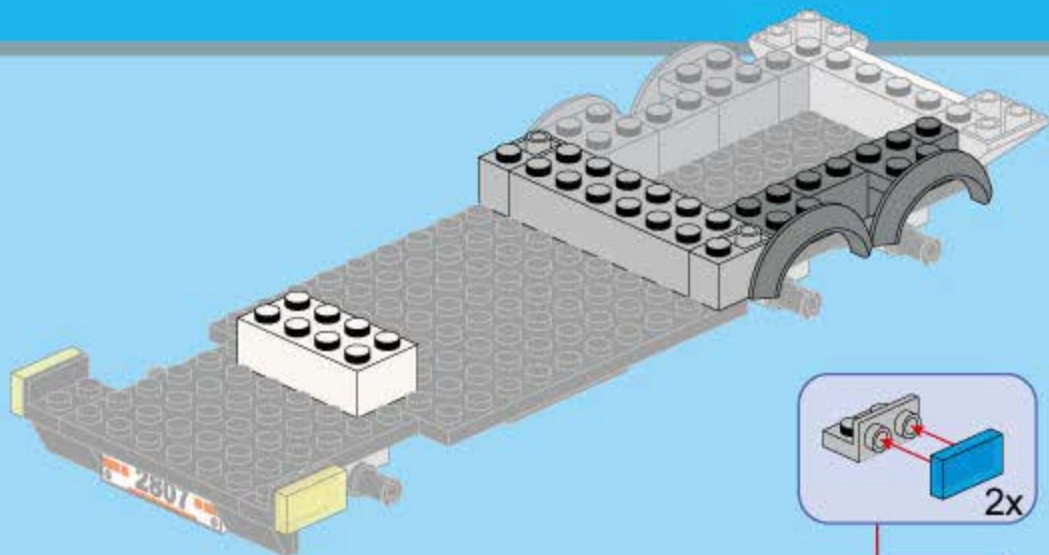
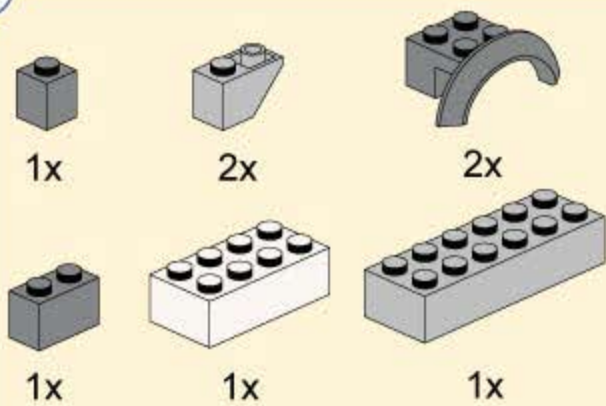

9

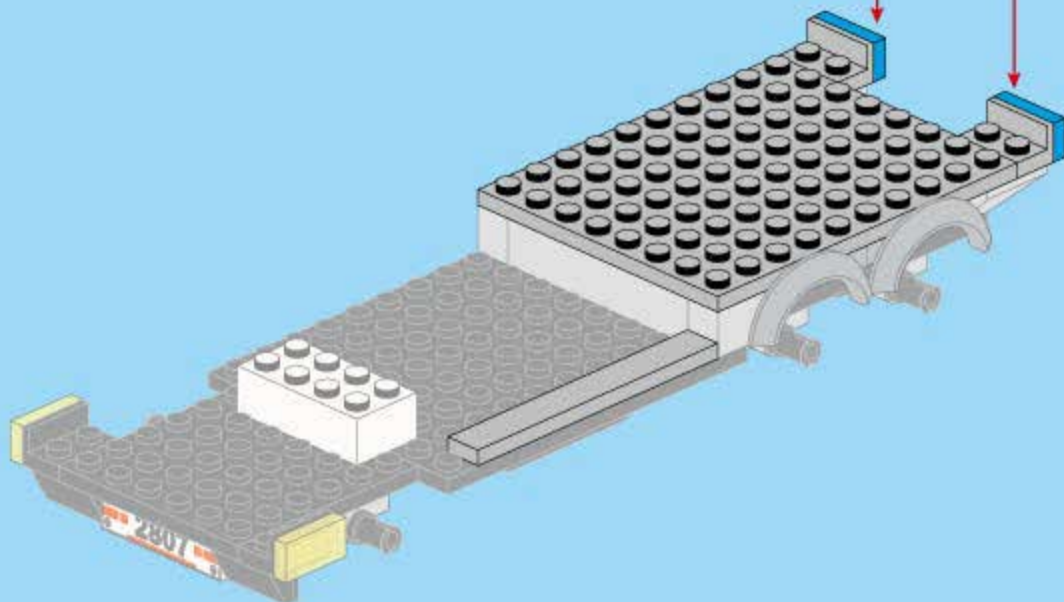
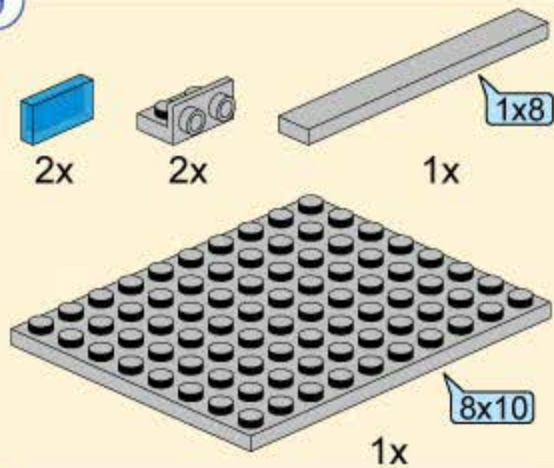

10

- 1x
- 1x
- 1x
- 2x
- 2x
- 2x
- 1x
- 1x

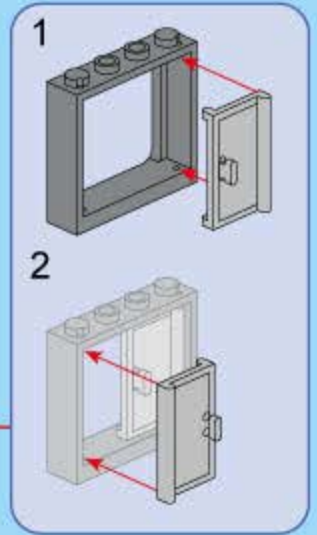
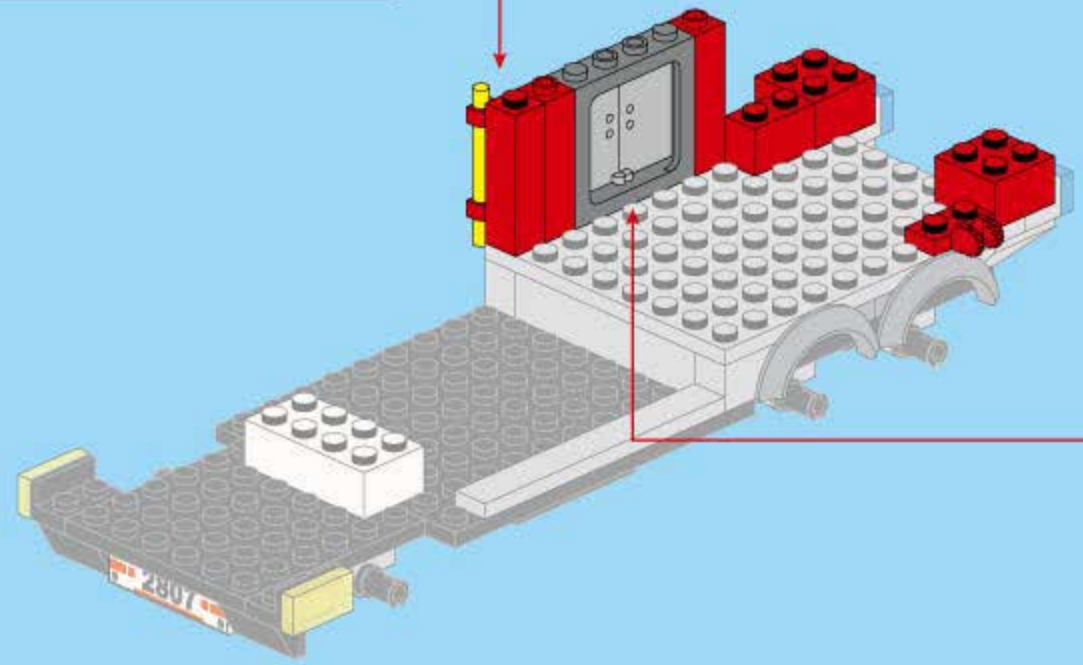
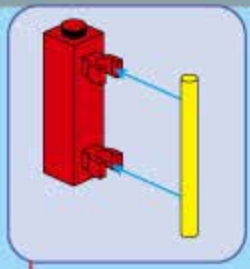

13



1x



1x



2x



1x



1x



1x



1x



1x



1x



1x

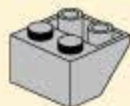

3x

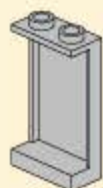

1x

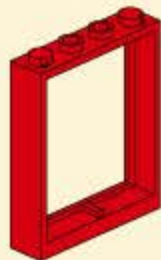

1x

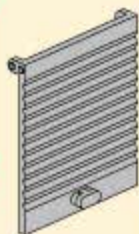

1x

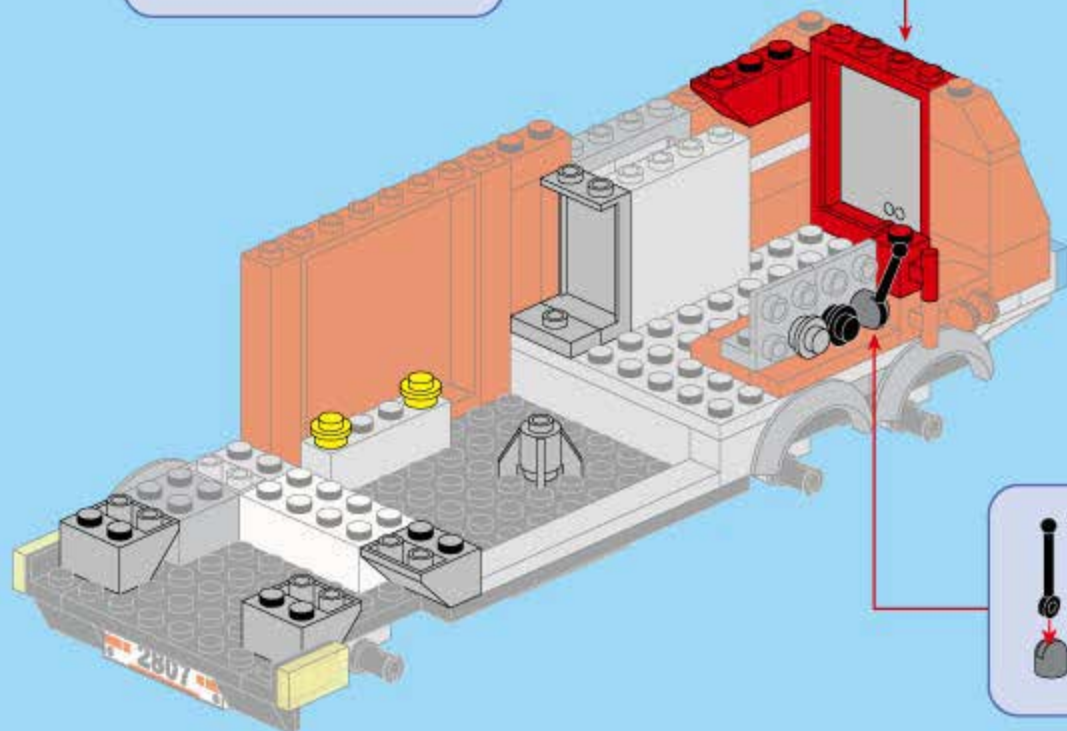
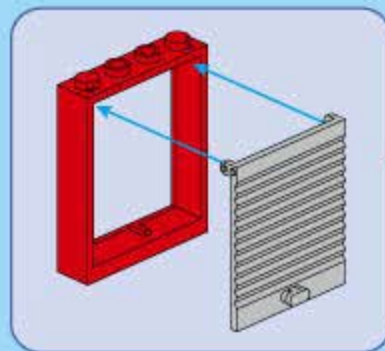

- 1x
- 1x
- 1x
- 1x
- 2x
- 2x
- 1x
- 1x
- 1x
- 1x
- 1x

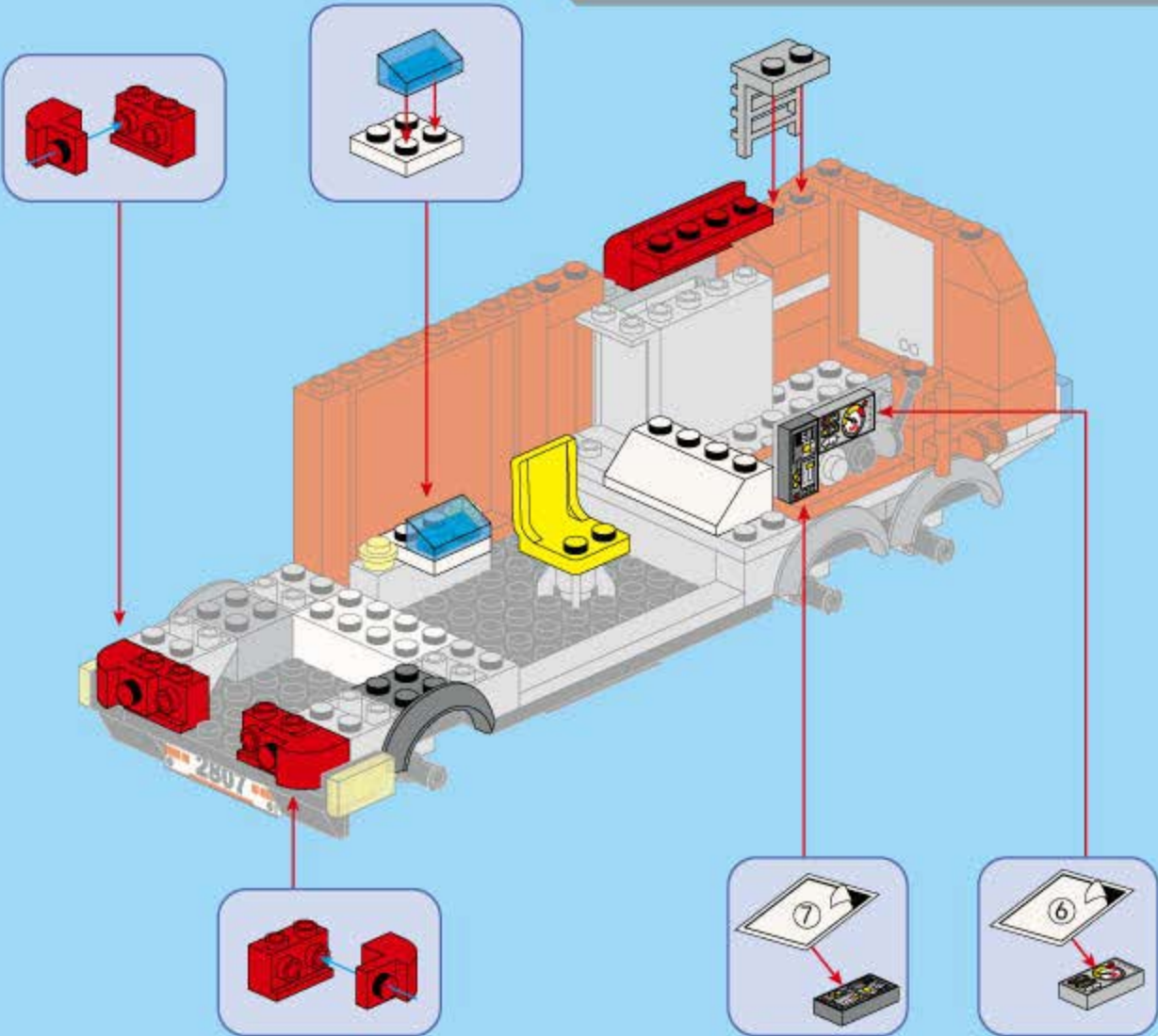

15

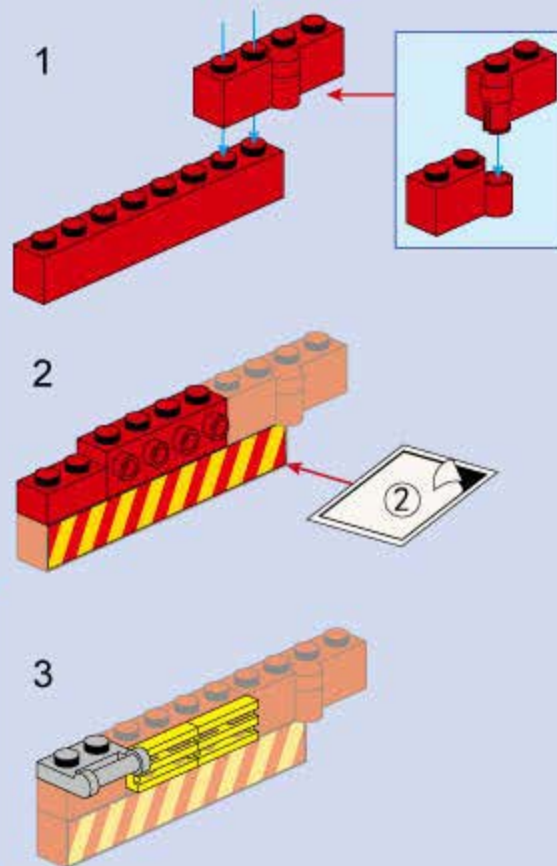
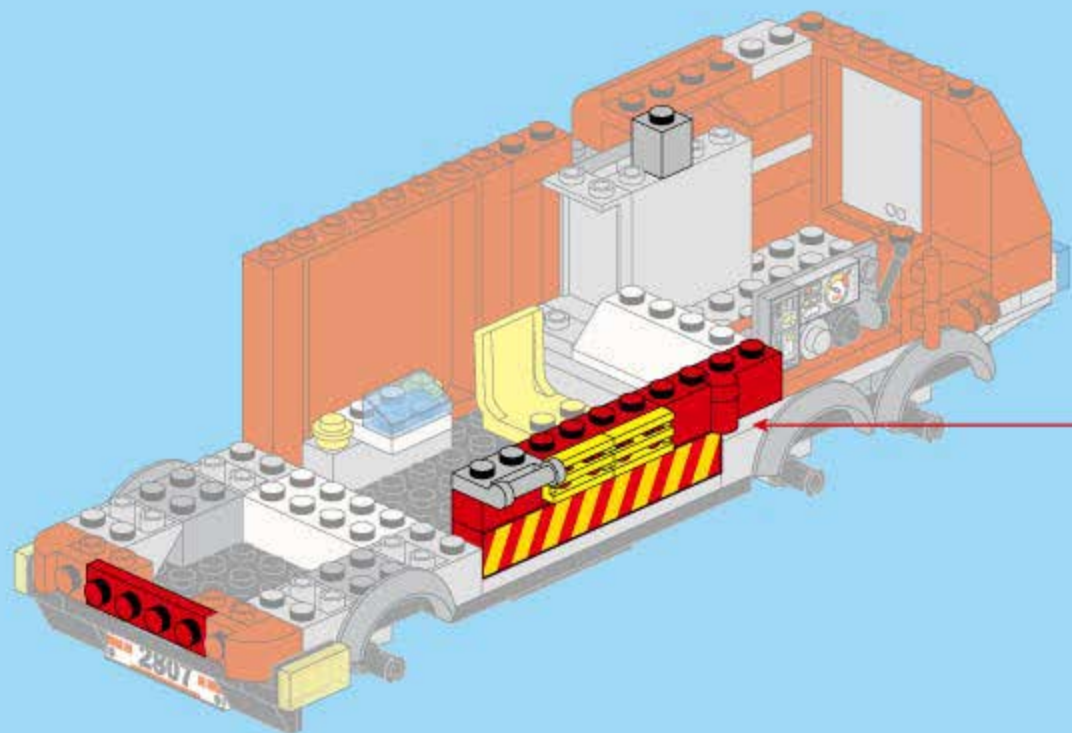
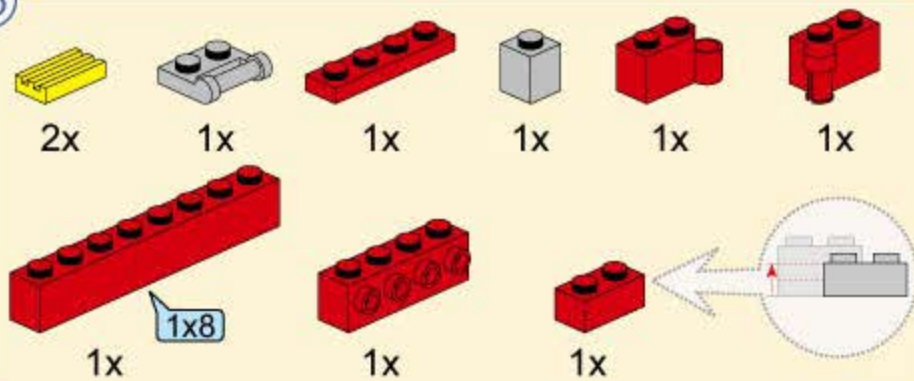

16



1x



1x



1x

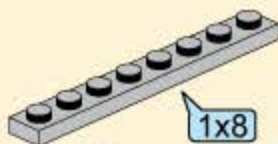

1x8

1x

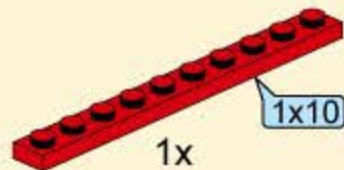

1x

1x10

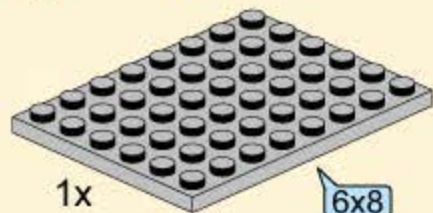

1x

6x8

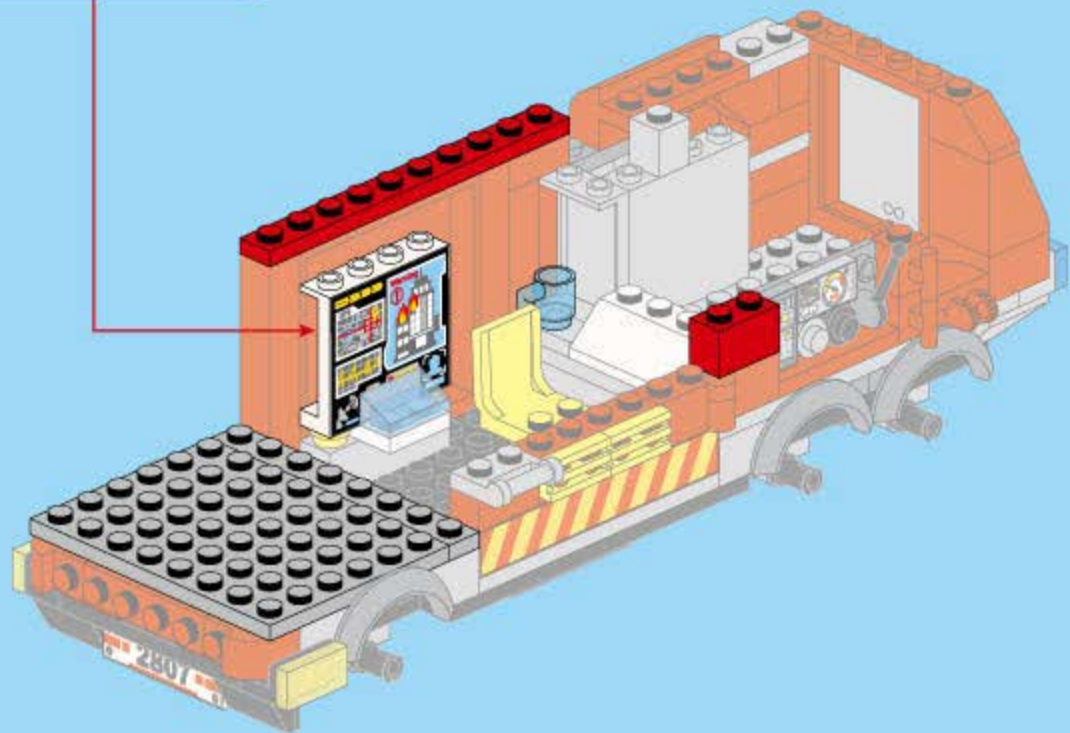

17



1x



1x



1x



1x



1x



1x

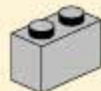

1x



1x



1x

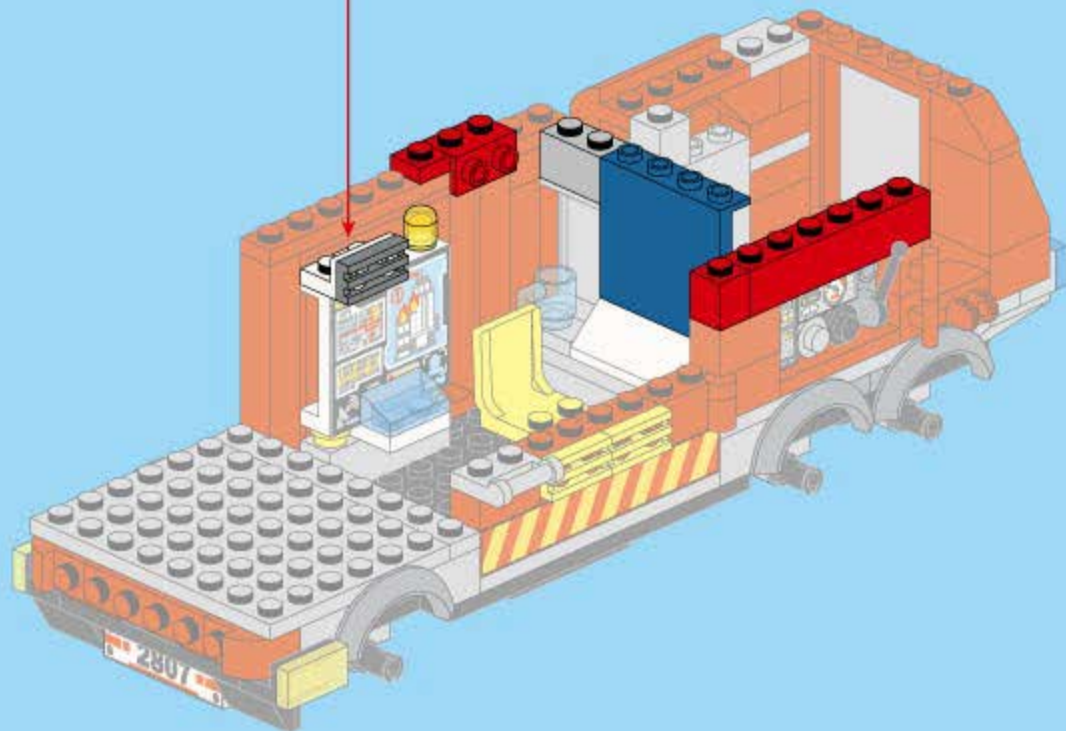
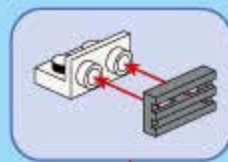

18

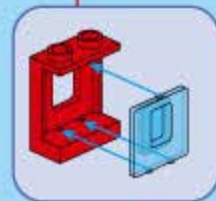
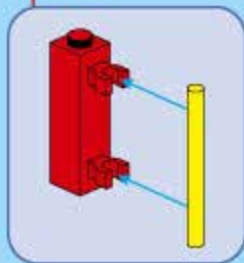
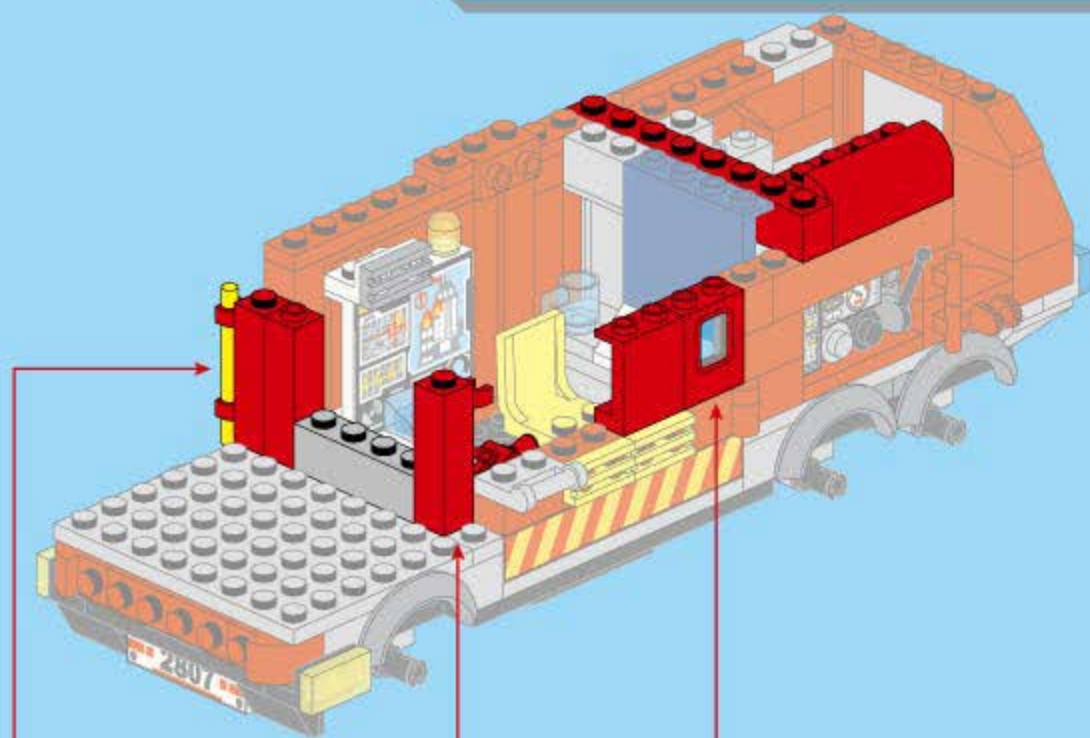
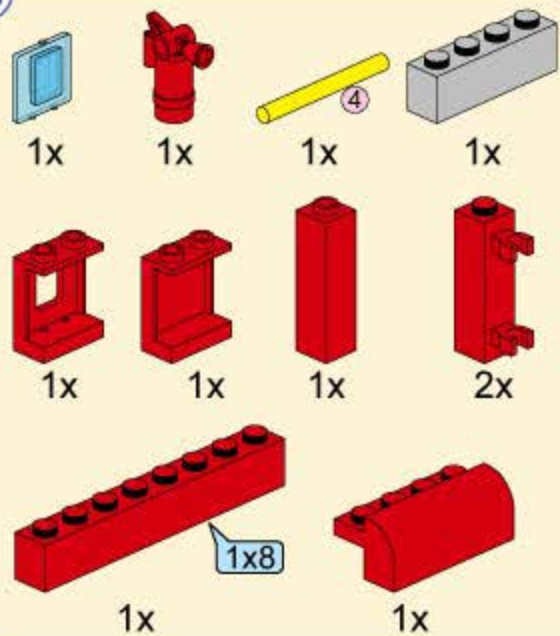

19



1x



1x



2x



1x



2x



1x

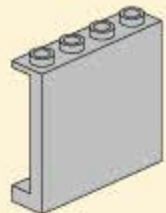

1x

1

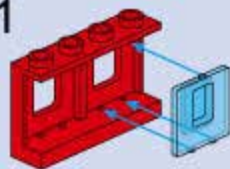

2

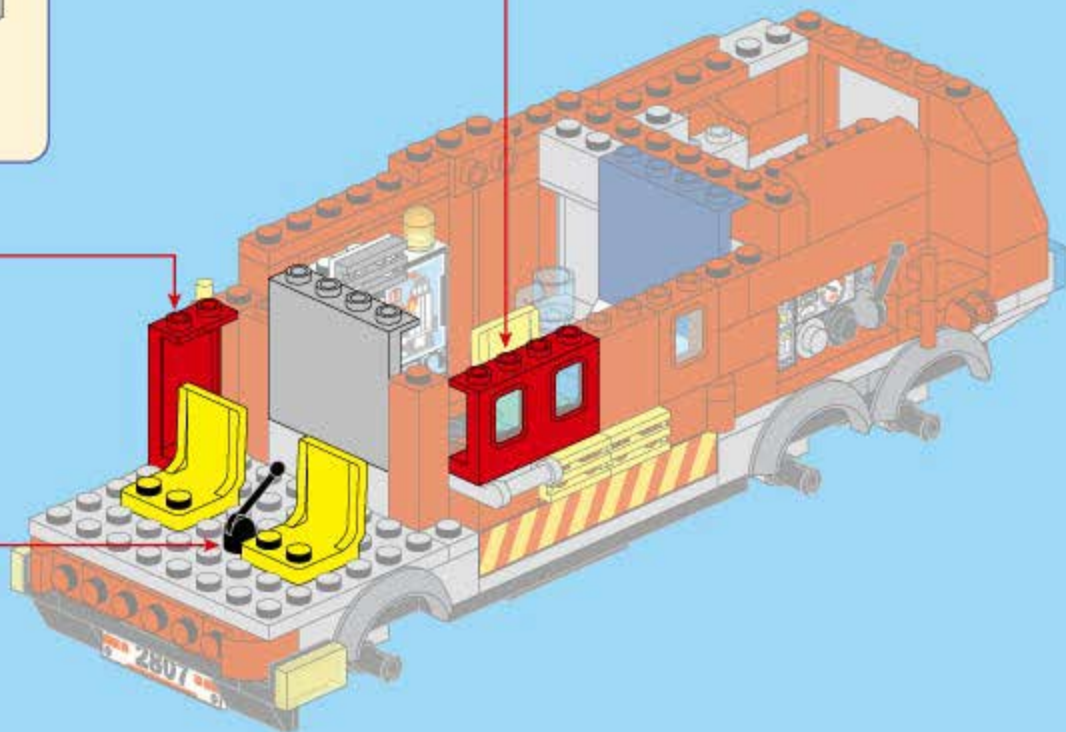
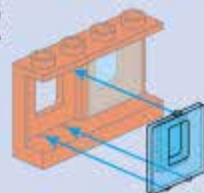



20



2x



1x



1x



1x



1x



1x

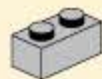

1x

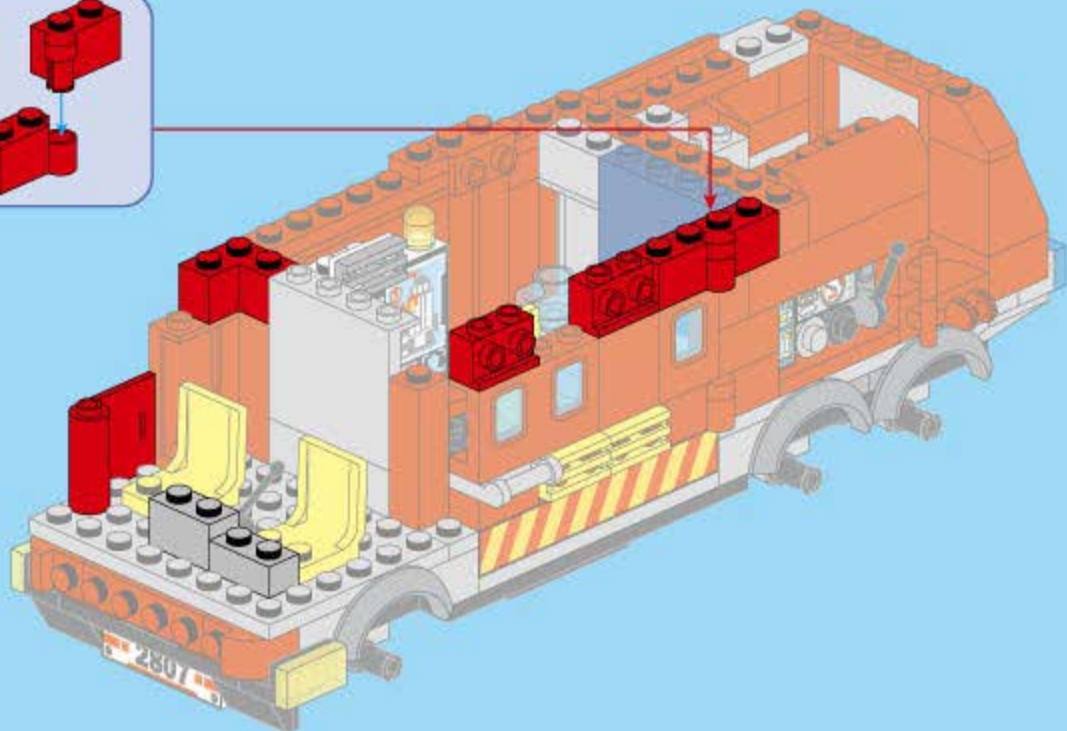
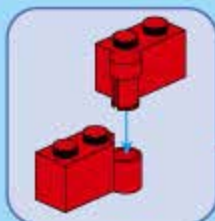
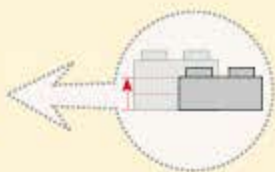

21



1x



1x



1x



1x



2x

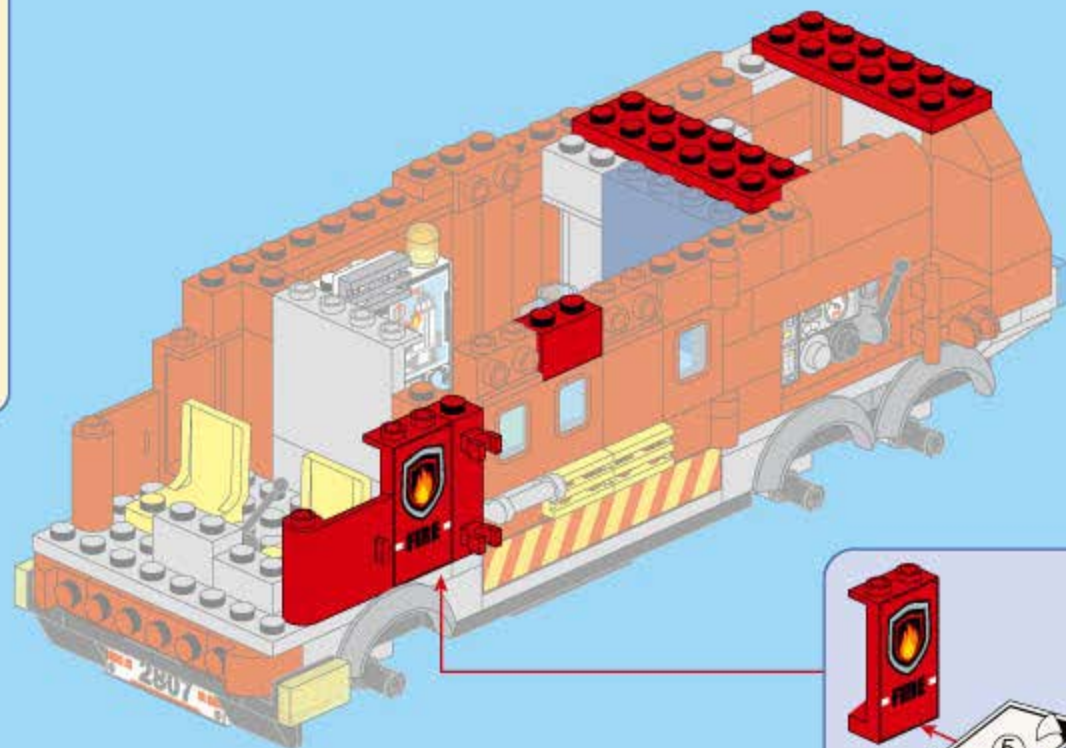

22



1x



2x



1x



1x

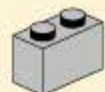

1x



1x

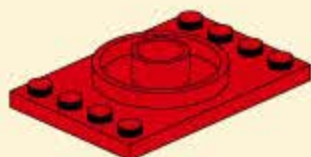

1x

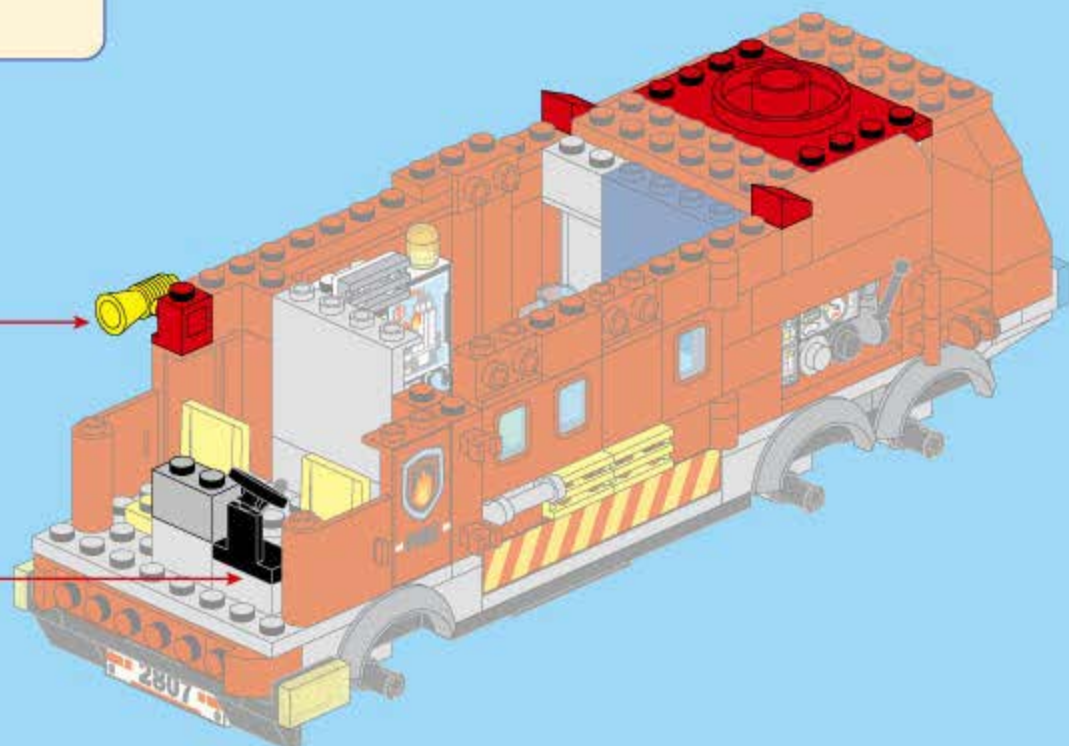

24



1x



1x



2x



1x



1x

1x8



1x

1x8

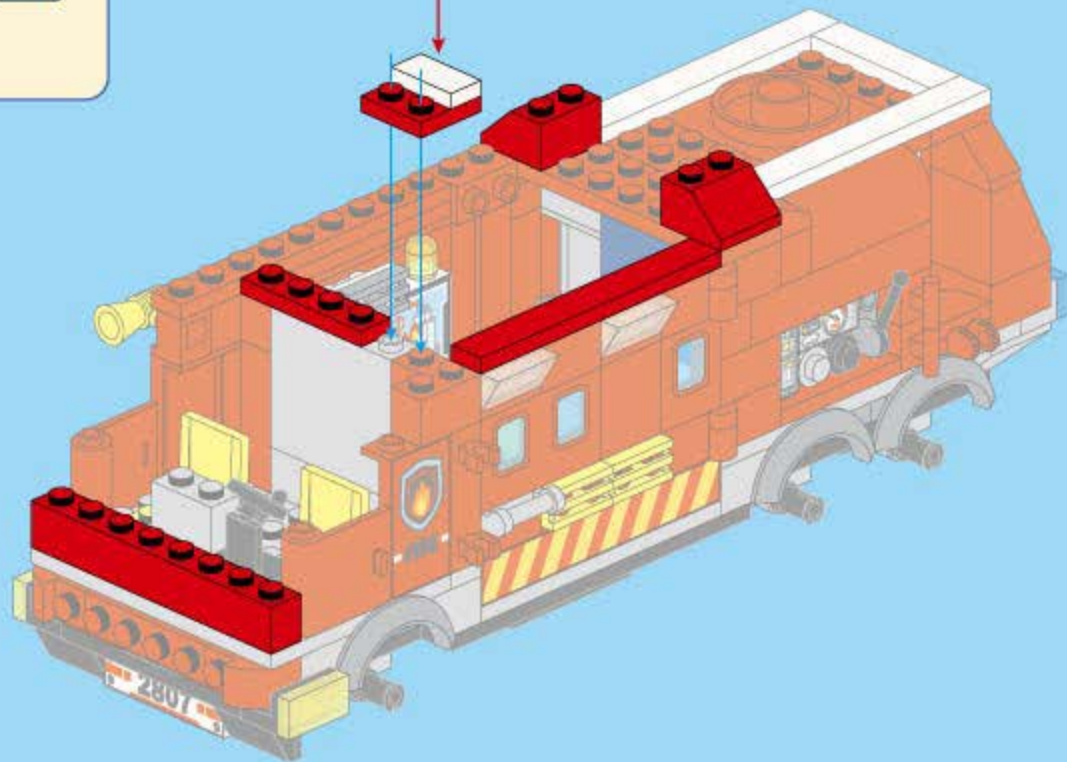

25



1x



1x



1x



2x

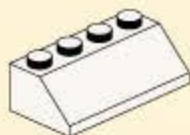

1x

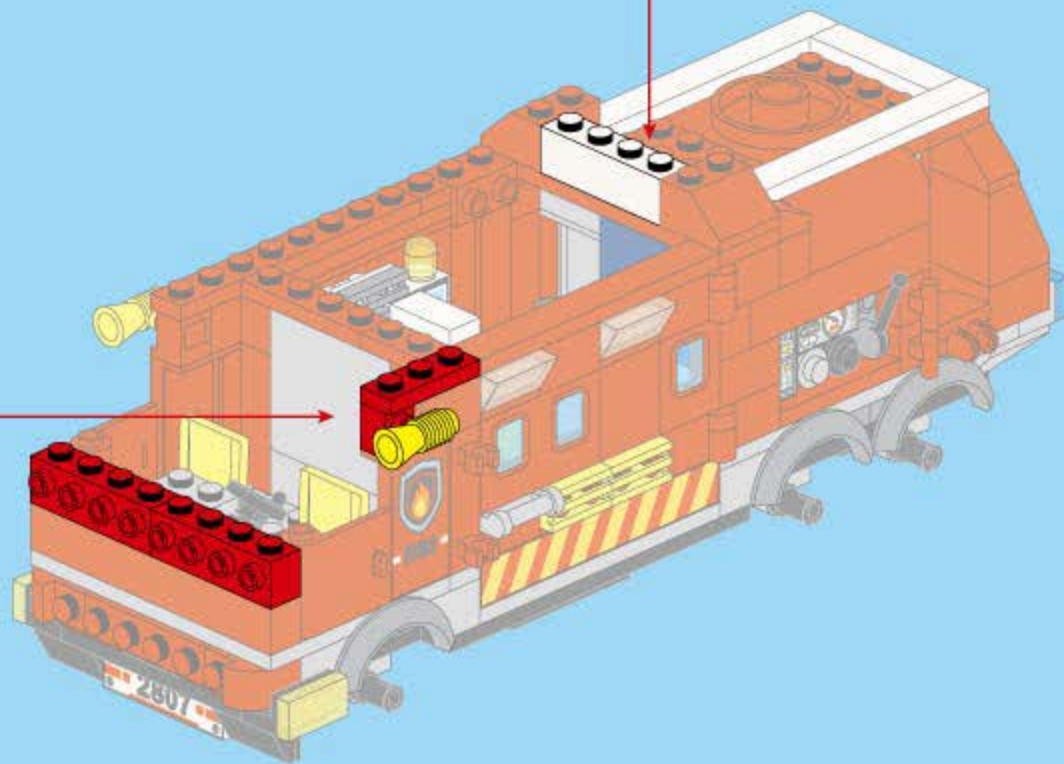
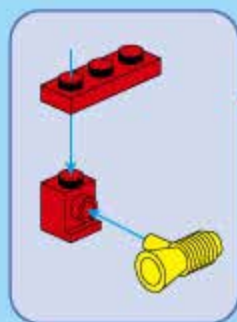
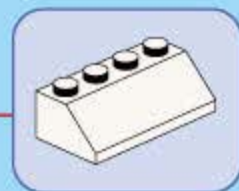

26

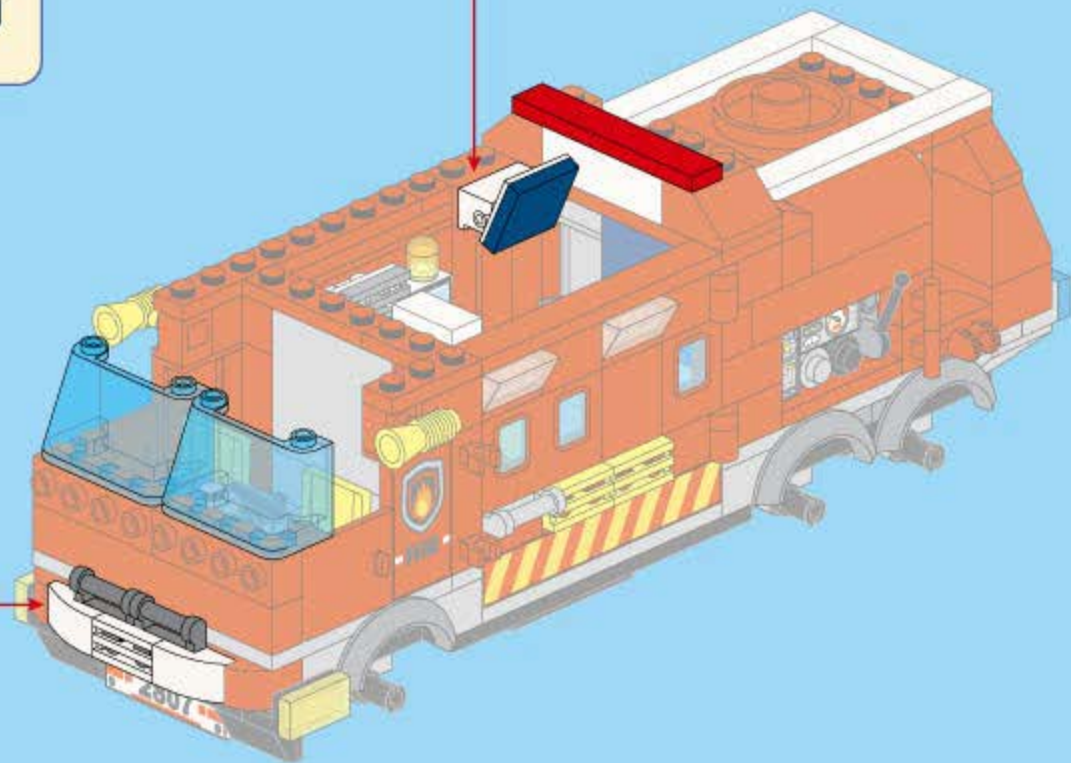
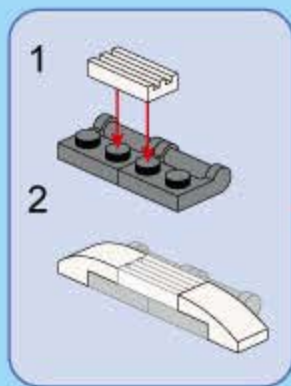
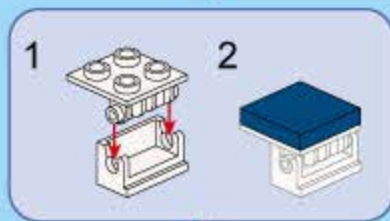
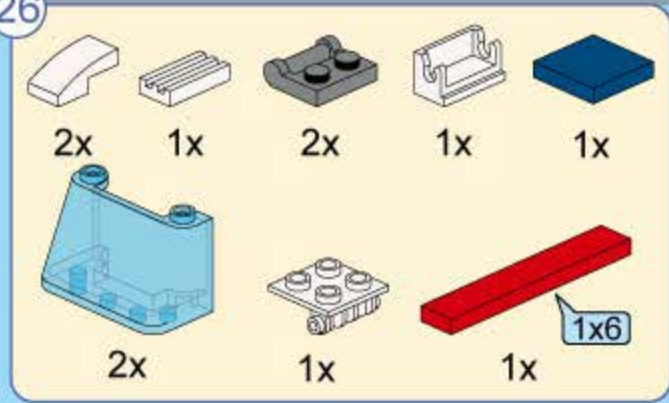

27



2x

4x

2x

1x



2x

1x

1x



1x



2x



1x



4x

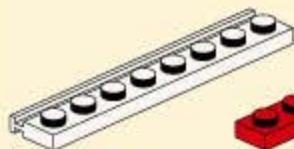

2x

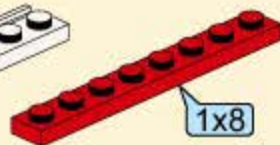

1x8

1x

1

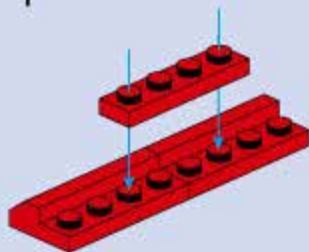

2

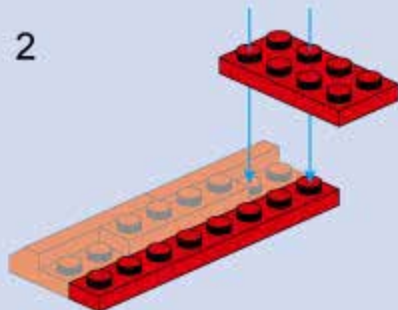

3

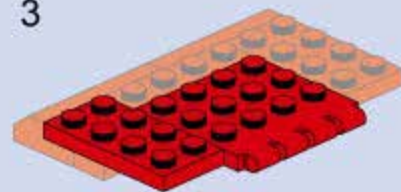

4

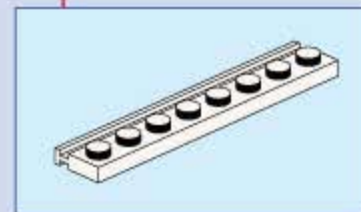
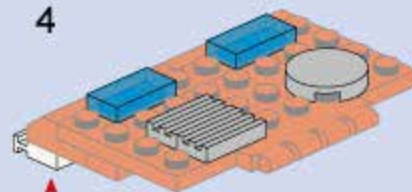

5

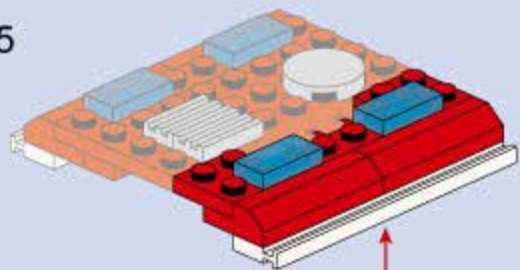

1

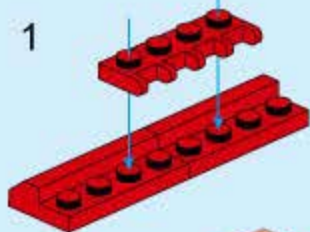

2

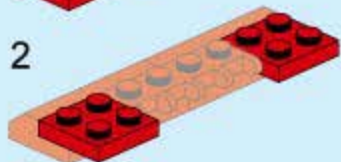

3

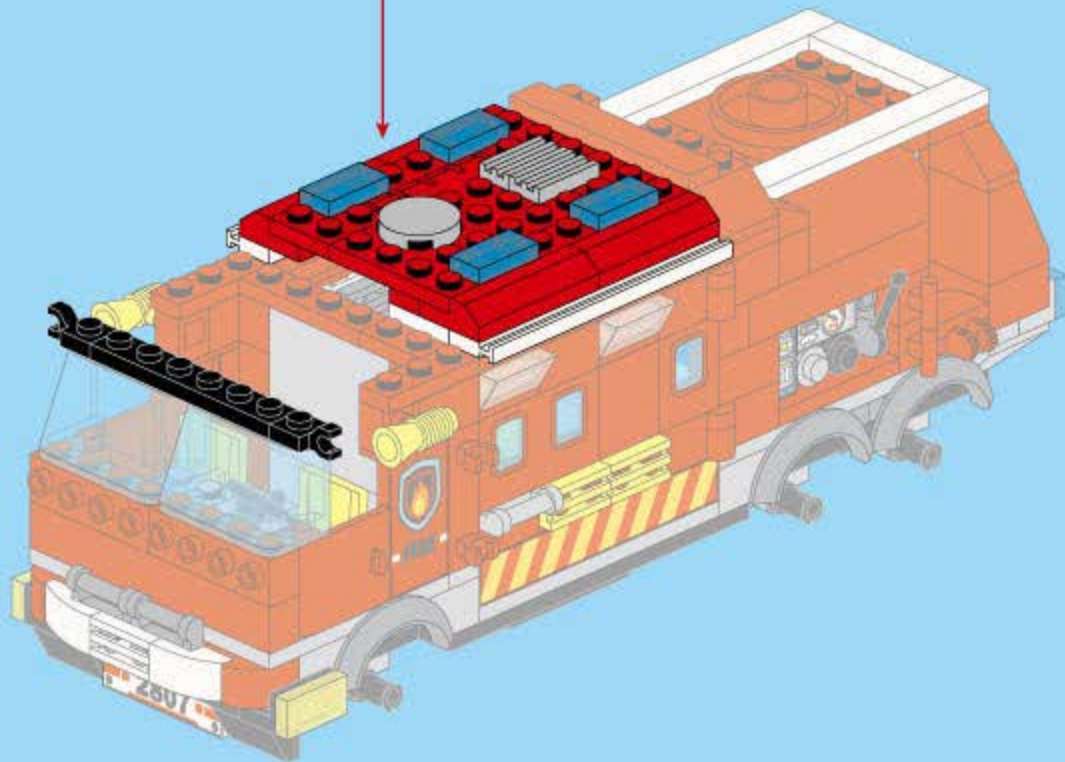
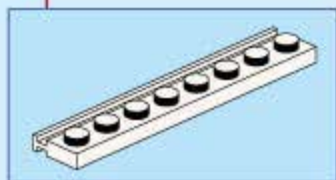
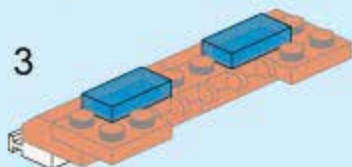

28



3x



2x



1x6

1x



1x

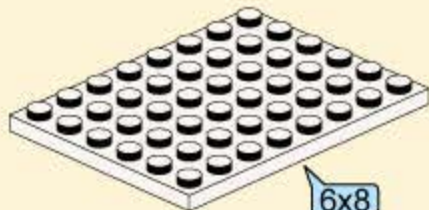

6x8

1x

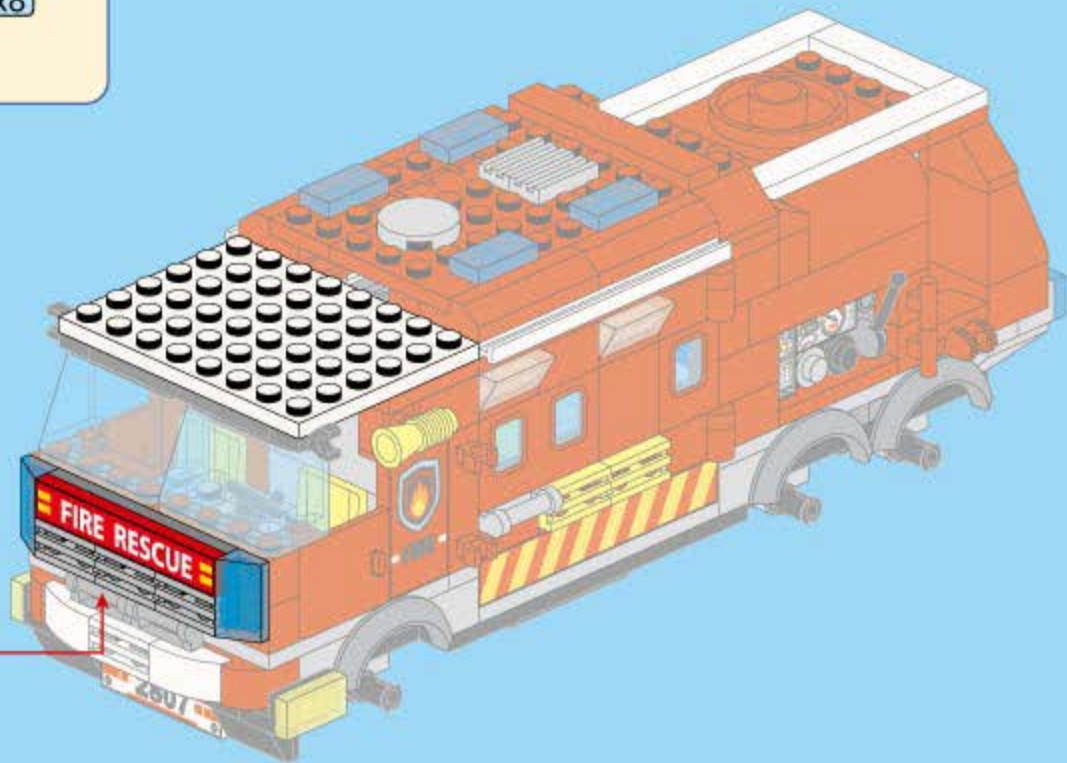
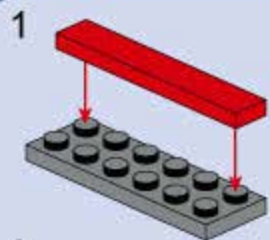

29



4x



2x



2x

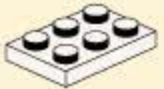

2x

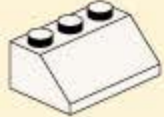

2x

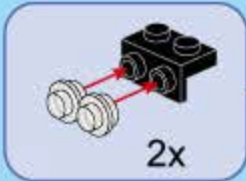

2x

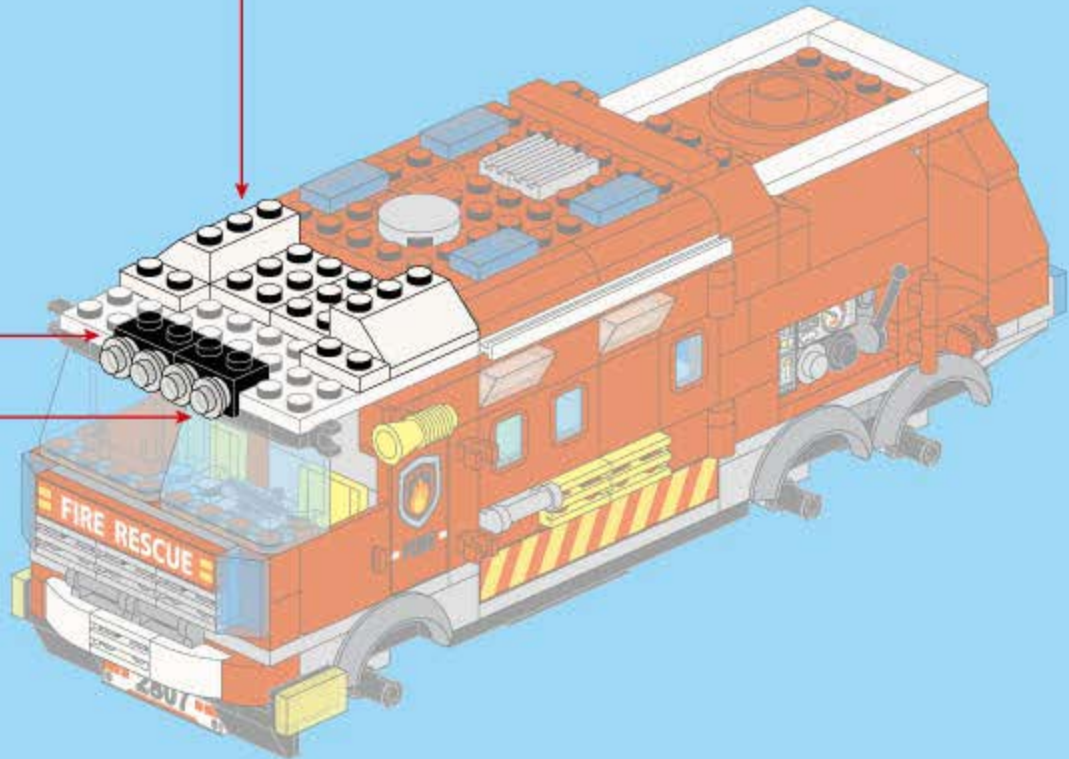

30

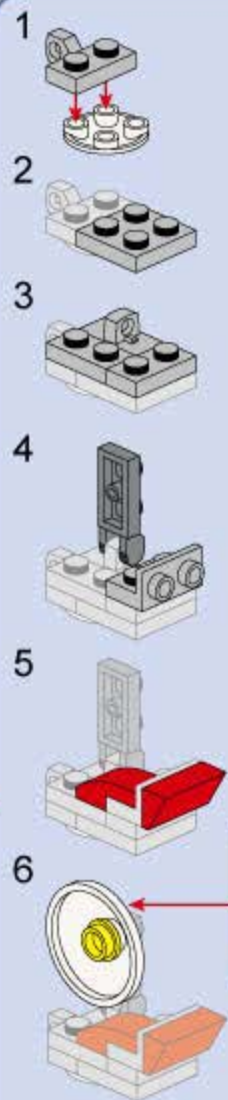
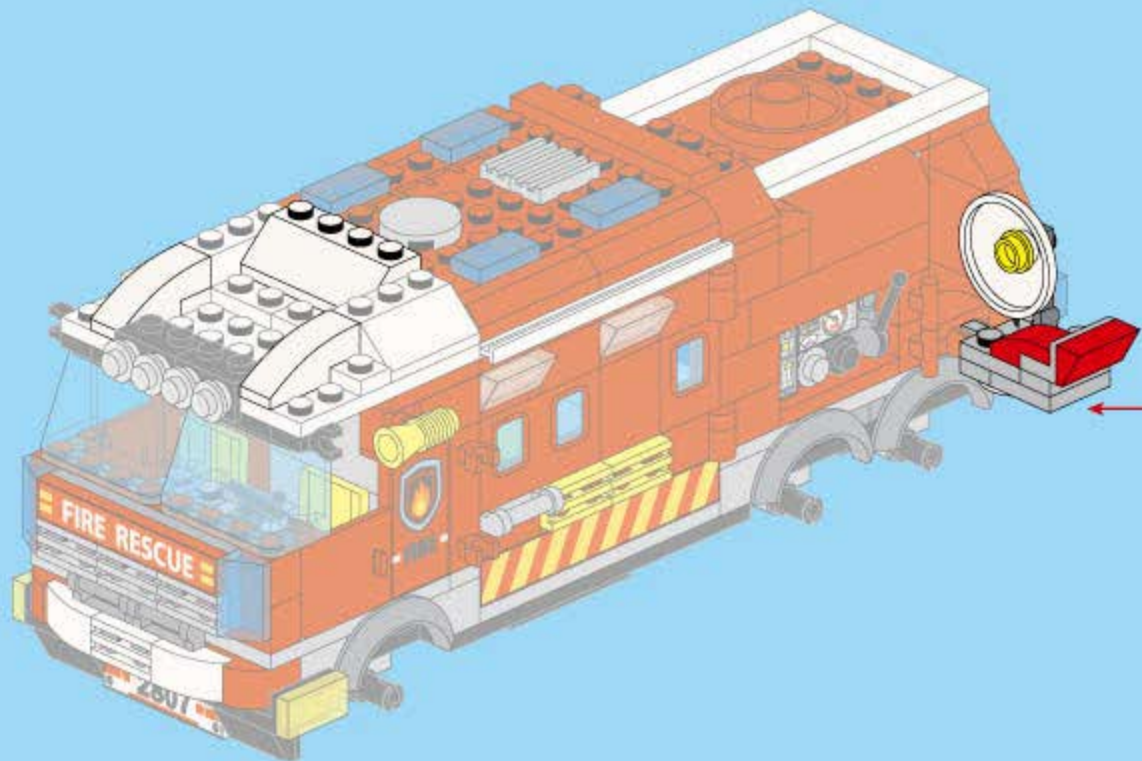
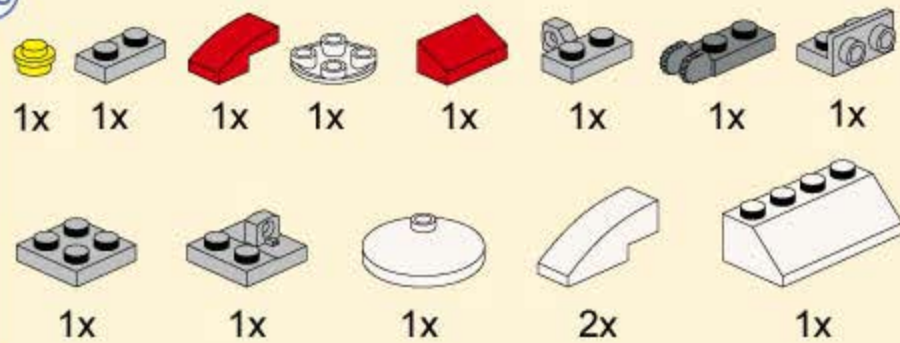

31



2x

2x

2x

2x



1x4

1x



1x

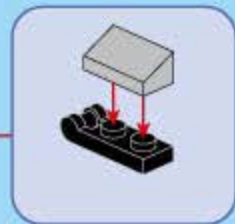
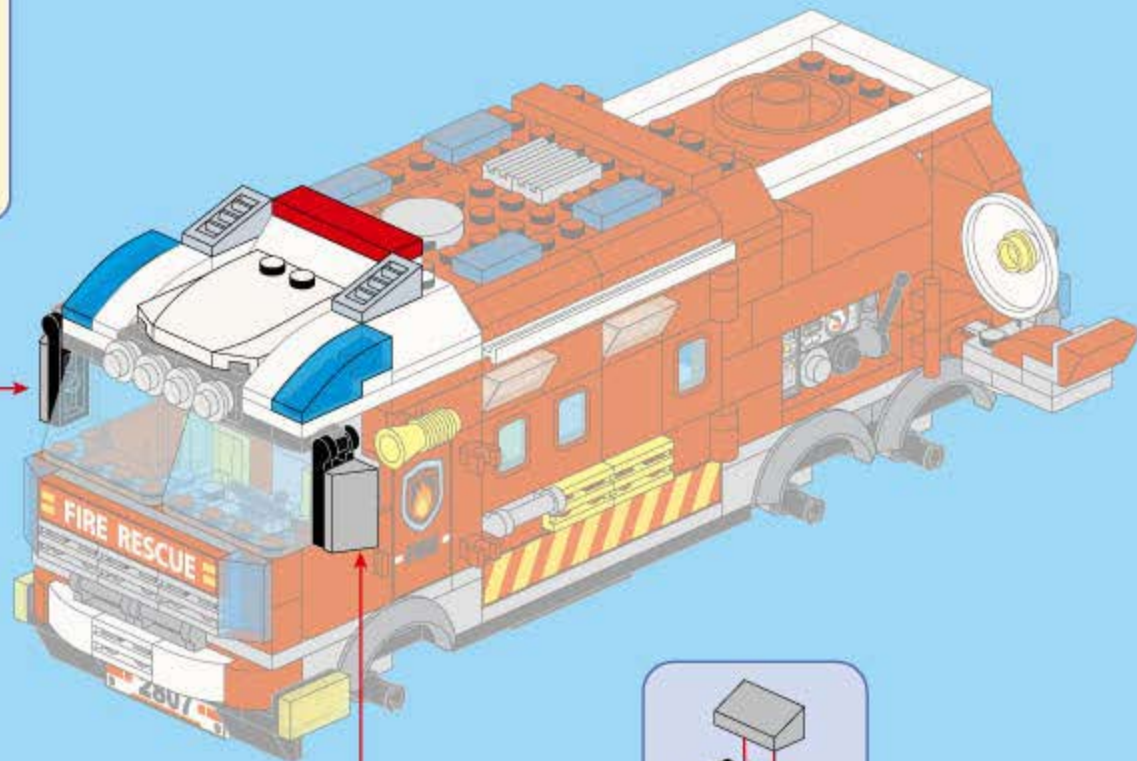
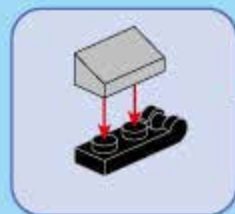

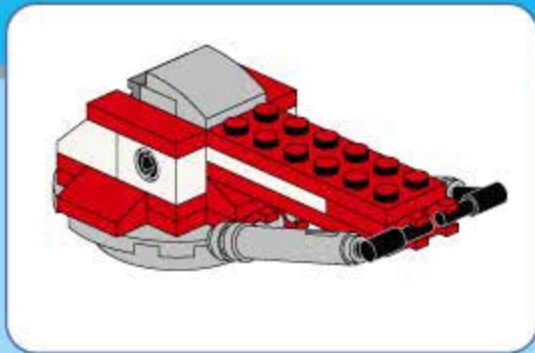

32

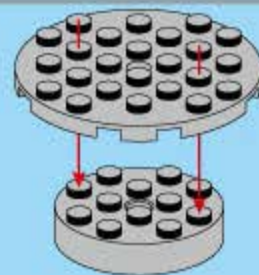
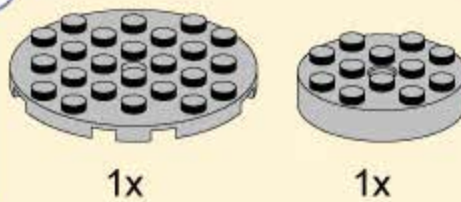

33

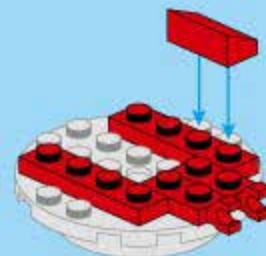
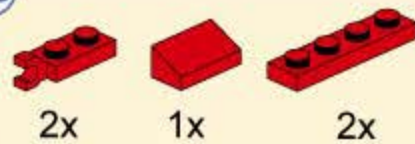

34

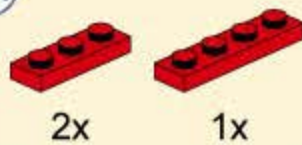

35



2x



2x



36



2x



1x



2x



37



2x

1x3



2x



2x

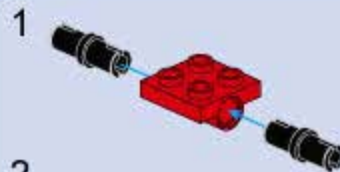
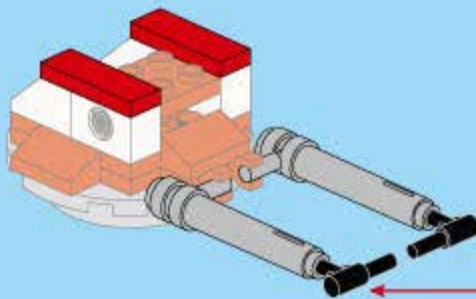

1

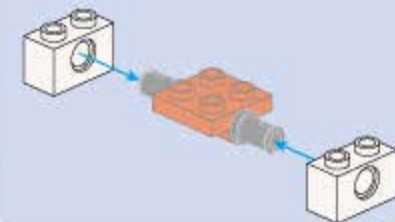

2

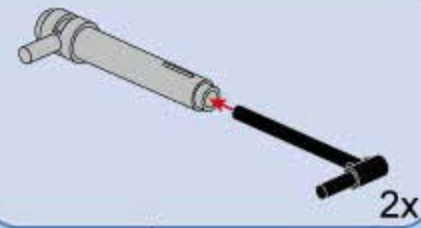

2x

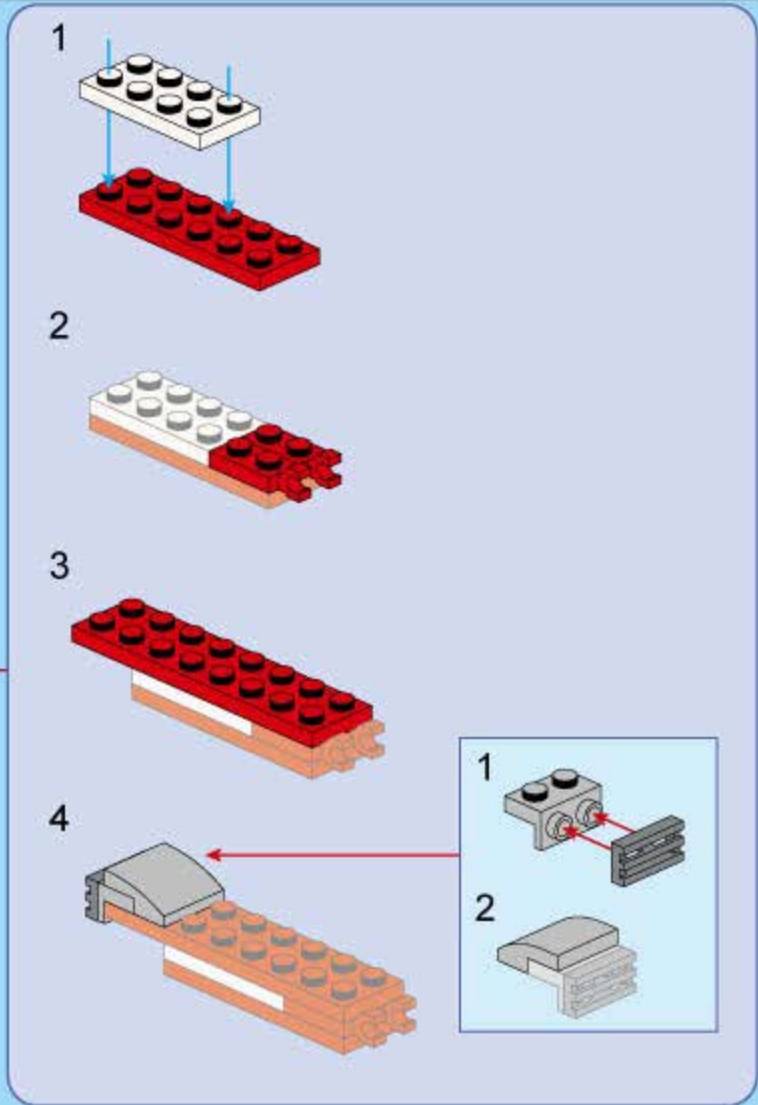
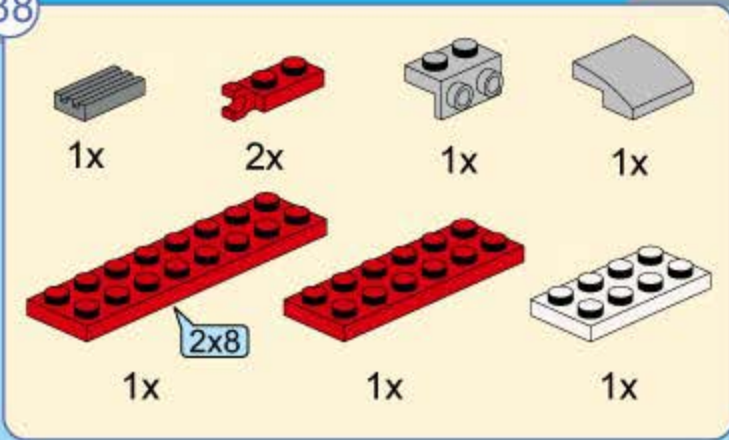

39

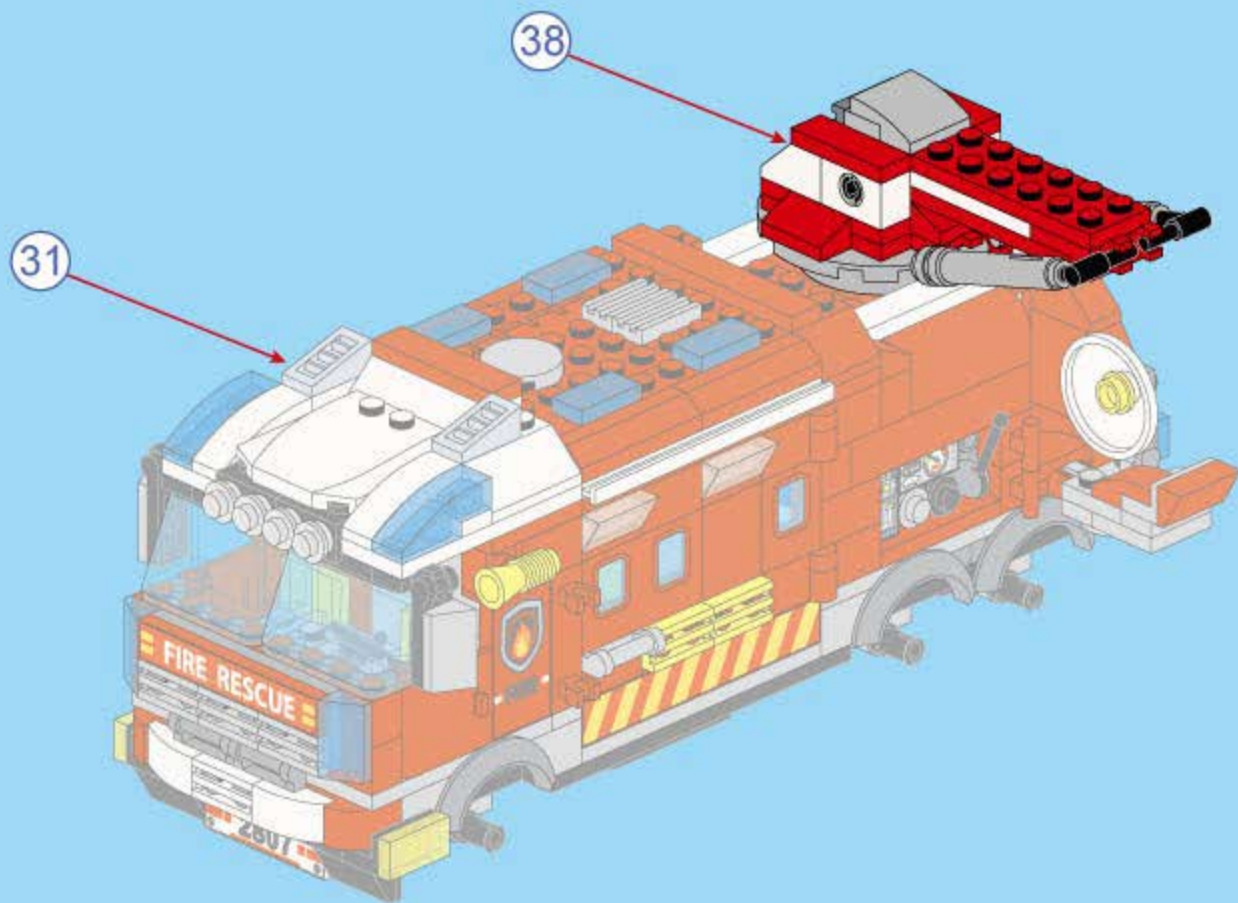

40

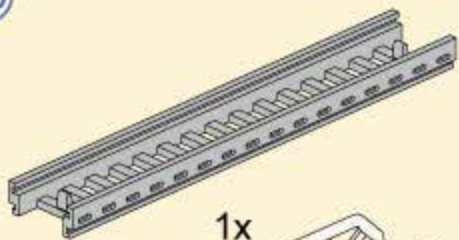

1x

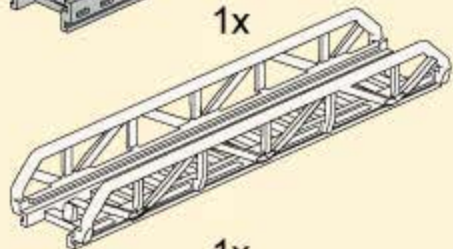

1x

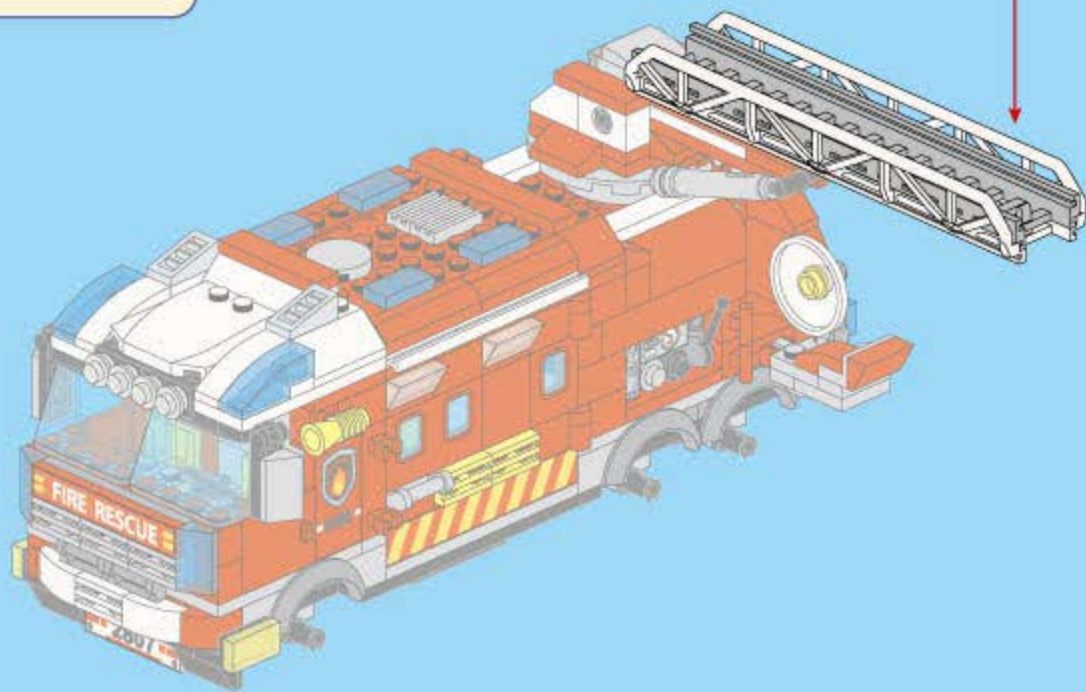
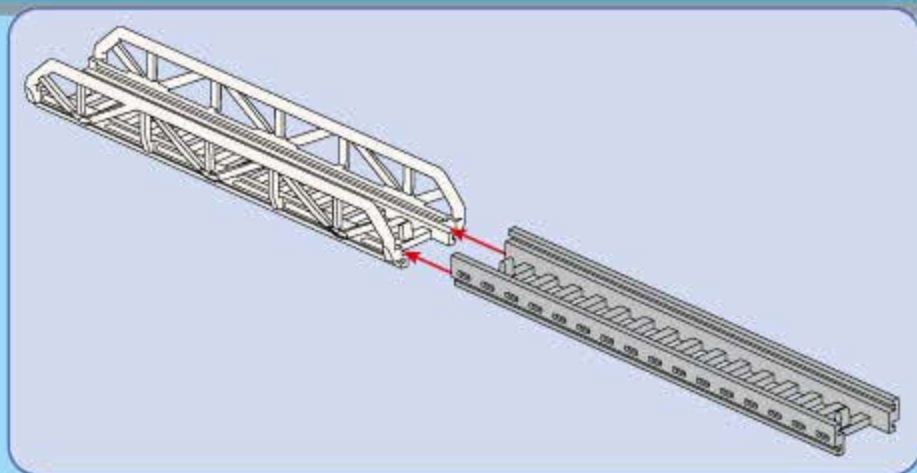

41



6x



6x



1x

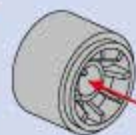
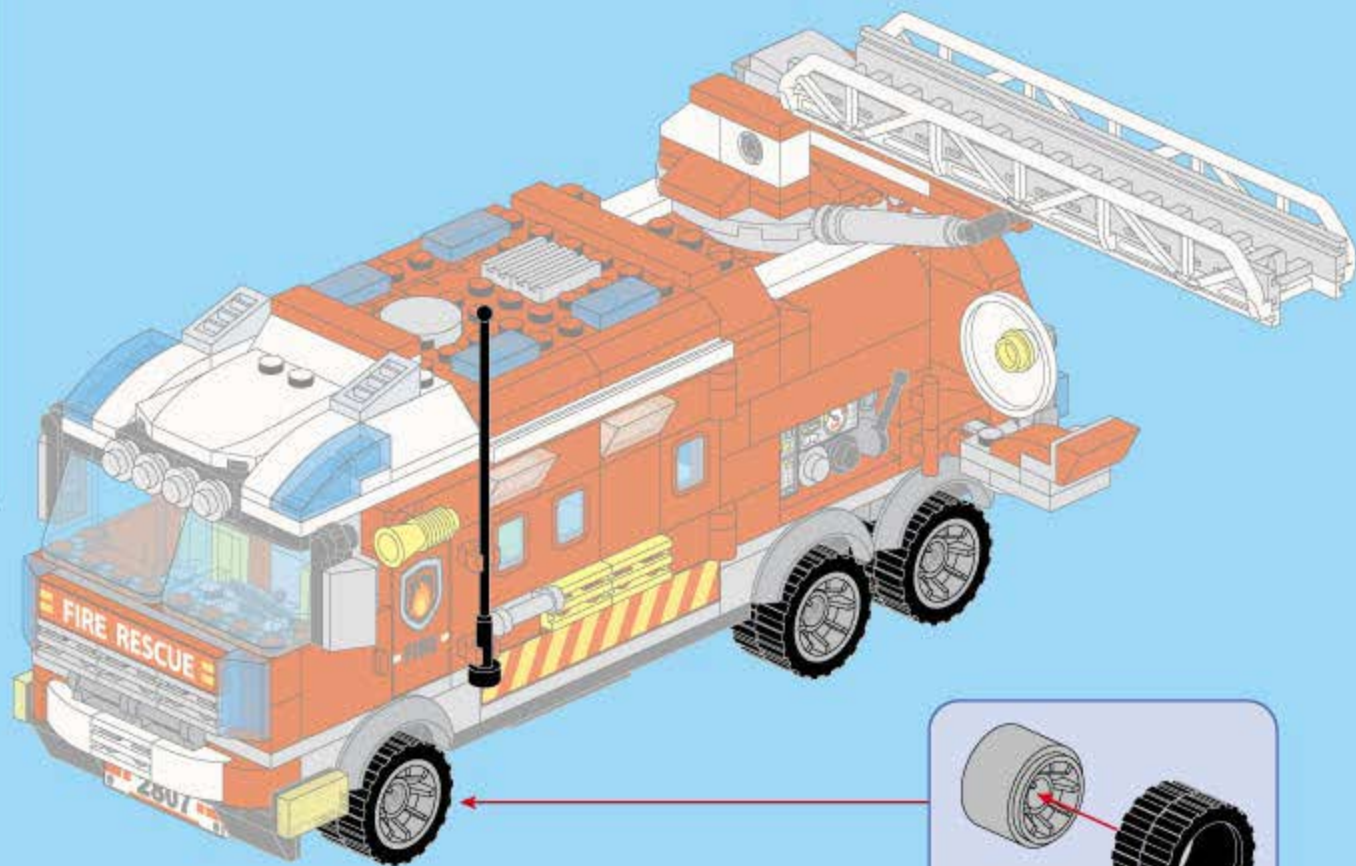

6x

FIRE RESCUE



2807



2801 MAINTENANCE CAR



2802 LIGHT ATTACK VEHICLE



2803 RESCUE HELICOPTER



2804 BOOKSTORE ON FIRE



2805 FOREST RANGER



2806 OFFSHORE FIELD CRISIS



2807 FIRE COMMAND TRUCK



2810 DOUBLE FIRE TRUCK ATTACK



2808 FIRE STATION



2809 AIRPORT FIRE FIGHTING

www.qmjm.com