

Qman

2901

Pcs:460

乐趣积木盒
Build N Learn
Box

Creative
Builder



ages for
3+



拆件器使用方法, 仅为示例

Usage of Brick Separator, Just for the sample

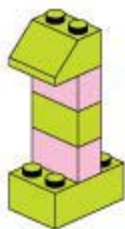
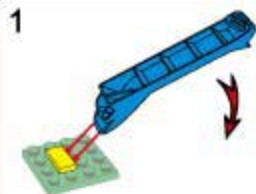

A1

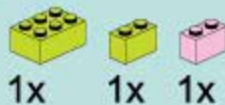

A2

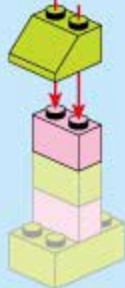

B1

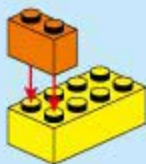
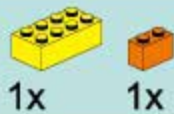

B2

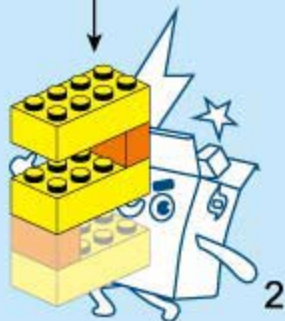
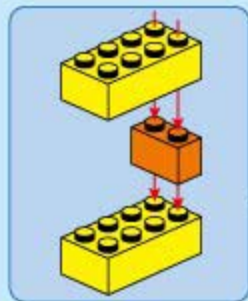
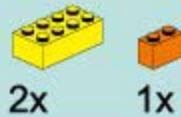

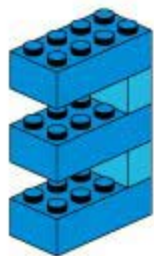

C1

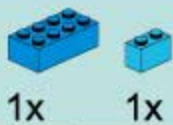

1x

1x



3

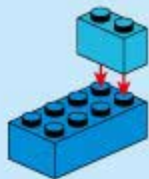

C2



1x

1x

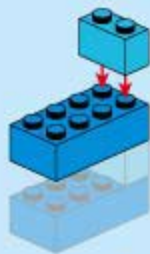

C3



1x





D1

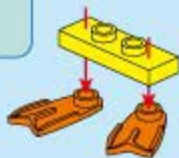

D2

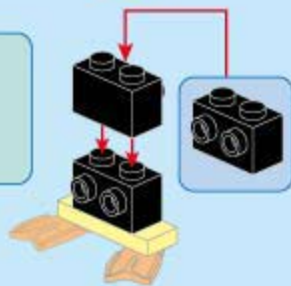

D3

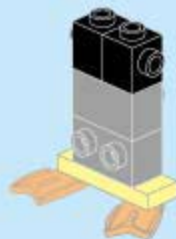

D4



D5

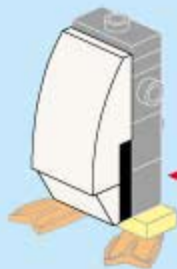
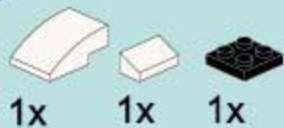

1

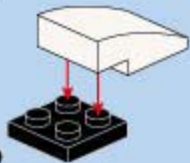

2



D6

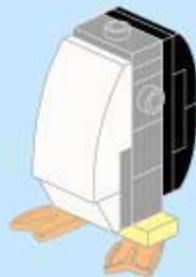

1

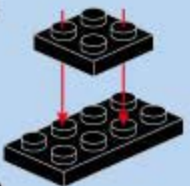

2

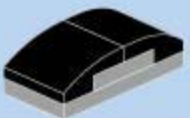

5



D7



2x

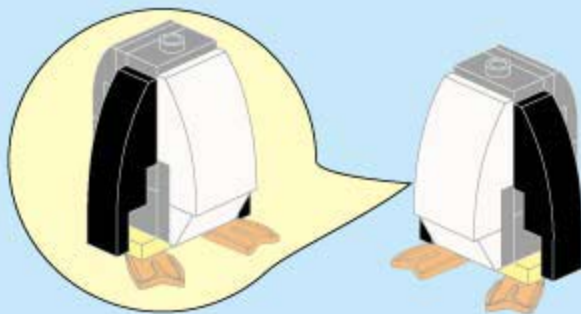

D8



1x



1x



1x



1x



1x

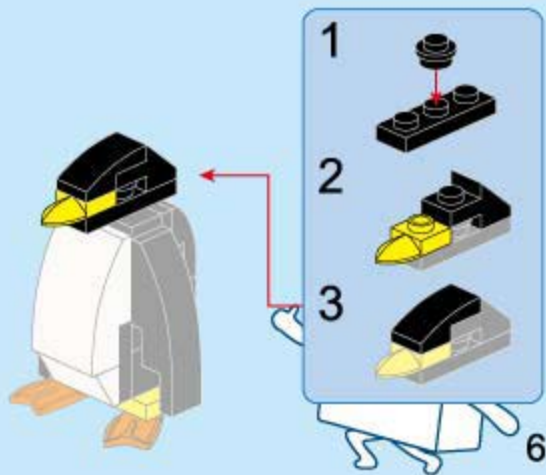

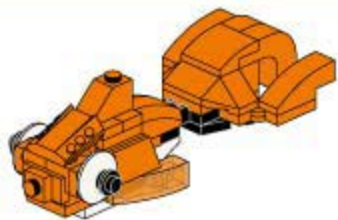

E1

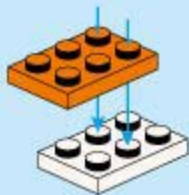

E2

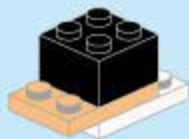

E3

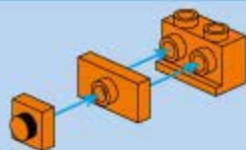

E4

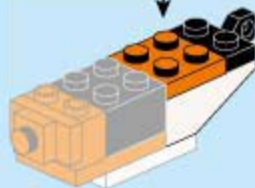
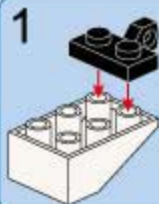

E5



E6



E7



E8

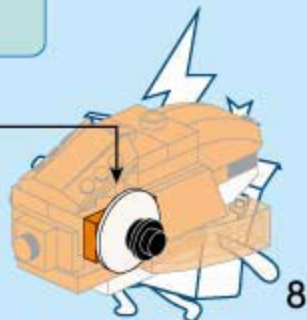

E9



E10

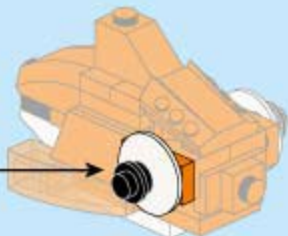

9

E11

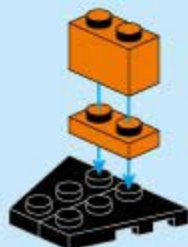
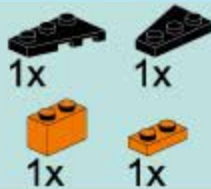

E12

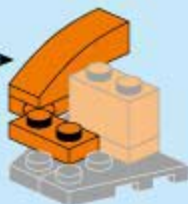
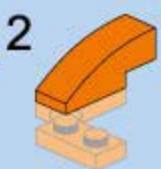
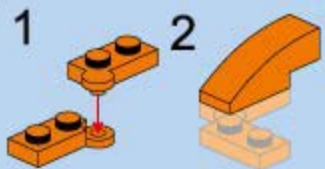
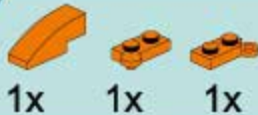

E13

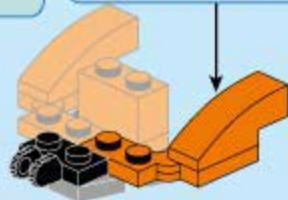
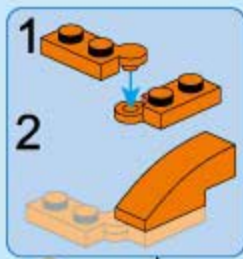
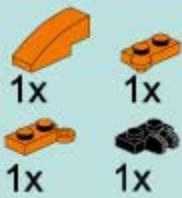

E14

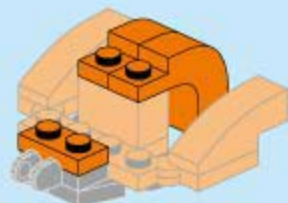
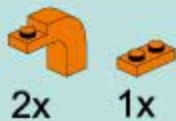

E15

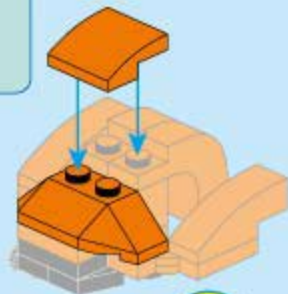
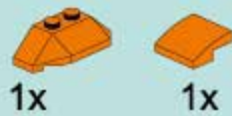

E15

E10

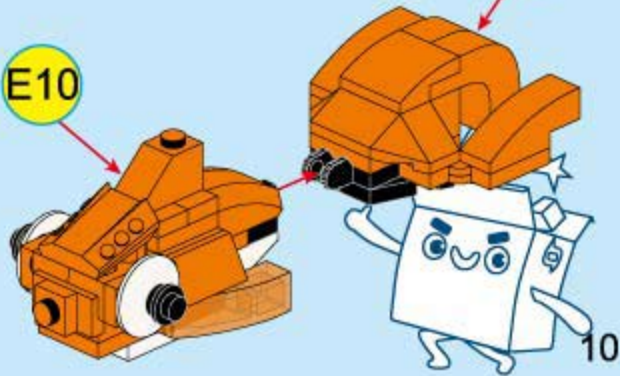

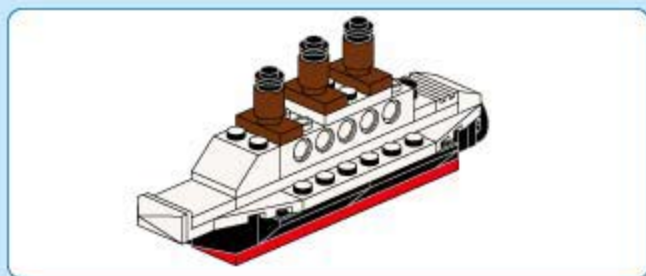

F1

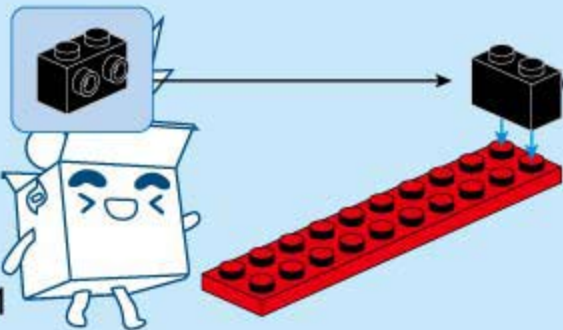
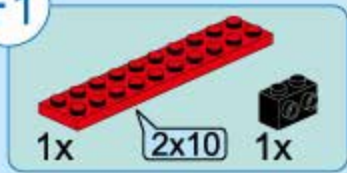

11

F2

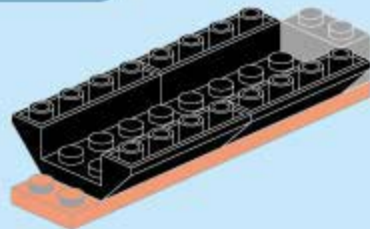

F3

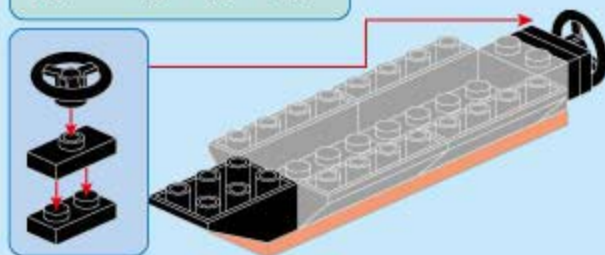

F4

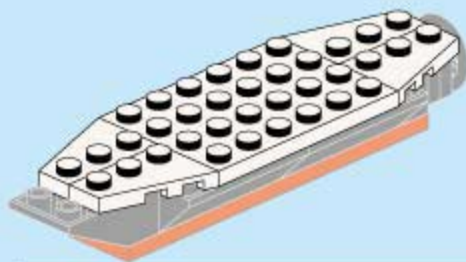
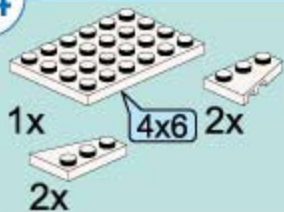

F5

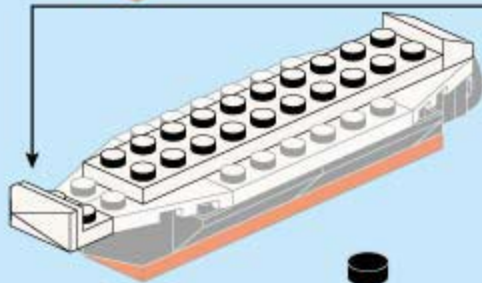
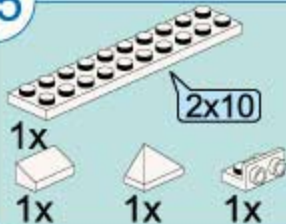

F6

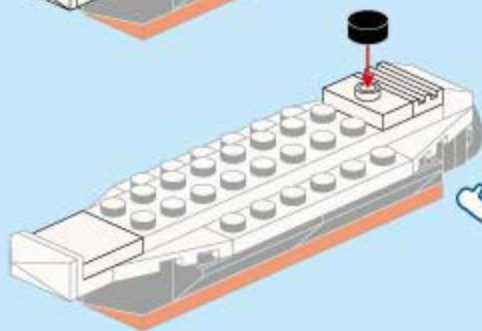
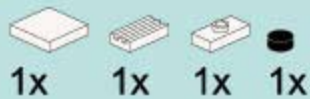

F7



2x

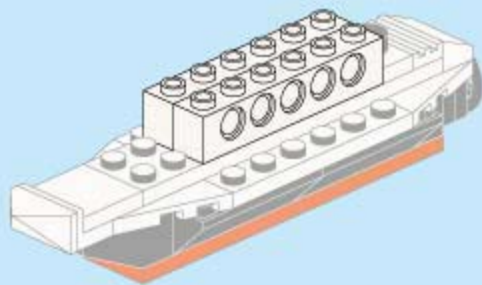

F8



1x



1x

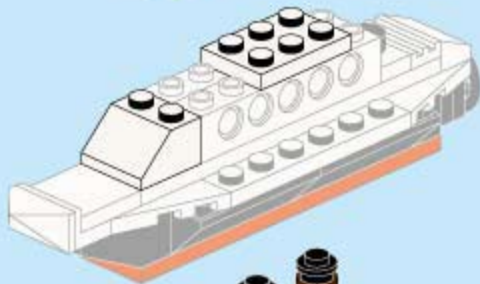

F9



3x



3x



3x

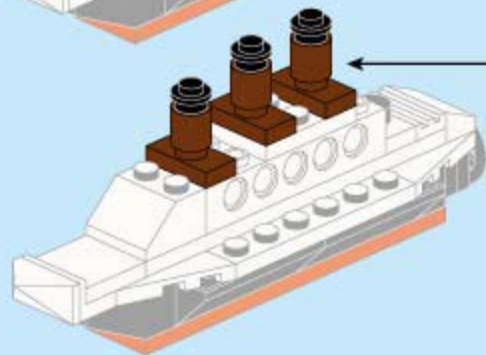

3x

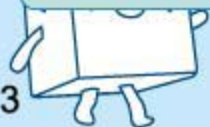

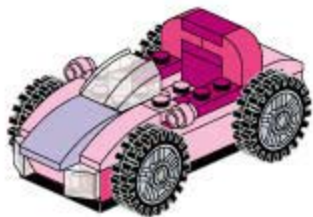

G2

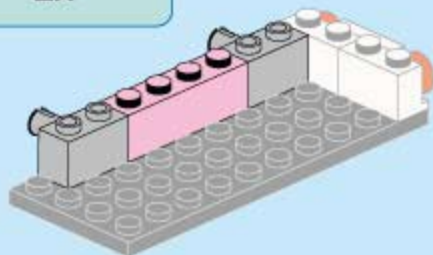
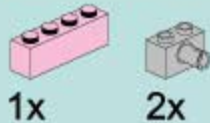

G3

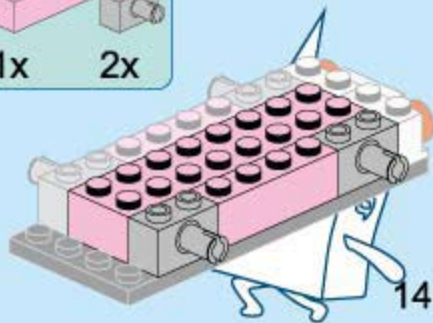
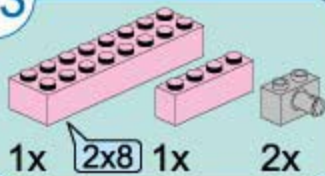

G1

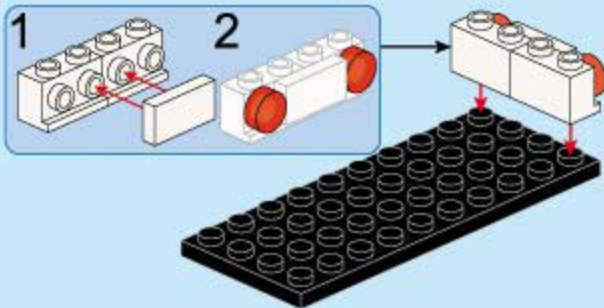
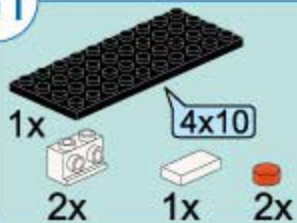

G4

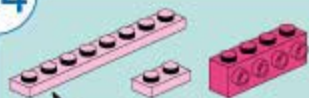

2x 1x8 1x 1x

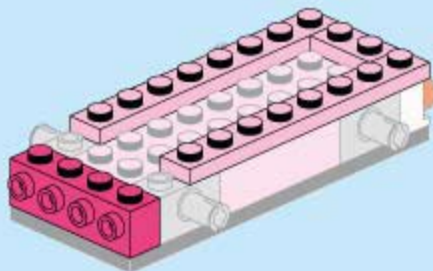

G5



2x 1x 1x 2x

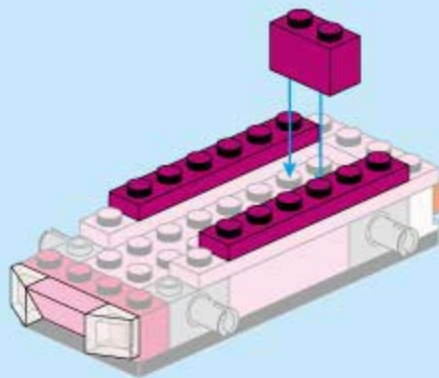

G6



1x 2x 2x 1x

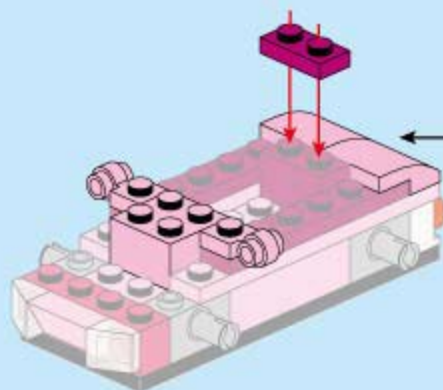

G7



1x 2x 2x

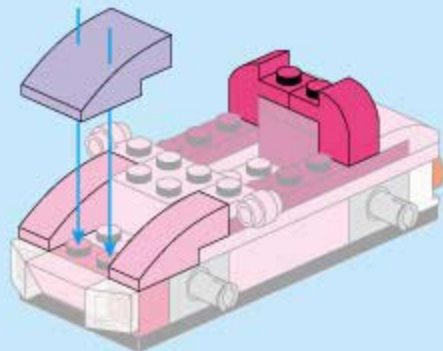

G8



1x



1x

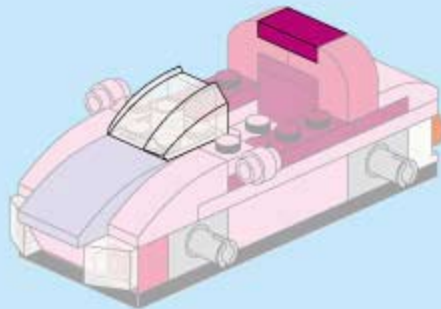

G9



4x



4x

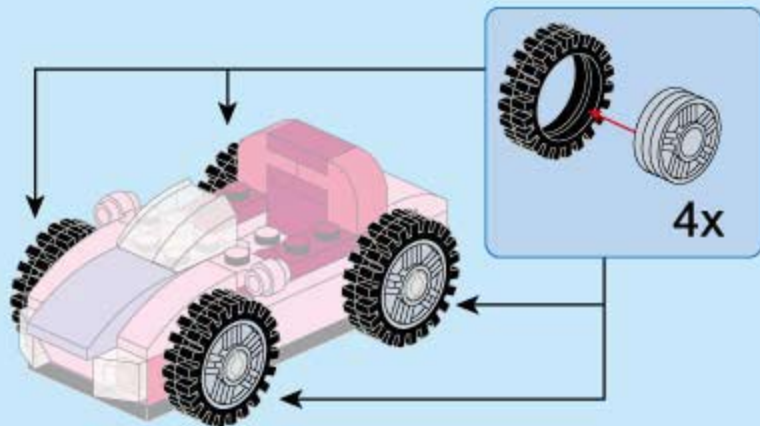

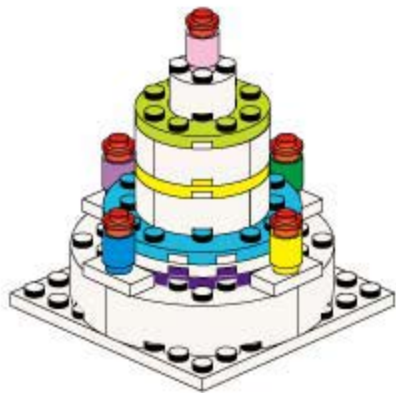

H1



1x

8x8



1x

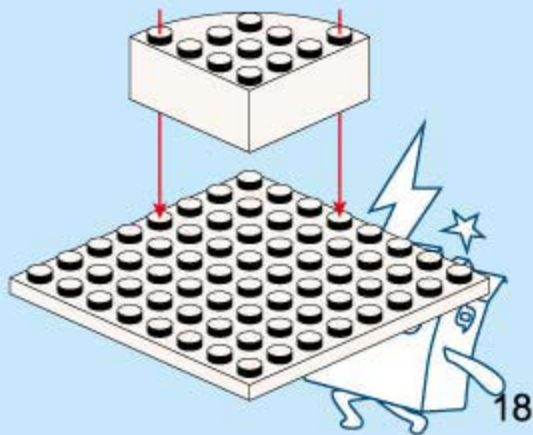

H2



3x

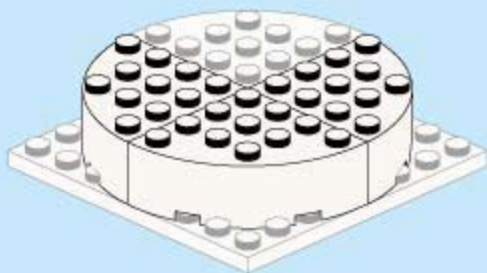

H3



1x



4x

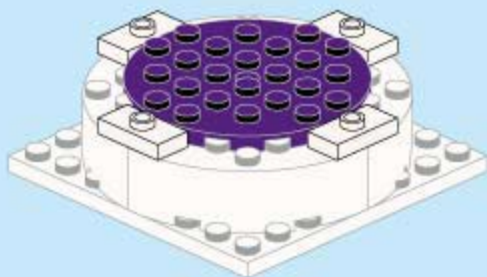

H4



1x



1x

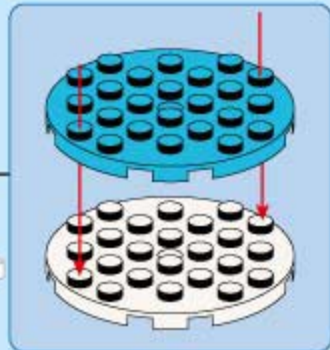
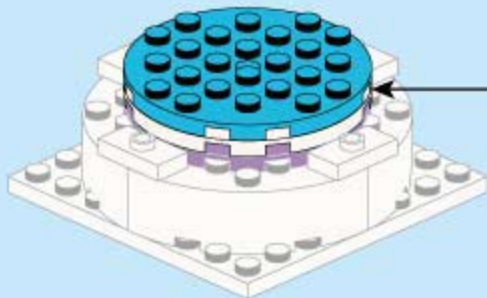

H5



4x 1x 1x 1x 1x

H6



1x



4x



4x

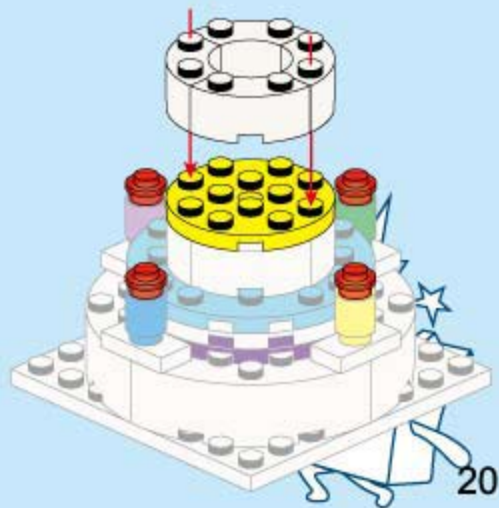
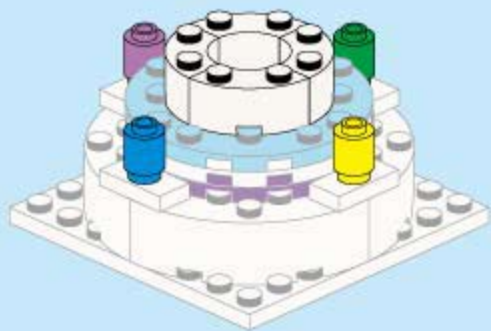

H7



1x

1x

H8



1x

1x

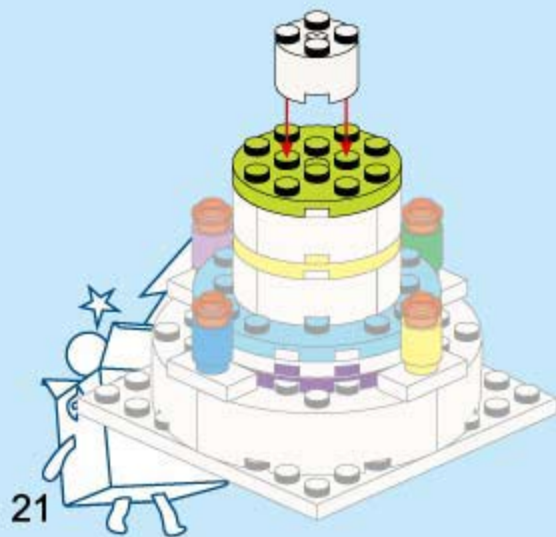



11

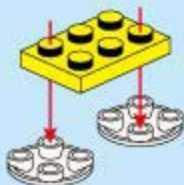

12



13

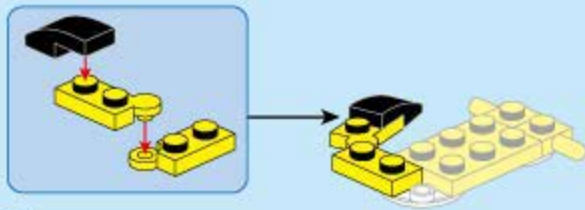

14

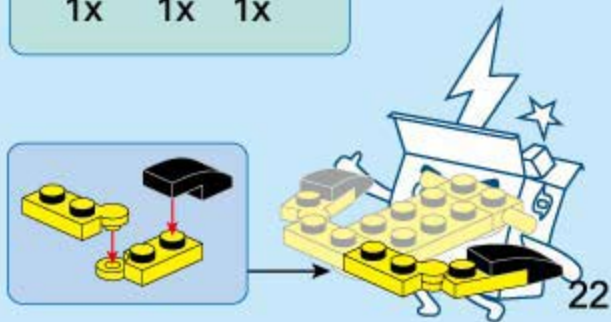

15



2x

1x

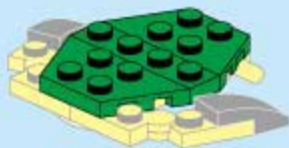

16



1x

1x

1x

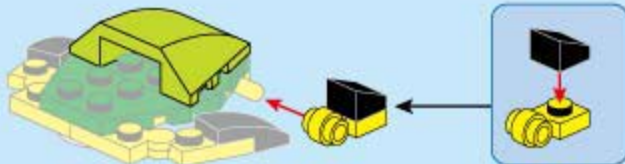

17



1x

1x

1x



18



1x



19



1x



1x



1x



1x



2x



2x



1



2

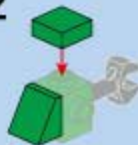

3

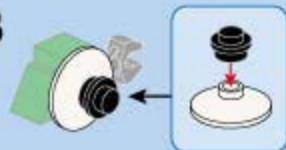

4

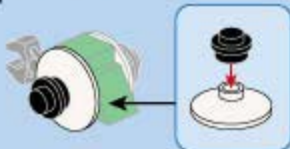

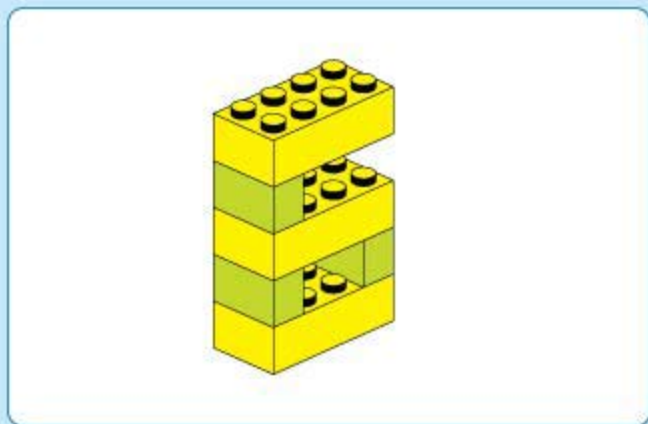

J1



1x

2x



25

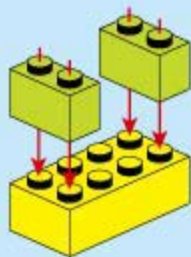

J2

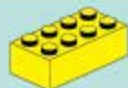

1x



J3



1x

1x

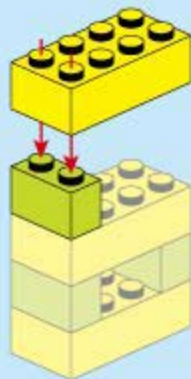

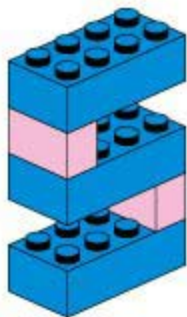

K2



1x

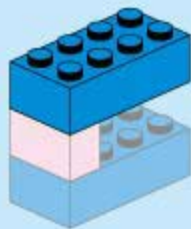

K1



1x



1x

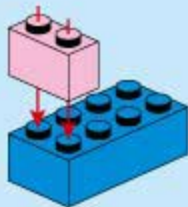

K3



1x



1x

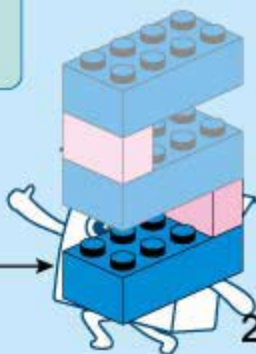
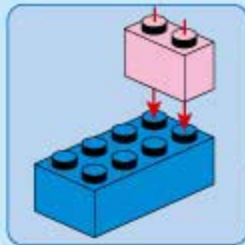

L1

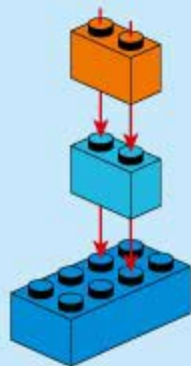
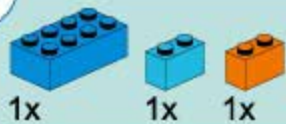

L2

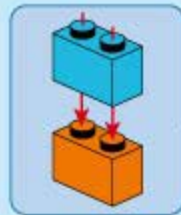

L3

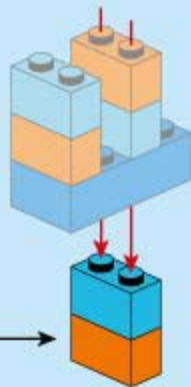
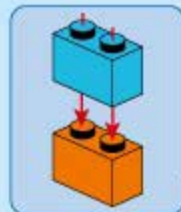



M1

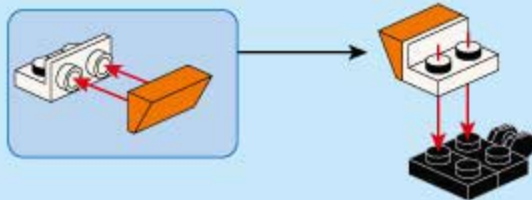
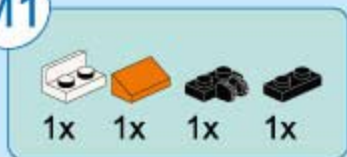

M2

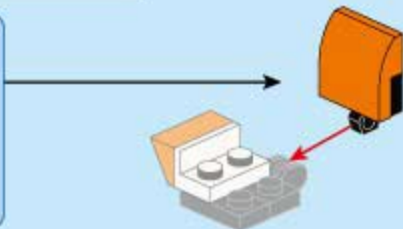

M3

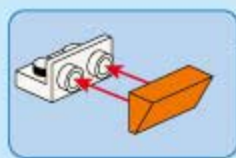

N1

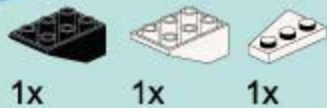

29

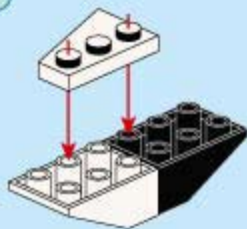

N2

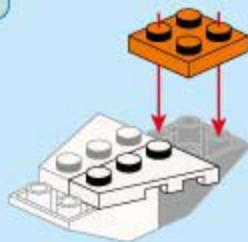

N3

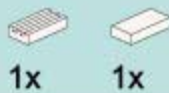

N4



1x

1x



N5



1x

1x



N6



1x

1x

1x

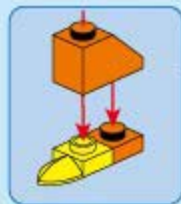

N7



2x

2x



2x



30

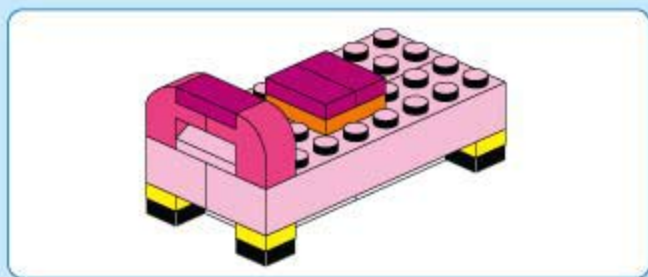

O1

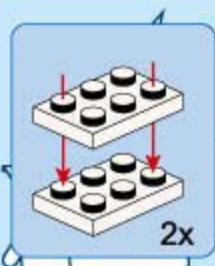

31

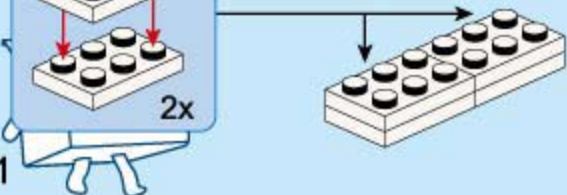

O2

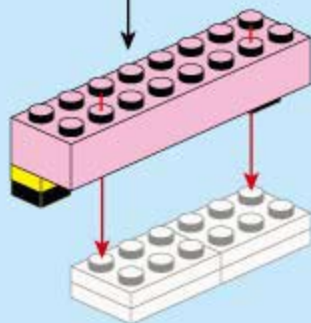
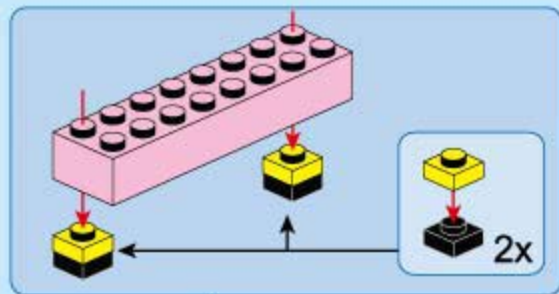
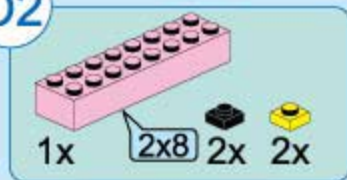

O3

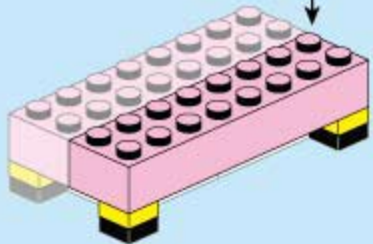
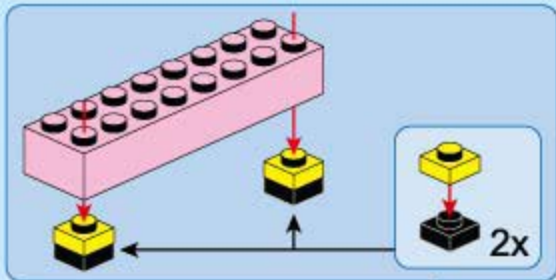
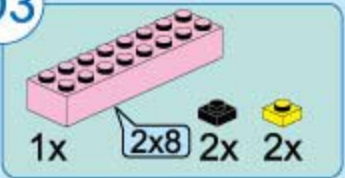

O4

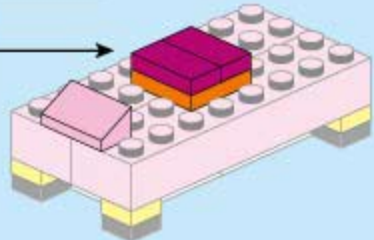
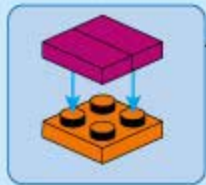
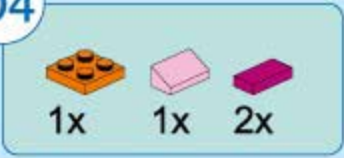

O5

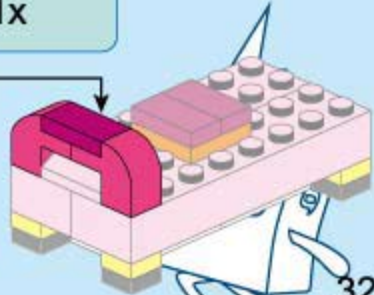
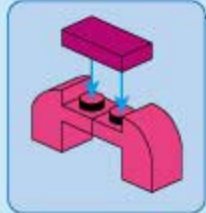



P1

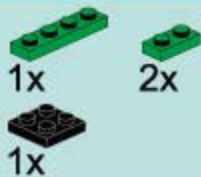

P2

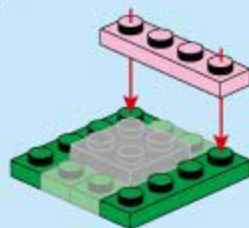

P3

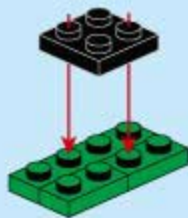
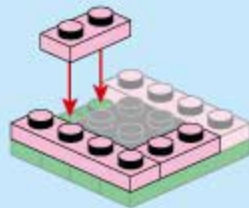

P4



2x



1x

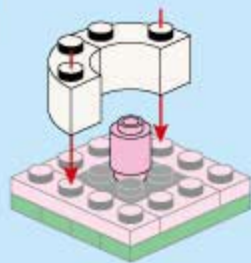

P6



4x



P5



2x

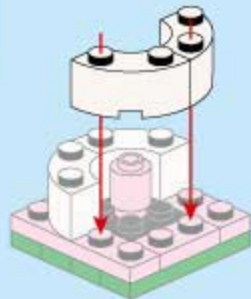

P7



1x



1x



1x

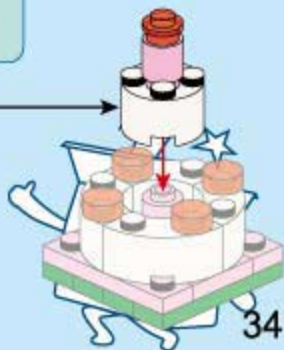



潜能
POTENTIAL



合作
COOPERATION



逻辑
LOGIC



协调
COORDINATION

2901

