

Qman

2004

Ages: 6+

Minifigs: X2

Pcs: 319

Cherry



OUTING TRIP BUS

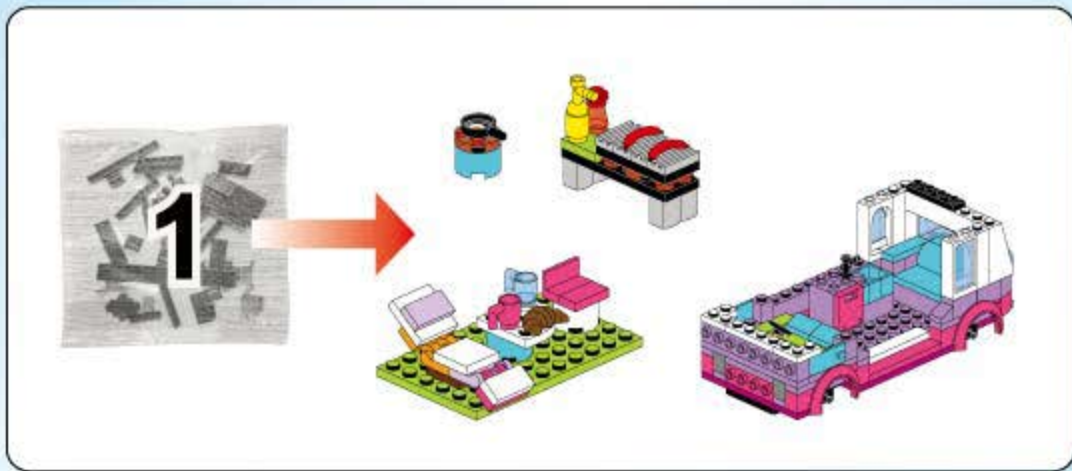

拆件器使用方法, 仅为示例  
Usage of Brick Separator, Just for the sample

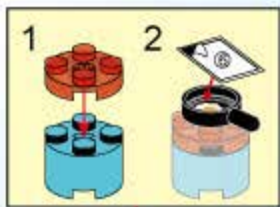
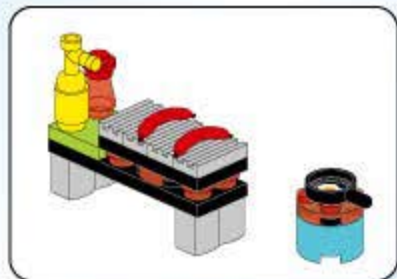
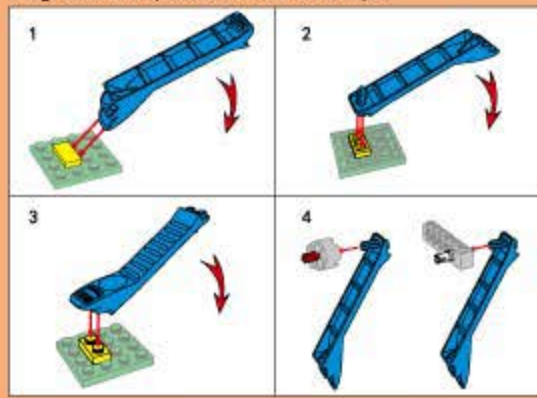

1

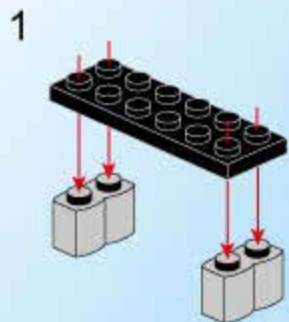

3

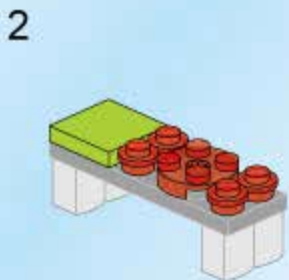
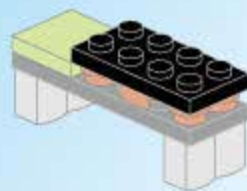

4

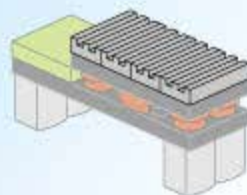

5

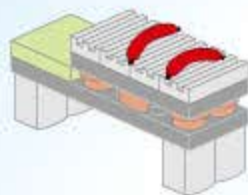

6

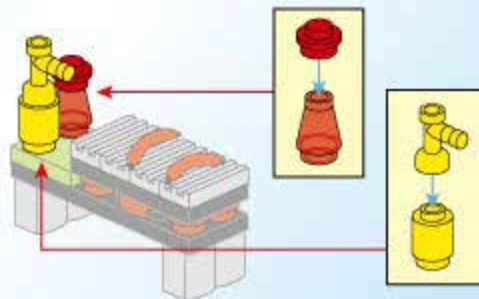

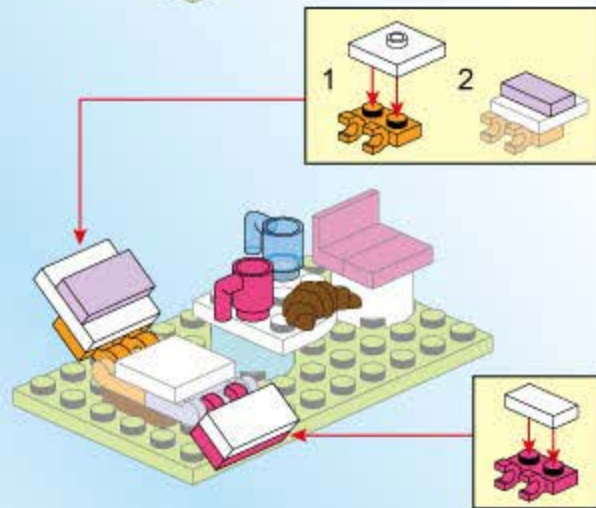
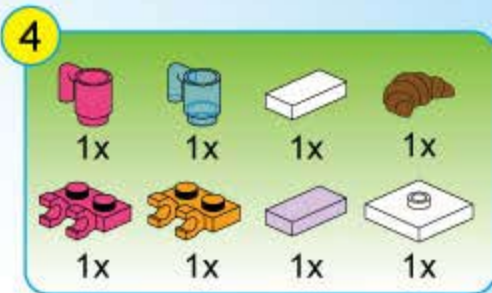
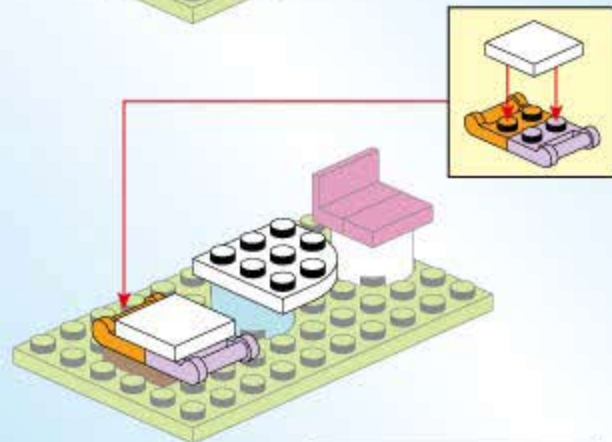
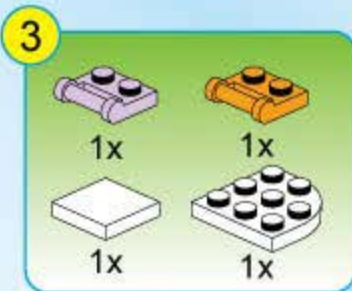
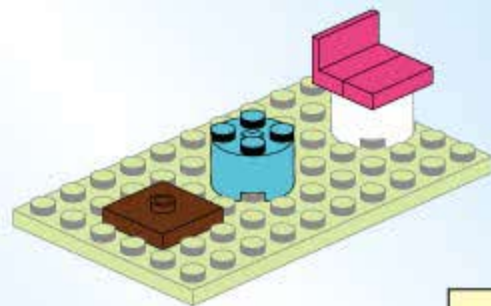
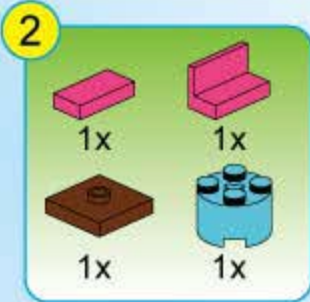
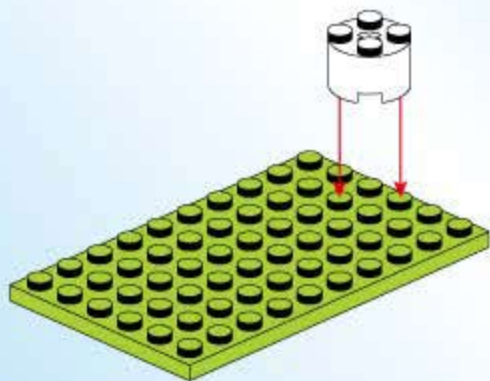
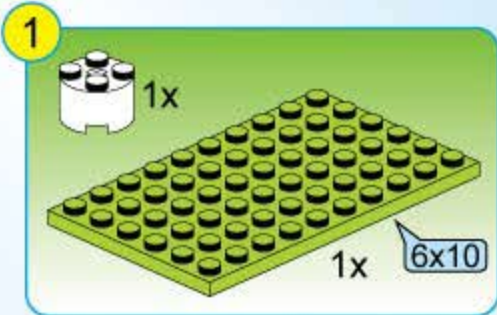
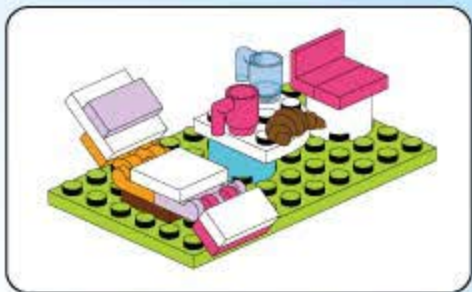

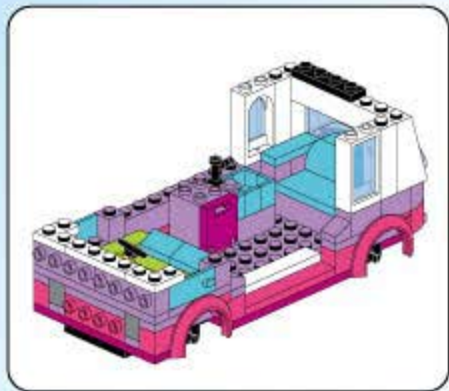

1

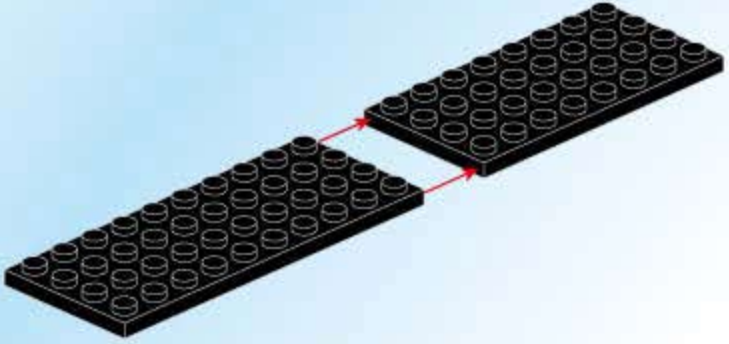
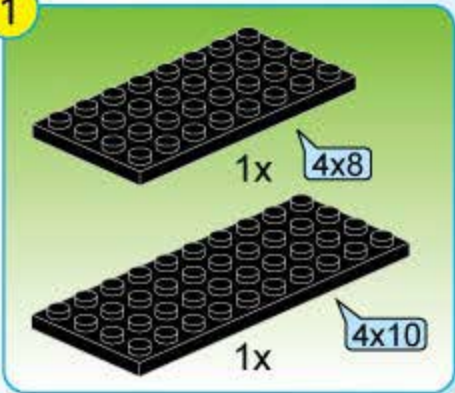

2

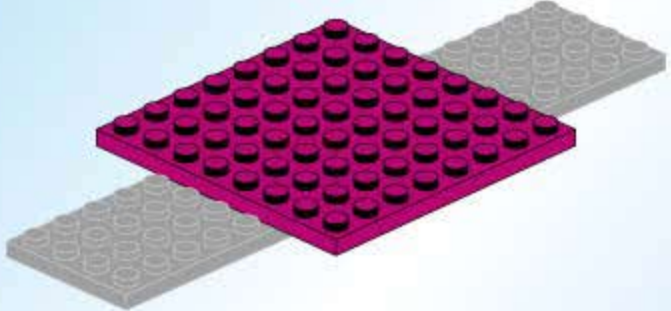
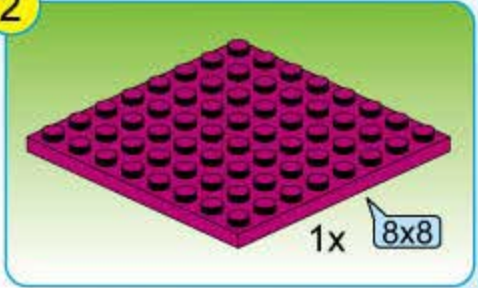

3

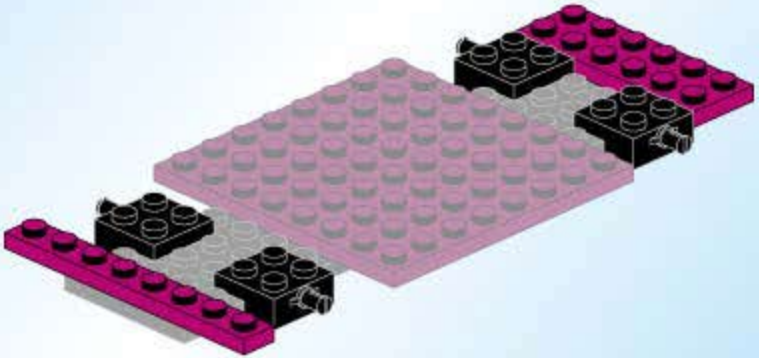
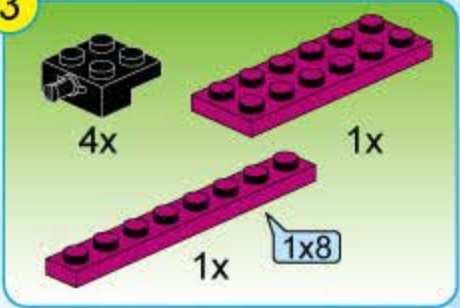

4

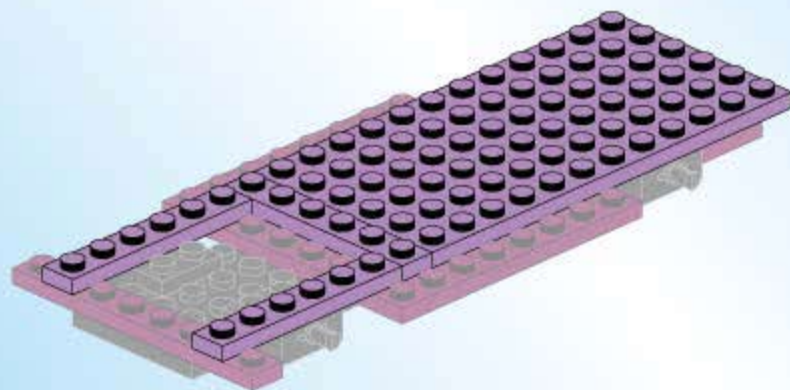
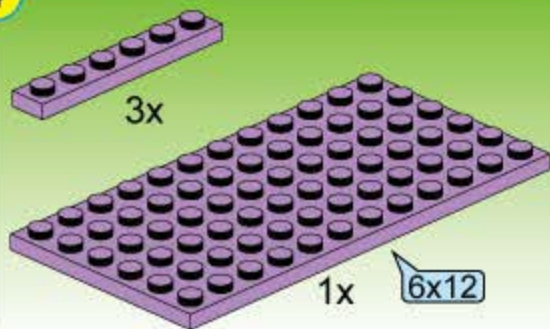

5

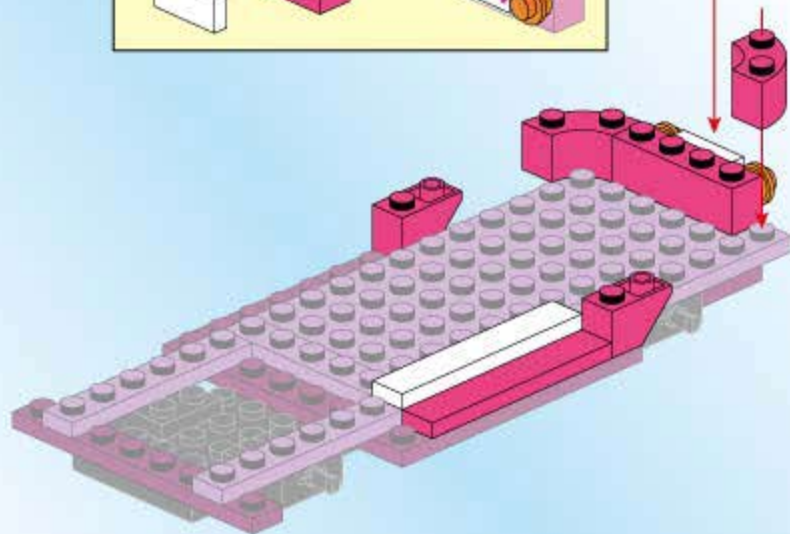
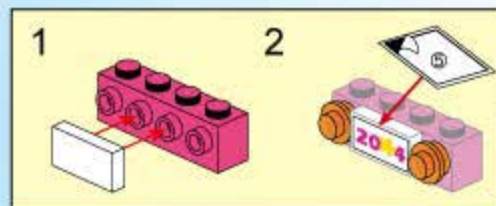
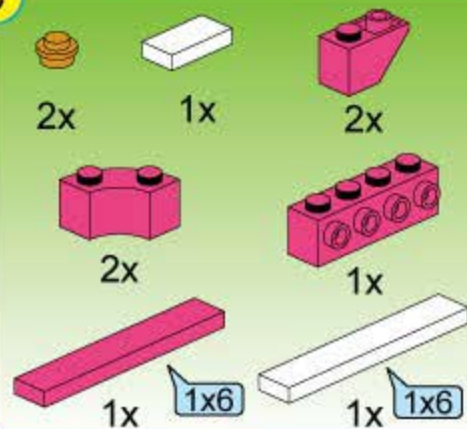

6

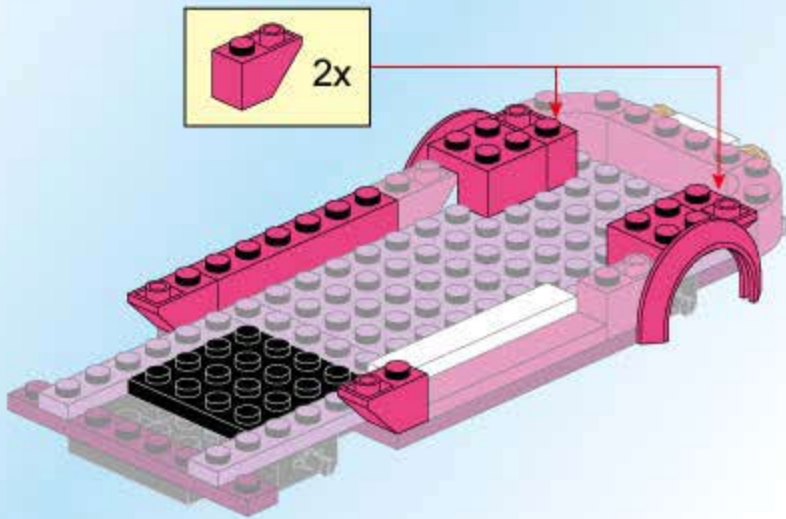
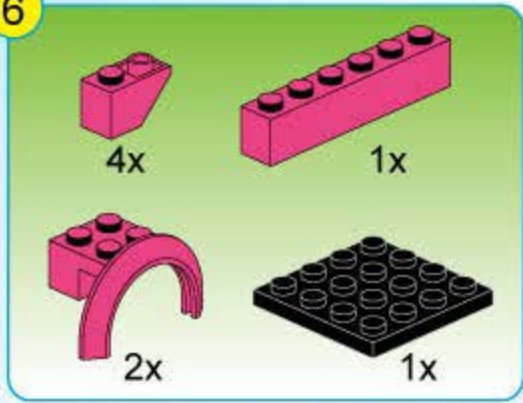

7

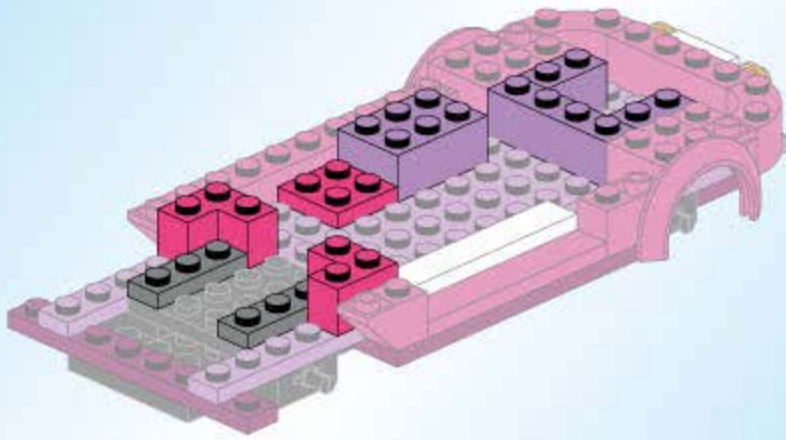
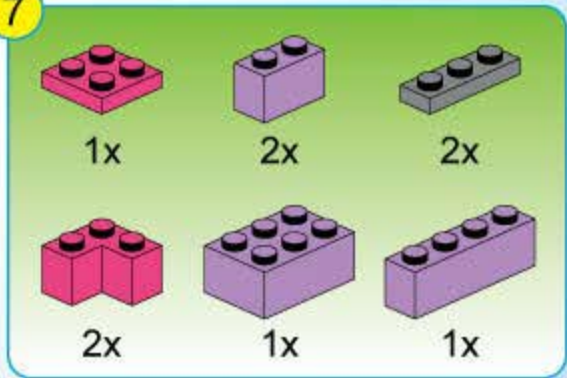

8

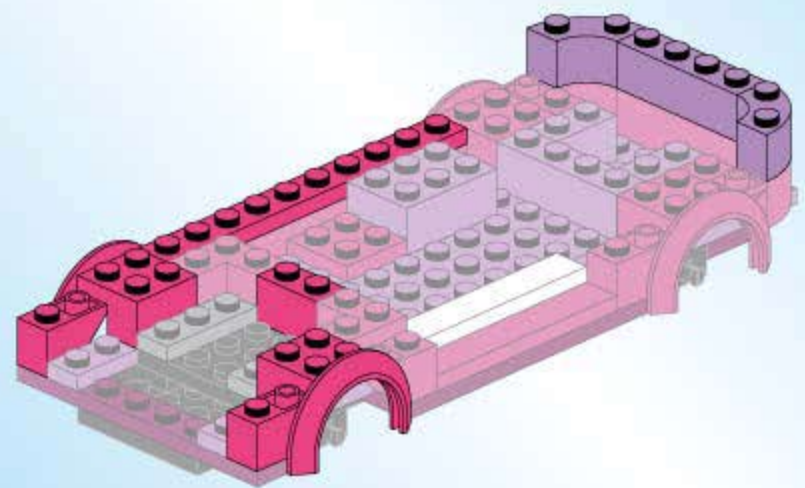
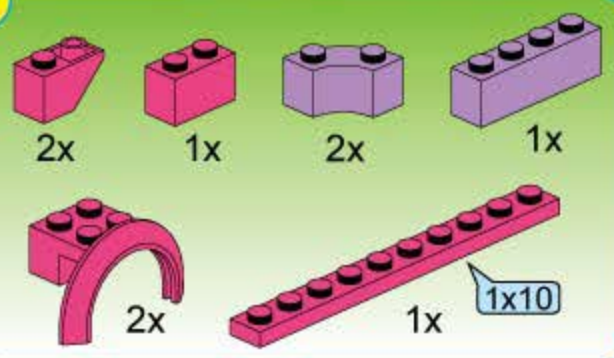

9

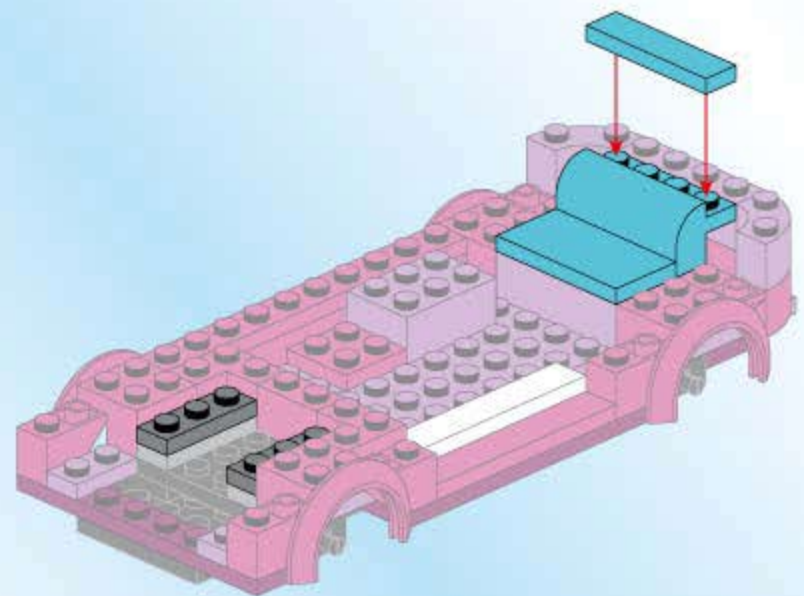
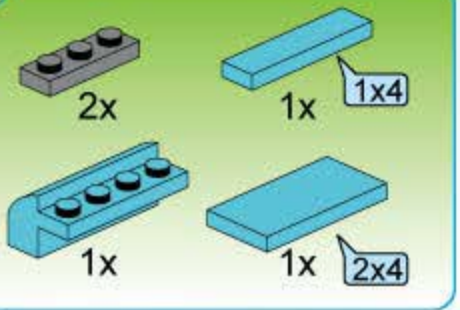

10

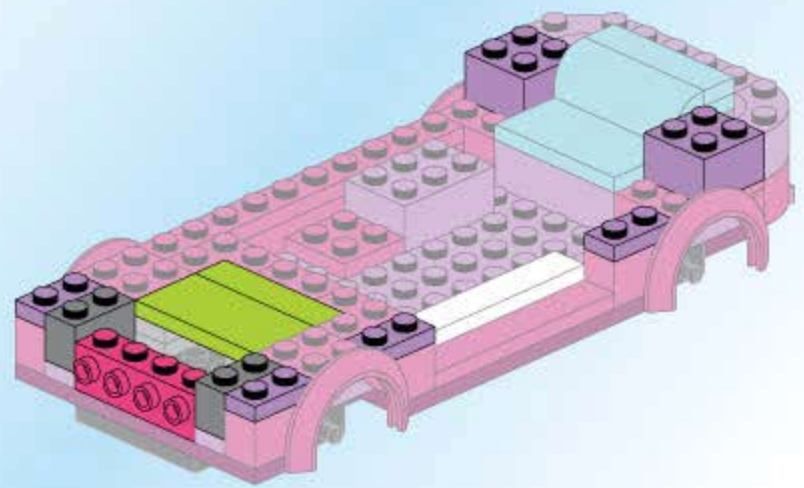
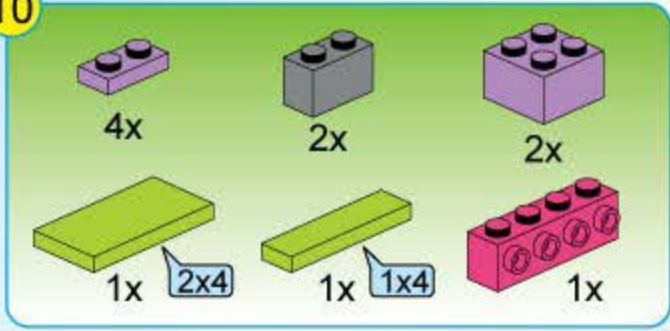

11

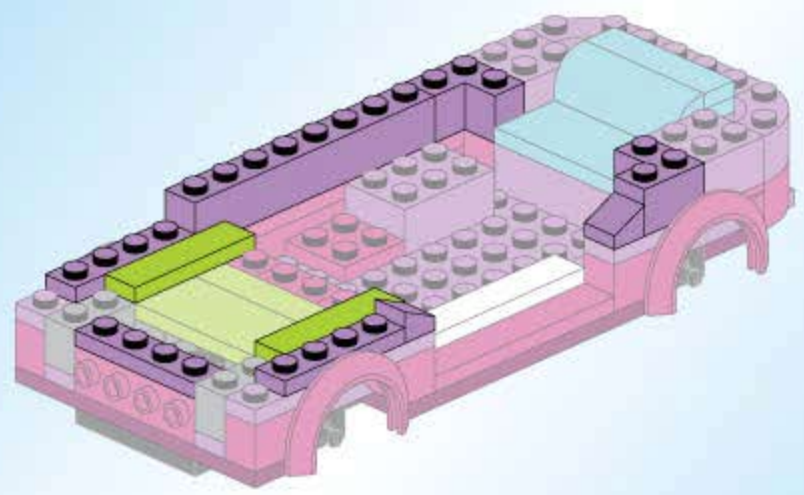
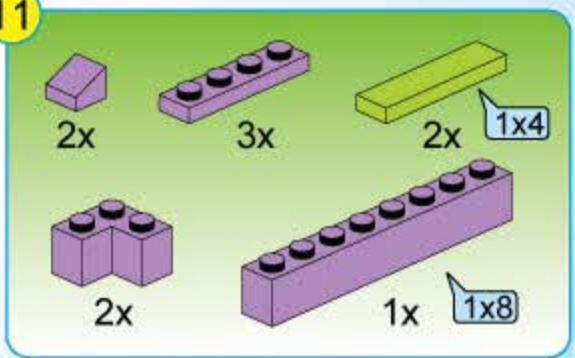



12

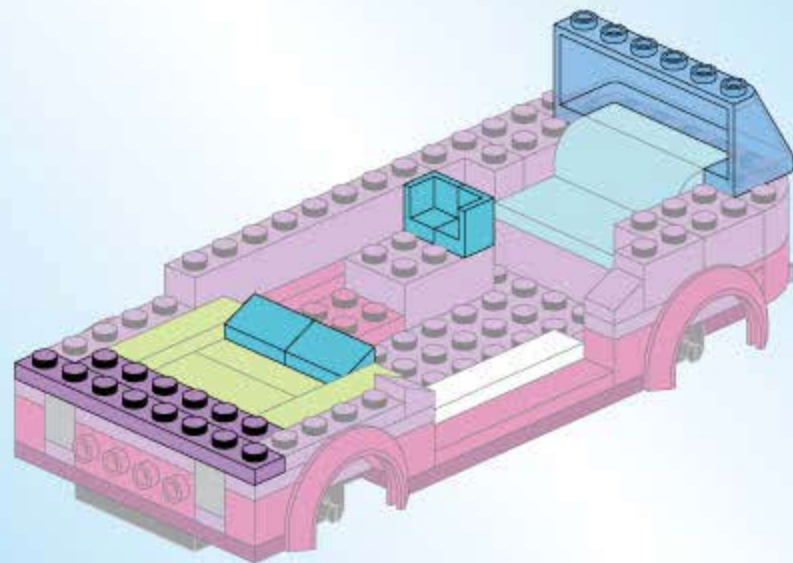
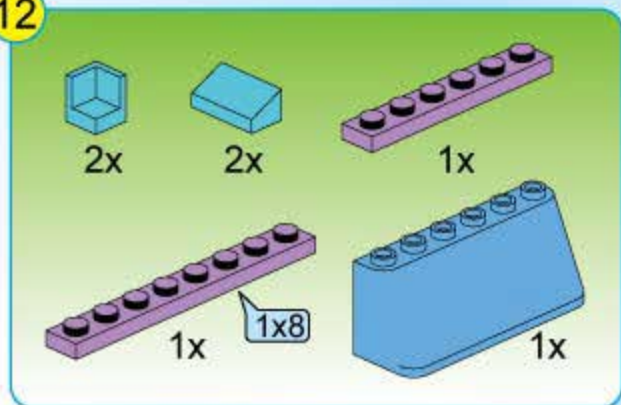

13

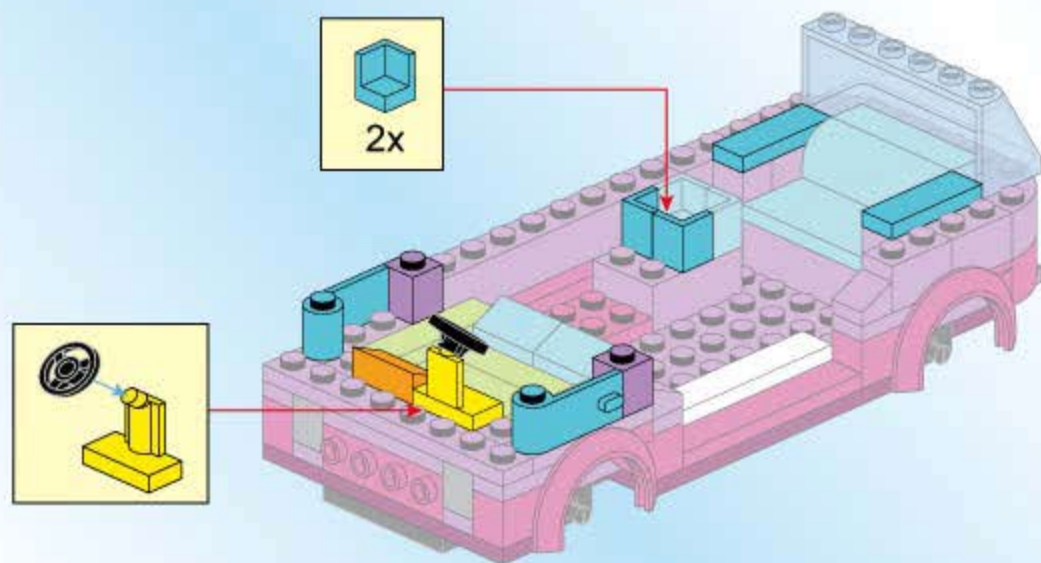
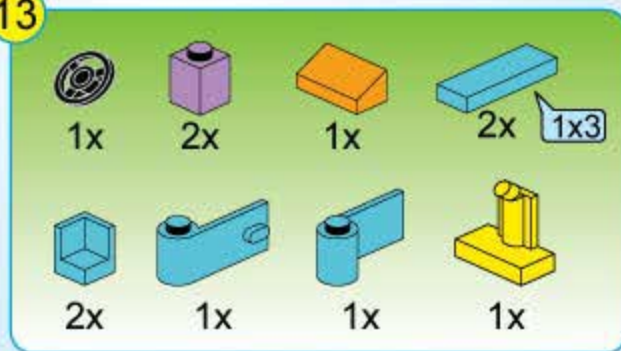

14

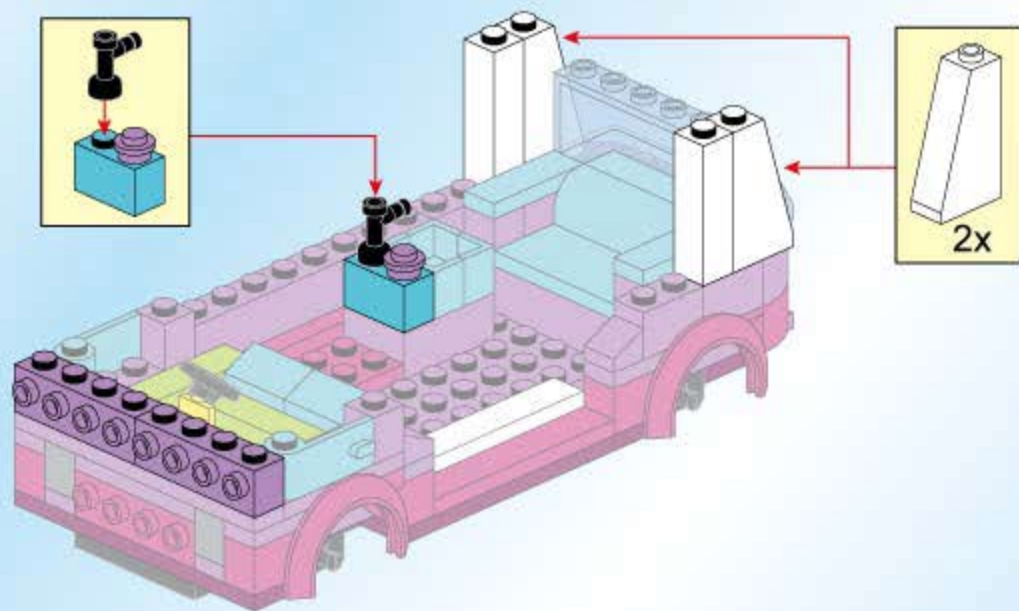
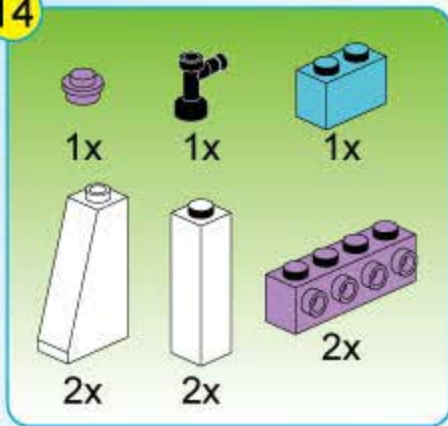

15

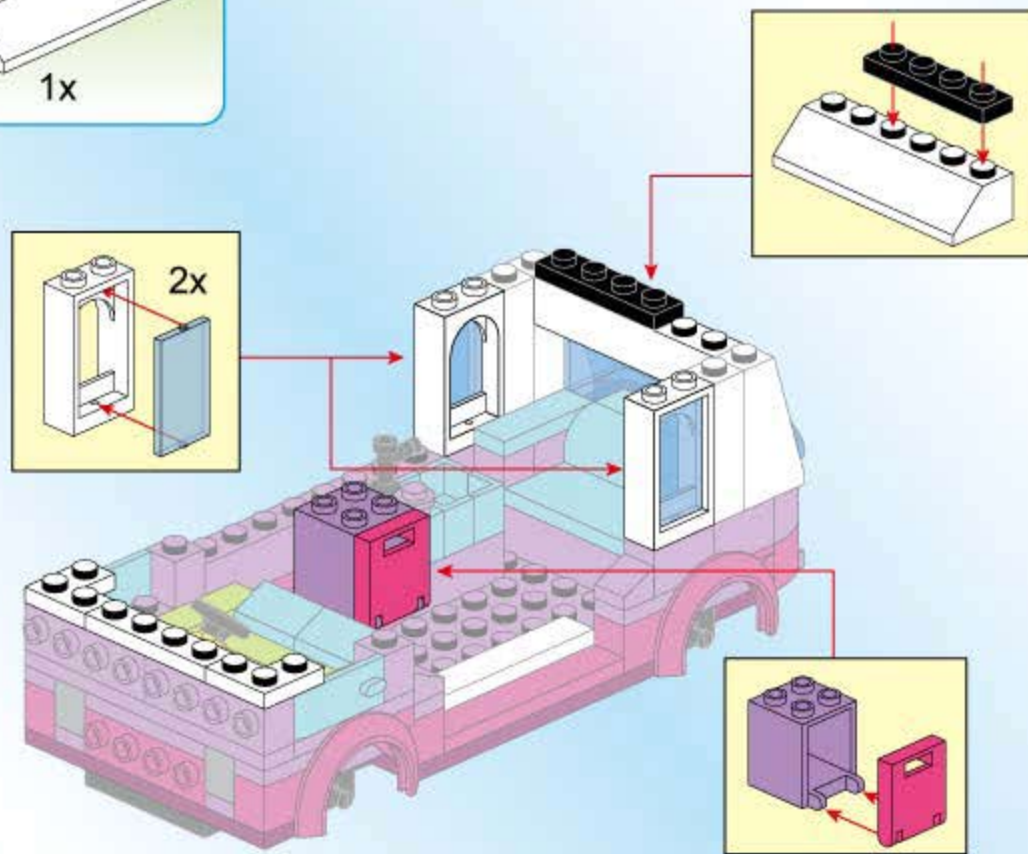
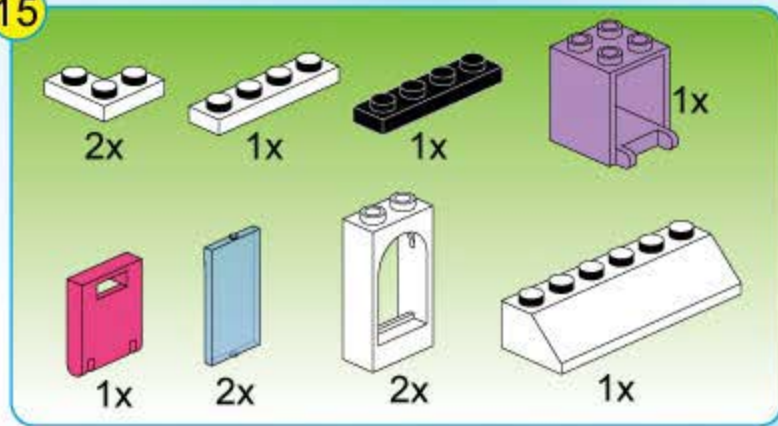



16



2x



2x



1x



1x



2x

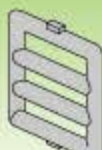

1x



2x



2x

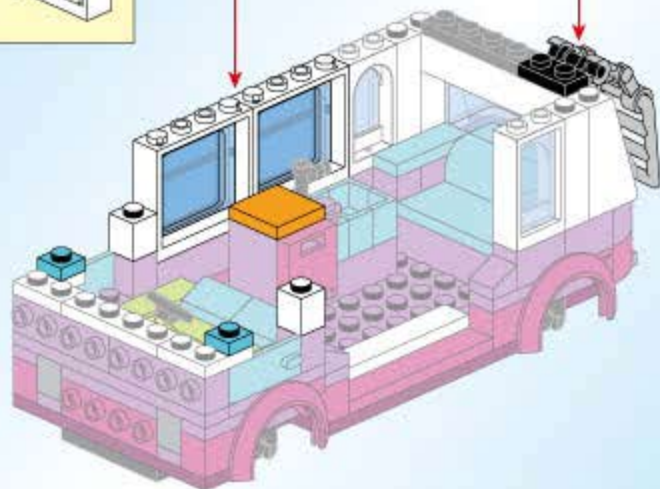
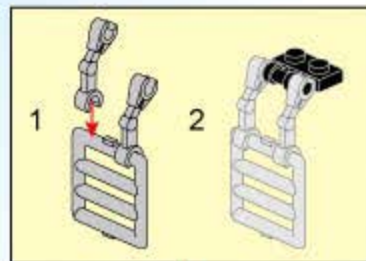
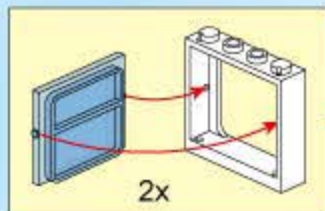

17

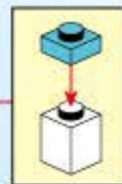
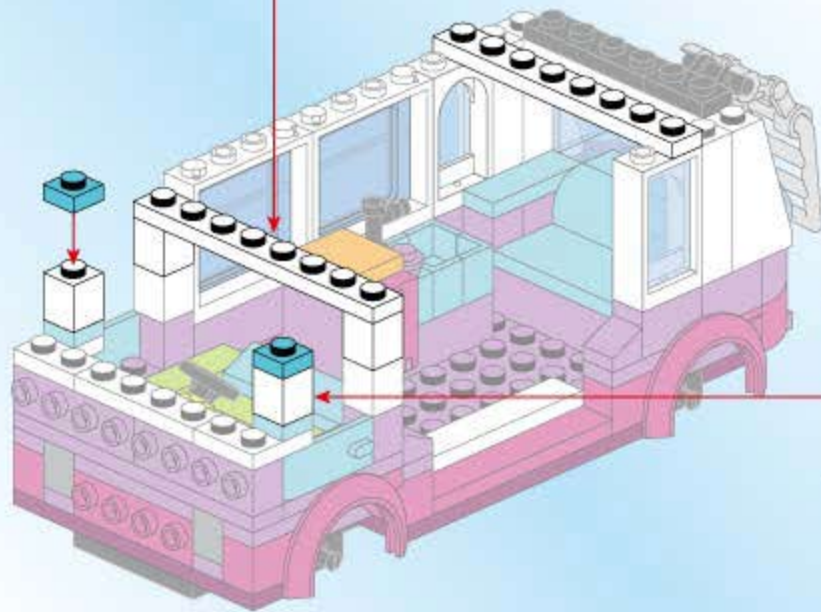
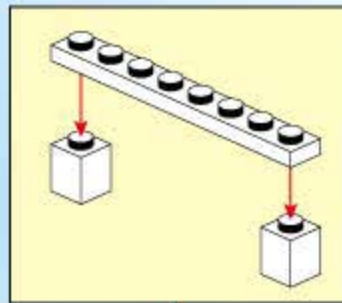
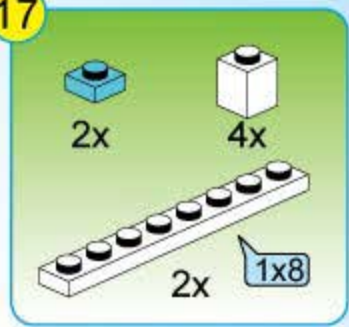

18

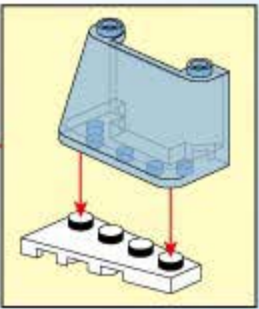
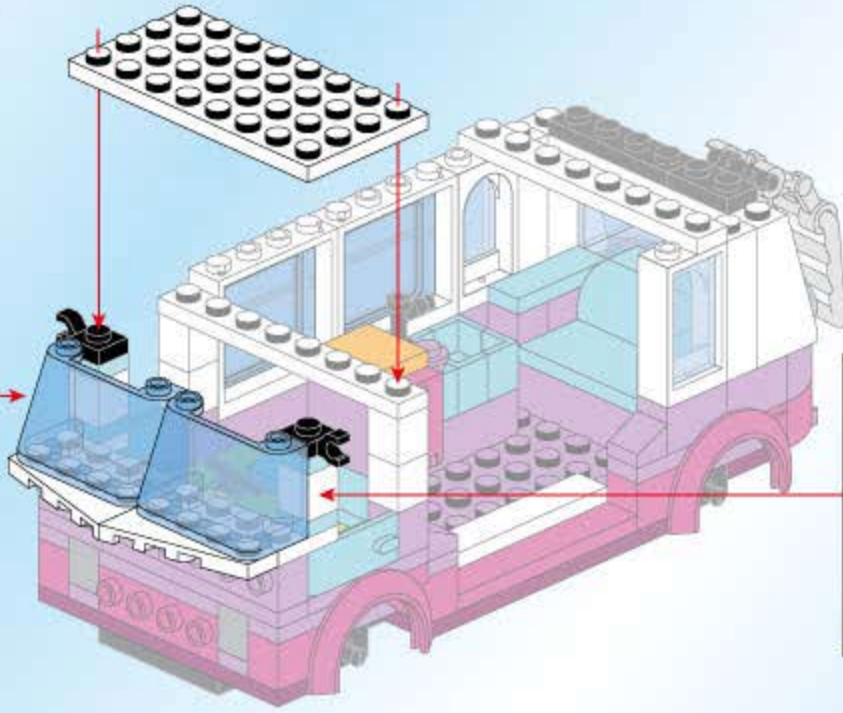
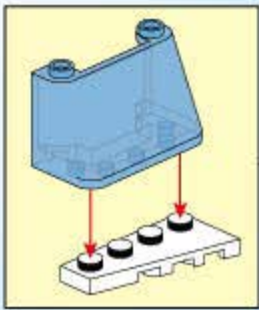
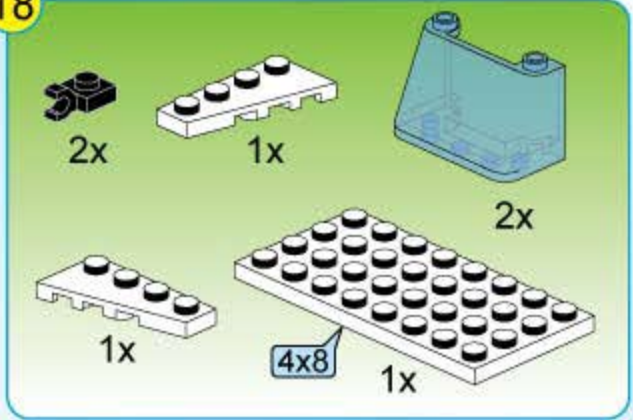

19



2x



2x



2x



2x

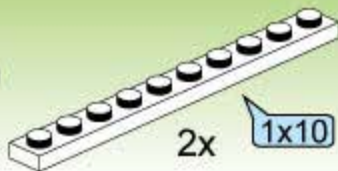

2x

1x10

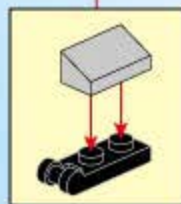
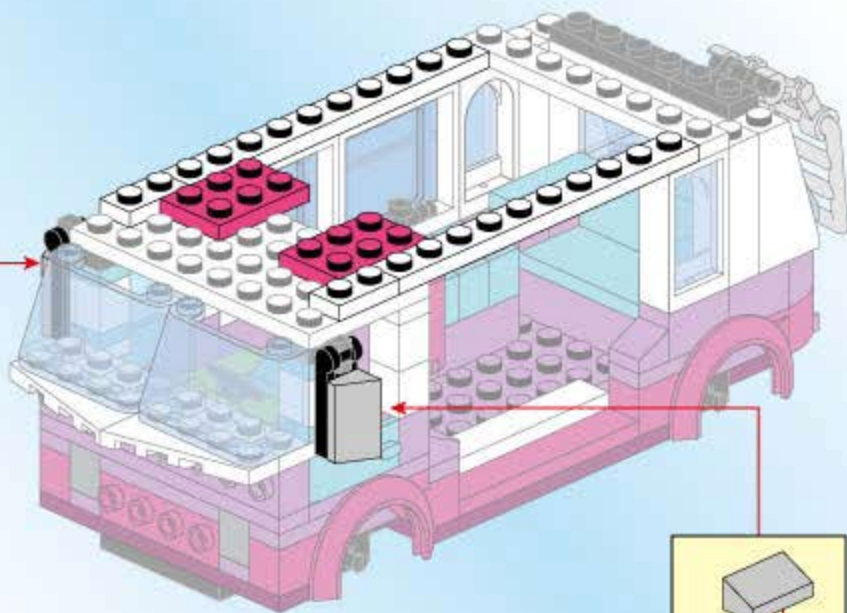
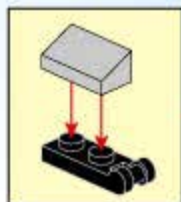

20

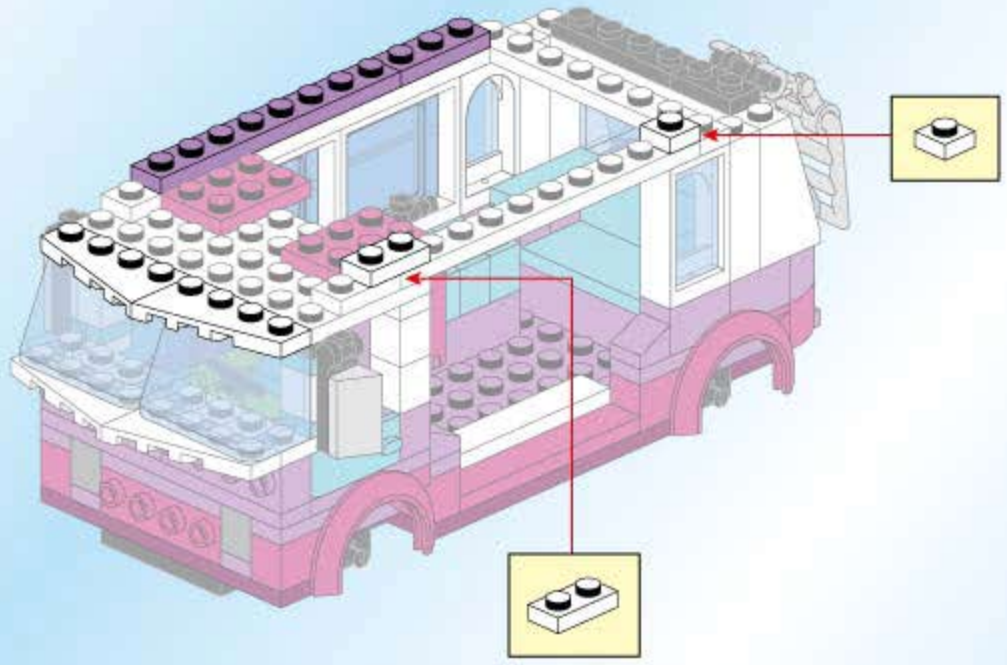
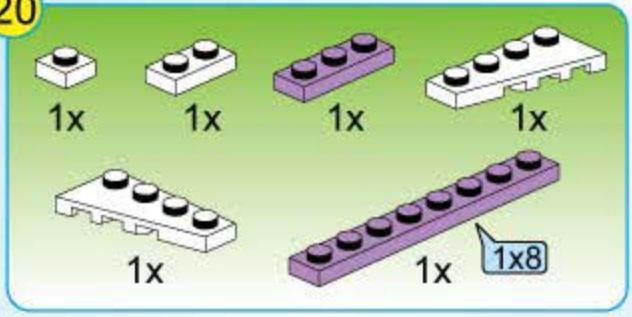



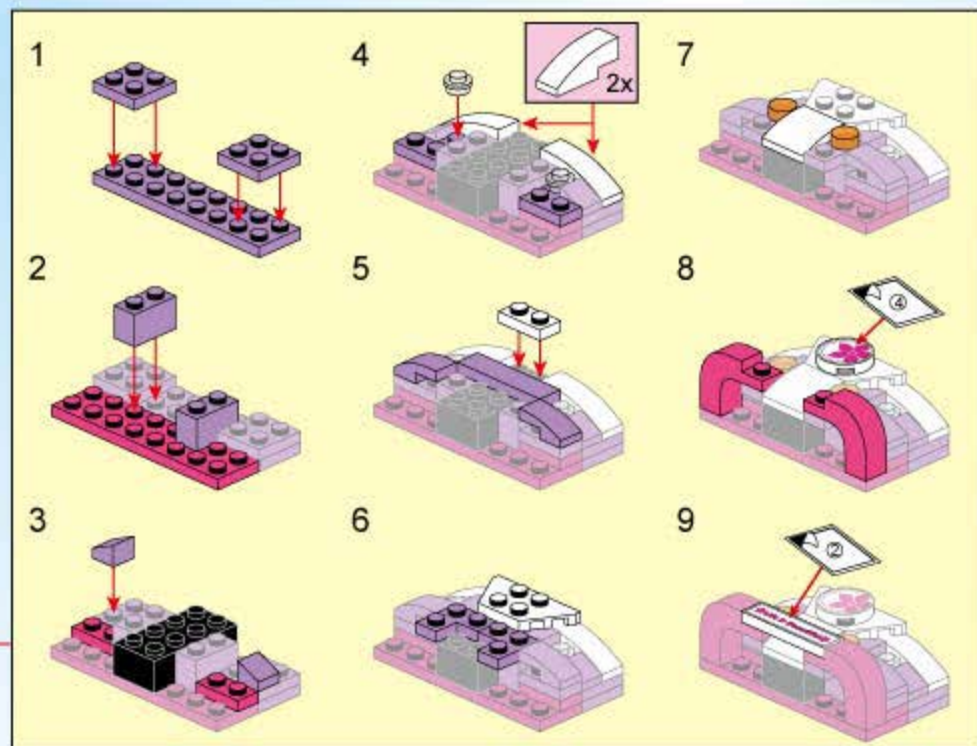
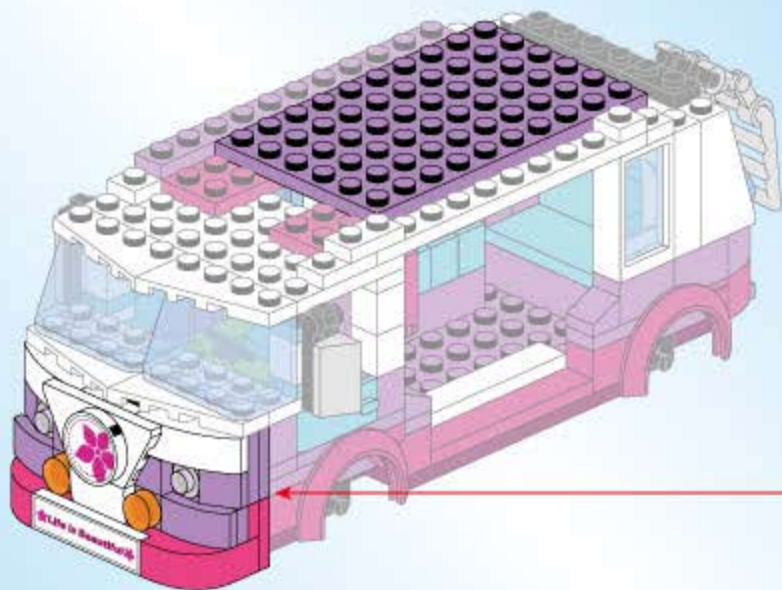
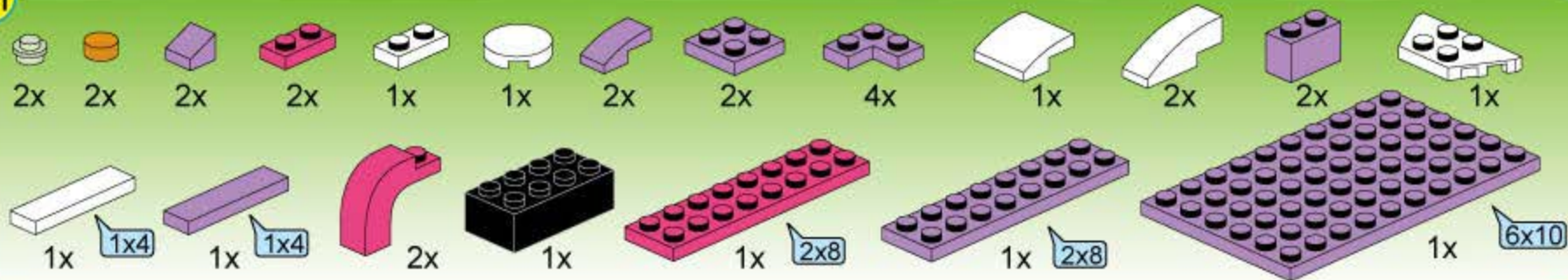

22

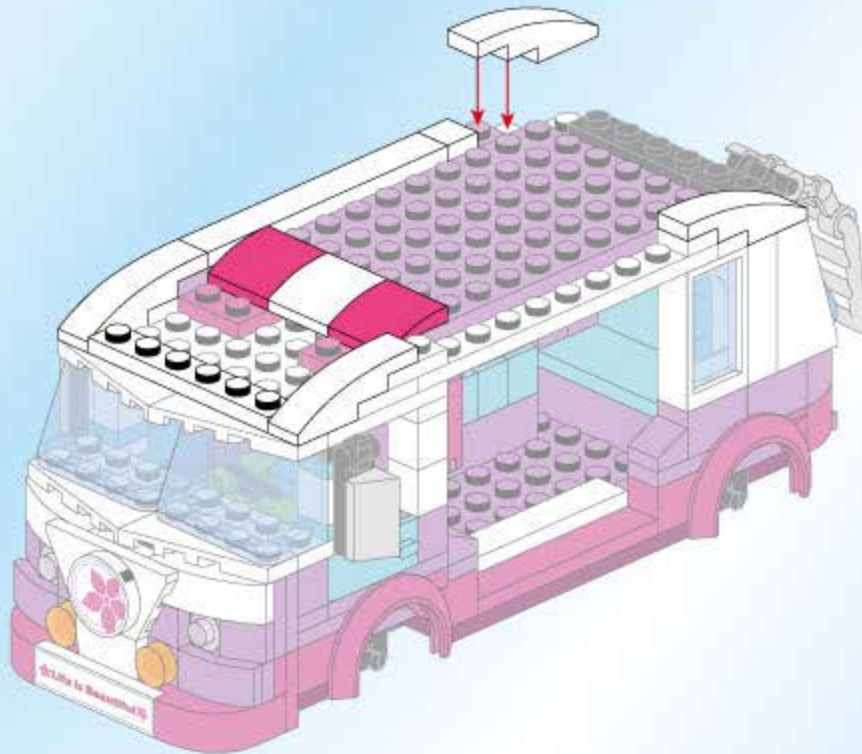
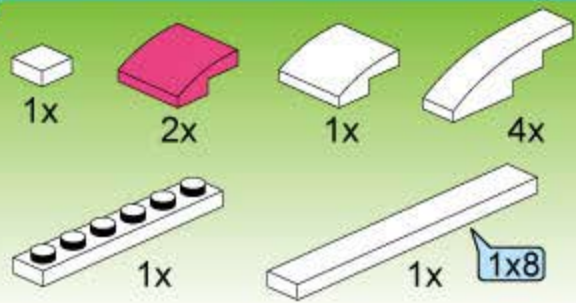

23

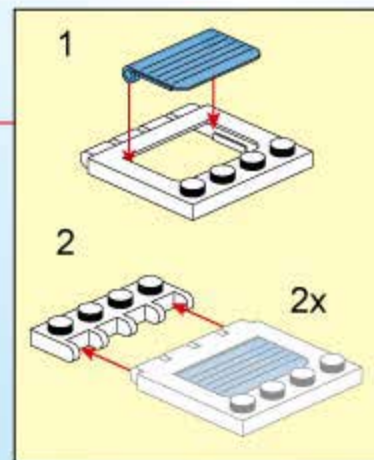
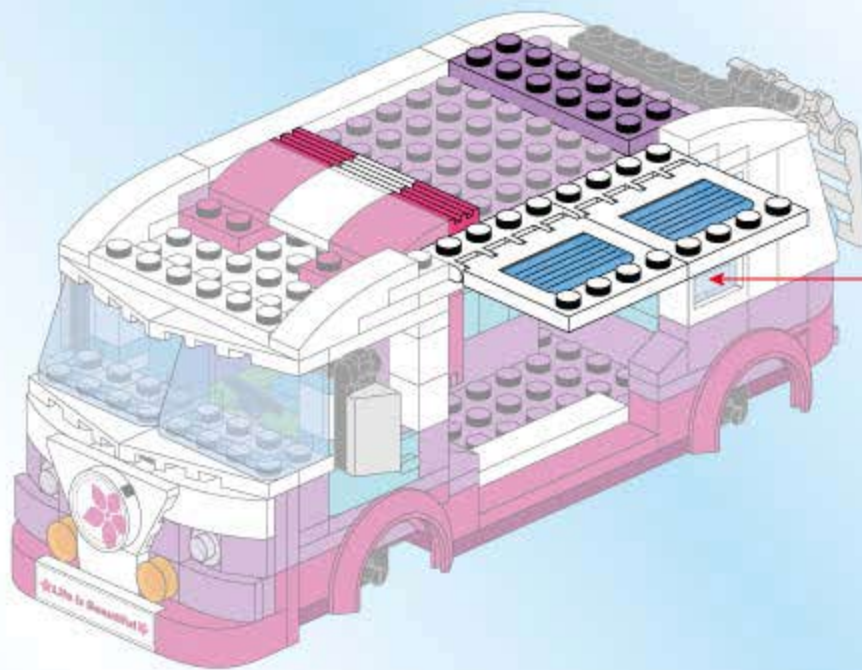
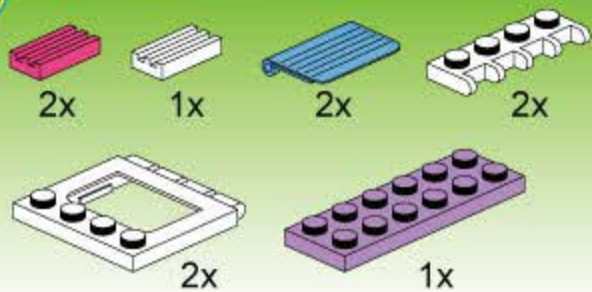

24

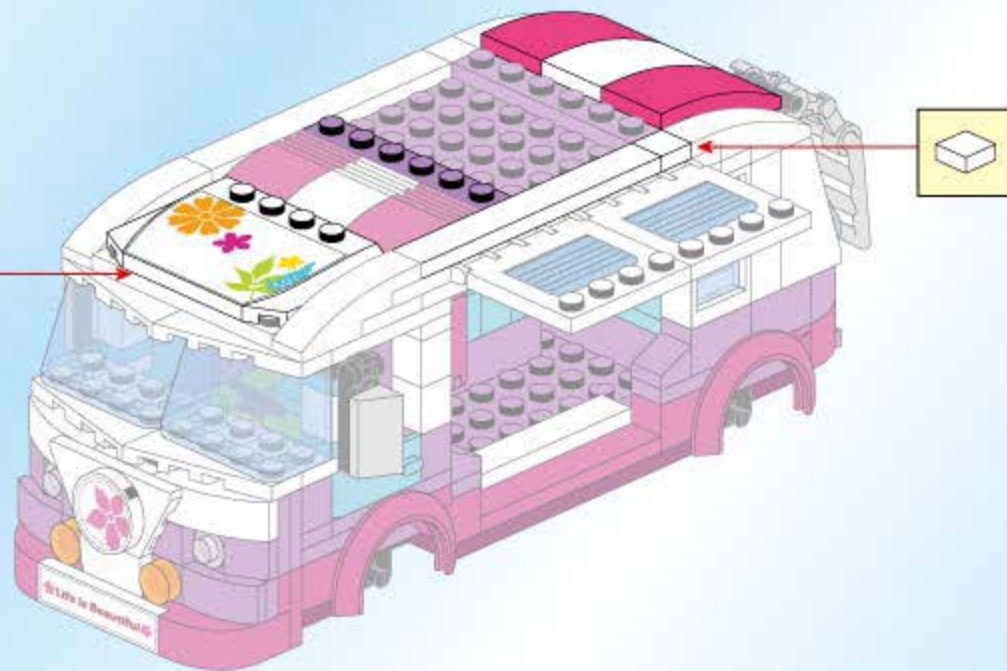
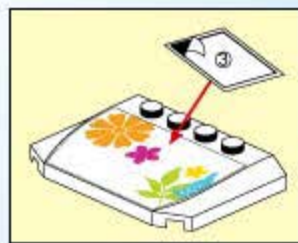
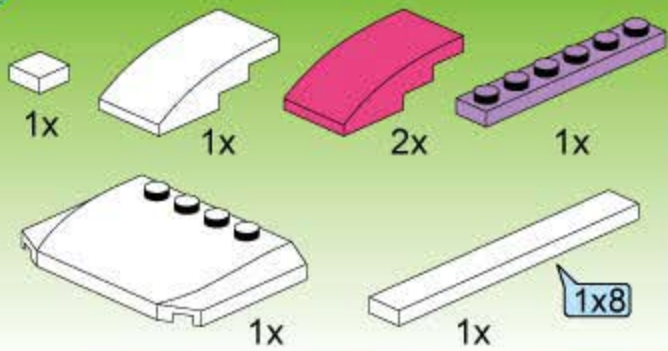

25

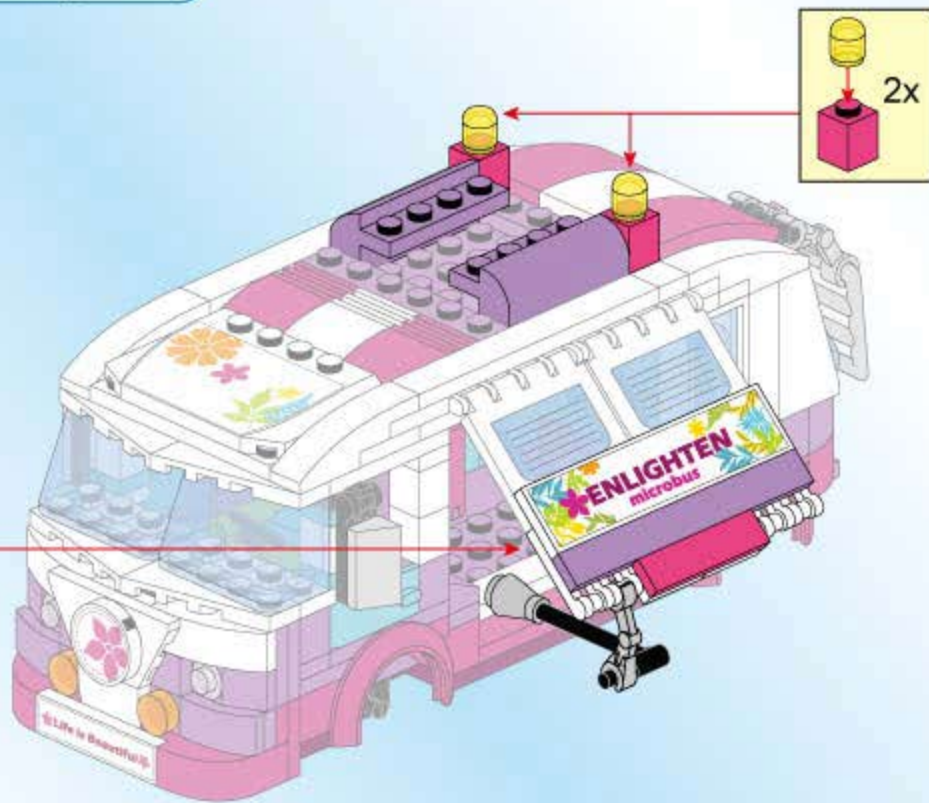
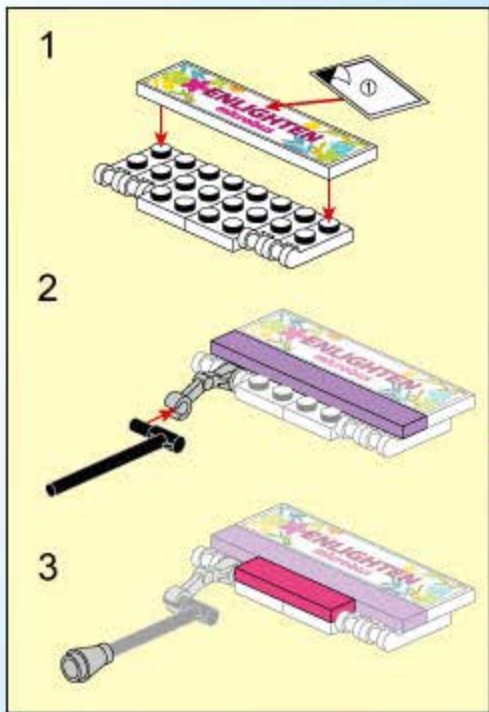
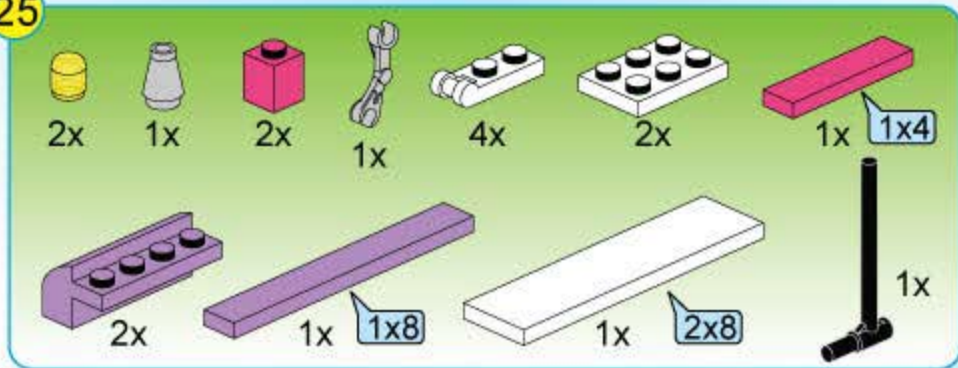

26

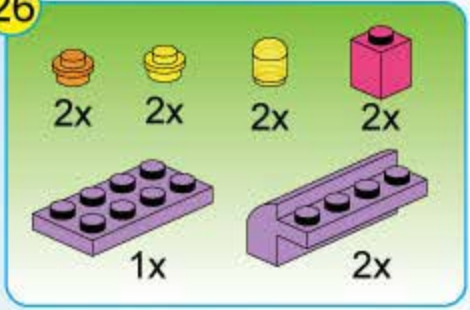

2x 2x 2x 2x

1x 2x

This block lists the required parts for step 26. It includes: two orange 1-hole Technic pins, two yellow 1-hole Technic pins, two yellow 1-hole Technic pins, two pink 1-hole Technic pins, one purple 1x6 Technic plate with 6 holes, and two purple 1x6 Technic plates with 4 holes.

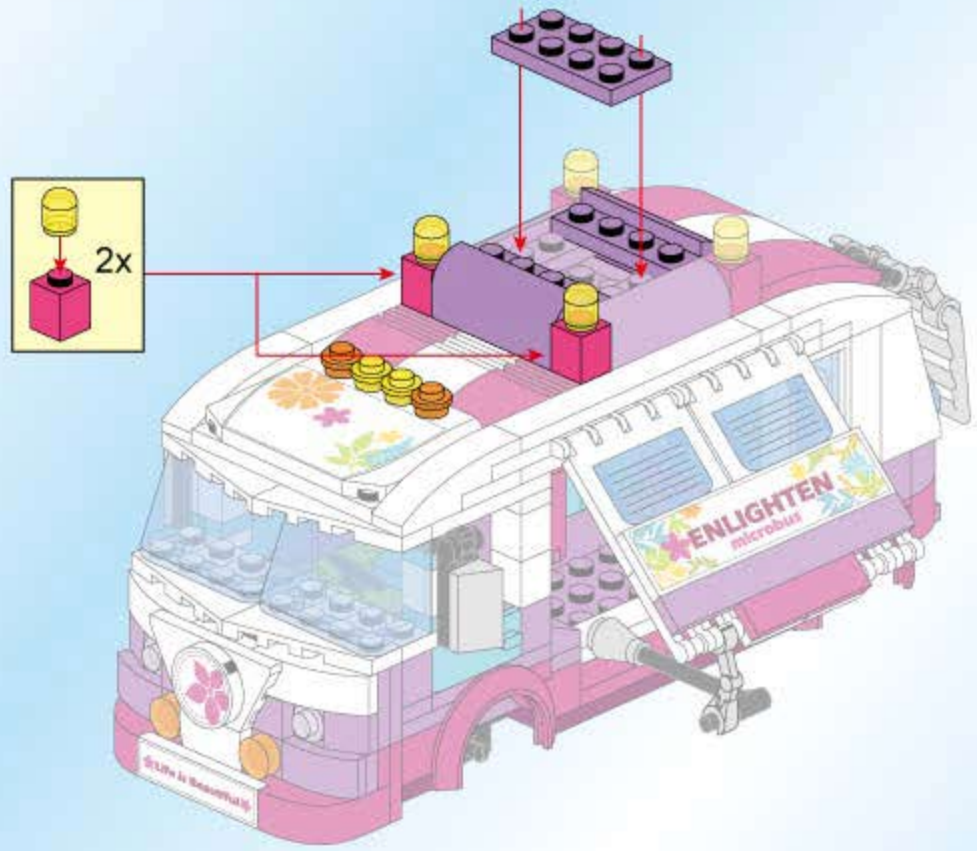

- 1x
- 1x
- 1x
- 1x
- 2x
- 4x
- 1x
- 2x
- 1x
- 2x
- 2x
- 1x
- 1x
- 1x
- 1x
- 1x
- 1x
- 2x
- 4x
- 1x
- 1x

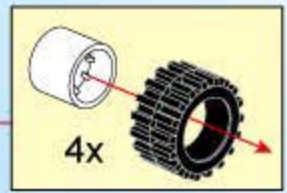
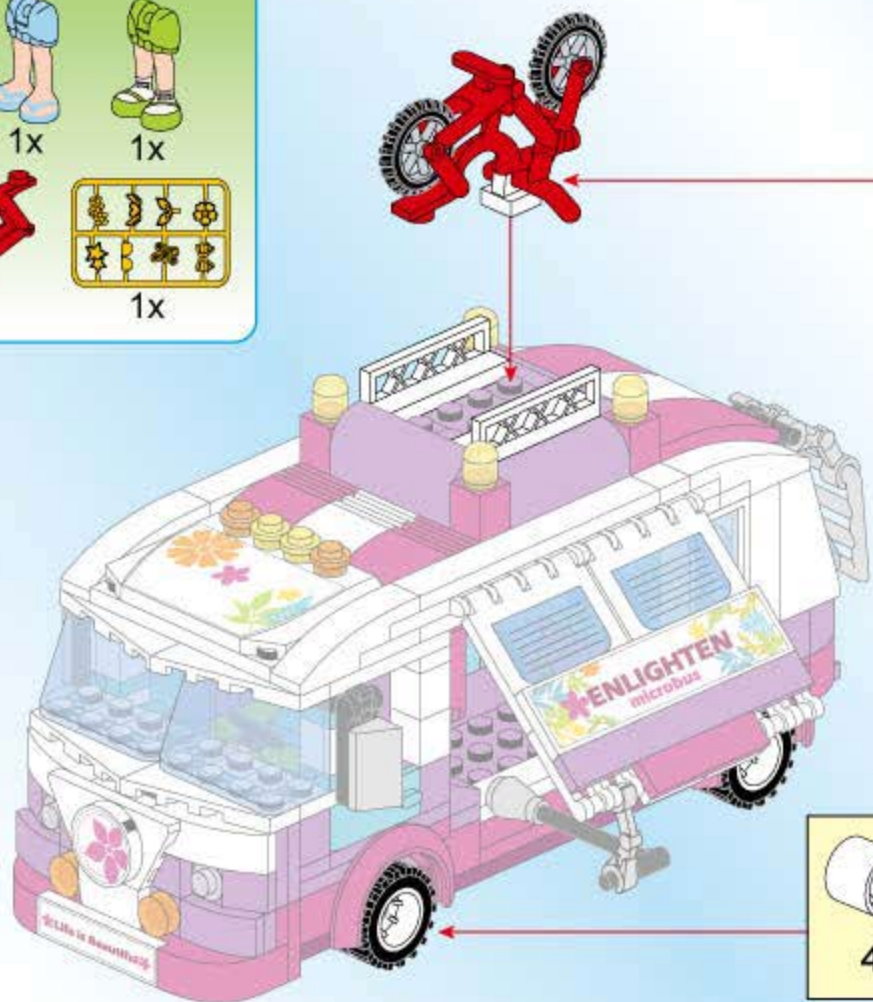
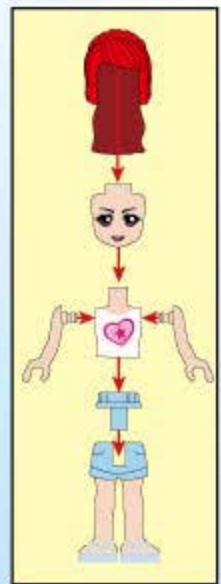



2004

# Cherry



2001 CHERRY'S BEDROM



2002 DOLPHIN TREVI FOUNTAIN



2003 ABBY'S CAFE



2004 OUTING TRIP BUS



2007 STAR TRAINING CENTER



2006 ENLI CITY BEAUTY SHOP



2005 ENLI CITY BOUTIQUE