



TACTICAL ESPIONAGE ACTION
COMBAT ZONE
F I R E

1724

Ages: 6+

Minifigs: X3

pcs: 1007



ENTERPRISE THE AIRCRAFT CARRIER



+



=

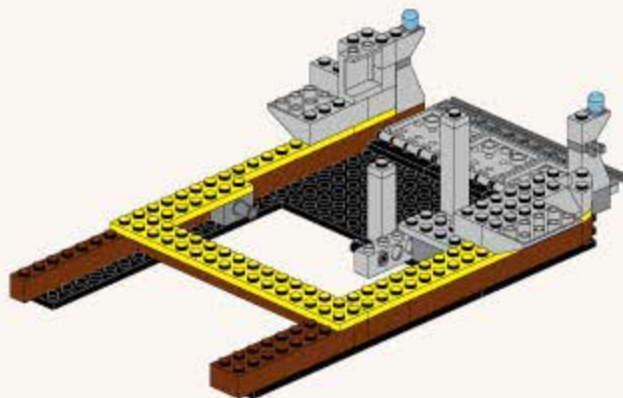

拆件器使用方法, 仅为示例

Usage of Brick Separator, Just for the sample

1

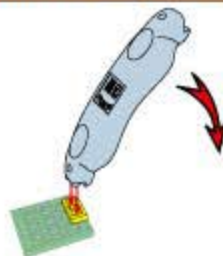

2

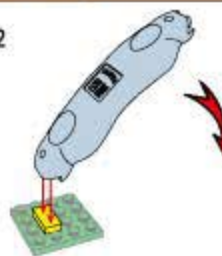

3

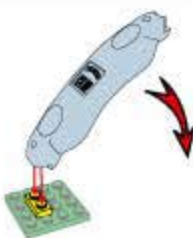

4

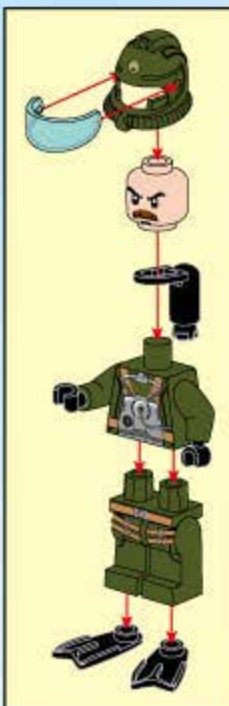
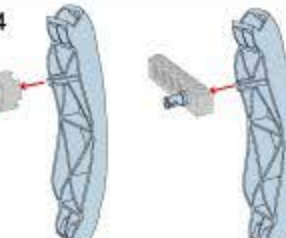

sketch map of fitting hand
装手示意图

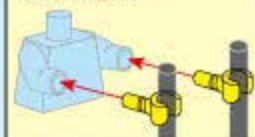

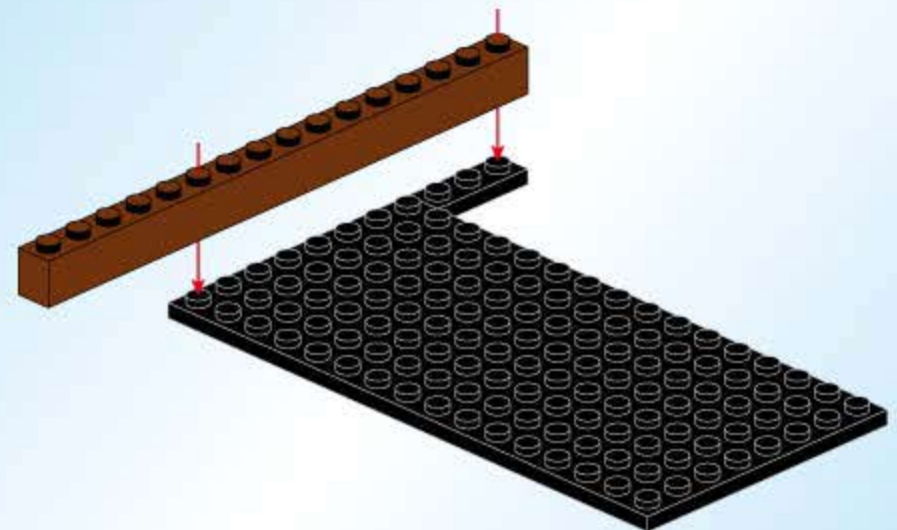
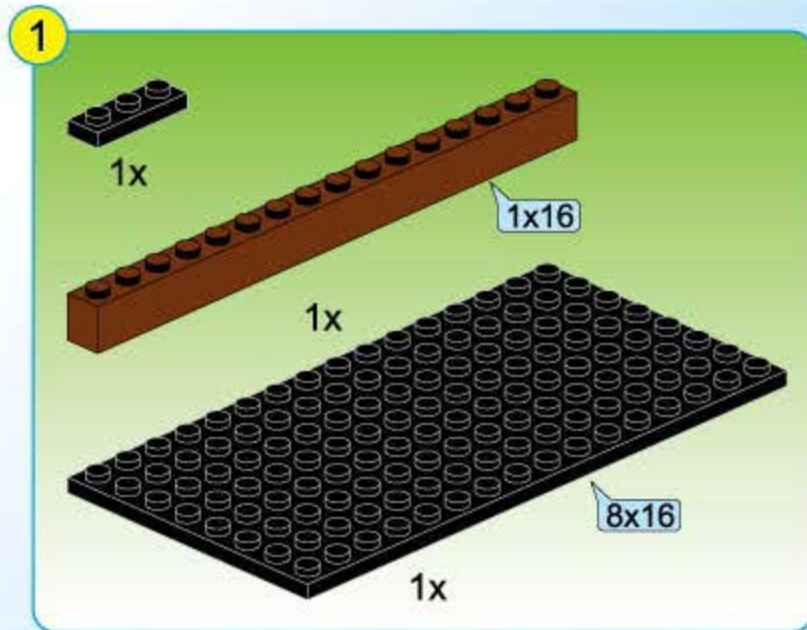
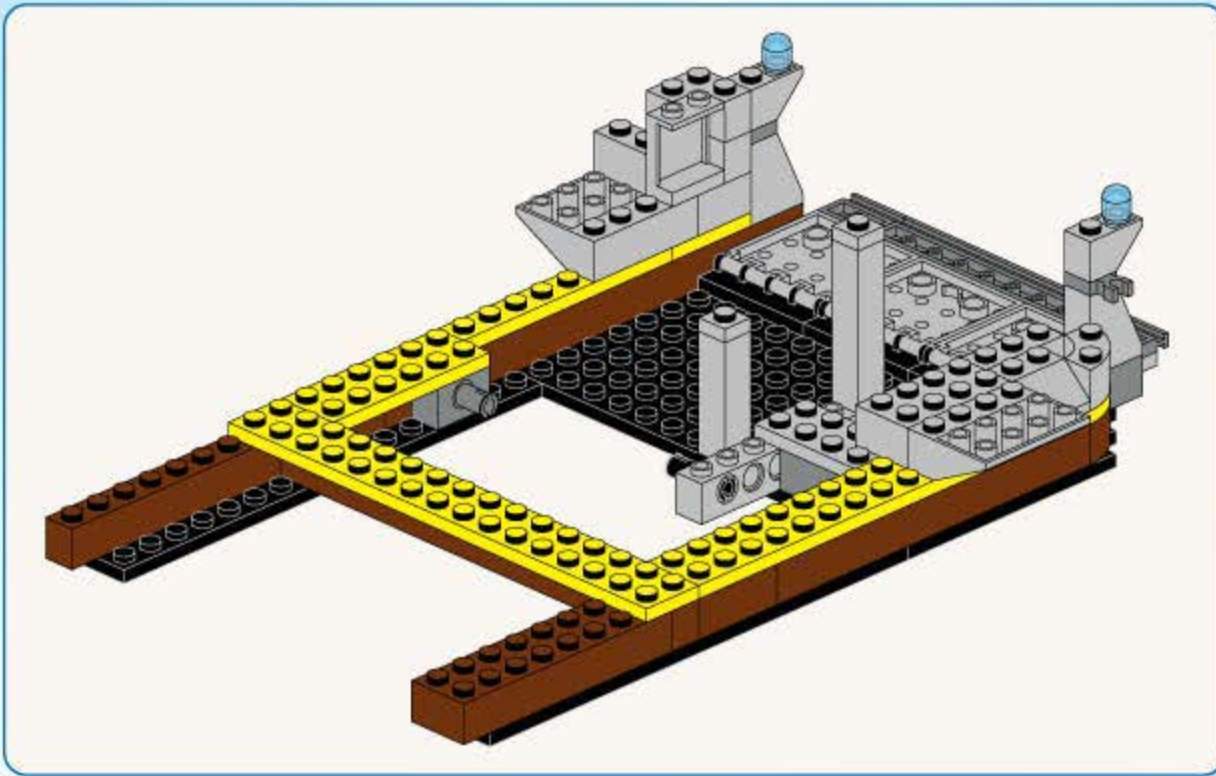

2

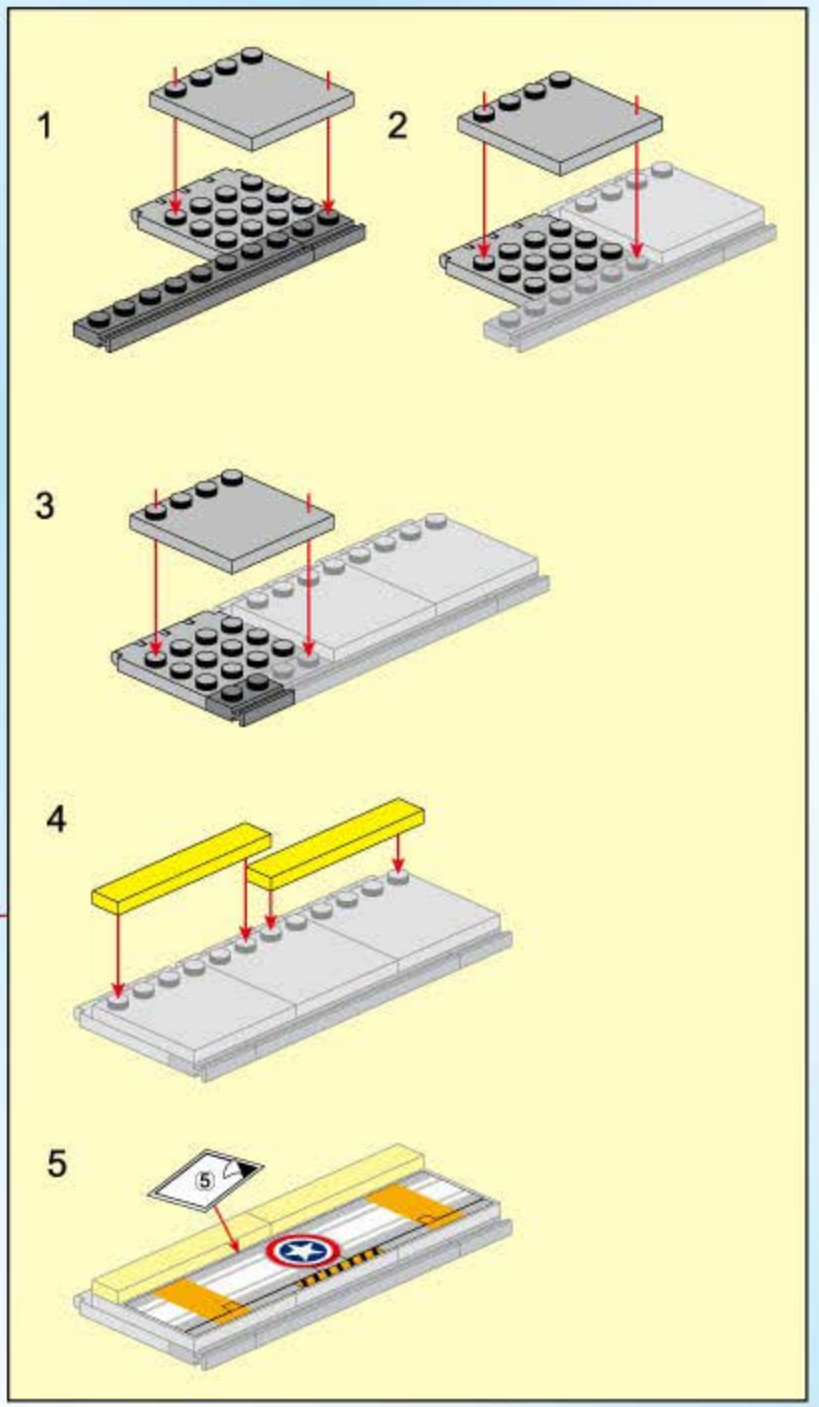
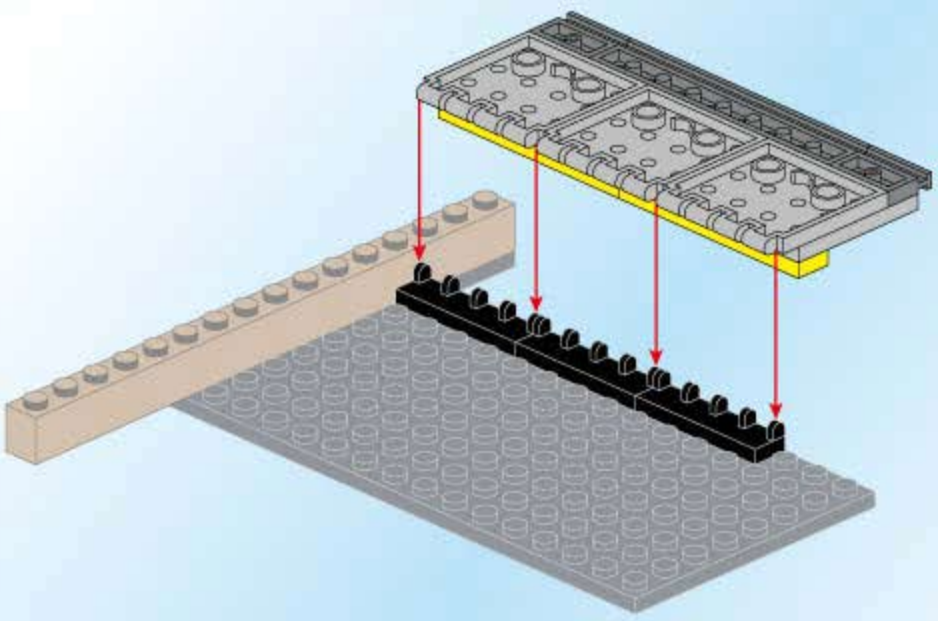
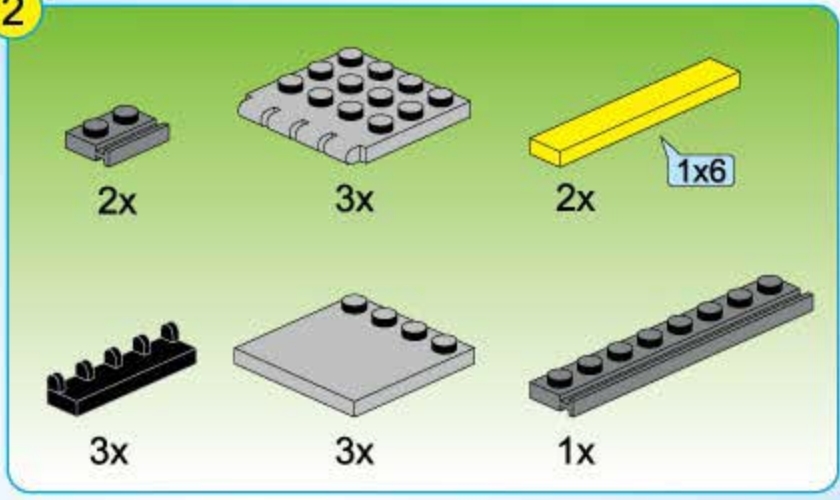

3

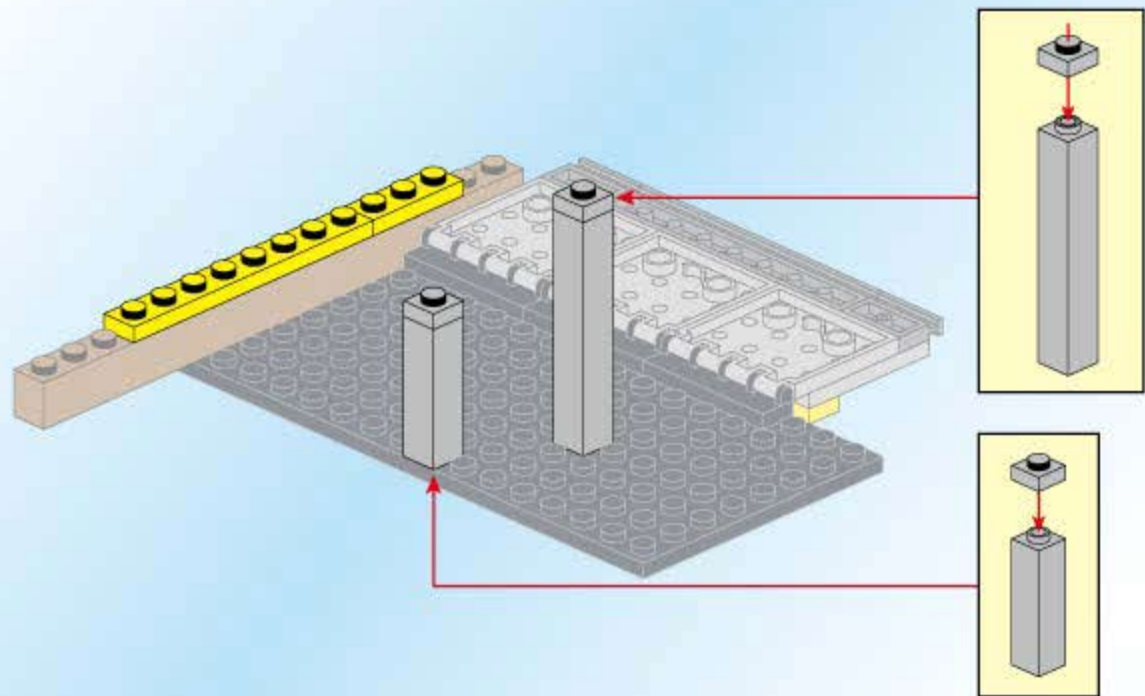
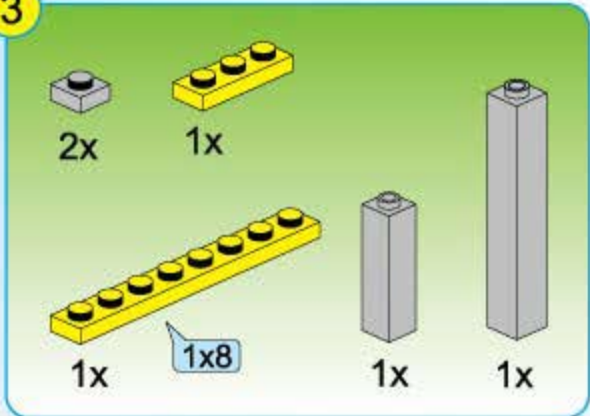

4

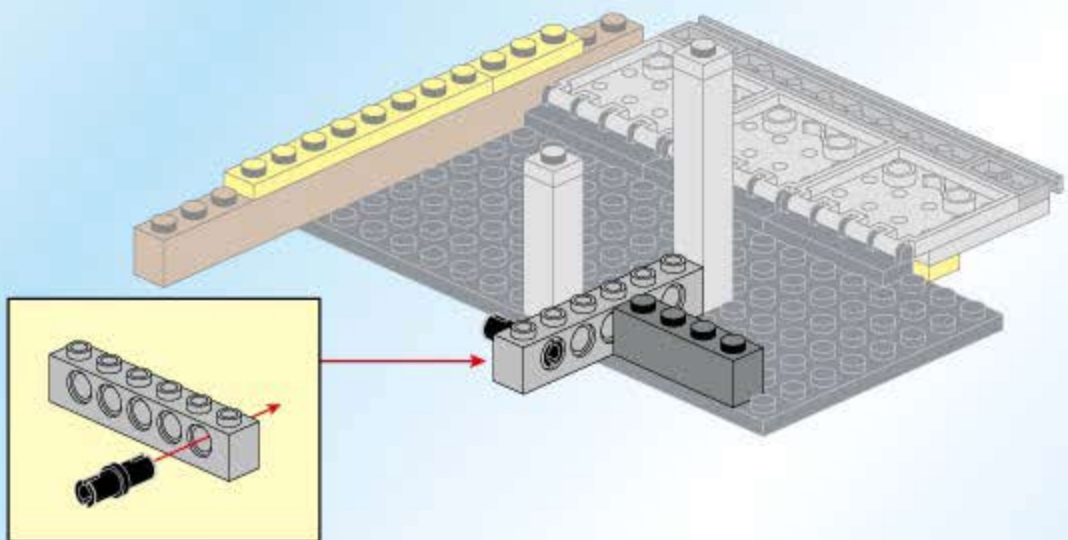
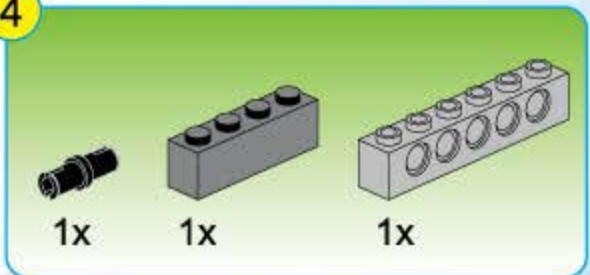

5



1x

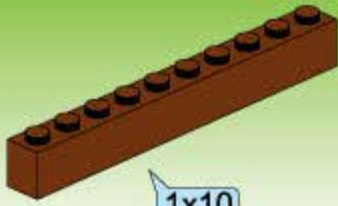

1x

1x10

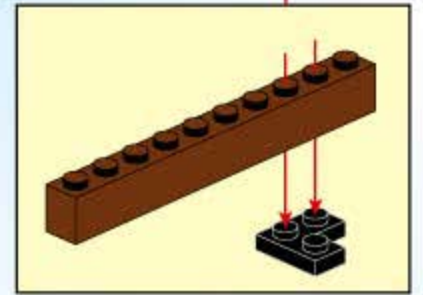
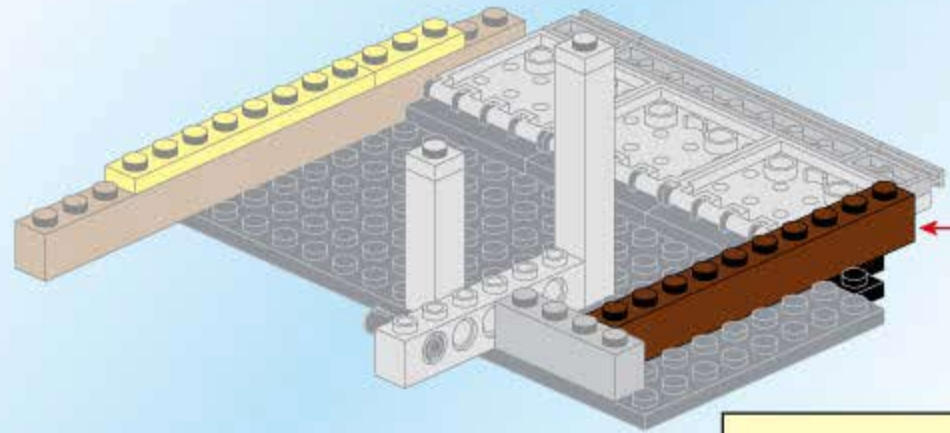

6



2x



1x



2x

1x12

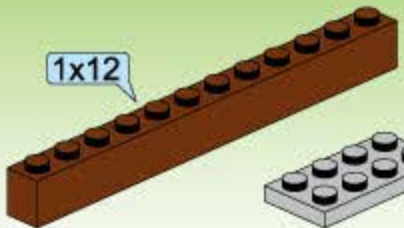

1x



1x

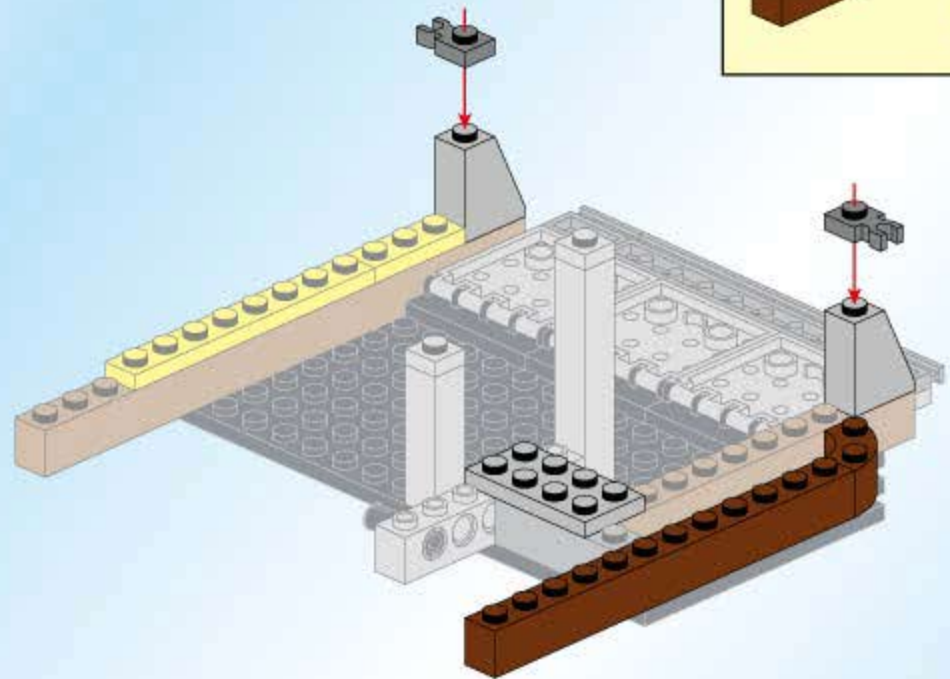

7

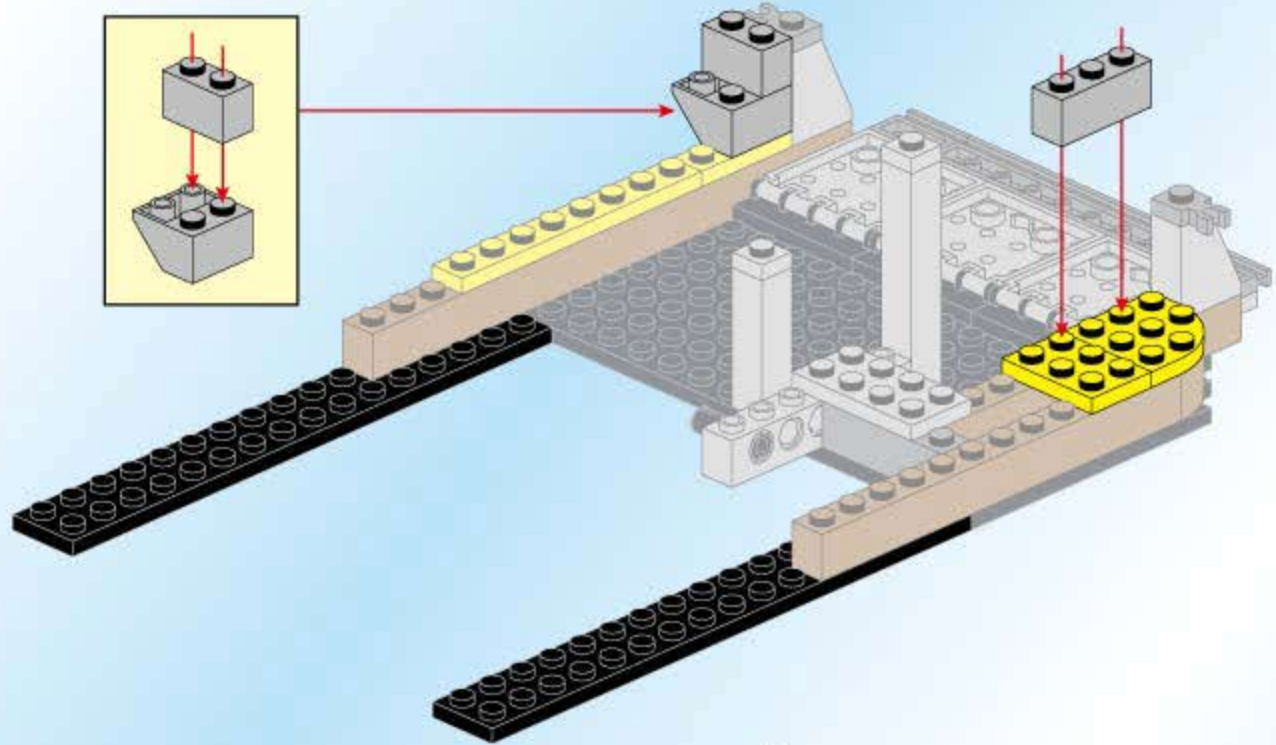
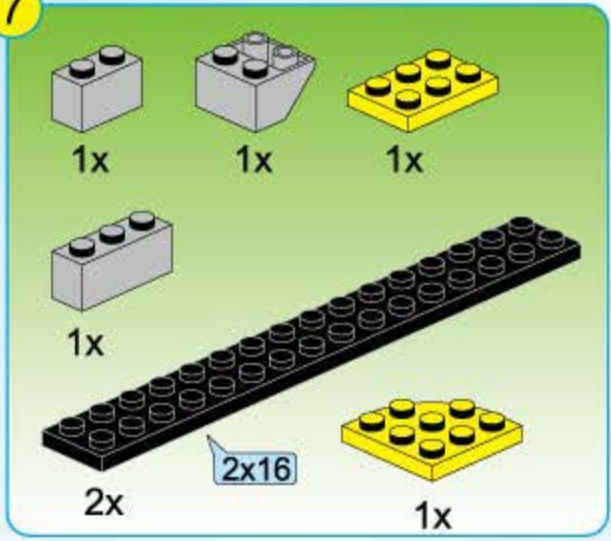

8

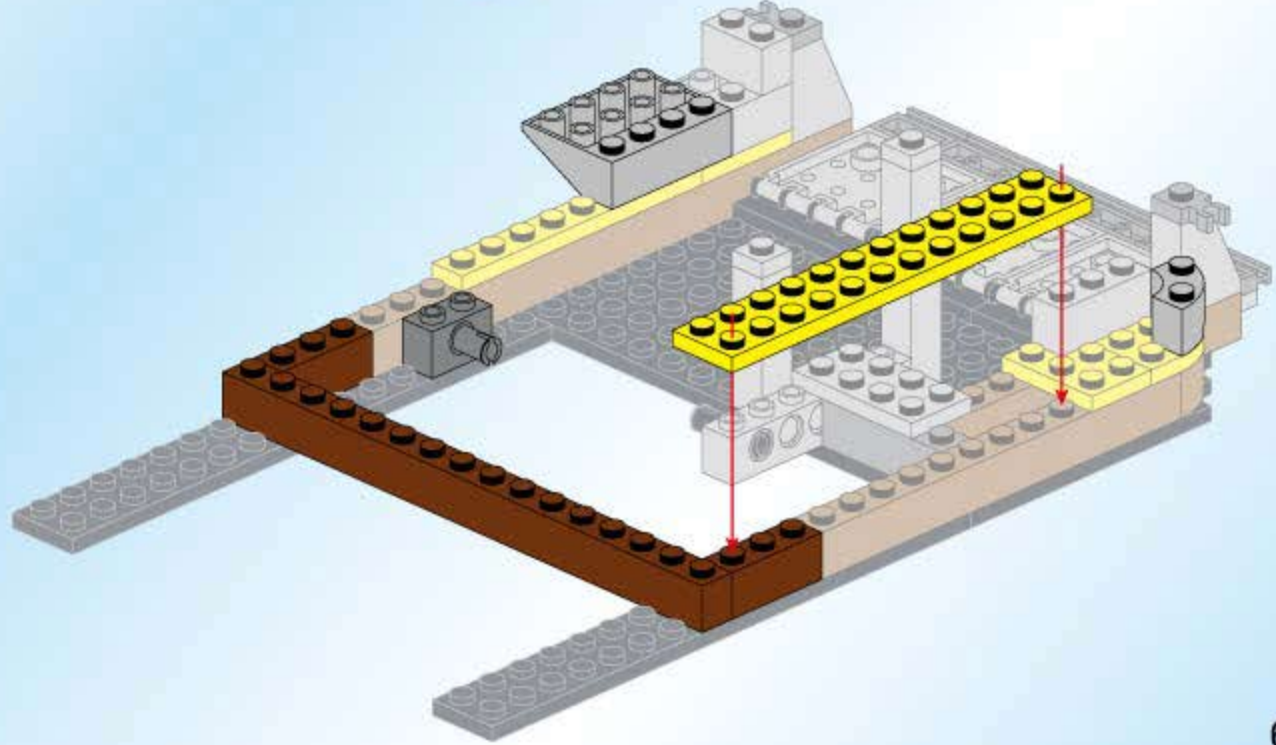
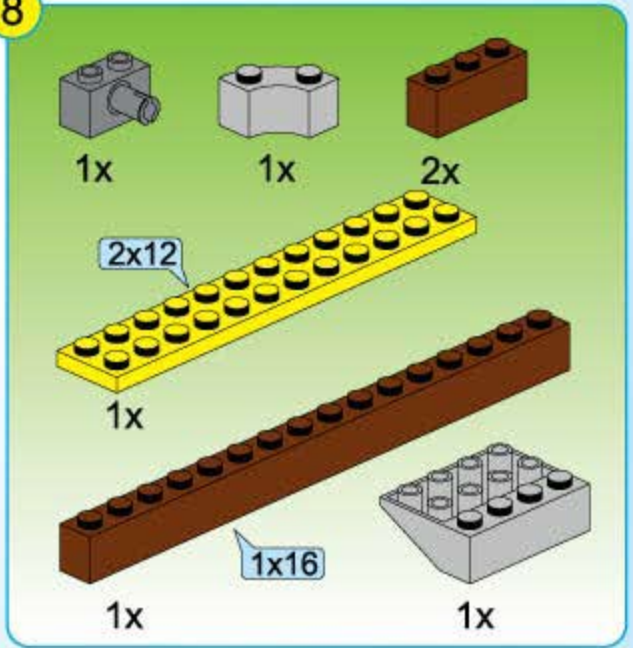

9

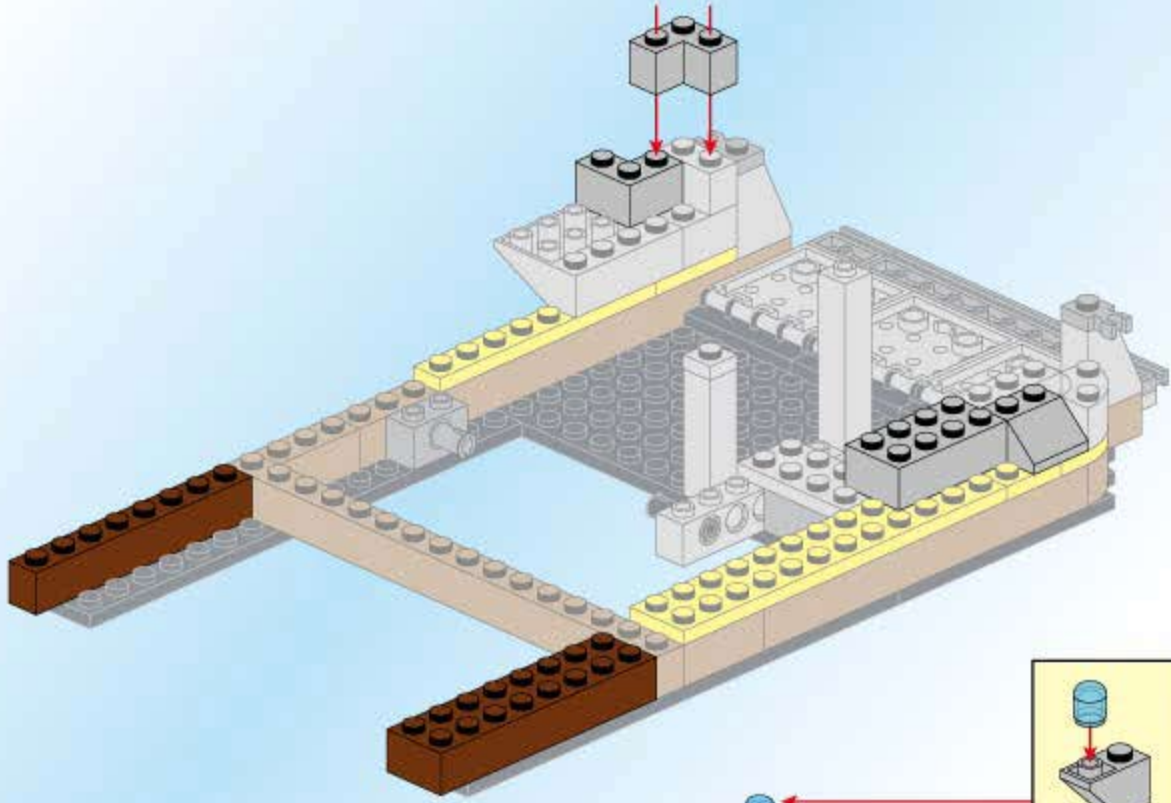
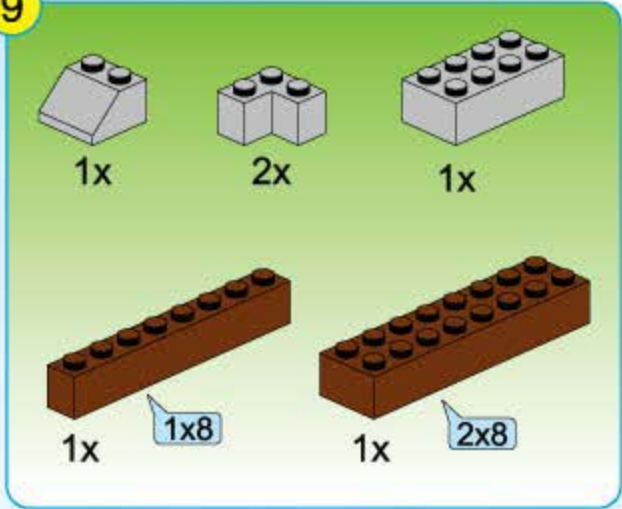

10

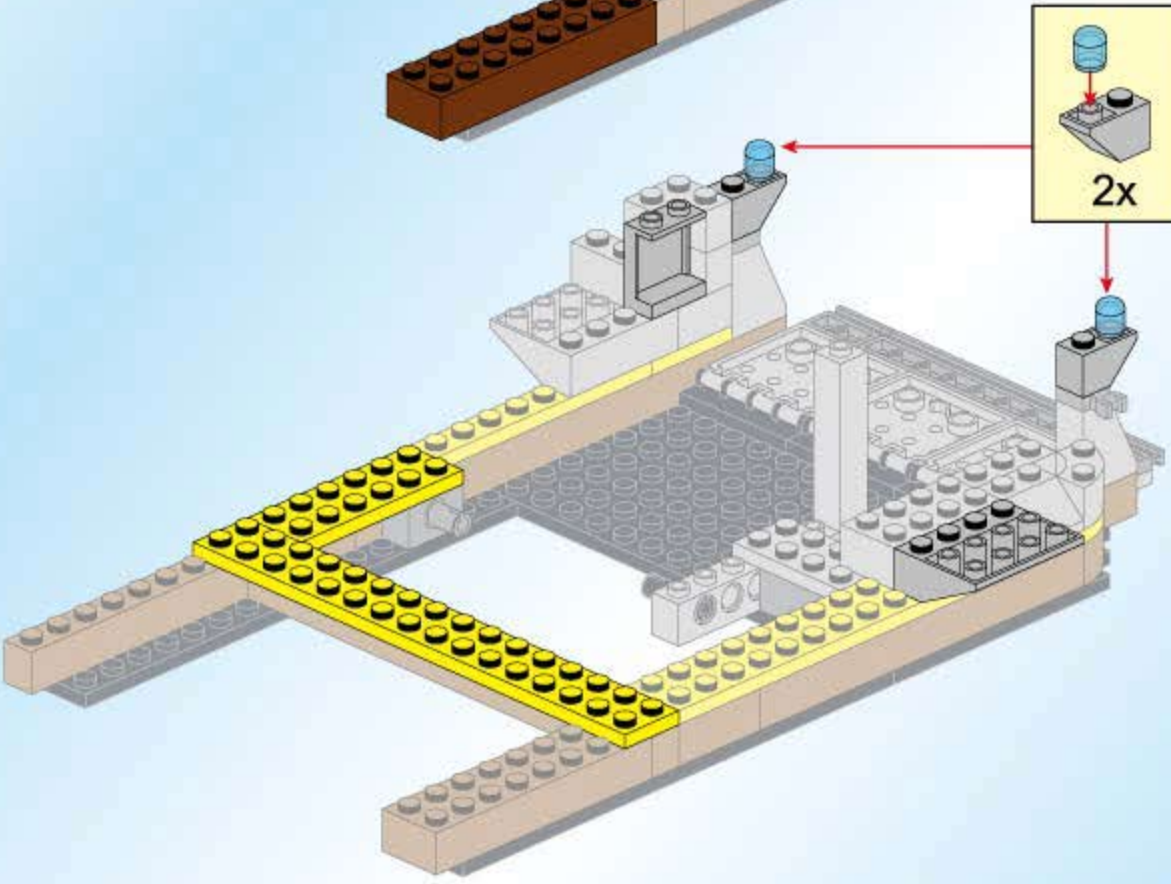
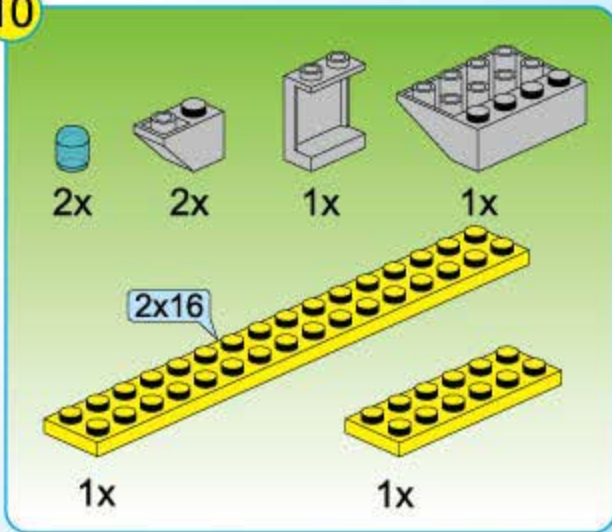



+ =

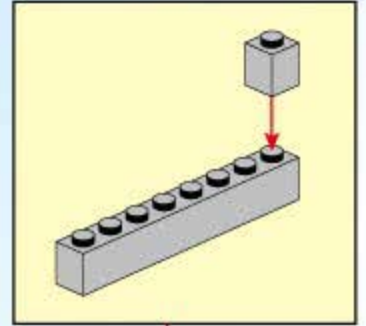
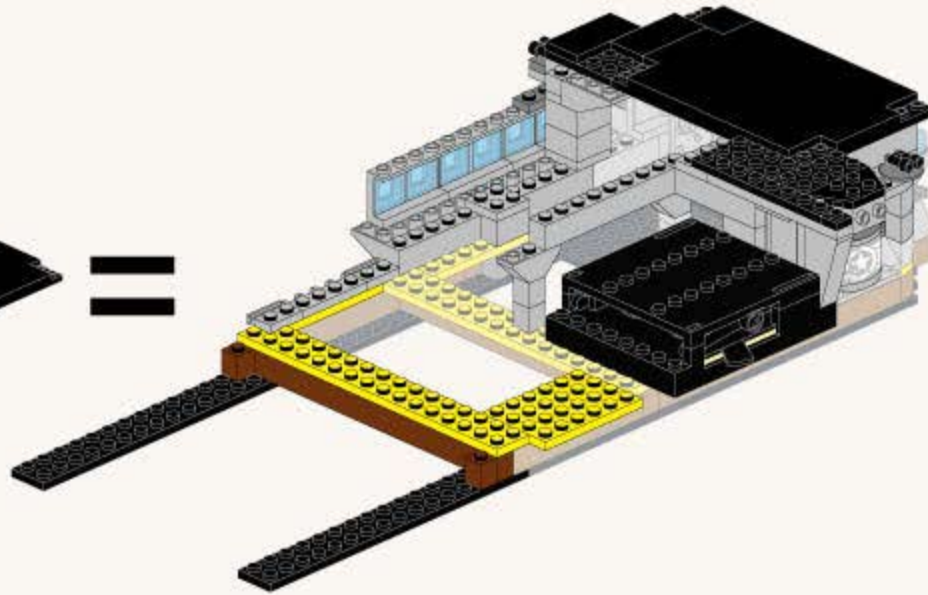

11

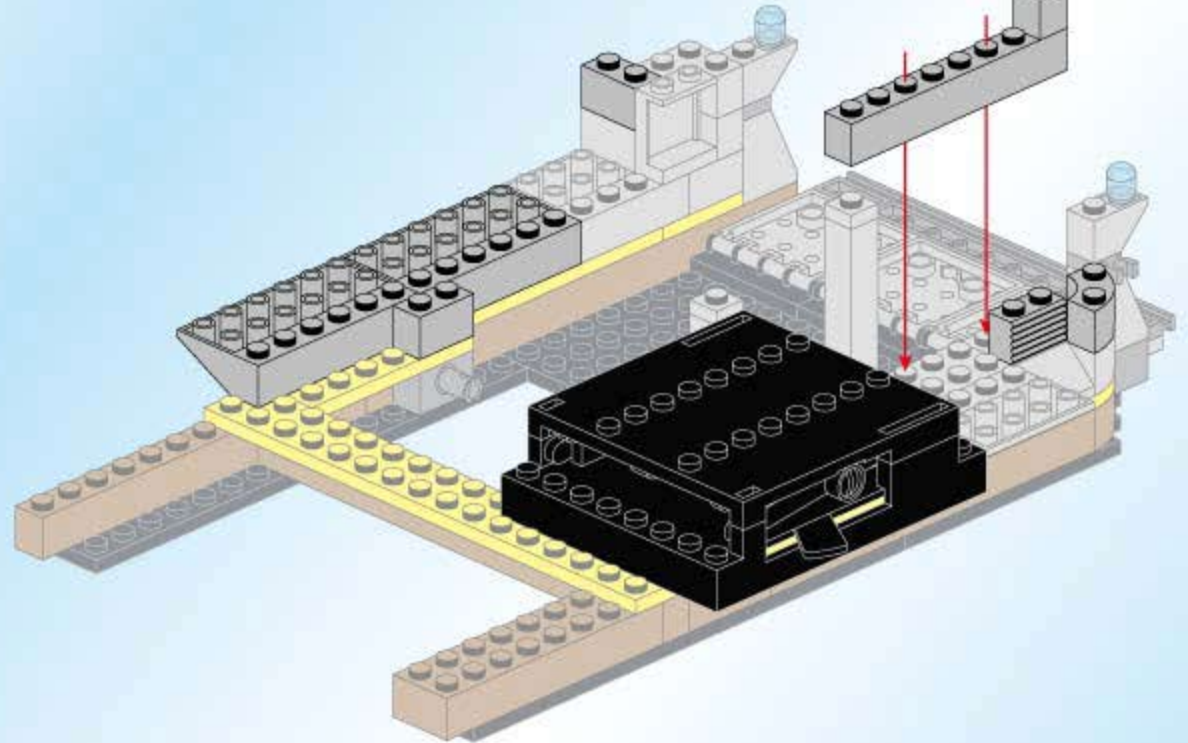
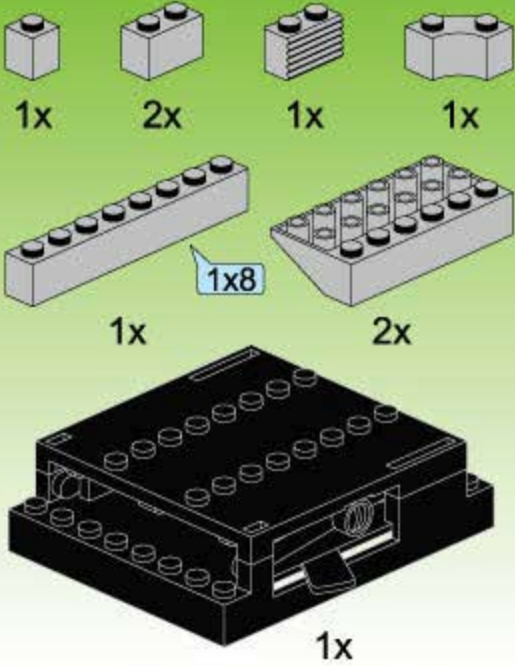

12

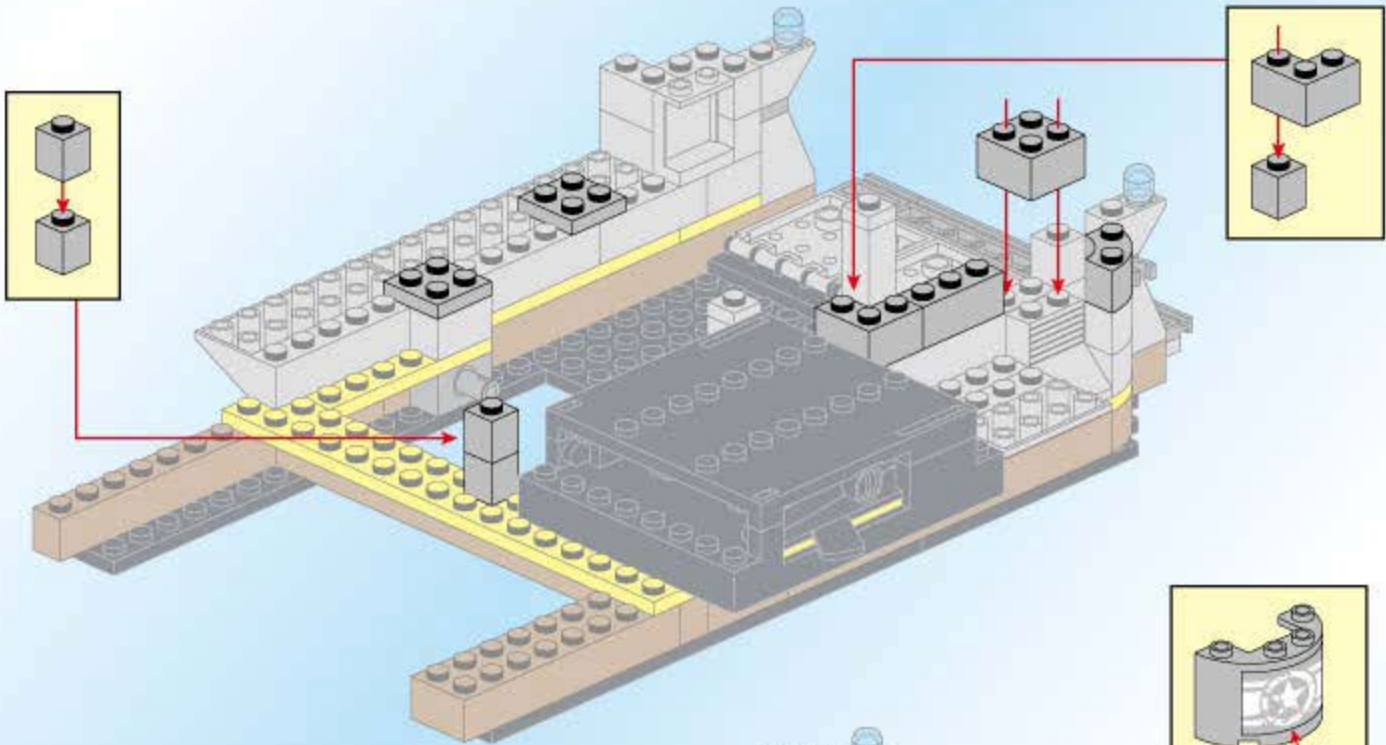
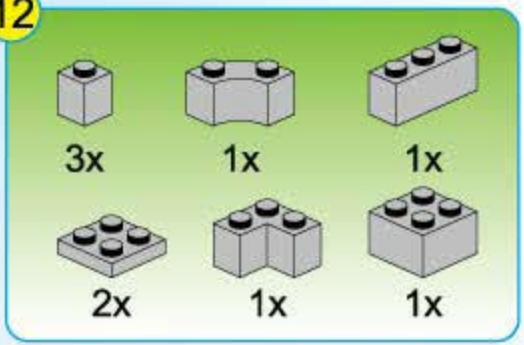

13

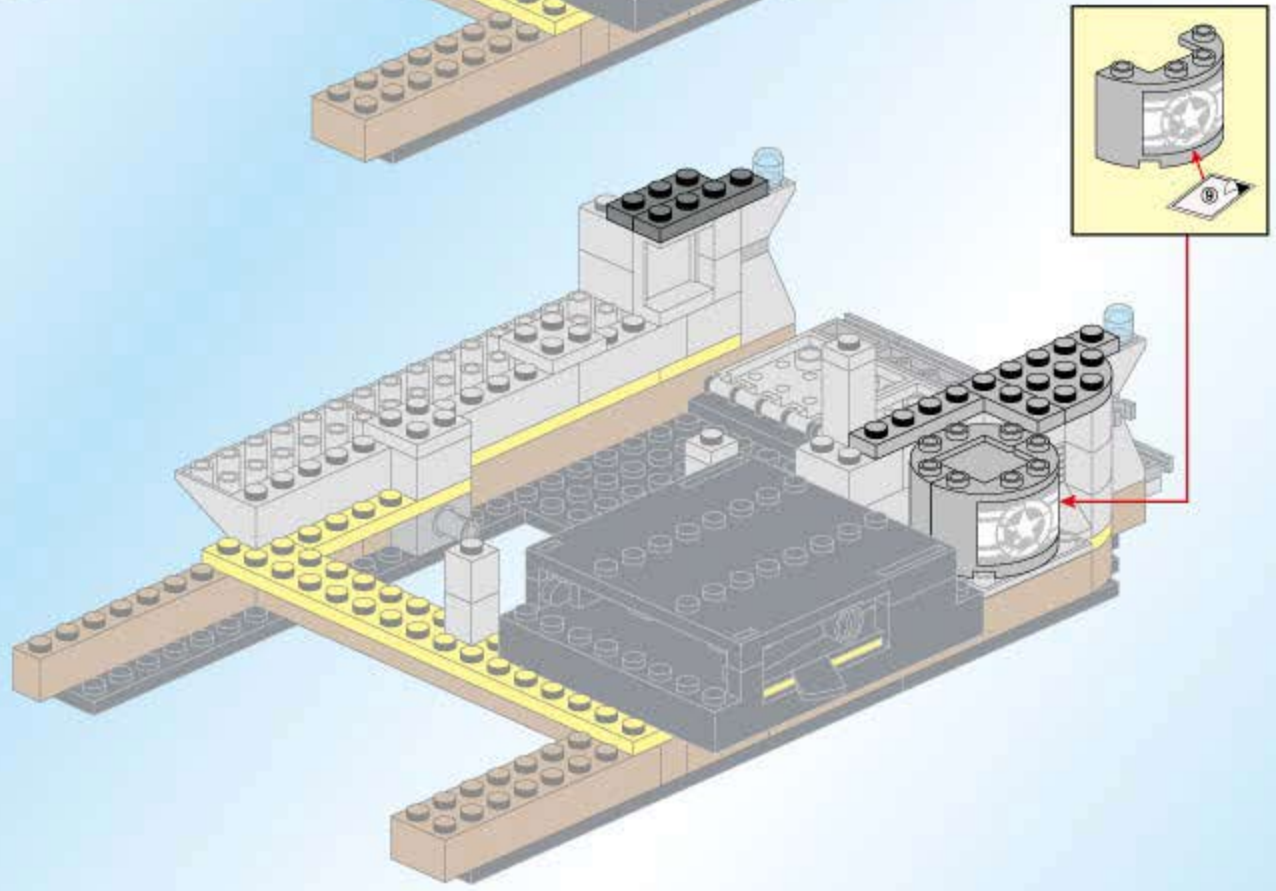
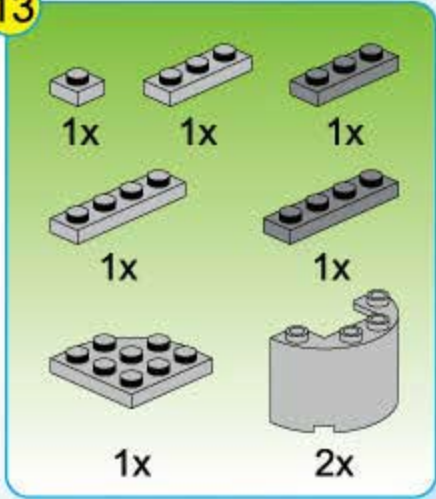

14

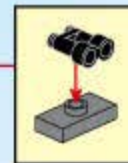
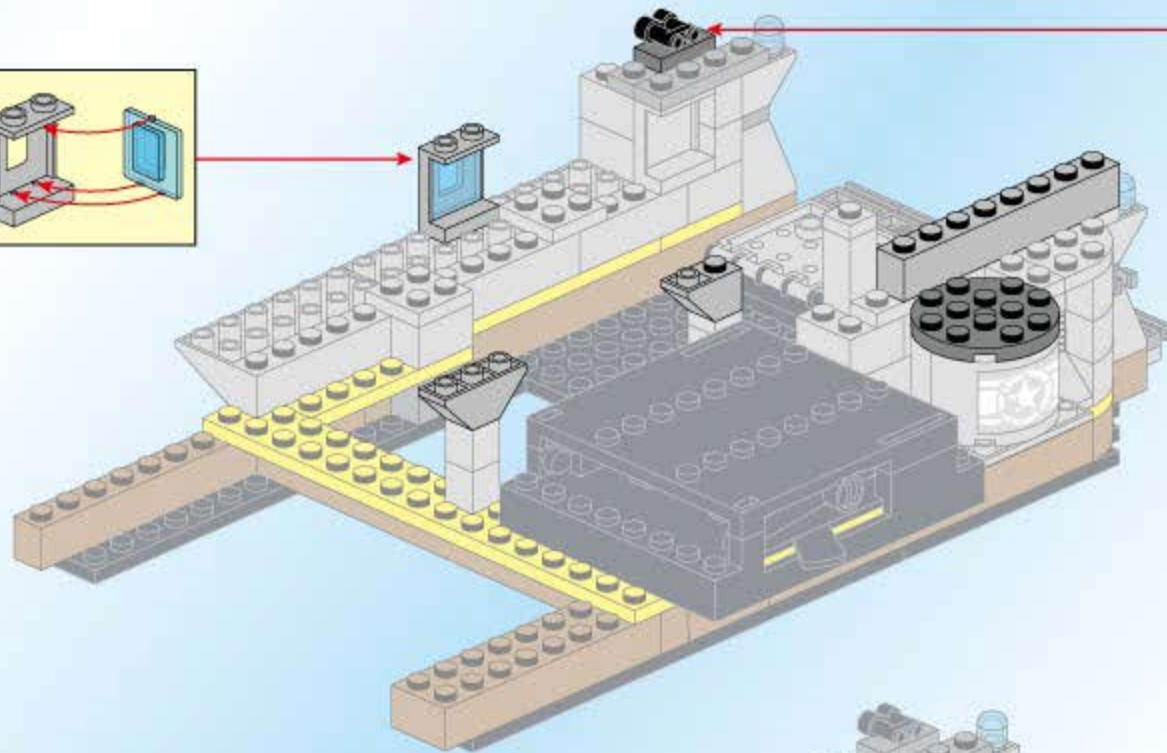
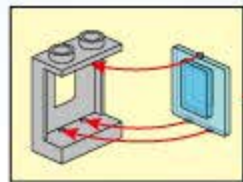
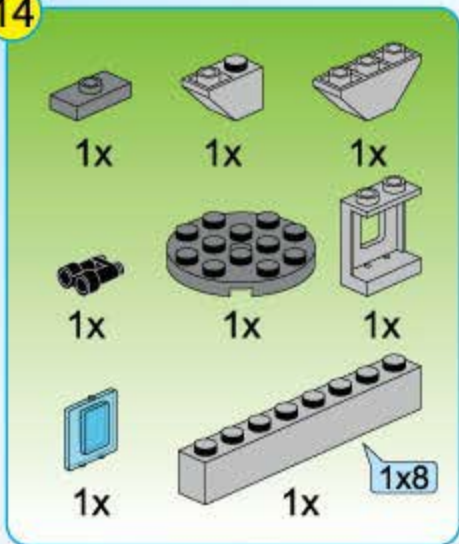

15

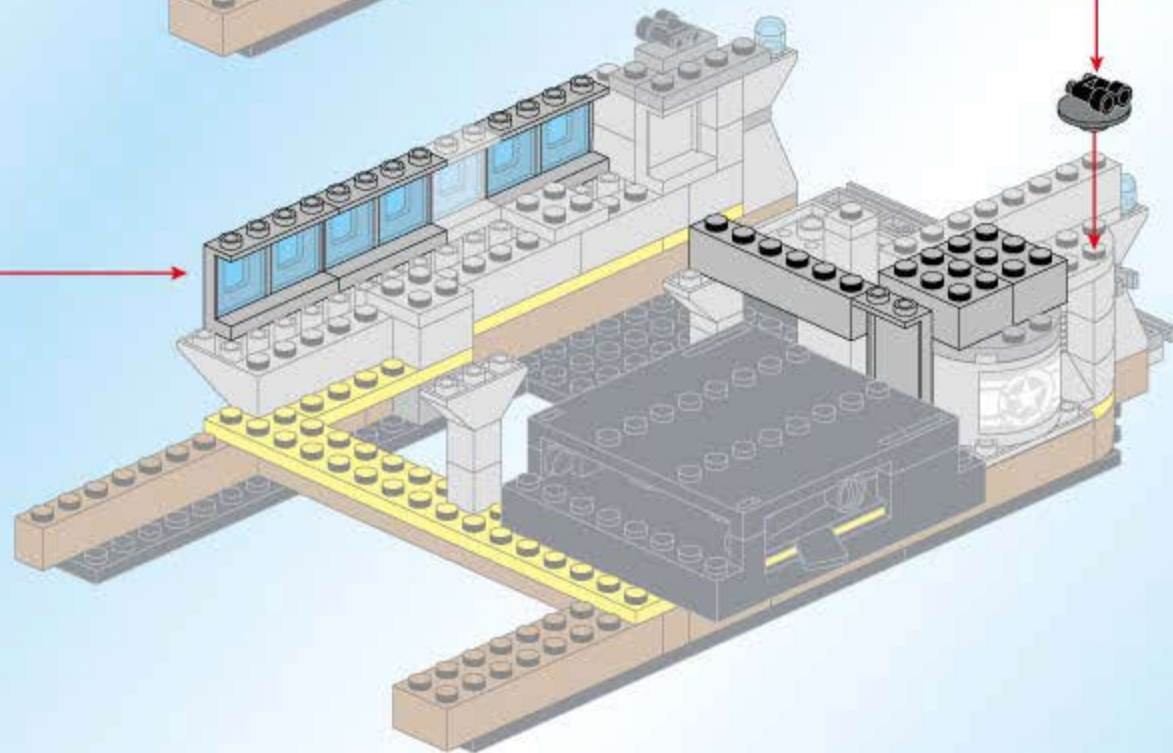
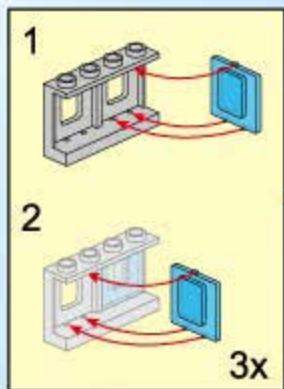
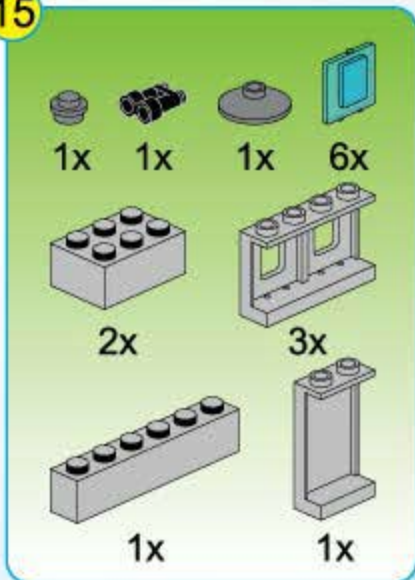

16

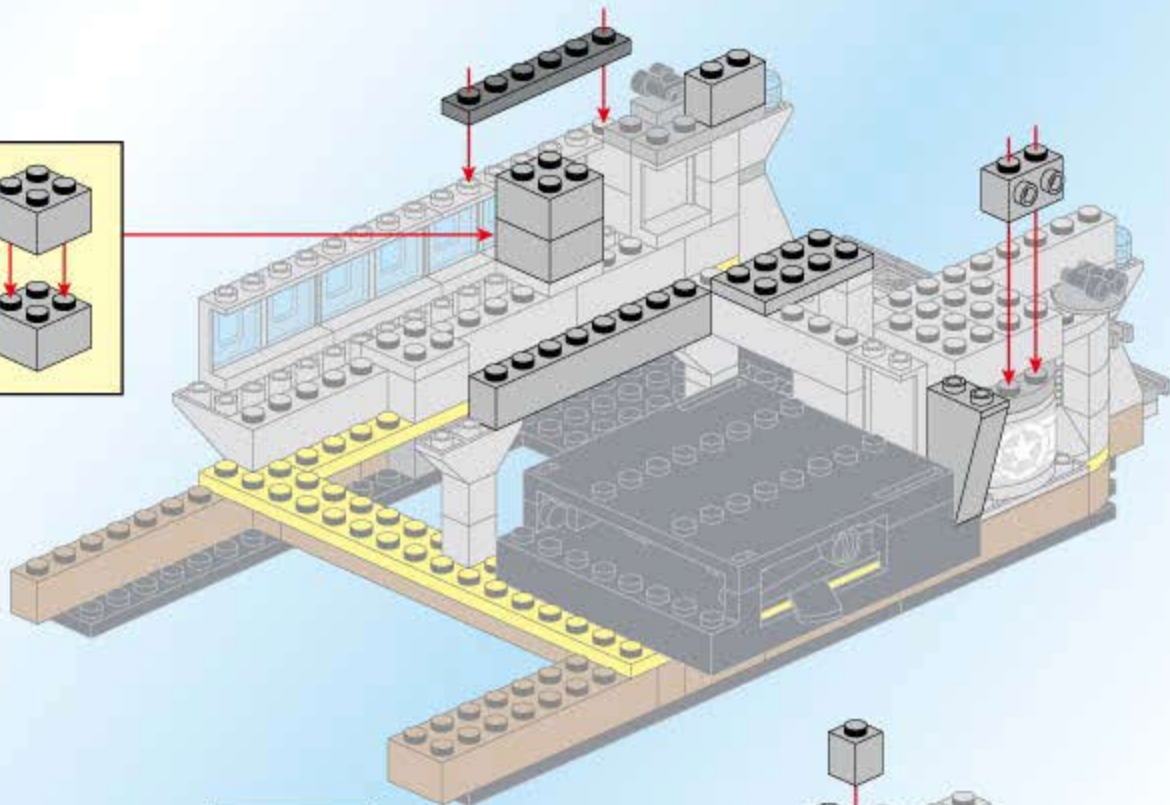
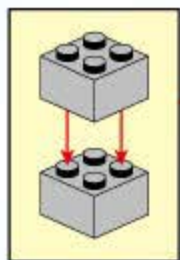
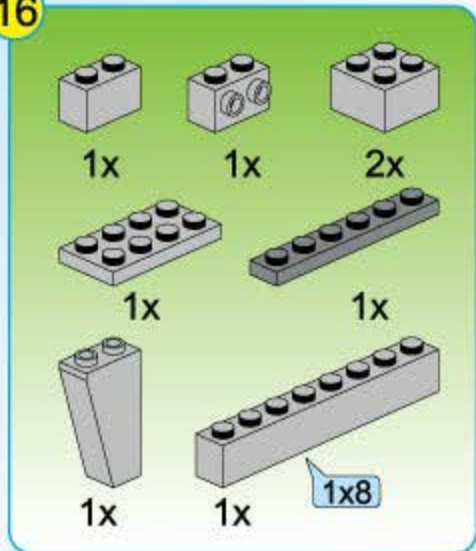

17

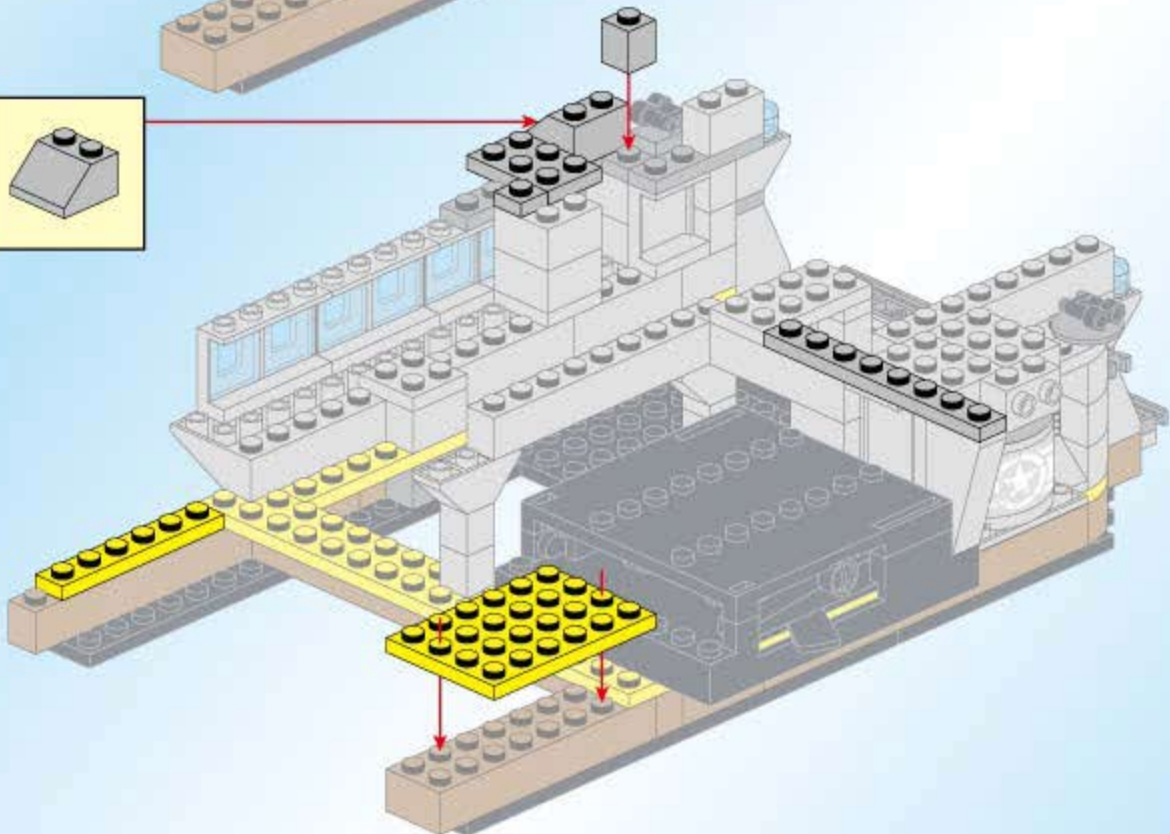
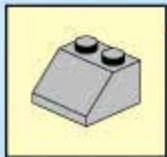
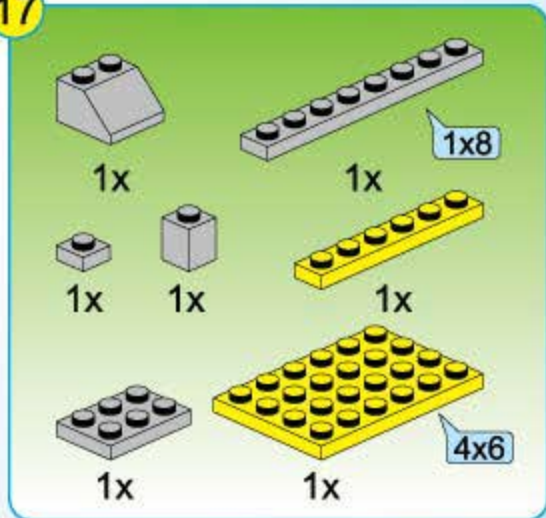

18

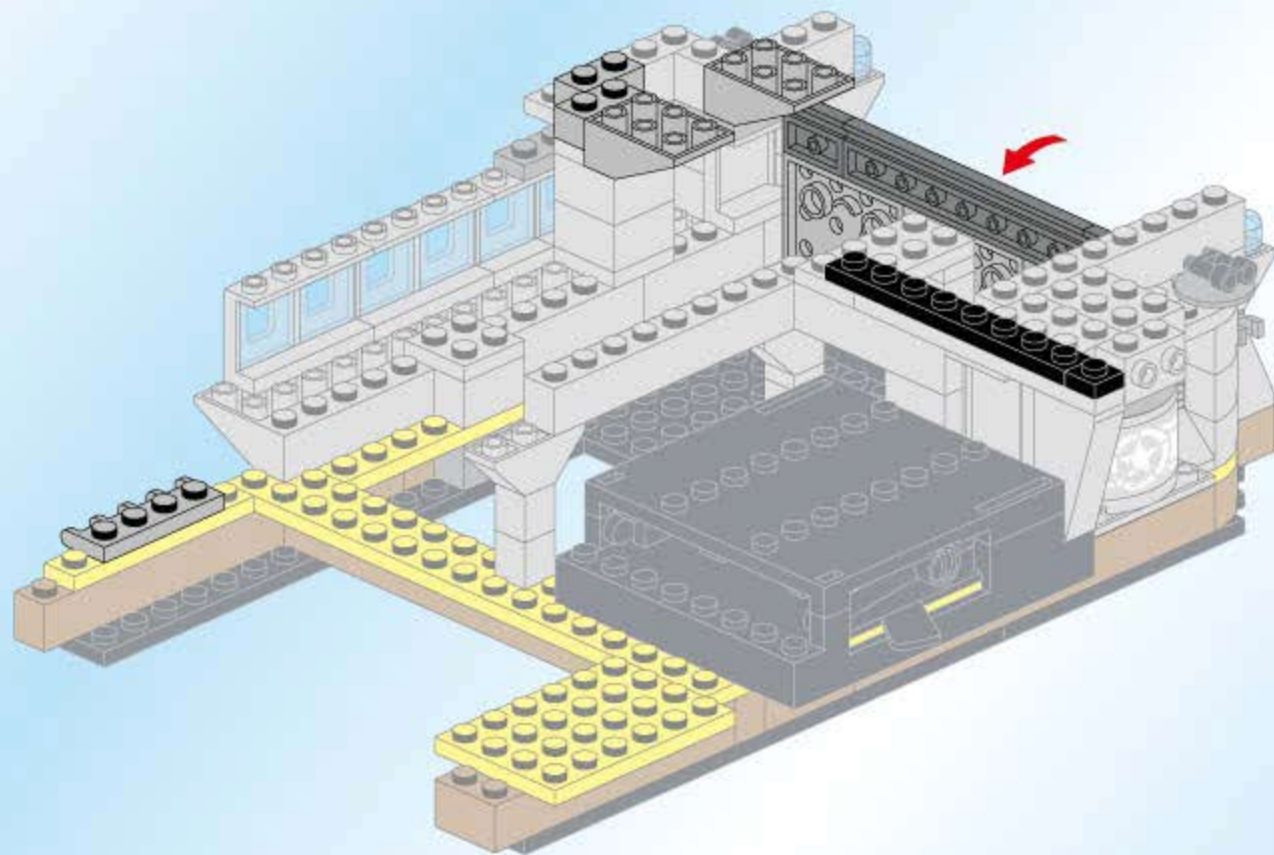
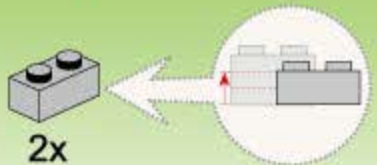

19

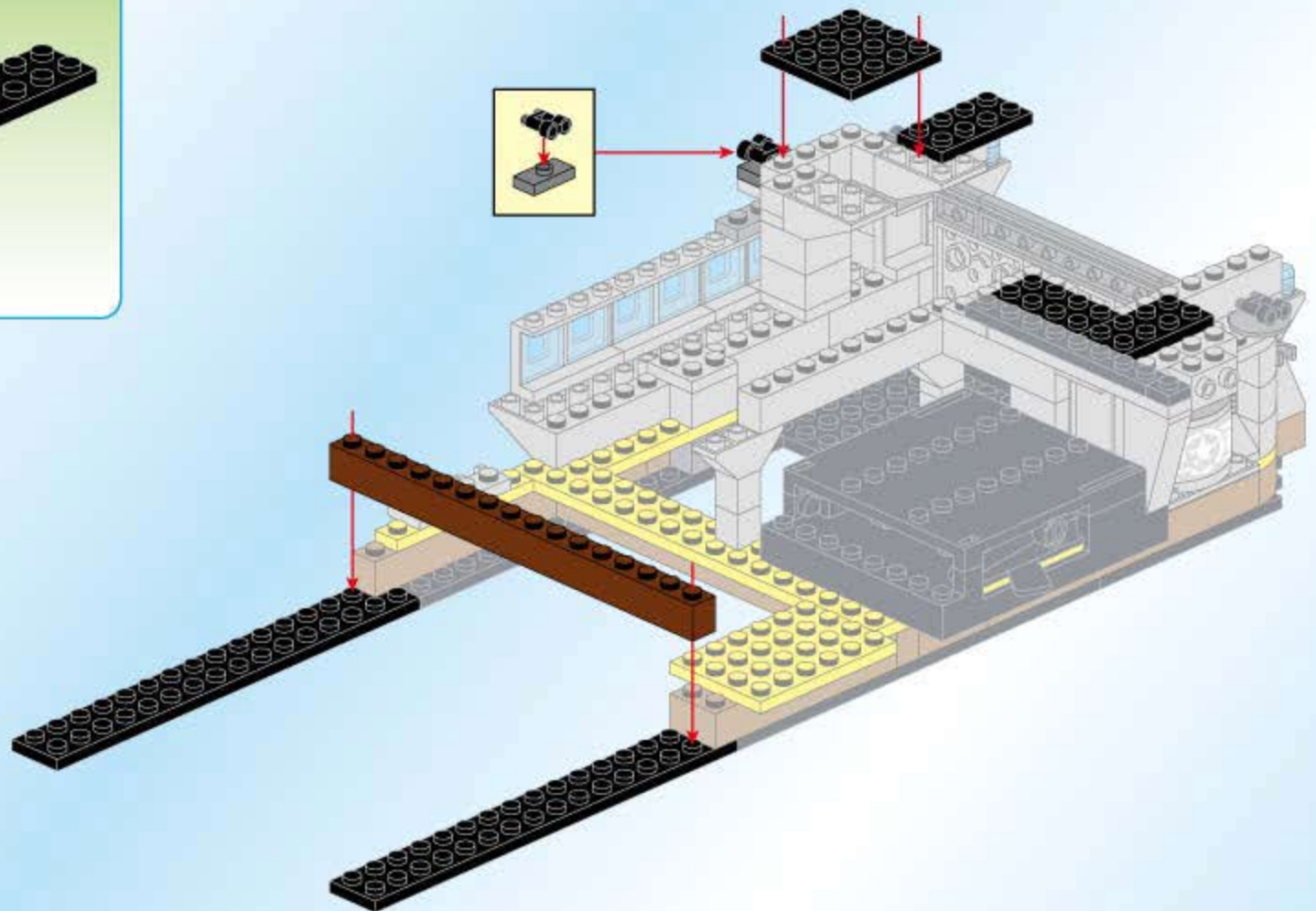
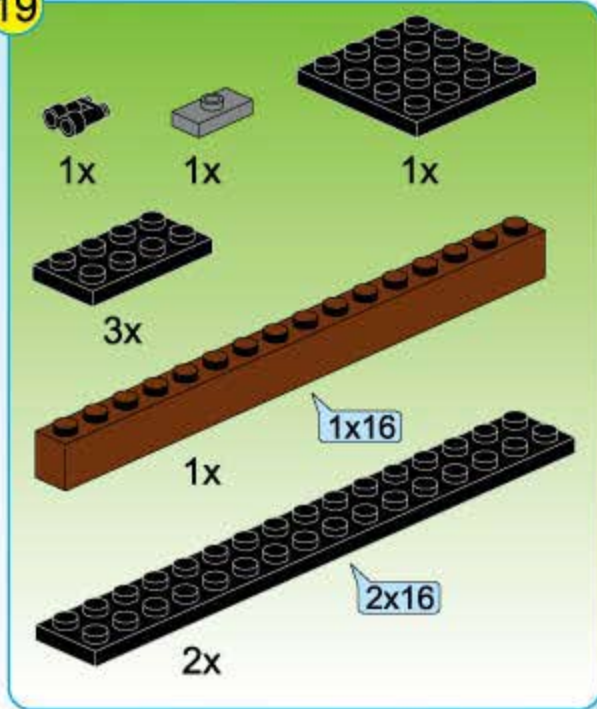

20

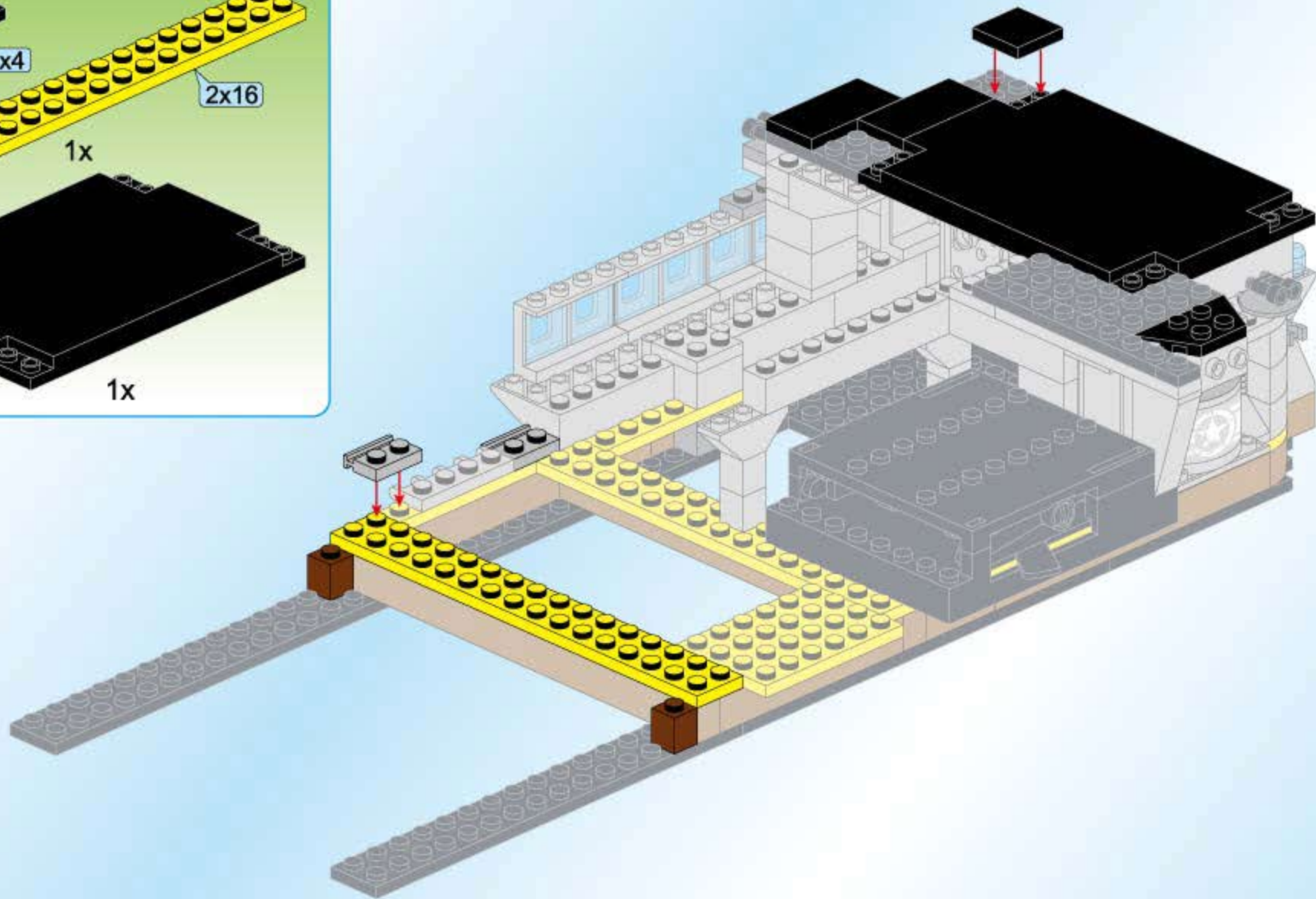
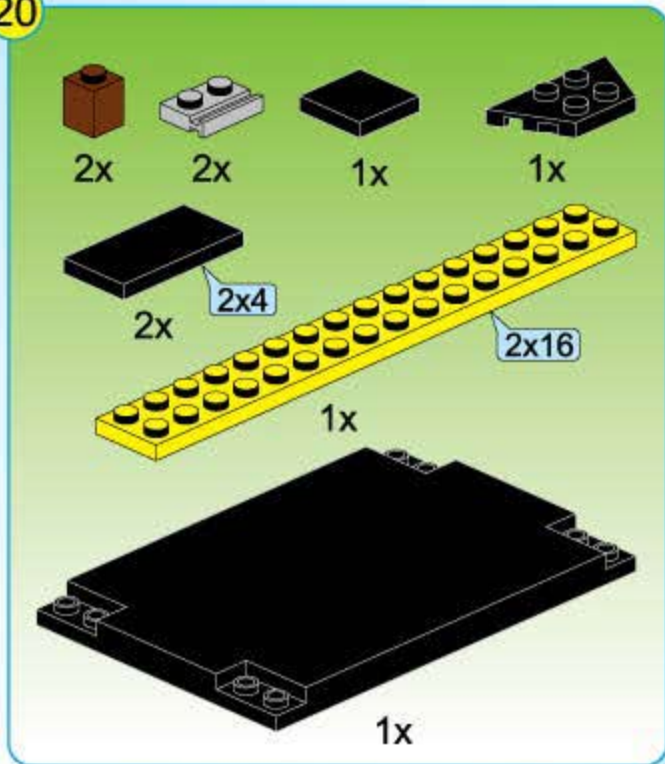



+ =

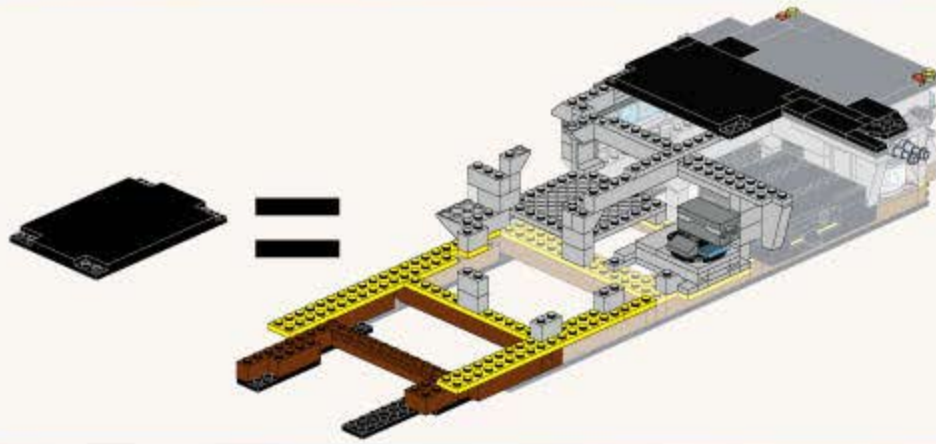

21

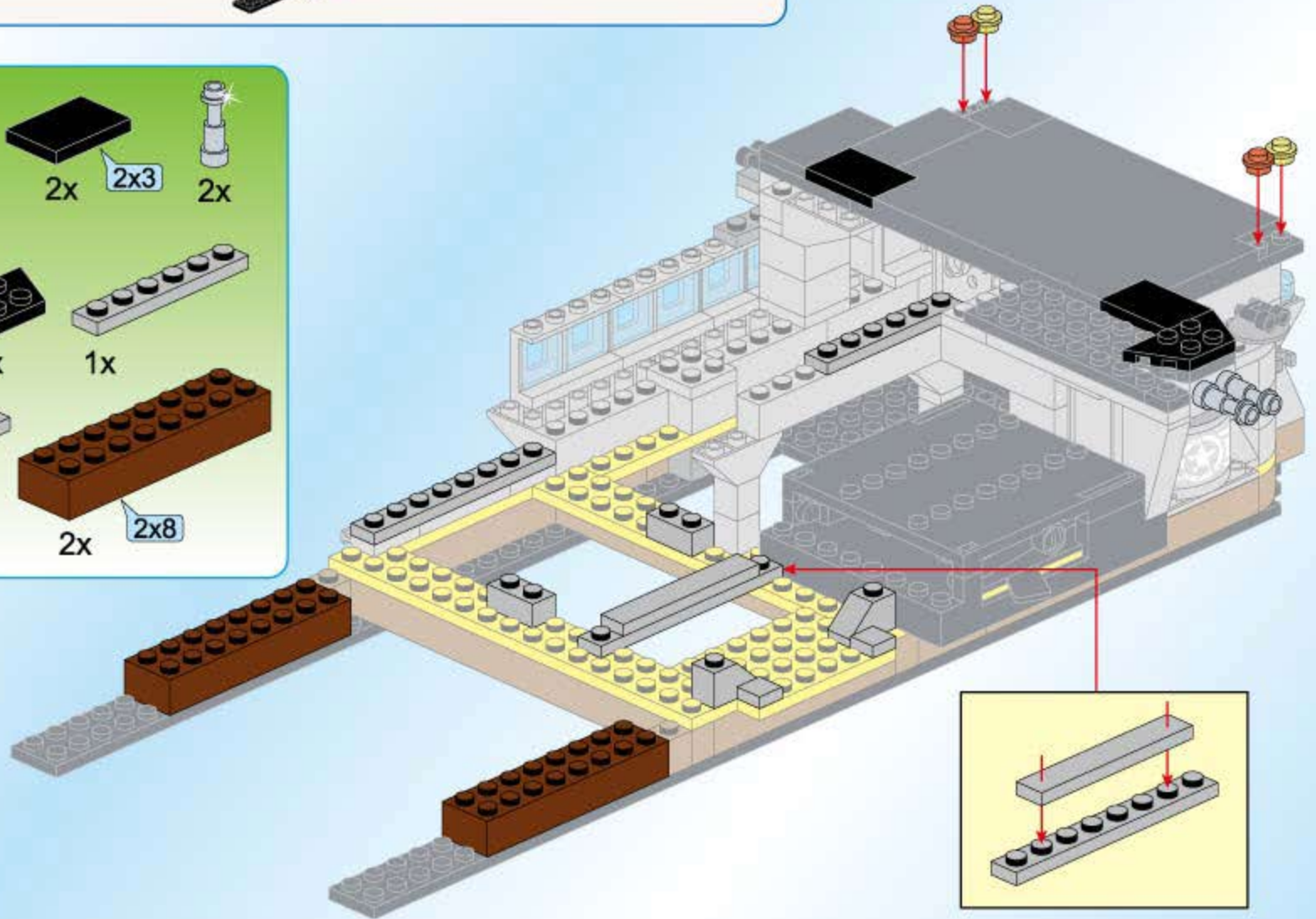
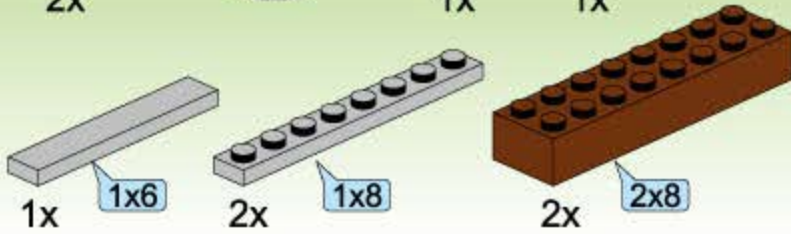
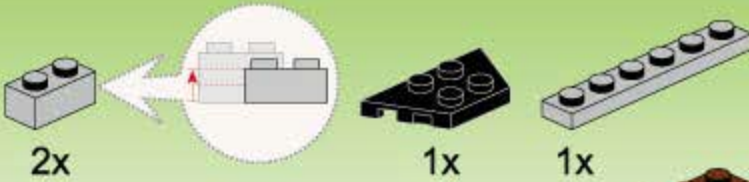

22



1x



2x



1x



2x



2x



1x

1x4



2x



1x

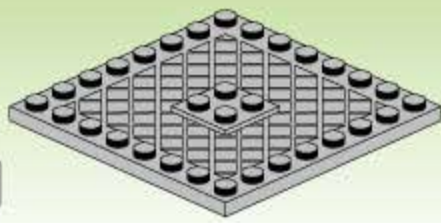

1x

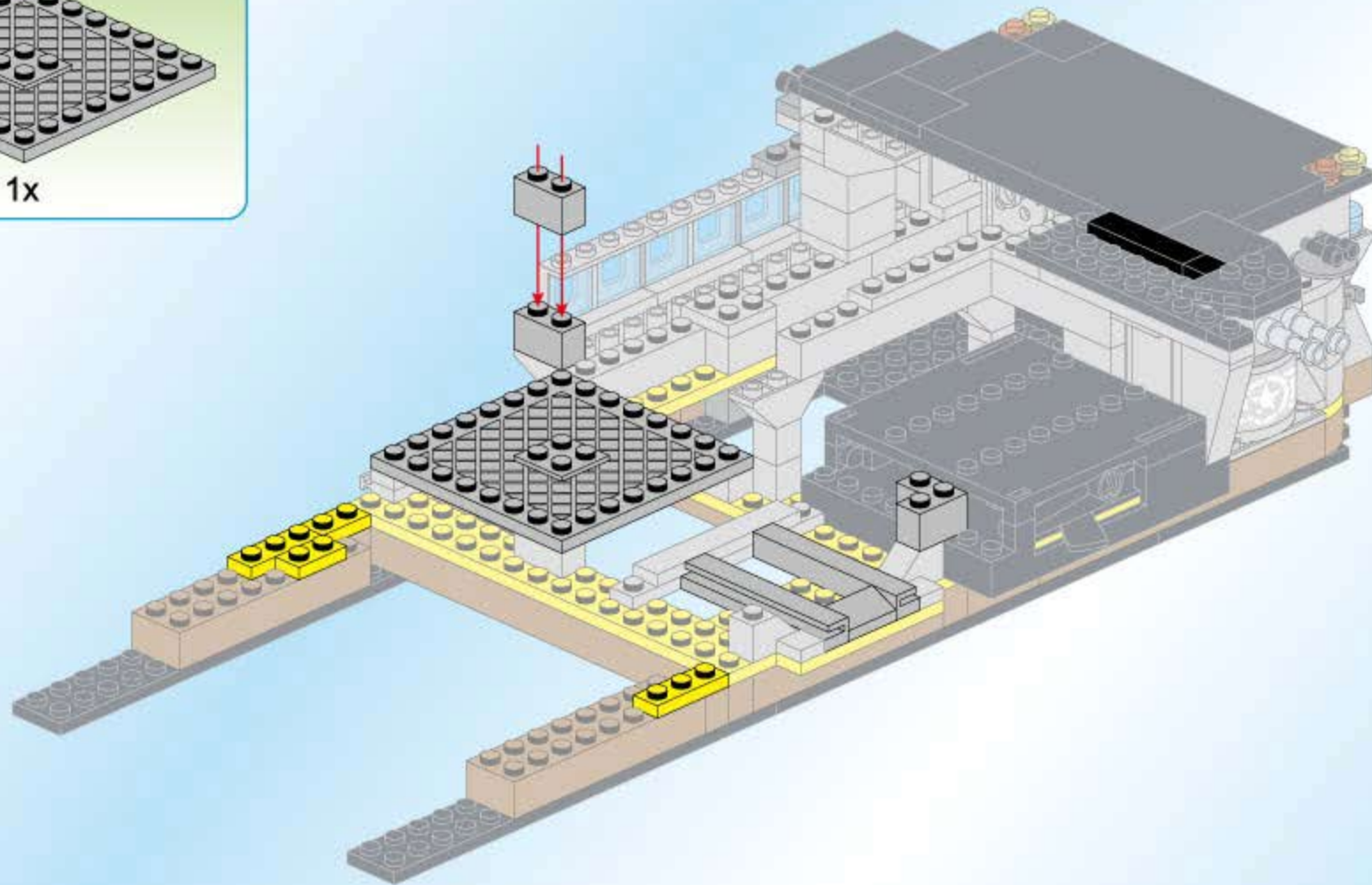

23

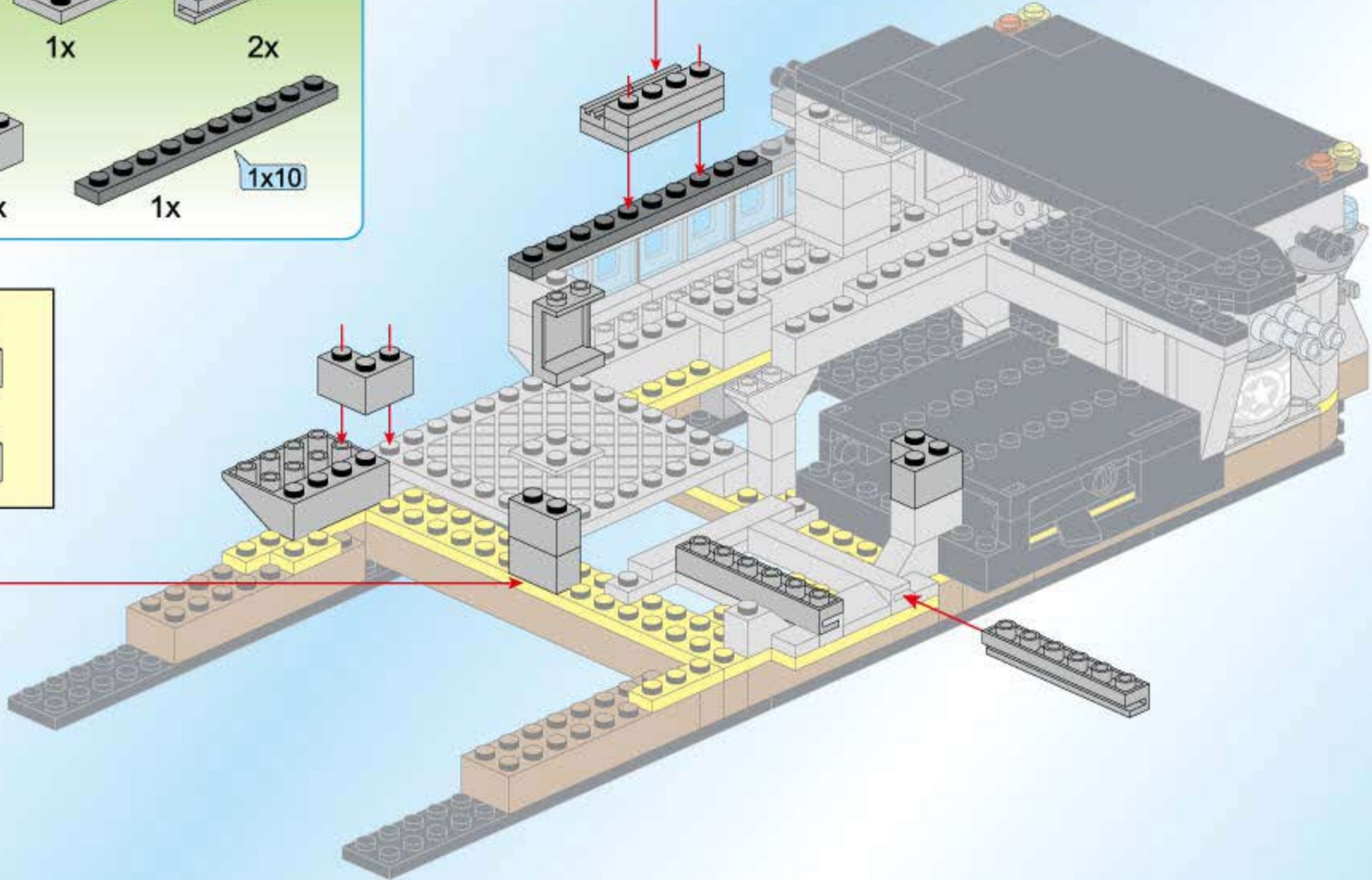
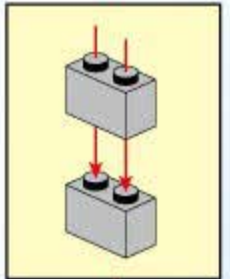
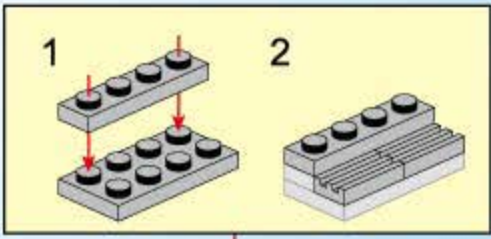
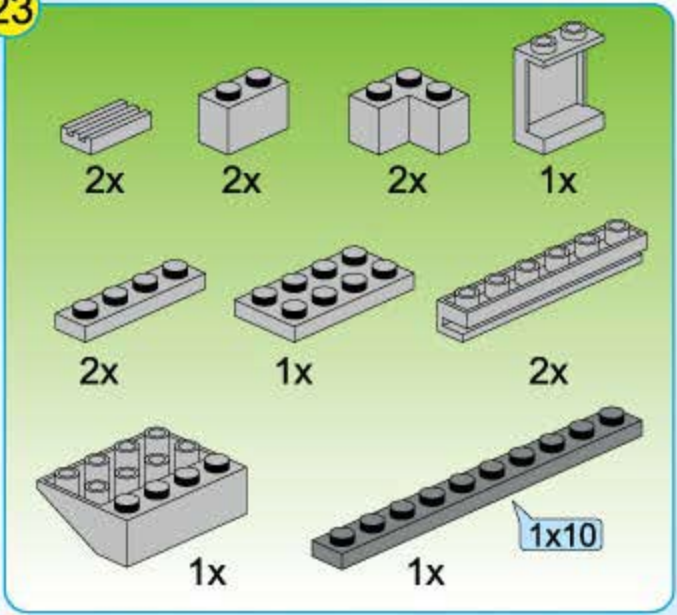

24

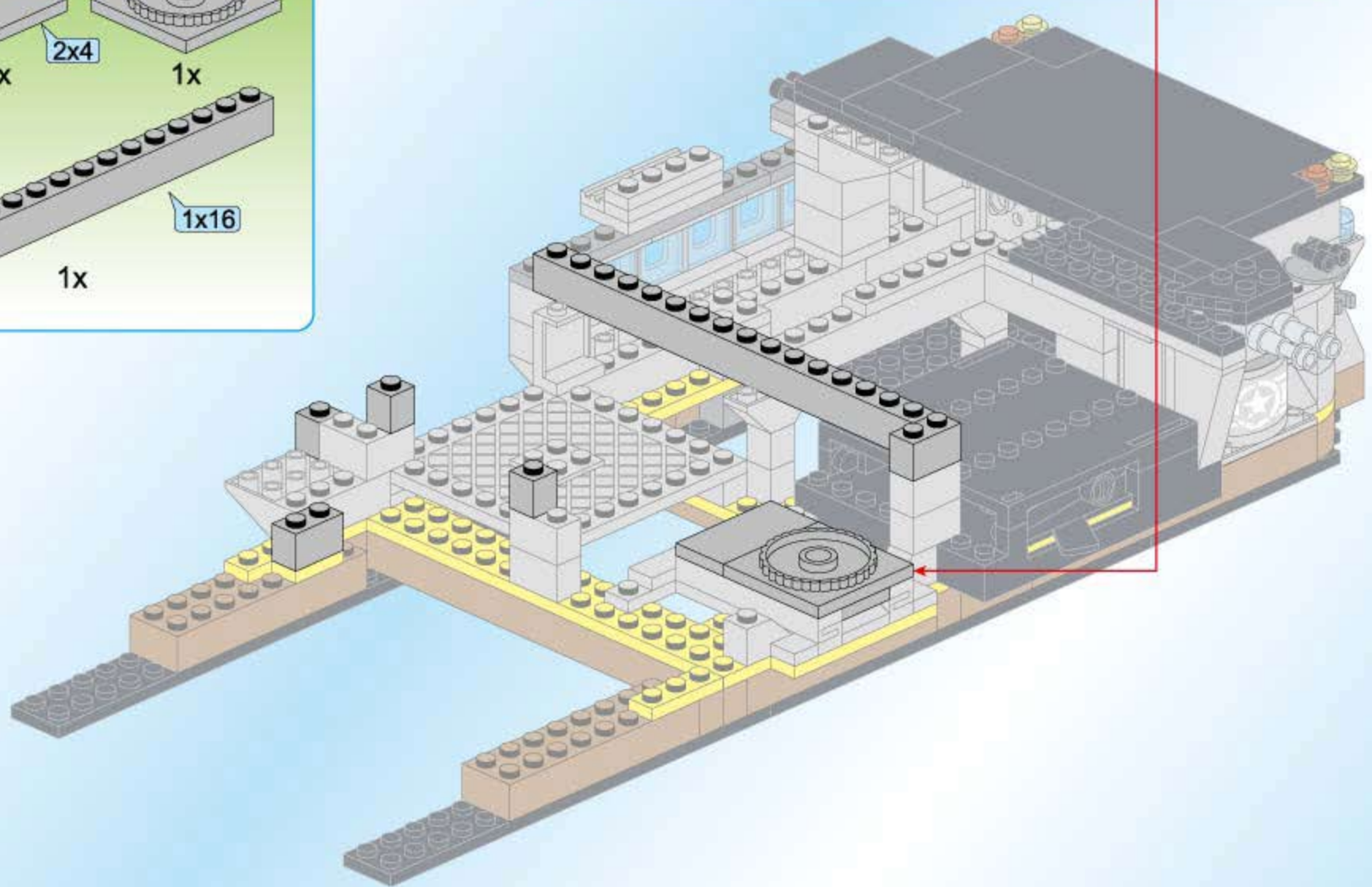
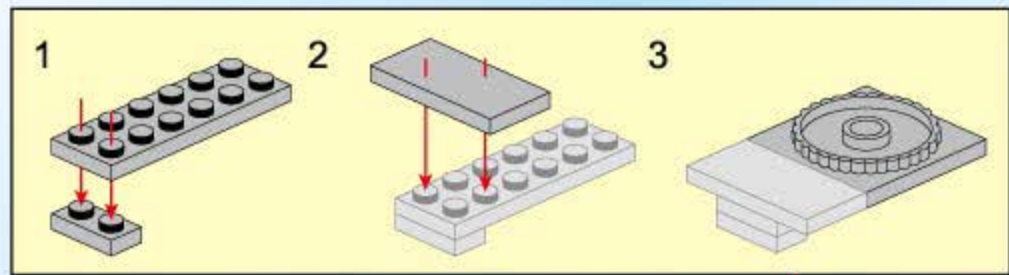
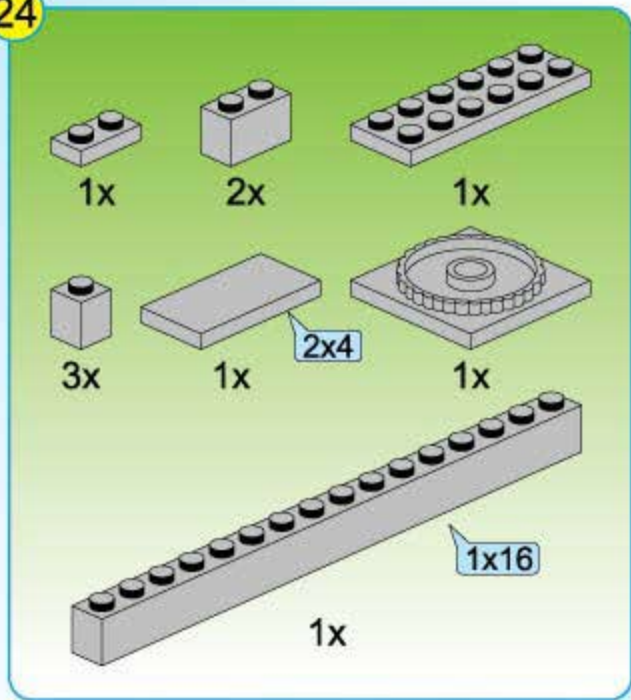

25

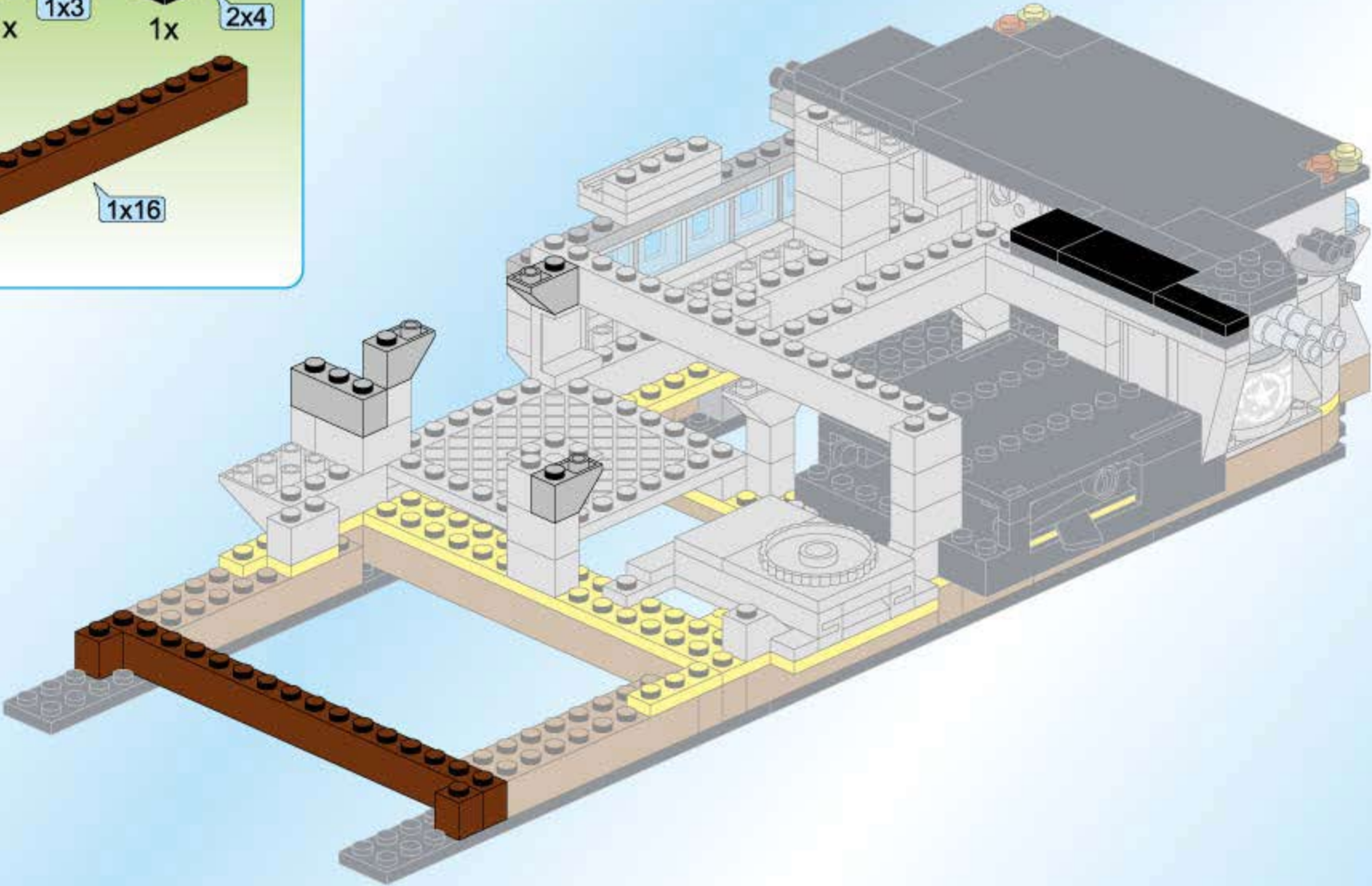
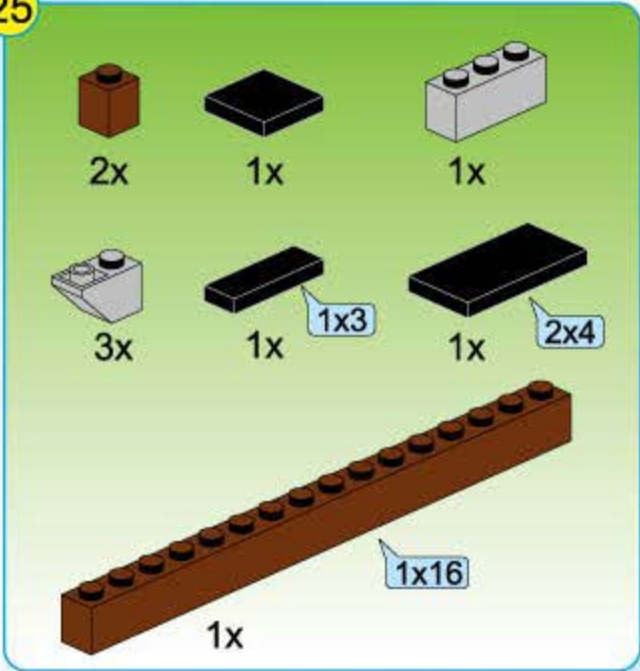

26

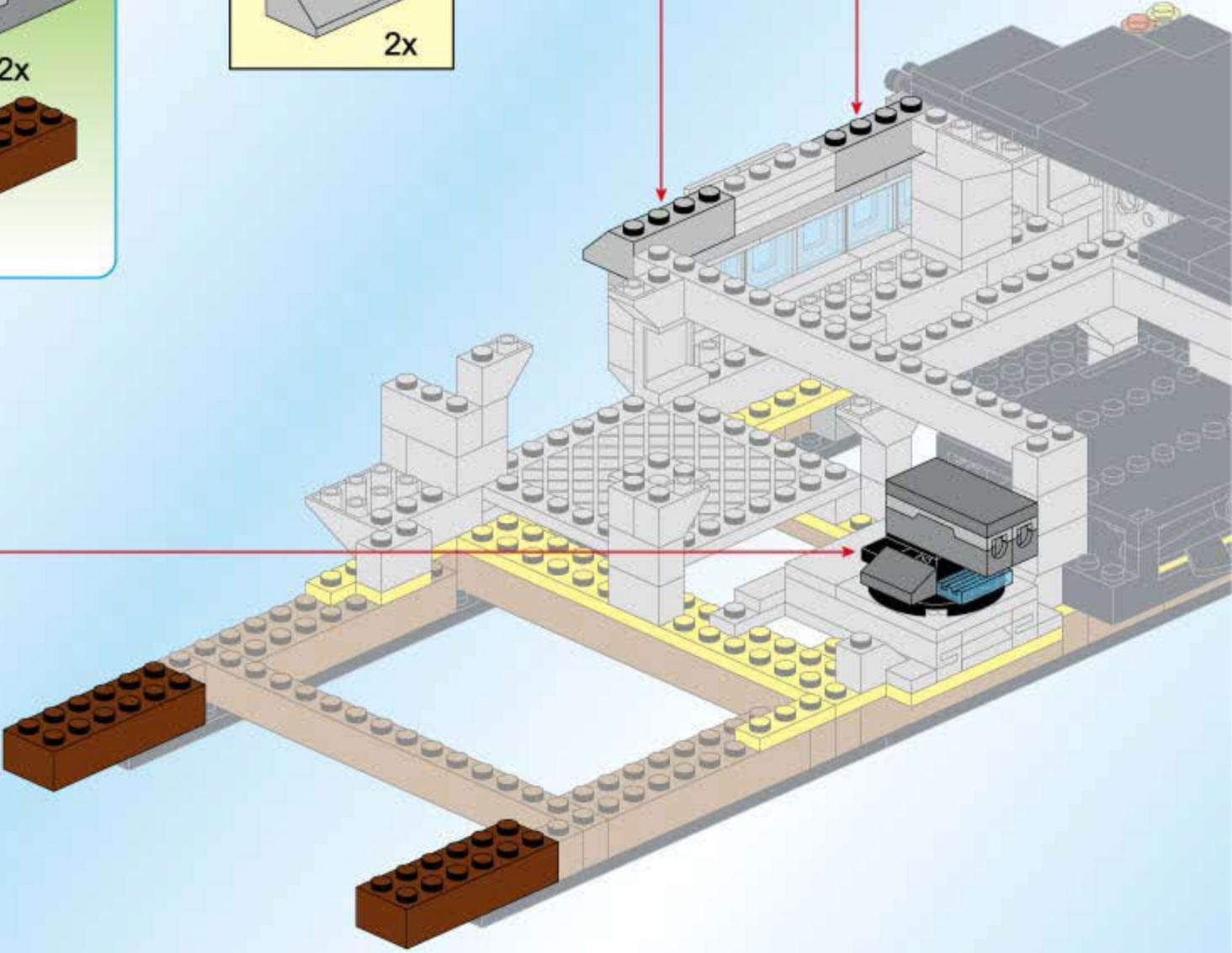
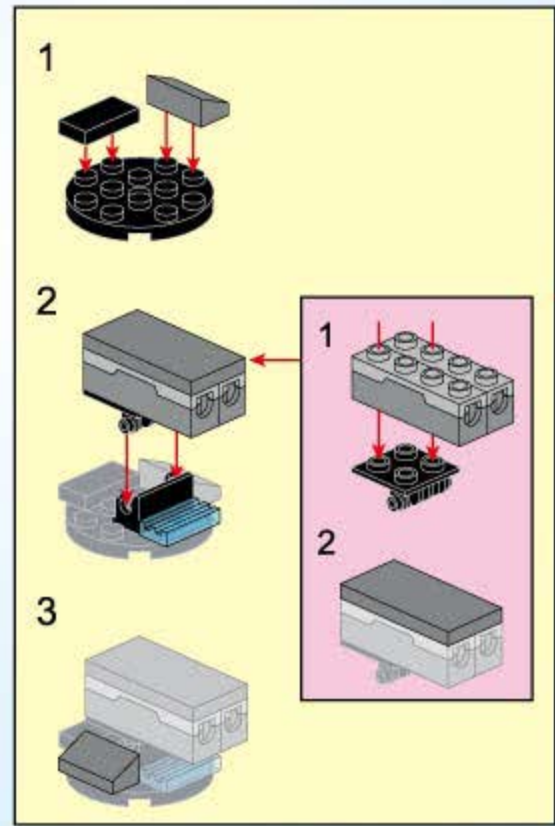
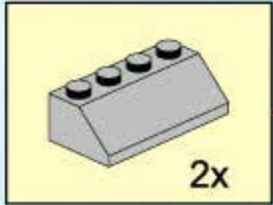
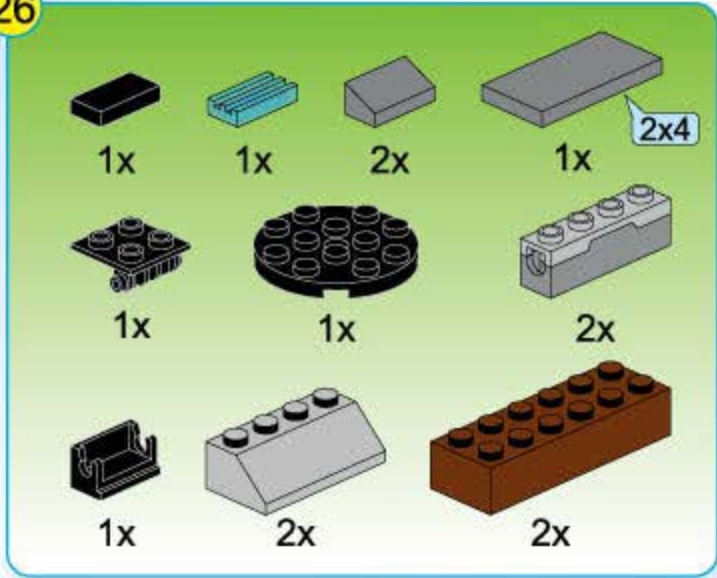

27

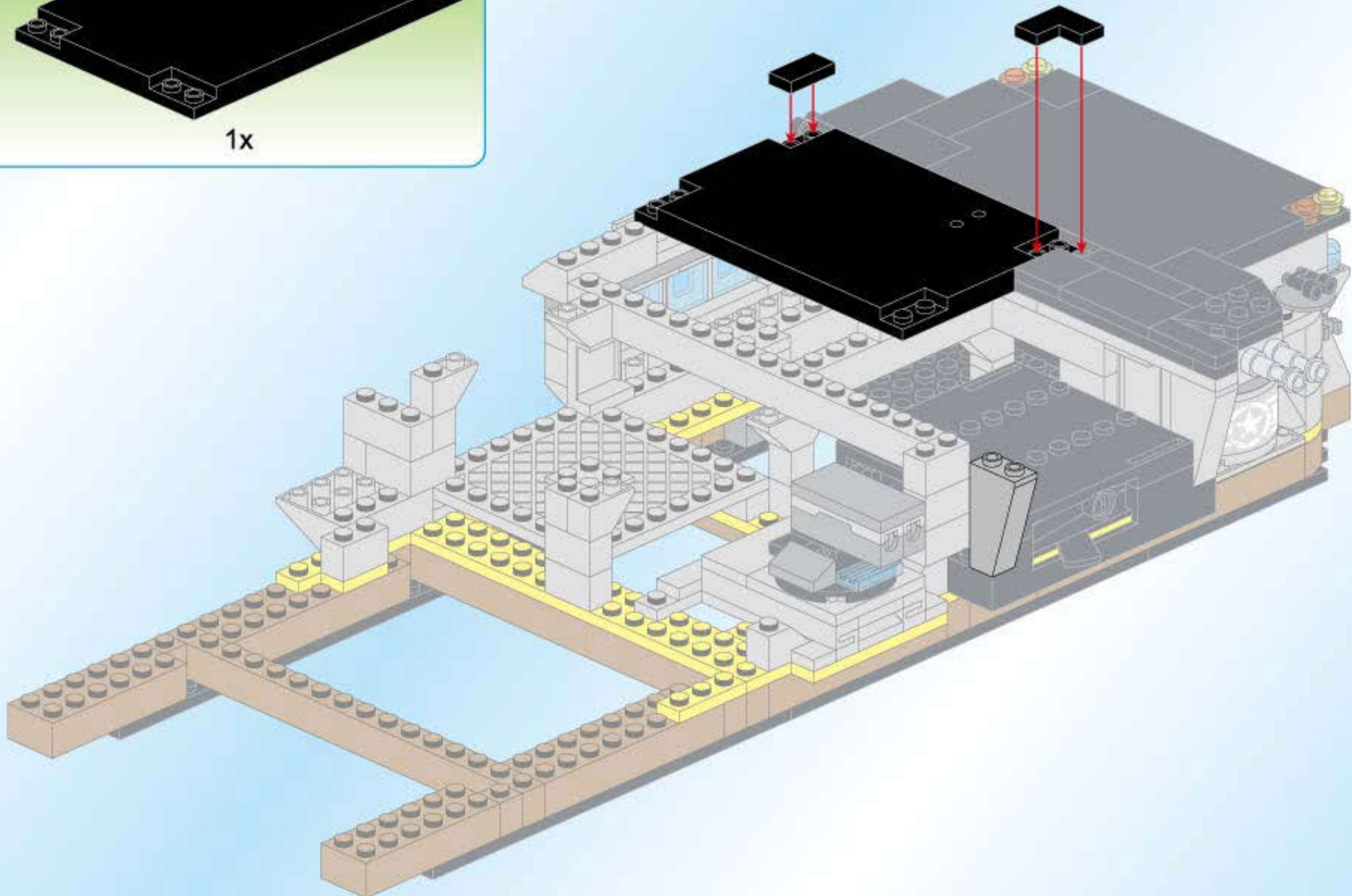
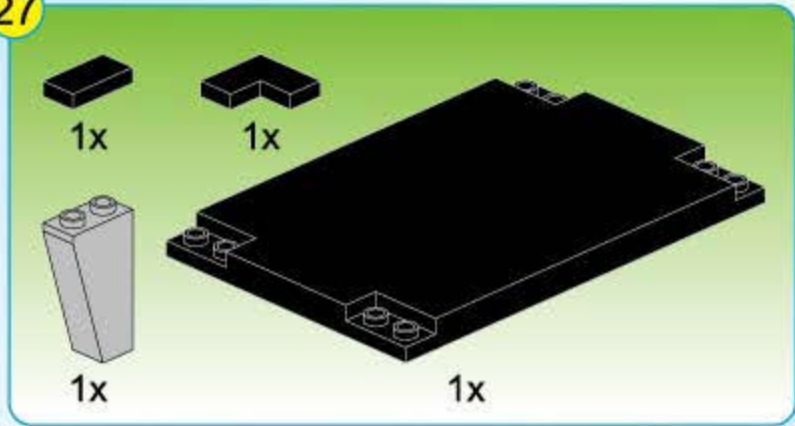

28

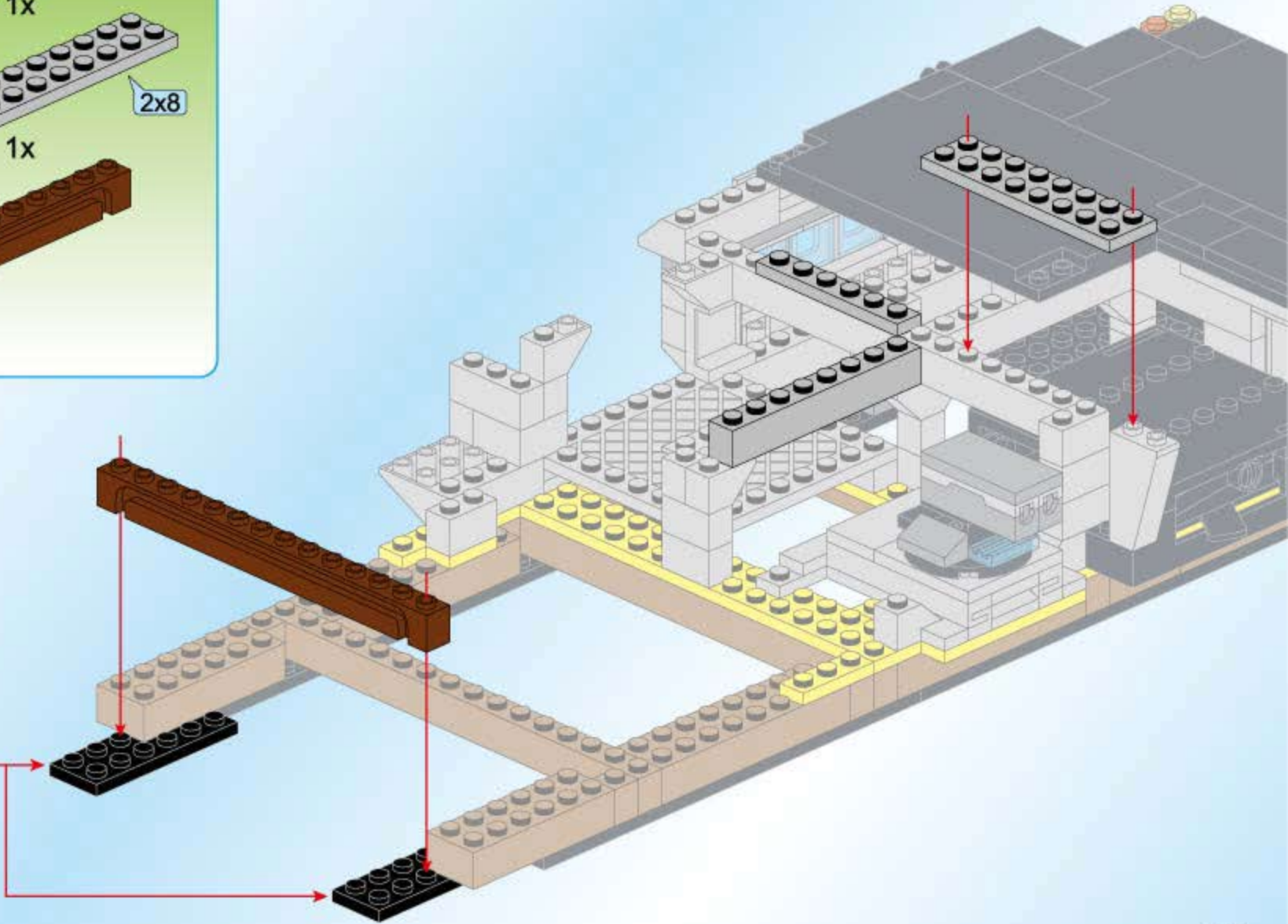
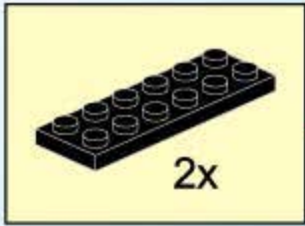
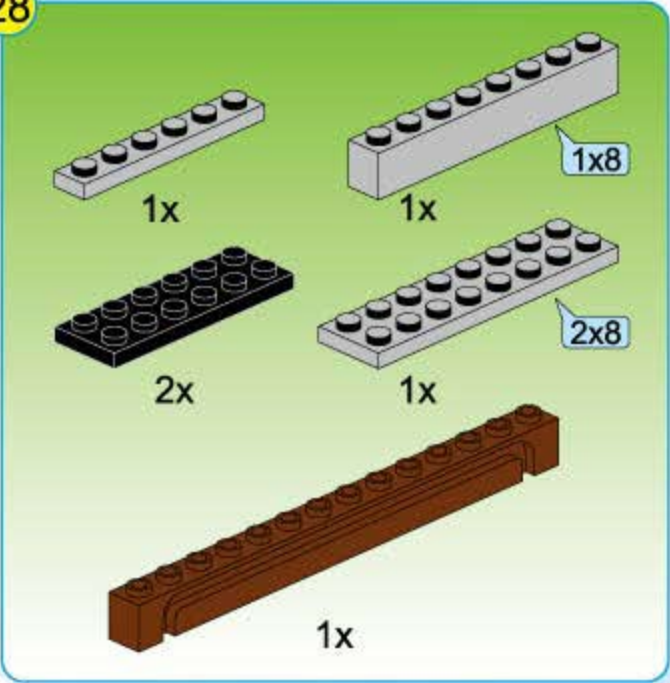

29

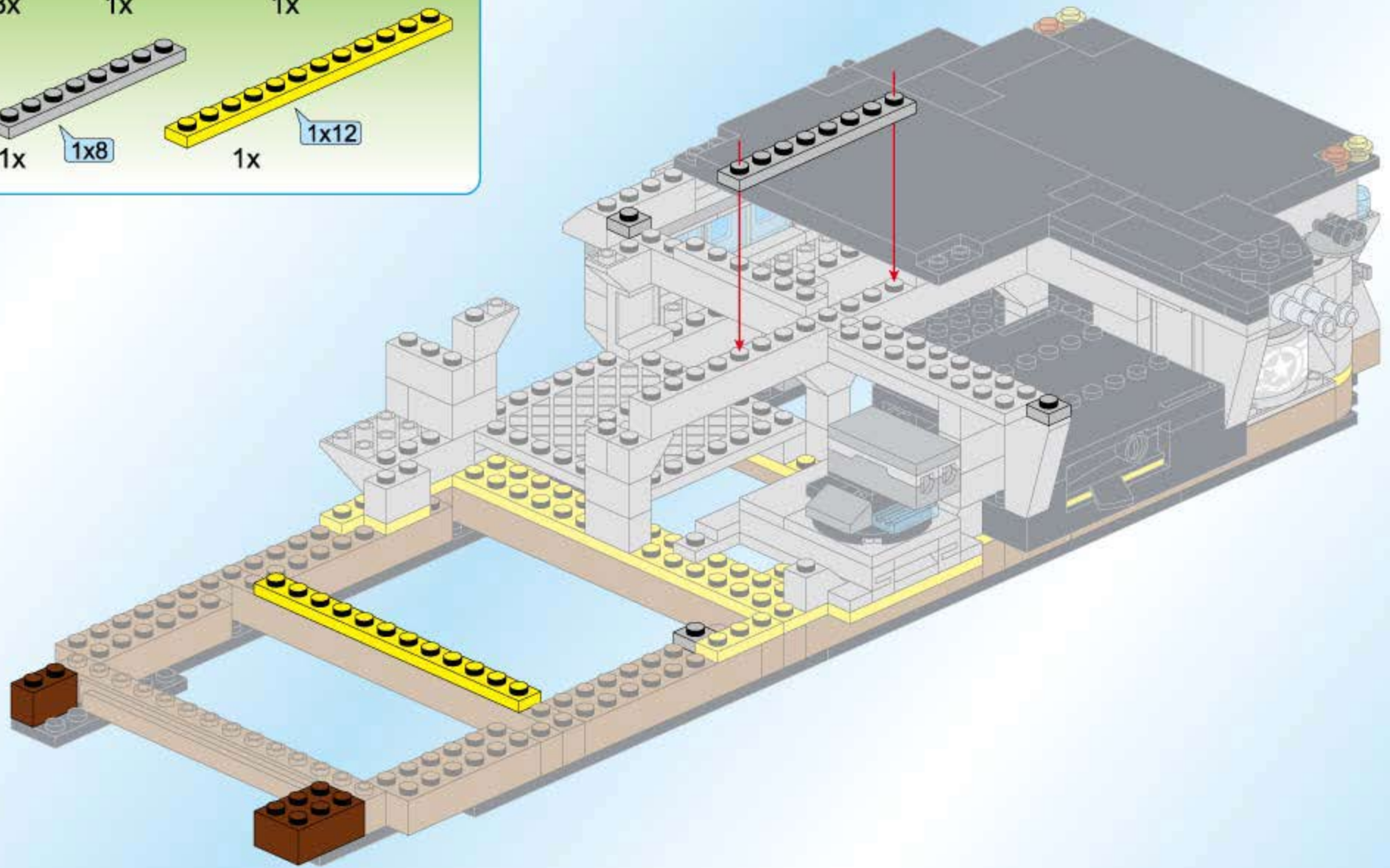
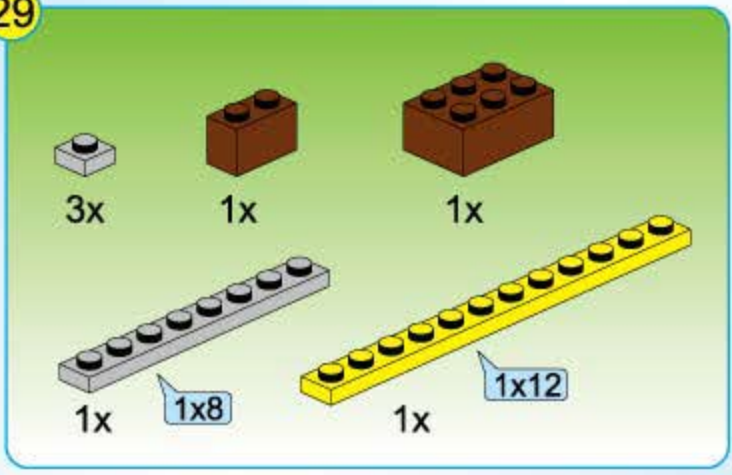

30

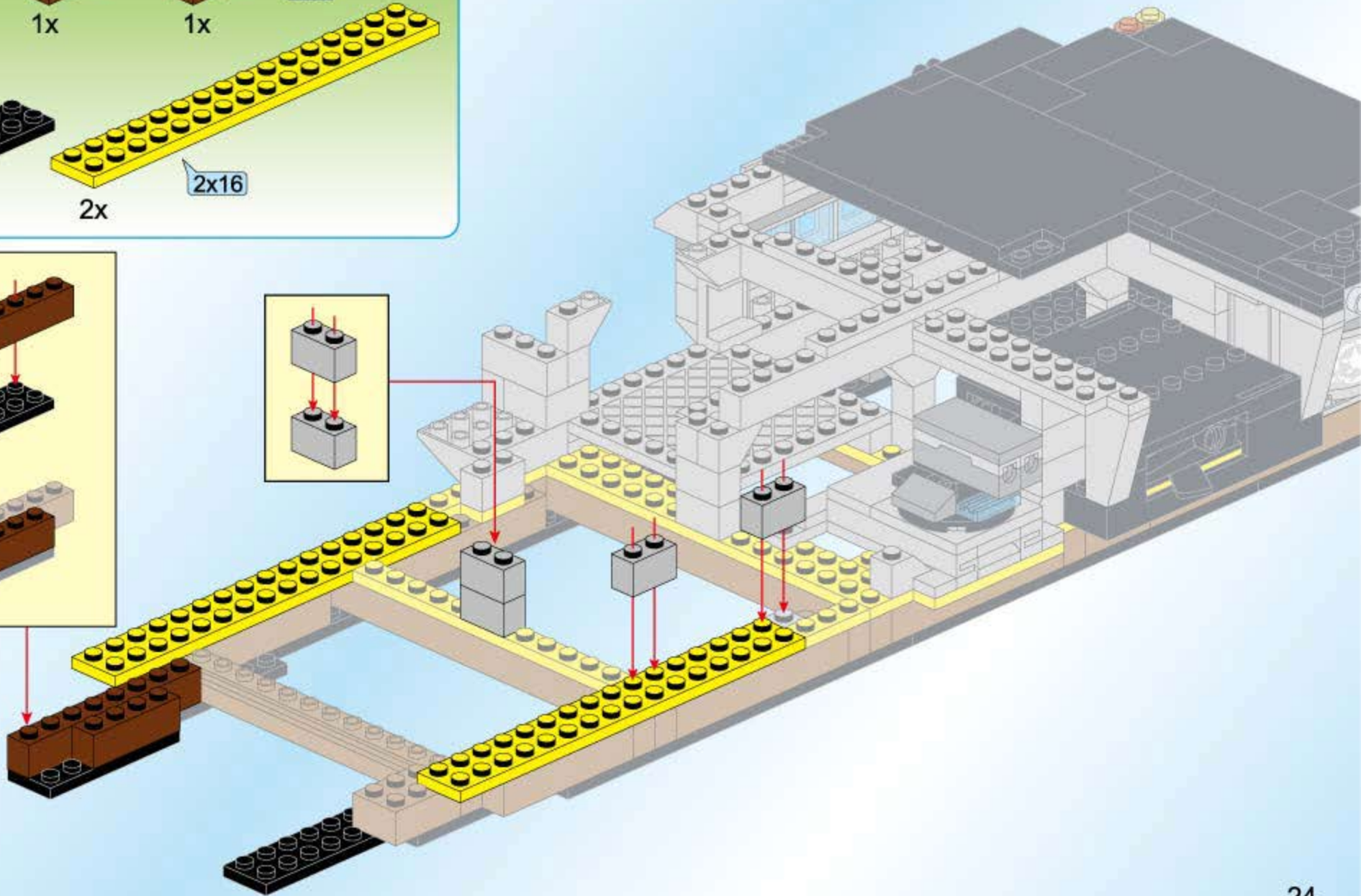
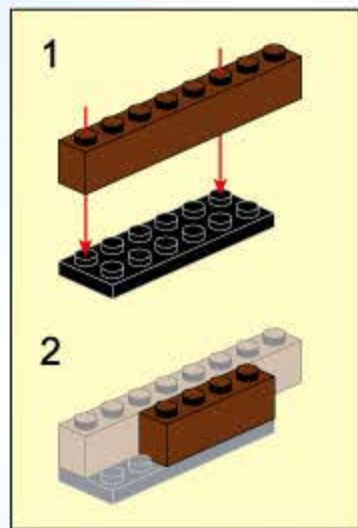
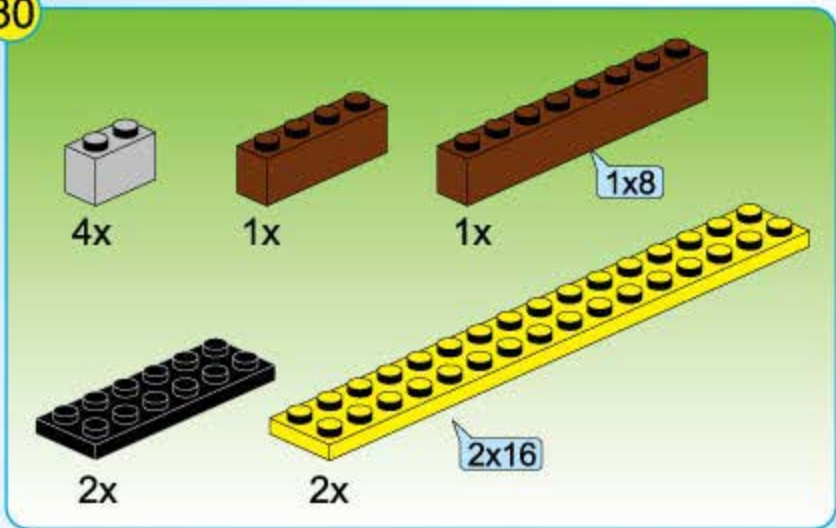

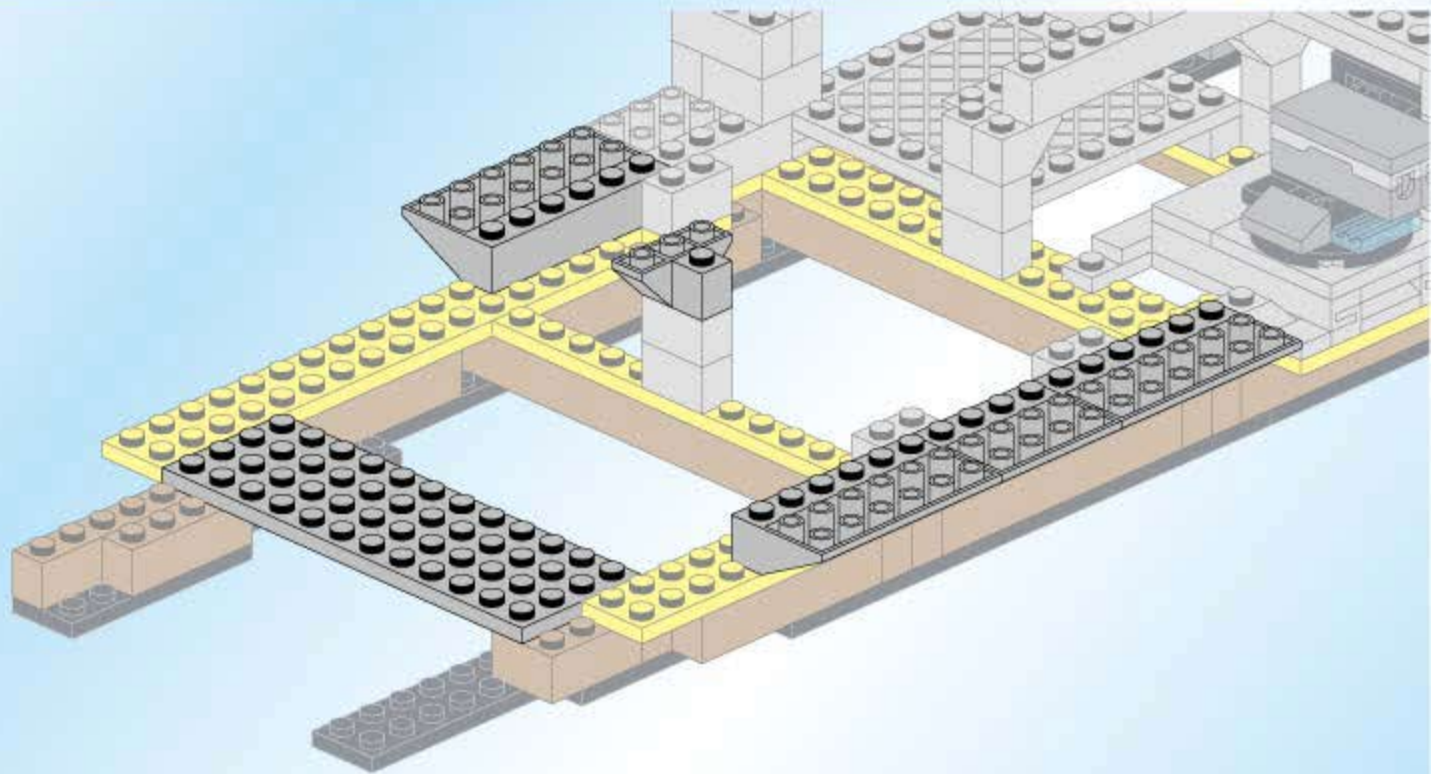
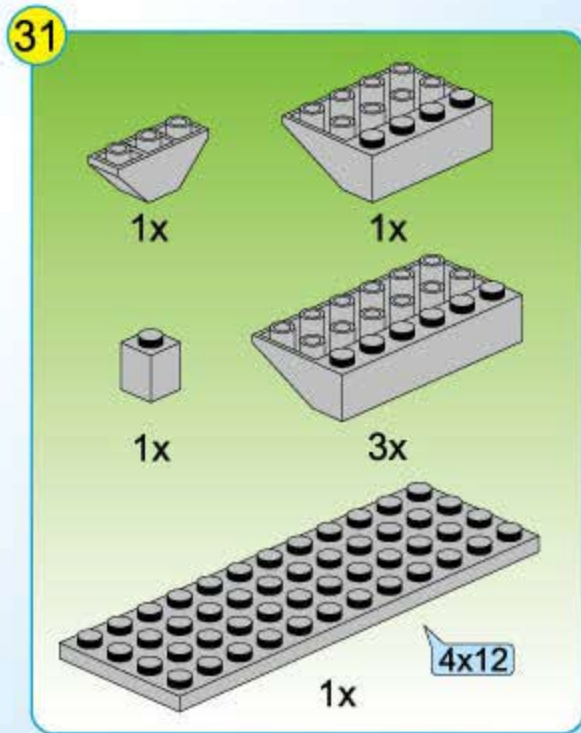
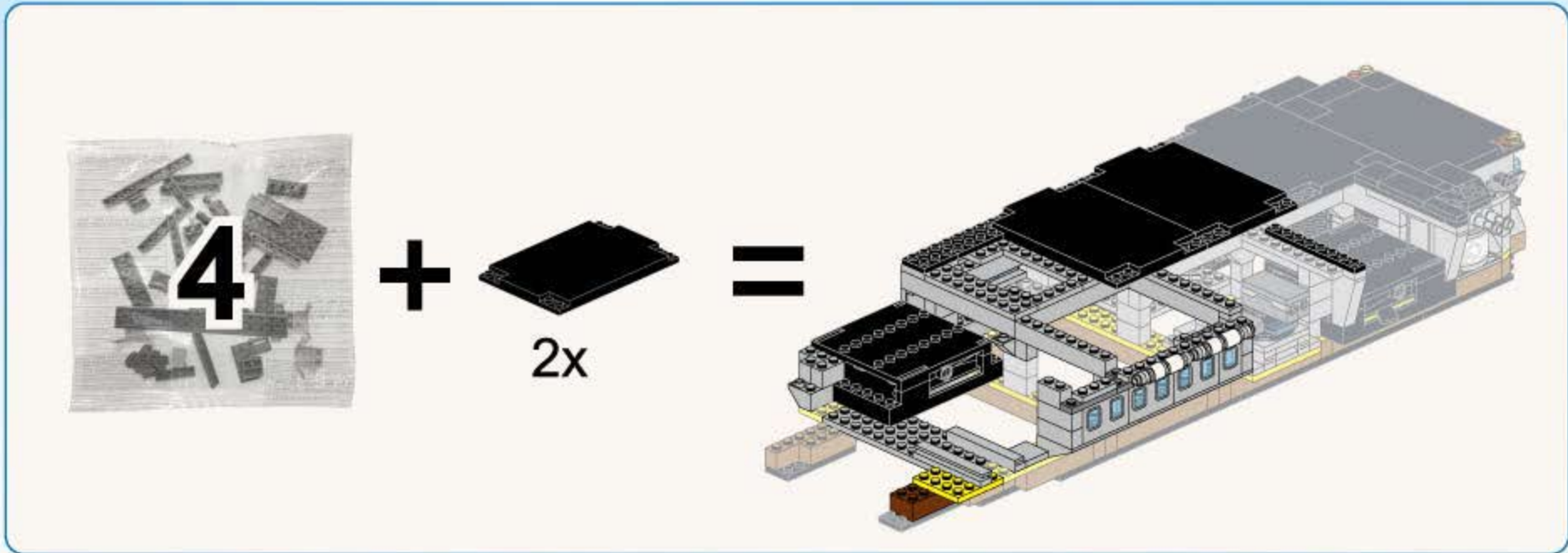

32

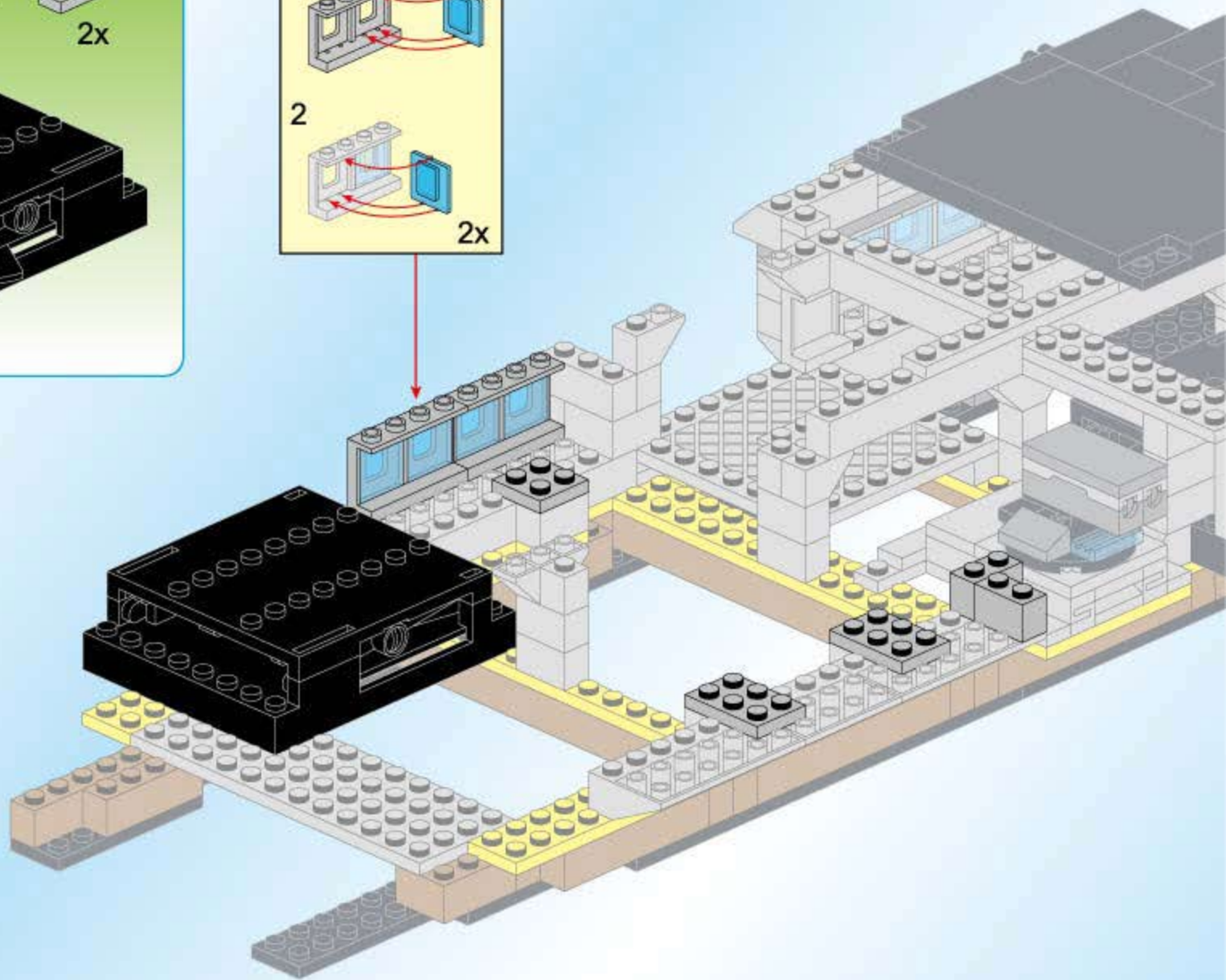
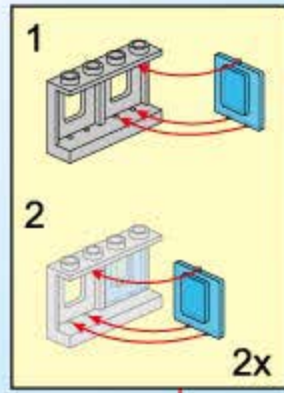
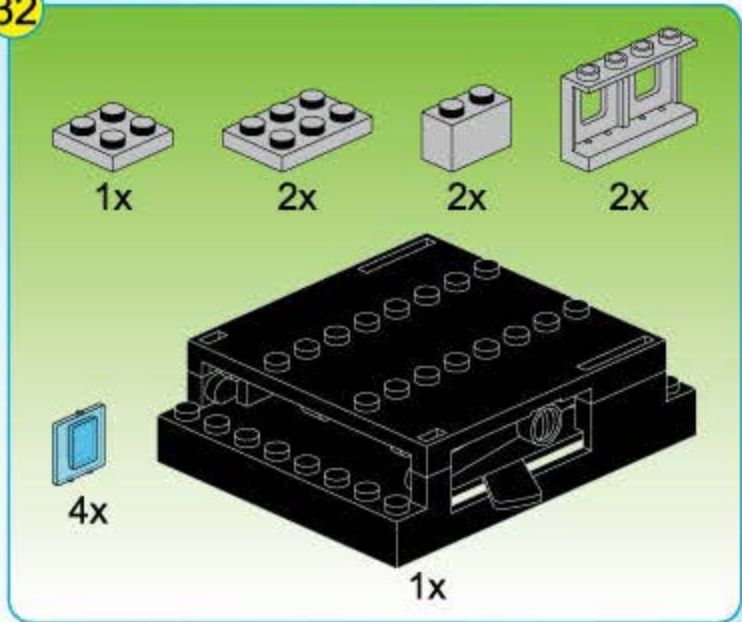

33



2x



1x



1x



2x



4x



1x

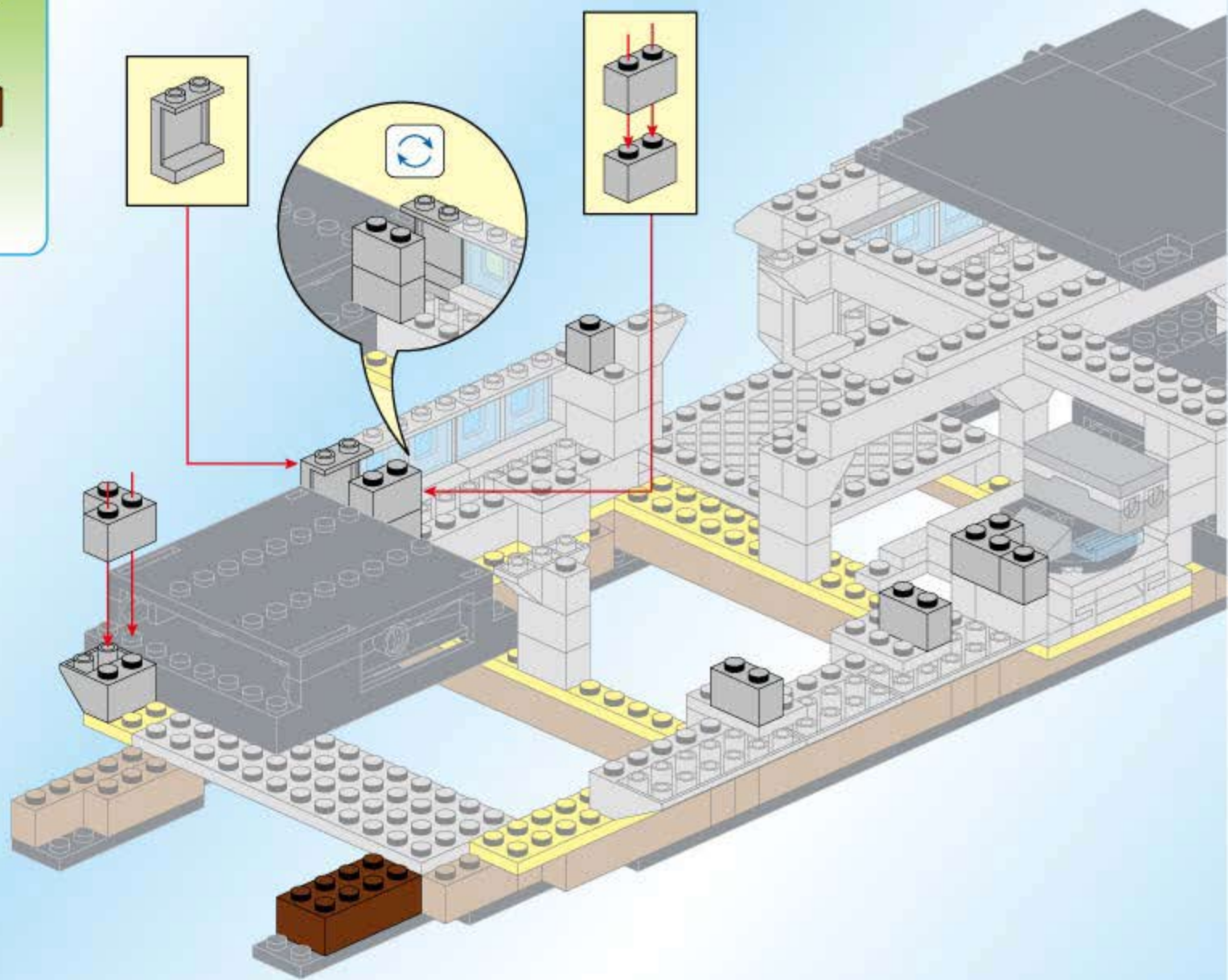

34

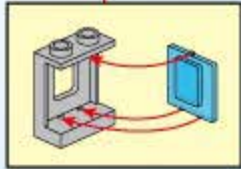
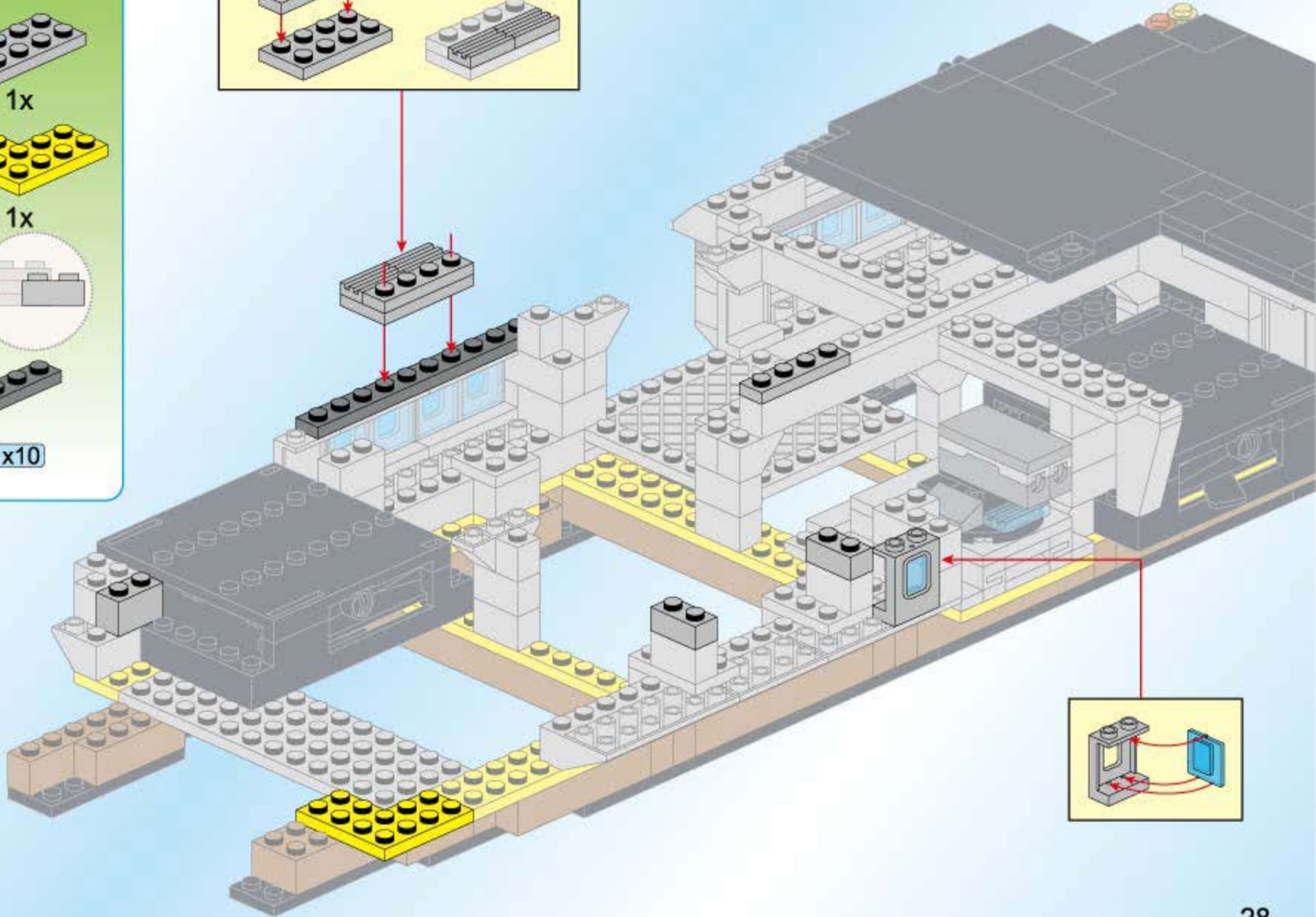
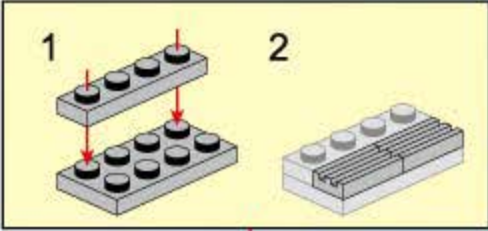
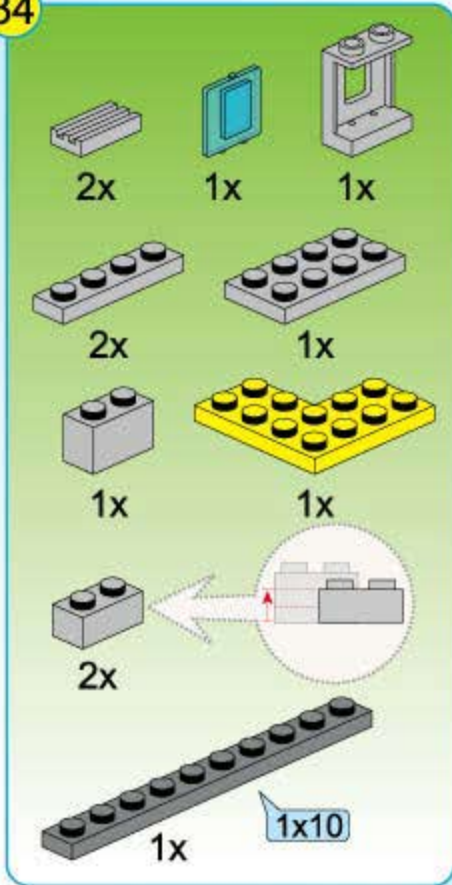

35

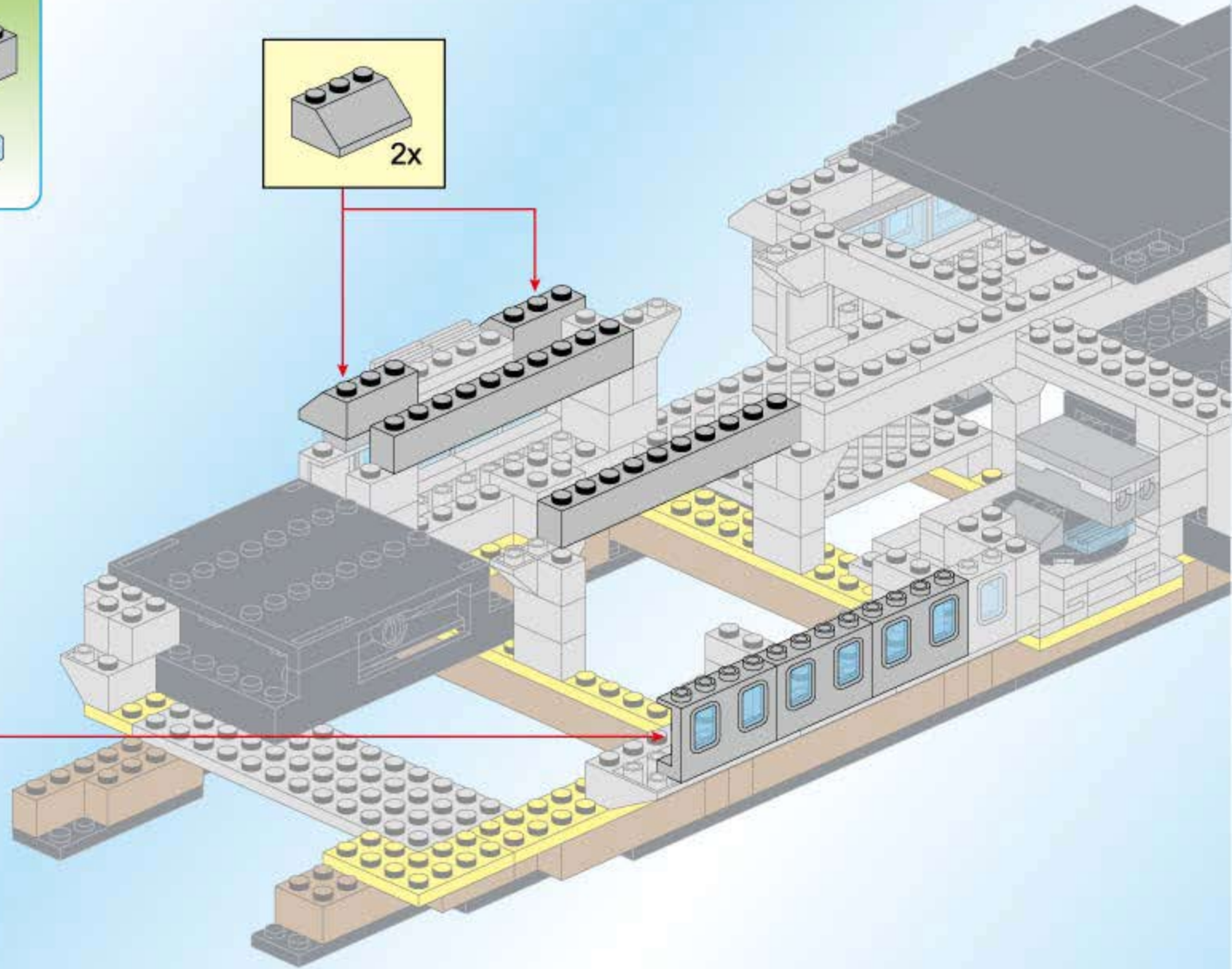
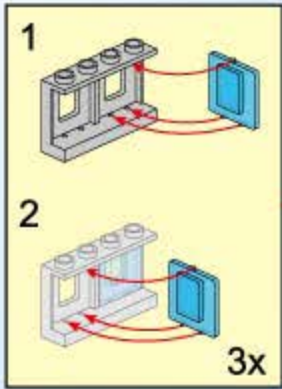
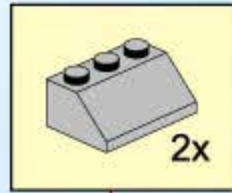
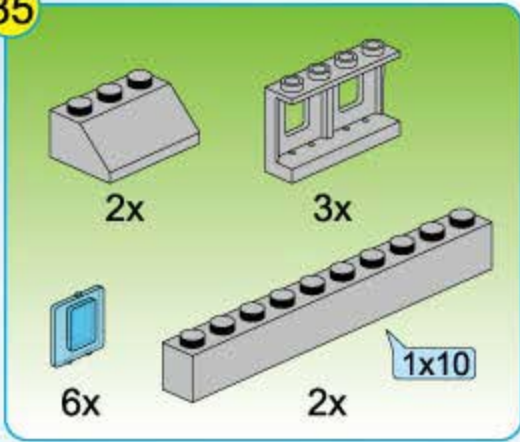

36

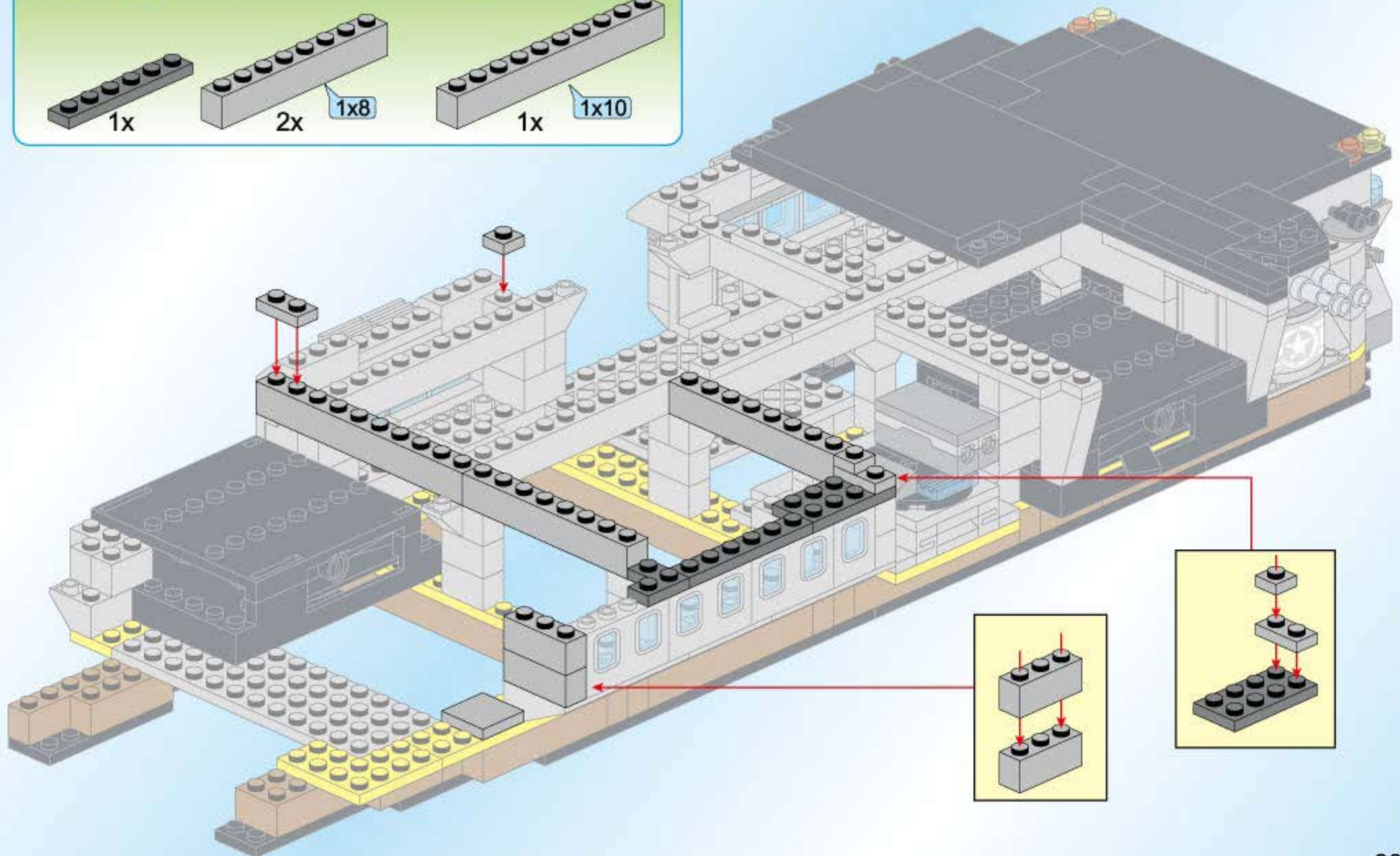
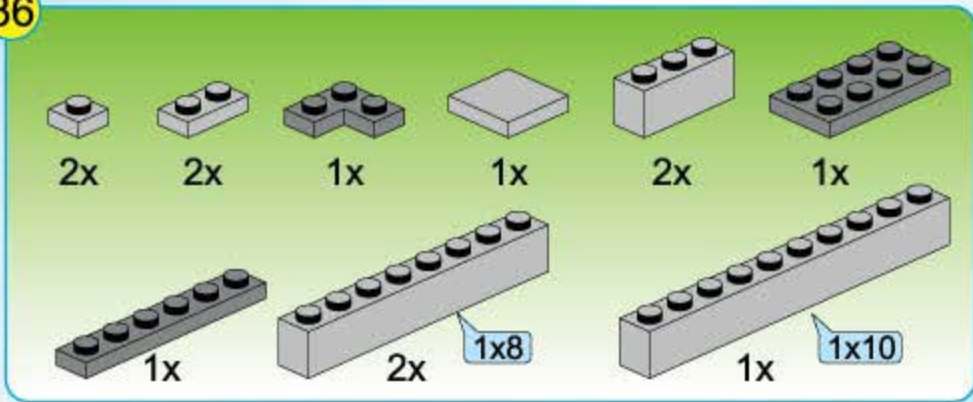

37

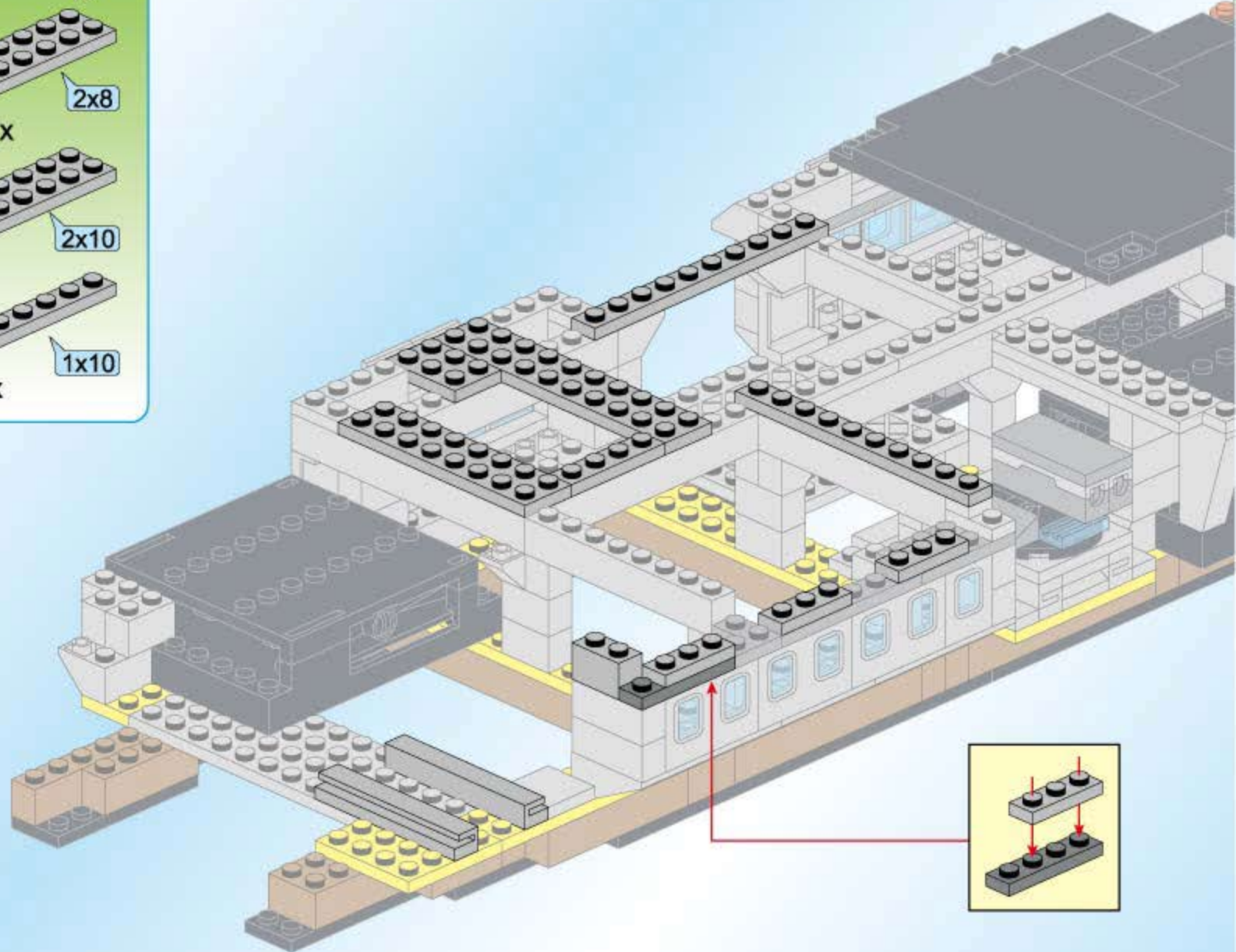
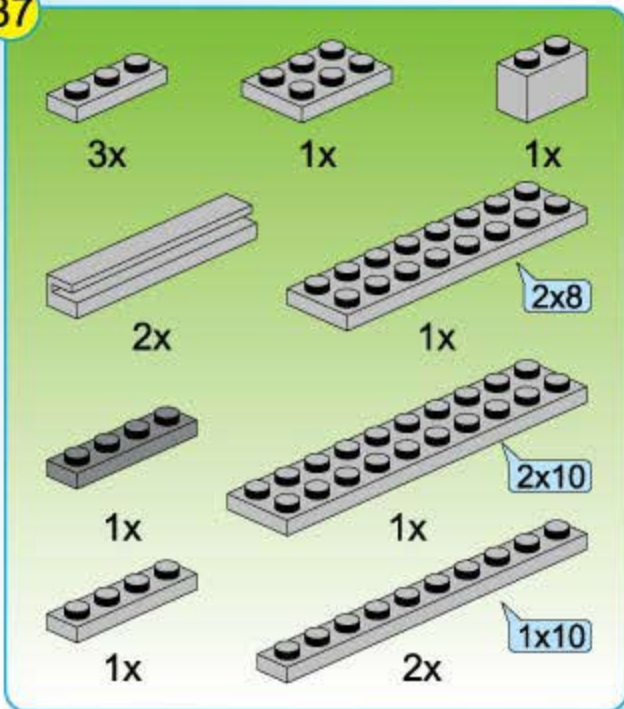

38

Parts list for step 38:

- 1x 2x4 black Technic brick
- 1x 2x6 black Technic brick
- 1x 1x8 black Technic Technonote
- 7x white Technic pins
- 2x white Technic pins with long friction ridges
- 4x grey Technic axle pins
- 2x white Technic pins with long friction ridges
- 2x black Technic Technonotes

Assembly sequence 1-4:

1. Insert a grey axle pin into a white pin with long friction ridges.
2. Insert a white pin with long friction ridges into the assembly from step 1.
3. Insert a white pin with long friction ridges into the assembly from step 2.
4. Insert a grey axle pin into the assembly from step 3.

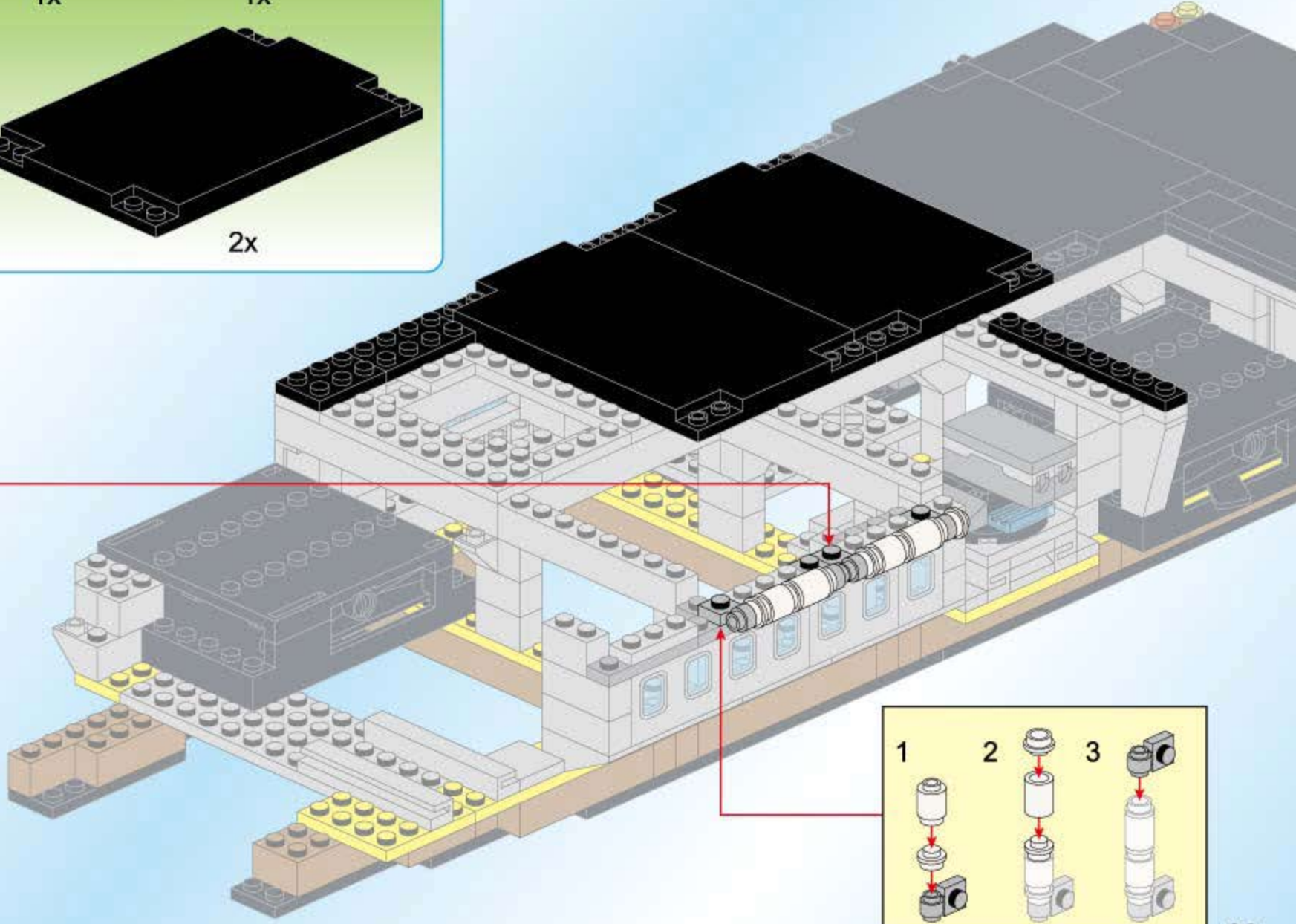

Assembly sequence 1-3:

1. Insert a white pin with long friction ridges into a grey axle pin.
2. Insert a white pin with long friction ridges into the assembly from step 1.
3. Insert a grey axle pin into the assembly from step 2.

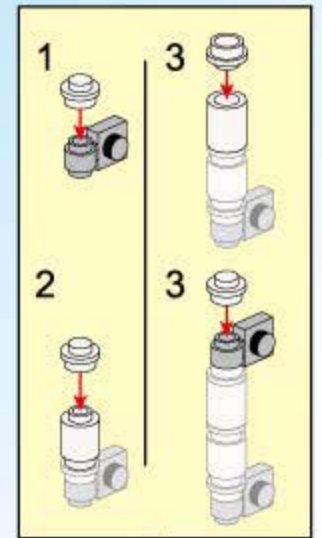
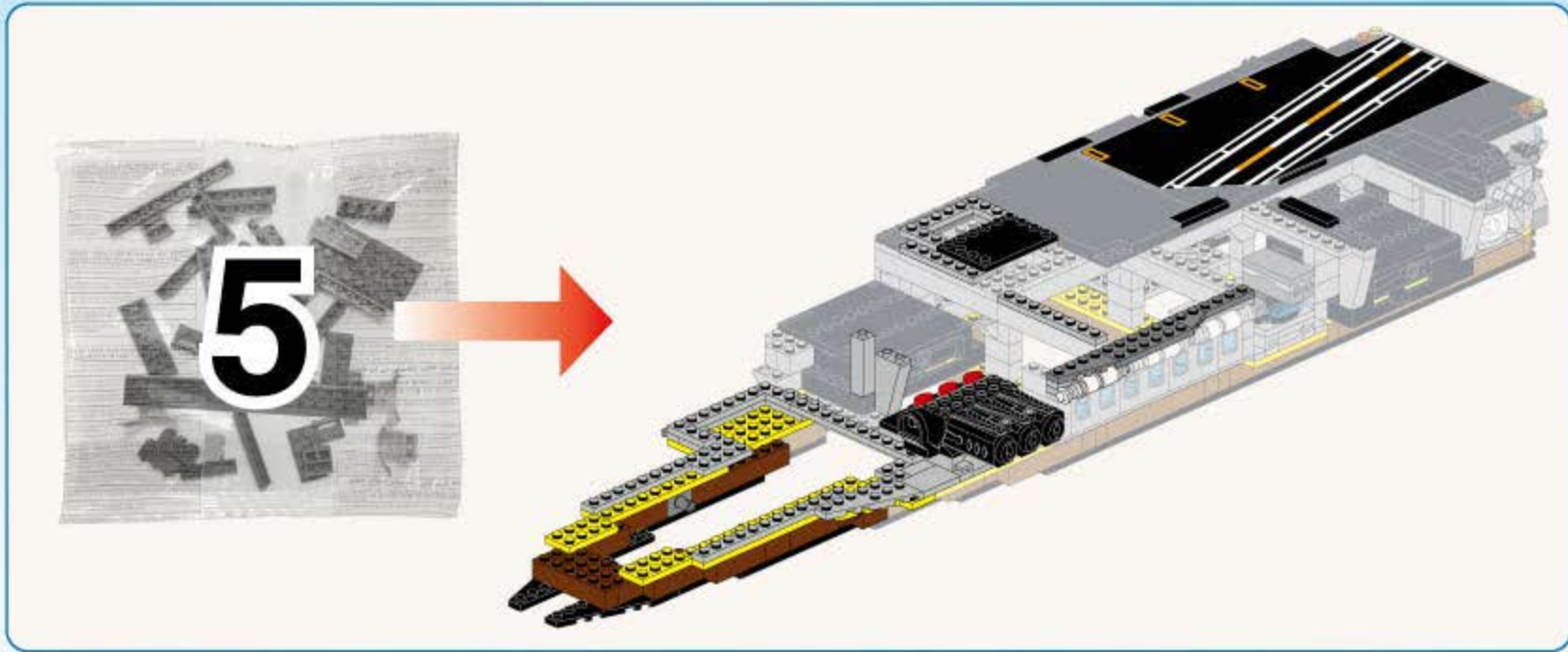

39

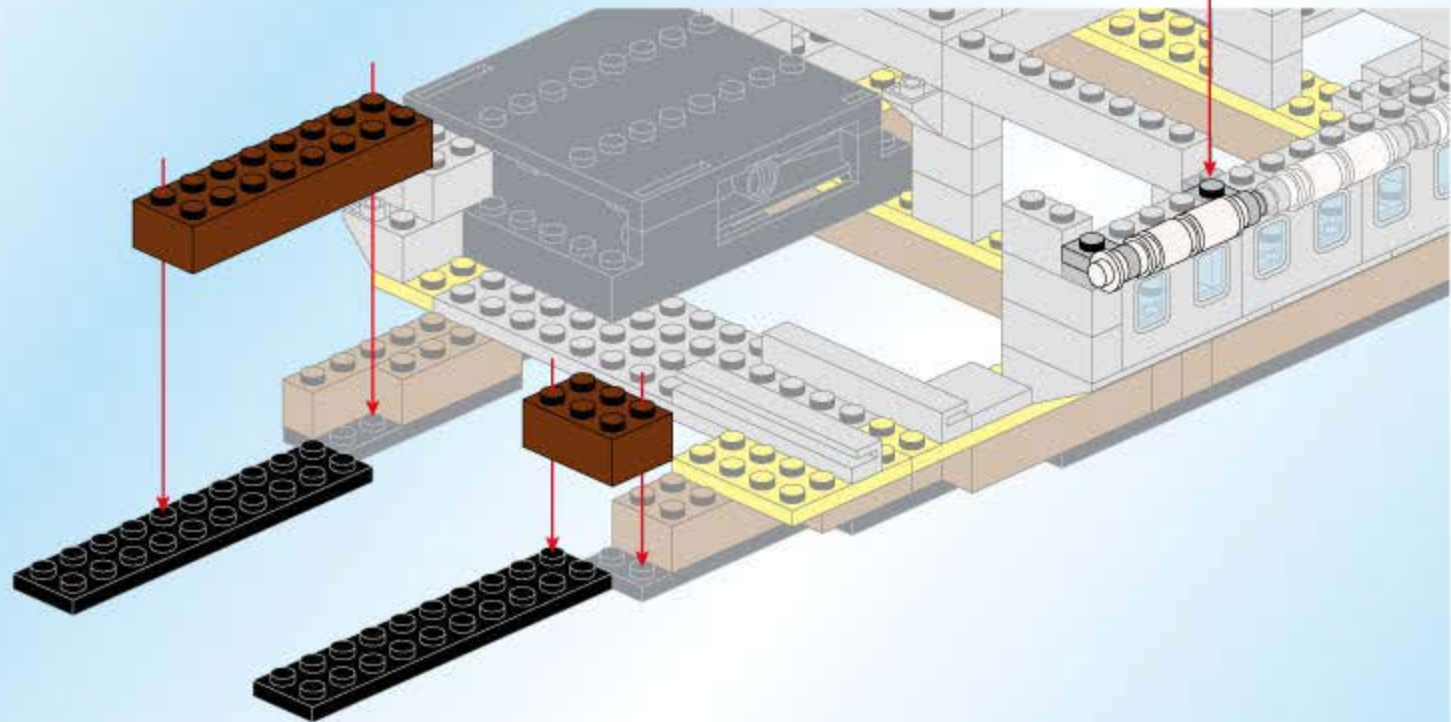
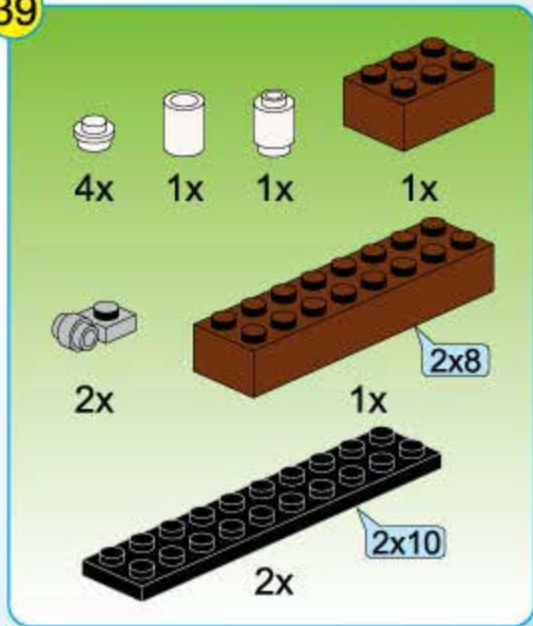

40

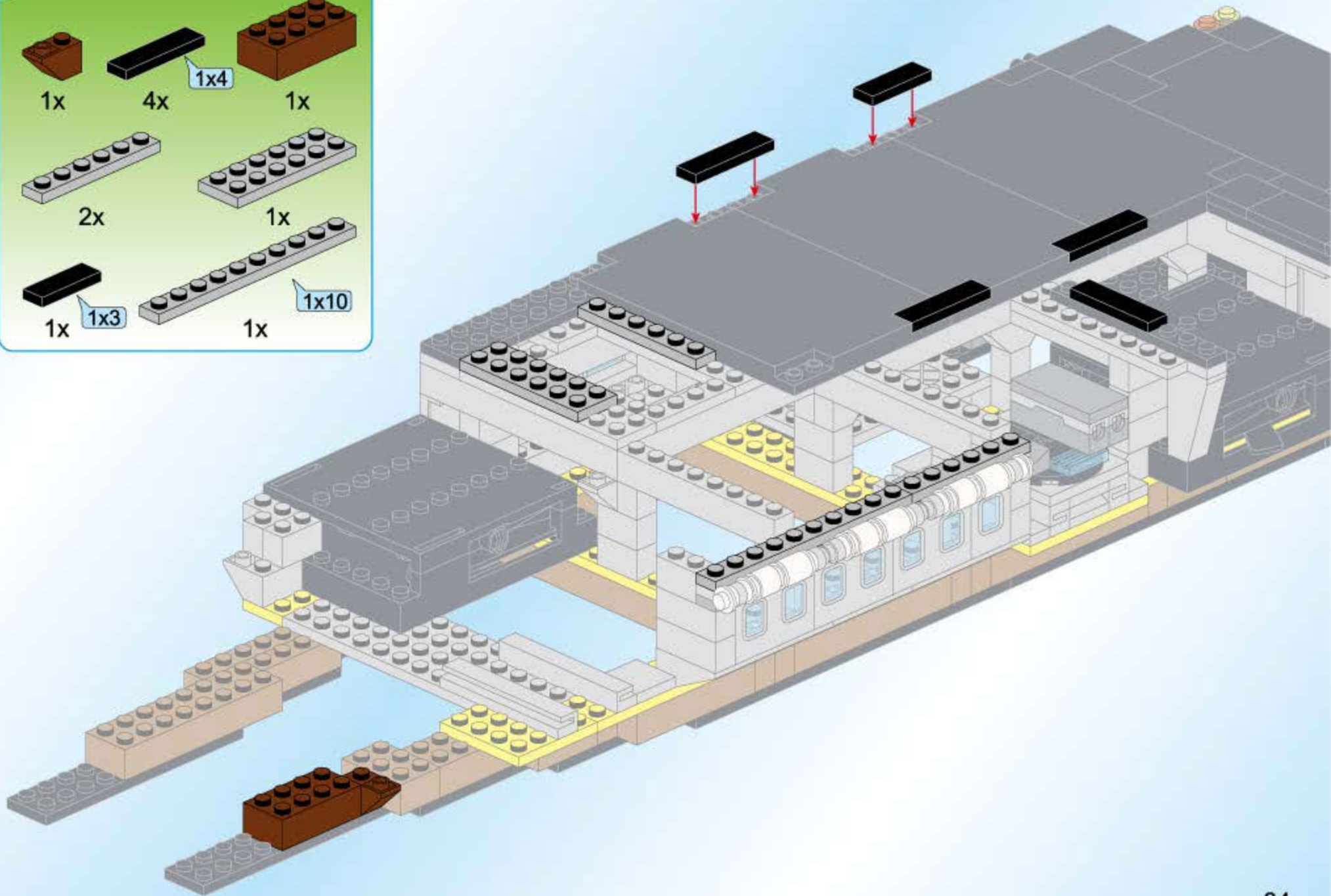
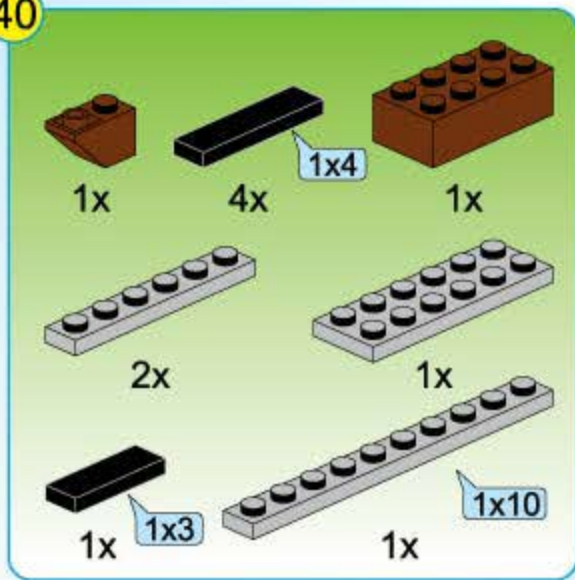

41

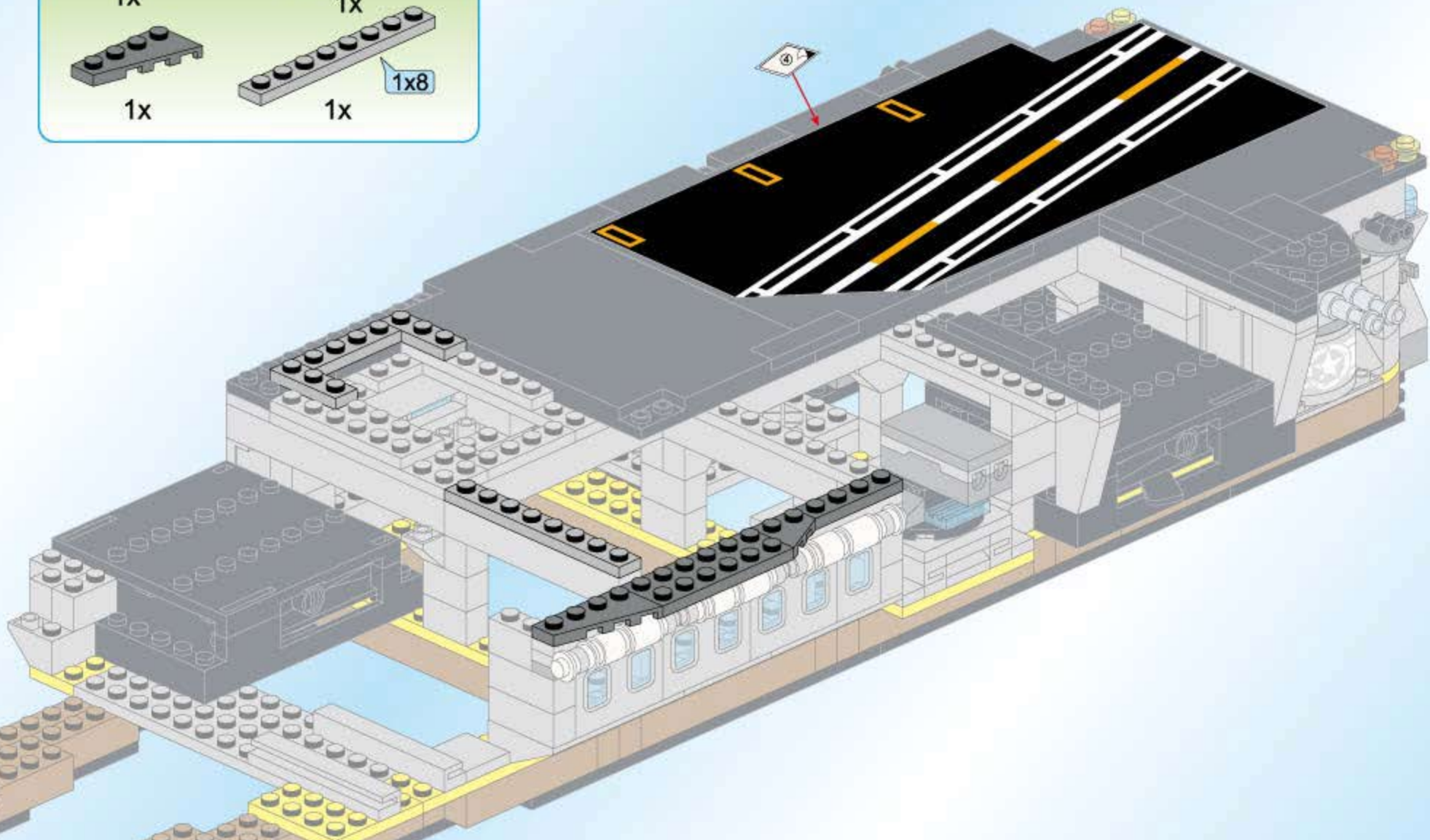
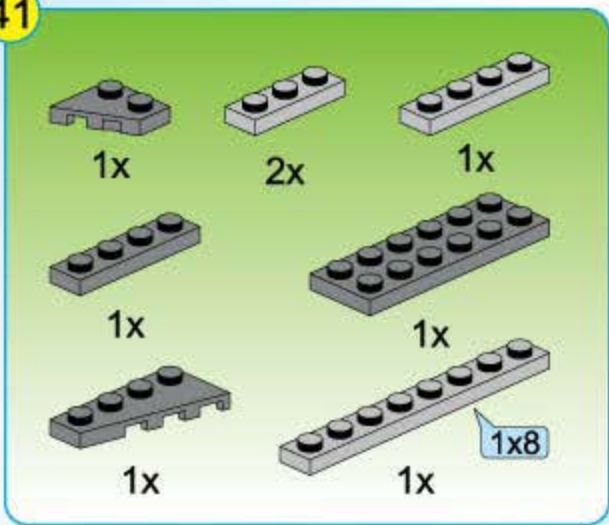

42

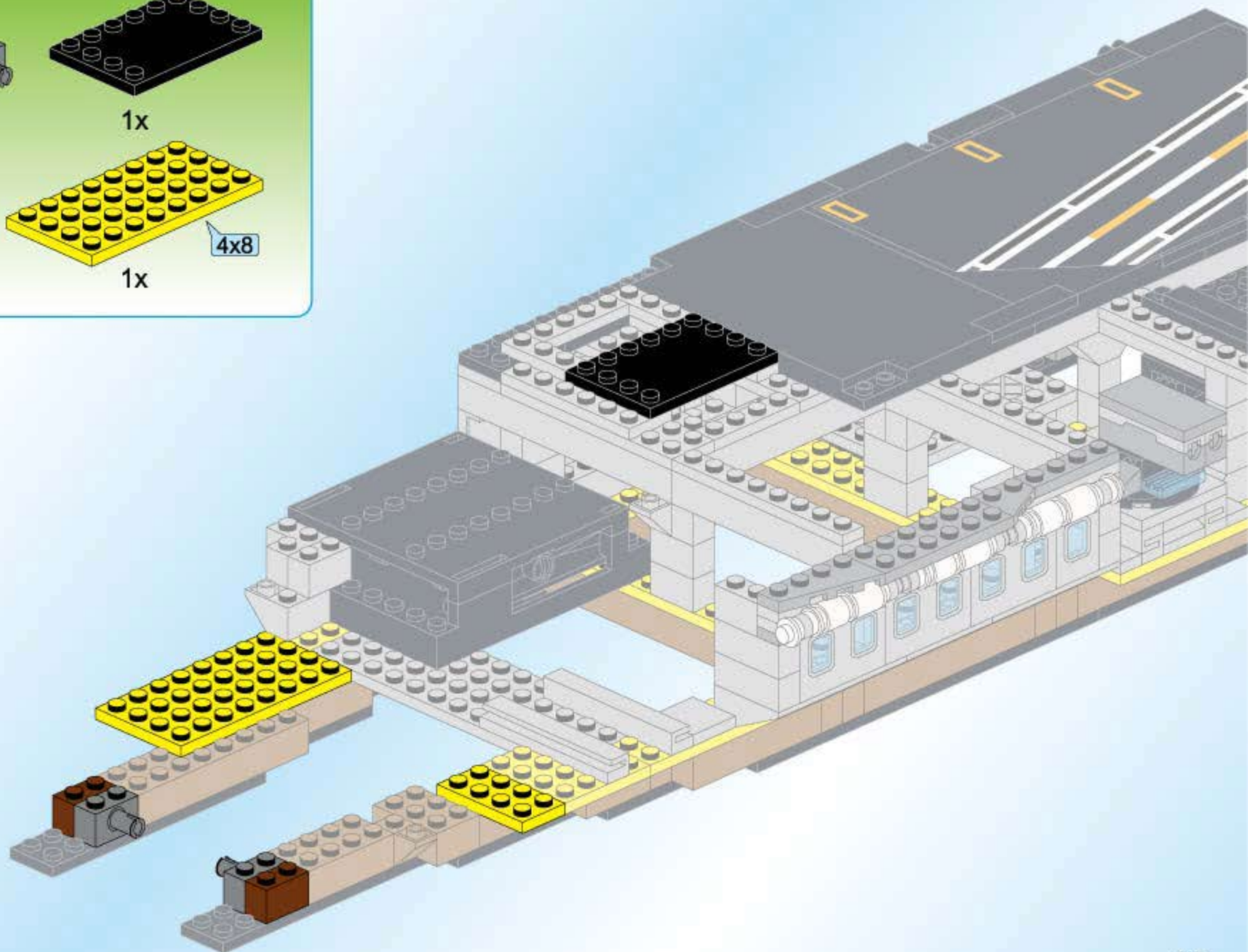
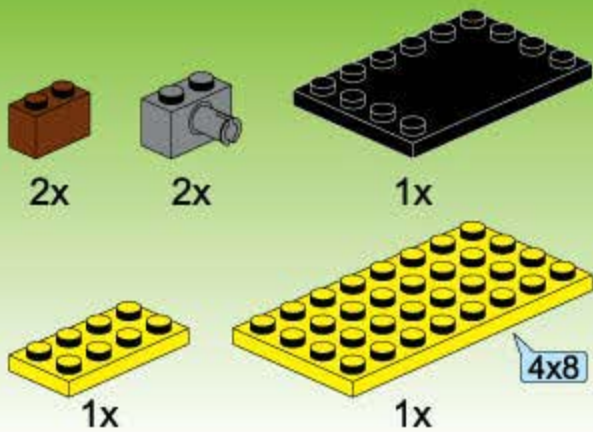

43

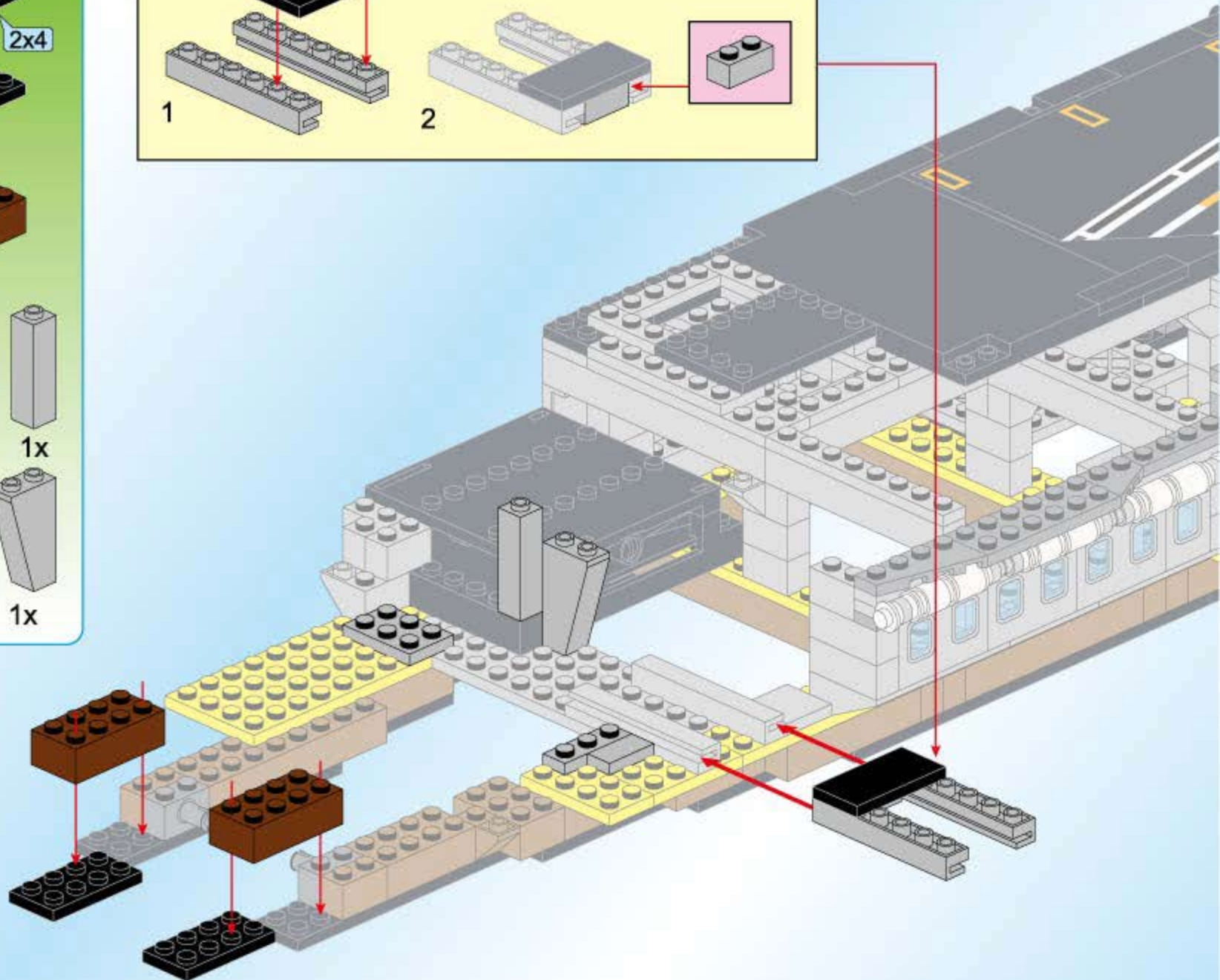
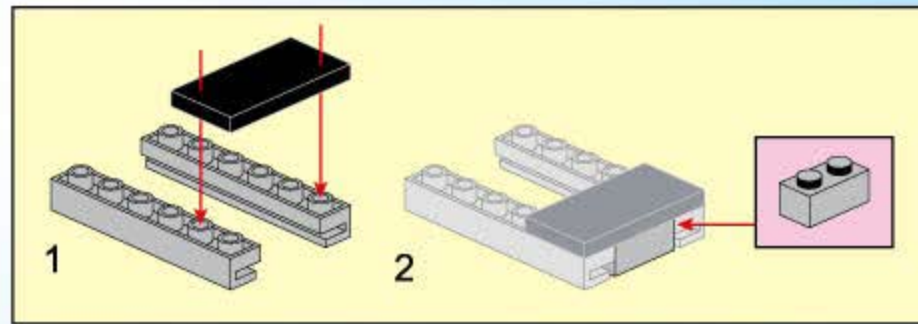
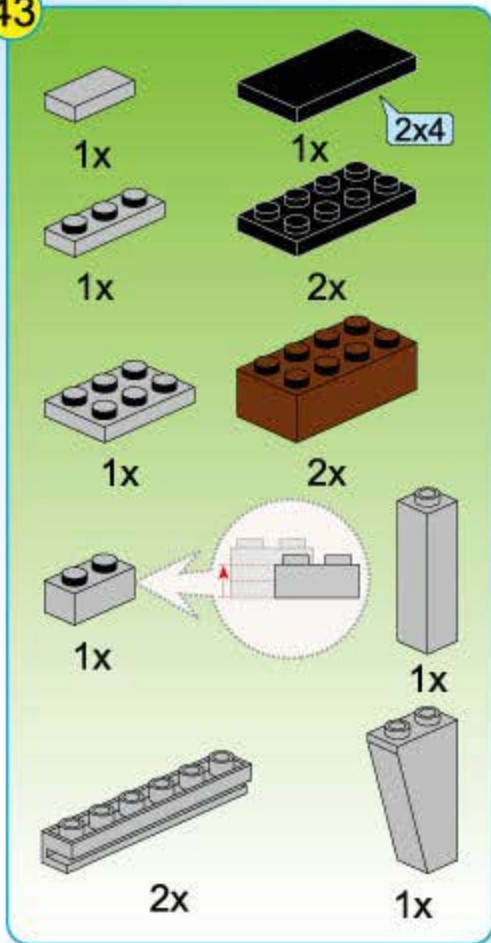

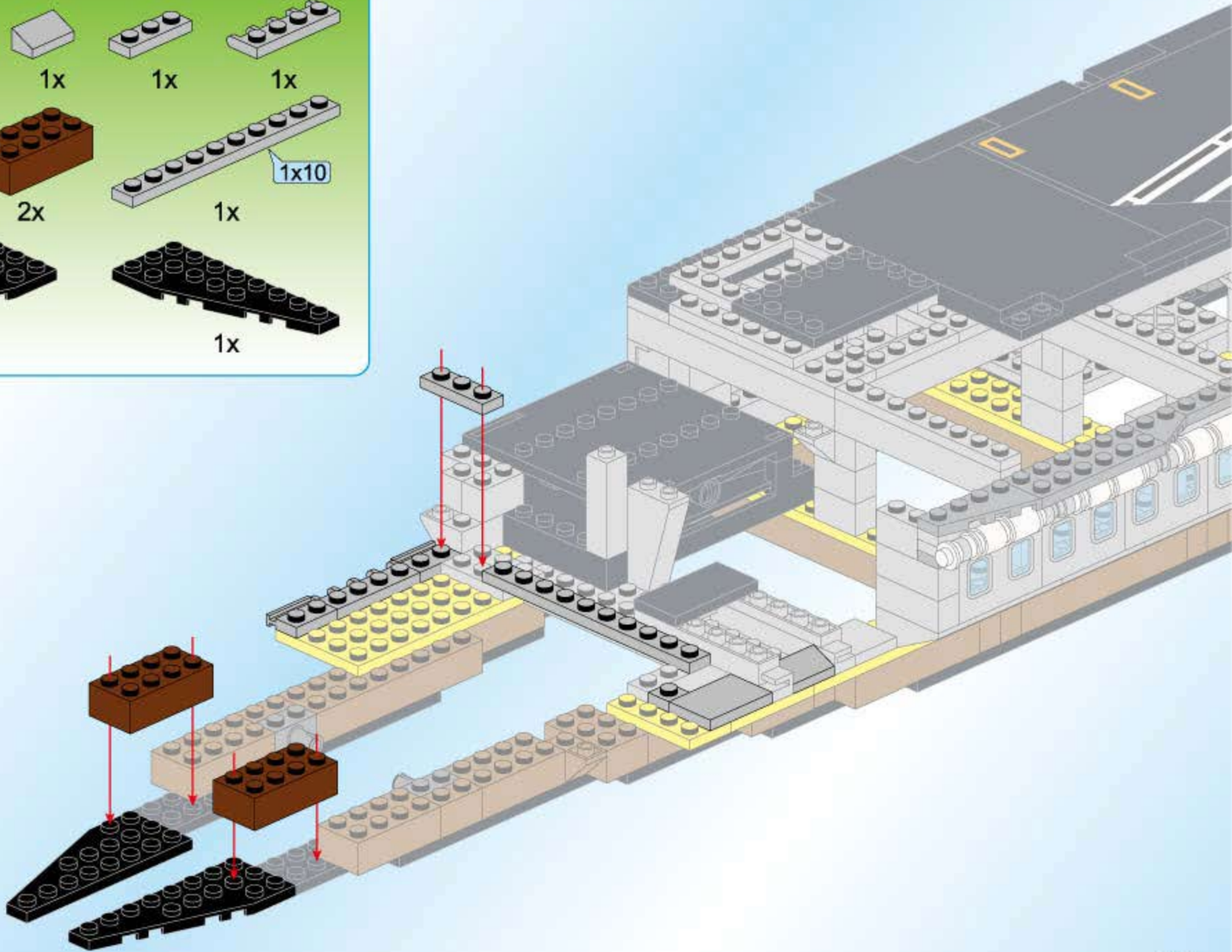
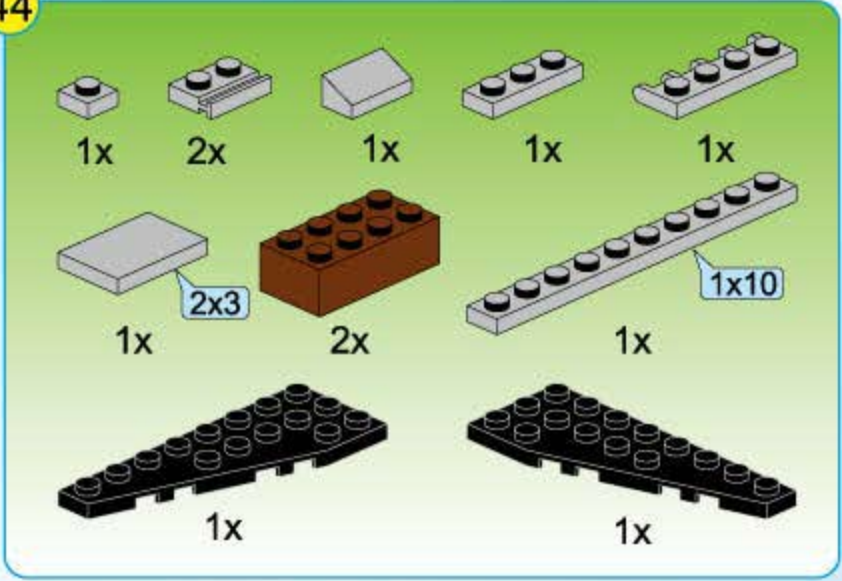

45

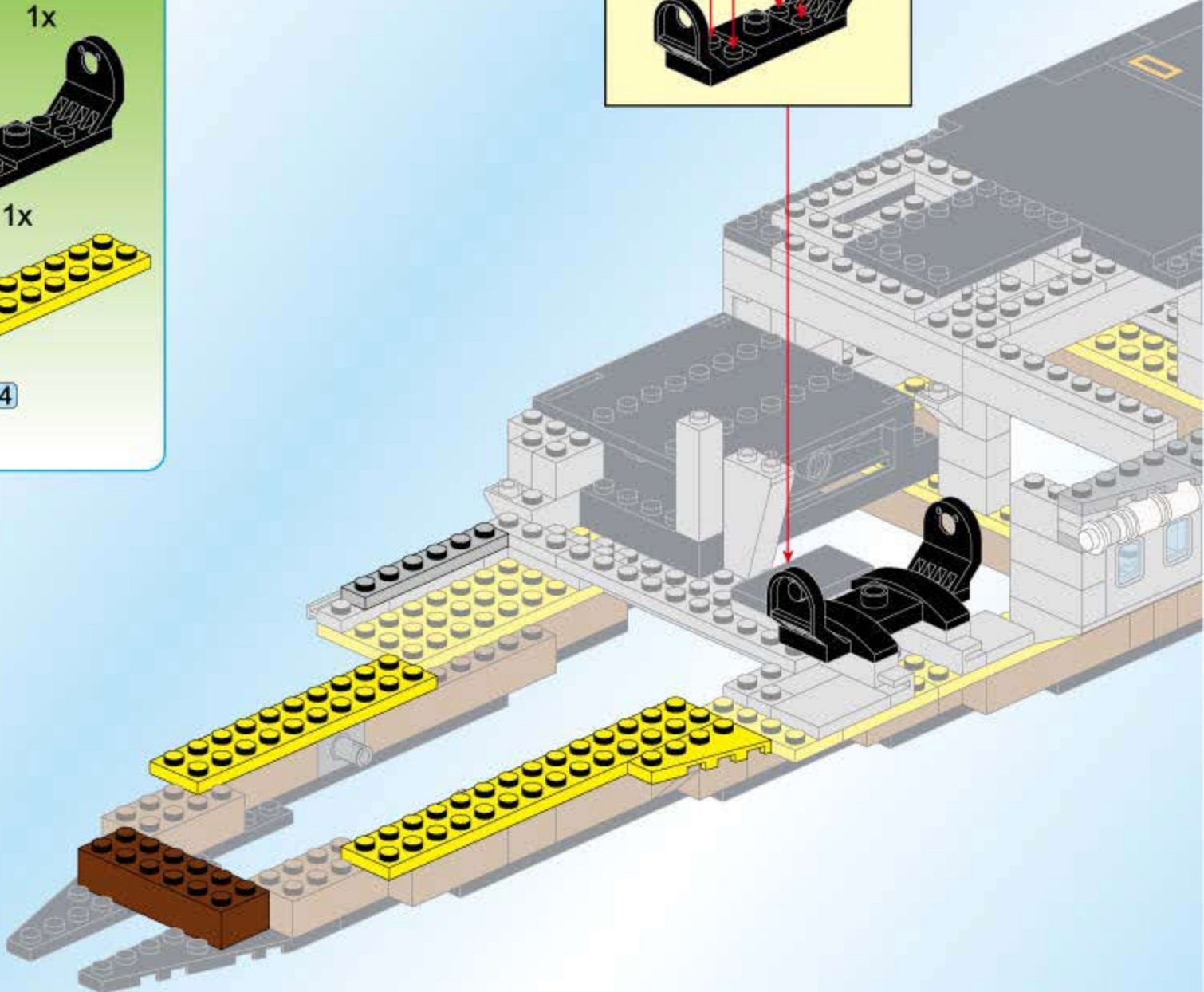
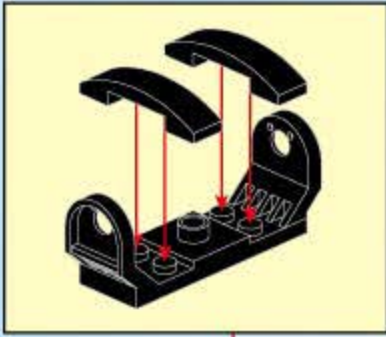
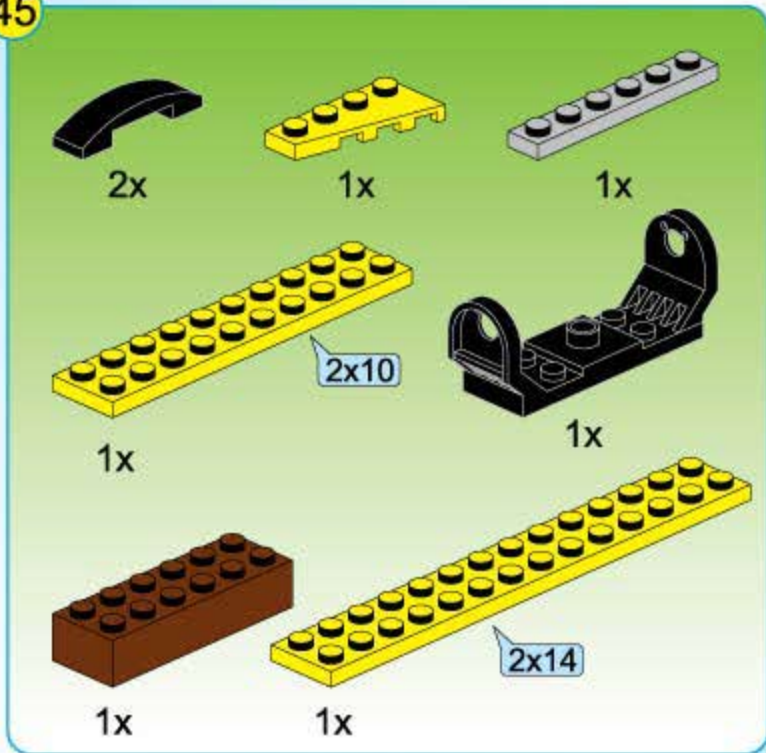

46

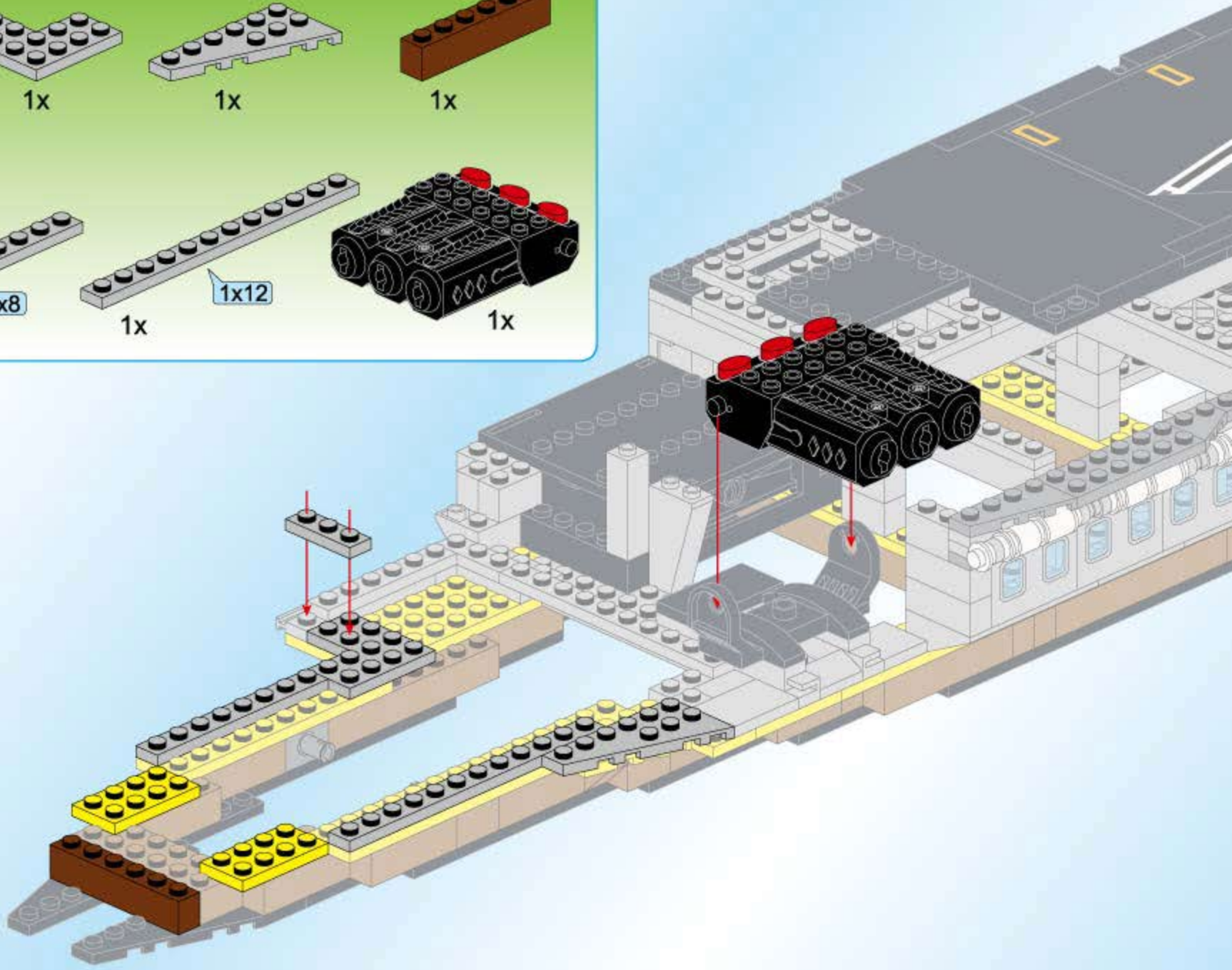
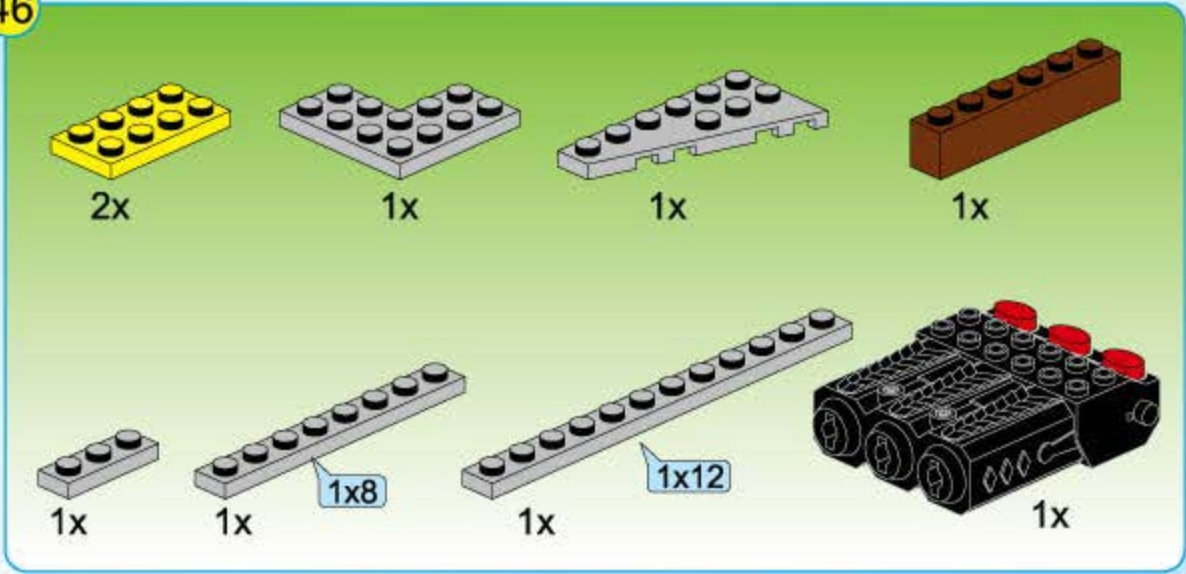

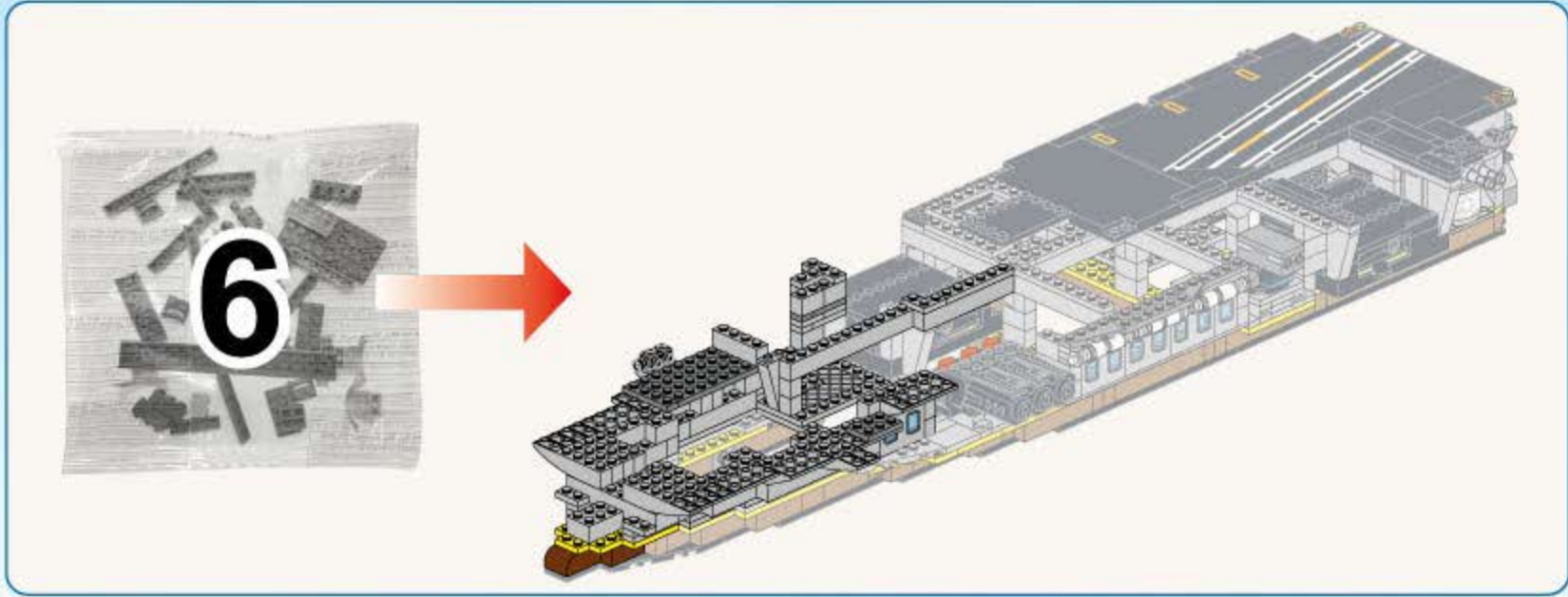

47

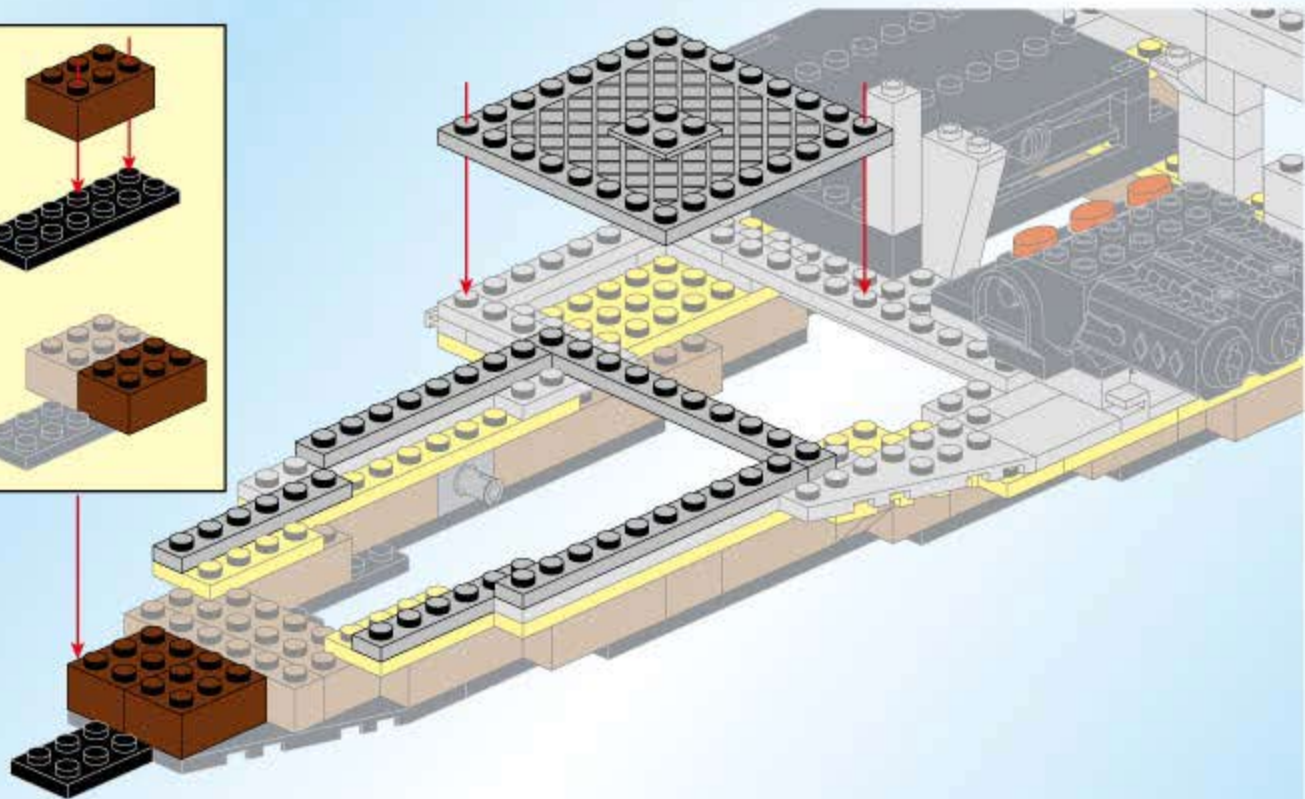
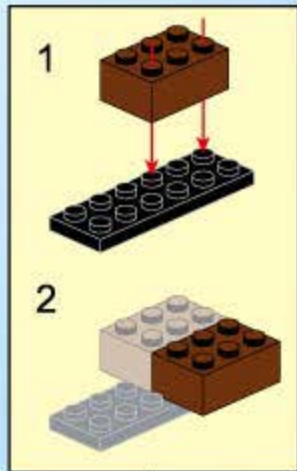
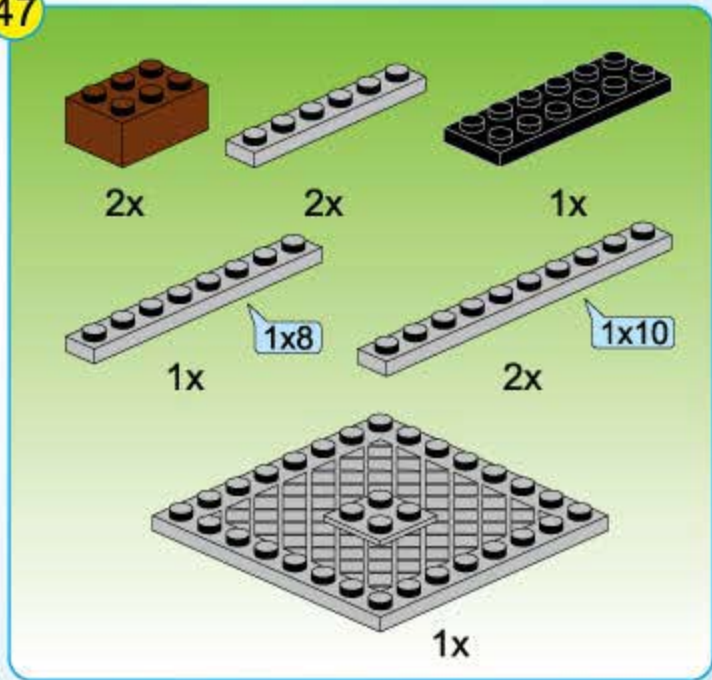

48

- 2x
- 1x
- 2x
- 1x
- 1x
- 1x
- 1x
- 1x

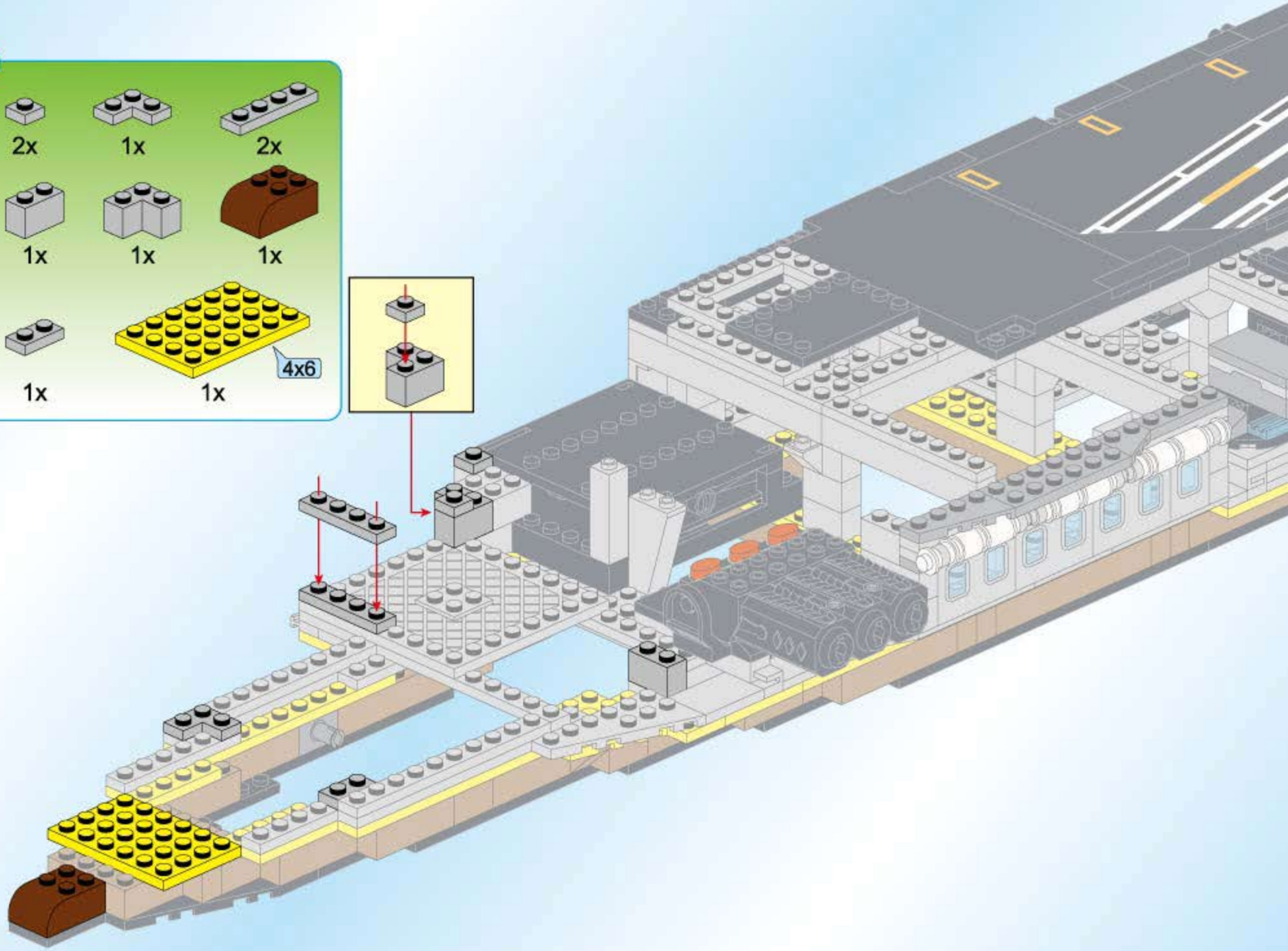
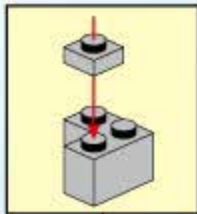

49

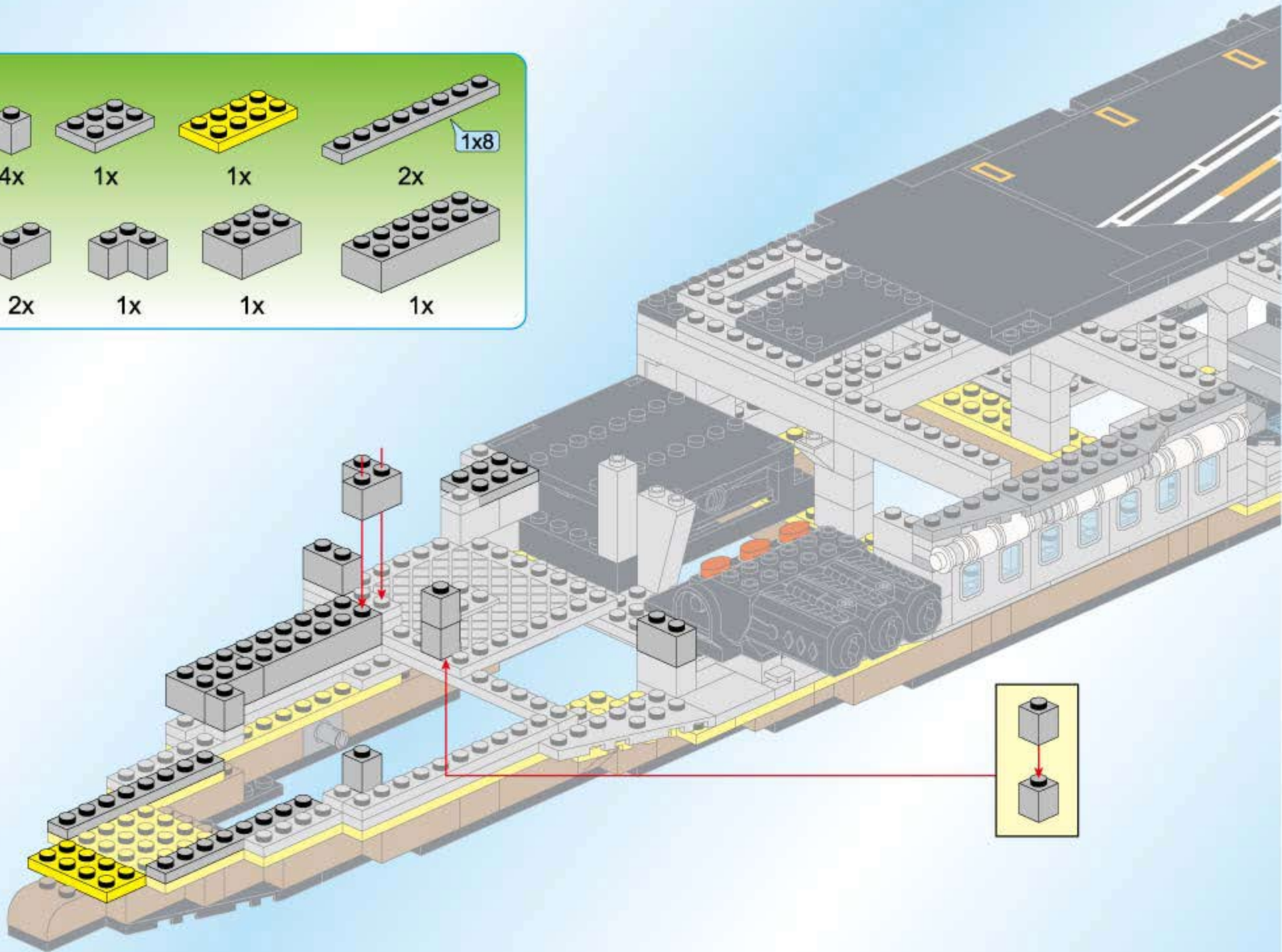
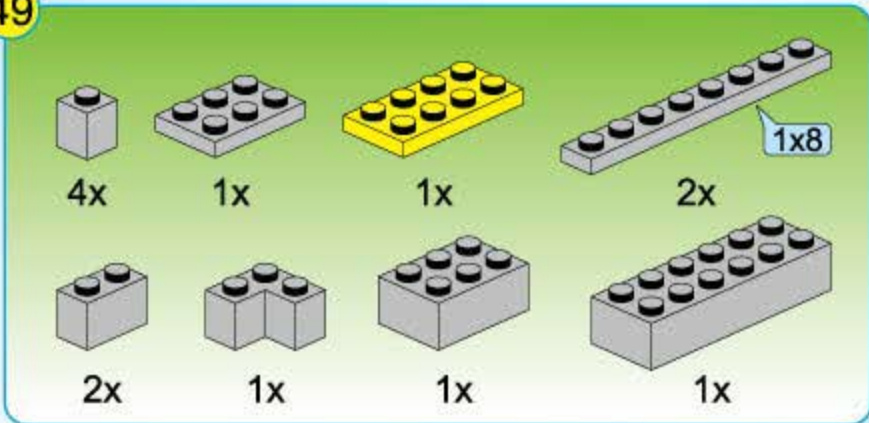

50

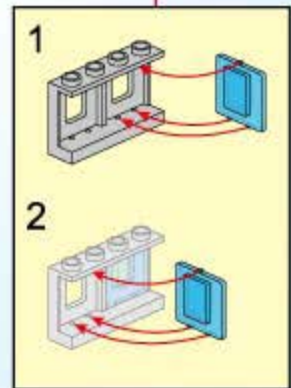
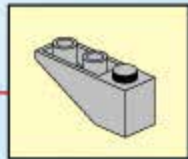
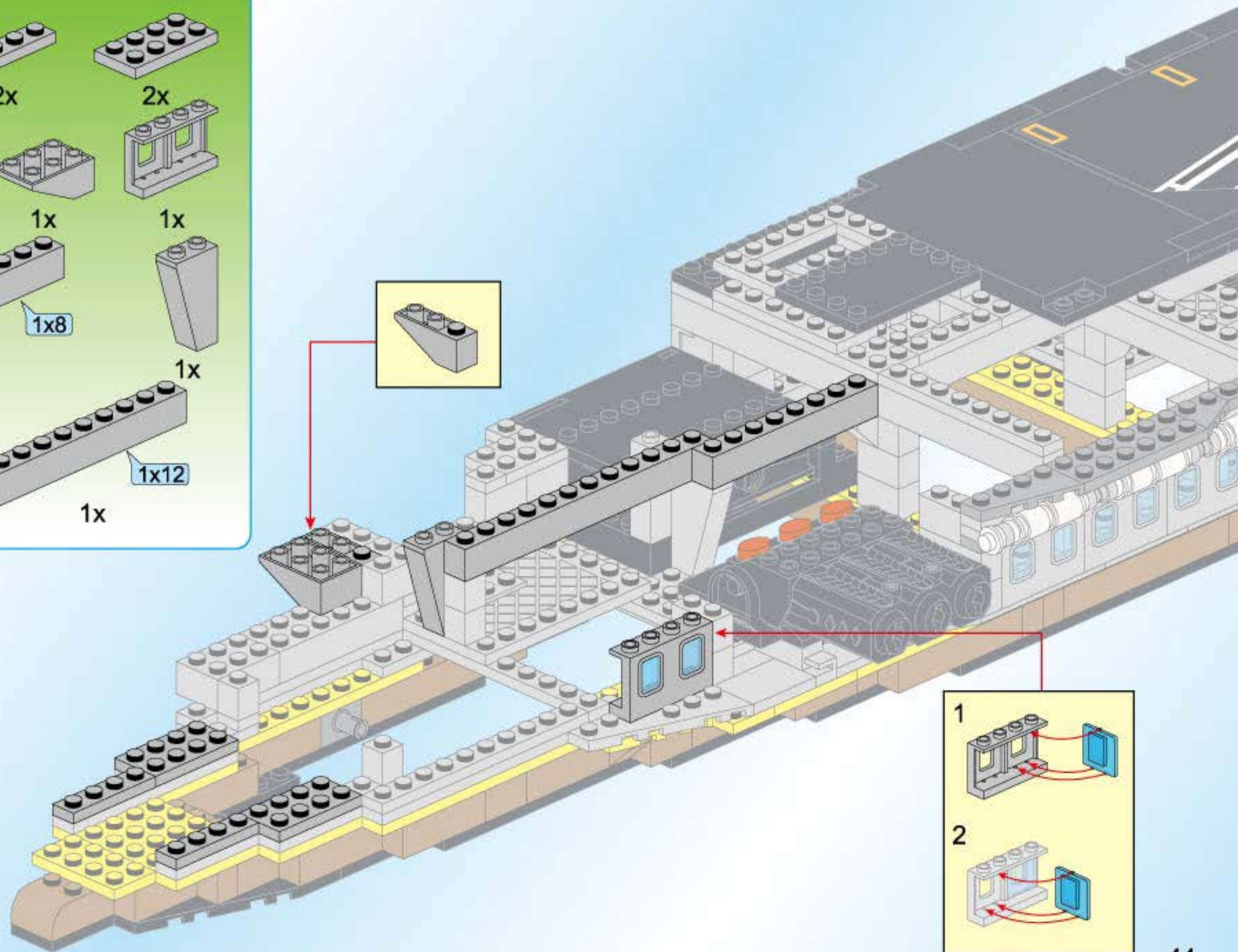
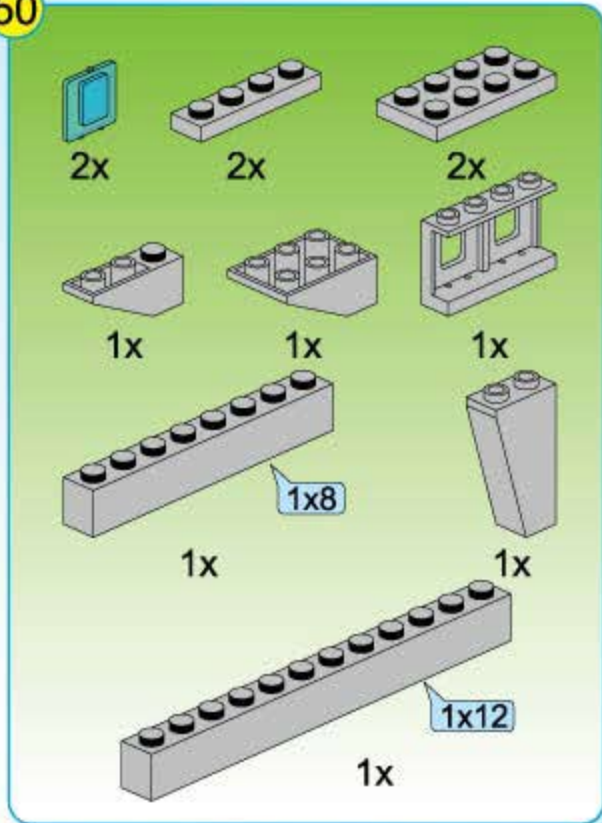

51

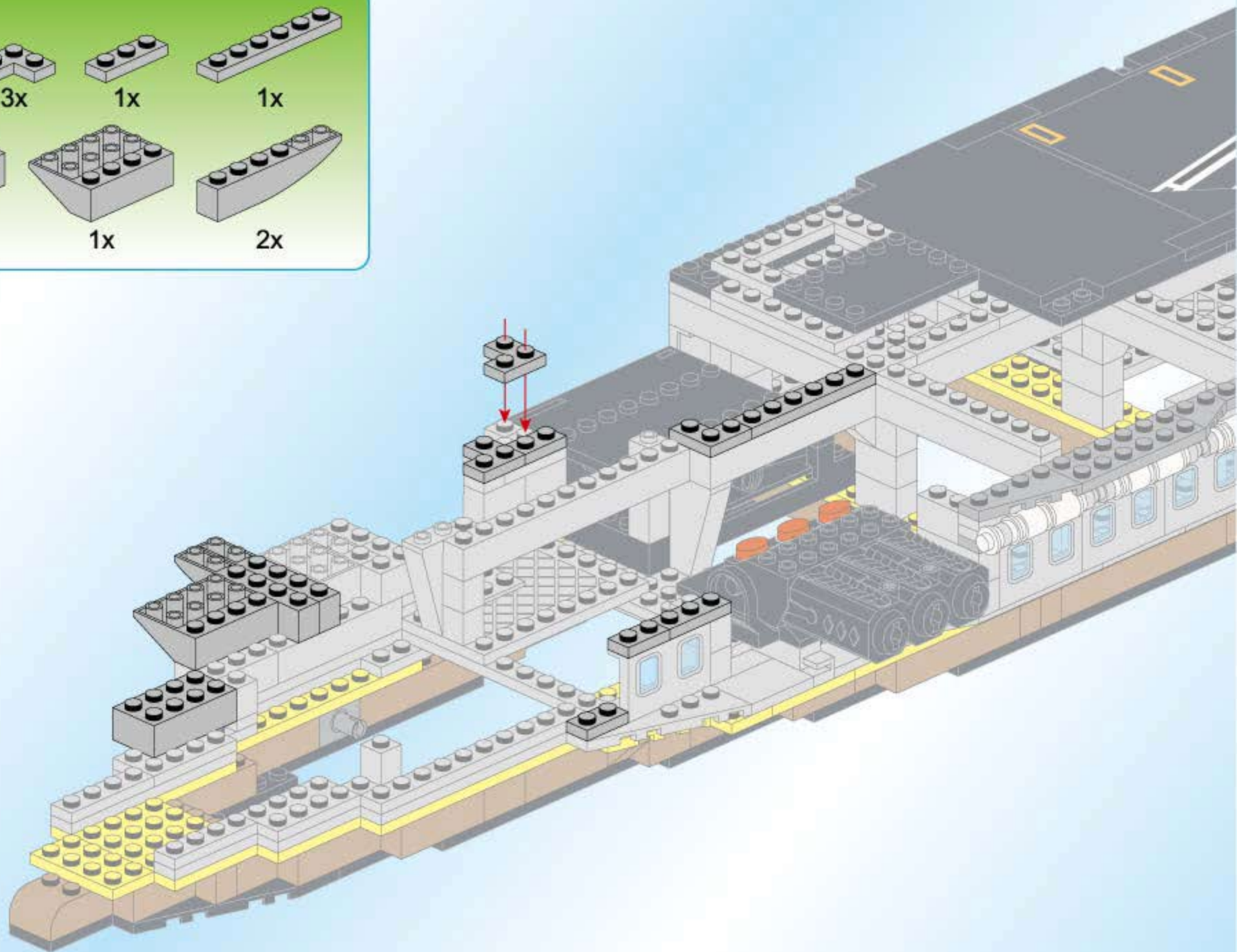
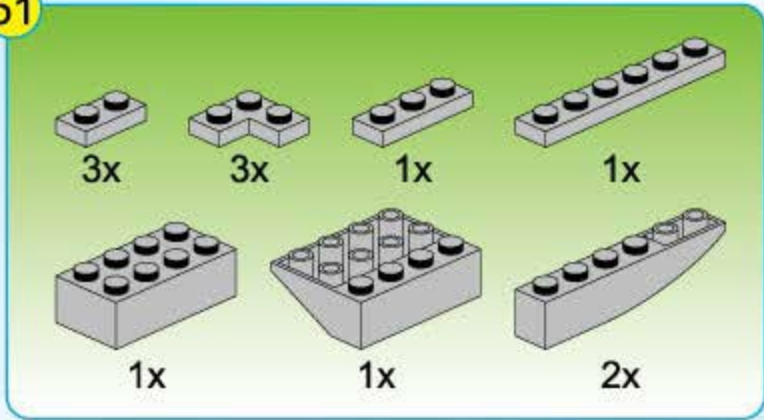

52

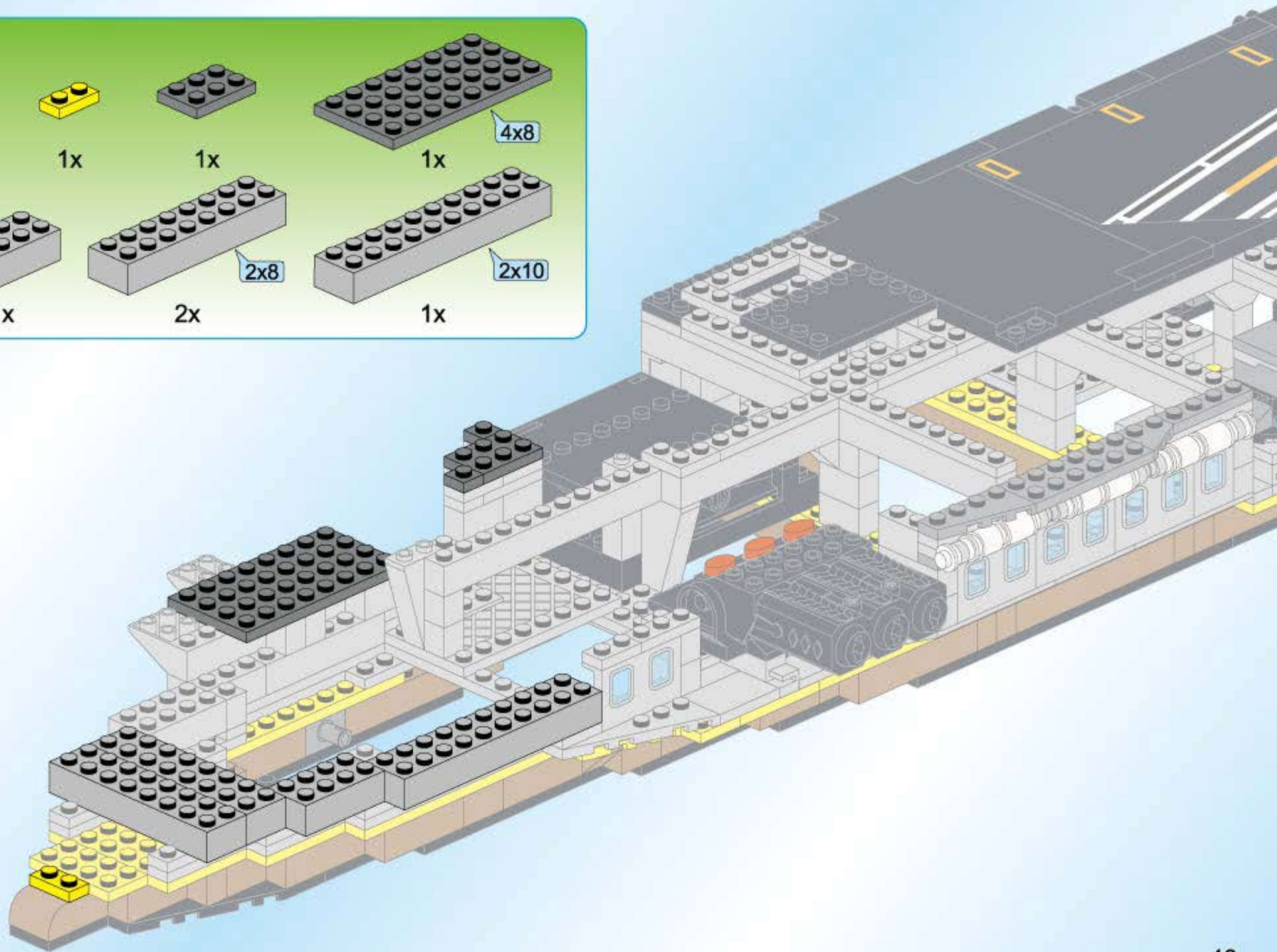
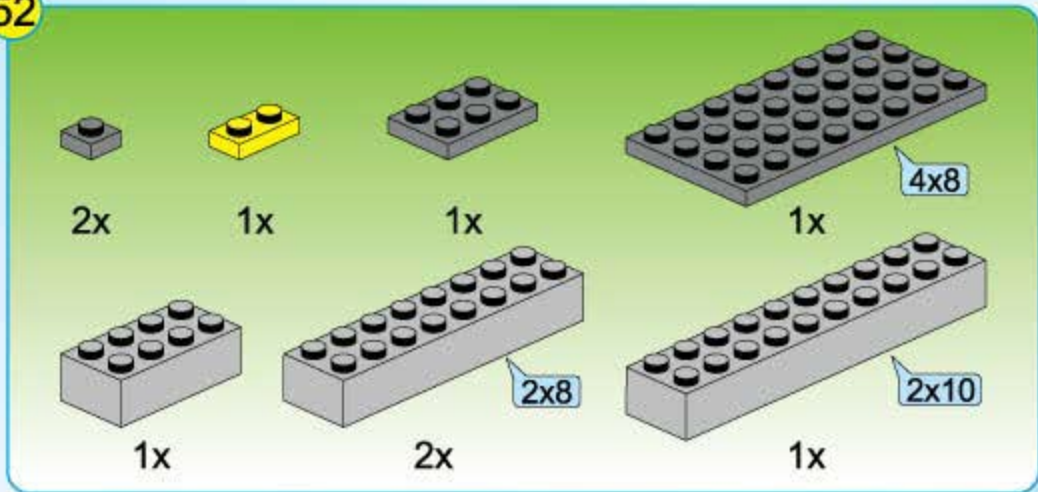

53

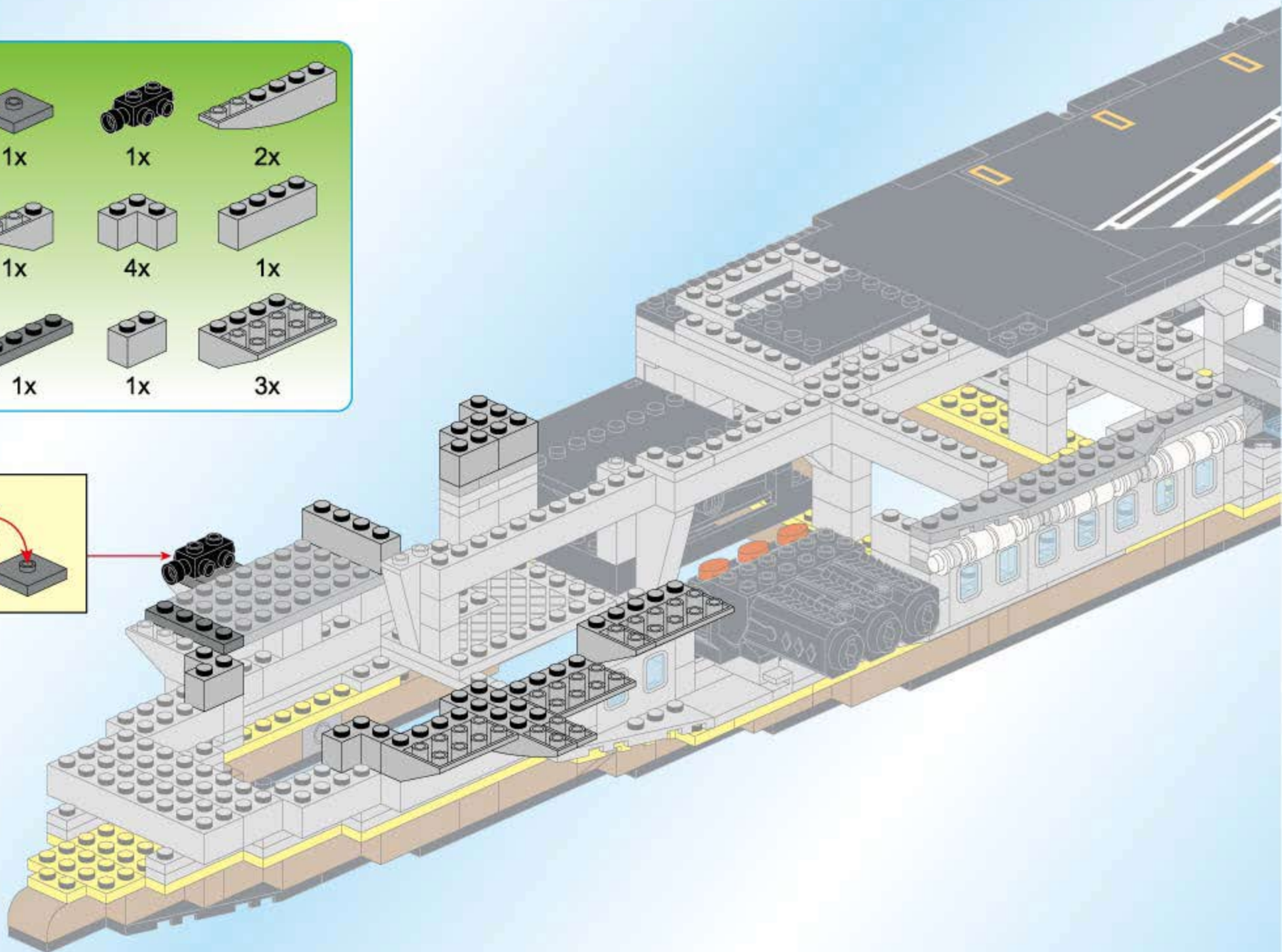
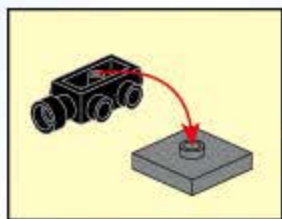
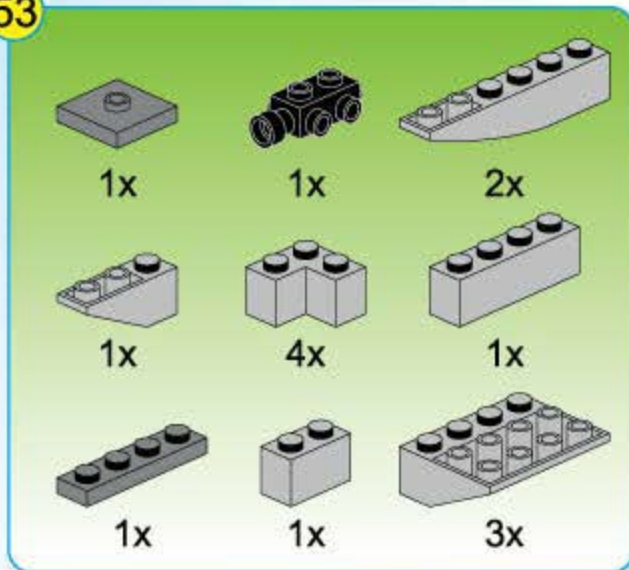

54

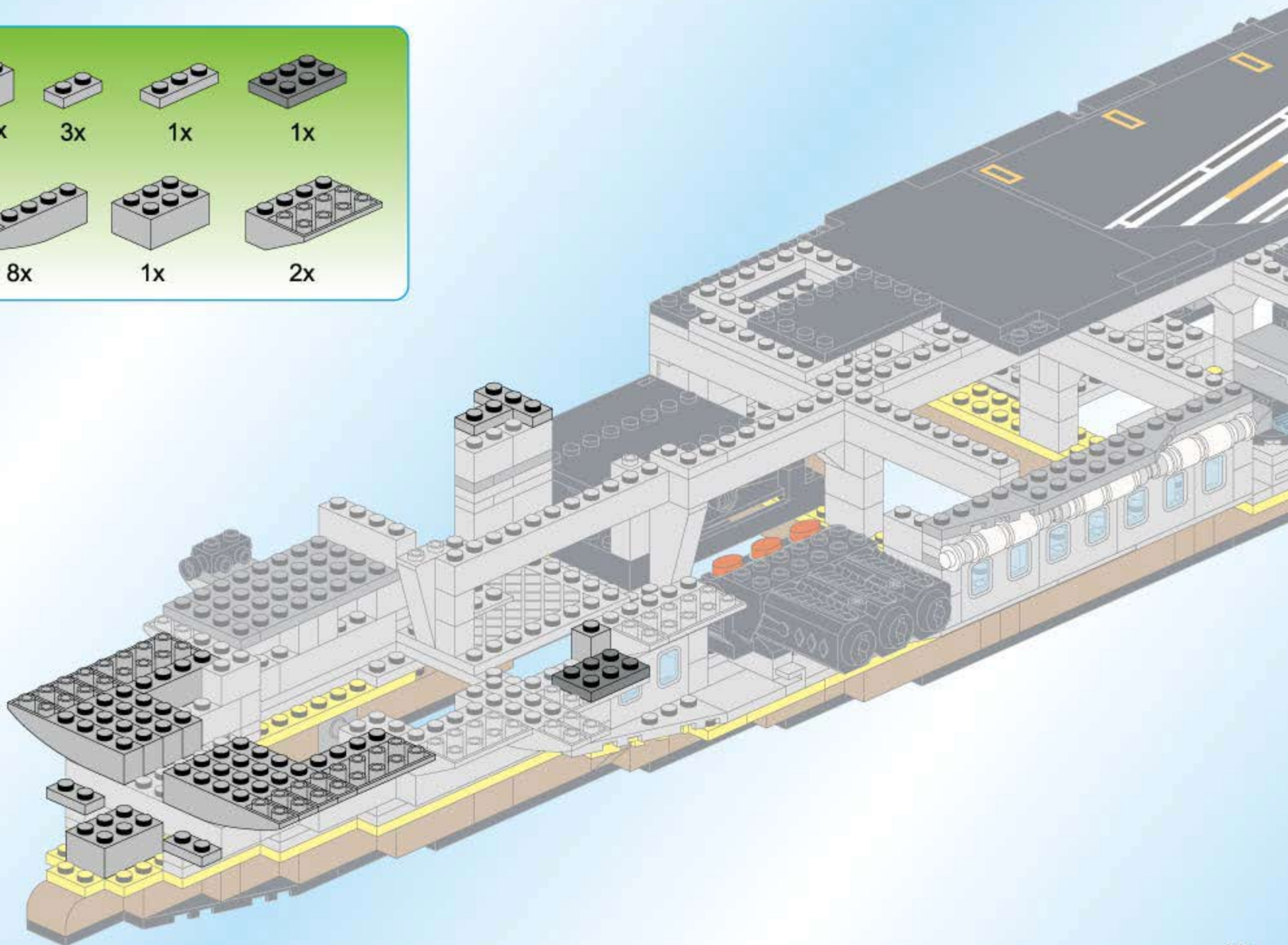
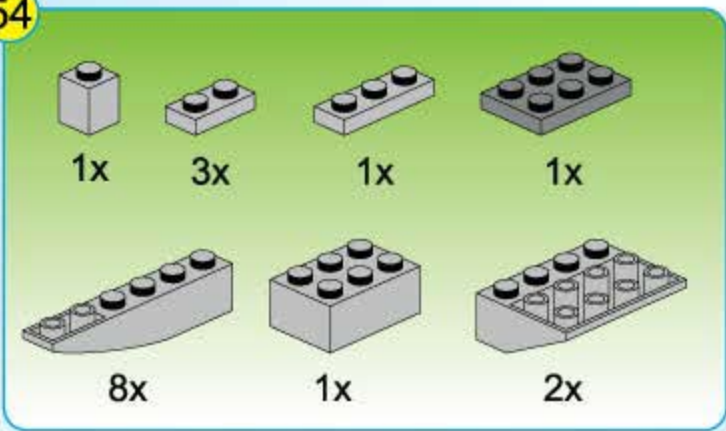



+ 5x =

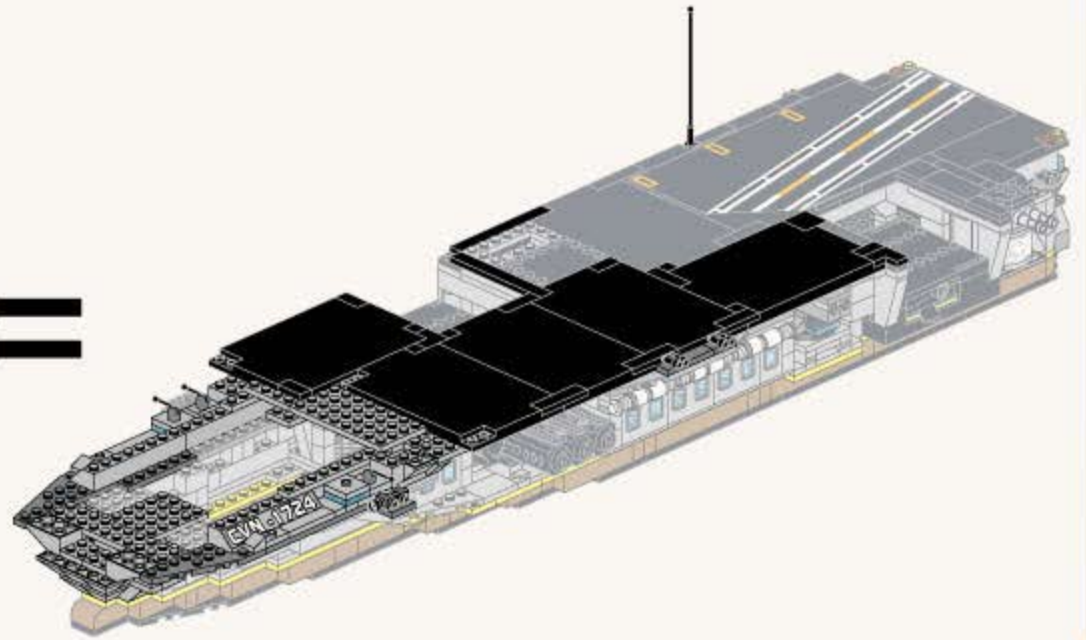

55

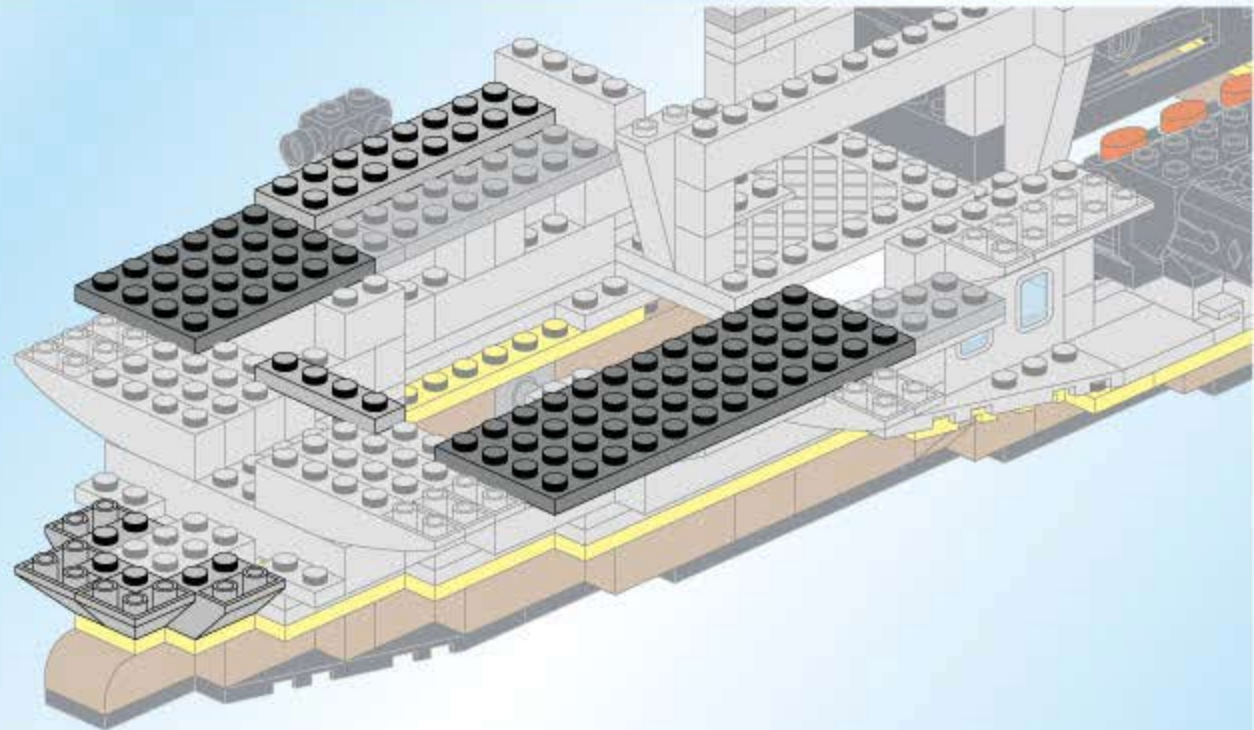
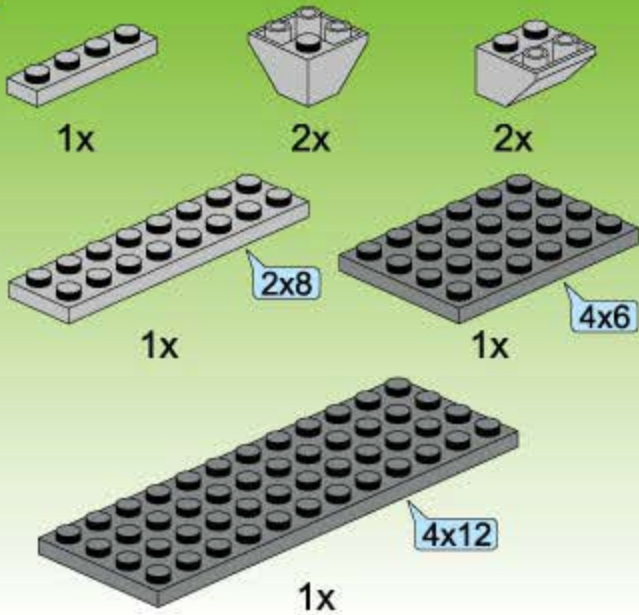

56

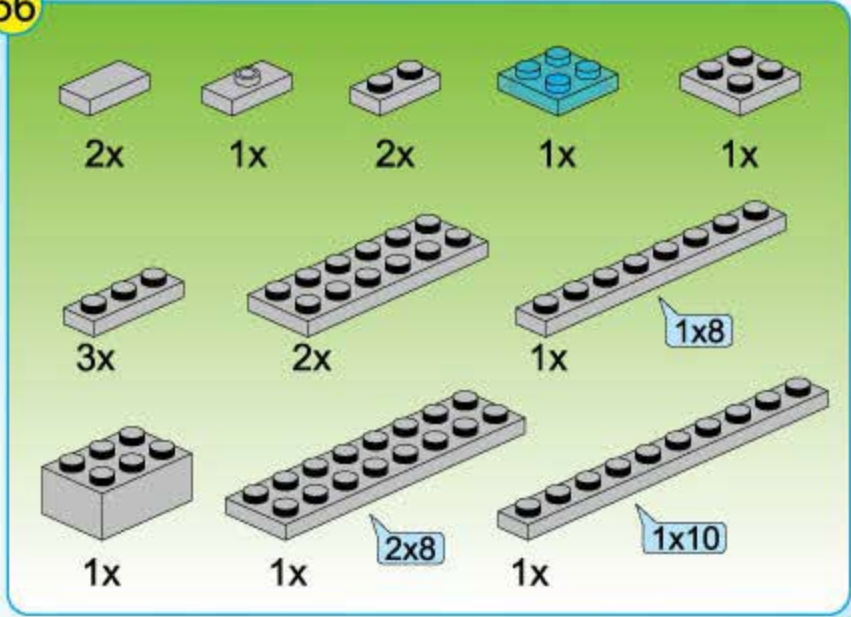

Parts list for step 56:

- 2x 1x1 grey plate
- 1x 1x1 grey plate with hole
- 2x 1x2 grey plate
- 1x 2x2 blue plate
- 1x 2x2 grey plate
- 3x 1x3 grey plate
- 2x 1x8 grey plate
- 1x 1x8 grey plate
- 1x 1x3 grey plate
- 1x 1x8 grey plate
- 1x 1x10 grey plate

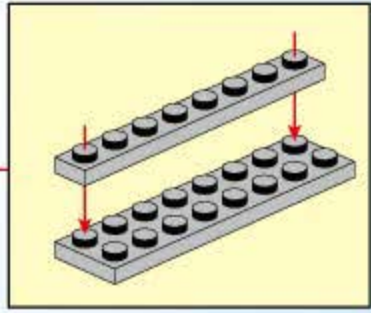
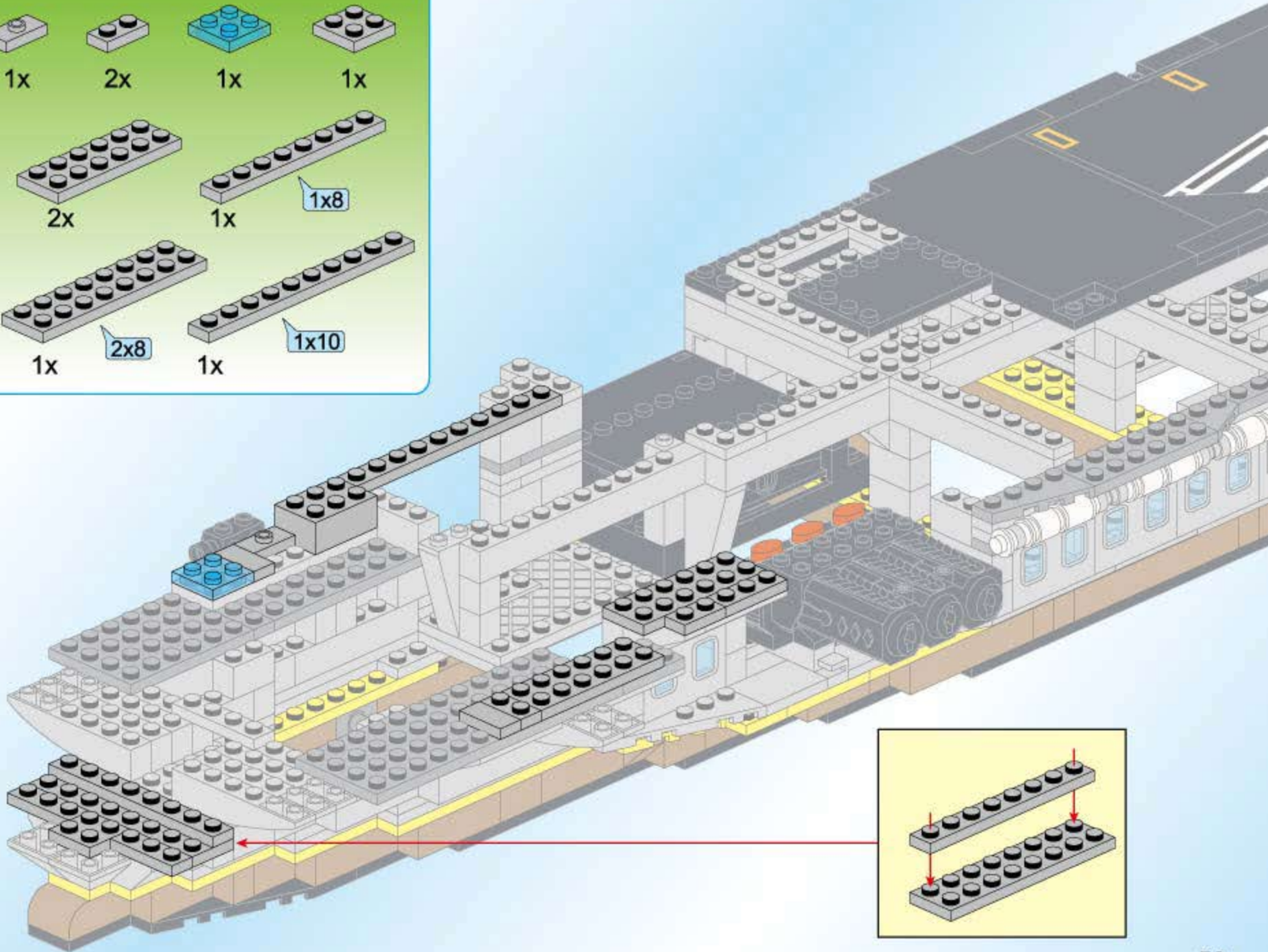

57

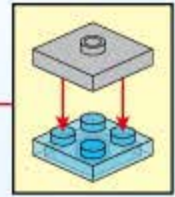
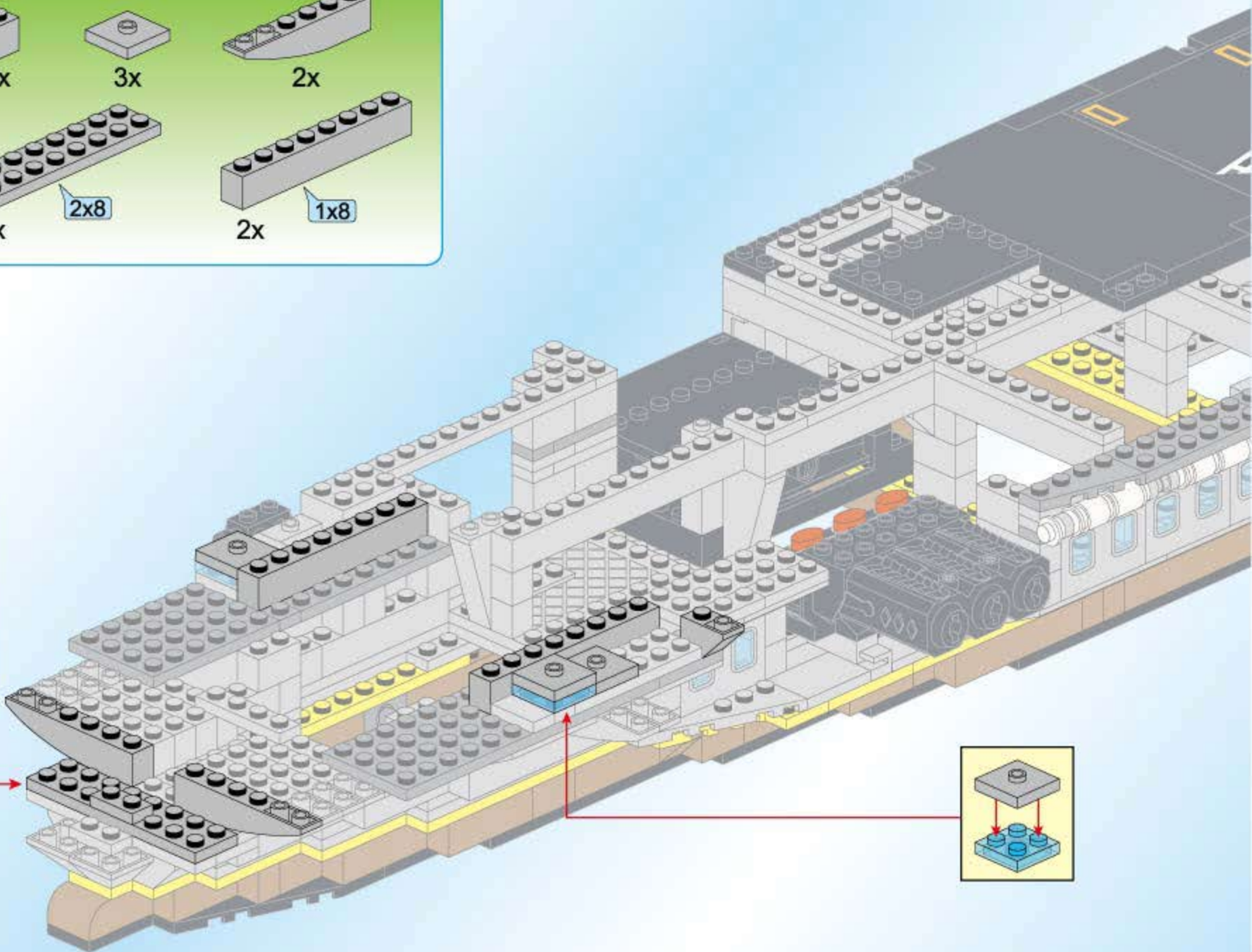
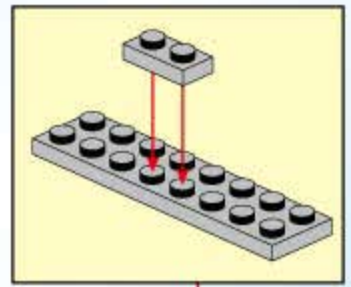
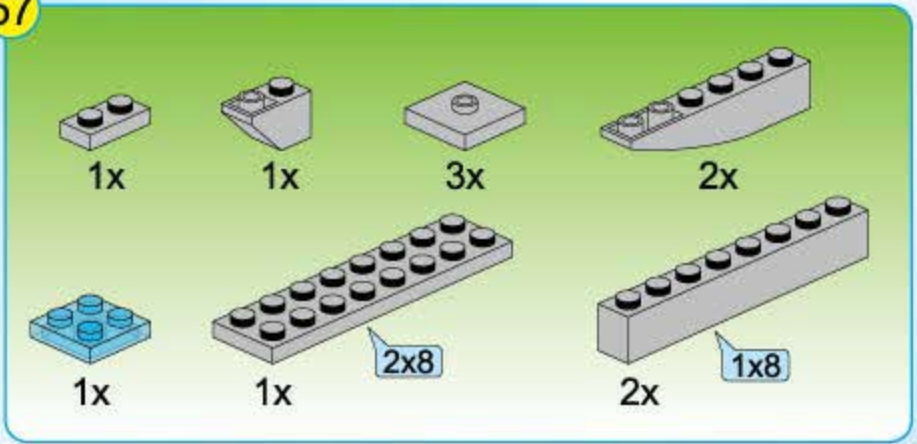

58

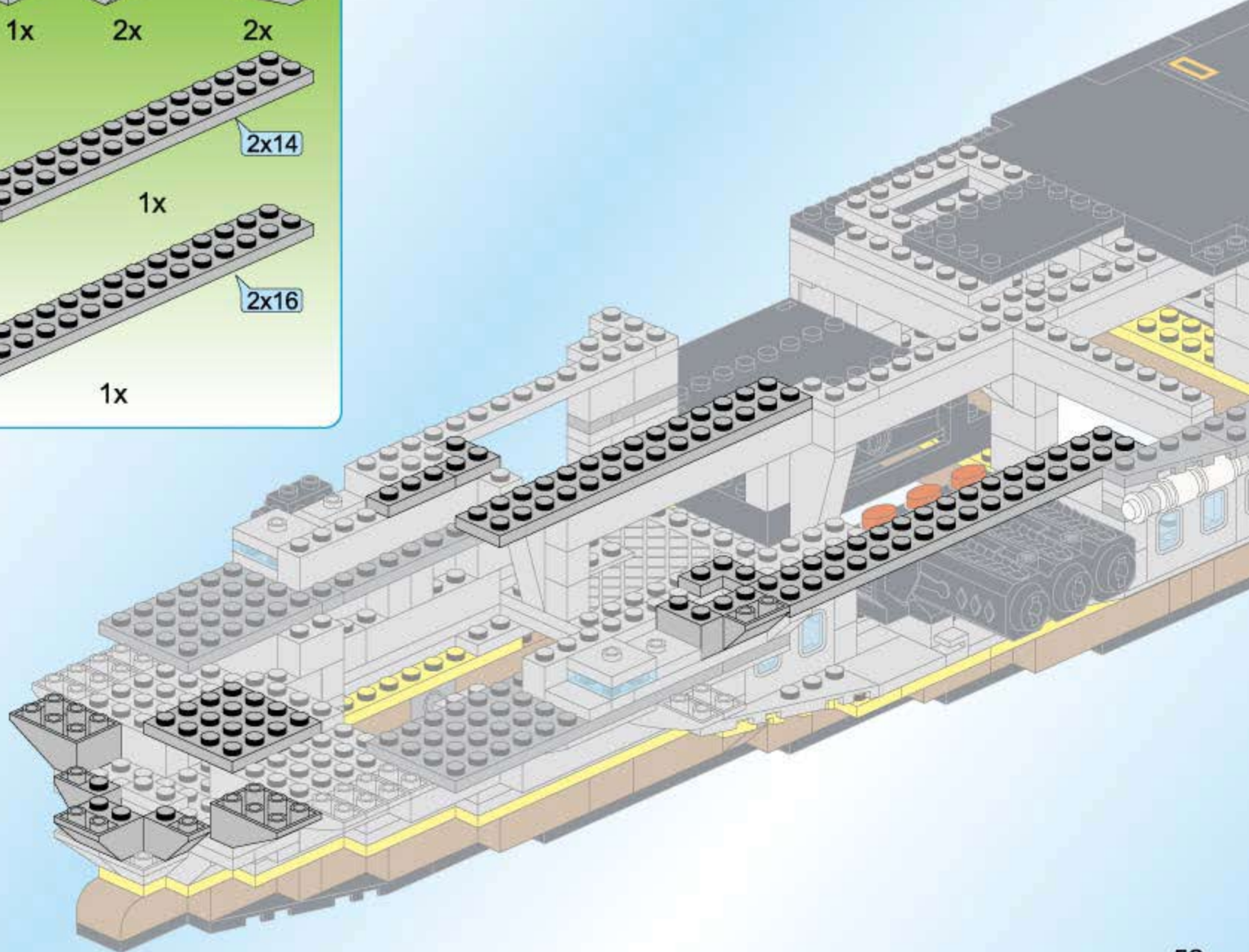
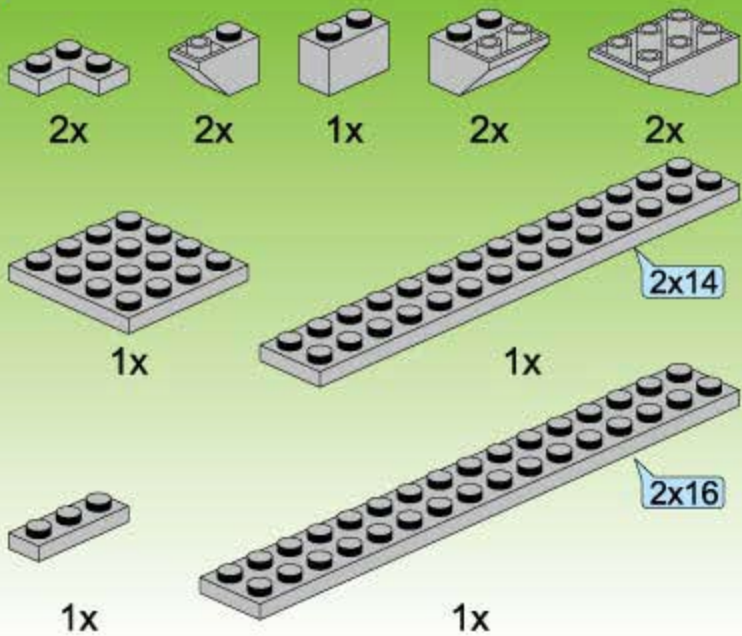

59



1x



1x



2x

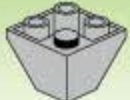

2x

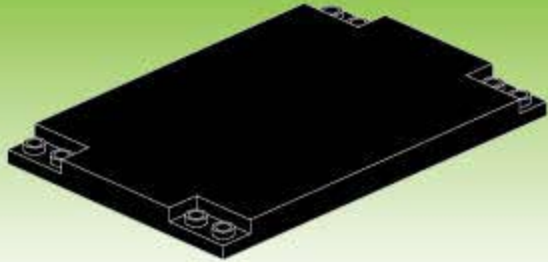

5x

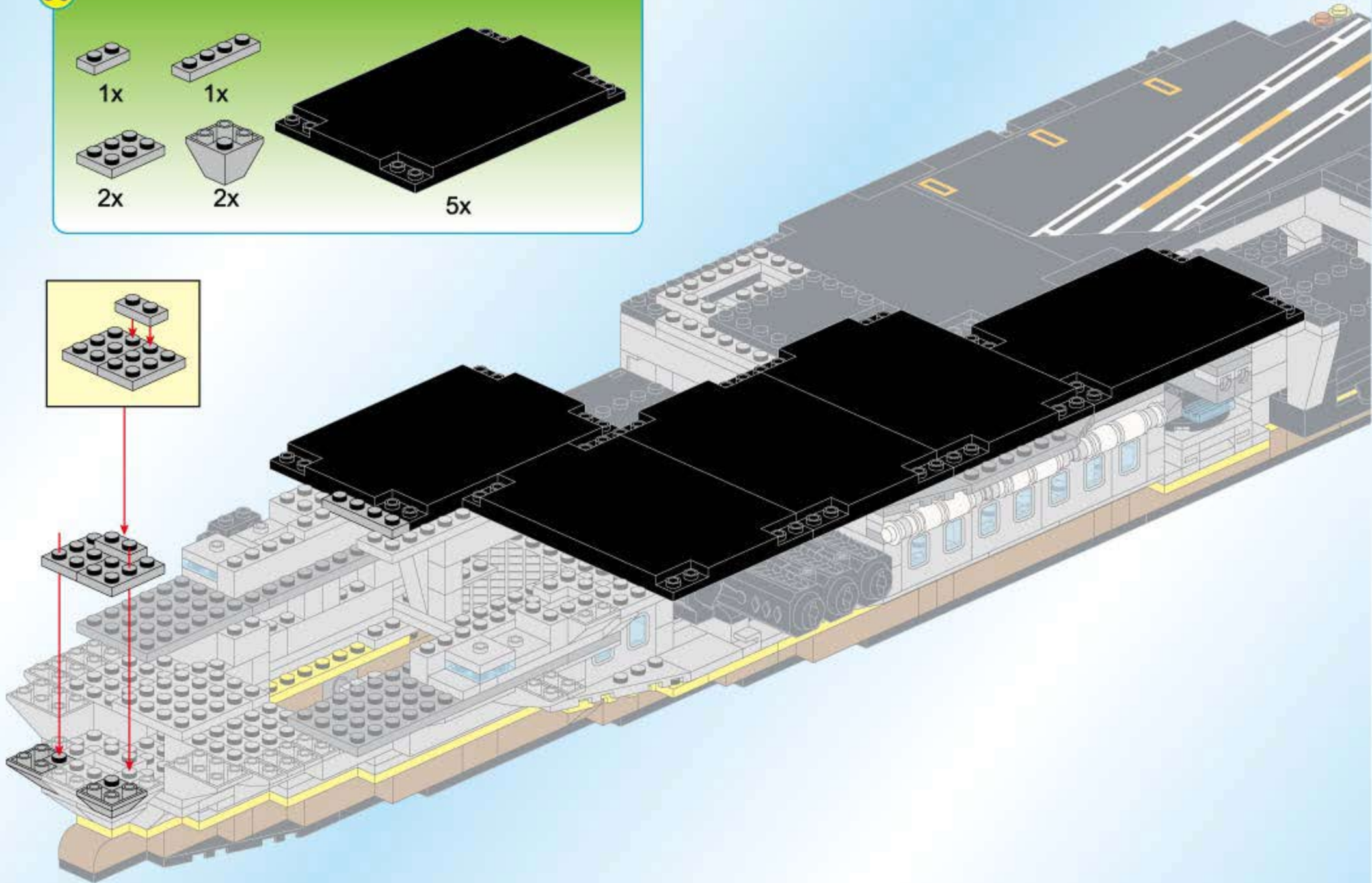
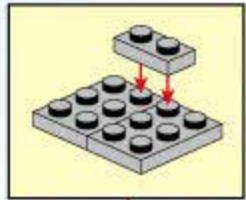

60

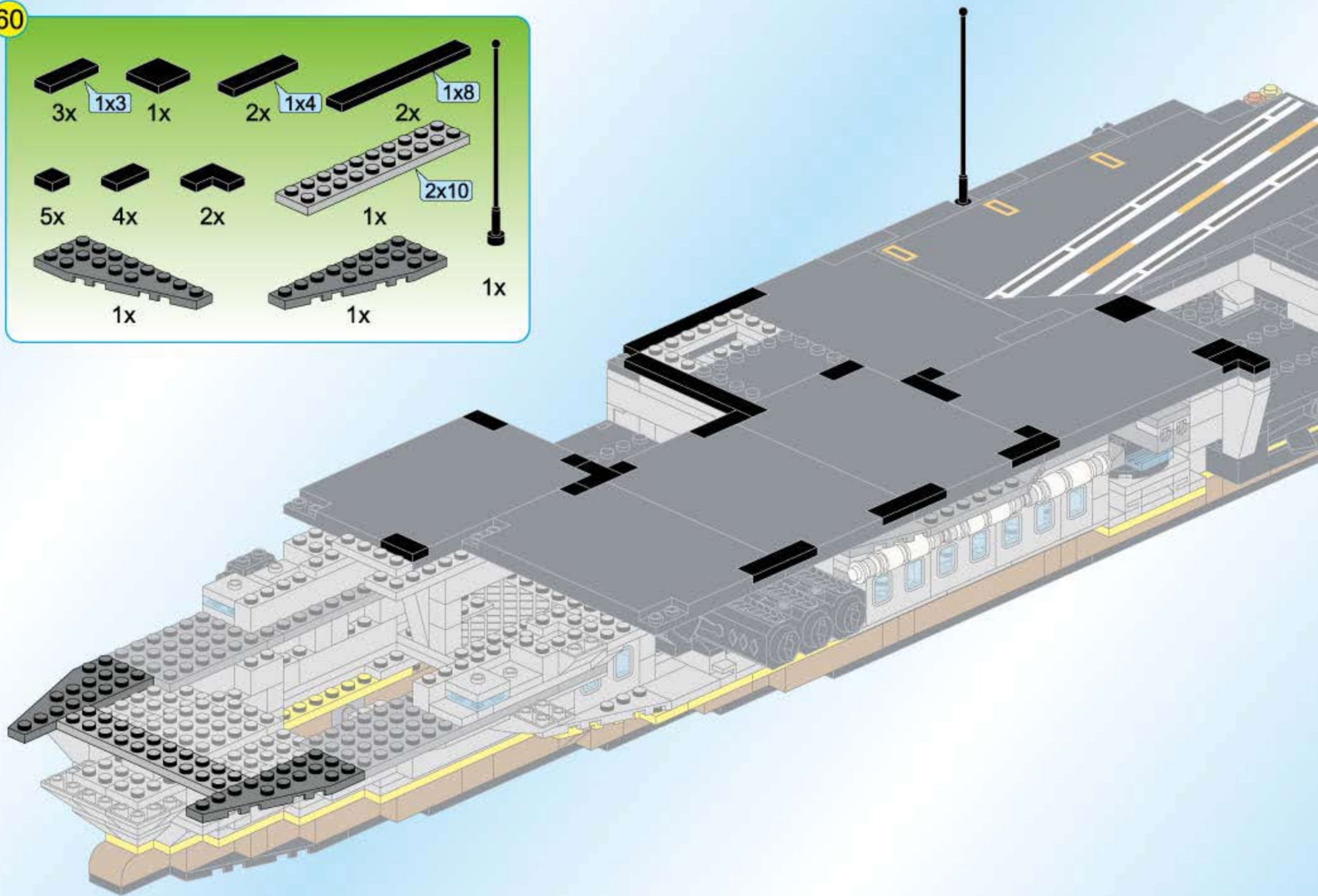
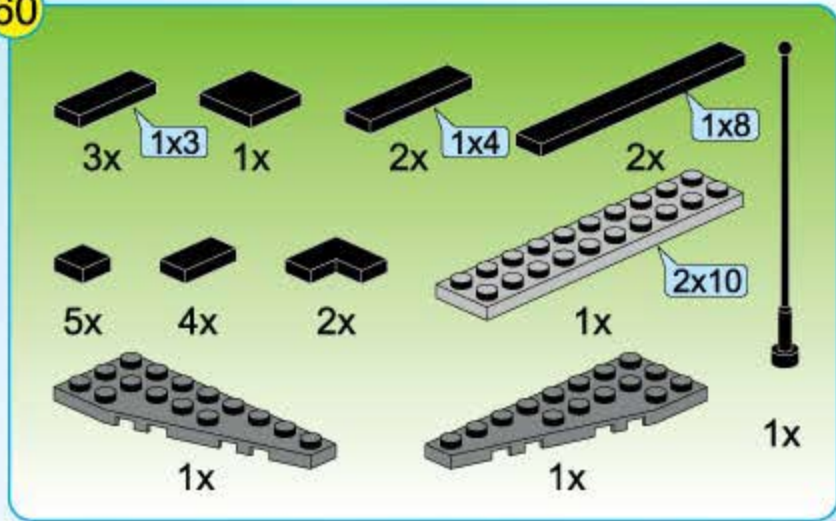

61

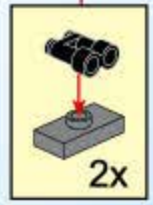
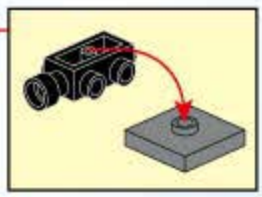
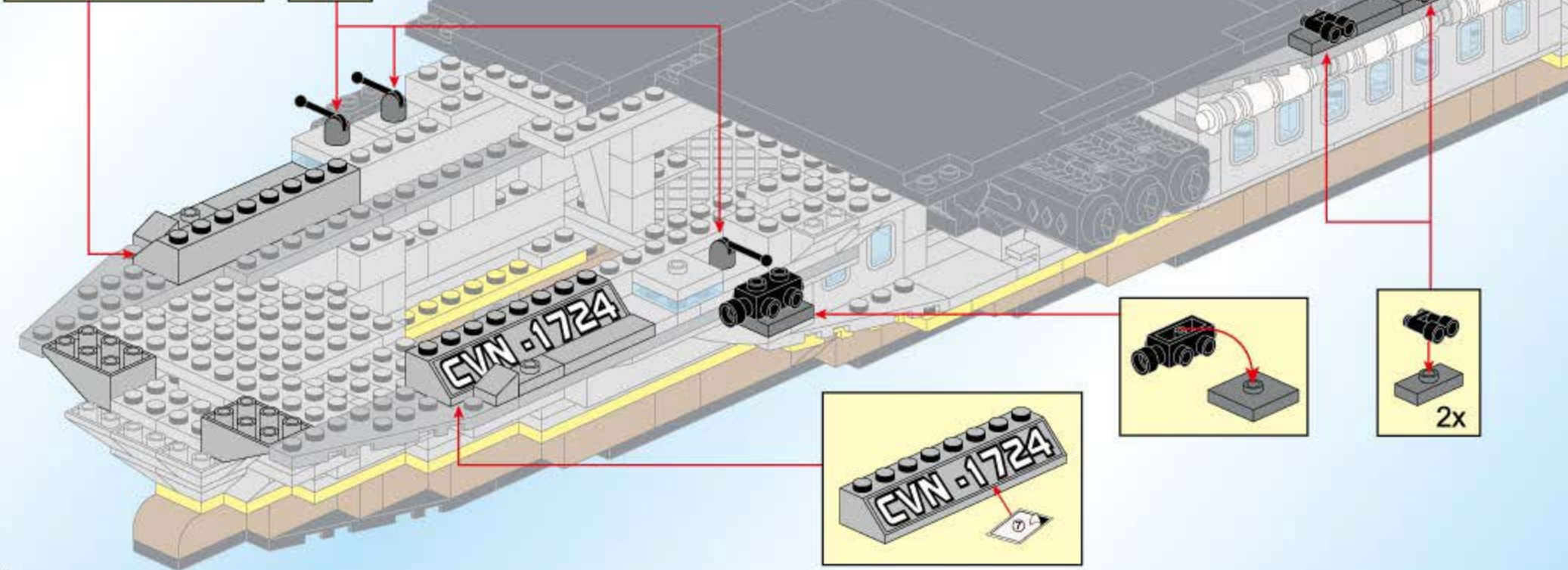
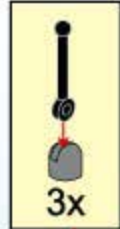
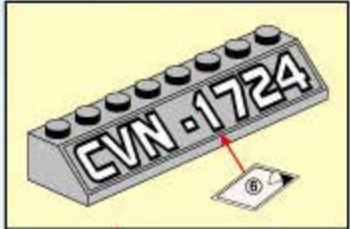
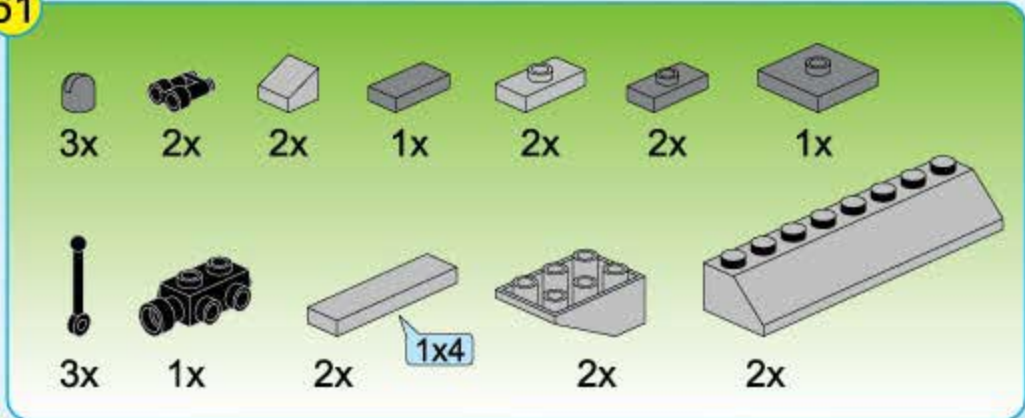

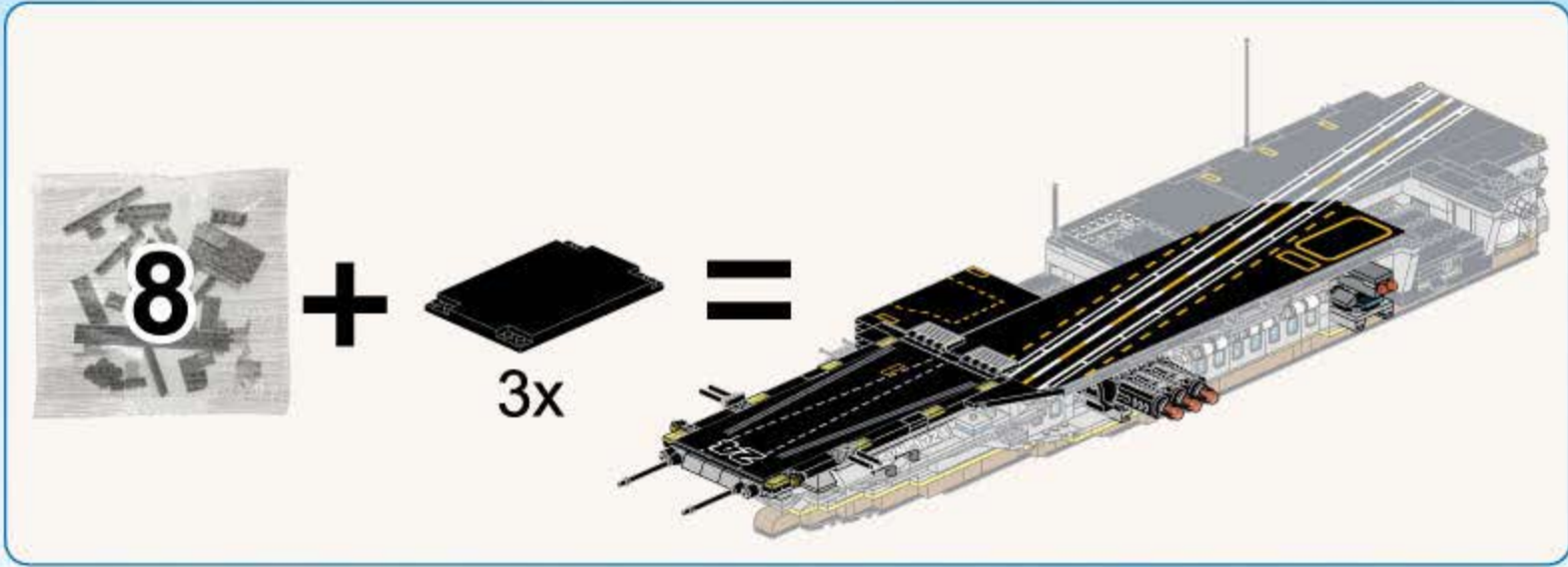

62

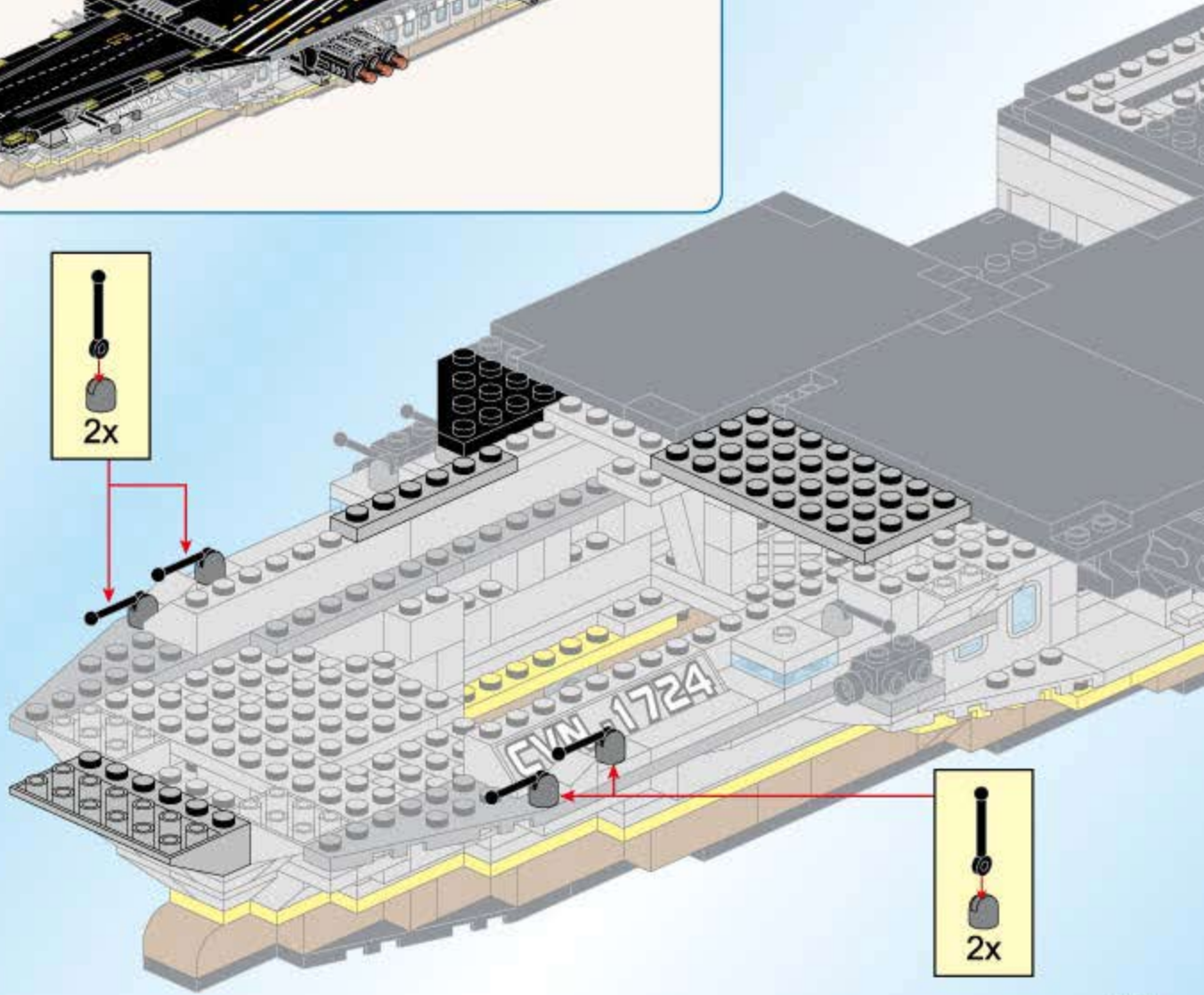
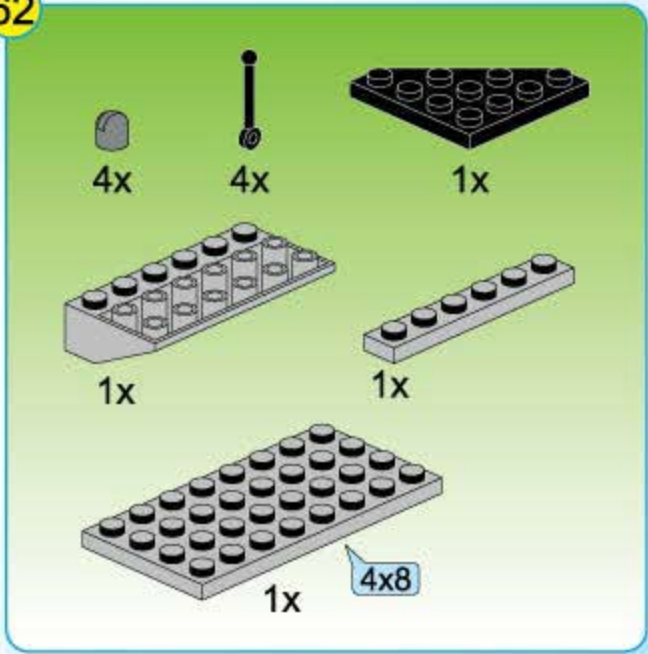

63



2x

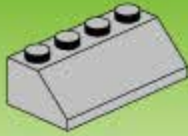

2x



2x

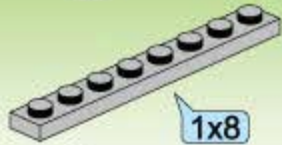

1x8

1x

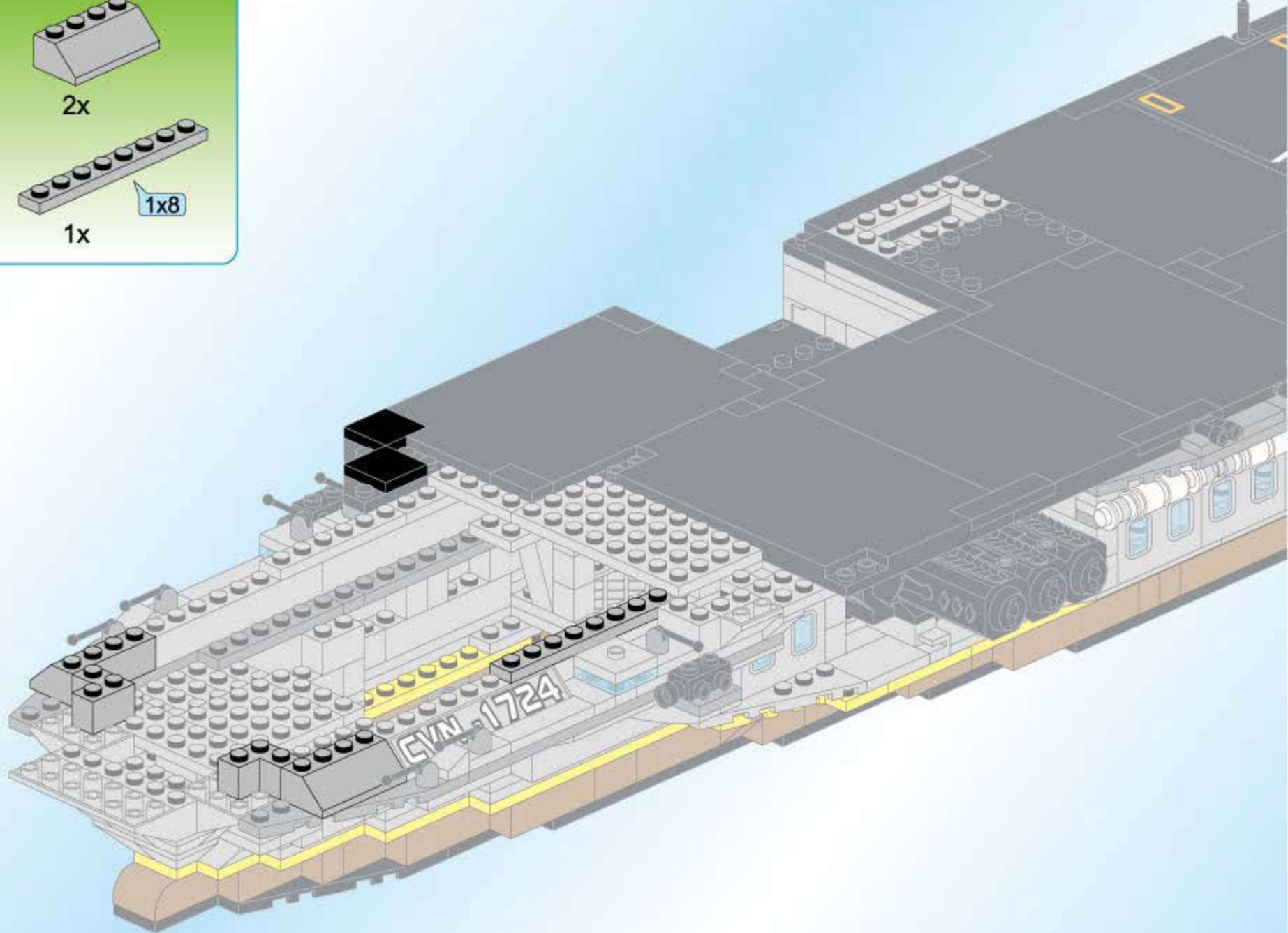

64

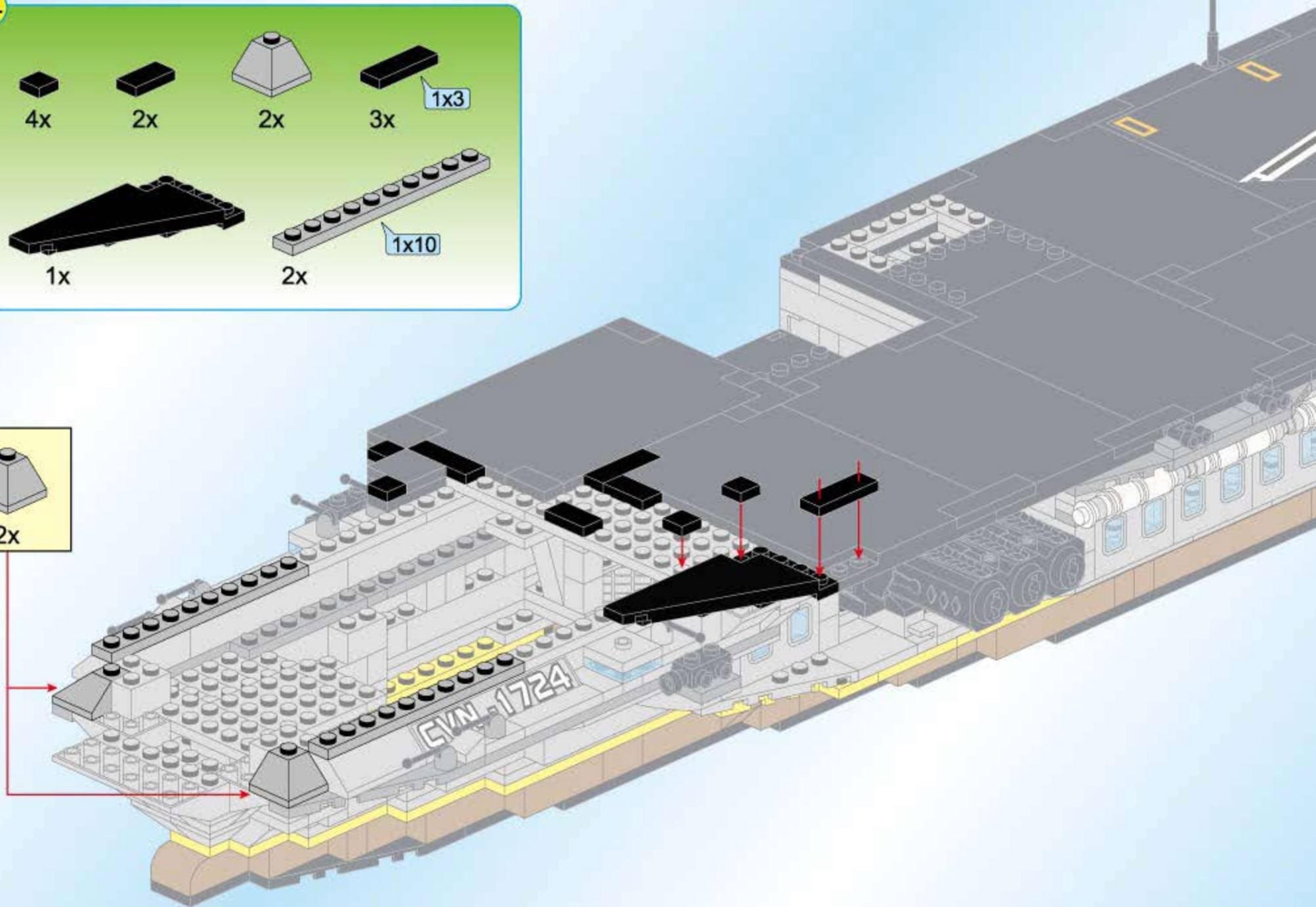
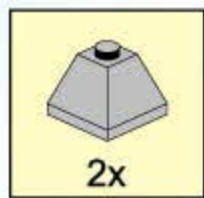
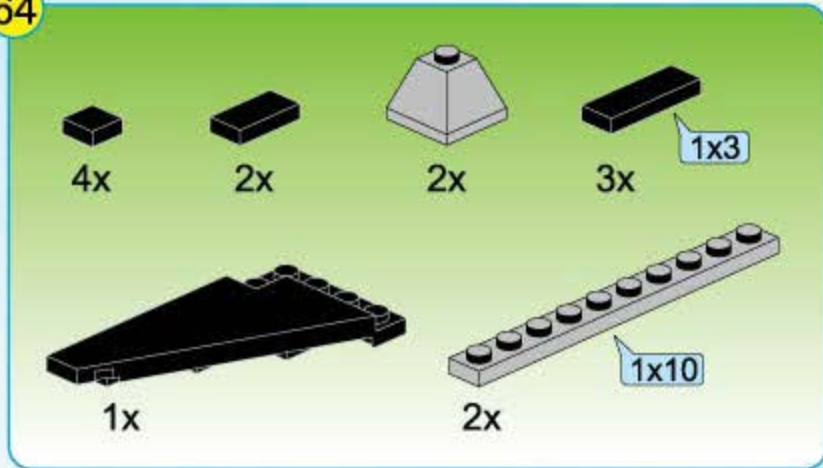

65

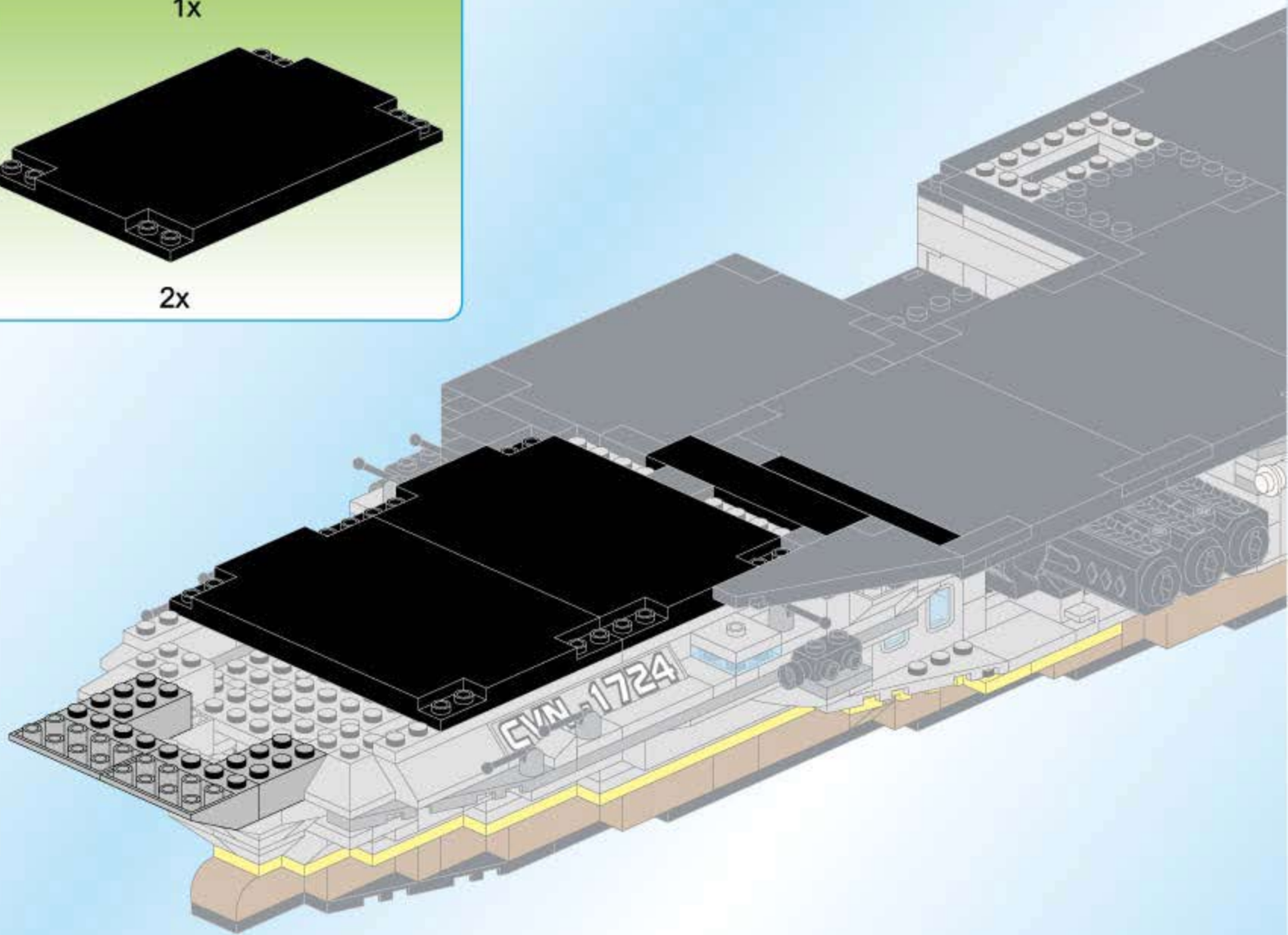
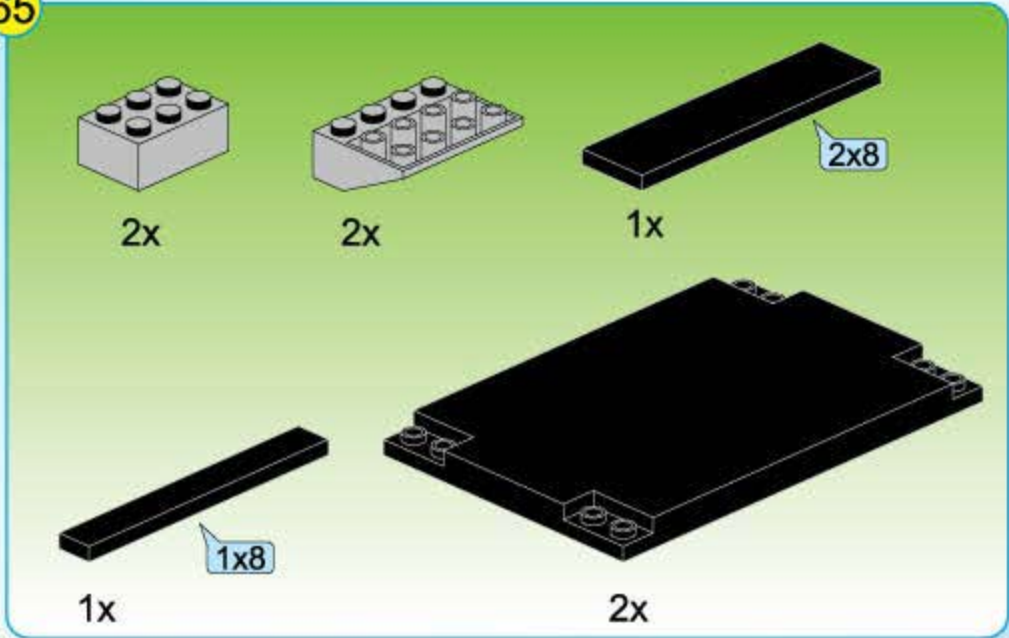

66



6x



2x



2x



1x



2x

2x8

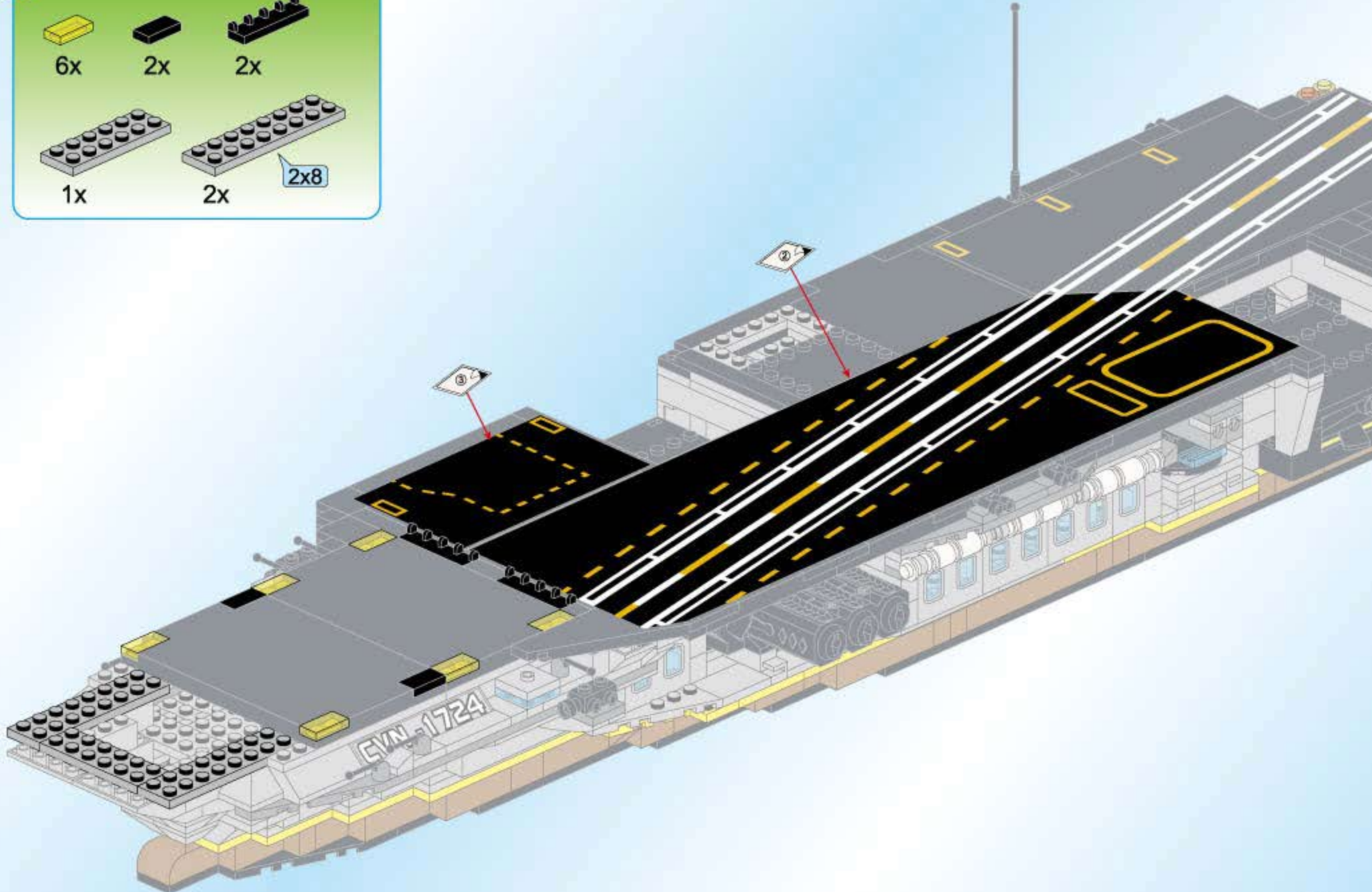

67

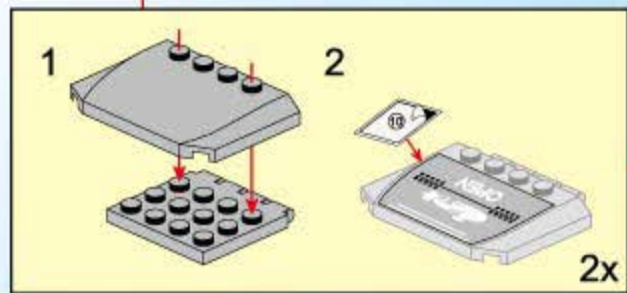
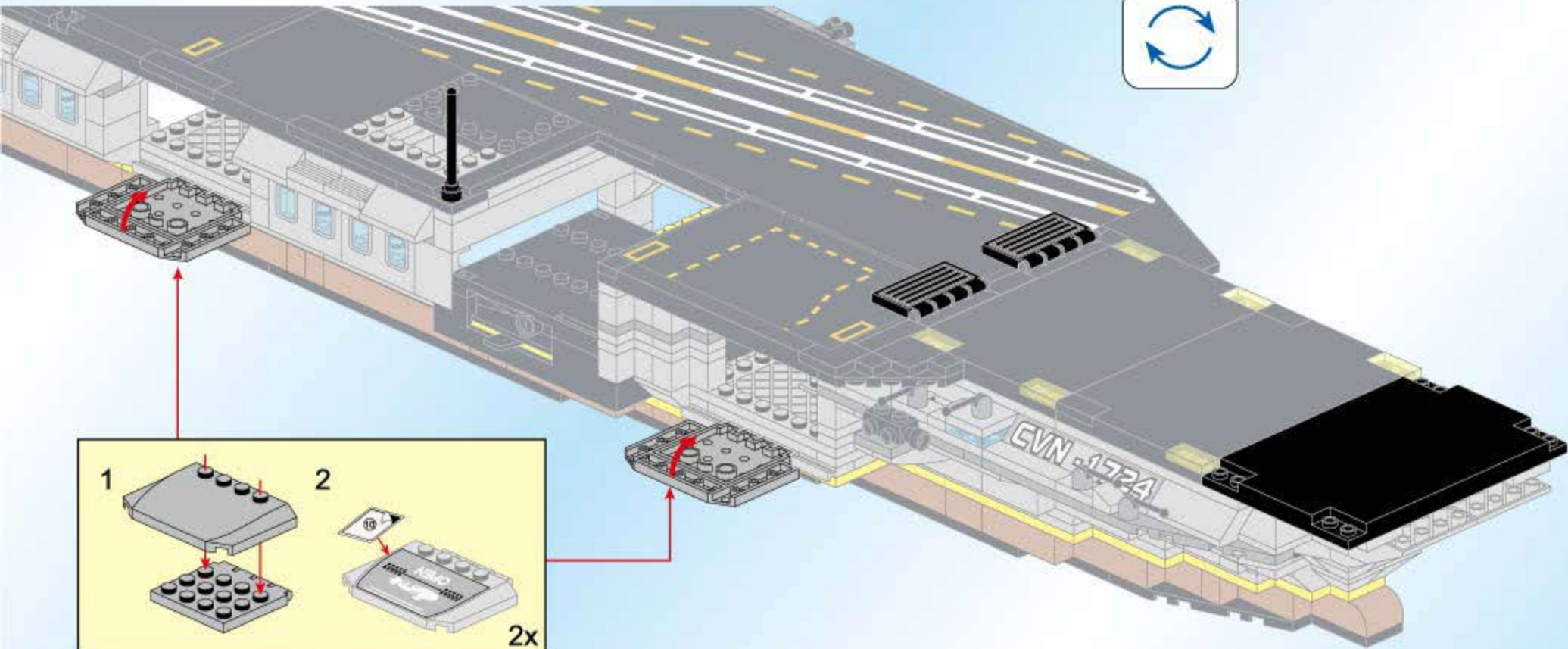
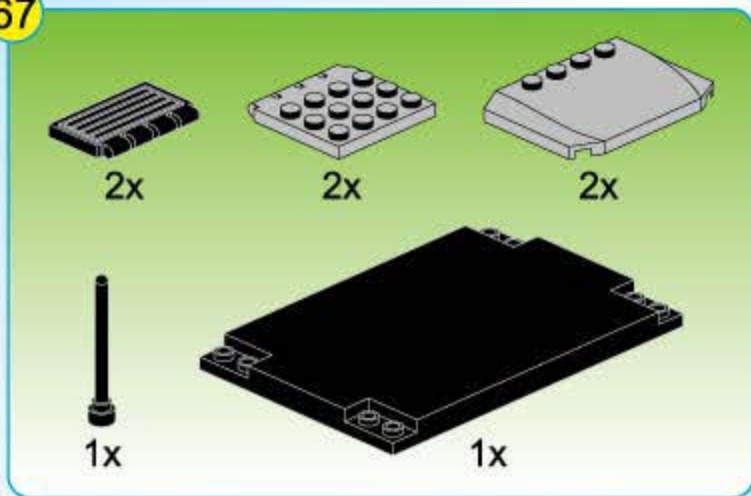

61

68

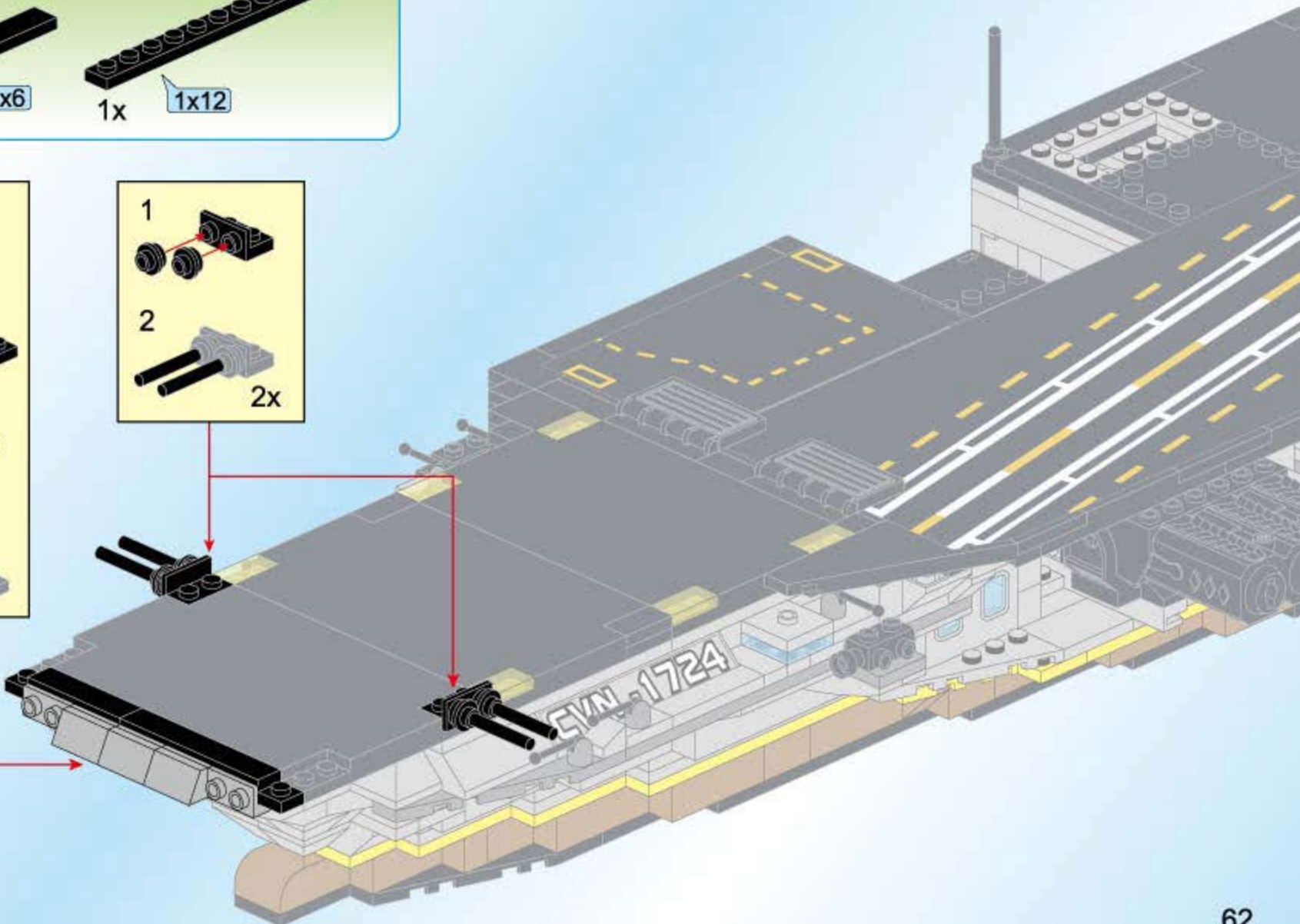
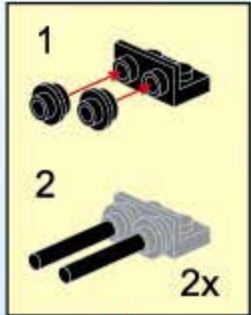
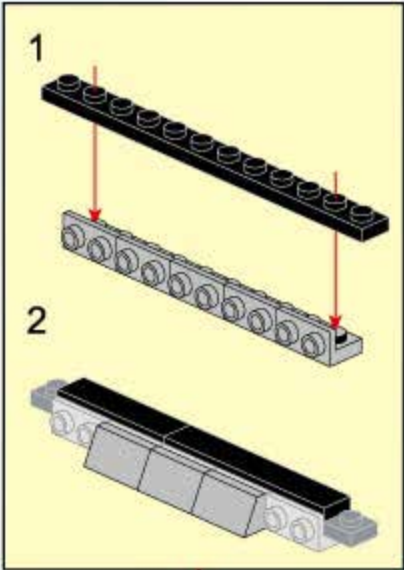
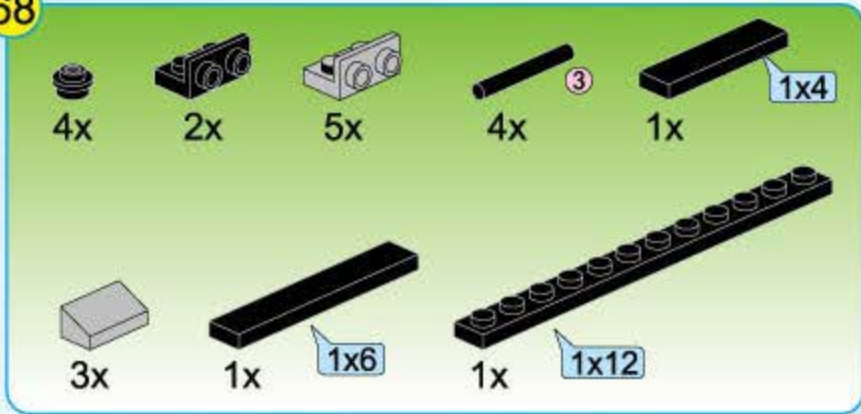

- 2x [Black axle pin]
- 2x [Black axle pin]
- 2x [Black axle pin]
- 4x [Blue gear]
- 4x [Black gear]
- 2x [Black axle pin]
- 2x [Yellow axle pin]
- 2x [Black axle pin]
- 2x [Yellow axle pin]
- 2x [Orange axle pin]
- 3x [Grey axle pin]

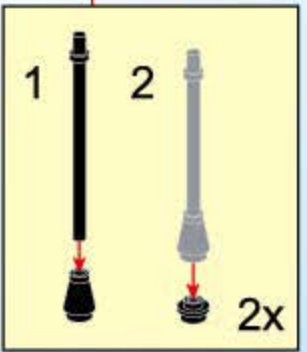
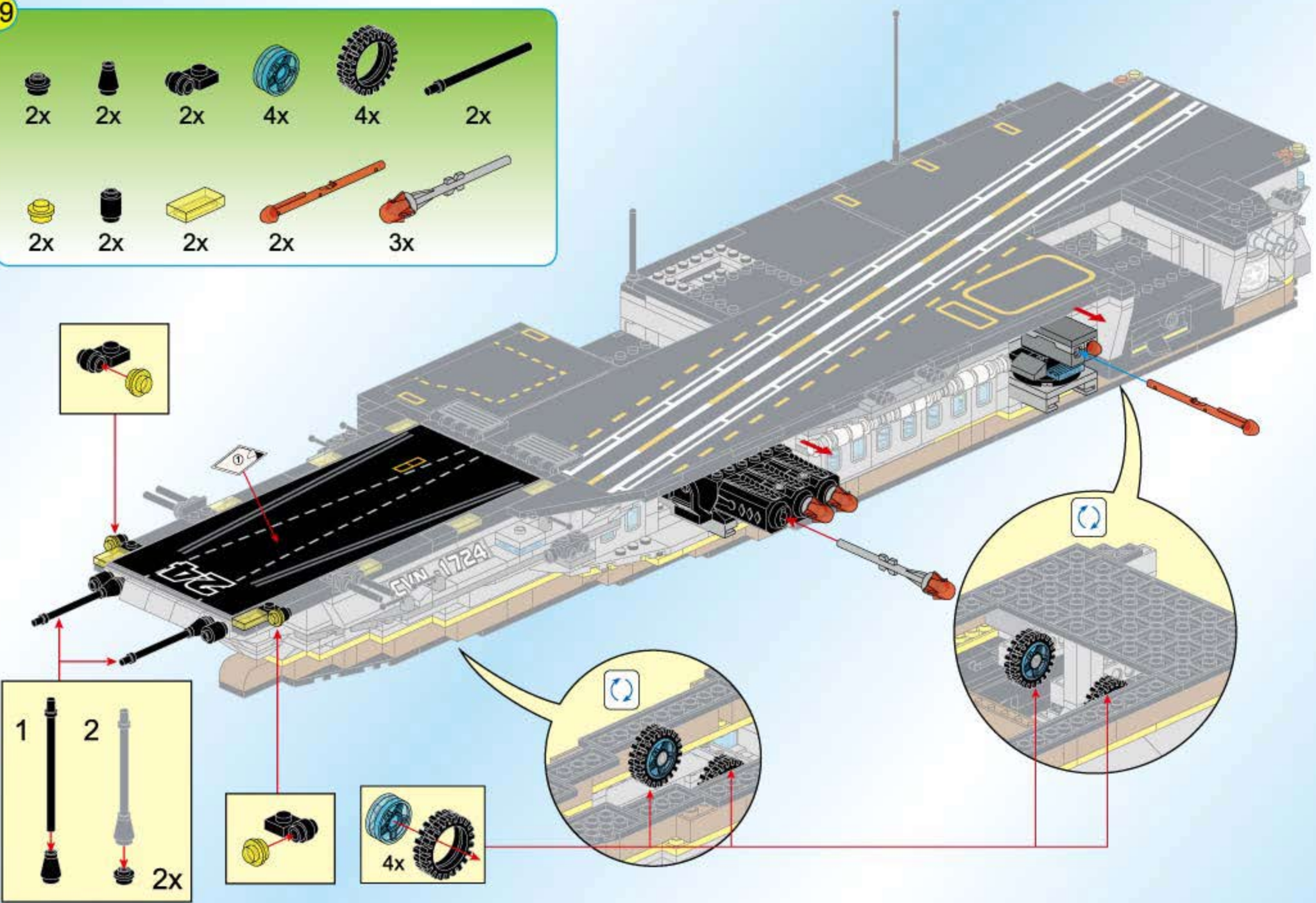

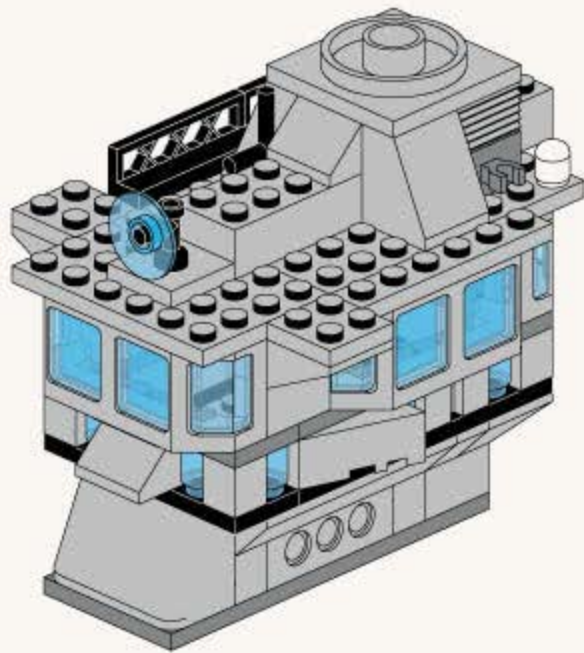

70

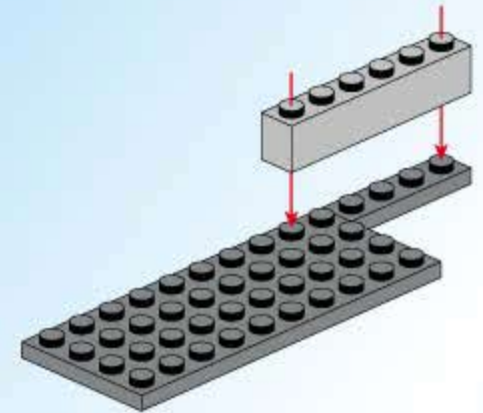
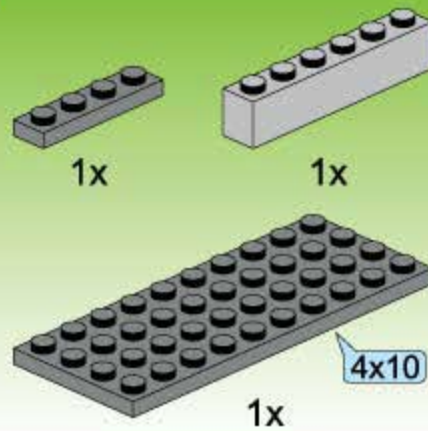

71

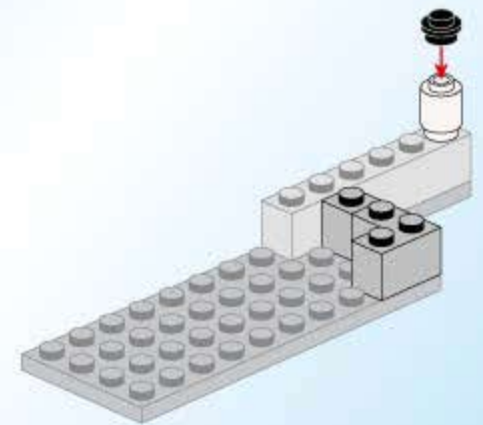
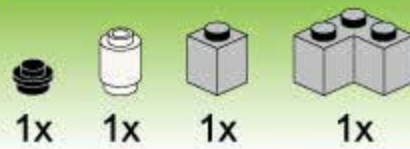

72



2x

2x

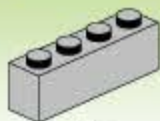

2x

73



2x



1x



1x

74



2x



1x

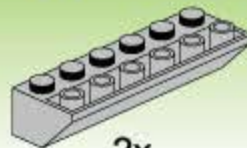

2x

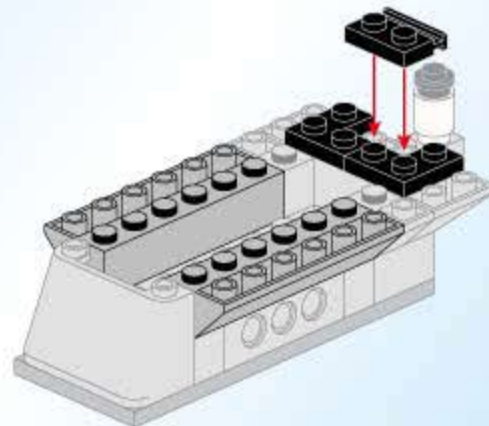
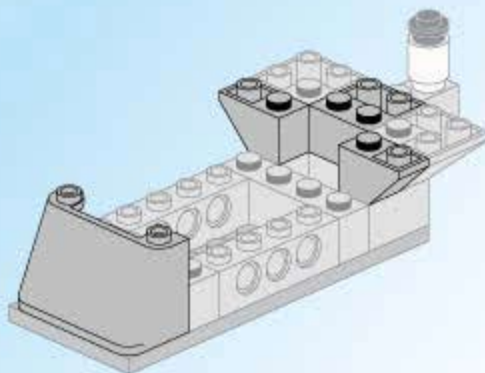
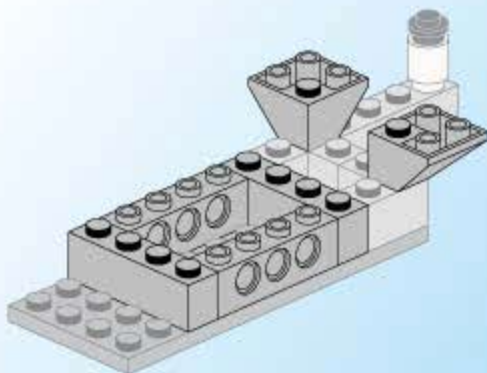

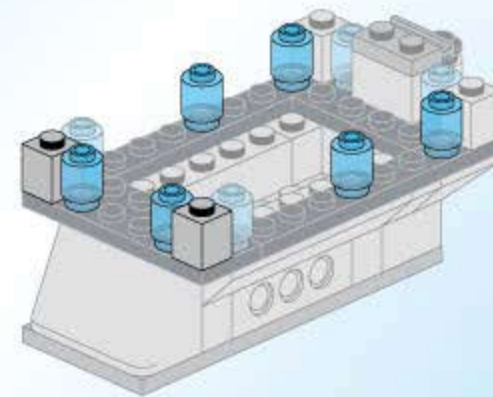
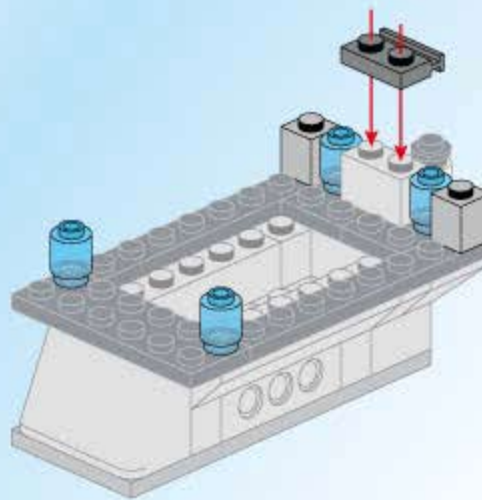
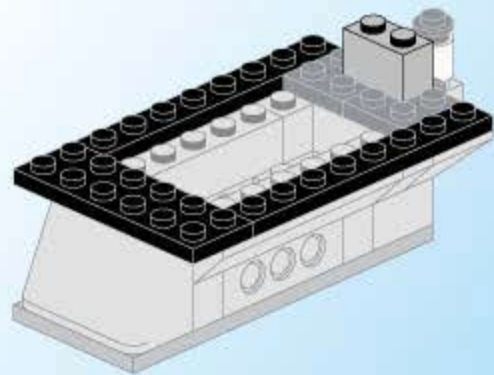
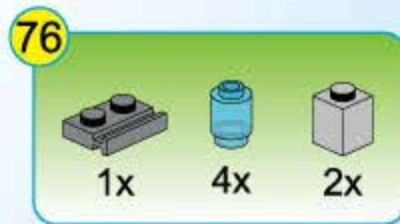
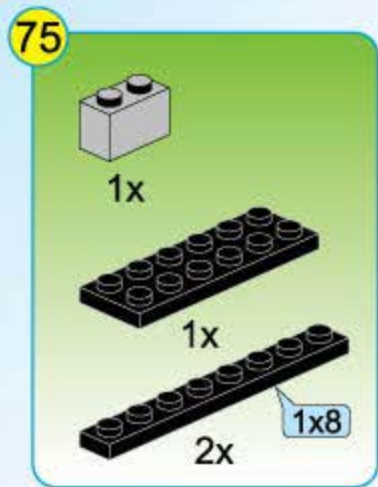

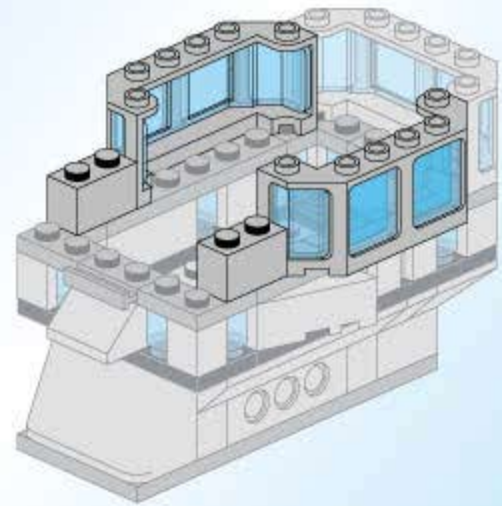
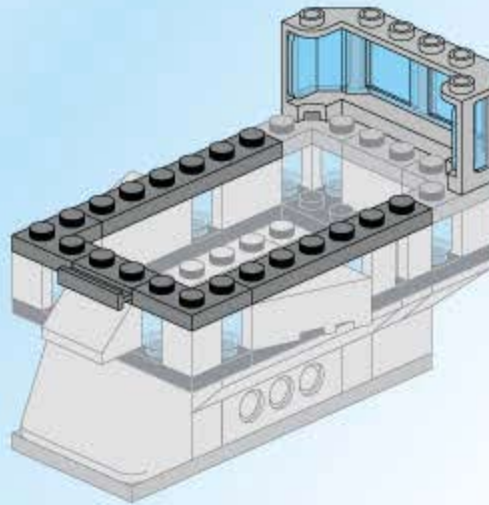
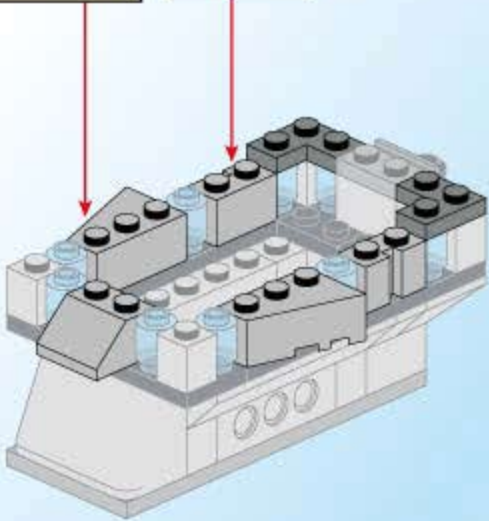
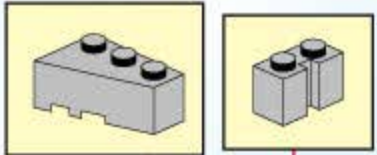
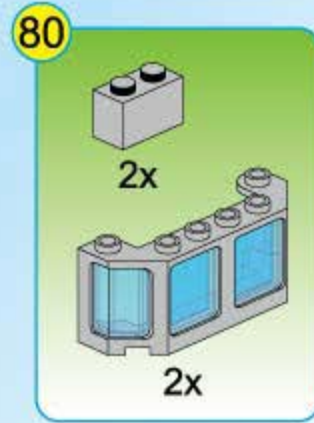
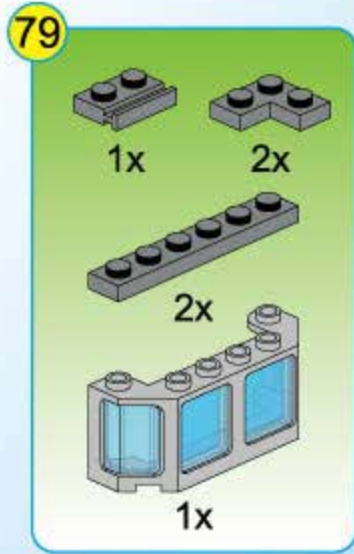
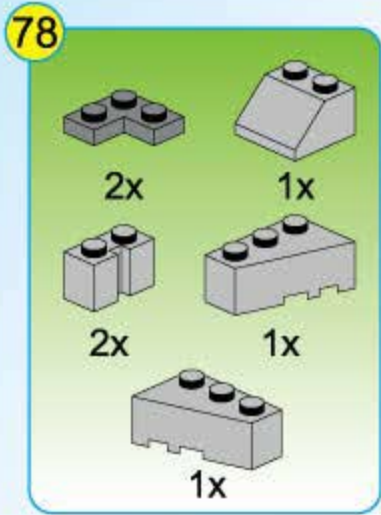

81

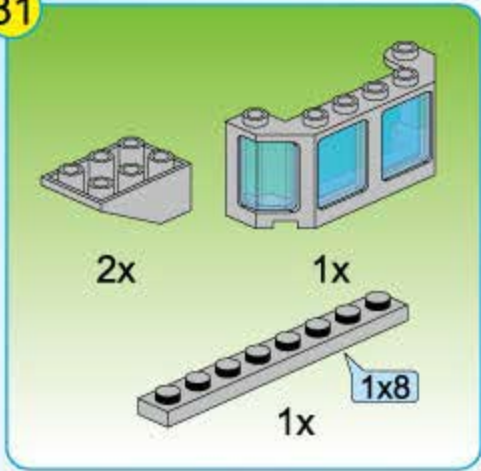

82

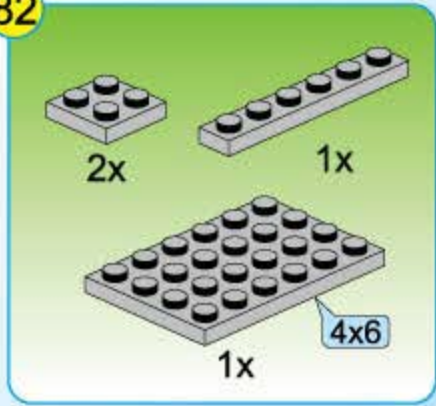

83

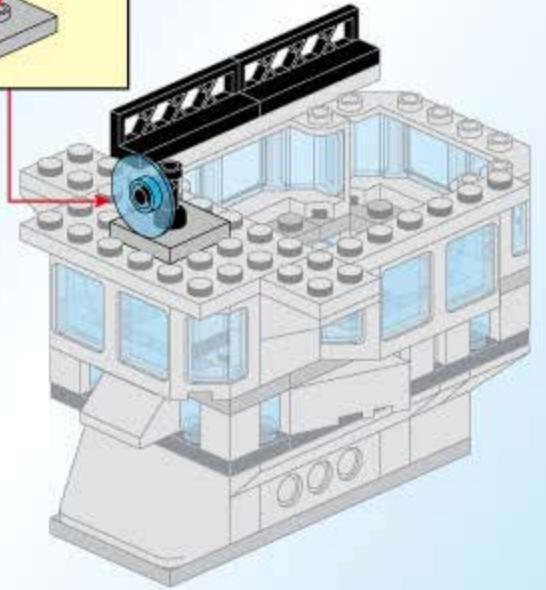
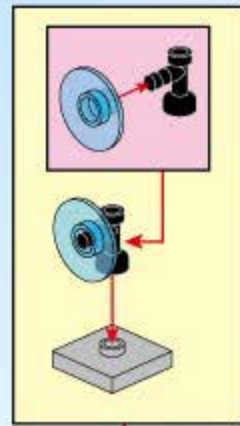
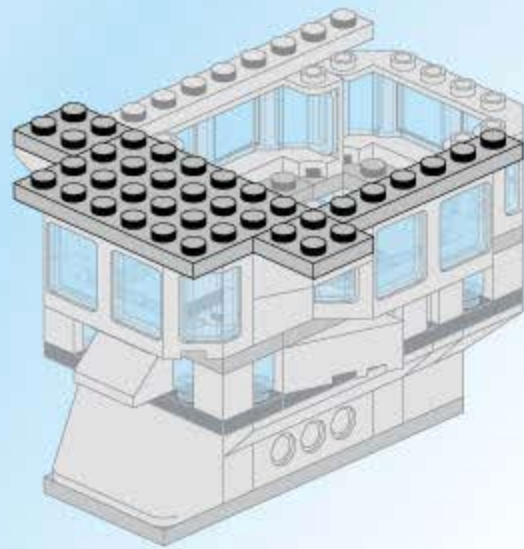
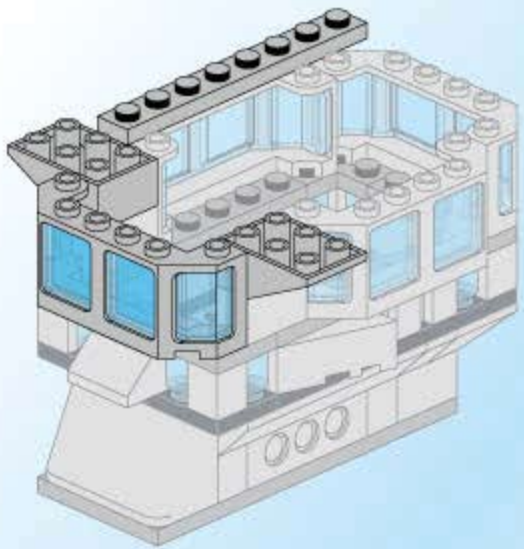

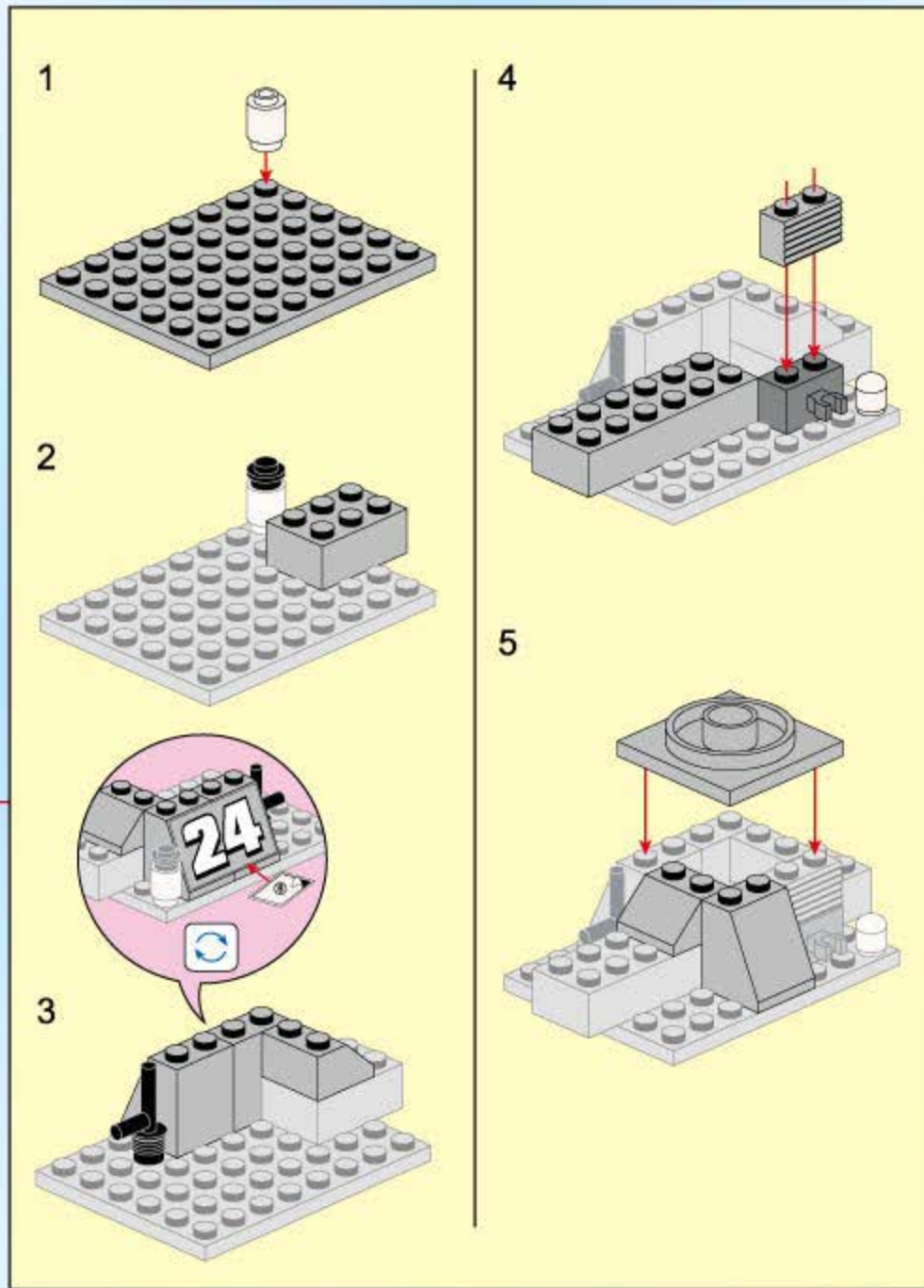
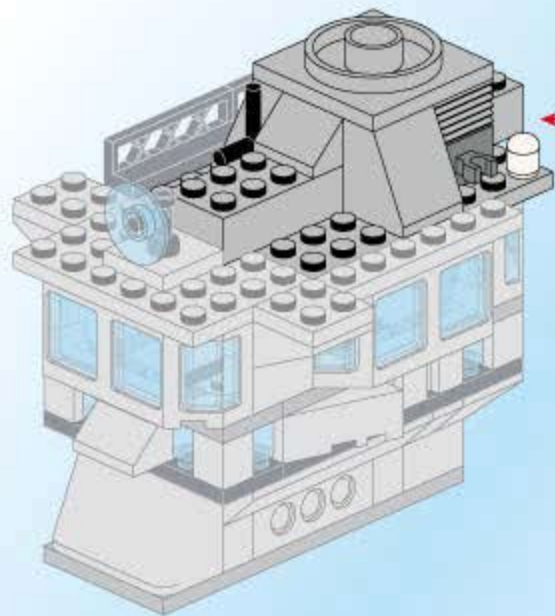
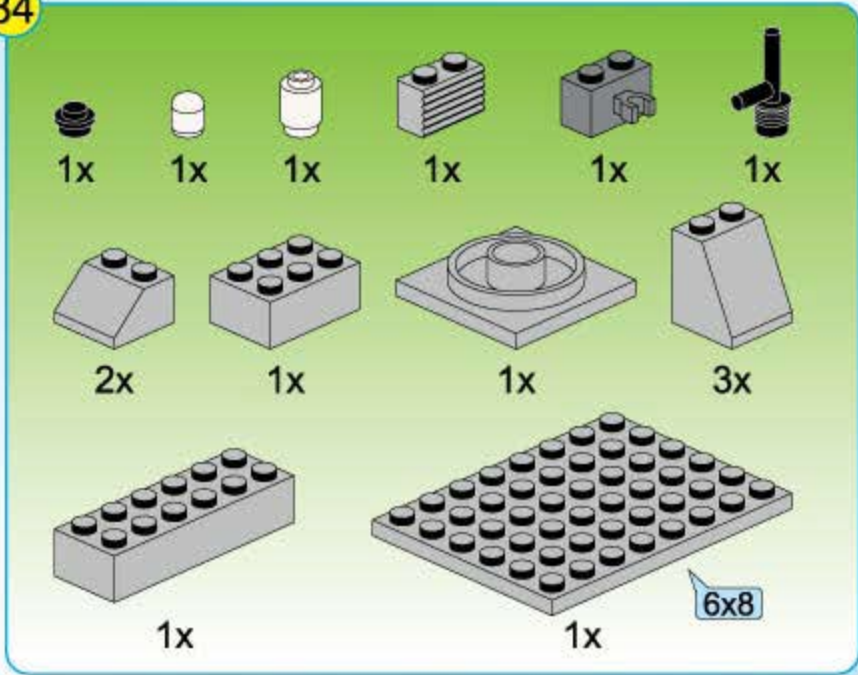

10

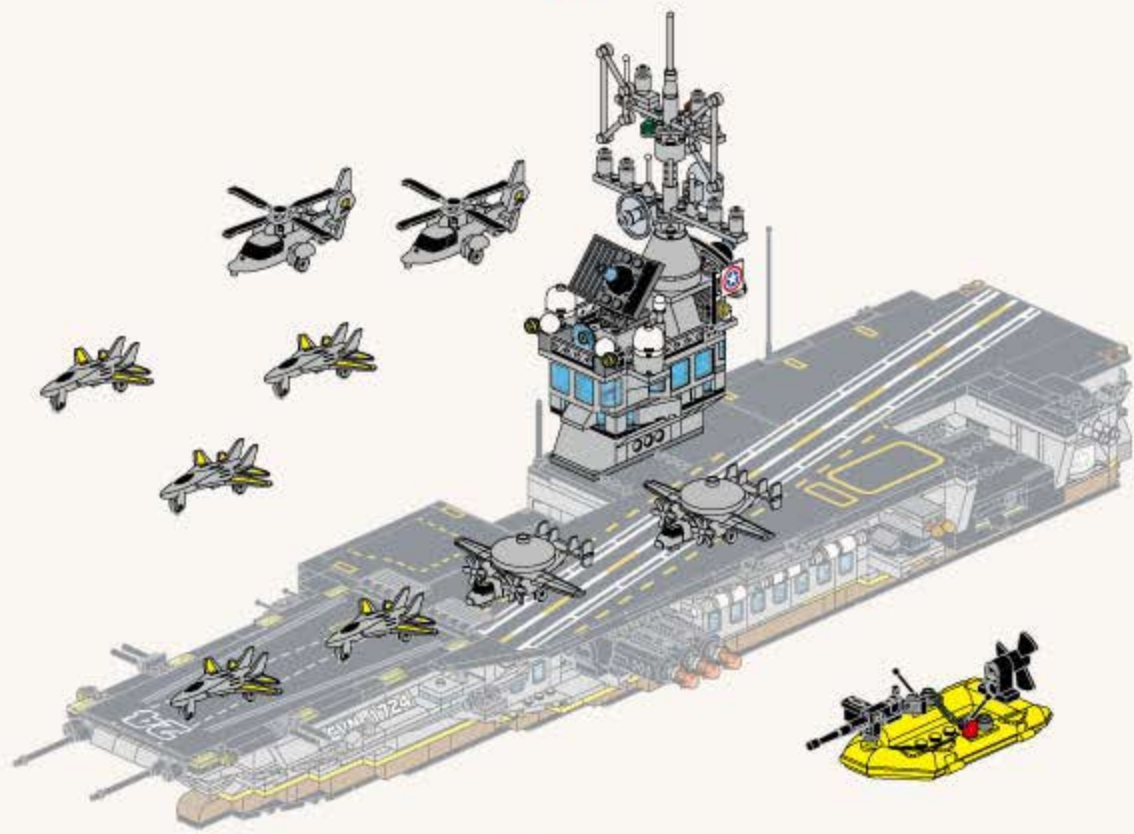

85



1x



1x



1x



1x



1x

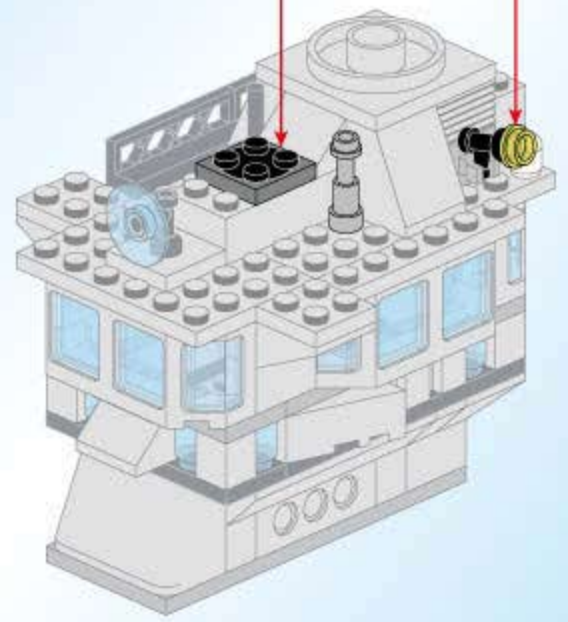
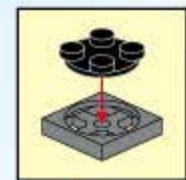

86

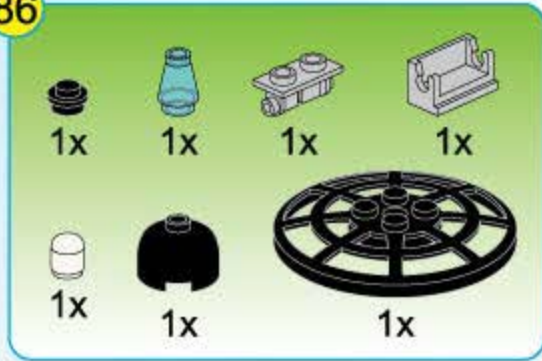

87

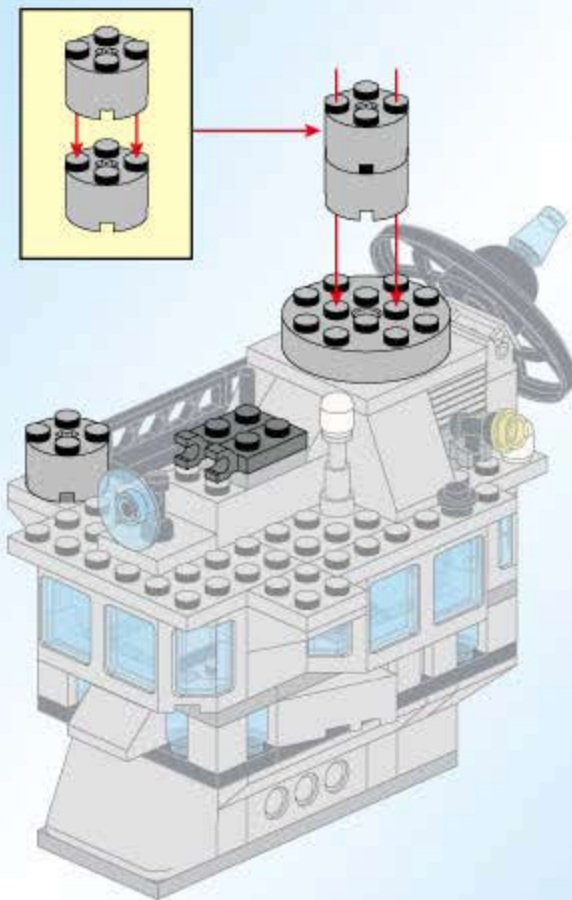
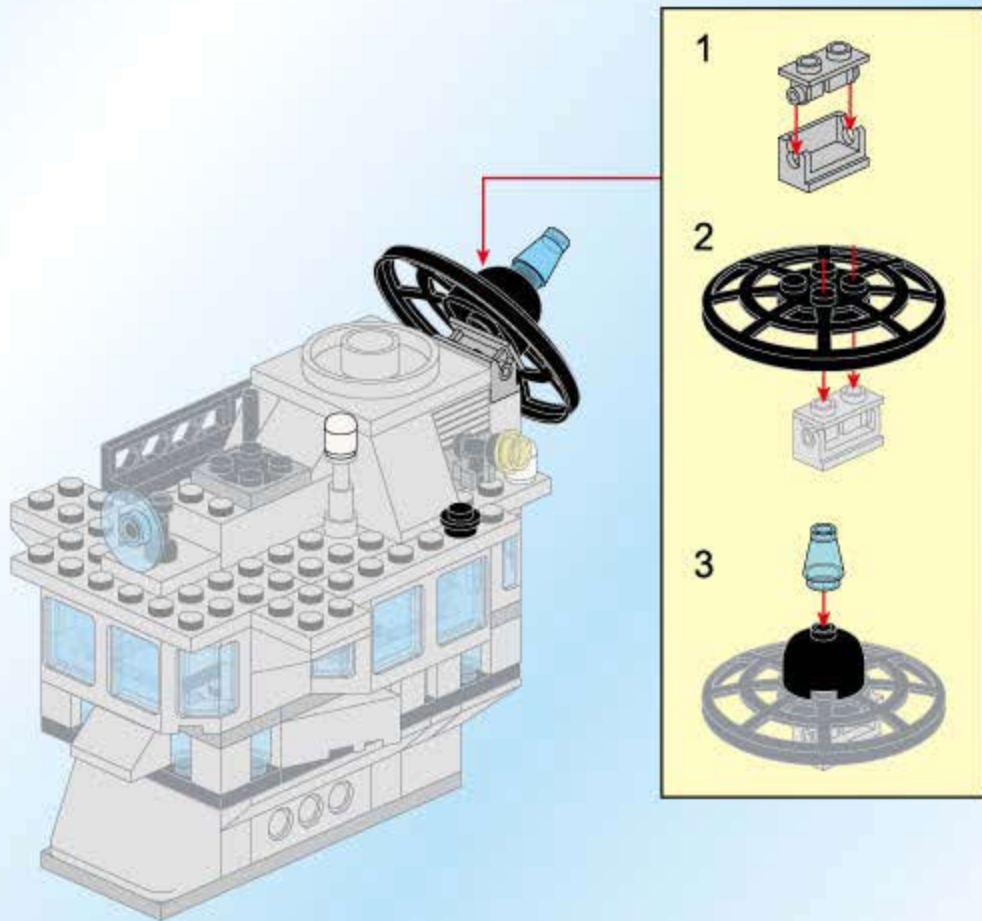
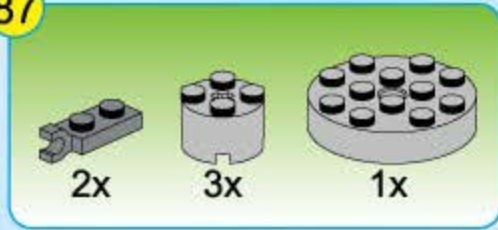

88



89

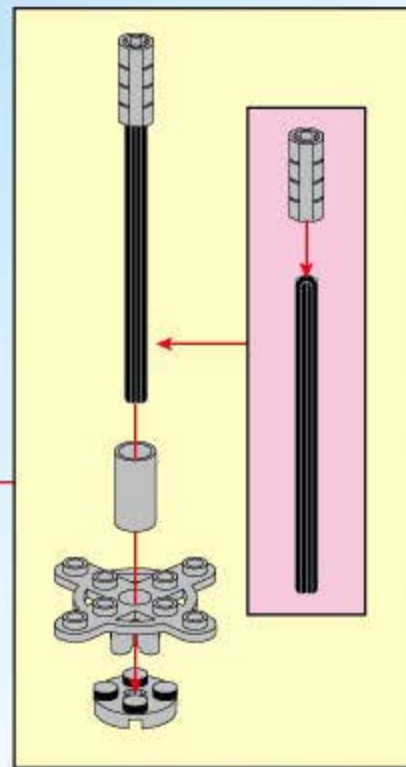
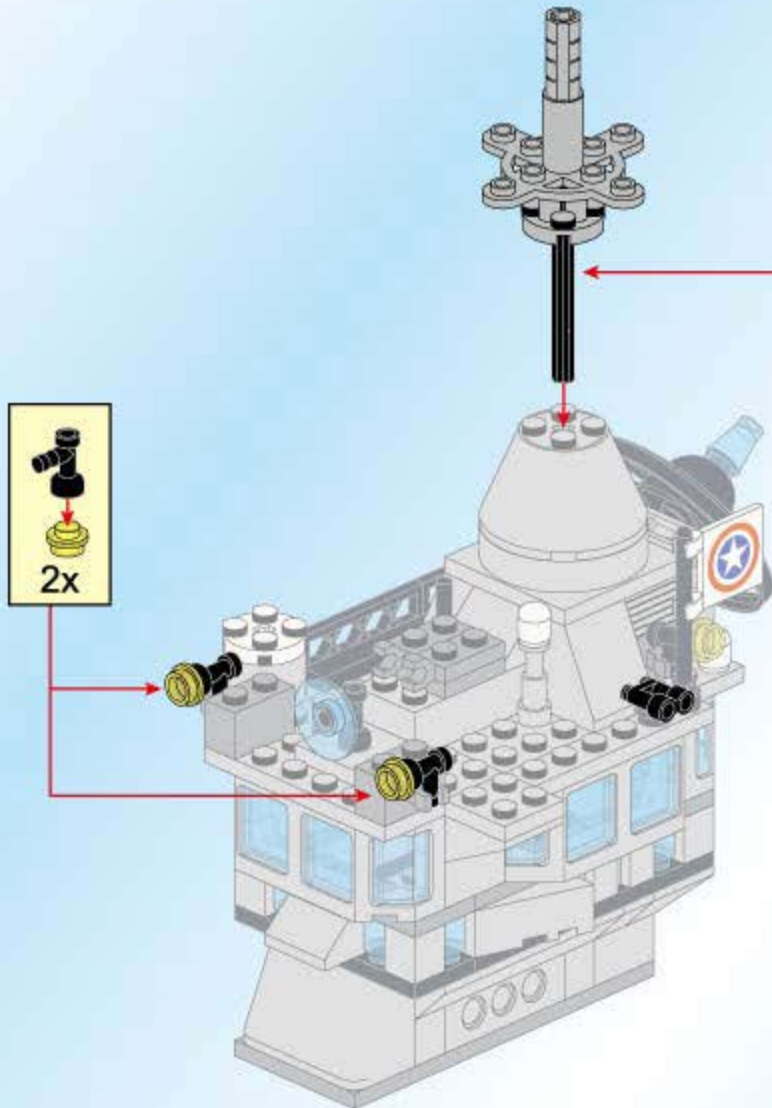
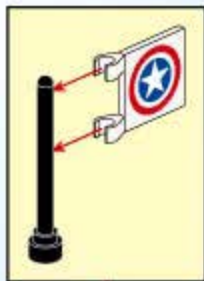
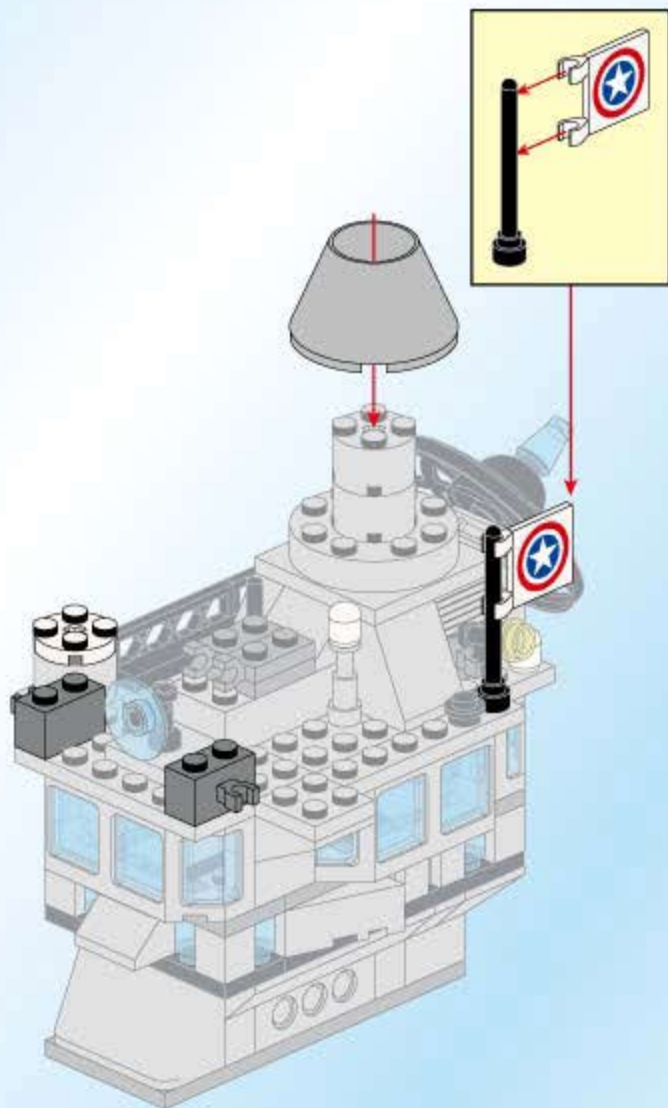

90



1x



2x

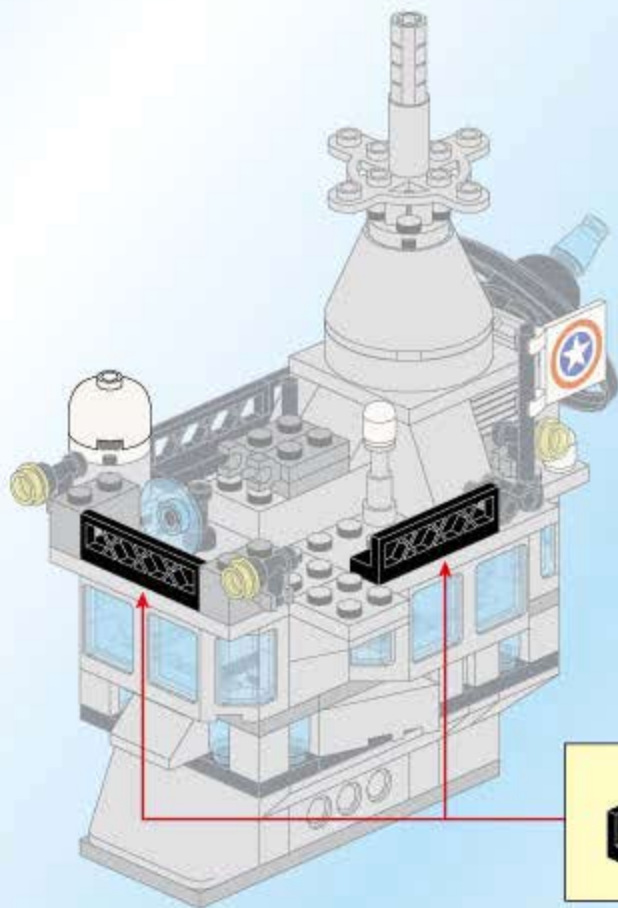

2x

91



2x



1x



1x



1x



1x



1x



1x



2x

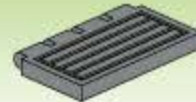

2x



1x

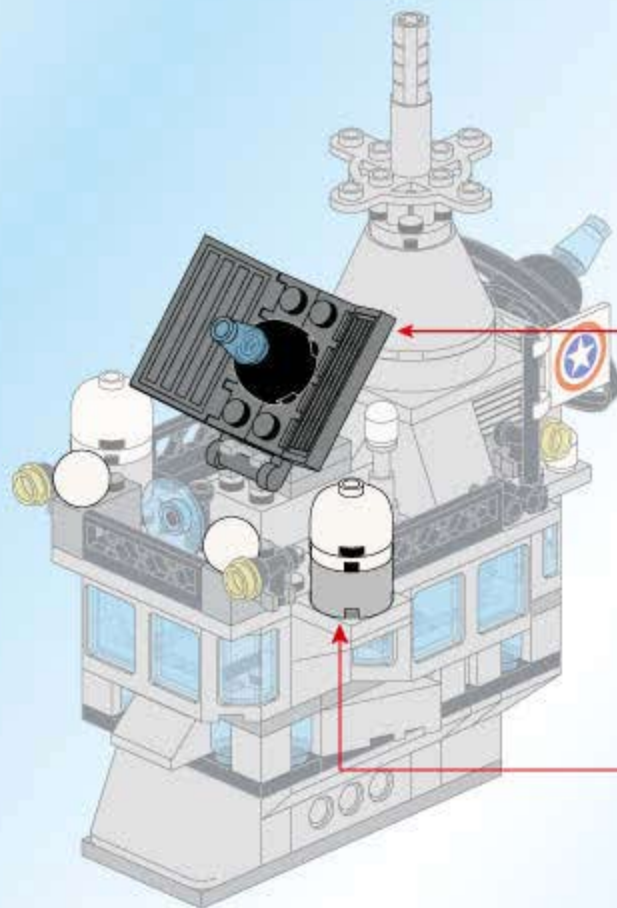

1

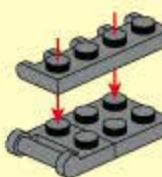

2

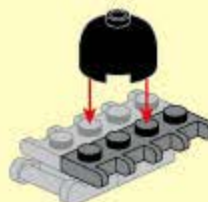

3

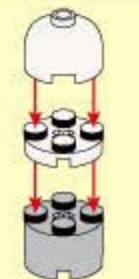
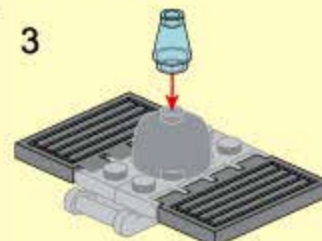

92

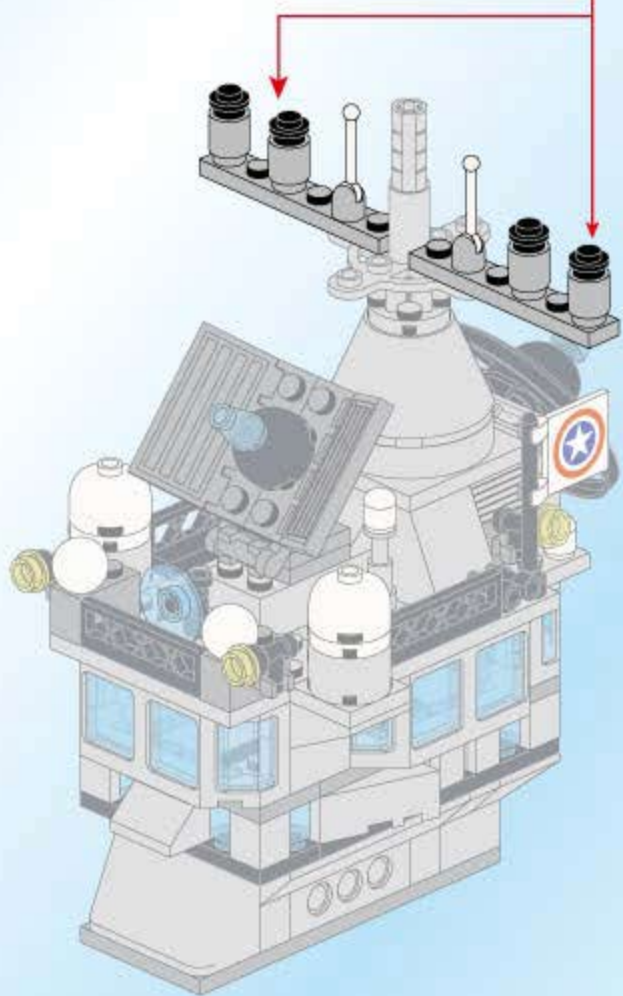
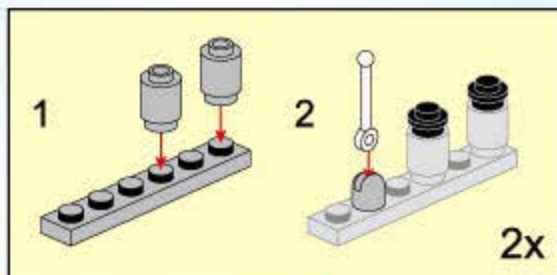
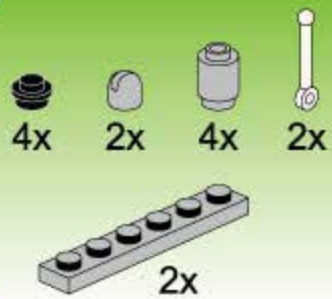

93

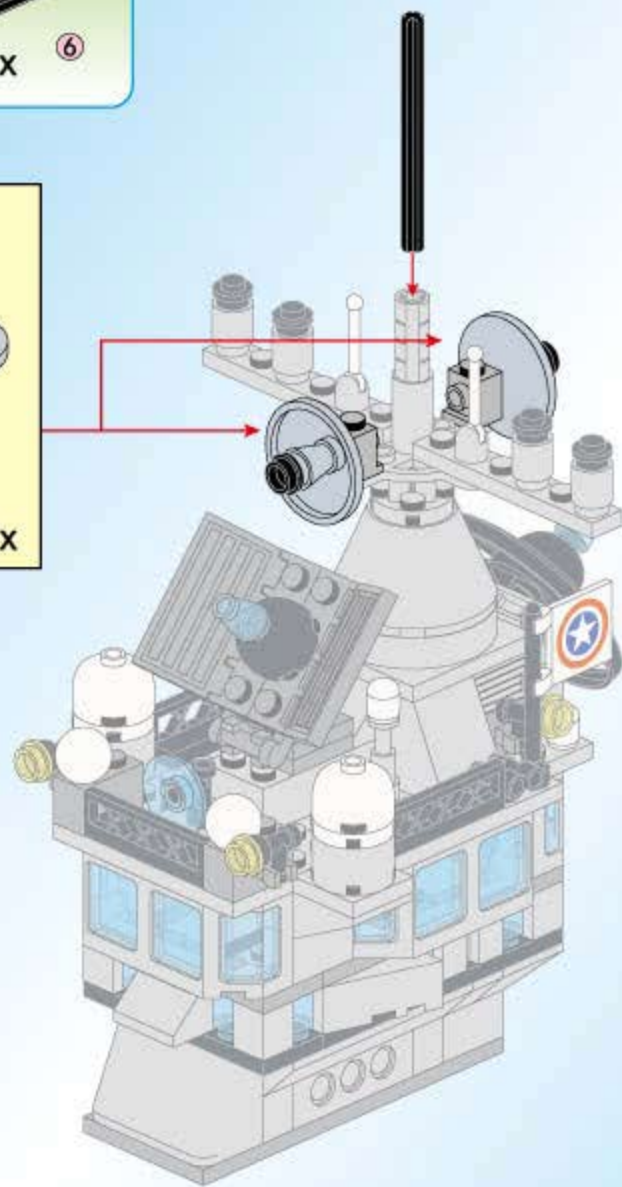
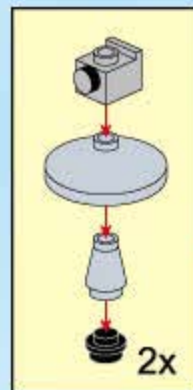

94



1x



1x

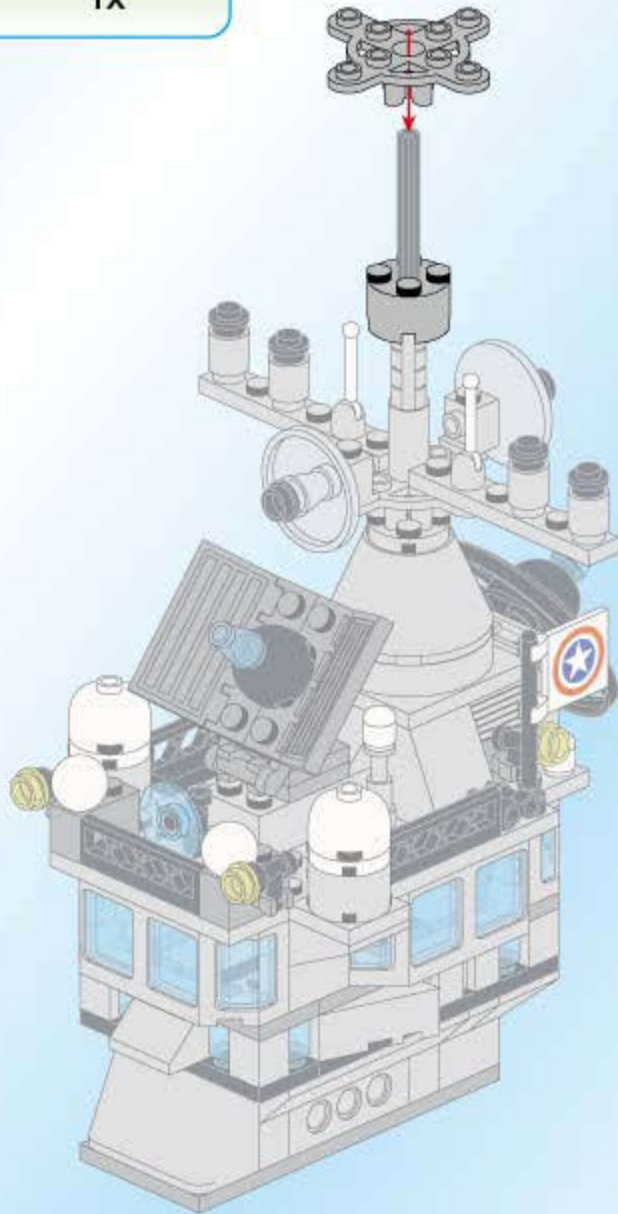

95



1x



1x



1x



1x

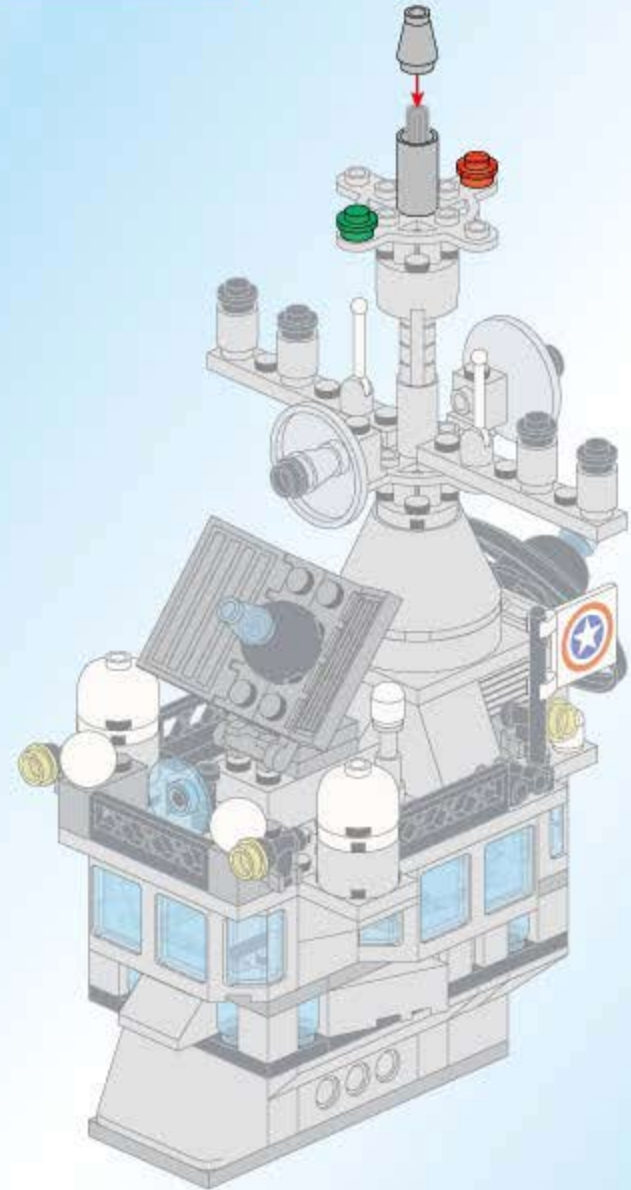

96

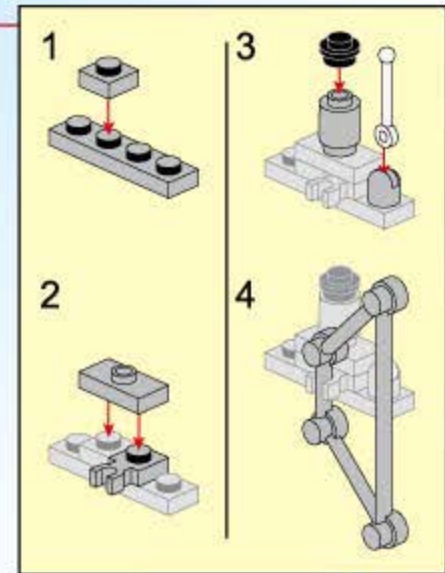
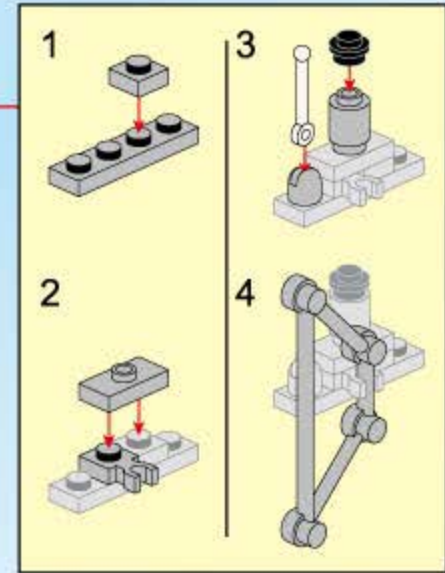
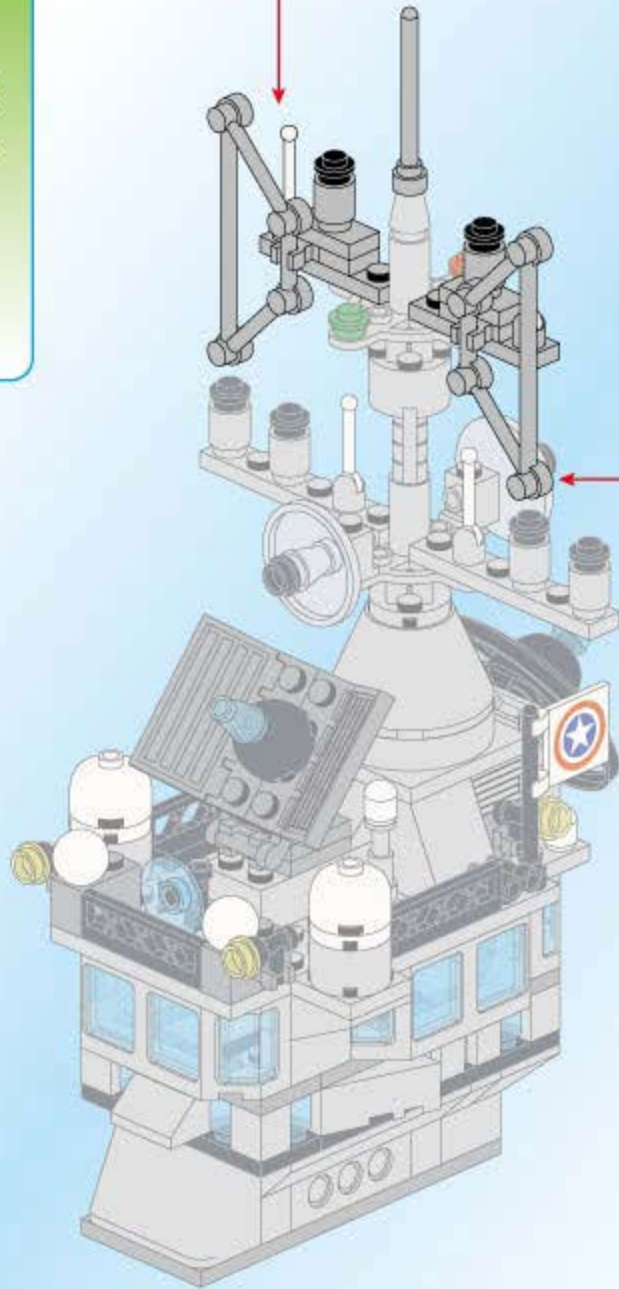
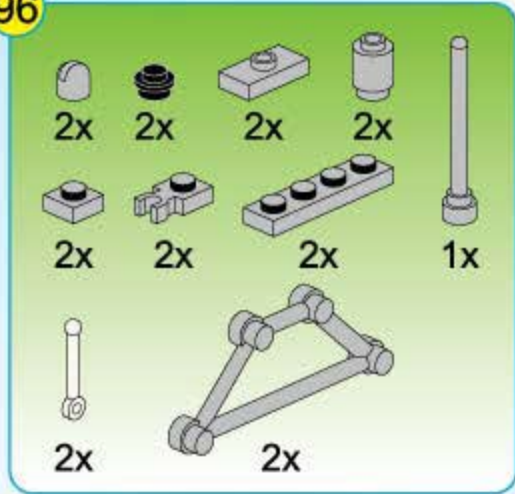

97

96

69

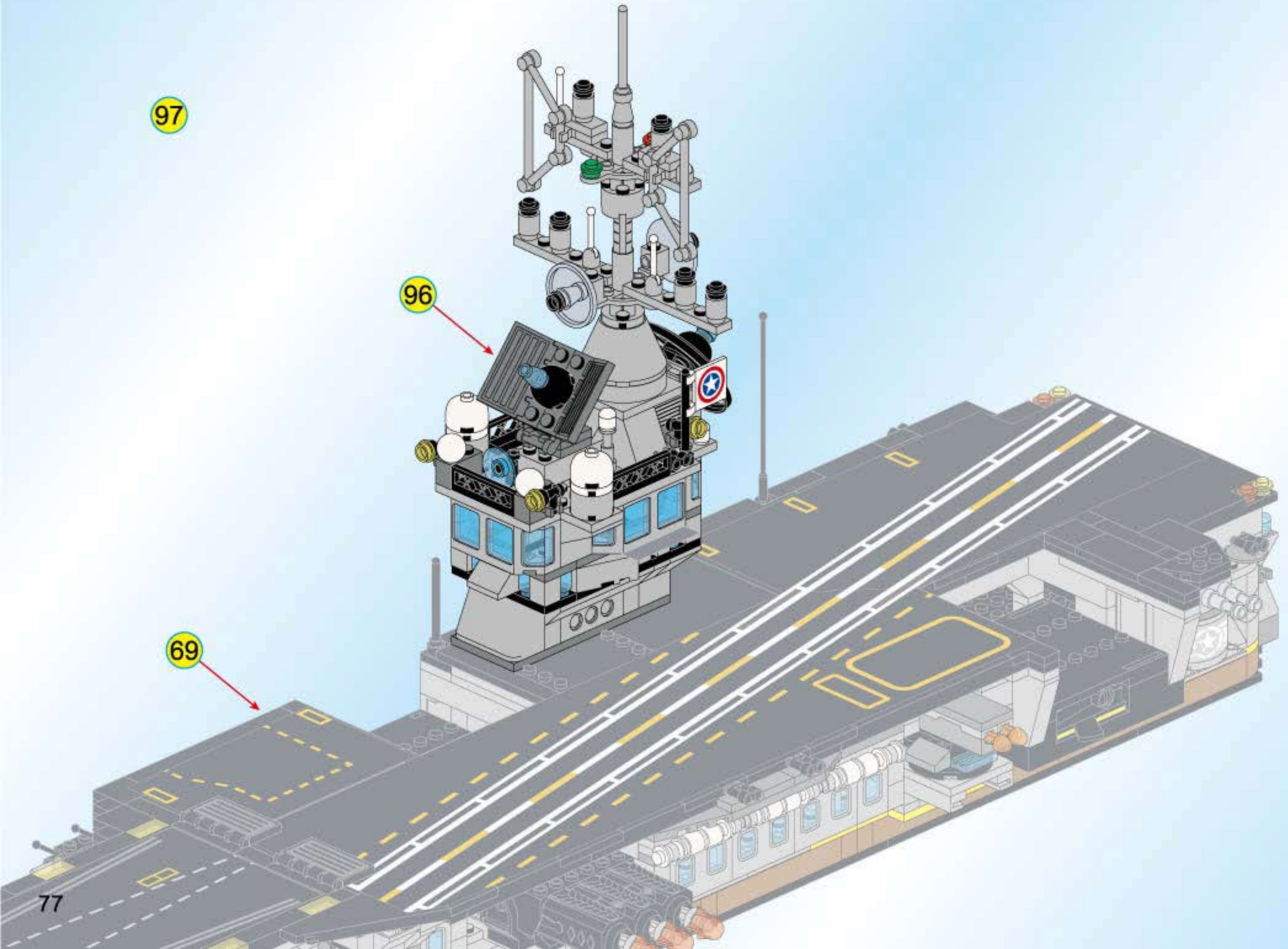

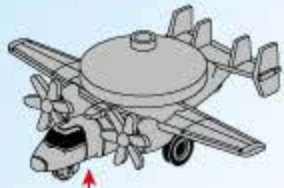

1

2

3

2x

1

2

2x

5x

1

2

3

4

2



TACTICAL ESPIONAGE ACTION COMBAT ZONE FIRE



1715 OPERATION NIGHTINGALE



1716 BATTLE ON THE SHOAL



1717 STEALTH UNDERWATER



1718 EMERGENCY MISSILE TRANSFER



1719 APACHE RAID



1720 COASTLINE CONFLICT



1723 SERPENT THE ESCORT CARRIER



1721 OVERLORD IS ON ITS WAY



1722 GO FOR IT! DESTROYER



1724 ENTERPRISE THE AIRCRAFT CARRIER