



3807

Ages: 6+

Minifigs: X5

Pcs: 1073

MONKEY KING

STORY OF WUKONG



Fight the Red Boy

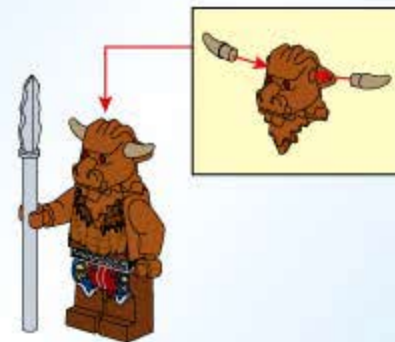
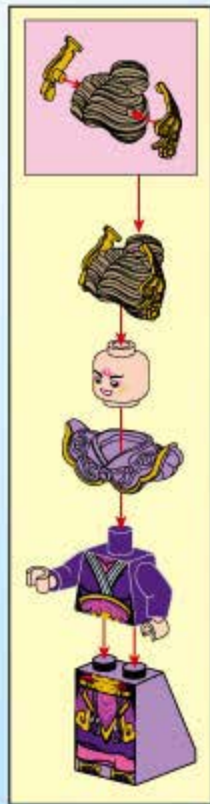
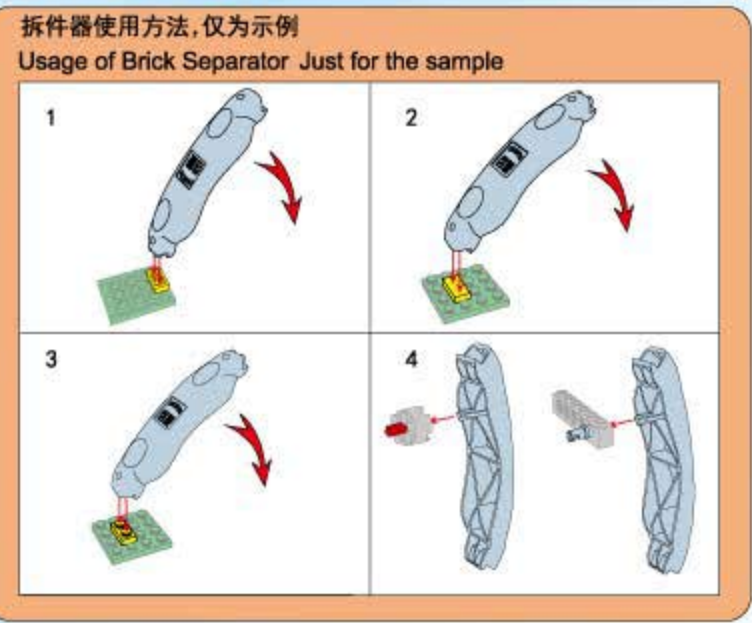
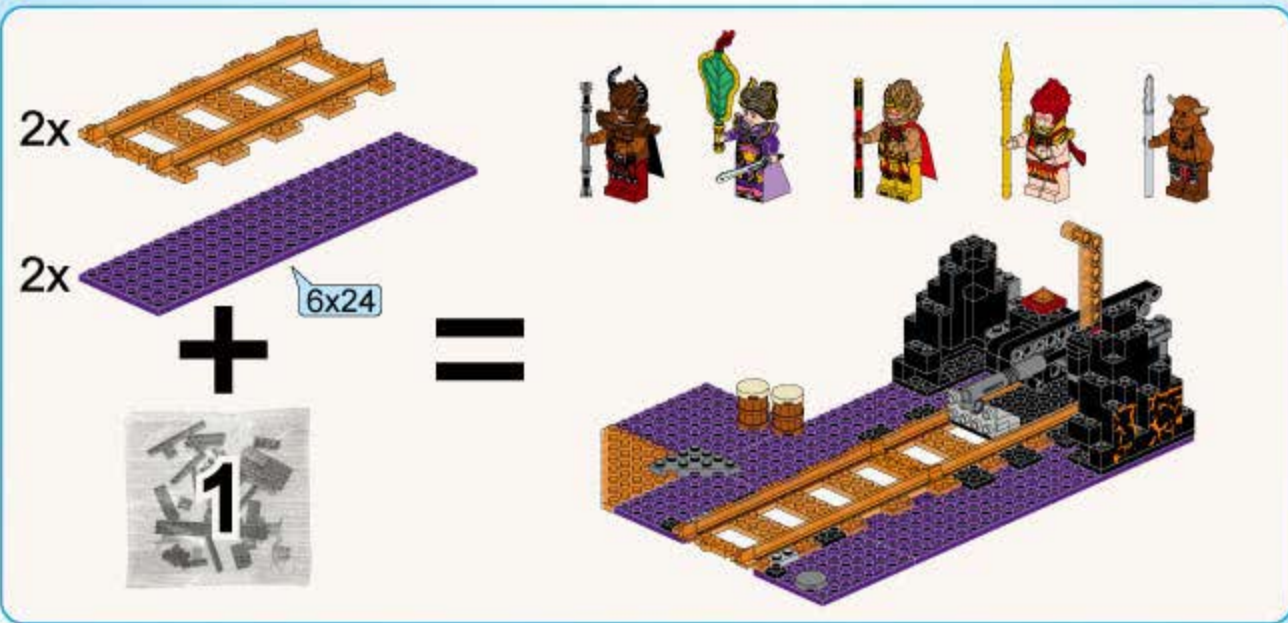

1

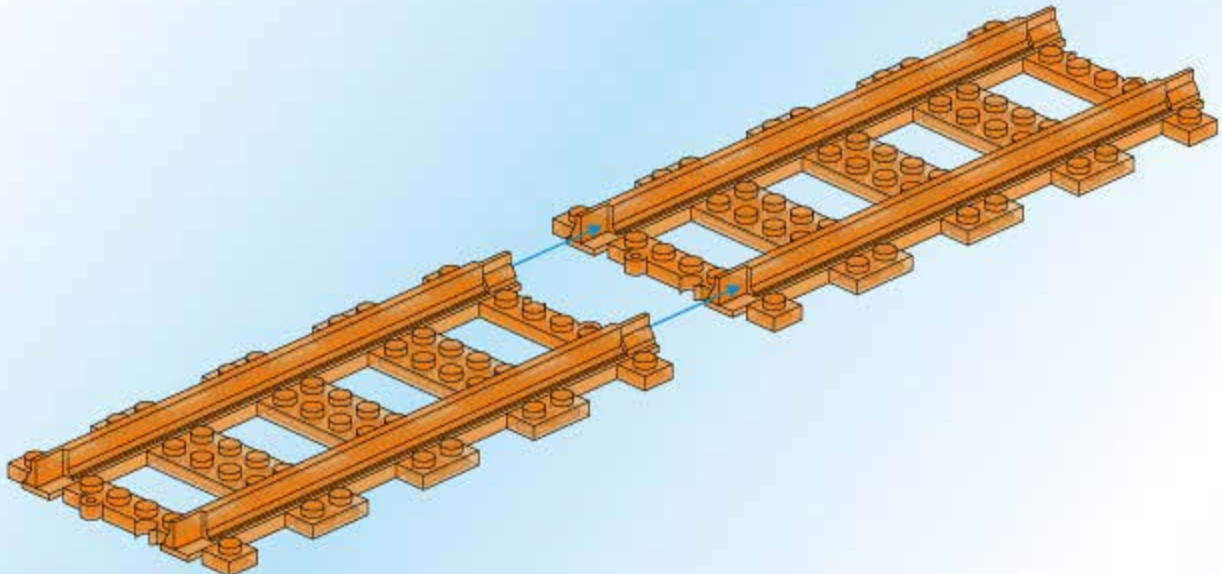
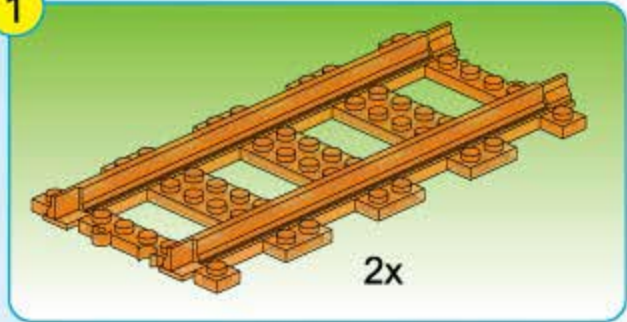

2

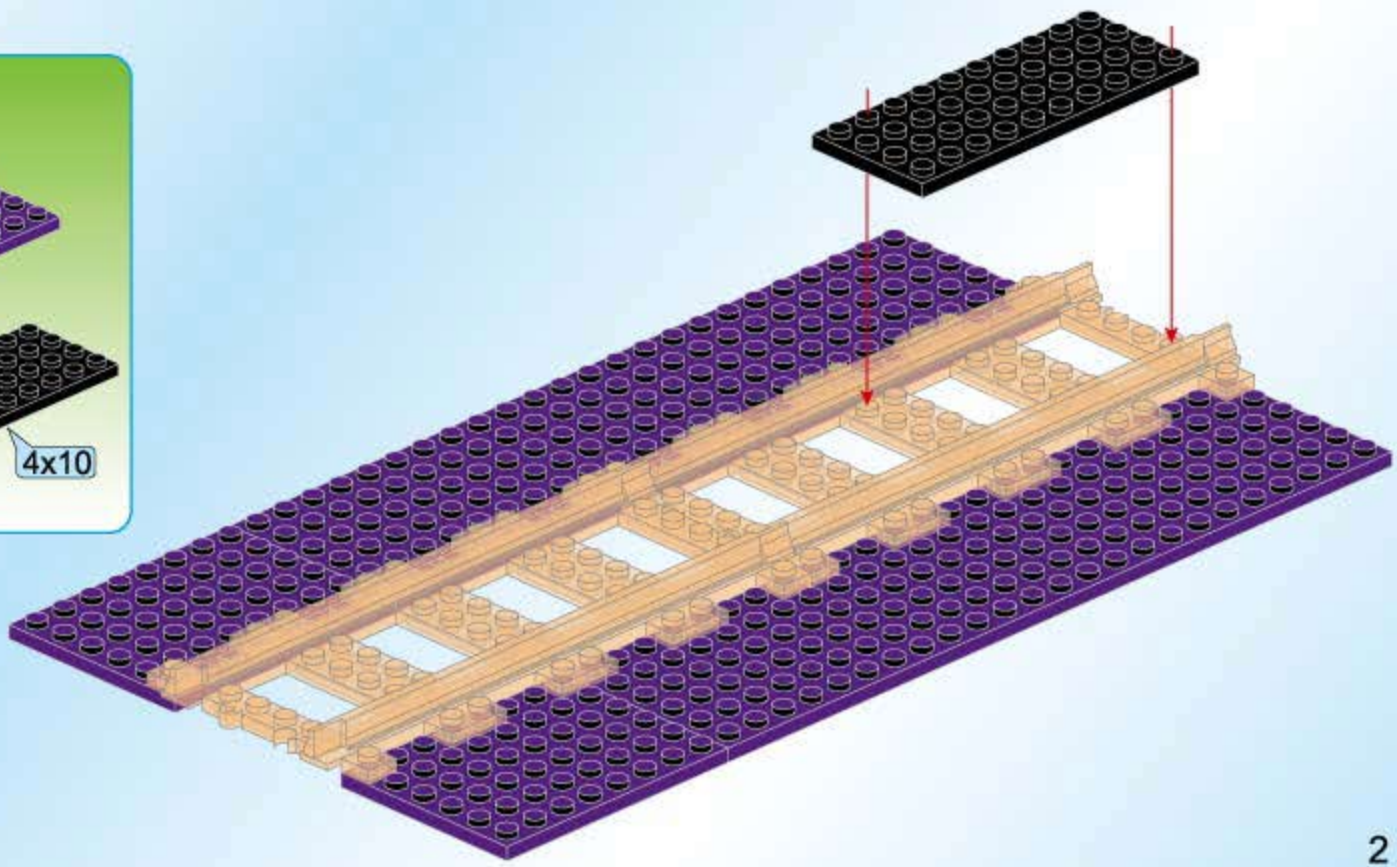
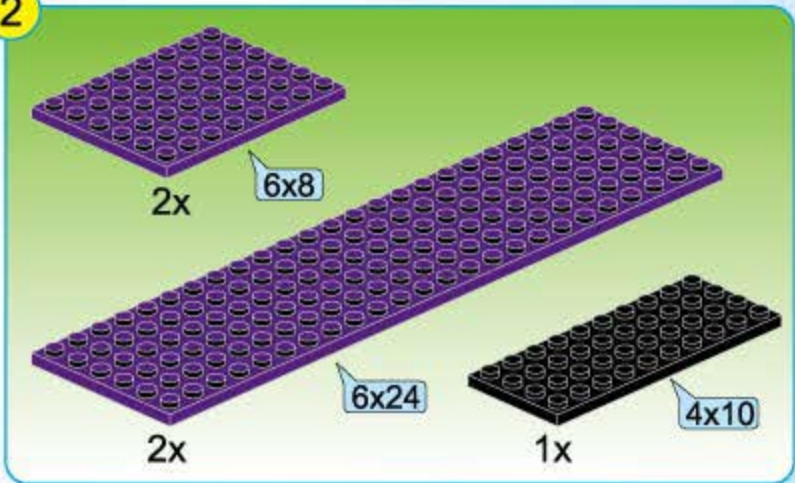

3

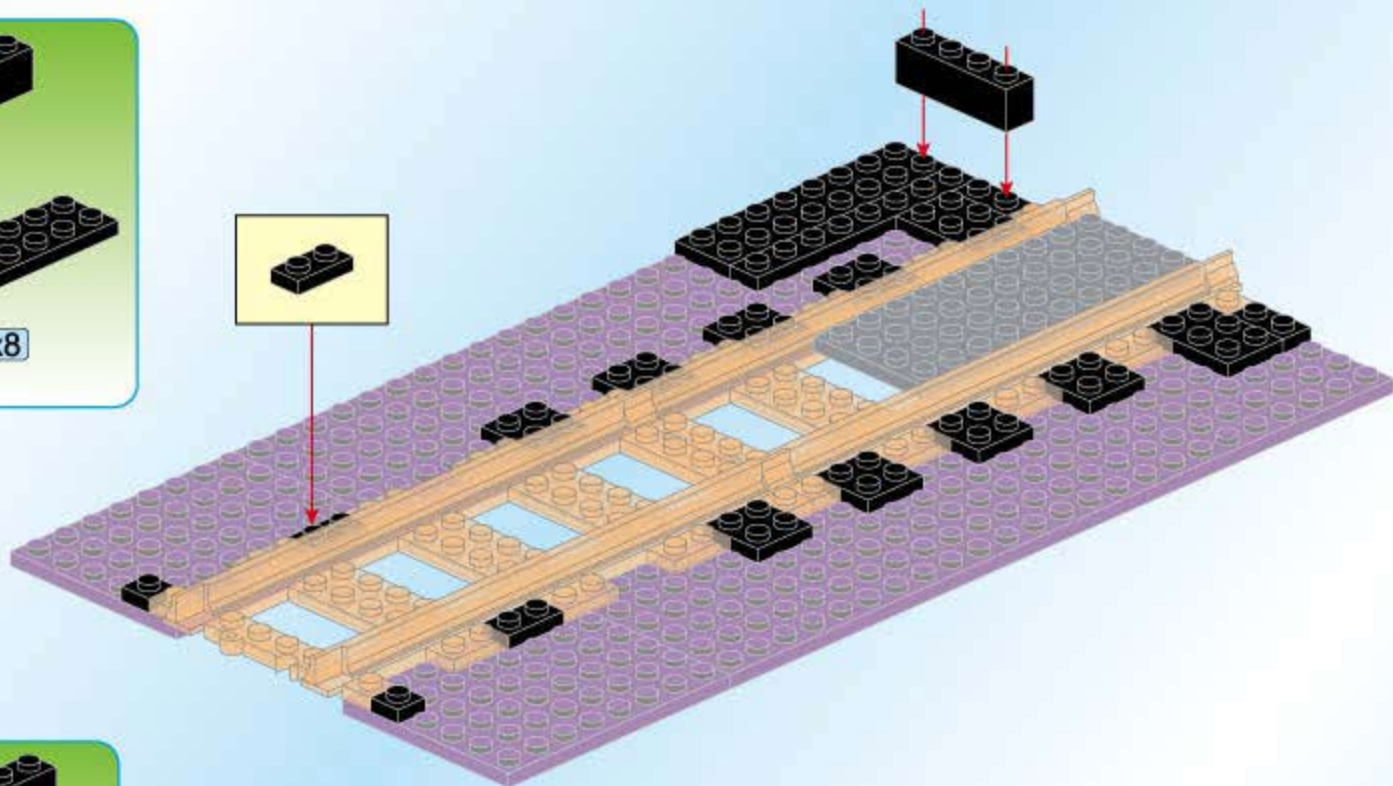
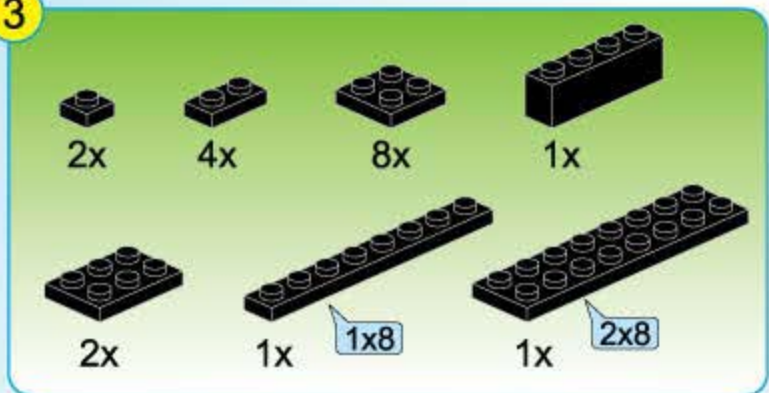

4

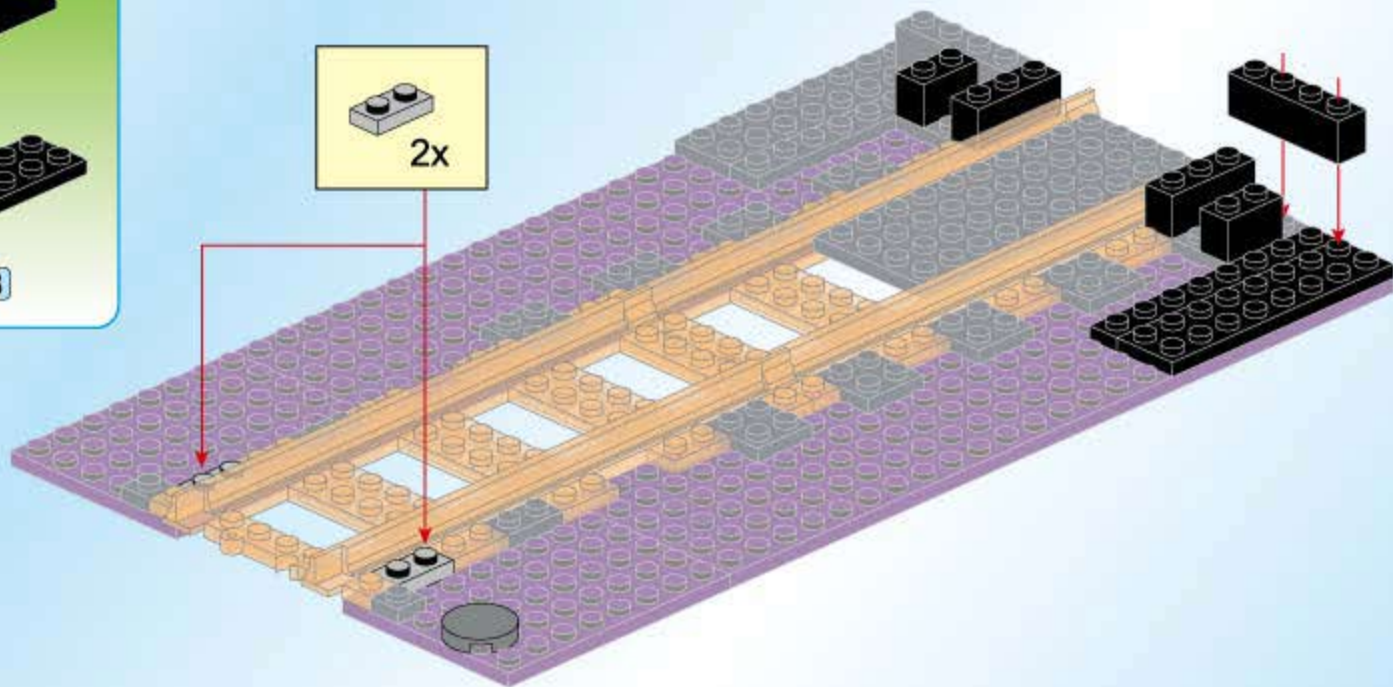
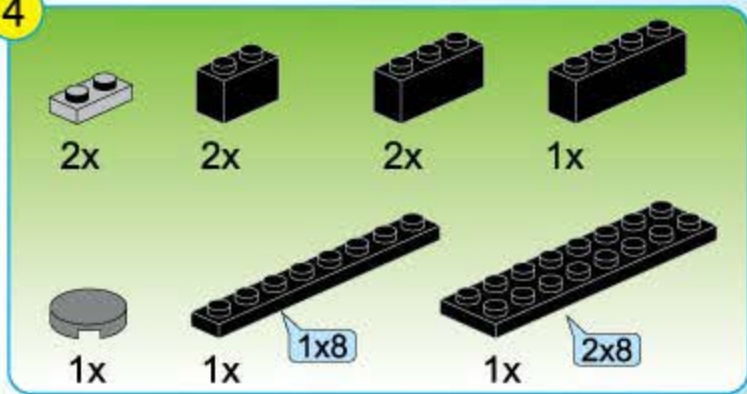

5

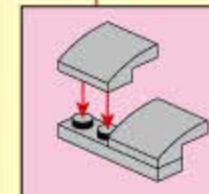
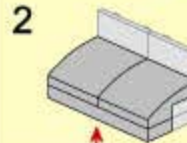
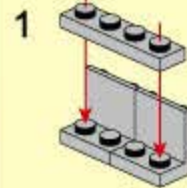
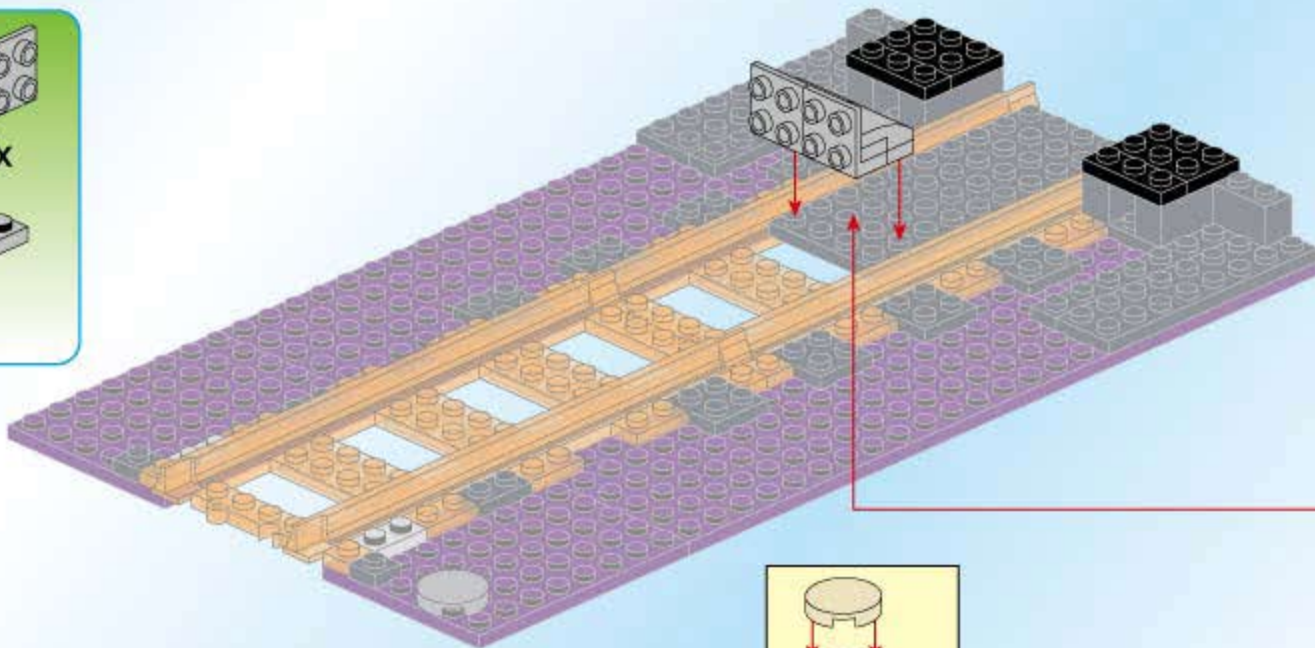
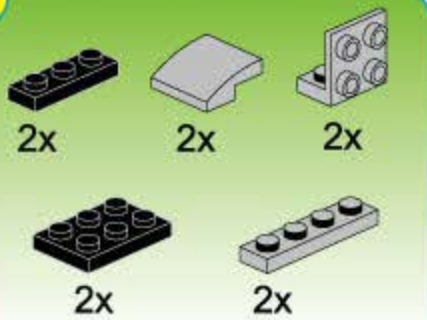

6

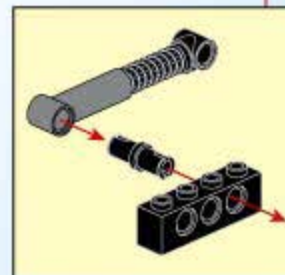
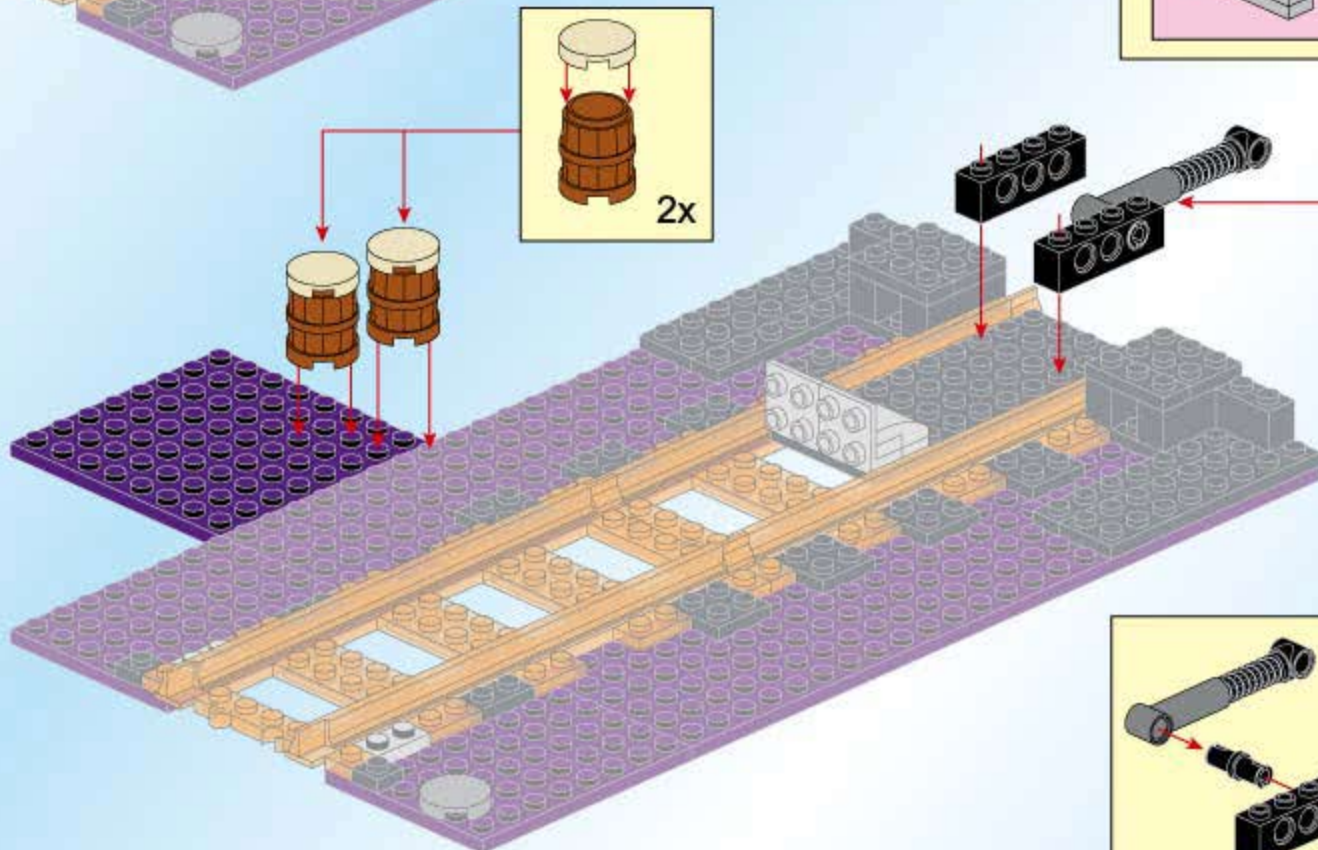
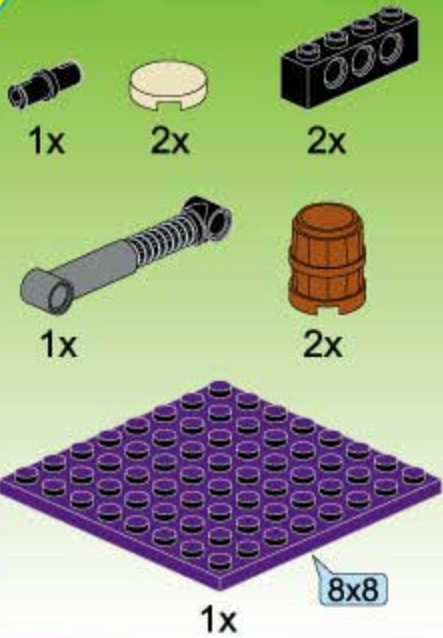

7

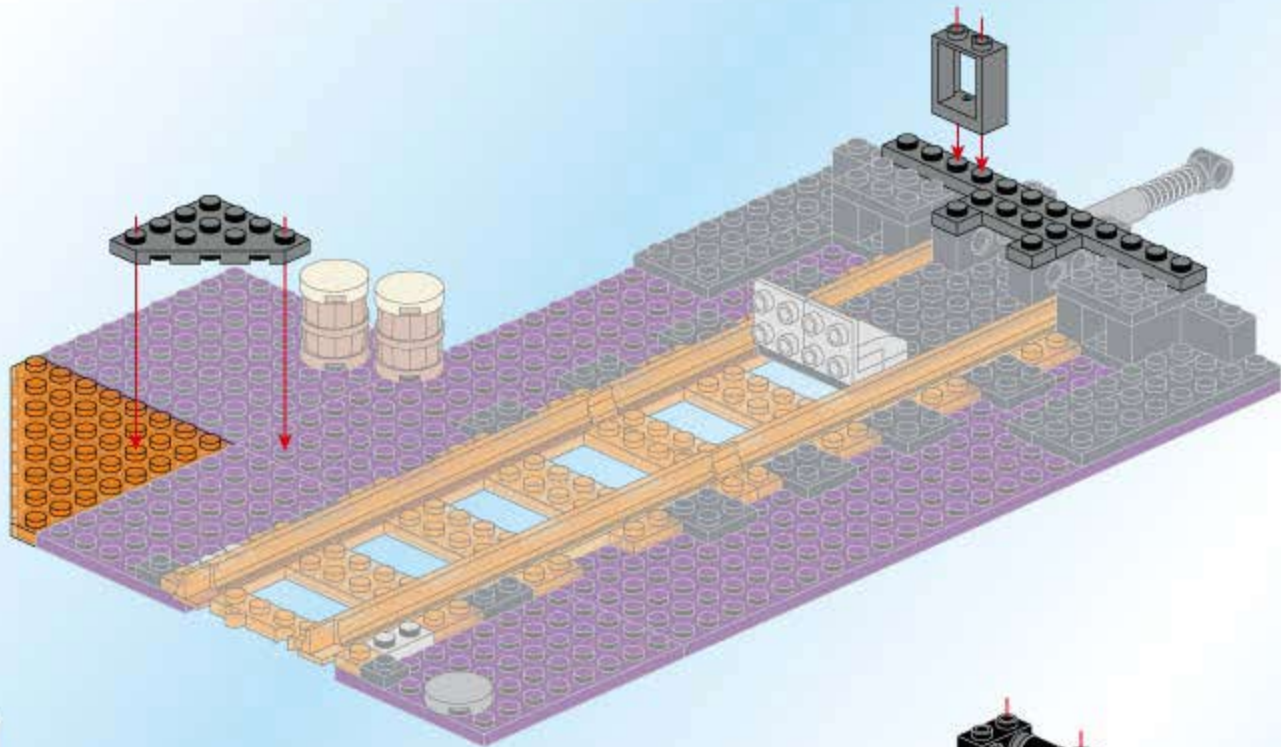
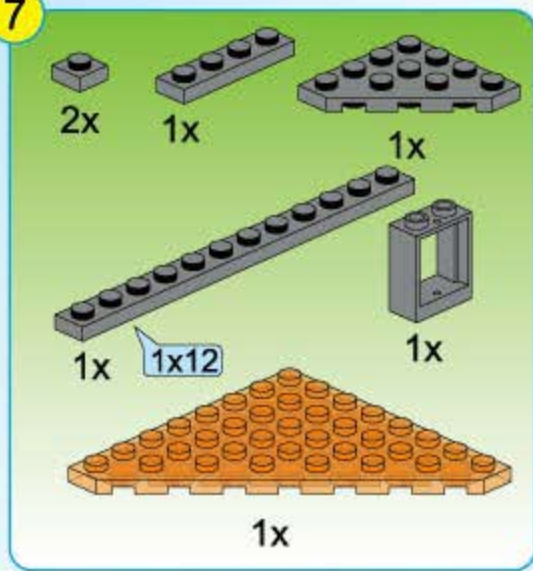

8

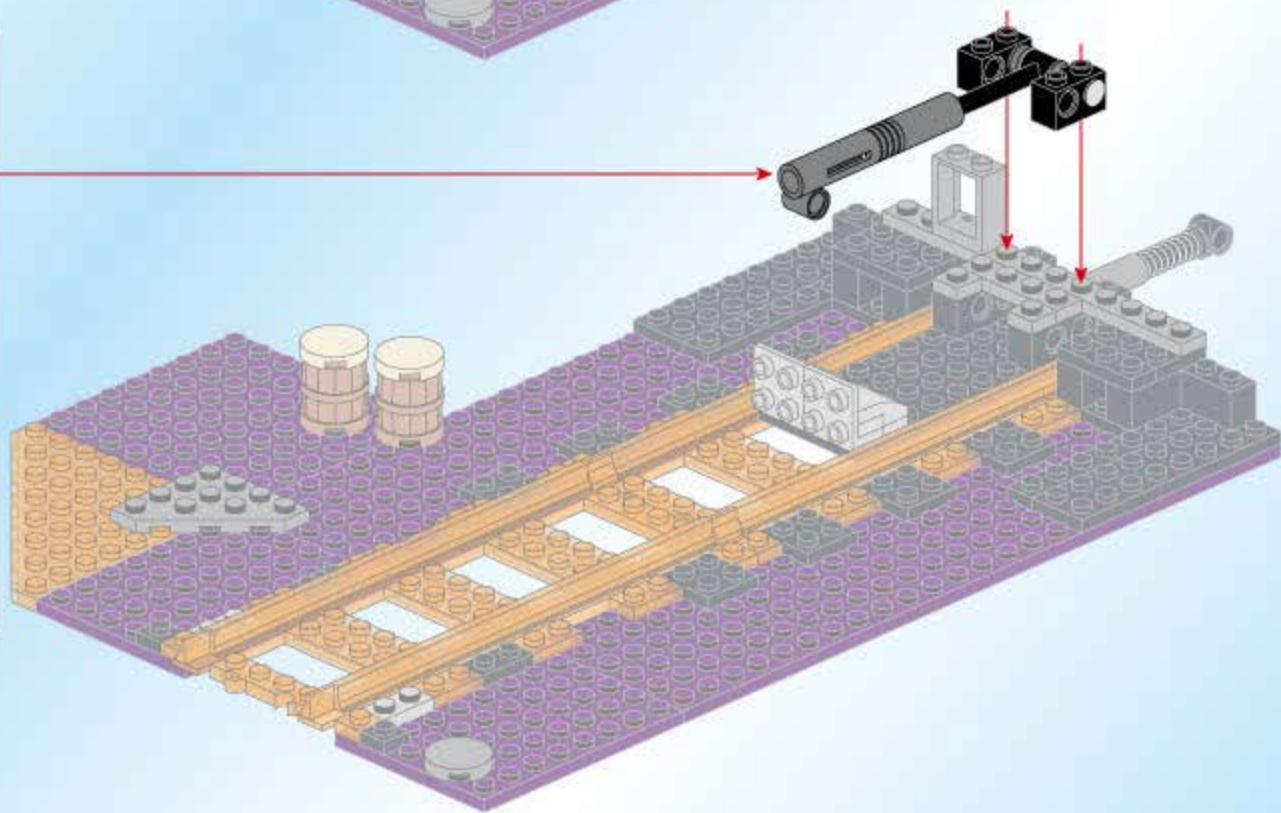
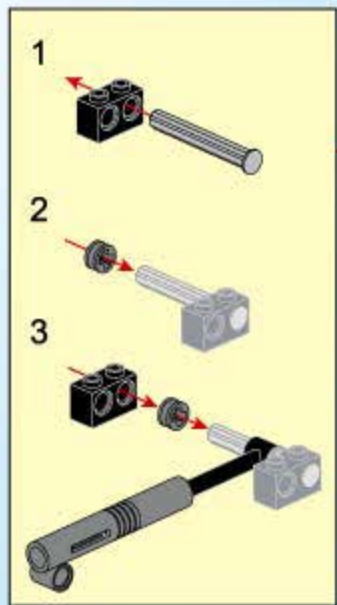

9

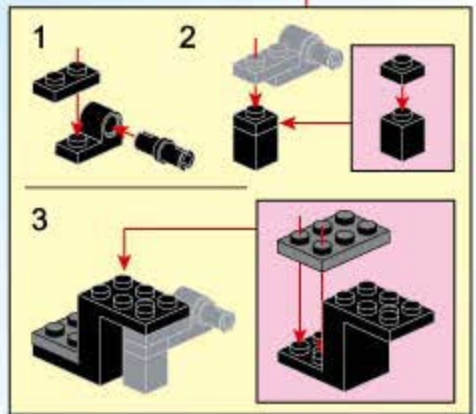
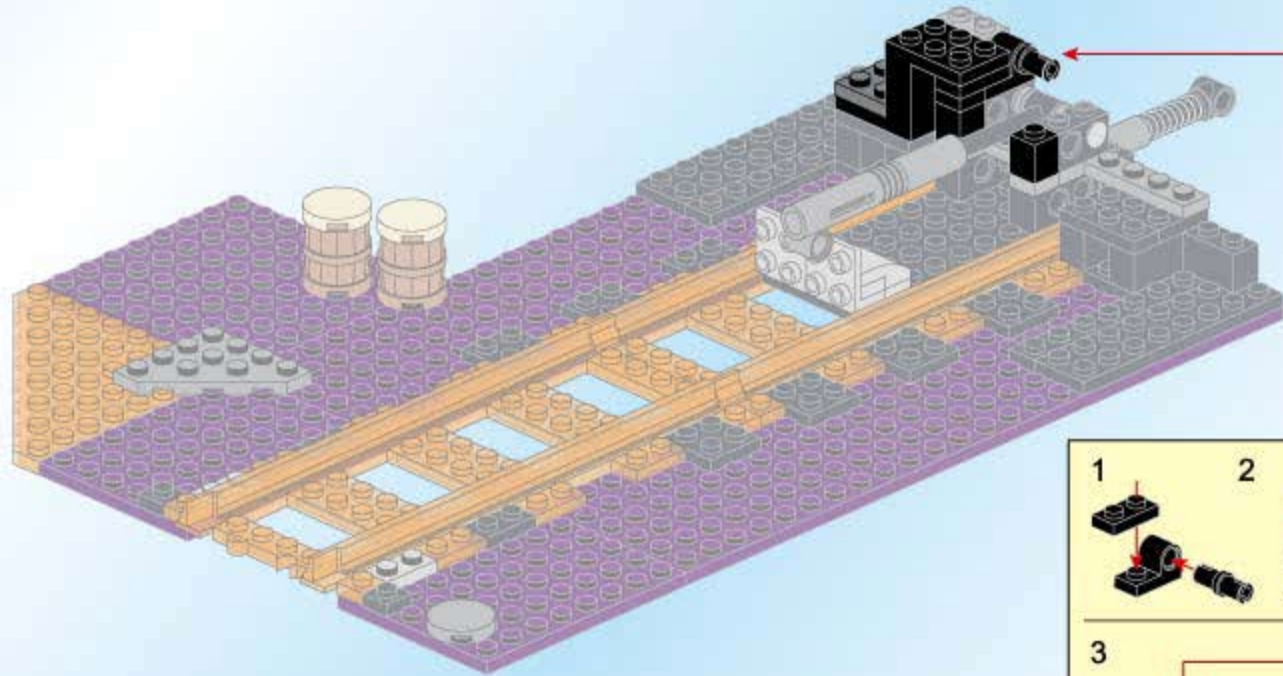
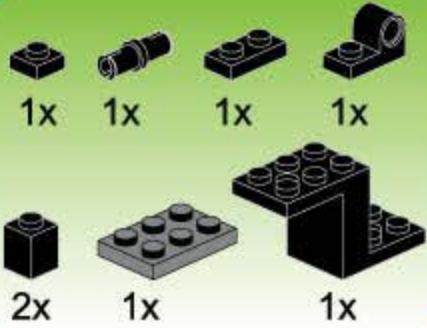

10

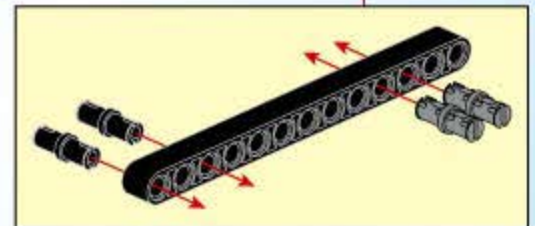
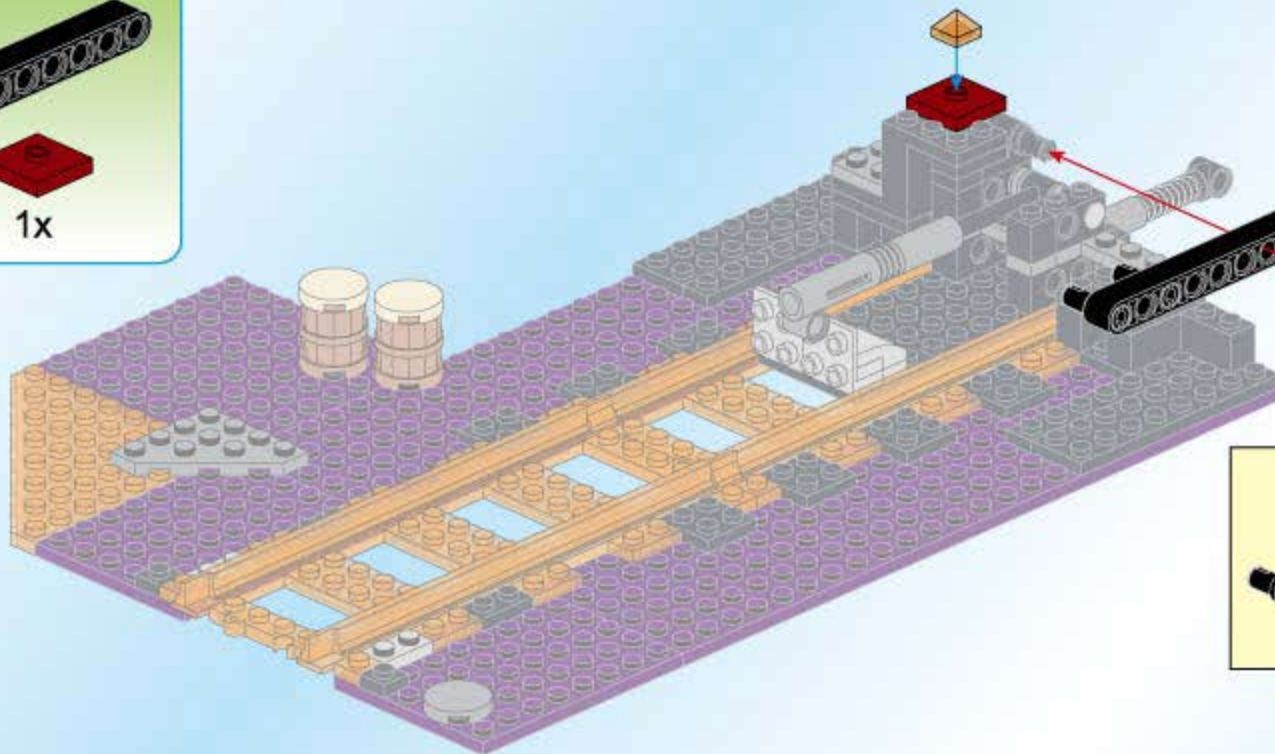
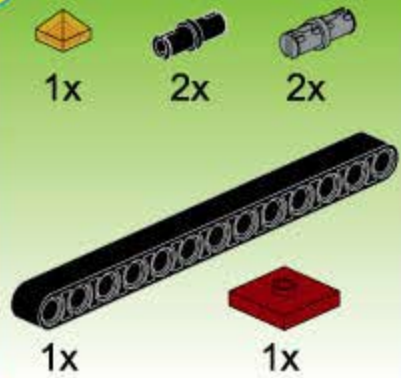

11

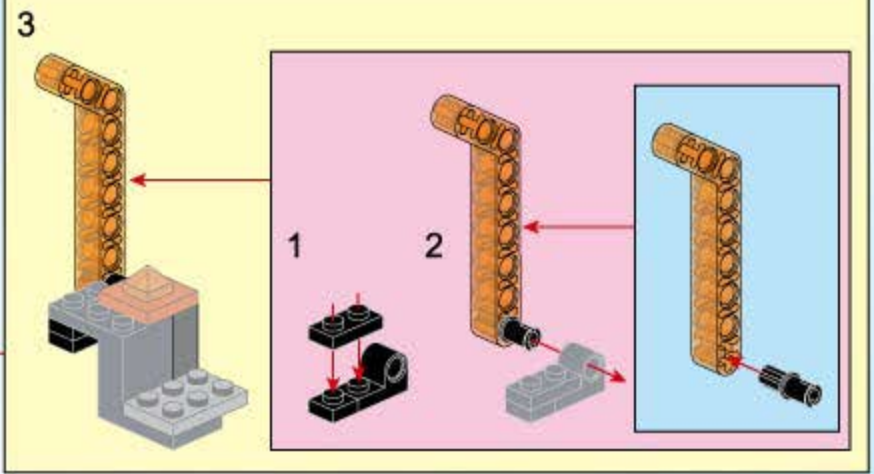
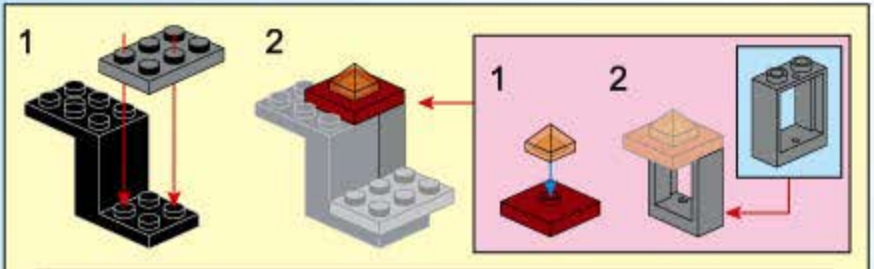
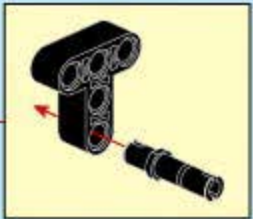
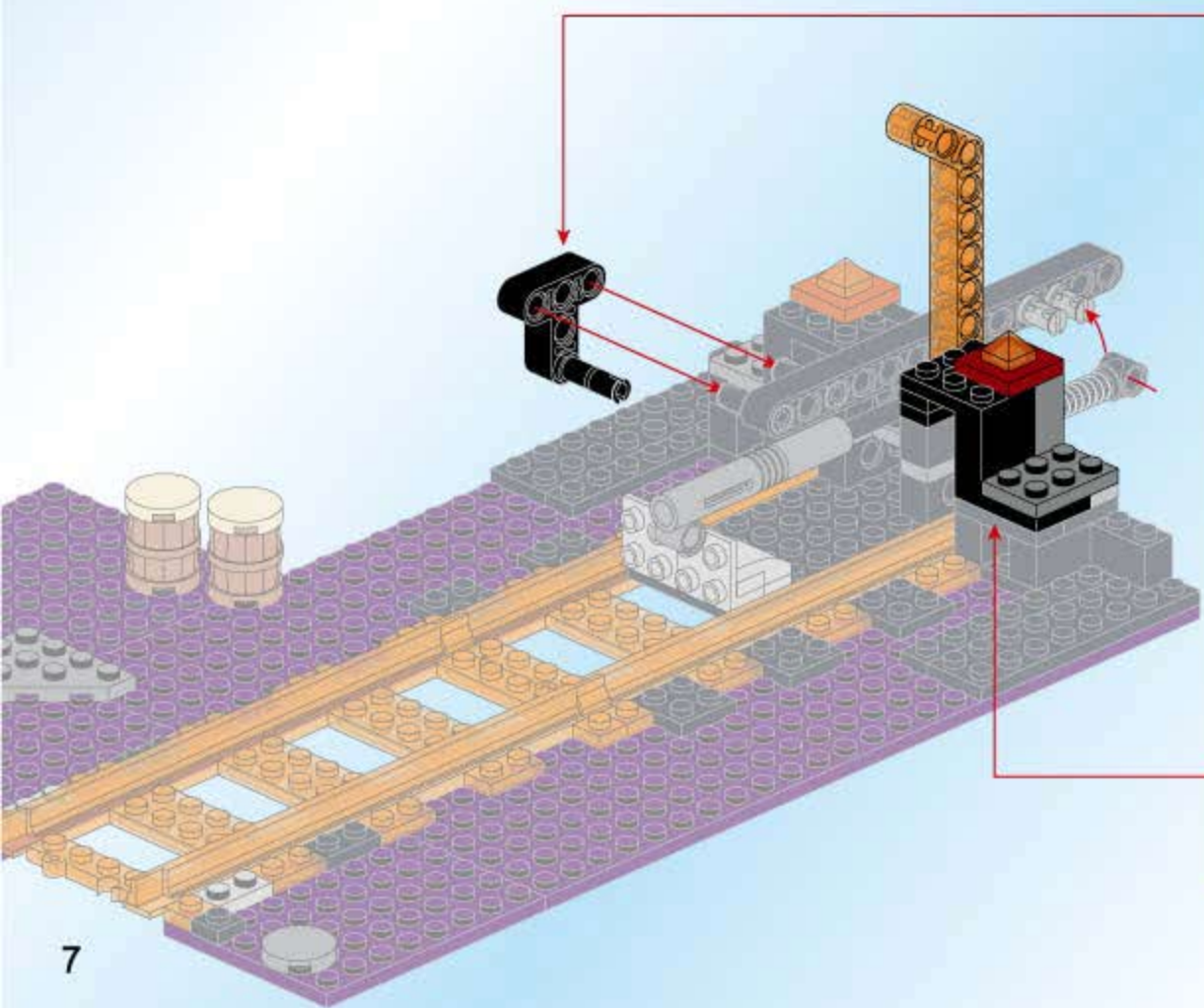
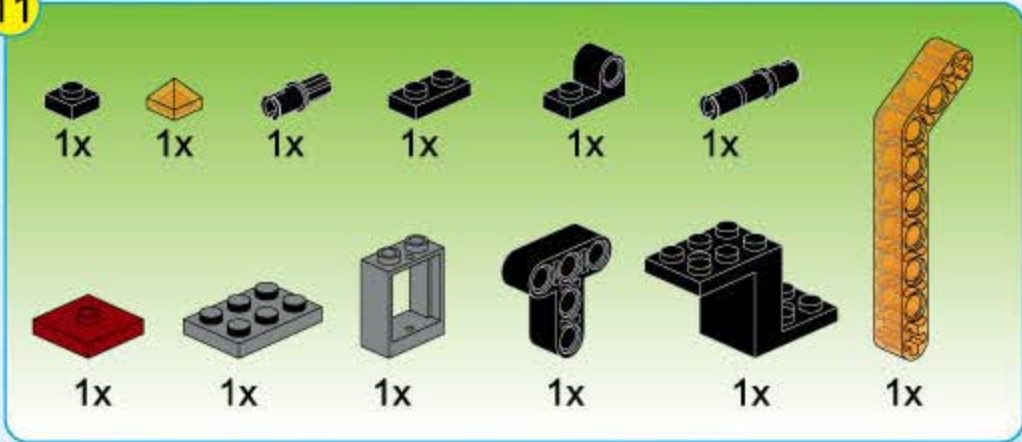

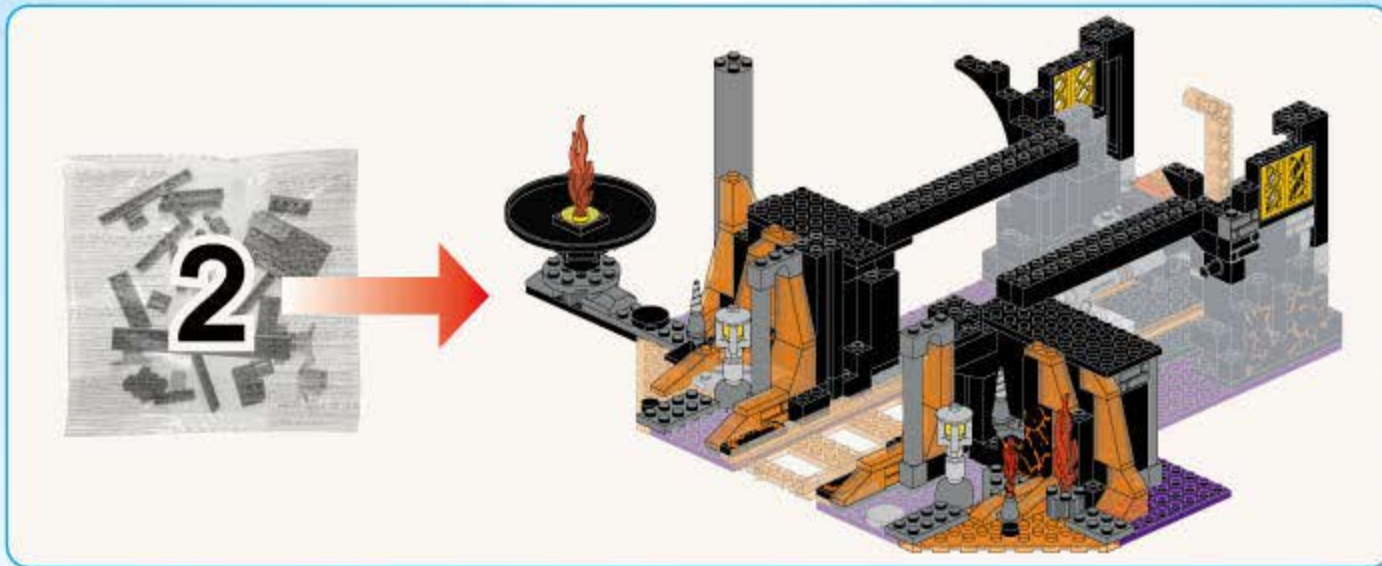

13

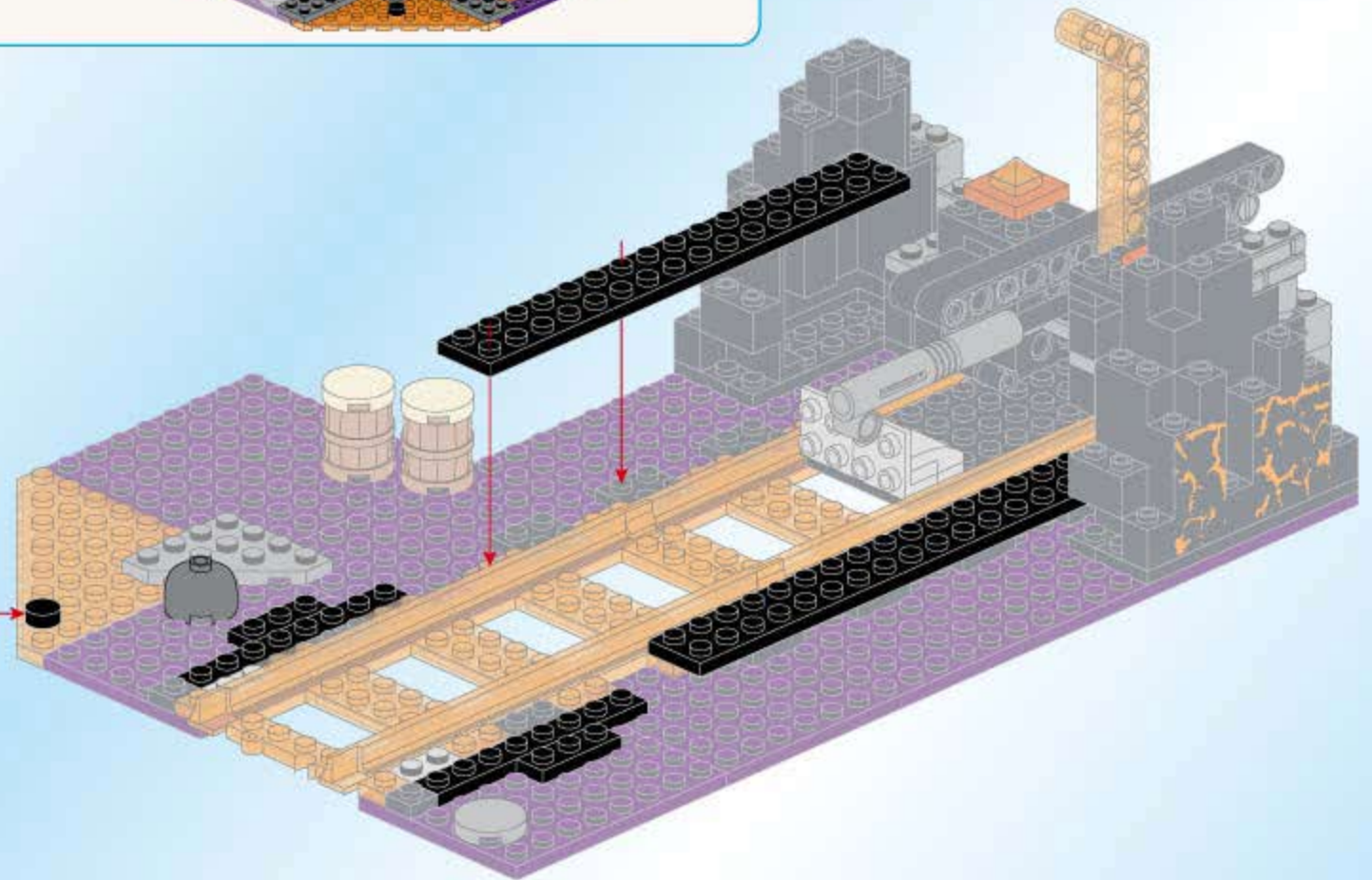
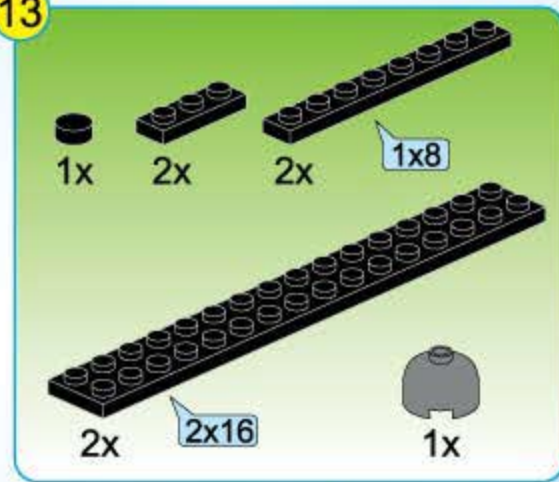







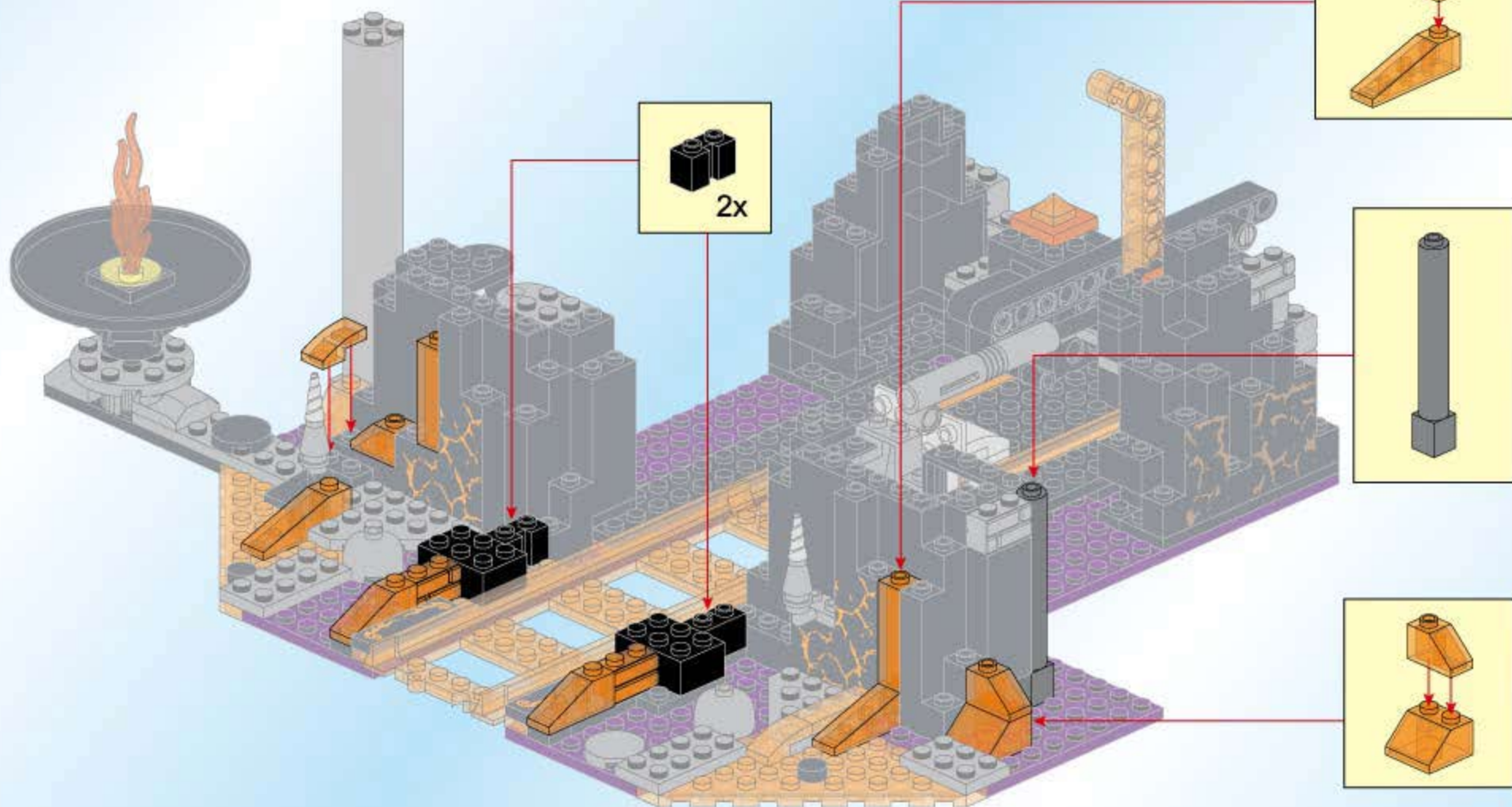
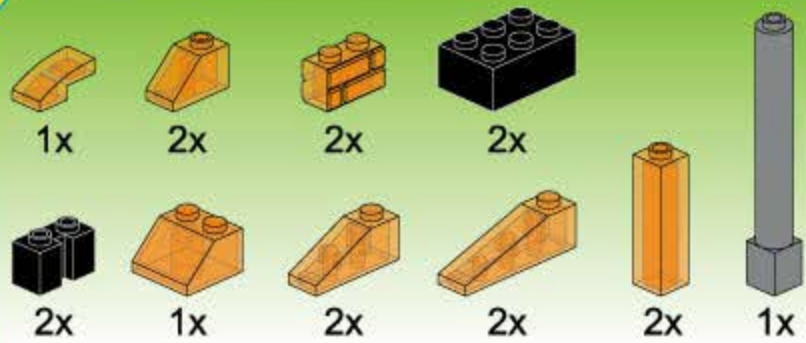

1x	2x	1x					
							2x
2x	2x	1x	1x	1x	1x	1x	2x
1x	2x	1x	1x	1x	1x	1x	2x

1

2

18



- | | | | |
|---|---|---|---|
| 
2x | 
1x | 
1x | 
2x |
| 
2x | 
1x | 
1x | 
3x |

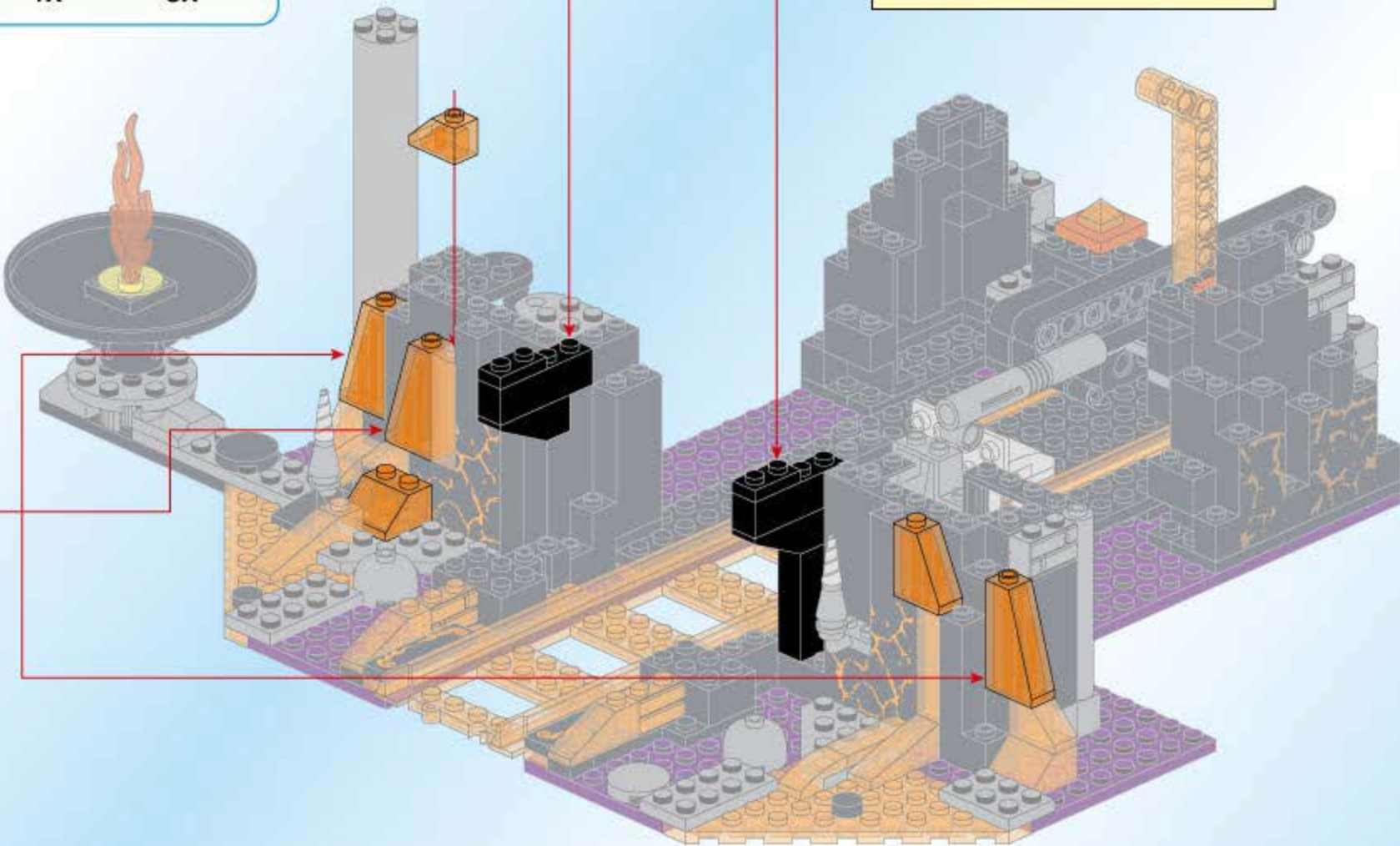
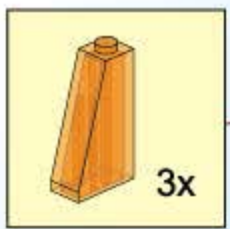
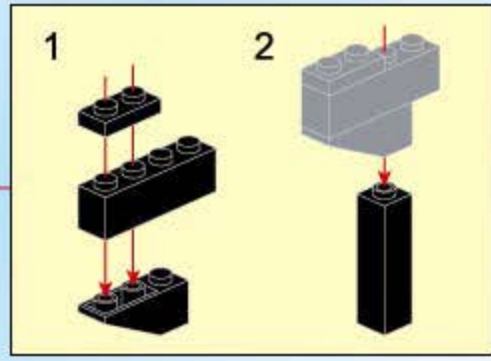
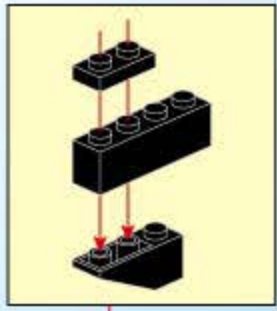

20

- 1x (grey) bush
- 1x (black) bush
- 2x (orange) 1x2 brick
- 1x (orange) 1x2 brick with hole
- 1x (orange) 1x2 brick with hole and notch
- 1x (red) flame piece
- 1x (orange) 1x2 brick with hole and notch
- 1x (black) 4x8 plate
- 1x (black) 1x2 brick
- 2x (black) 1x2 brick with hole

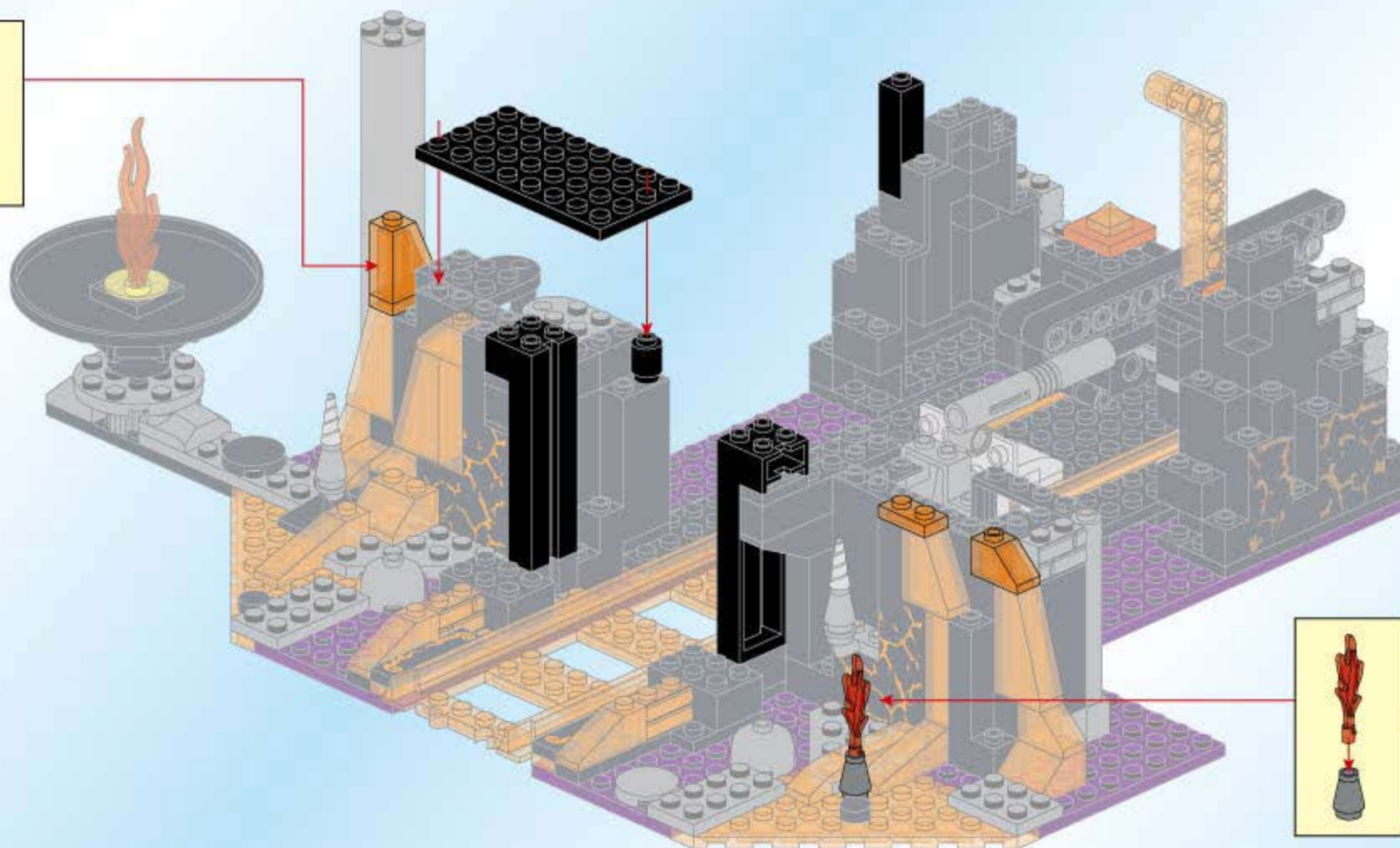
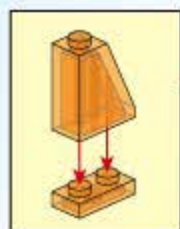

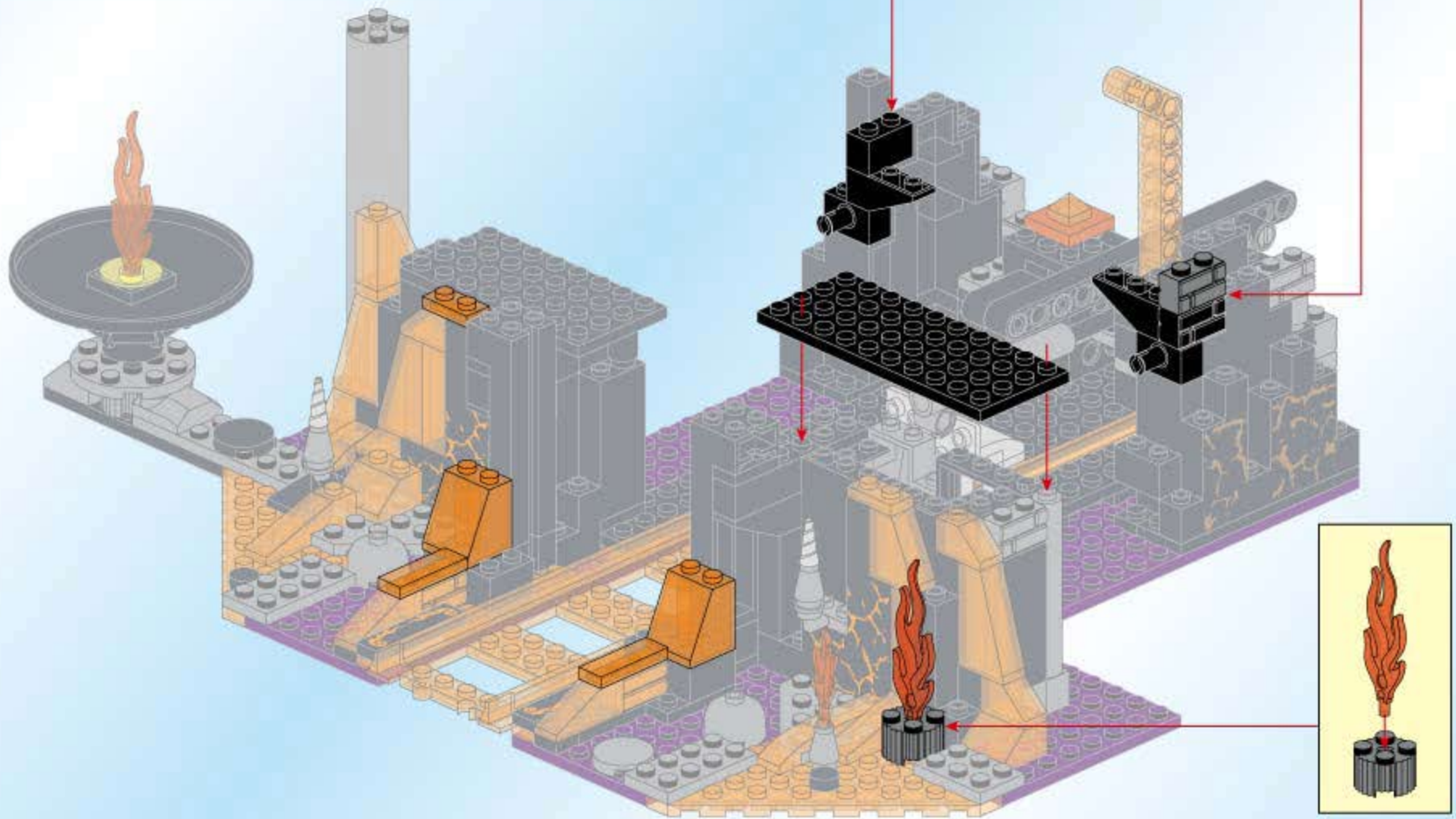
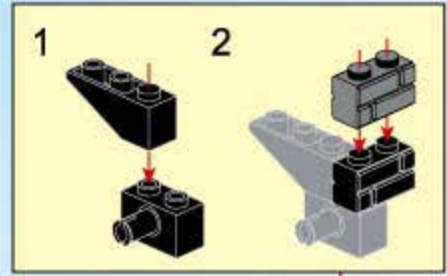
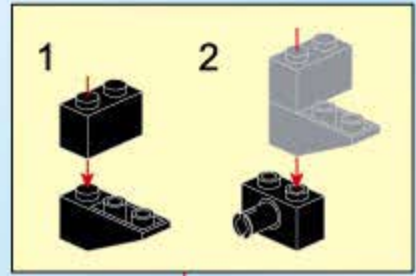
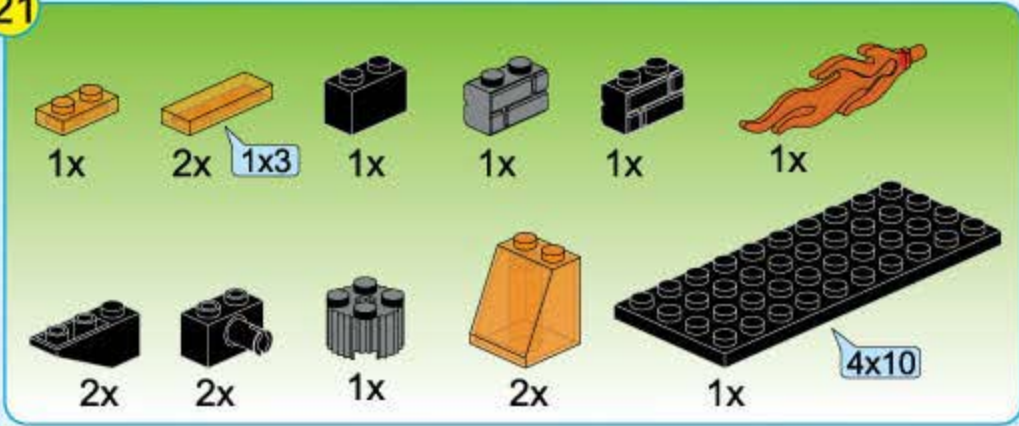

1x black 1x1 brick
1x black 1x2 brick
4x yellow 1x2 window
2x orange 1x2 wedge
2x black 1x2 frame
2x grey axle
1x black 1x2 curved brick

2x orange 1x2 wedge

2x yellow 1x2 window

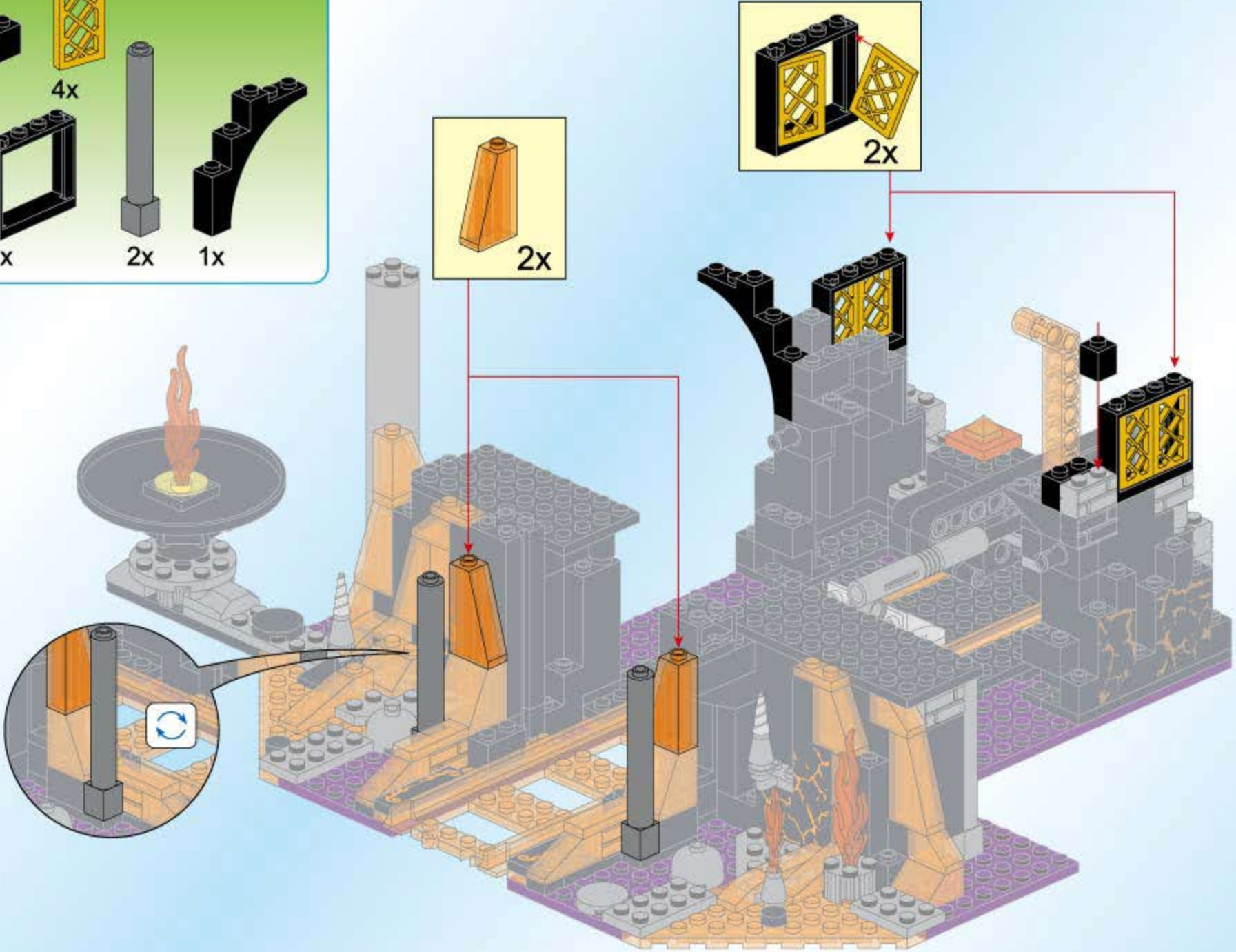

23

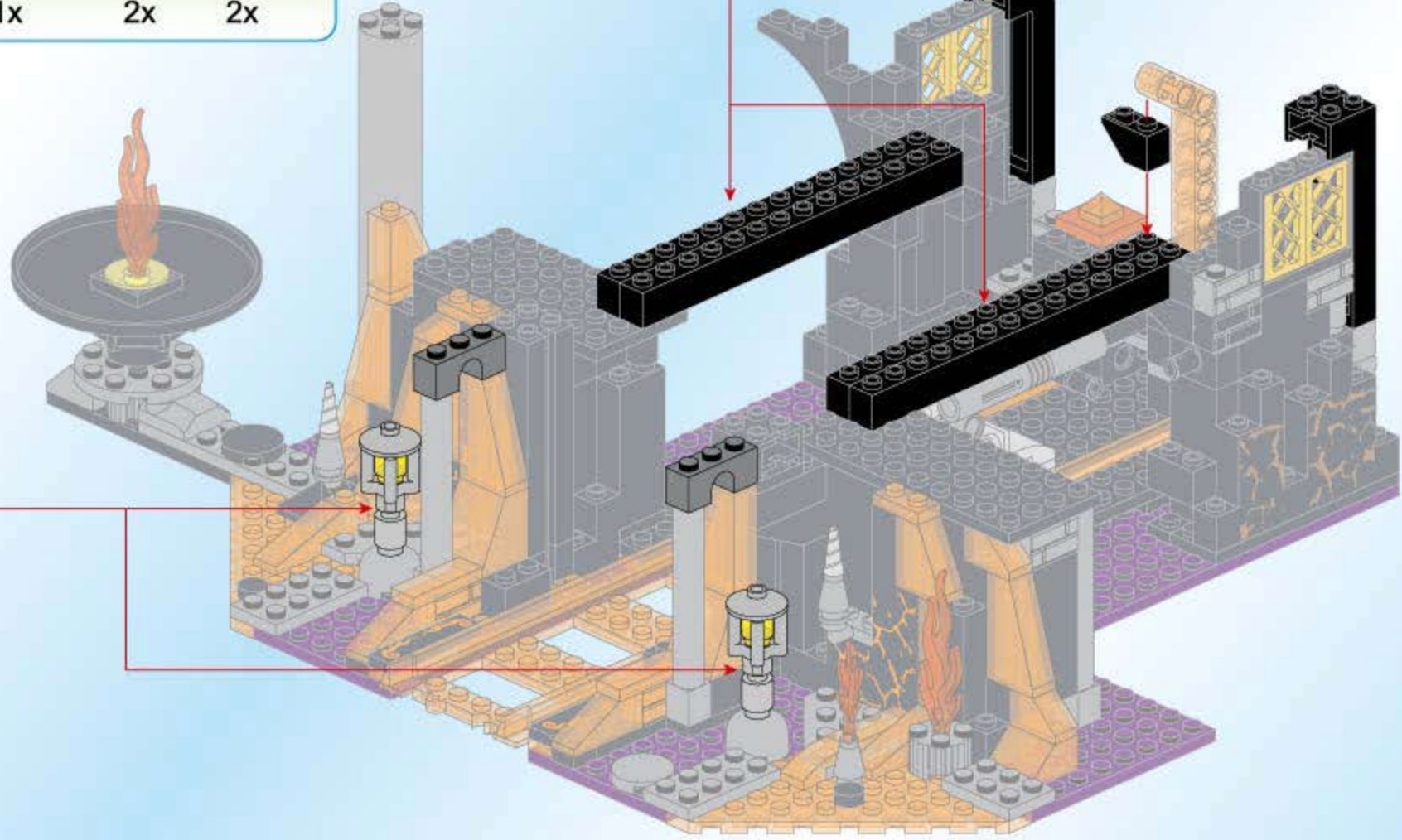
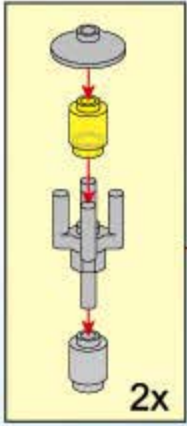
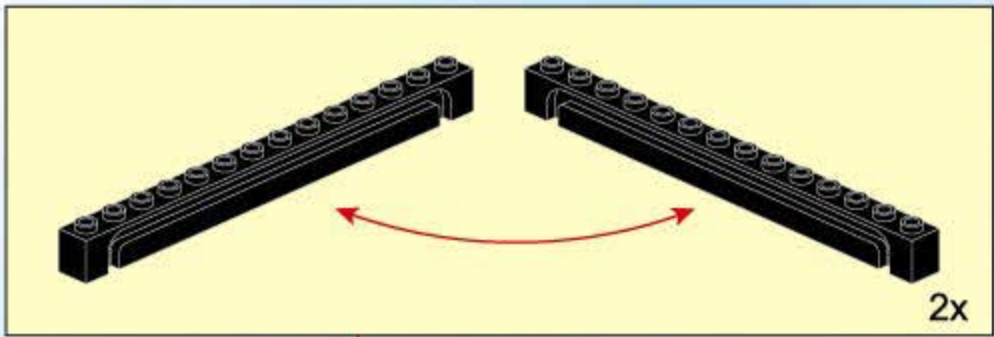
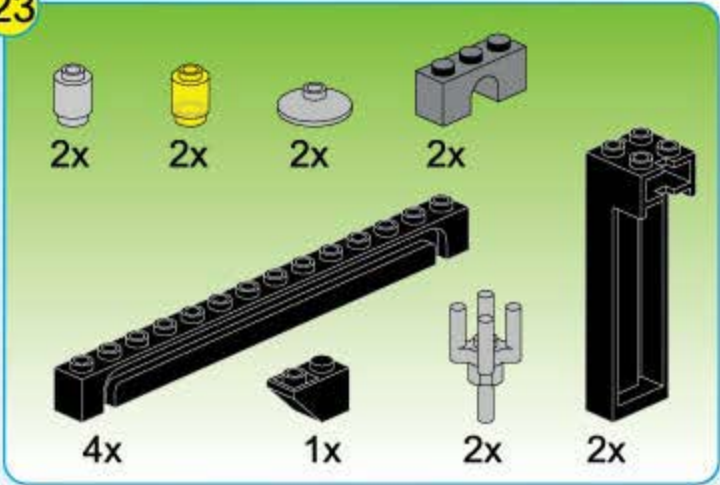

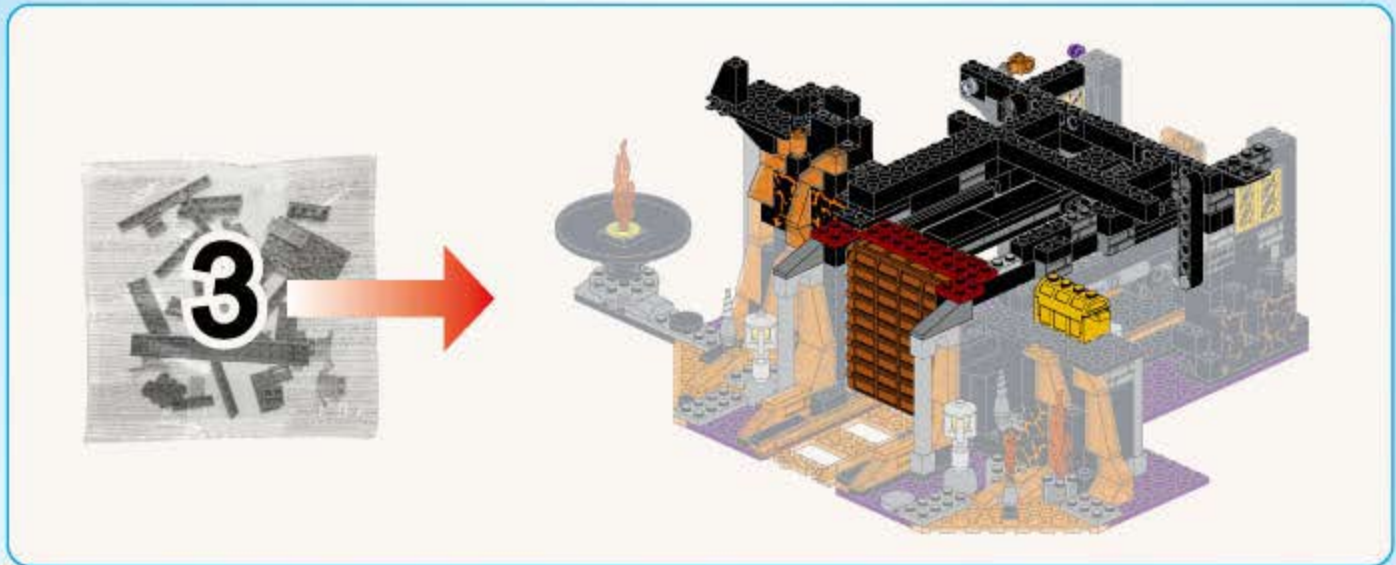

24



2x 1x 2x 1x



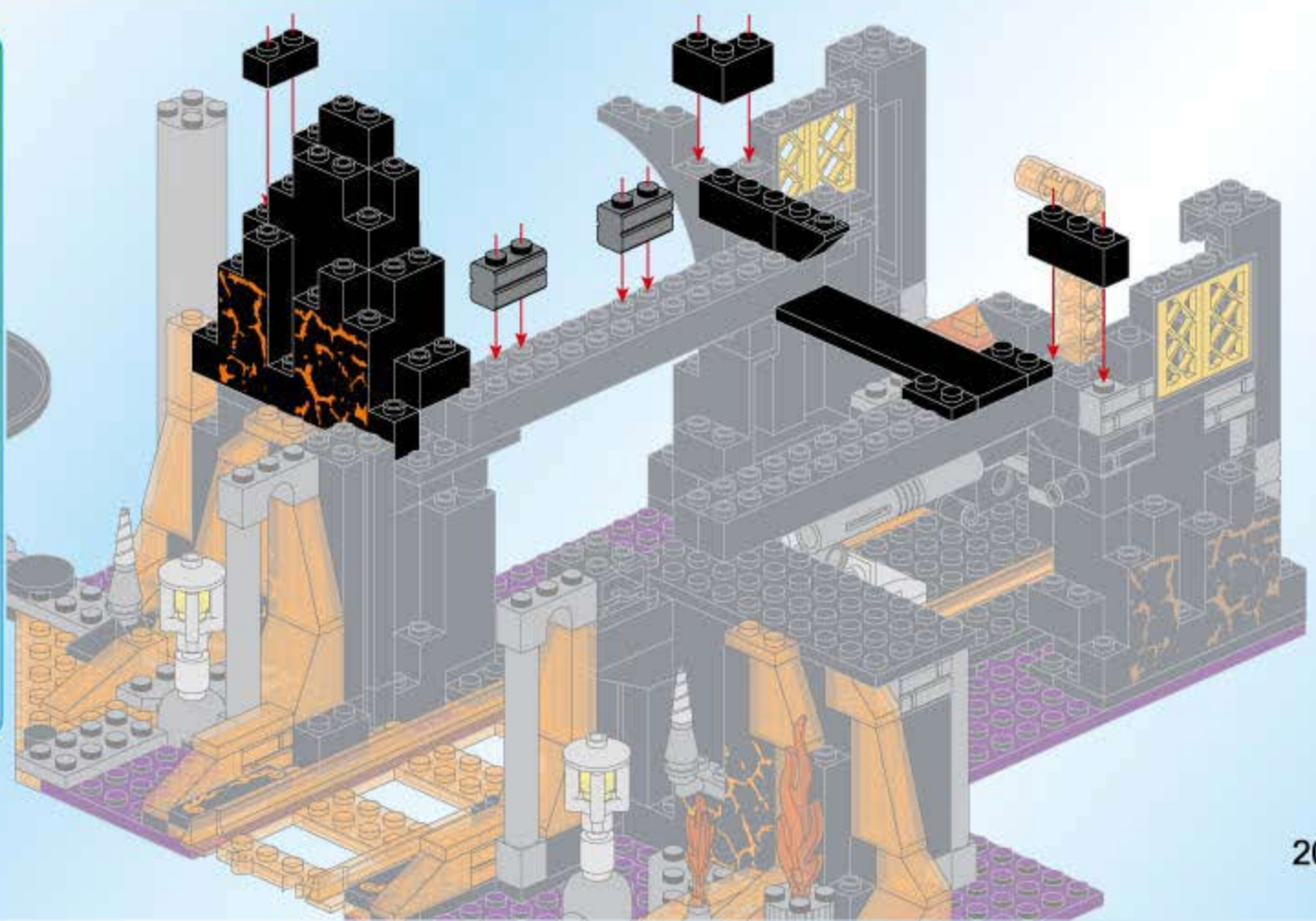

2x 1x

1x 2x8 1x

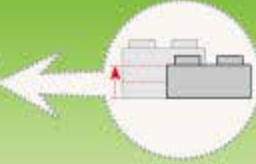

25

1x  6x  1x  

1x  2x  2x  1x 

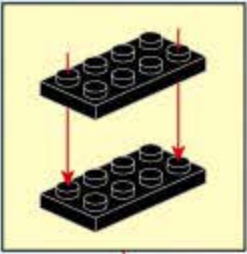
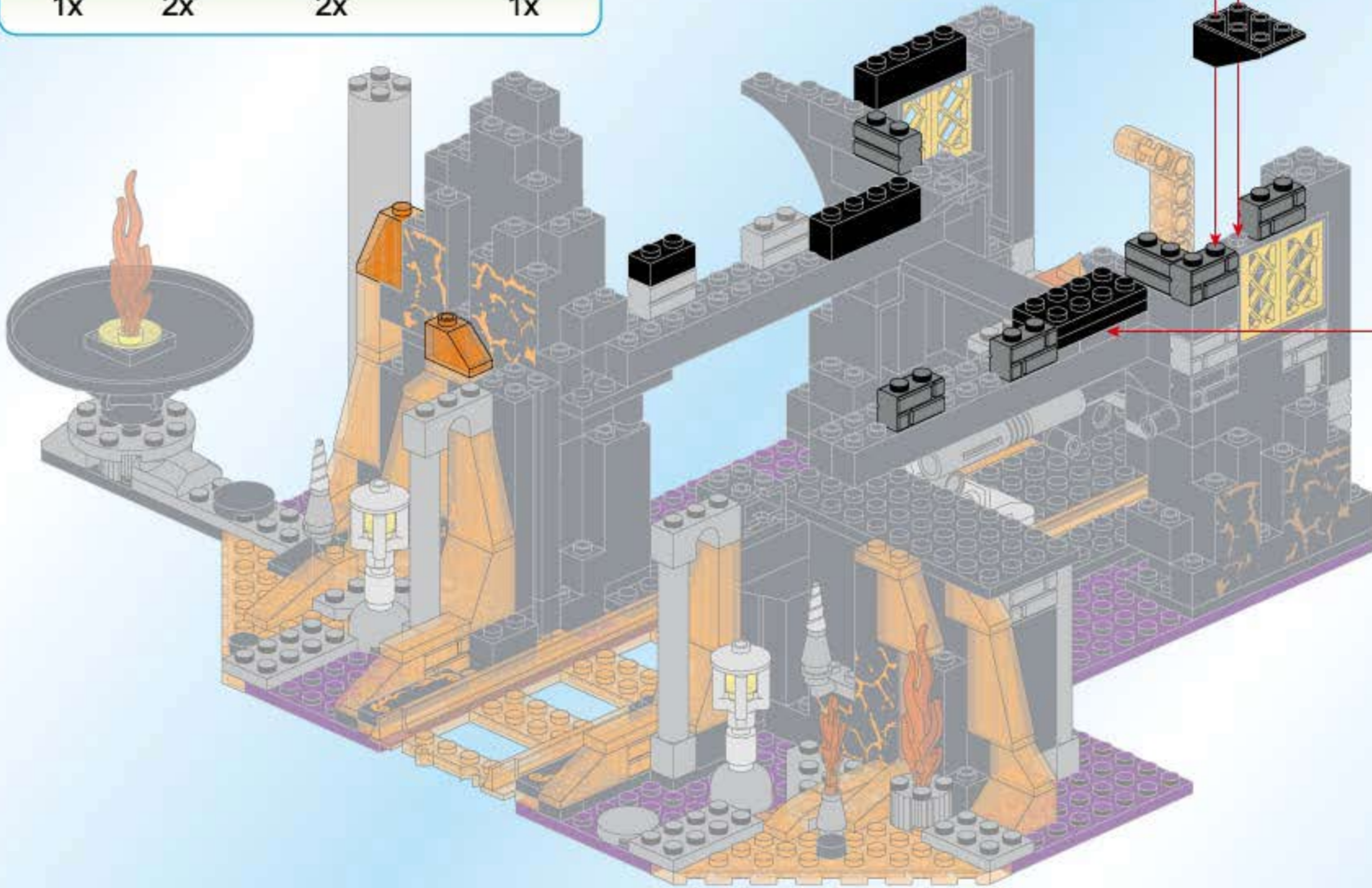

Parts list for step 26:

- 1x (black axle)
- 4x (black axle)
- 1x (grey 1-hole Technic brick)
- 4x (grey 2-hole Technic brick)
- 2x (grey axle)
- 11x (brown 1-hole Technic beam)
- 1x (brown 2-hole Technic beam)
- 1x (grey axle)
- 1x (black axle)
- 2x (black axle)
- 2x (black 2x8 Technic plate)
- 2x (black 2x4 Technic plate)
- 1x (black 2x12 Technic plate)

Ratio 1:1 for part 3

Ratio 1:1 for part 6

Main assembly diagram for step 26 showing four steps:

- Step 1: A grey 1-hole Technic brick is placed on top of a grey 2-hole Technic brick, which is then attached to a black 12-hole Technic plate.
- Step 2: A black axle is inserted into the hole of the grey 1-hole Technic brick.
- Step 3: A black 2x8 Technic plate is attached to the black axle.
- Step 4: A black 2x4 Technic plate is attached to the black axle.

Inset diagrams for step 1:

- Inset 1: Shows the grey 1-hole Technic brick being placed on the grey 2-hole Technic brick.
- Inset 2: Shows the grey 2-hole Technic brick being placed on the black 12-hole Technic plate.

Inset diagram for step 2:

- Inset 3: Shows the black axle being inserted into the hole of the grey 1-hole Technic brick.

Inset diagram for step 3:

- Inset 6: Shows the black 2x8 Technic plate being attached to the black axle.

Inset diagrams for step 4:

- Inset 1: Shows the black 2x4 Technic plate being attached to the black axle.
- Inset 2: Shows the brown 1-hole Technic beam being attached to the black axle.

Inset diagram for step 4 (bottom right):

- Inset 1: Shows the black 2x4 Technic plate being attached to the black axle.
- Inset 2: Shows the grey 2-hole Technic brick being attached to the black axle.

27



1x



1x

26

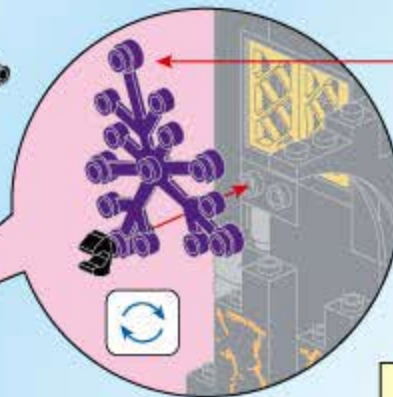
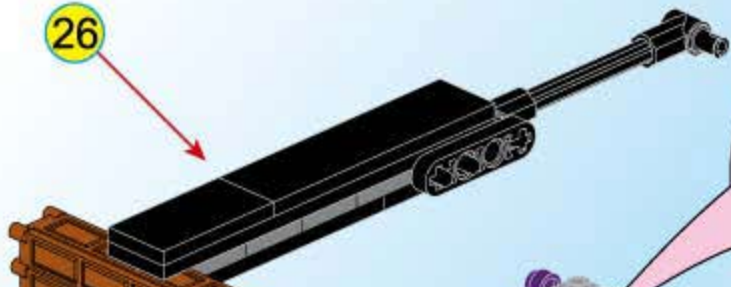

25

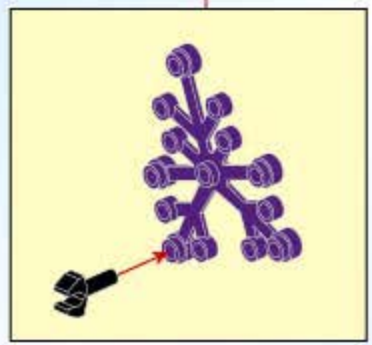
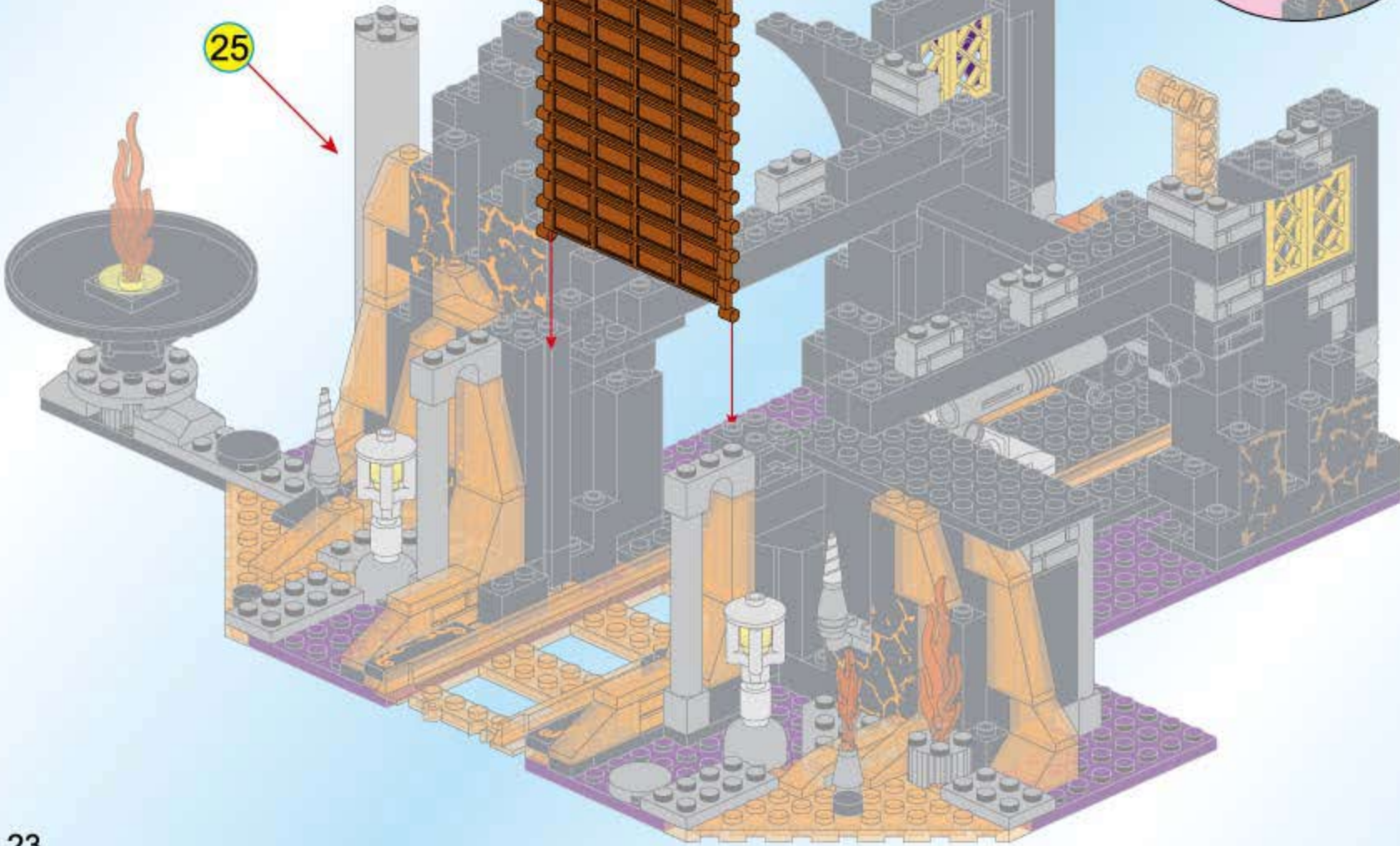

1x [Orange 1x2 Pin] 1x [Orange 1x2 Brick with Hole] 1x [Black 1x2 Brick with Hole] 2x [Black 1x10 Technic Beam] 1x [Orange 1x2 Wedge] 1x [Orange 1x2 Wedge]

(Note: A circular inset shows a grey 1x2 Technic Beam with a red arrow pointing to the hole position.)

1 [Black 1x2 Brick with Hole] 2 [Orange 1x2 Brick with Hole]

(Note: Diagram 1 shows the black brick being placed on top of the orange brick. Diagram 2 shows an orange pin being inserted into the hole of the orange brick.)

2x [Black 1x10 Technic Beam]

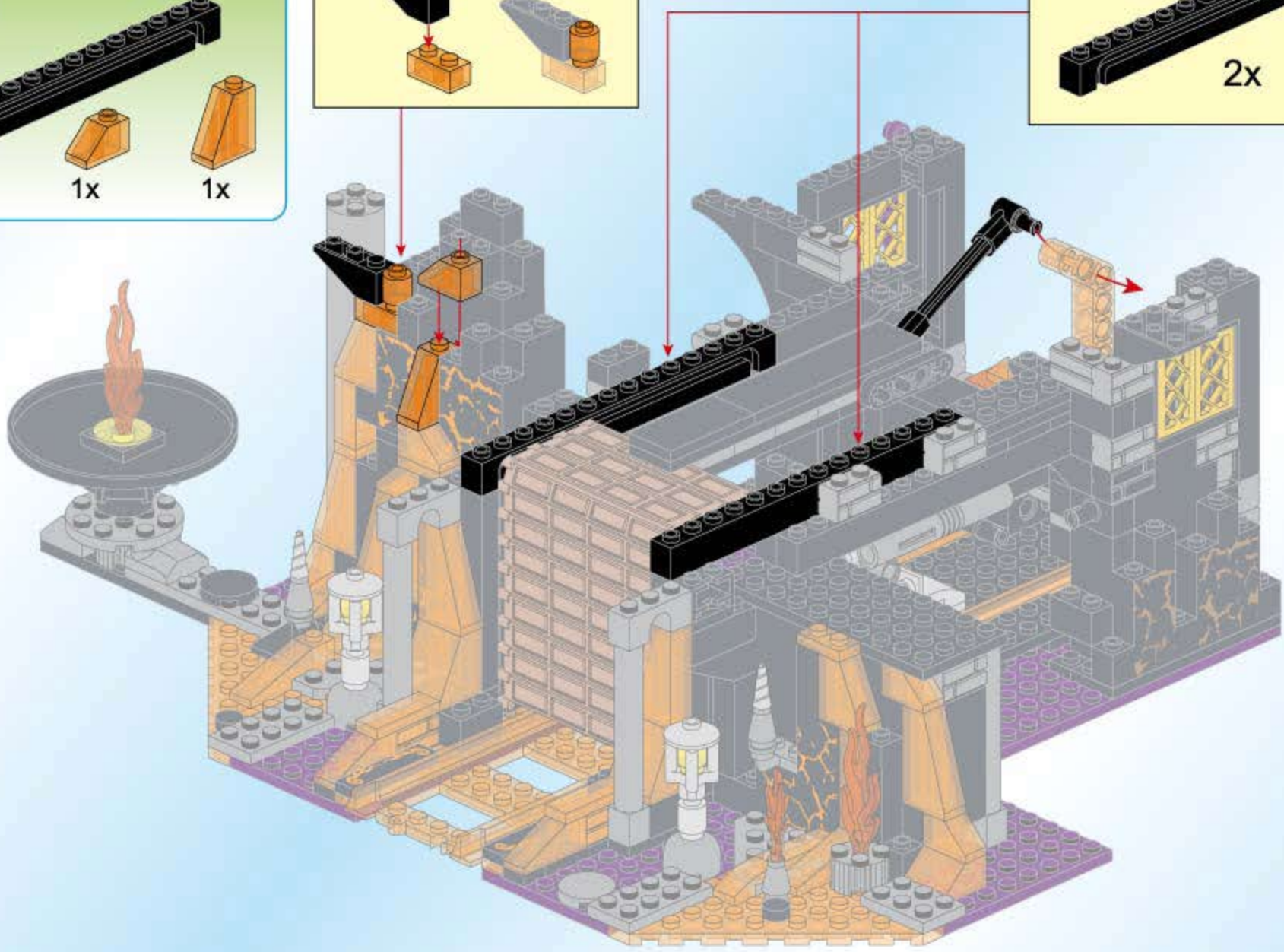

29

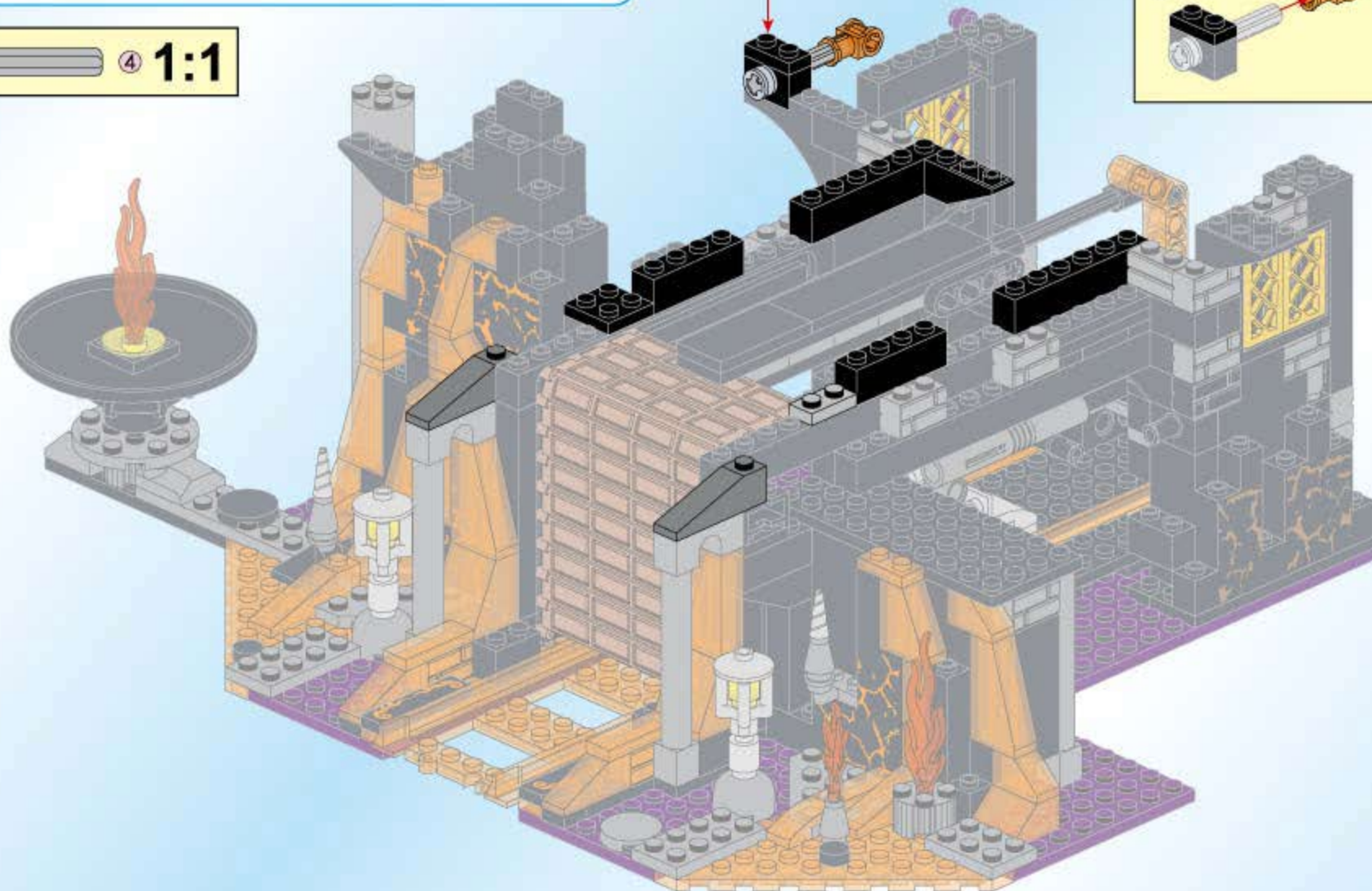
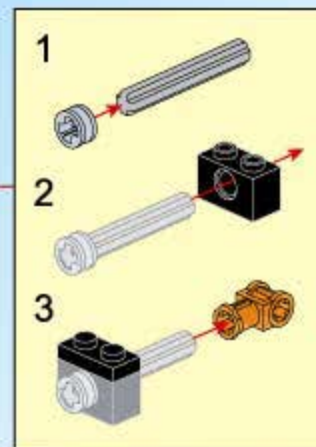
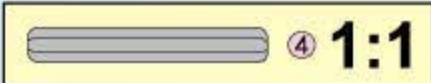
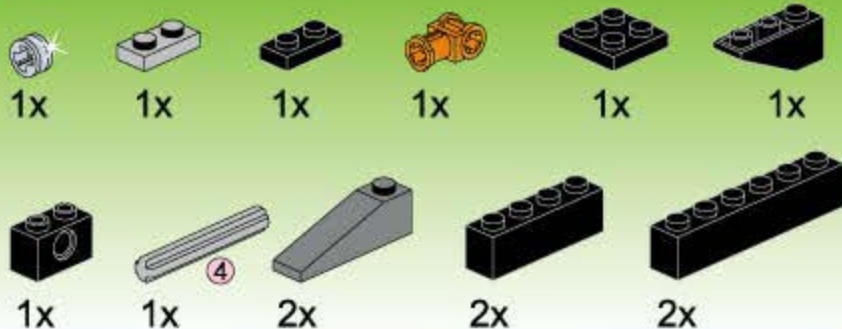

2x 1x 2x 1x 2x 2x

2x 1x 2x10 1x

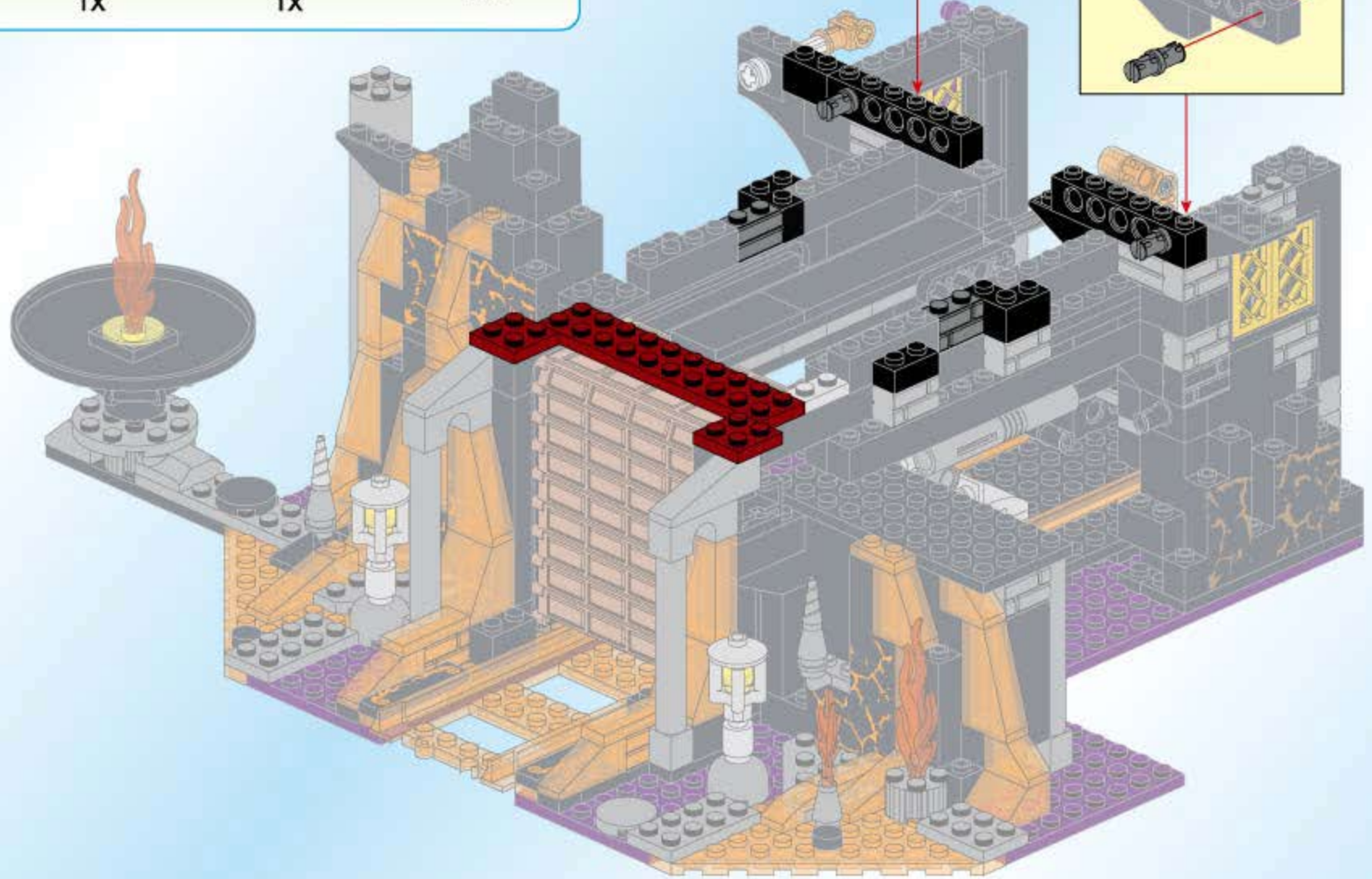
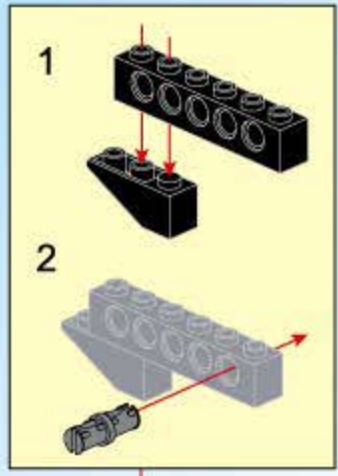
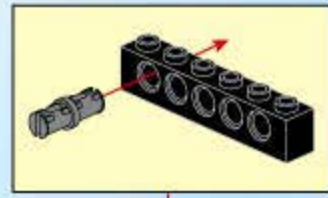

31

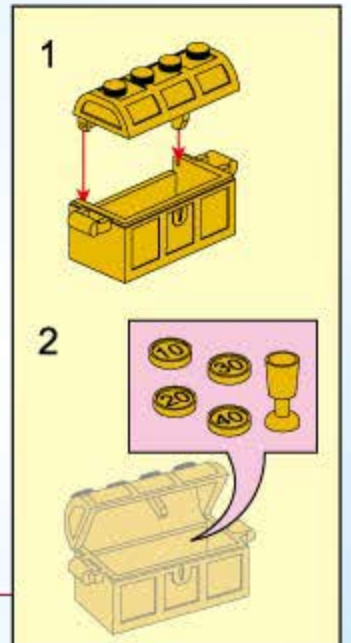
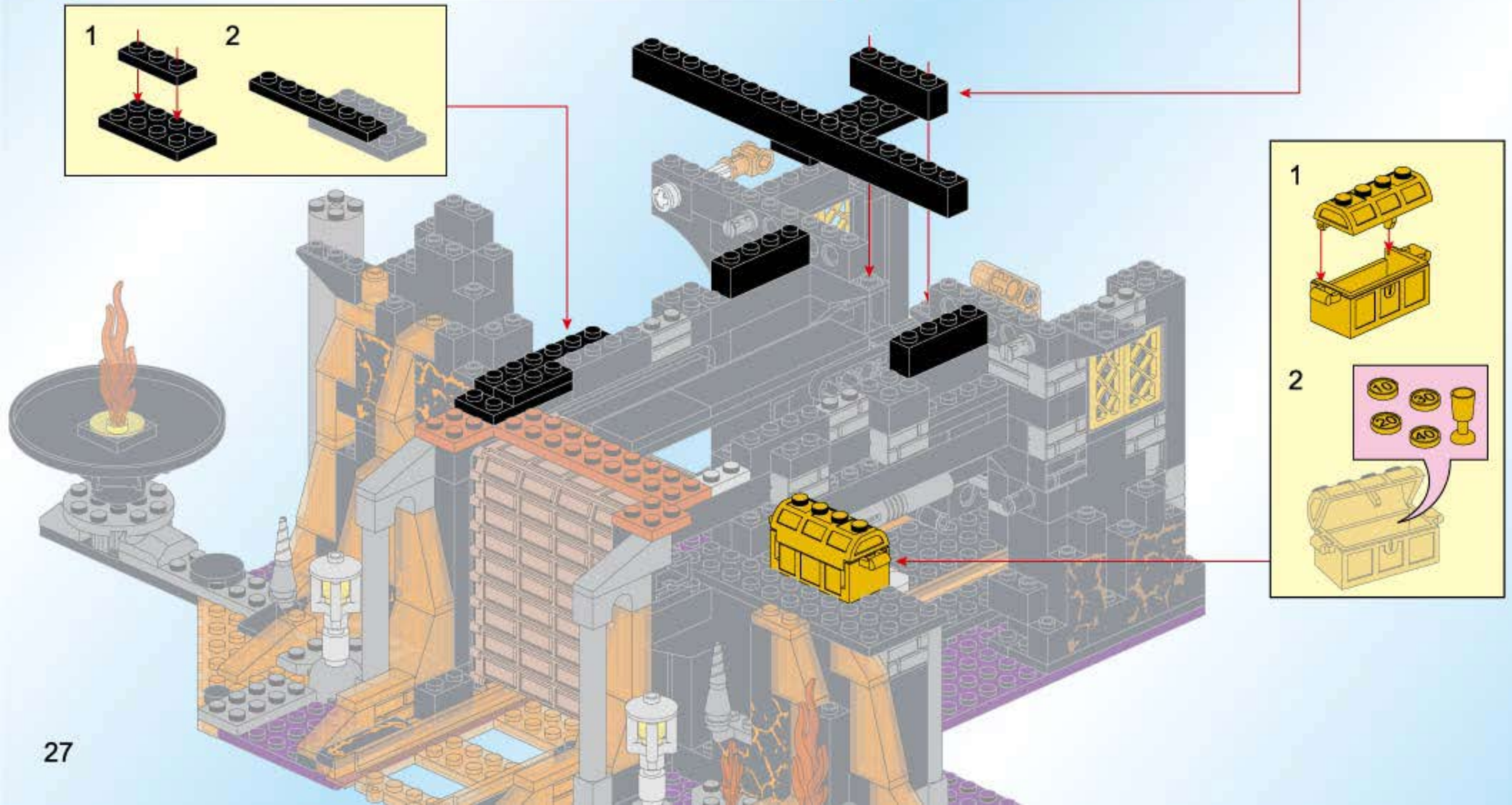
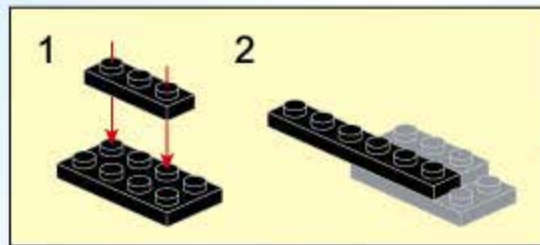
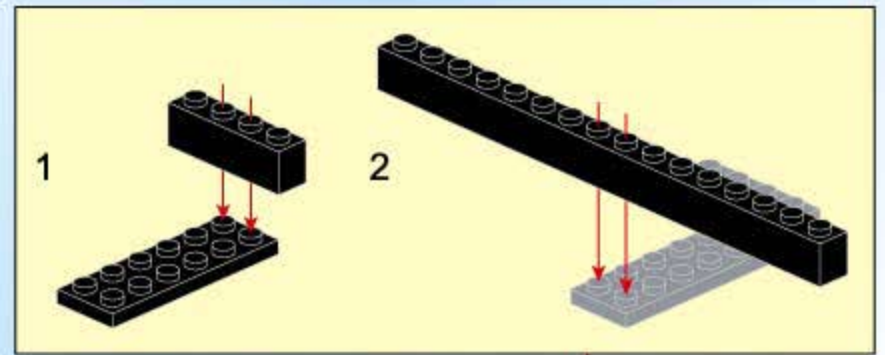
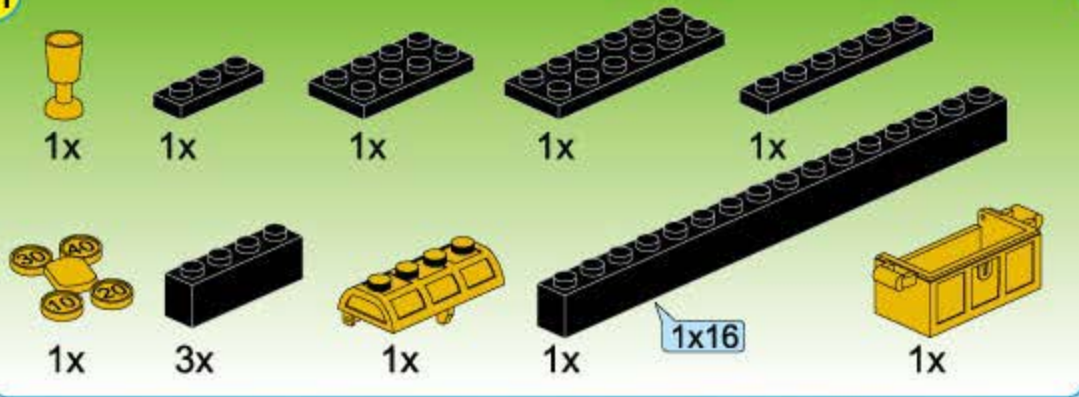

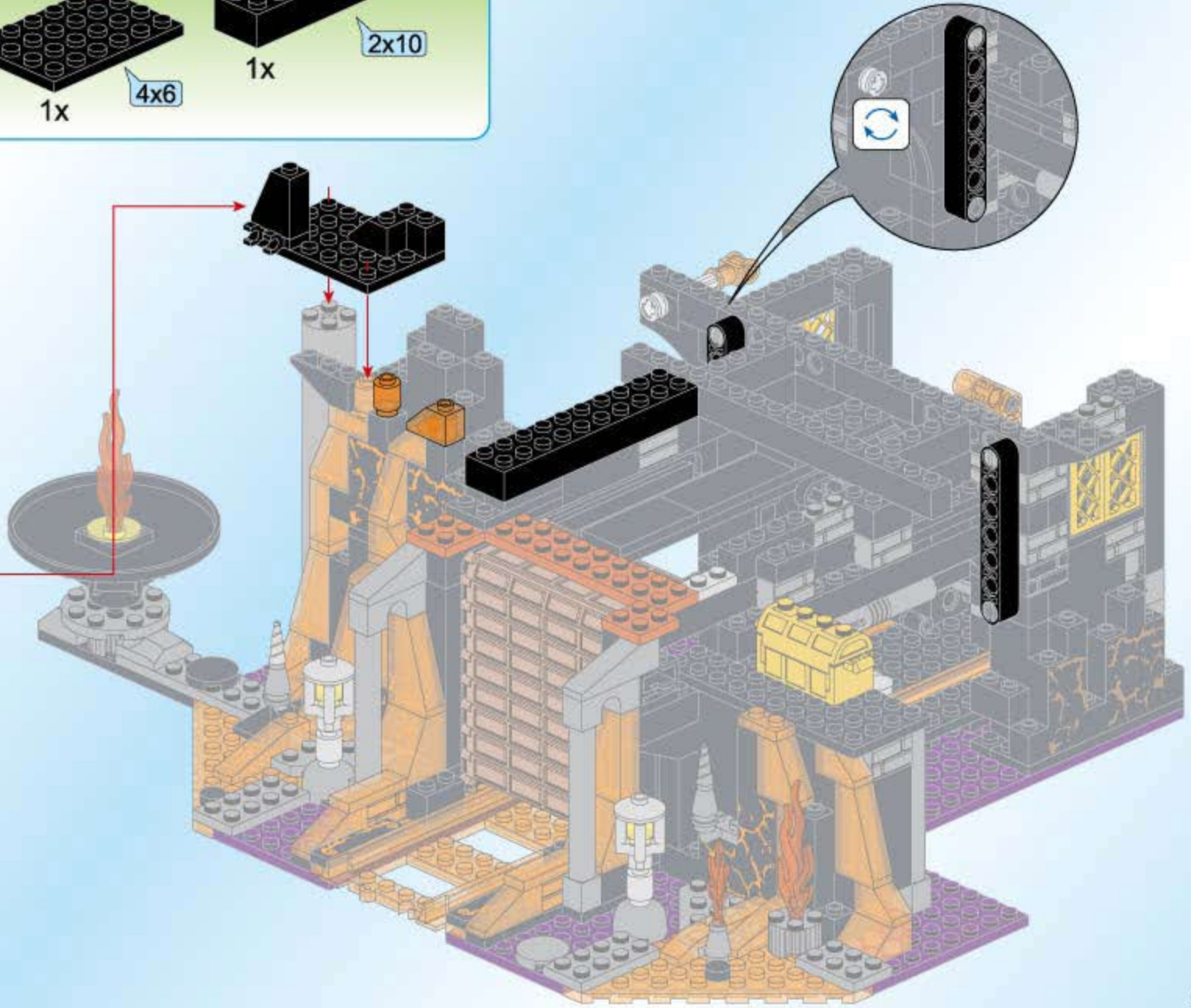
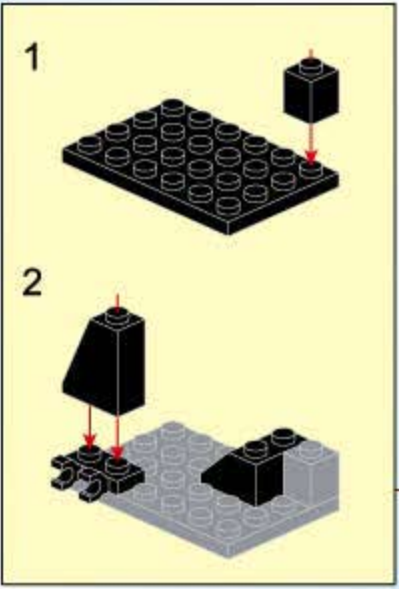
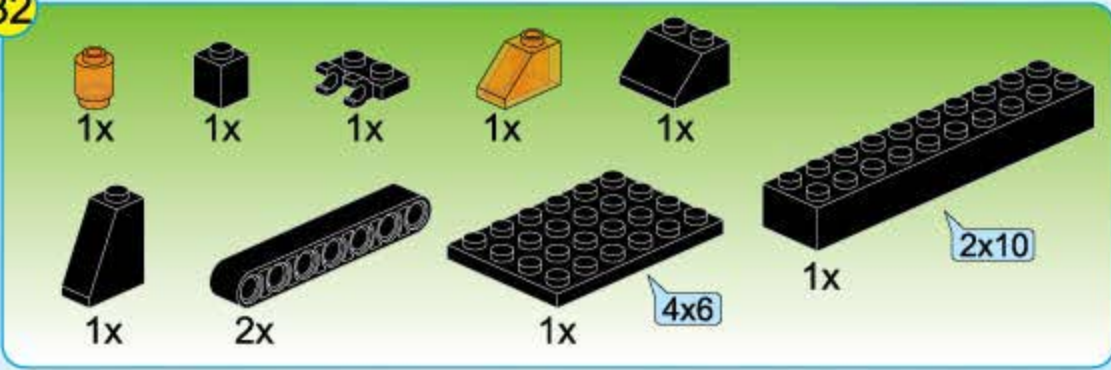



16x16

+



4

=

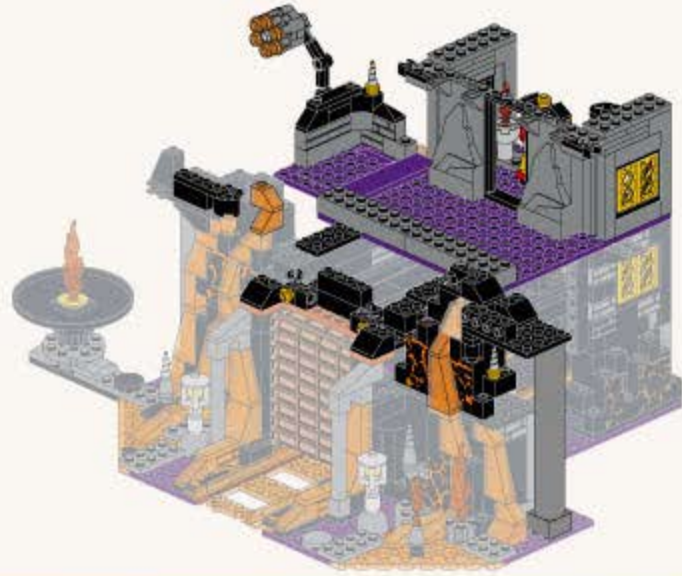

33

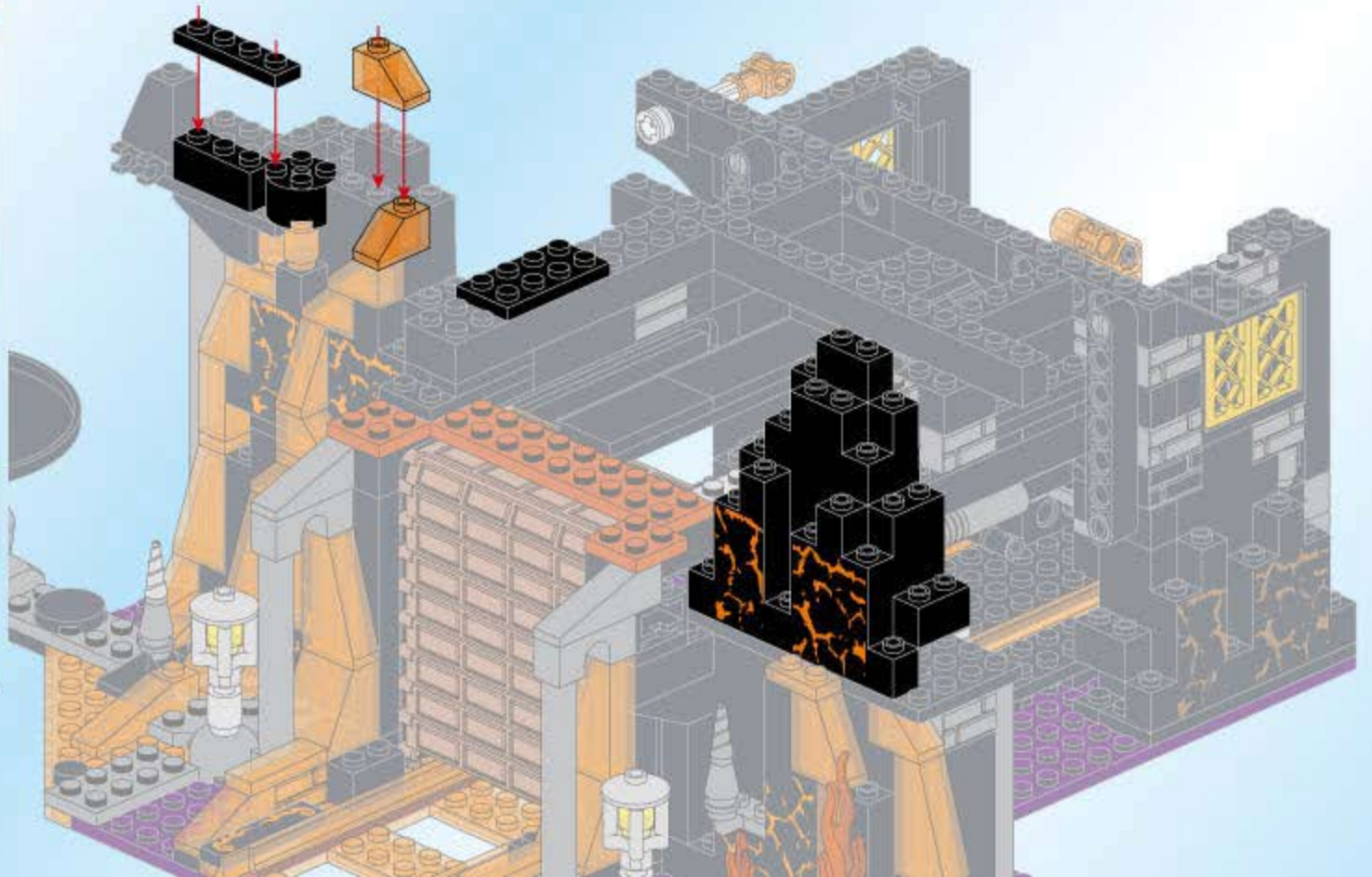
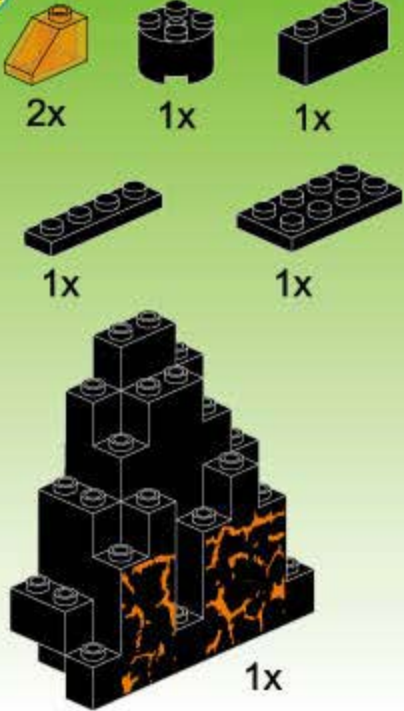

34

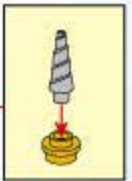
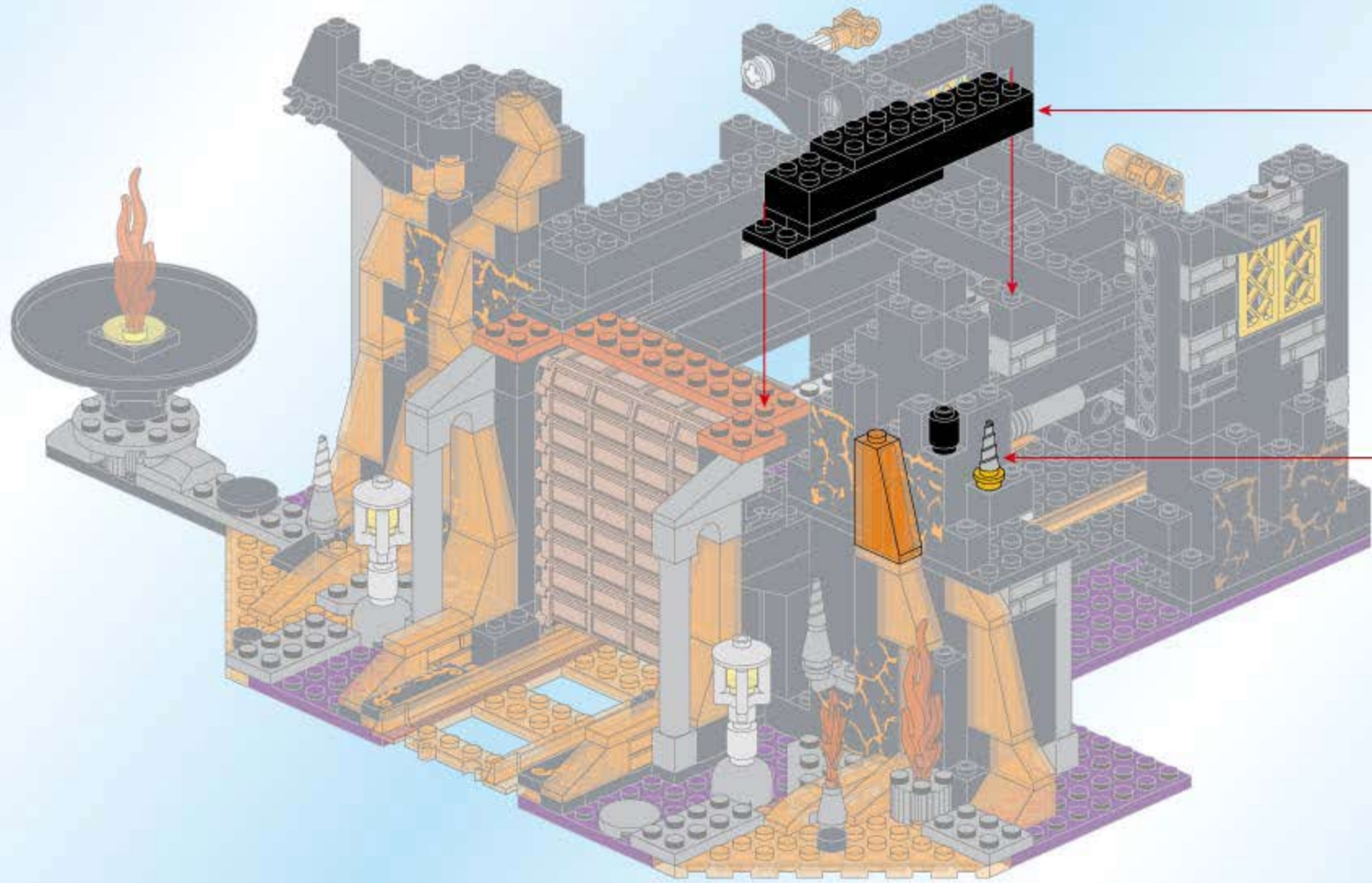
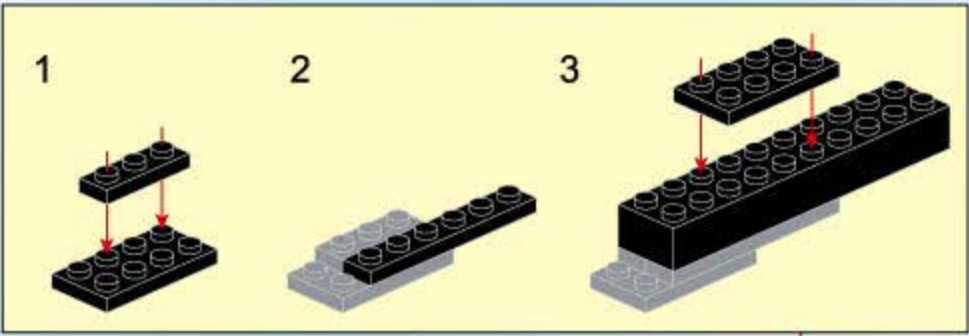
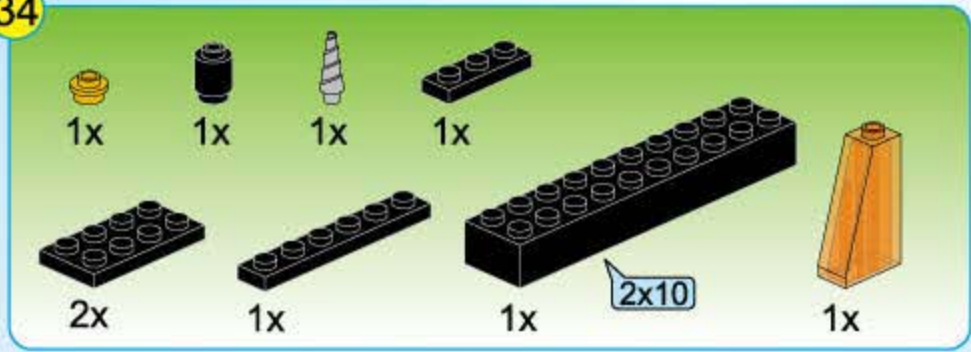

- 4x [Black Pin]
- 2x [Yellow Pin]
- 2x [Black Axle]
- 2x [Black 2x2 Technic Brick]

- 1x [Orange Technic Brick]
- 2x [Black 2x2 Technic Brick]
- 2x [Black 1x4 Technic Beam]
- 2x [Black 1x4 Technic Beam]

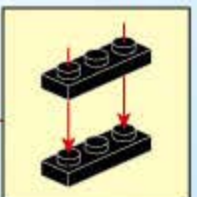
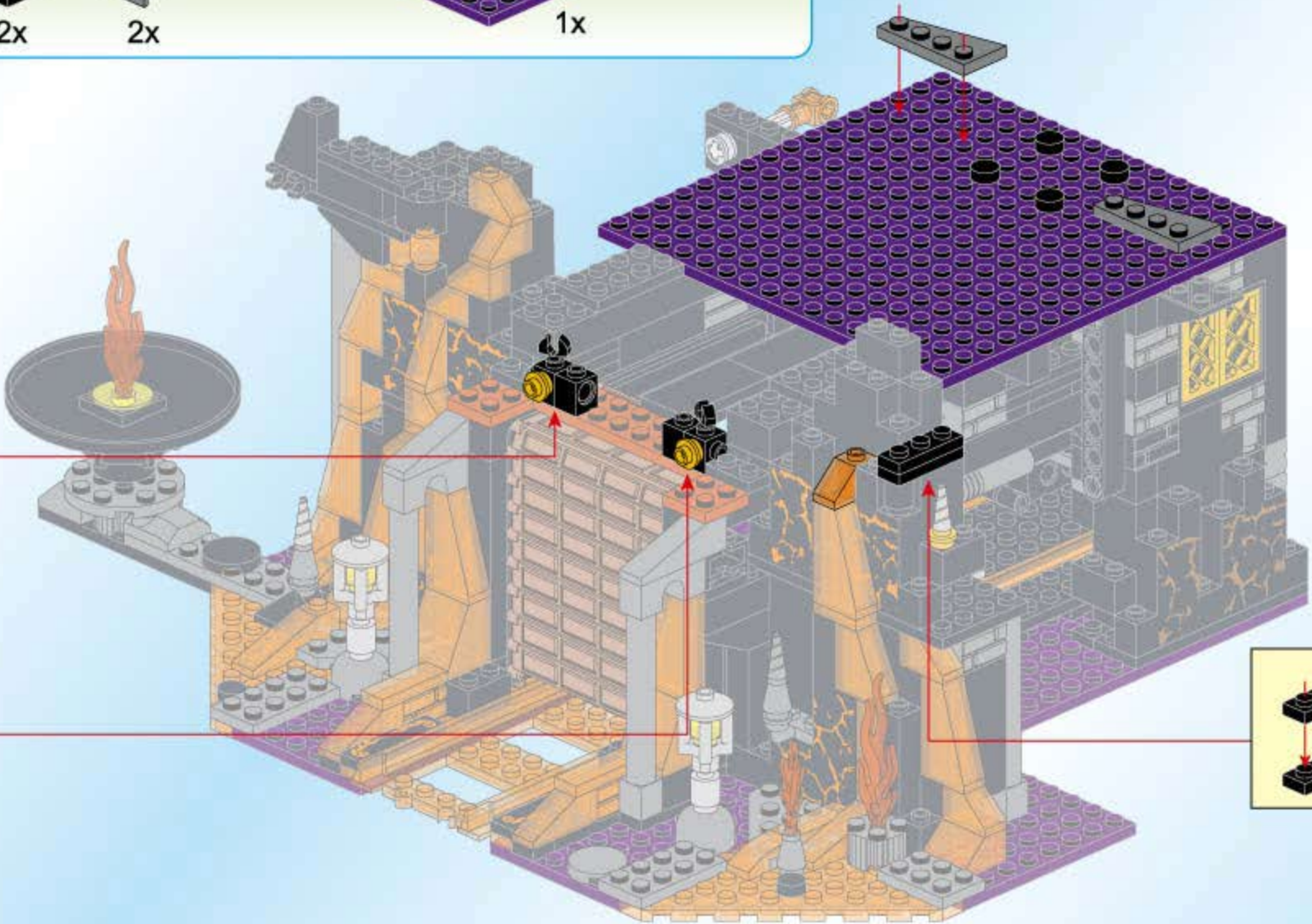
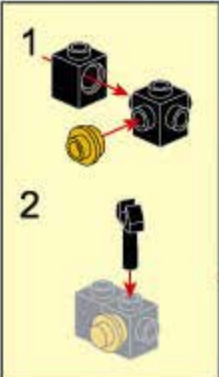
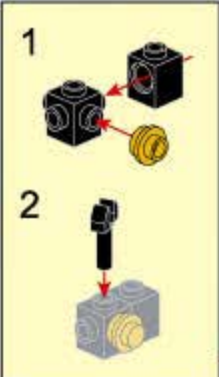
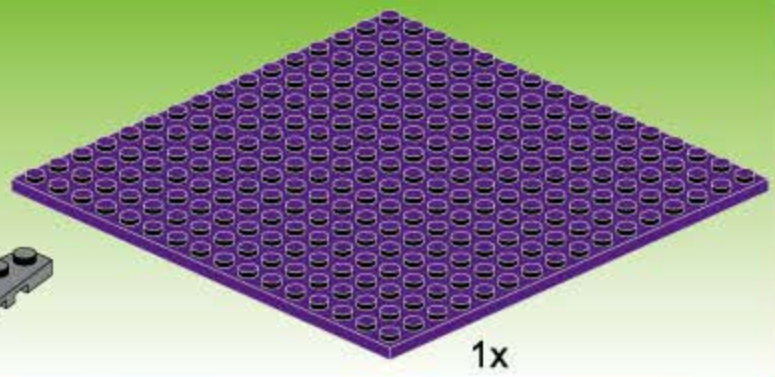

36

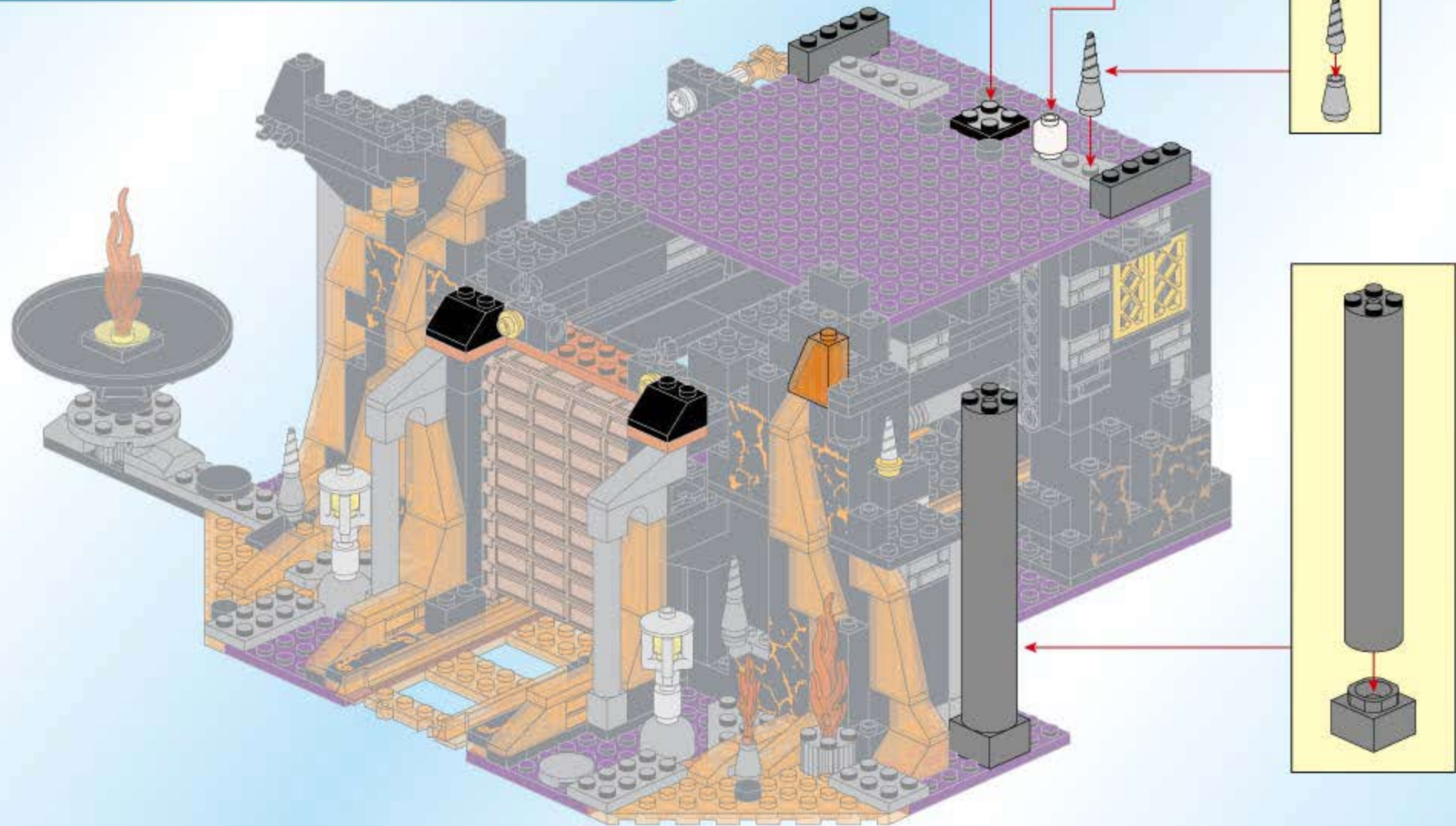
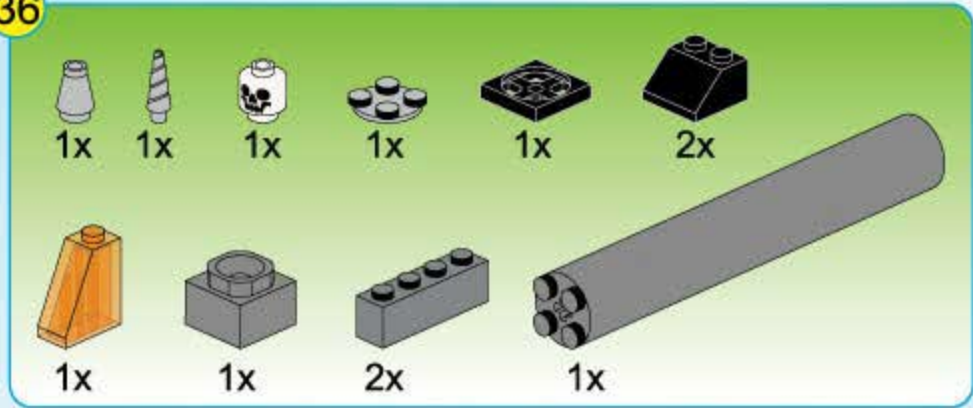

37

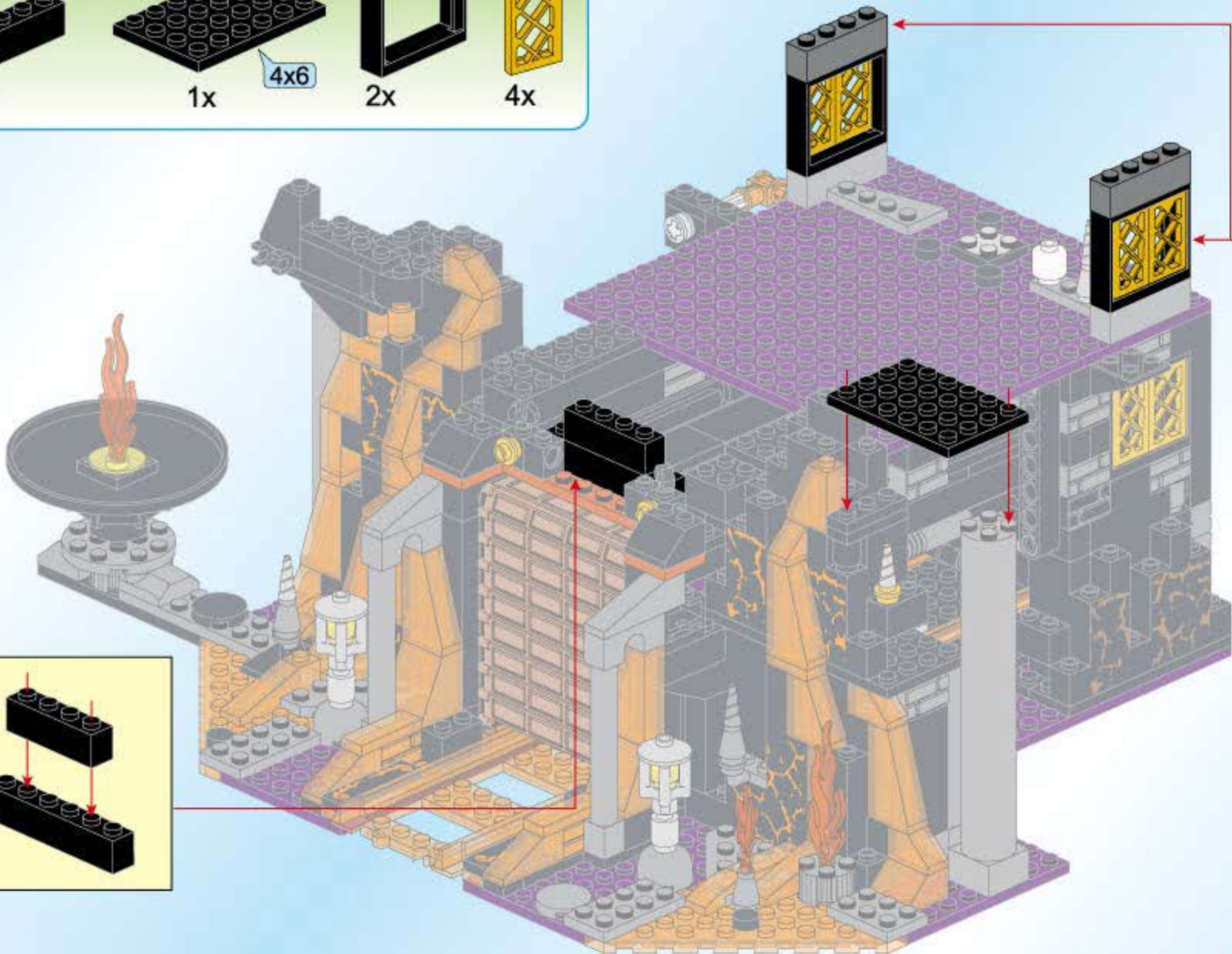
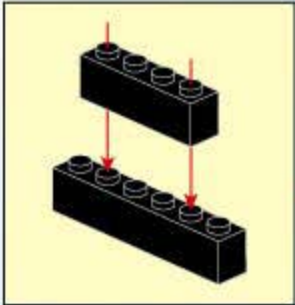
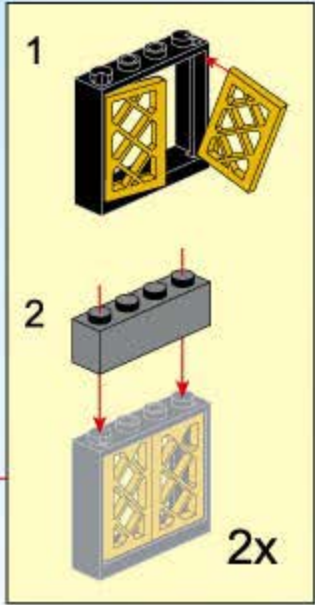
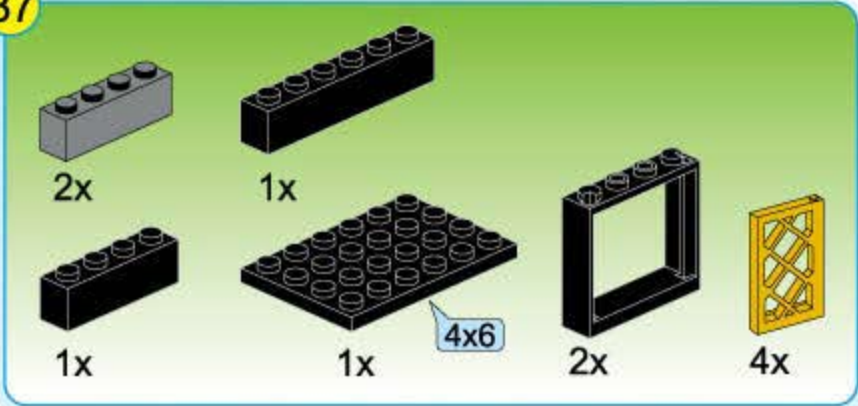

- 3x
- 4x
- 2x
- 2x
- 2x
- 1x
- 1x
- 2x
- 1x
- 2x
- 2x
- 1x
- 2x
- 1x
- 1x
- 1x
- 2x

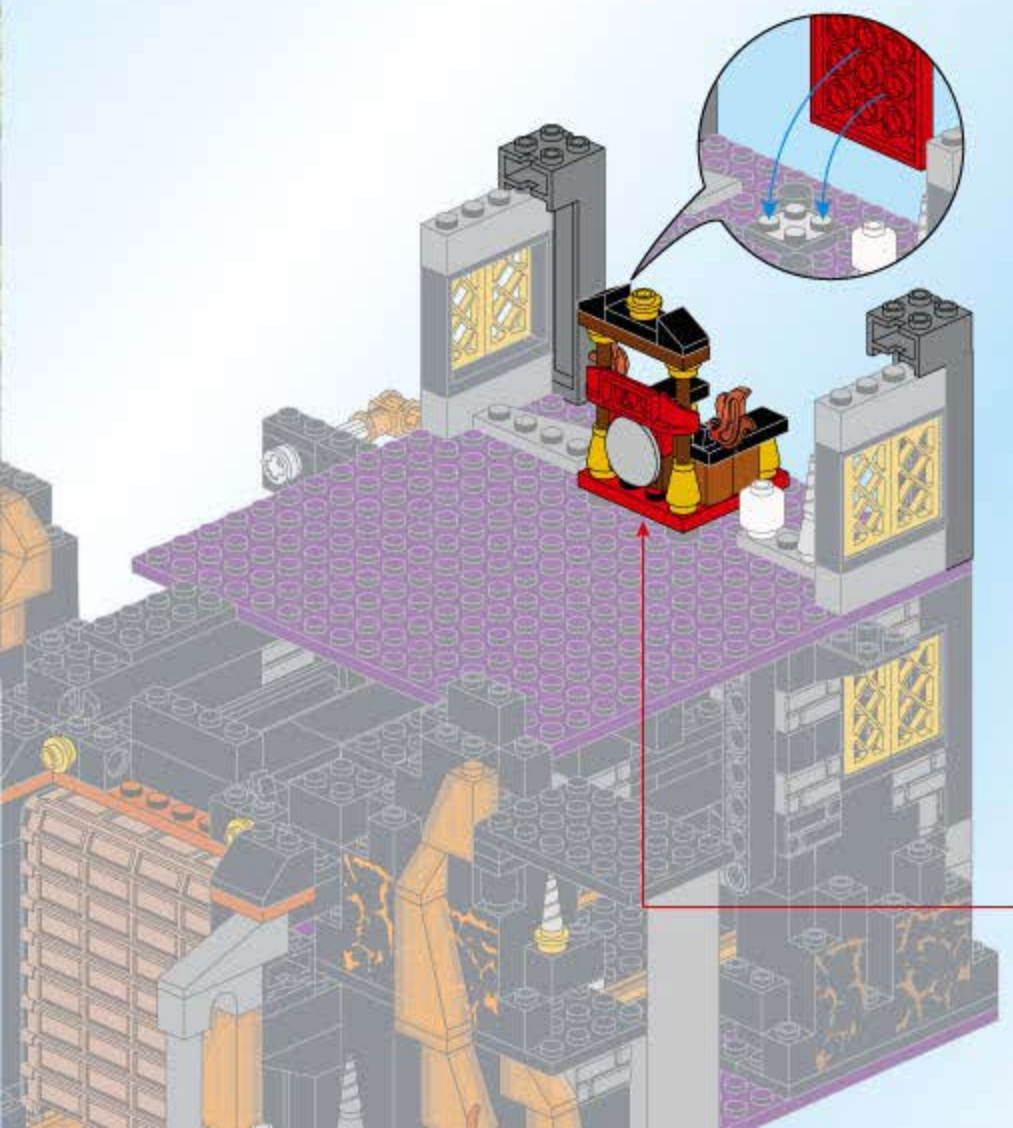

1

2

3

4

5

6

1

2

1

2

- 1x [Grey 1-hole Technic Pin]
- 1x [Grey 1-hole Technic Bush]
- 2x [Grey 1-hole Technic Plate]
- 2x [Grey 1-hole Technic Long Pin]
- 1x [Black 1-hole Technic Brick]
- 1x [Black 1-hole Technic Sloped Brick]
- 1x [Red Flame Piece]
- 2x [Grey 1-hole Technic Long Pin]

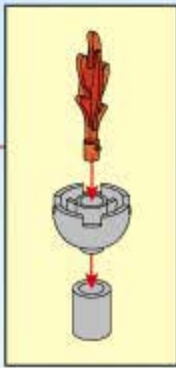
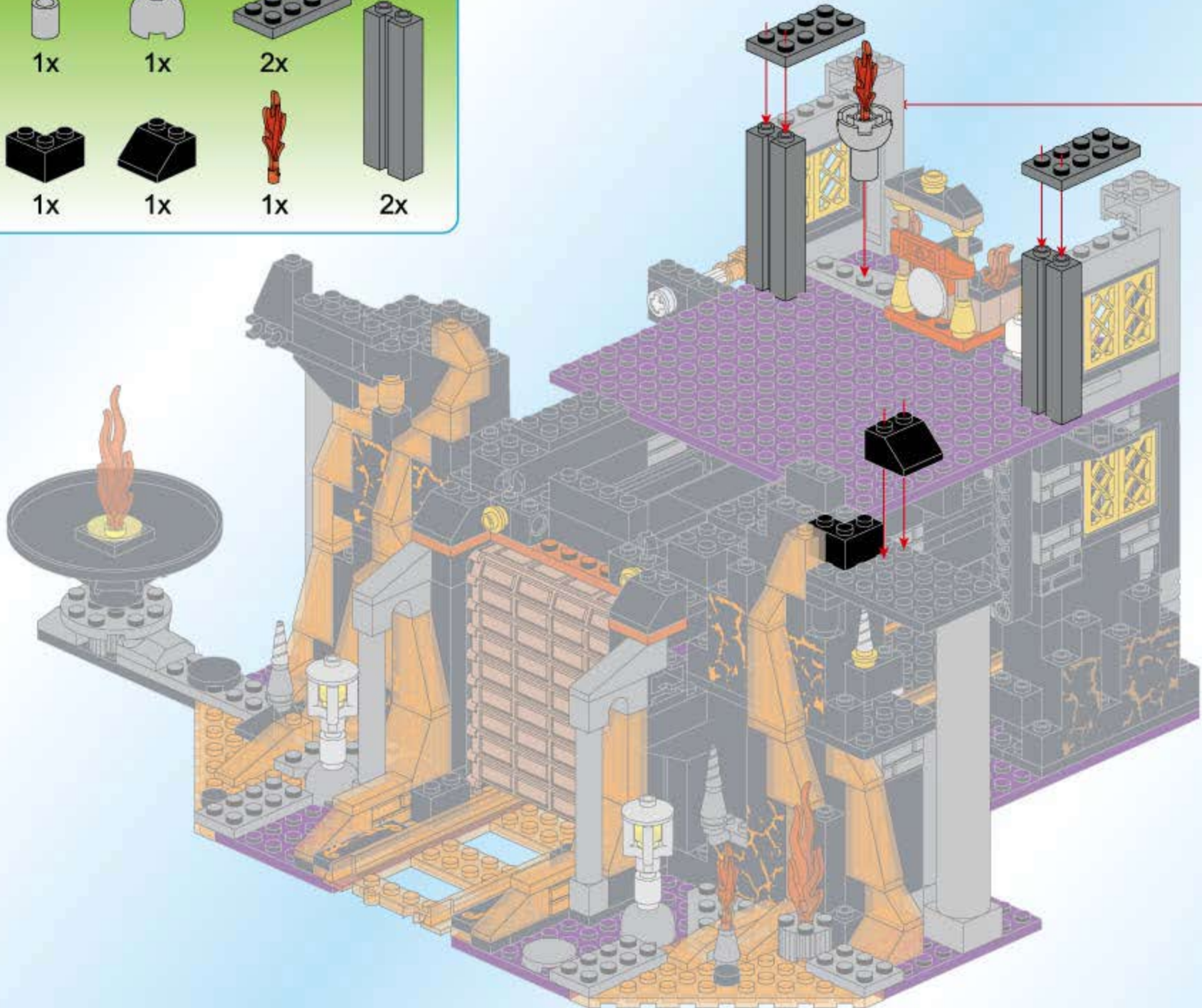

41

- 6x 
- 1x 
- 1x 
- 1x 
- 1x 
- 1x 
- 1x 
- 1x 

 2 **1:1**

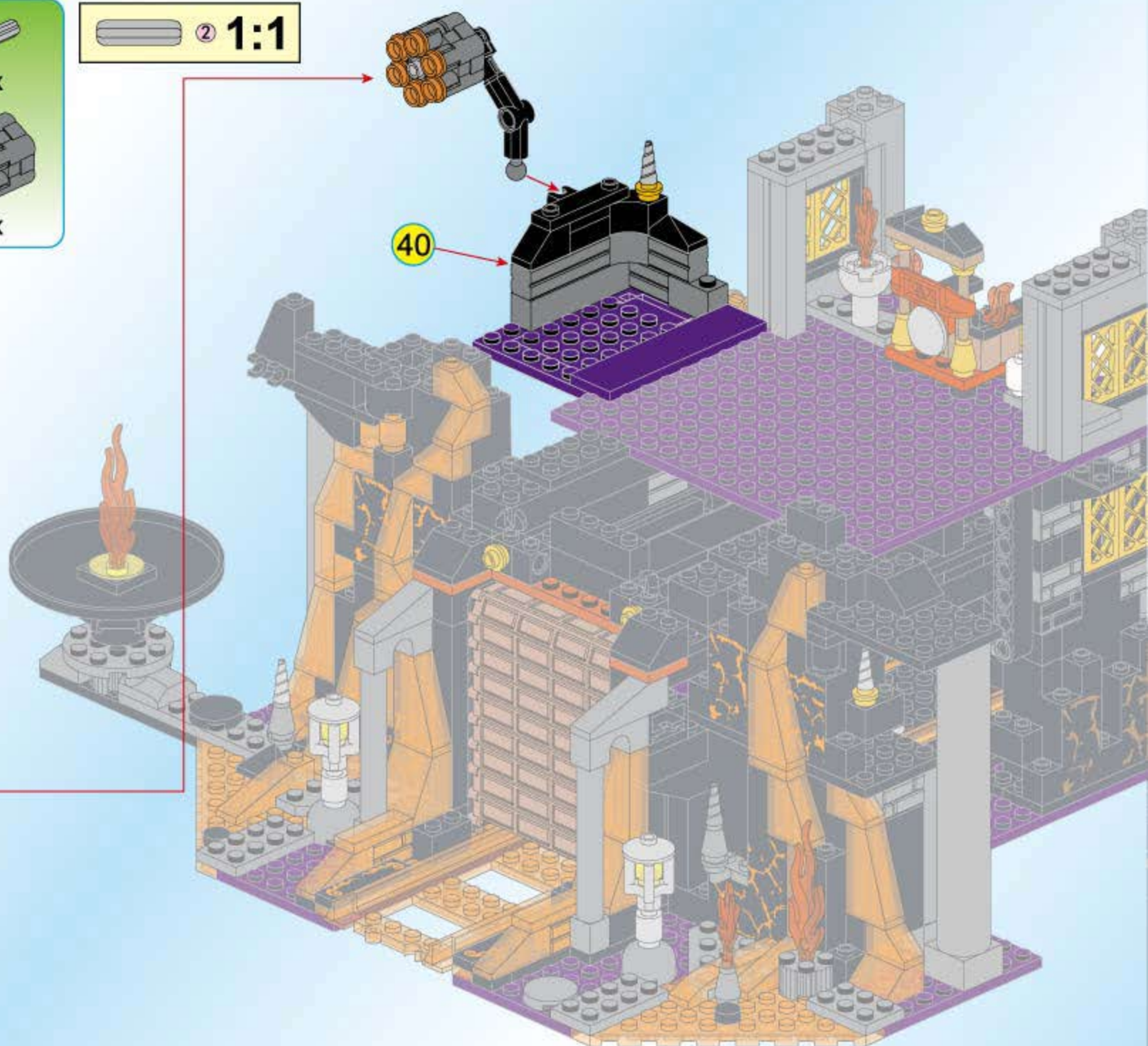
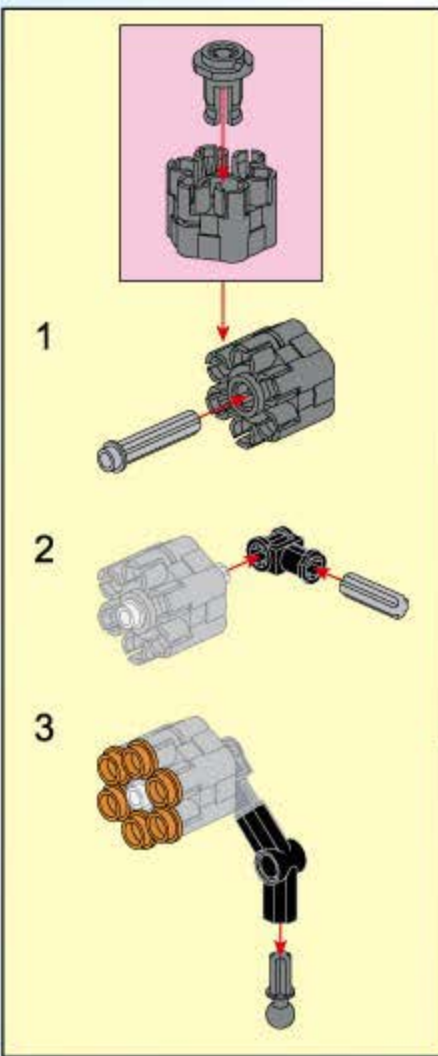

1x 1x 1x 2x

1x 1x 2x

4x 2x 2x8

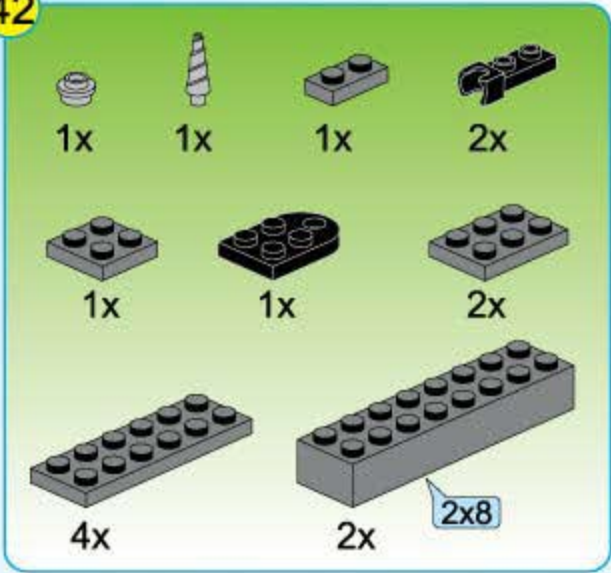

1 2

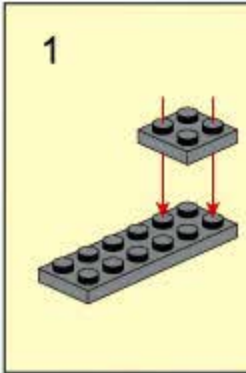

2

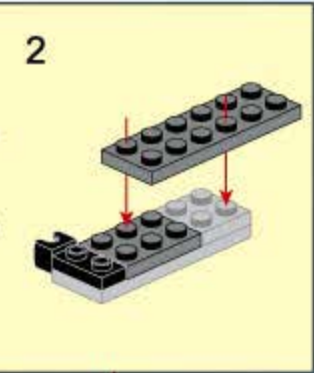

1 2 3

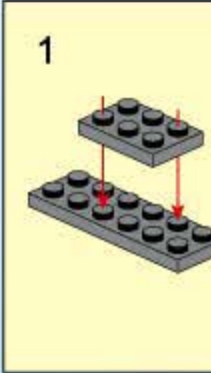

2

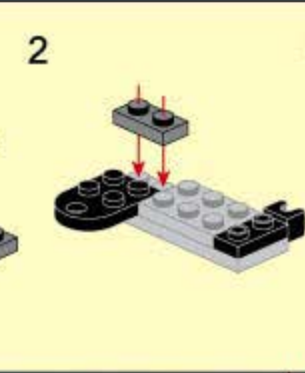

3

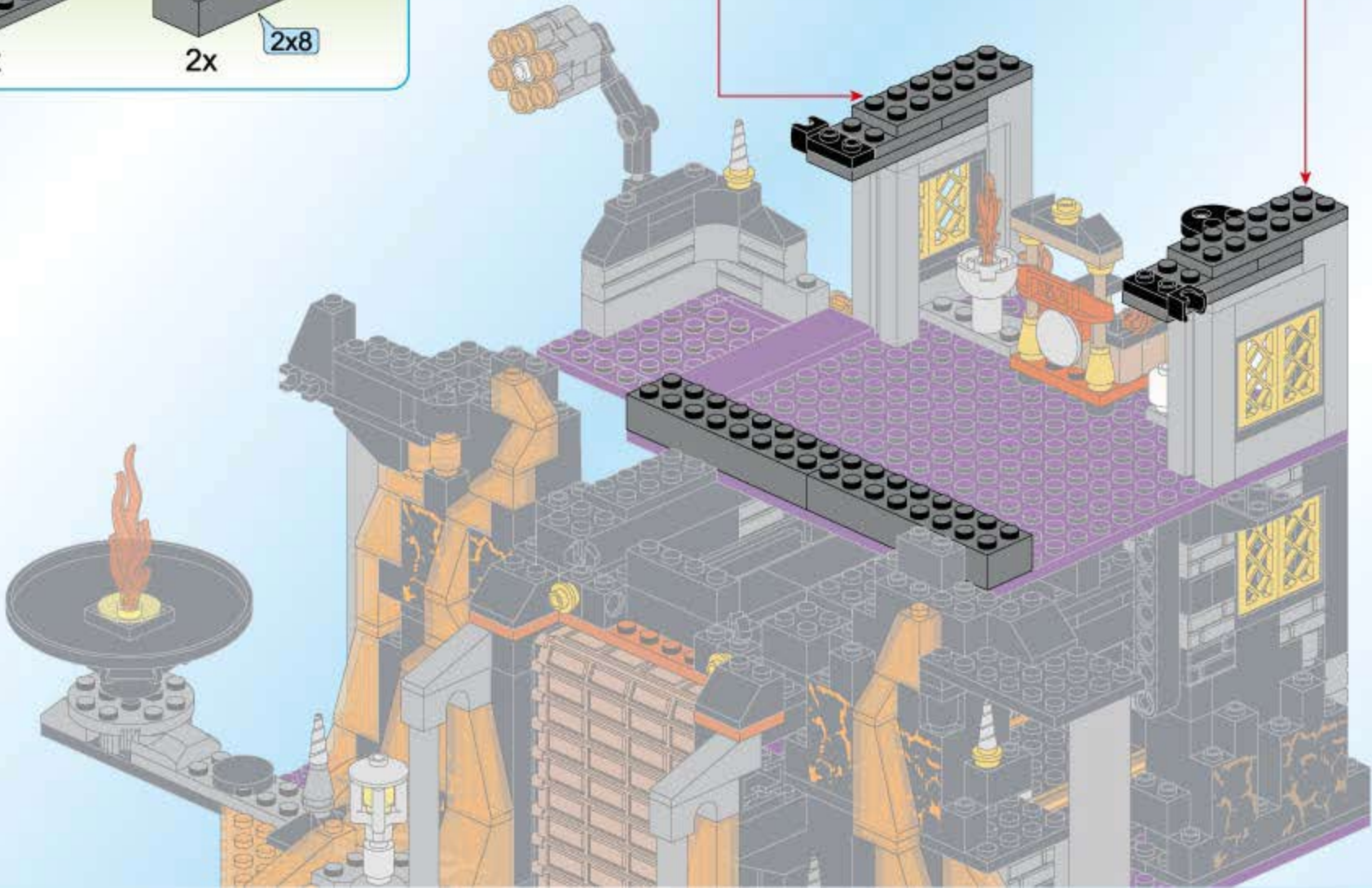
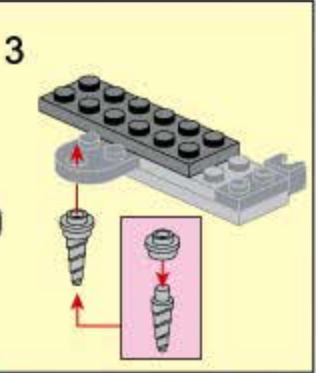

The main assembly diagram shows a complex LEGO structure. Red arrows from the sub-steps point to the locations where the parts should be attached. The structure features a purple floor, grey walls, and various mechanical elements like a crane and a furnace. The background is a light blue gradient.

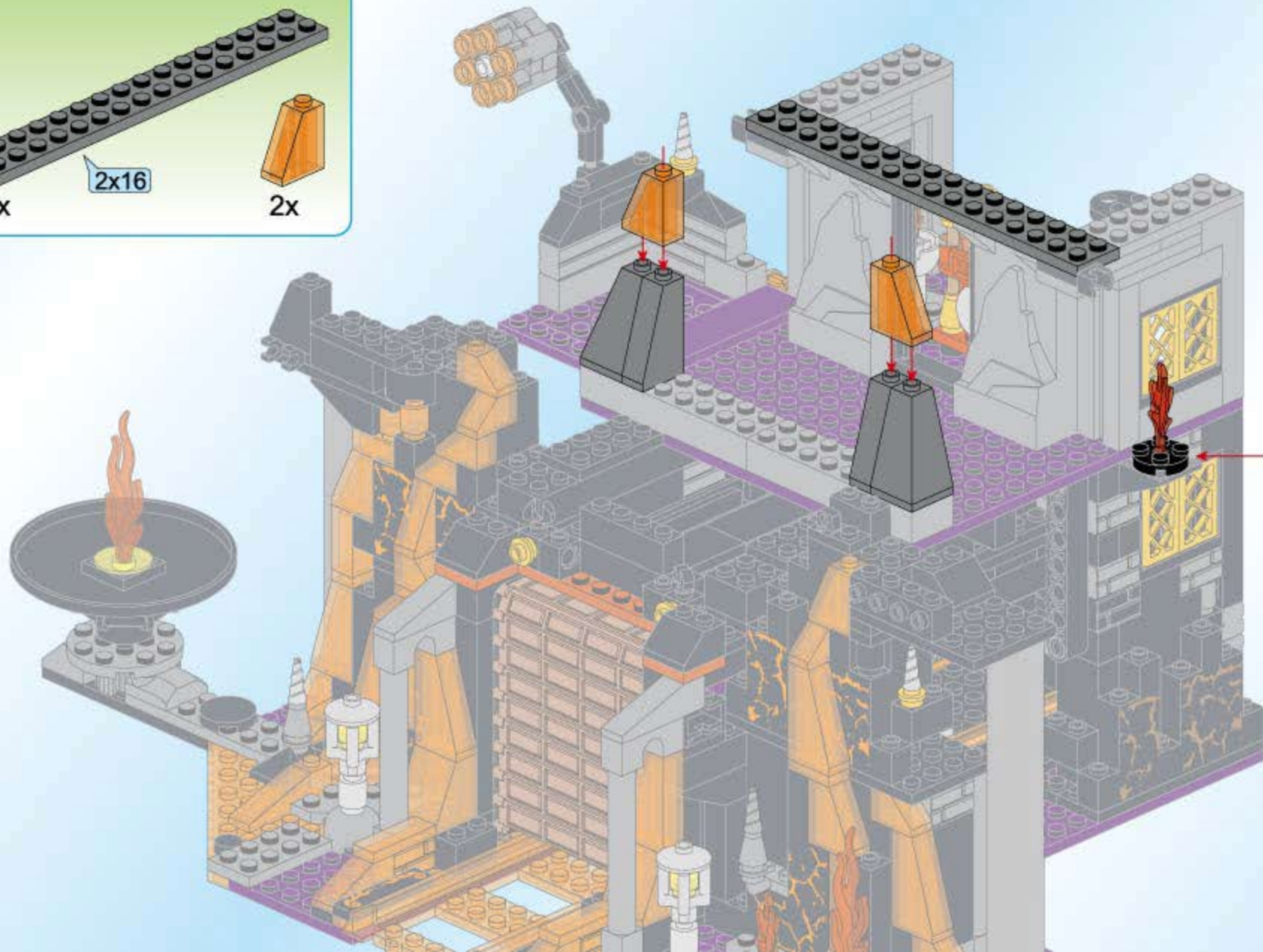
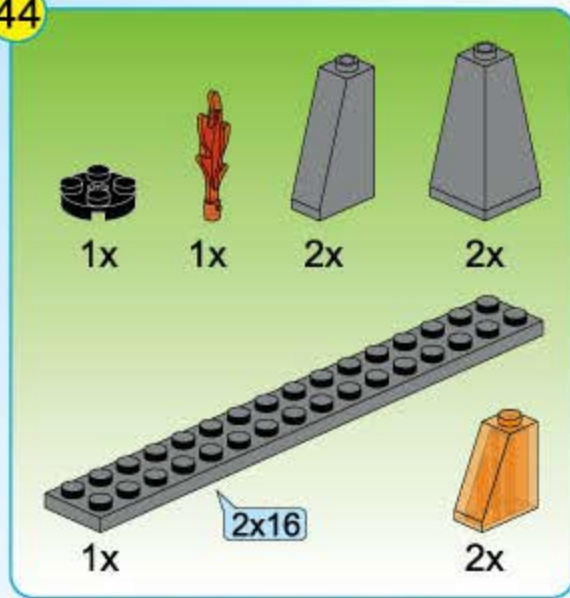

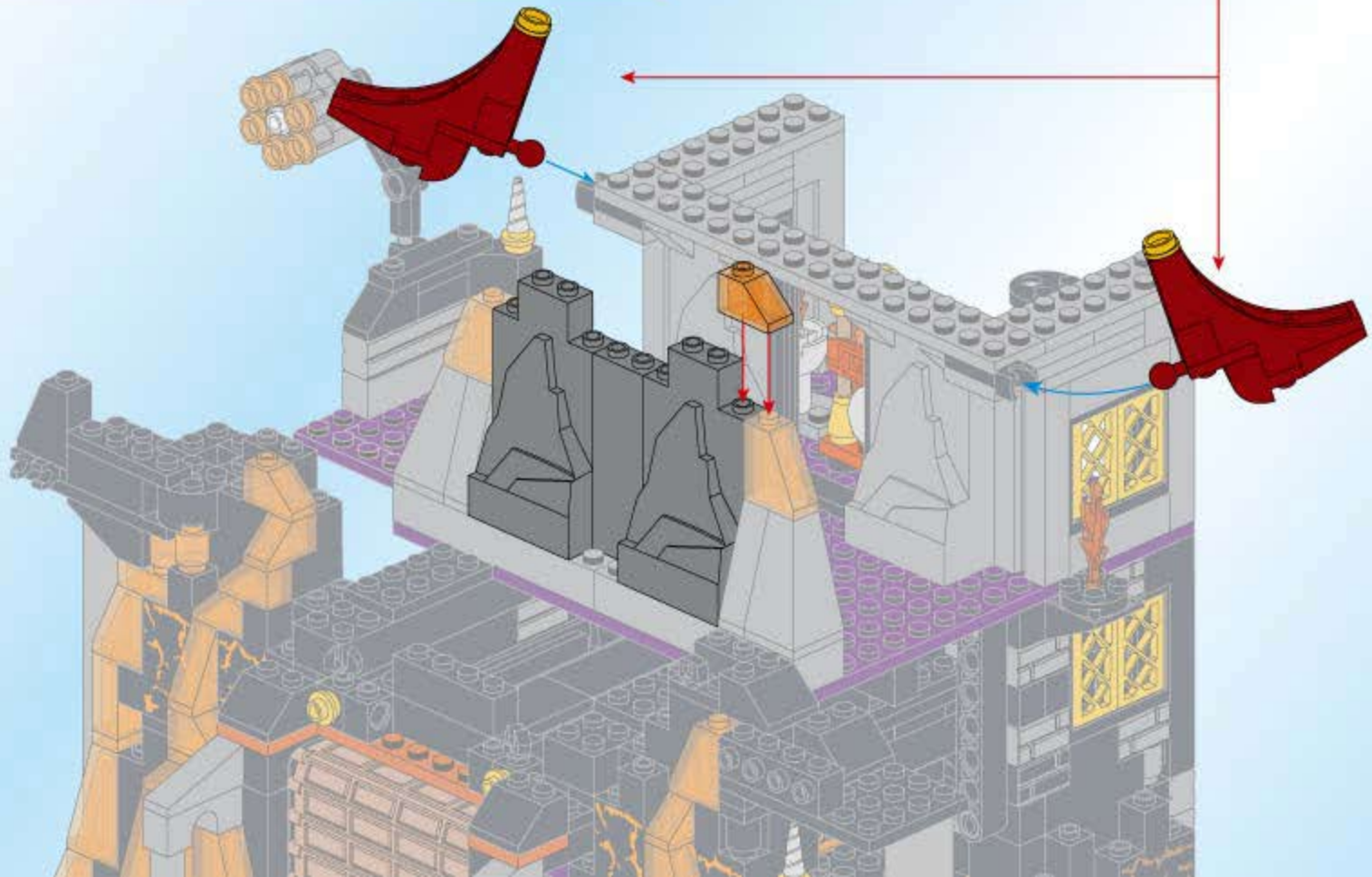
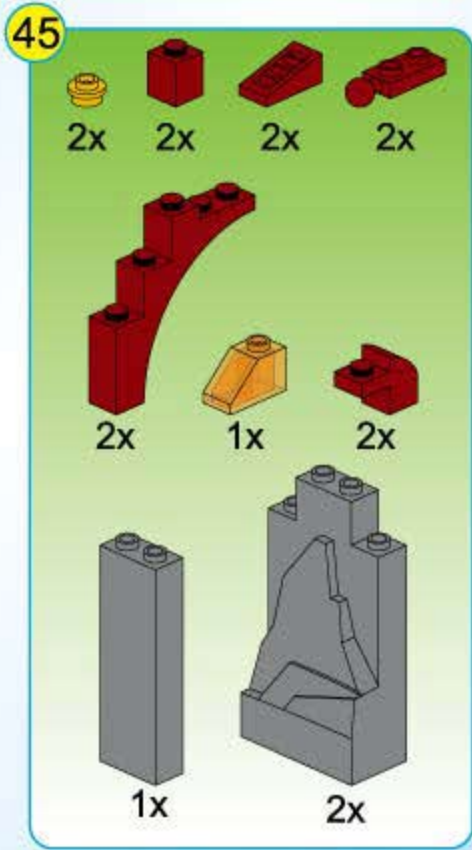
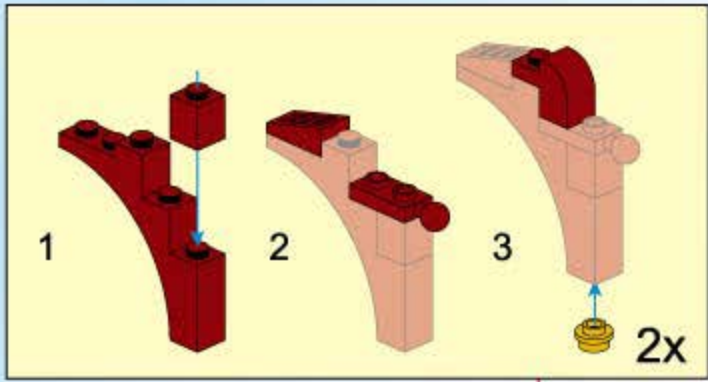
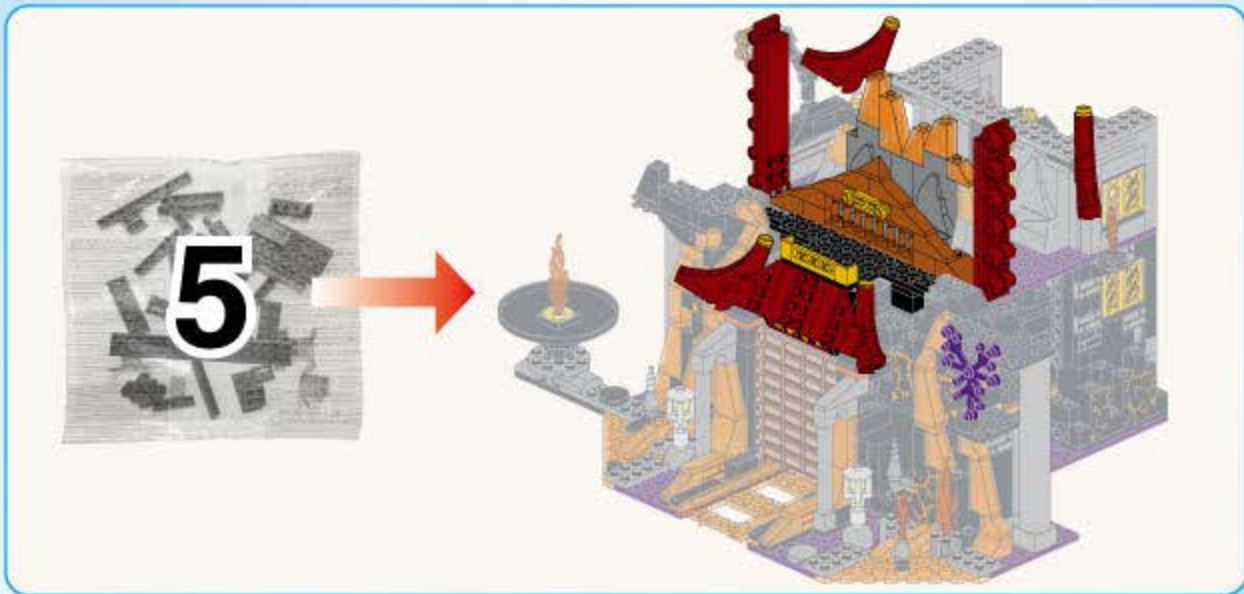

46



2x



2x

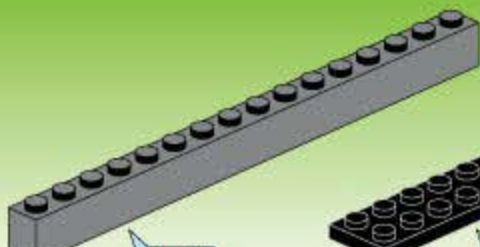

2x

1x16



2x

2x10



2x

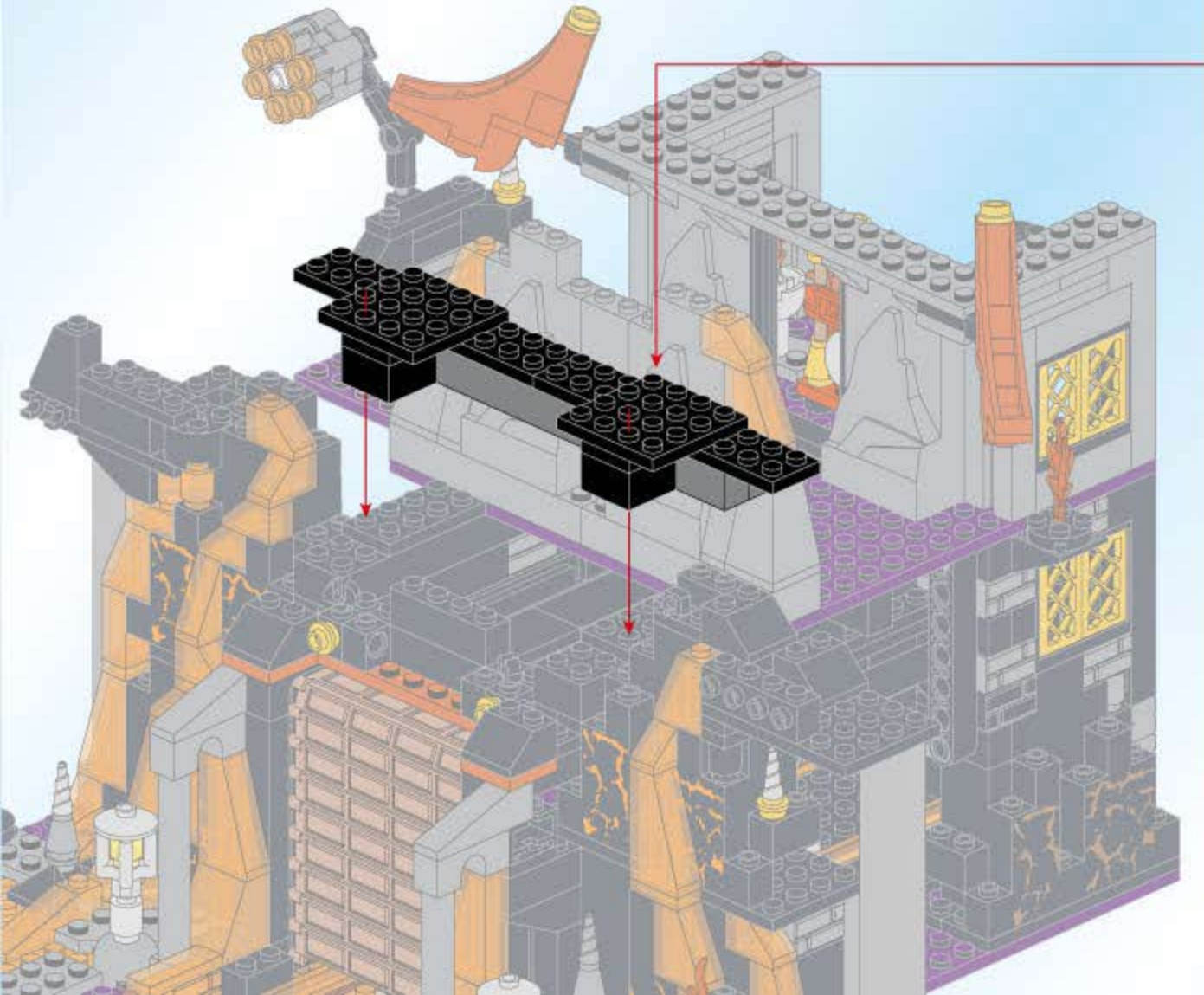

1



2

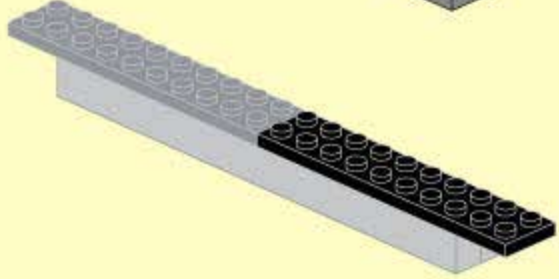

3

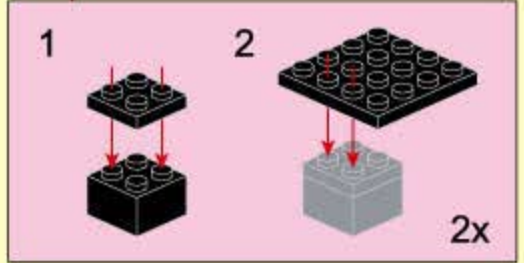
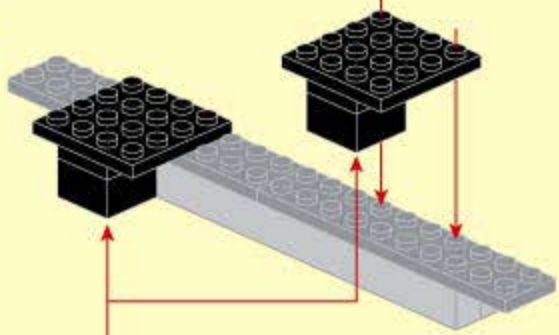

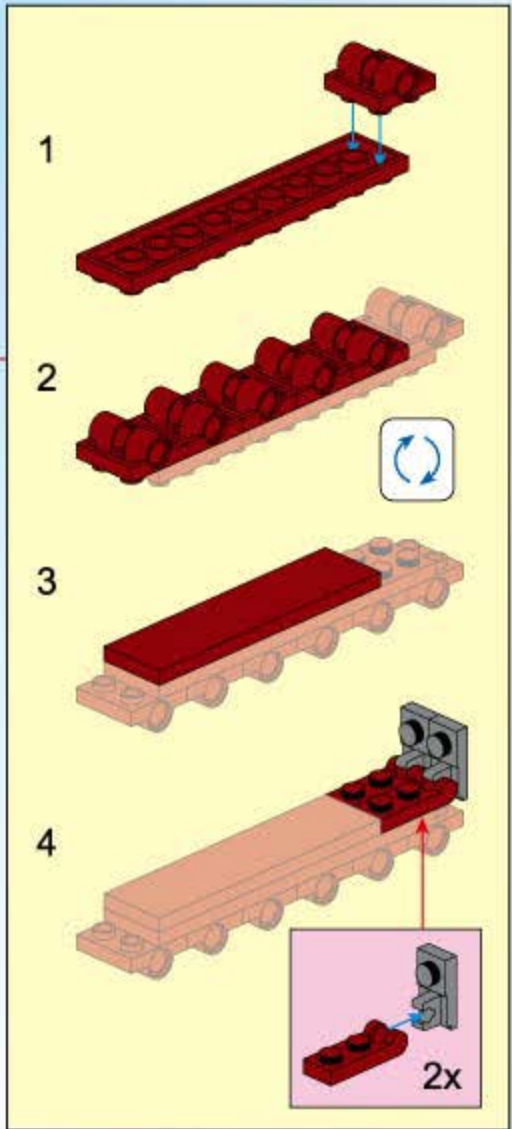
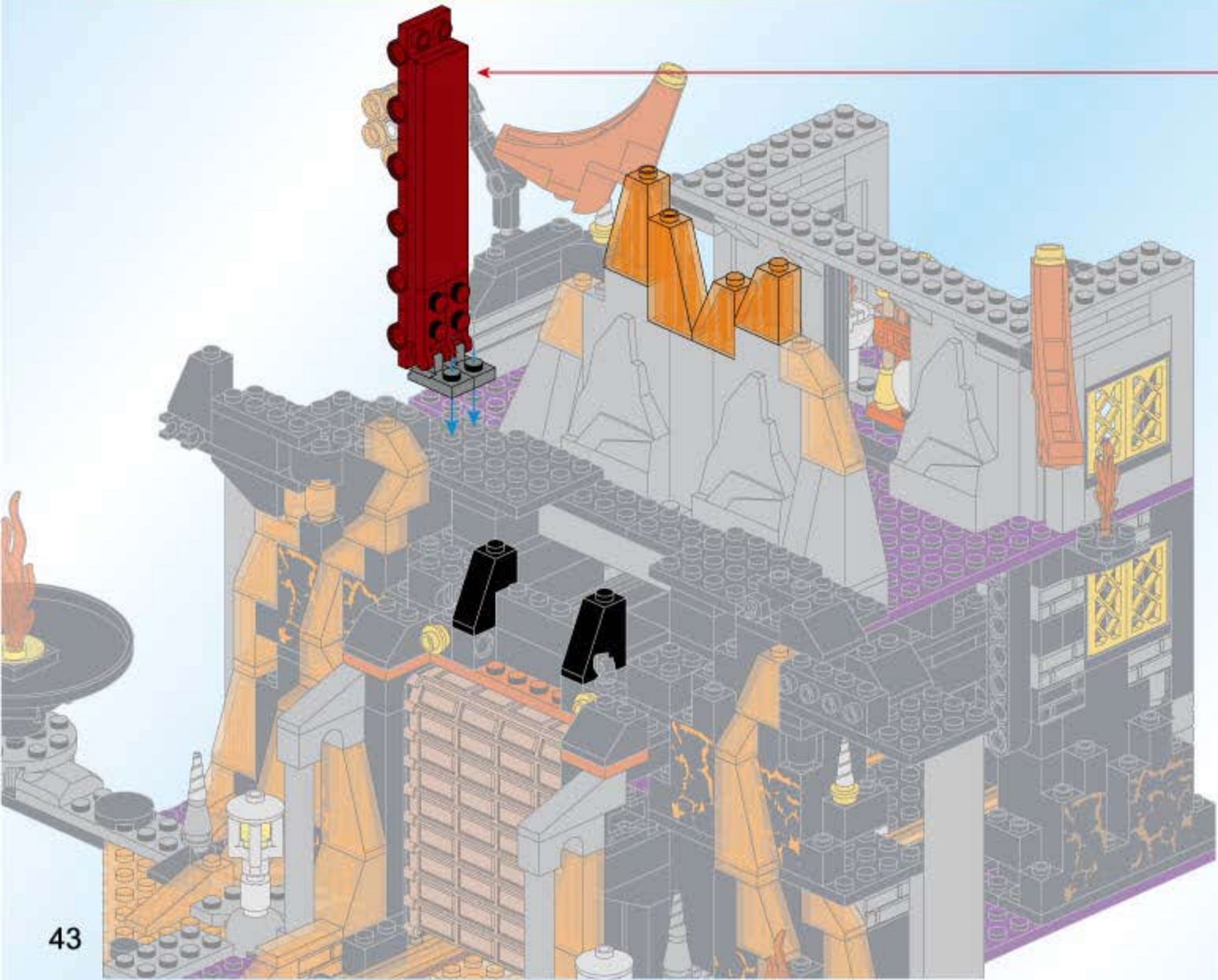
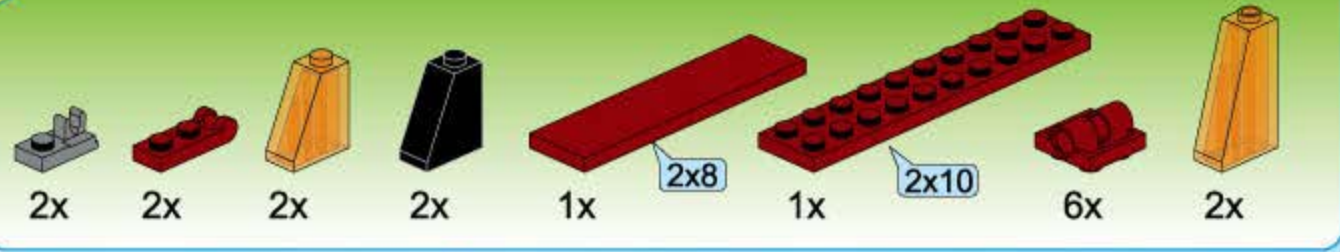

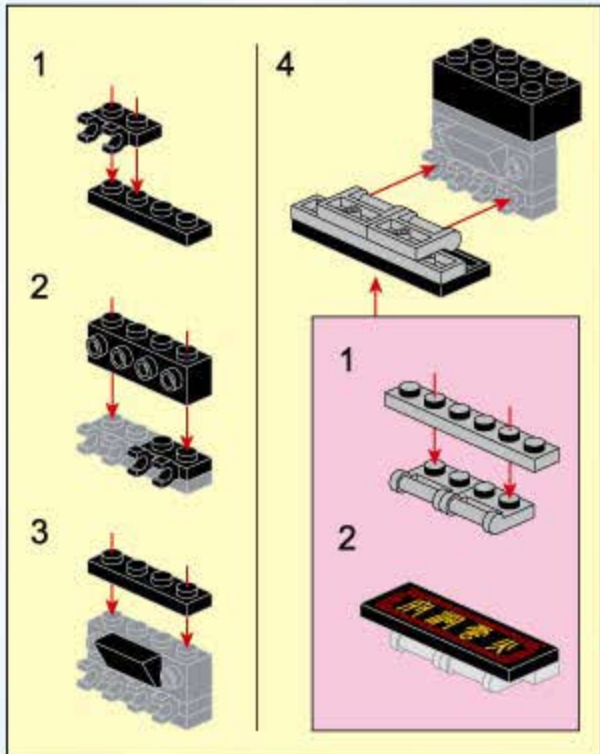
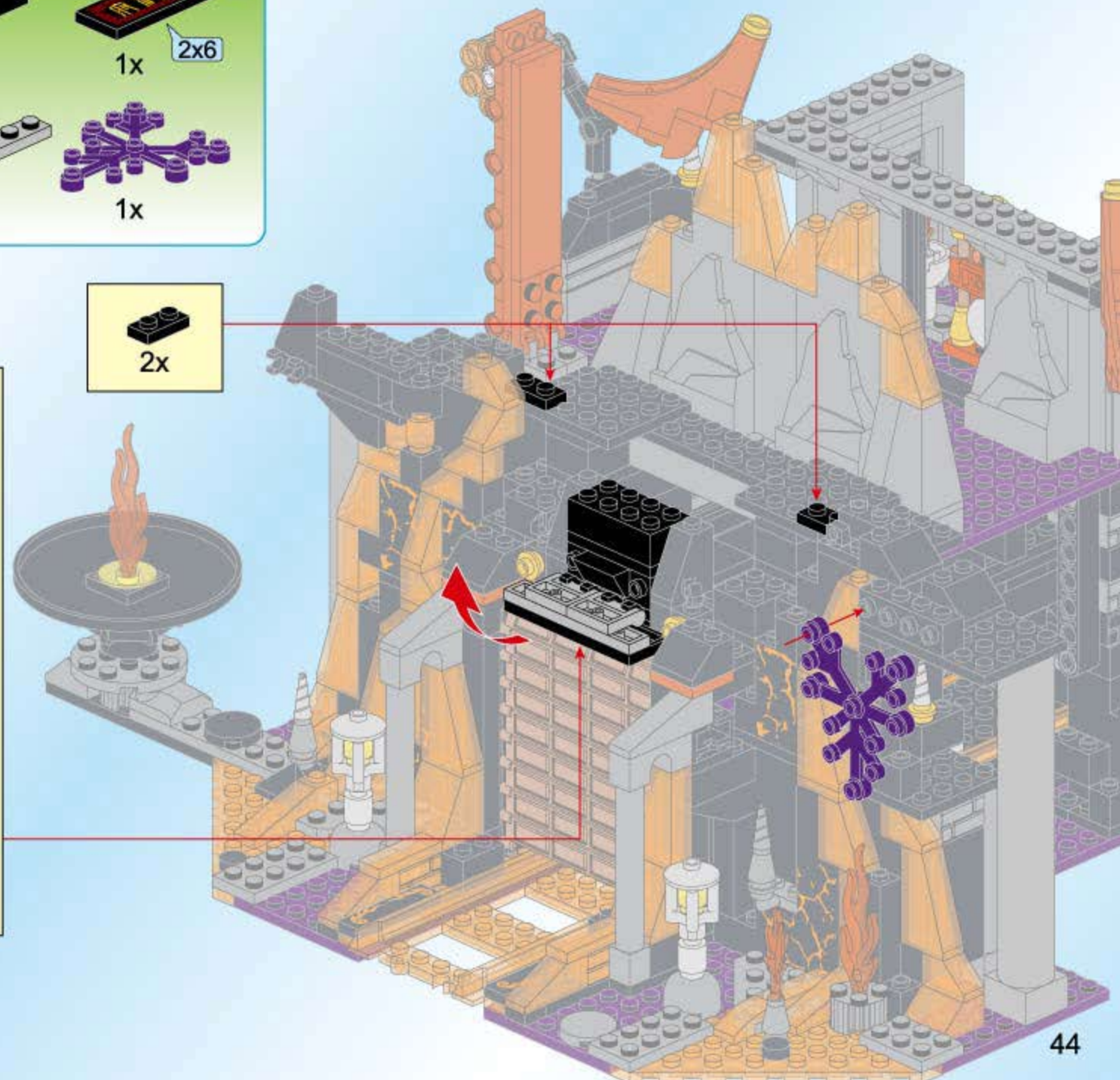
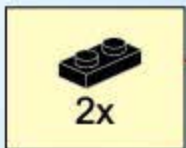
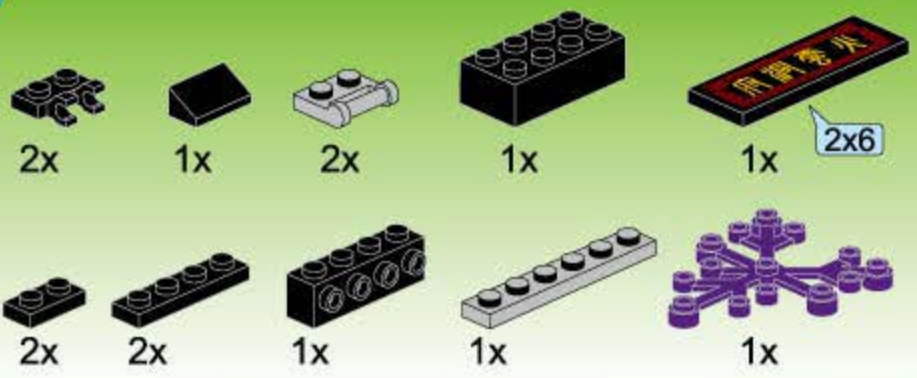

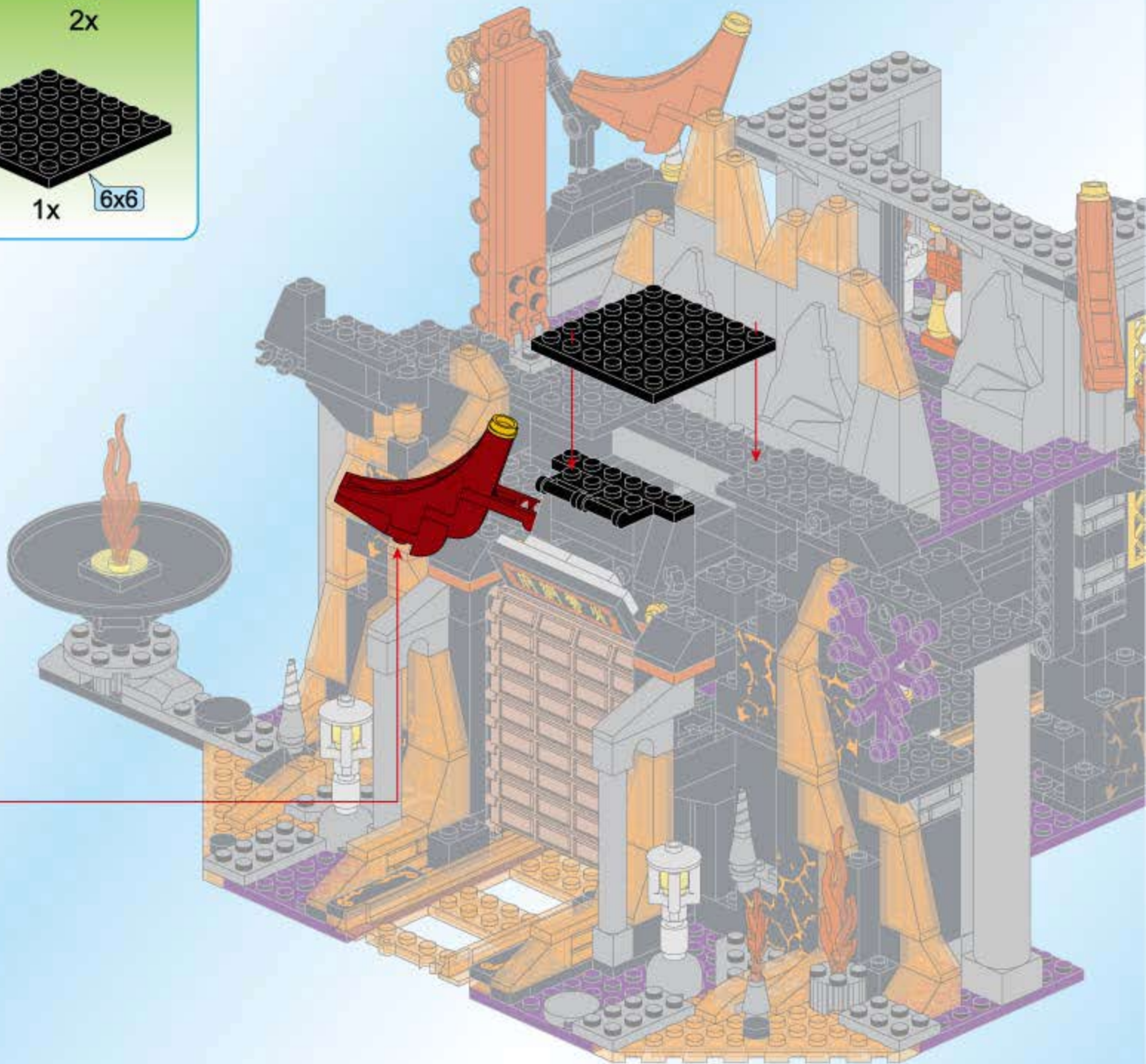
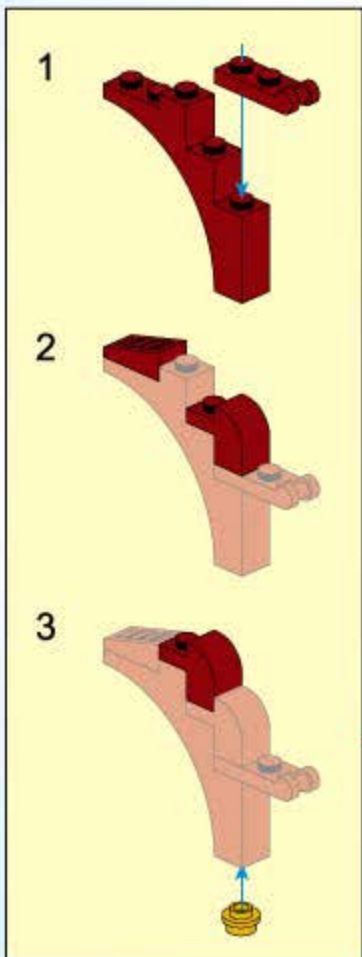
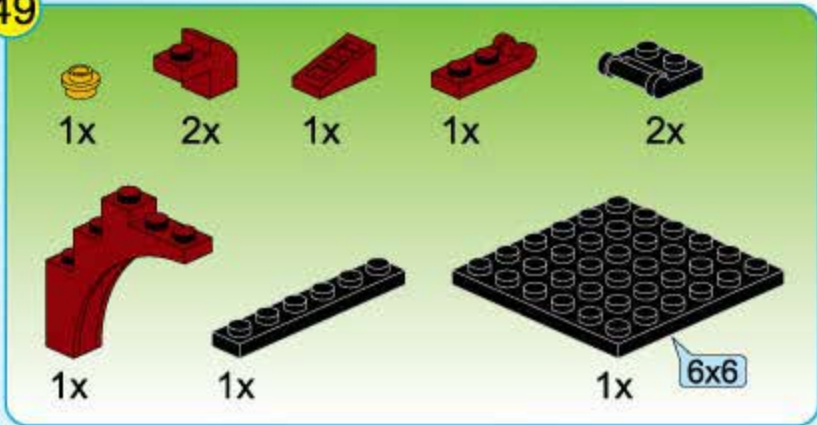

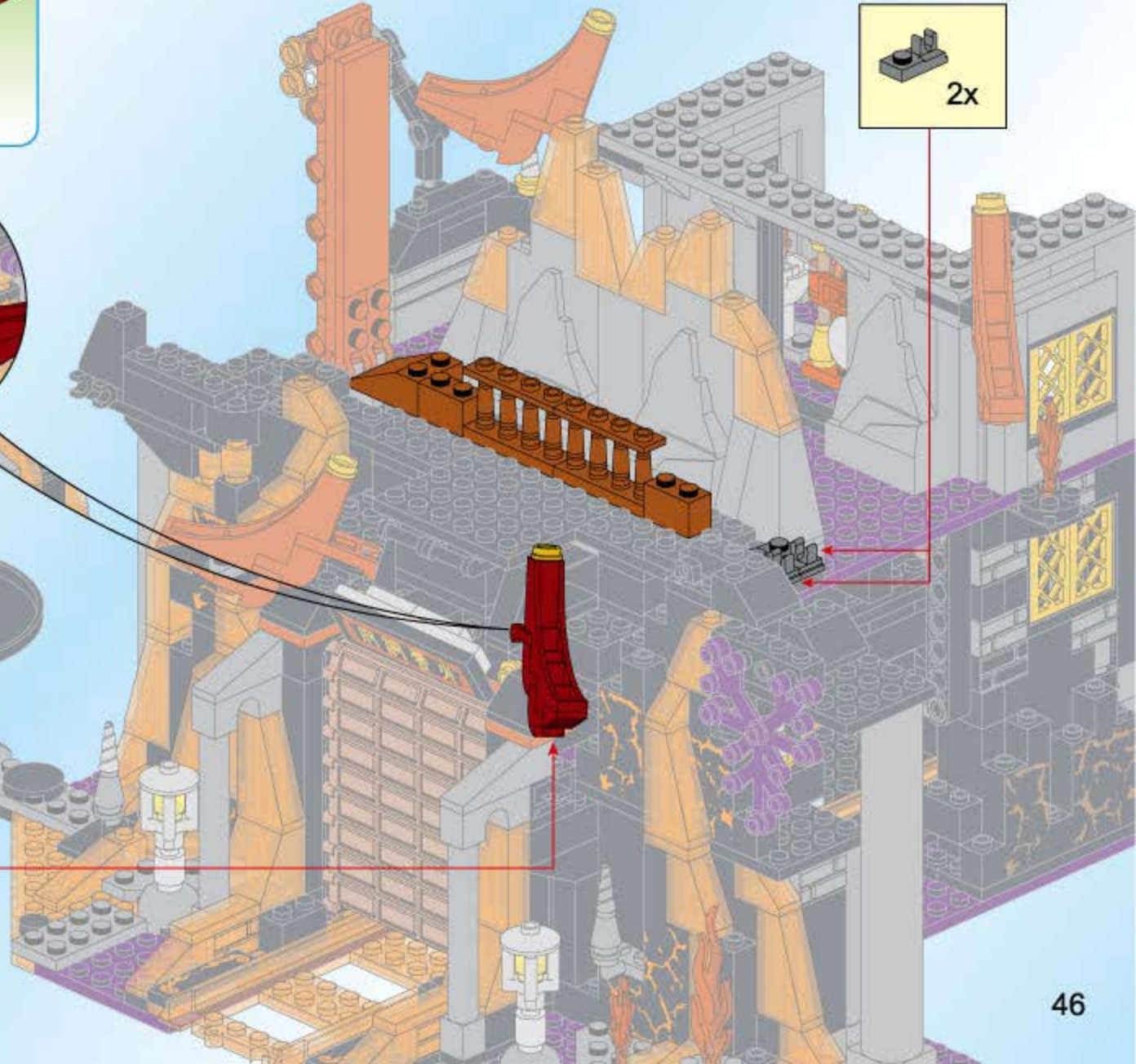
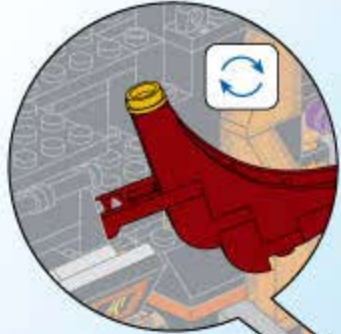
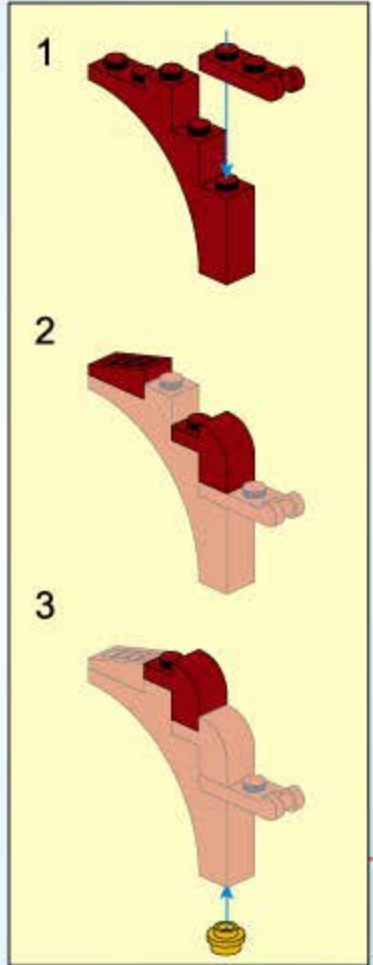
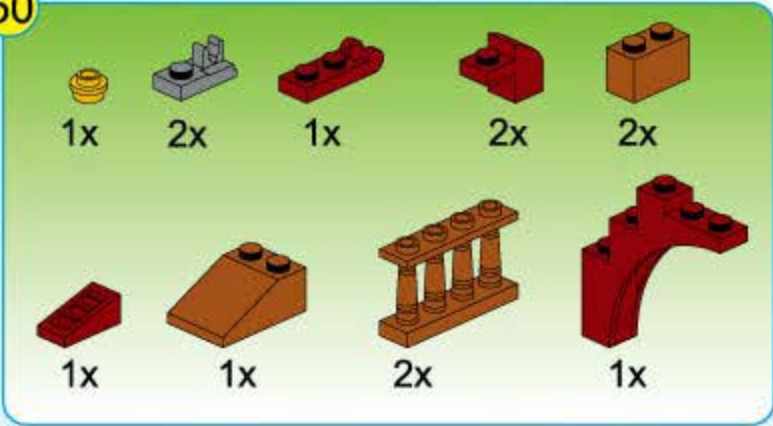

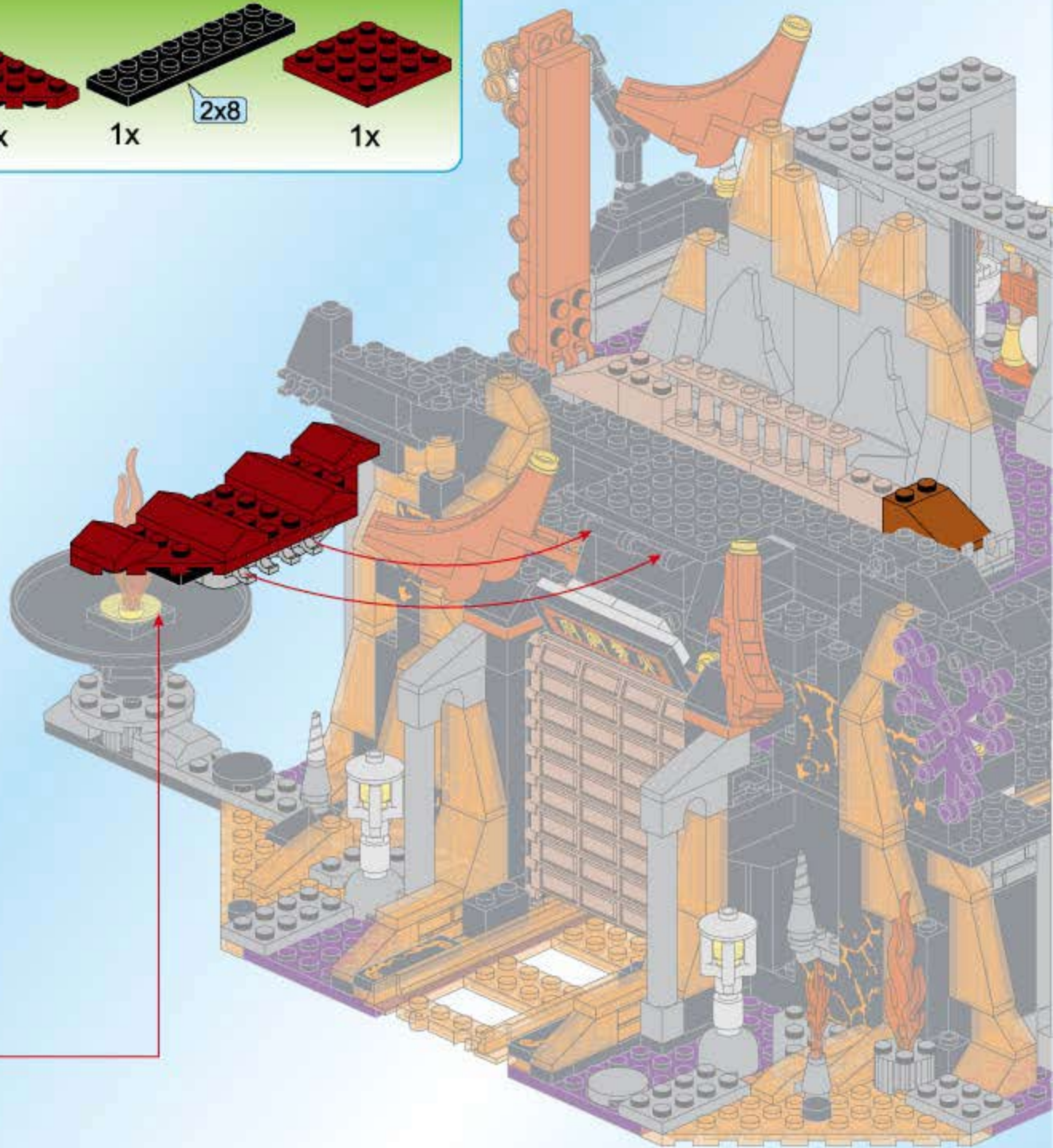
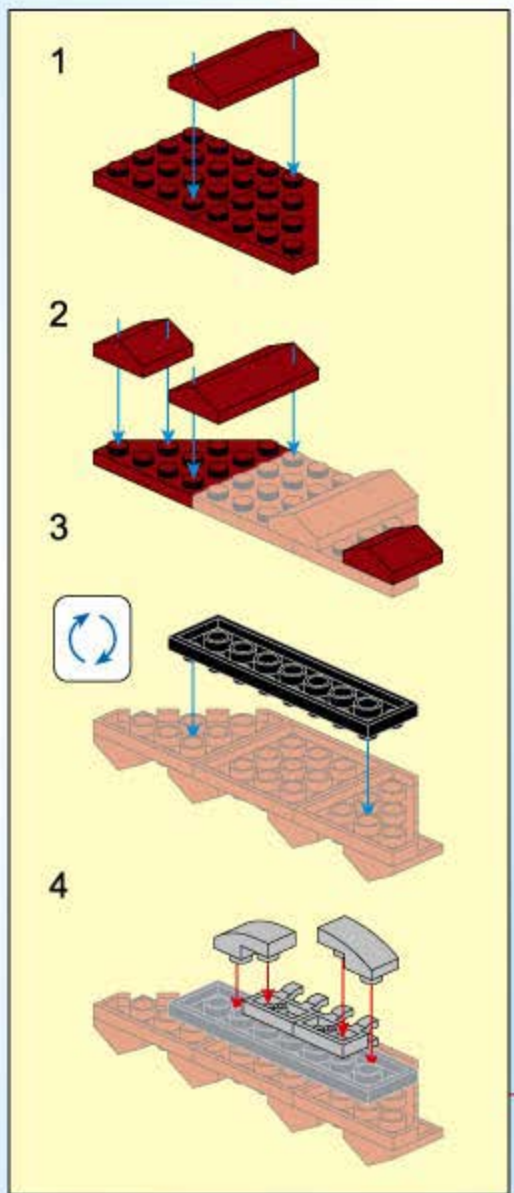
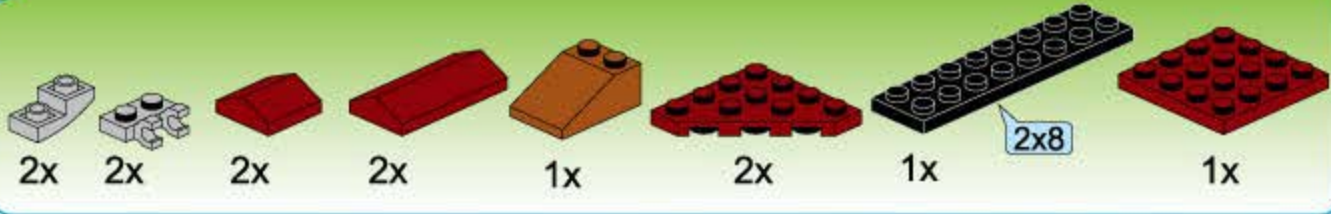

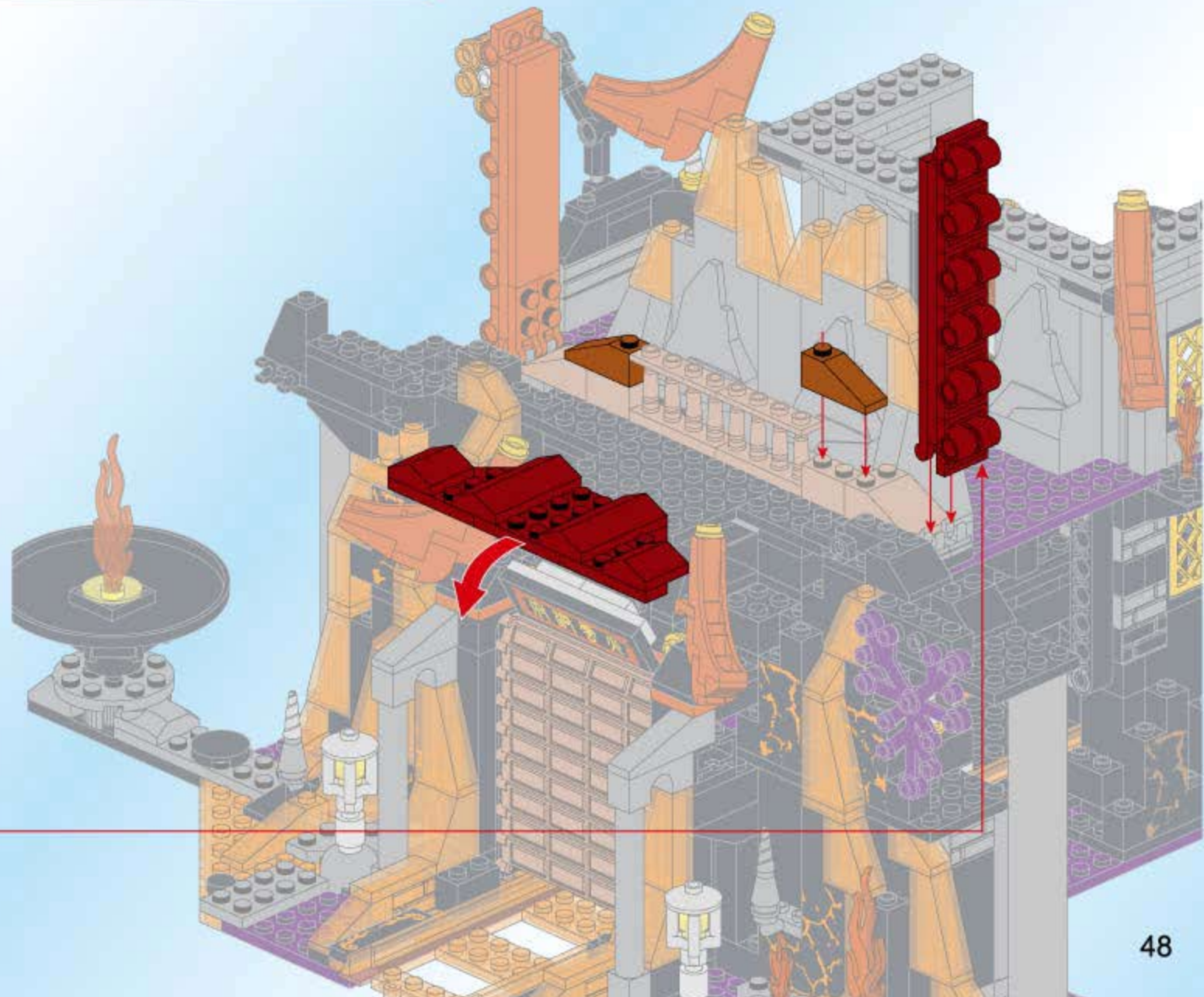
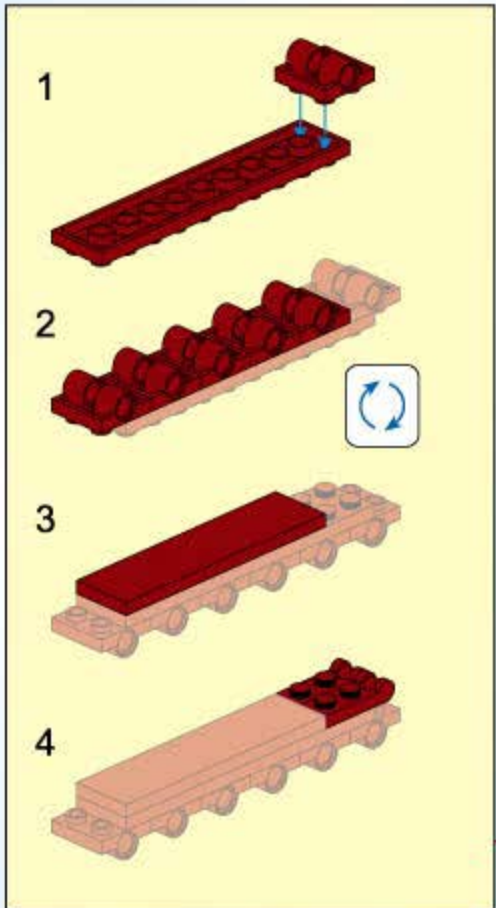
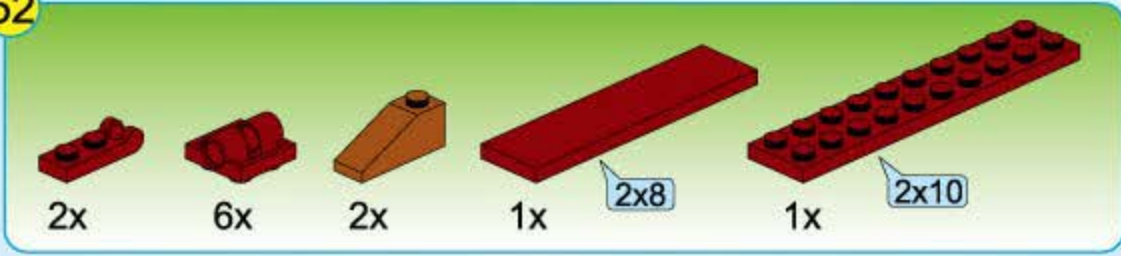

- 2x
- 1x
- 2x
- 1x
- 4x
- 1x
- 1x

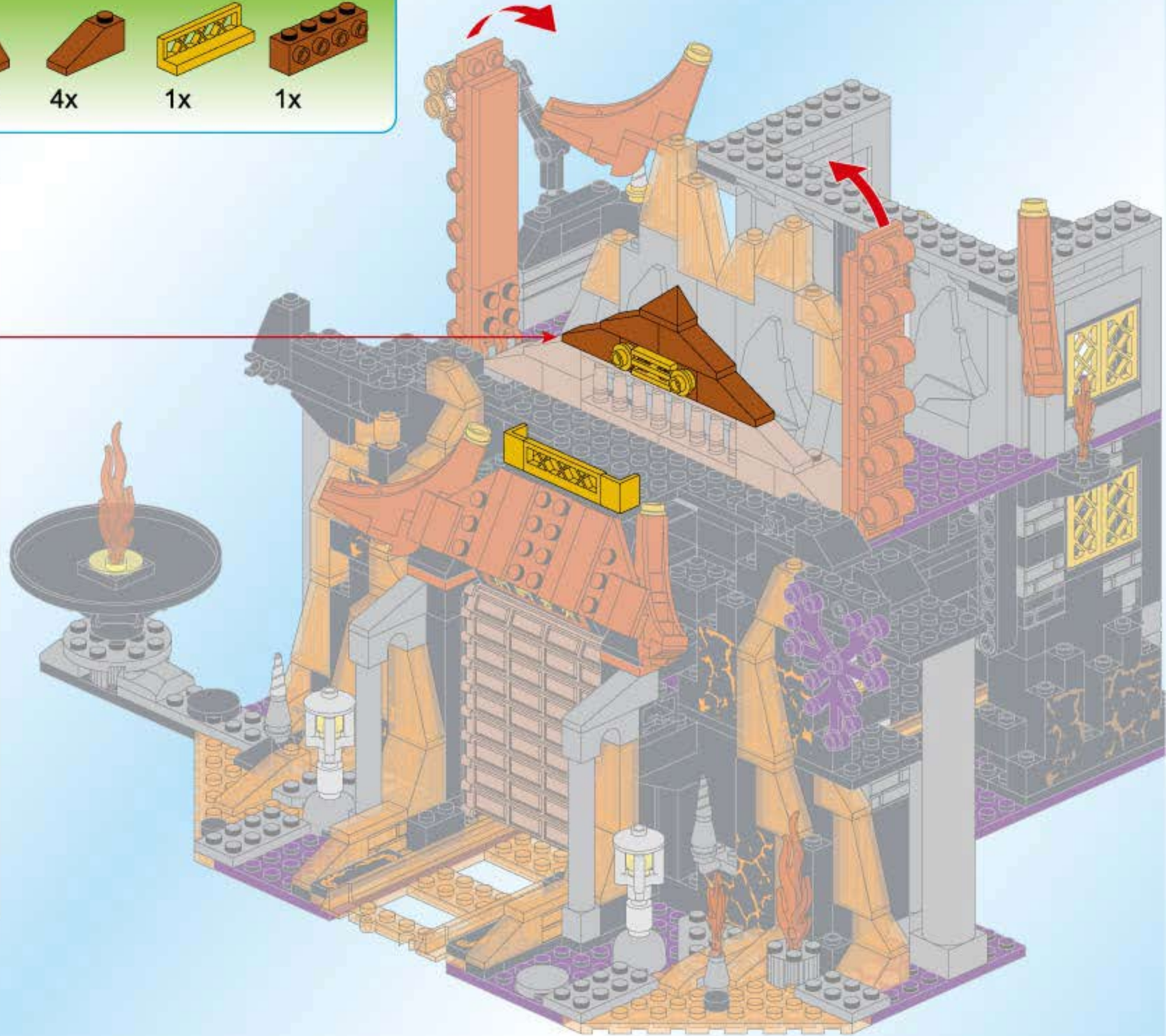
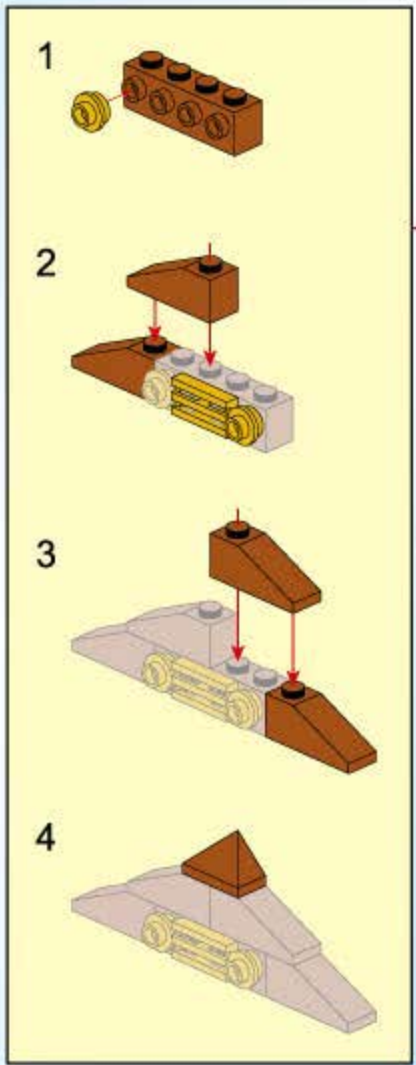

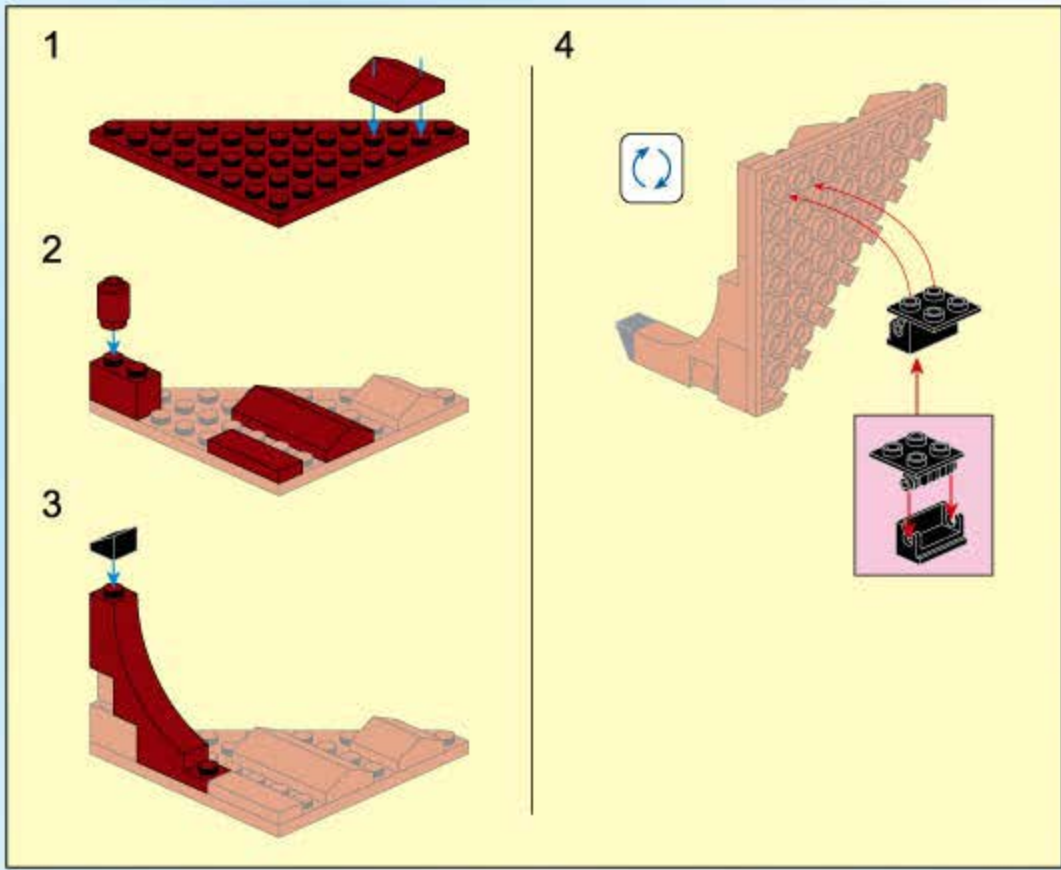
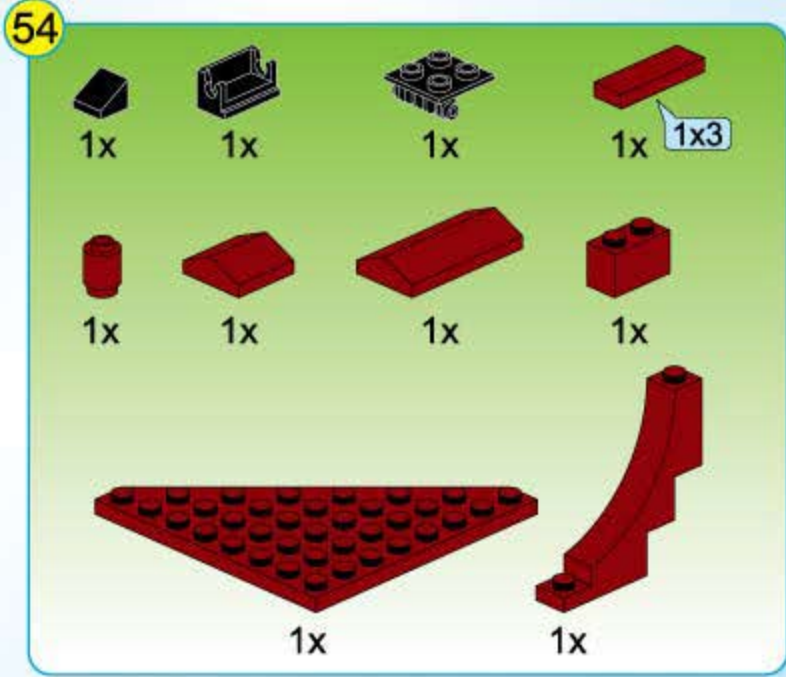
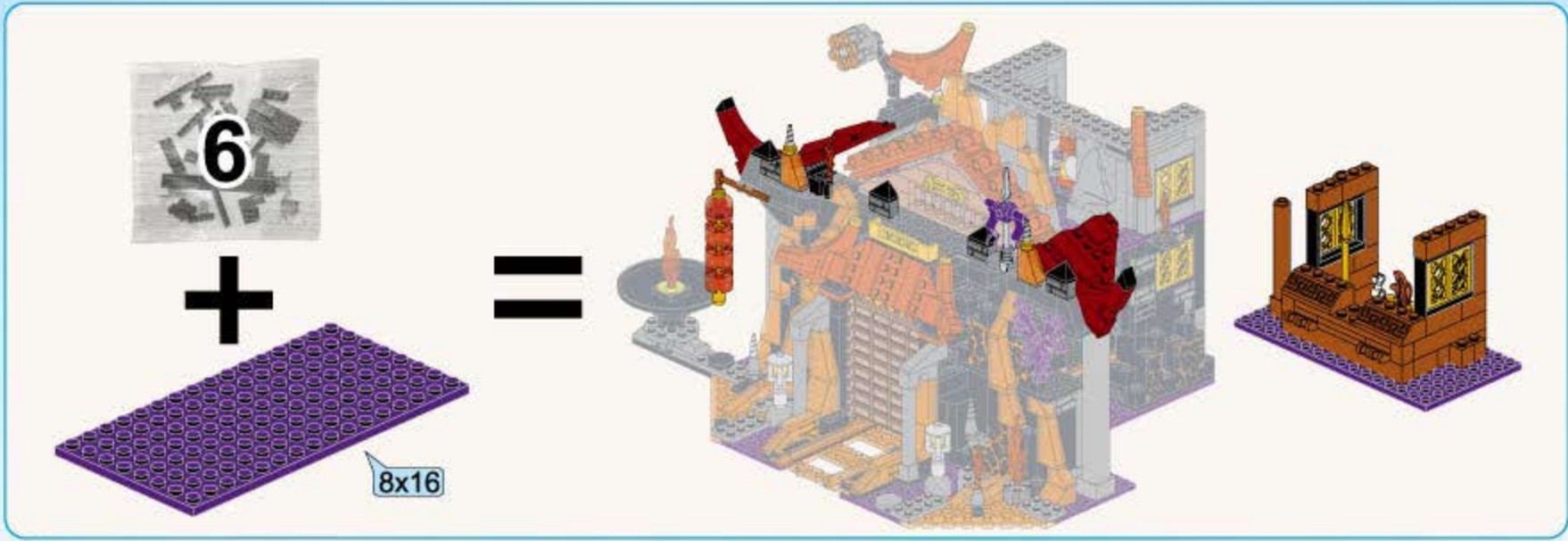

55

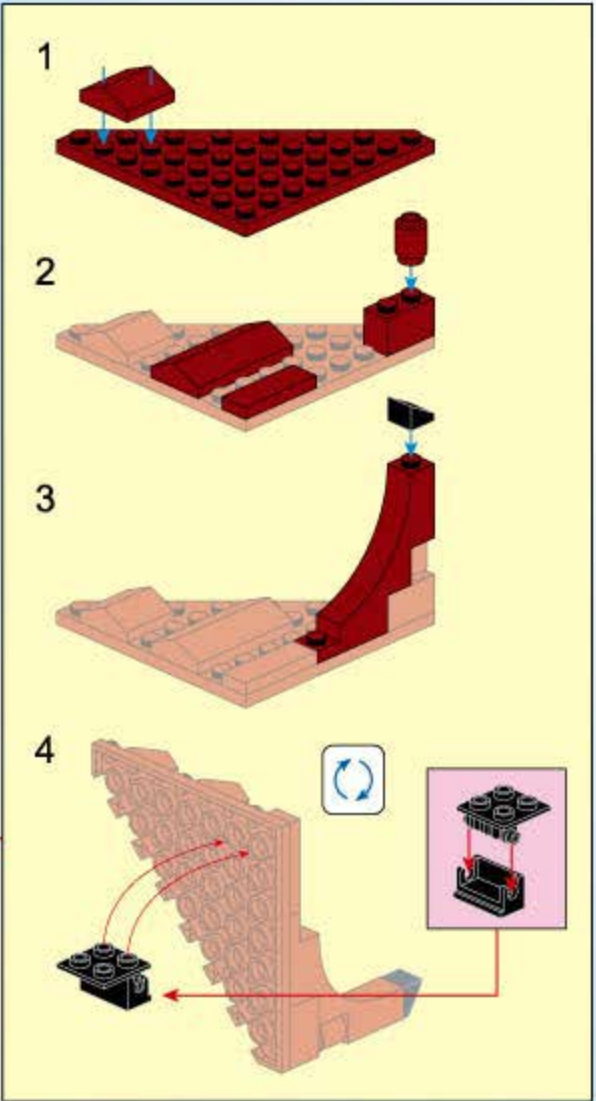
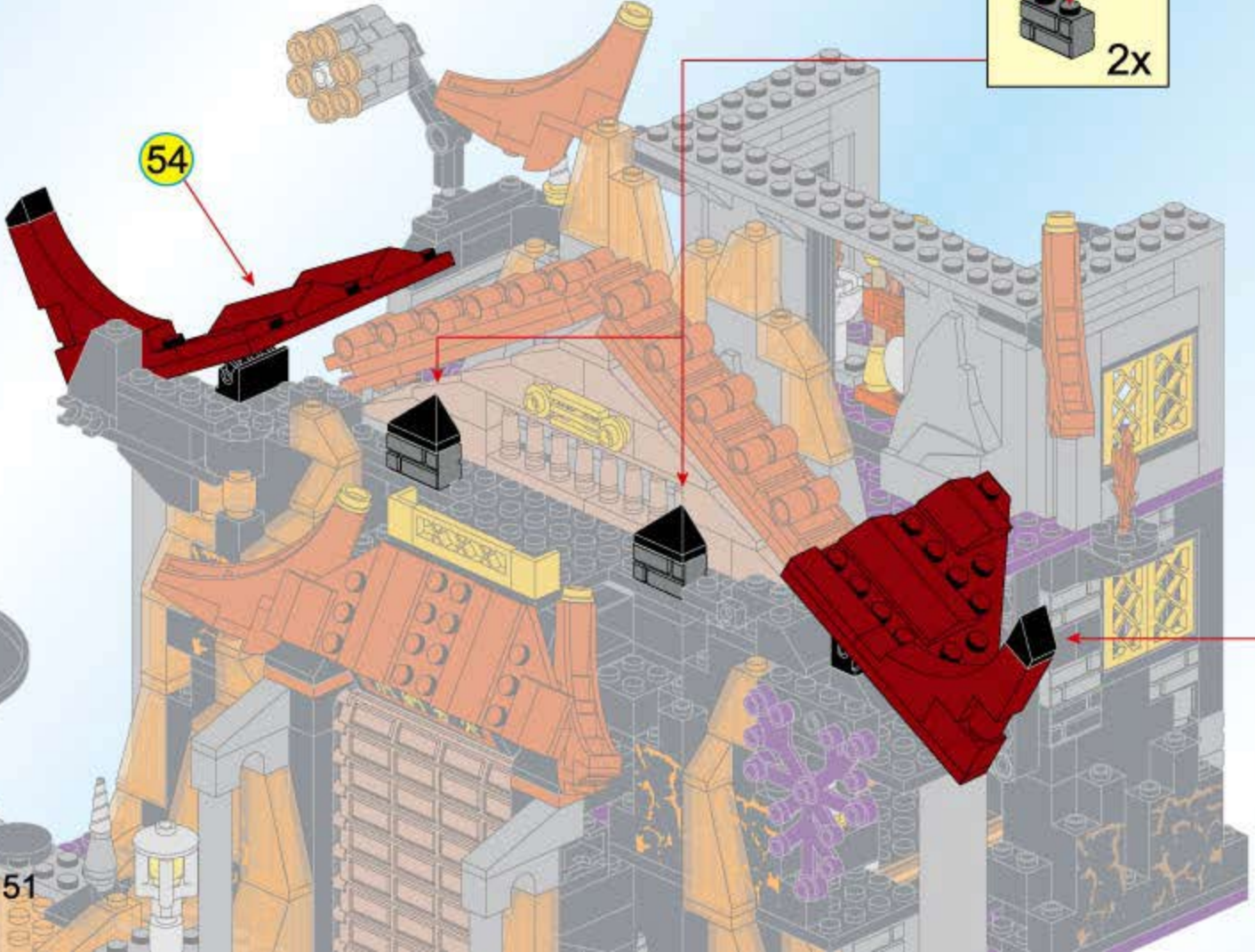
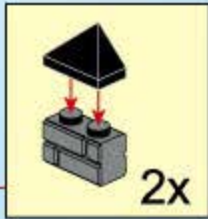
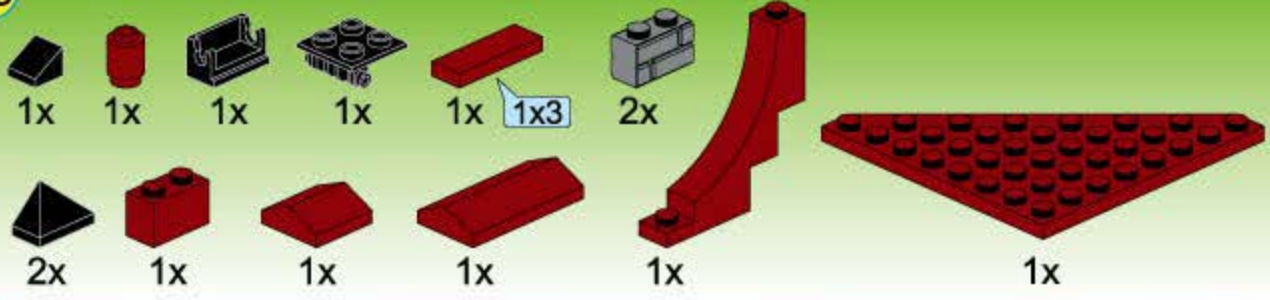

51

- 1x [Black Technic Pin]
- 1x [Purple Technic Connector]
- 1x [Black Technic 1x2 Brick]
- 1x [Grey Technic 1x2 Brick]
- 1x [Black Technic Triangle]
- 2x [Purple Technic Connector]
- 1x [Red Coral Piece]
- 1x [Grey Technic Pin]
- 1x [Grey Technic Pin]
- 1x [Black Technic 1x2 Brick]
- 1x [Black Technic 1x2 Brick]
- 1x [Black Technic 1x2 Brick]

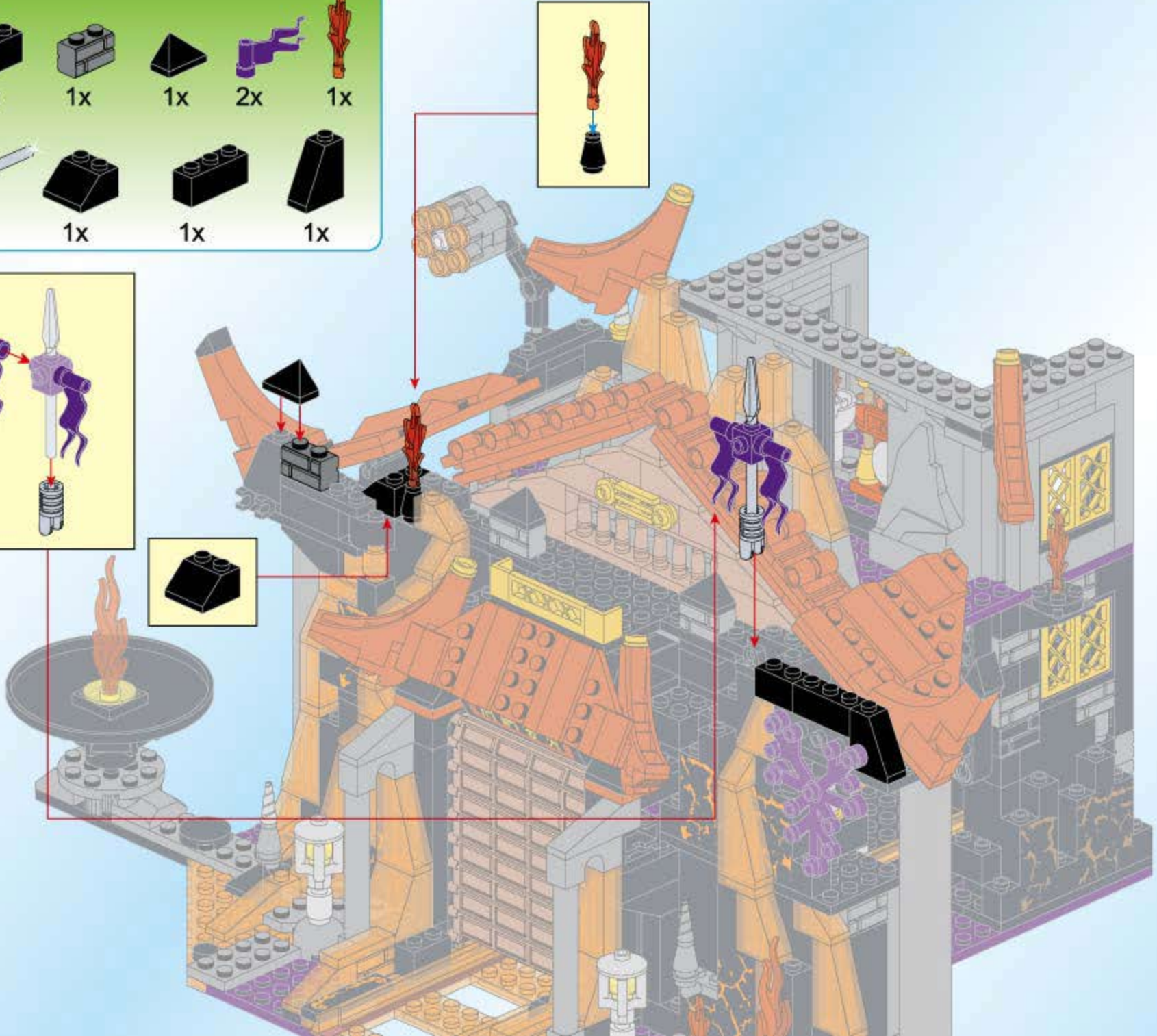
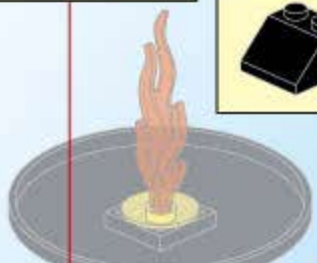
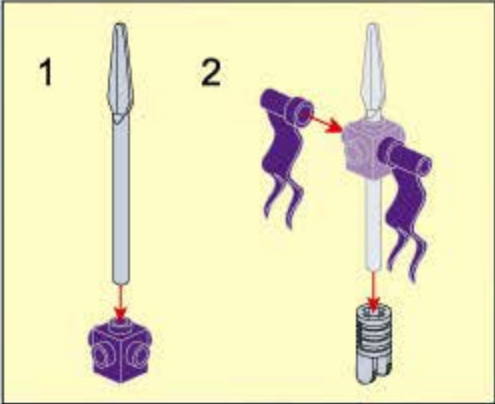

- 6x [Yellow 1-hole Technic Pin]
- 2x [Grey 1-hole Technic Pin]
- 1x [Yellow 1-hole Technic Pin]
- 1x [Red 1-hole Technic Pin]
- 1x [Grey 1-hole Technic Pin]
- 1x [Brown Technic Hammer]
- 1x [Black Technic Triangle]
- 1x [Red 1-hole Technic Pin]
- 3x [Red 1-hole Technic Pin]
- 2x [Orange Technic Wedge]
- 1x [Yellow Technic Pin]

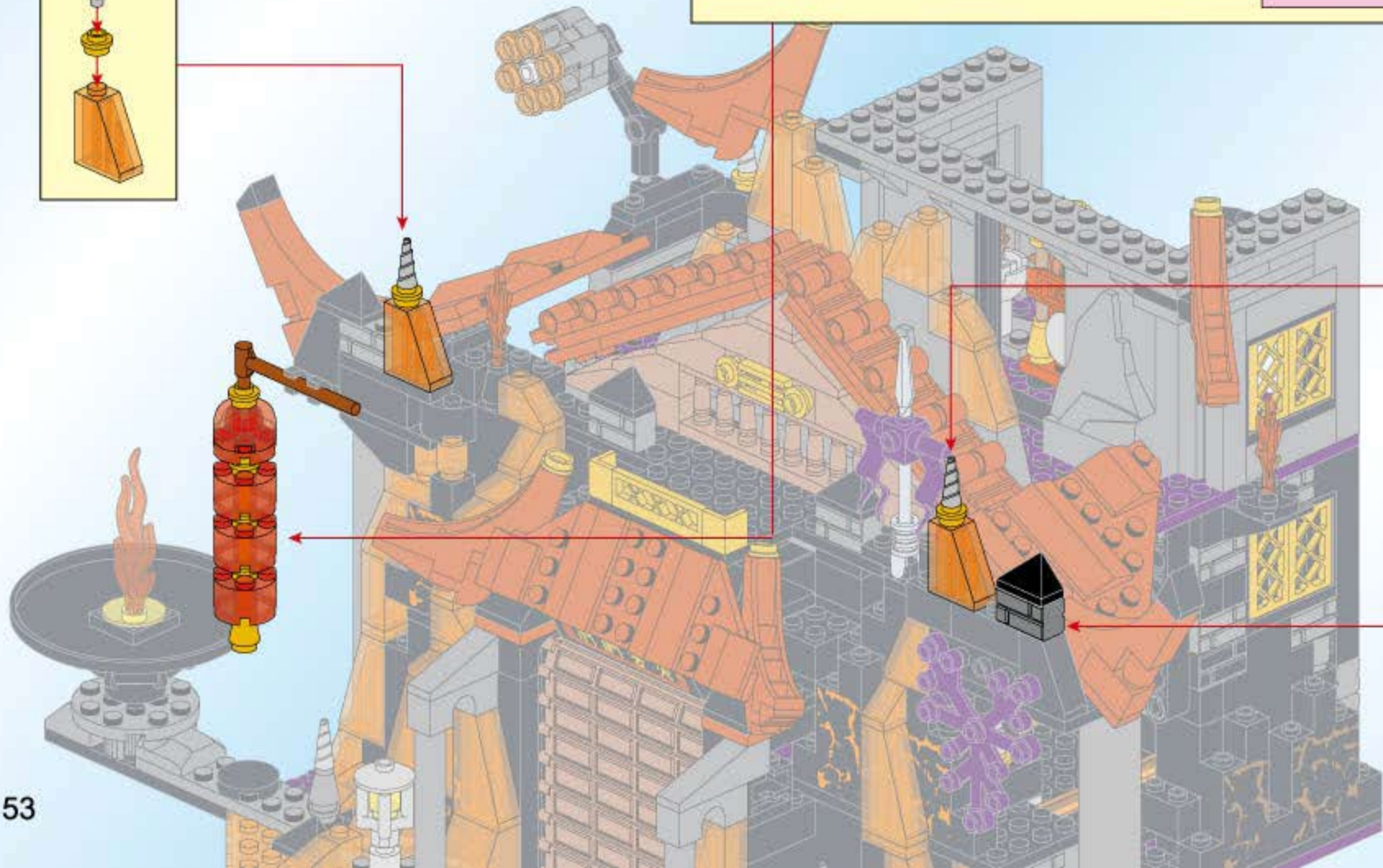
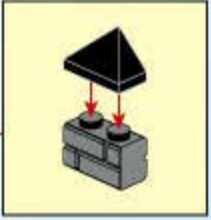
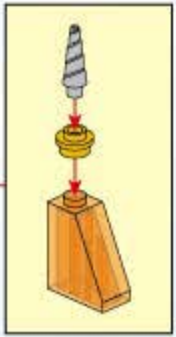
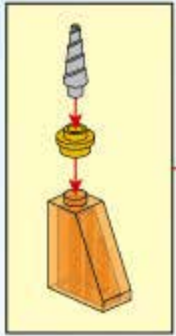
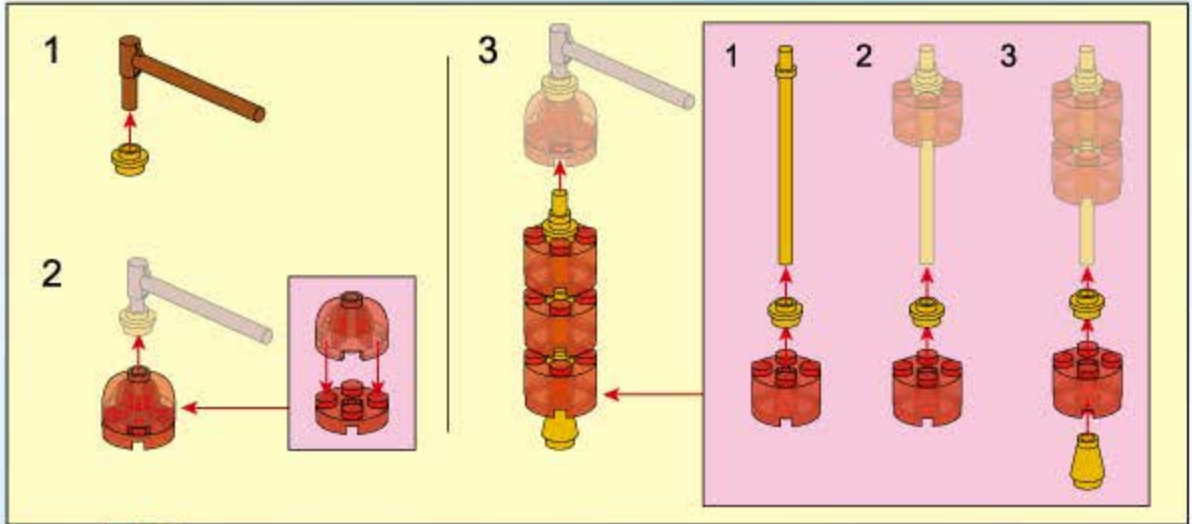



58

2x 2x 2x

1x 8x16

2x

59

2x 2x 1x

2x 2x 1x

1

2

1

2

60

1x 3x 2x

61

- 1x (white 1x1)
- 1x (red 1x3)
- 1x (red 2x3)
- 1x (brown 1x10)

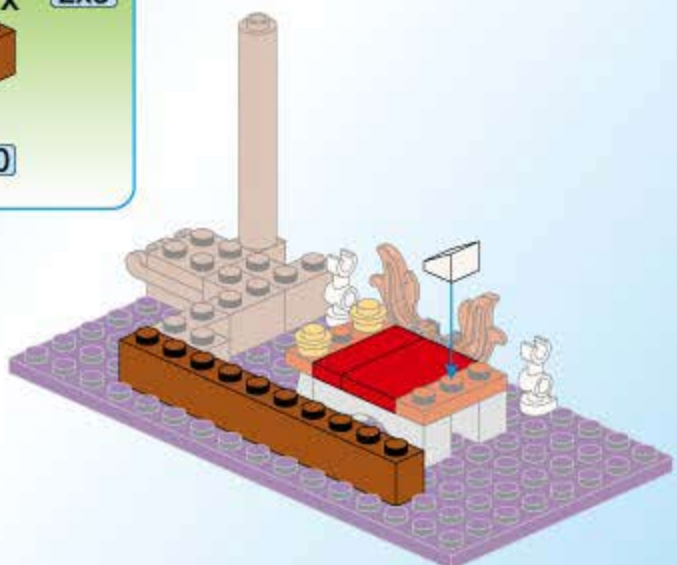

62

- 3x (brown 1x2)
- 1x (black 2x3)
- 1x (brown 1x2 with axle)

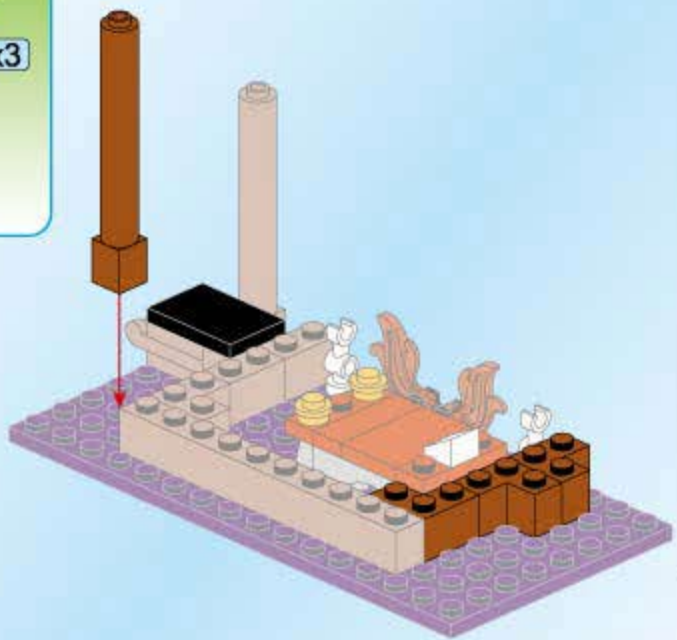

63

- 2x (yellow 1x2)
- 2x (red 1x2)
- 1x (black 1x2)
- 1x (brown 1x2)
- 1x (black 1x4)

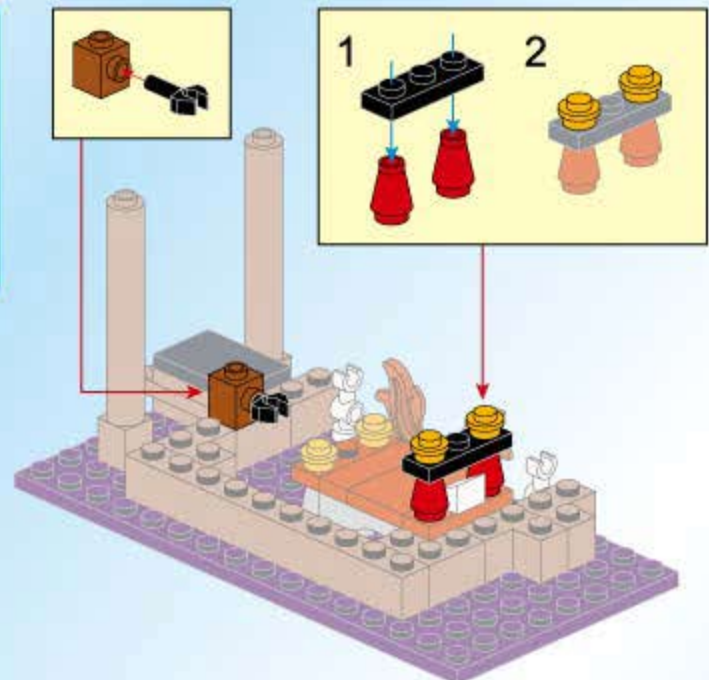

64

- 1x (brown 1x1)
- 2x (brown 1x2)
- 1x (brown 1x5)

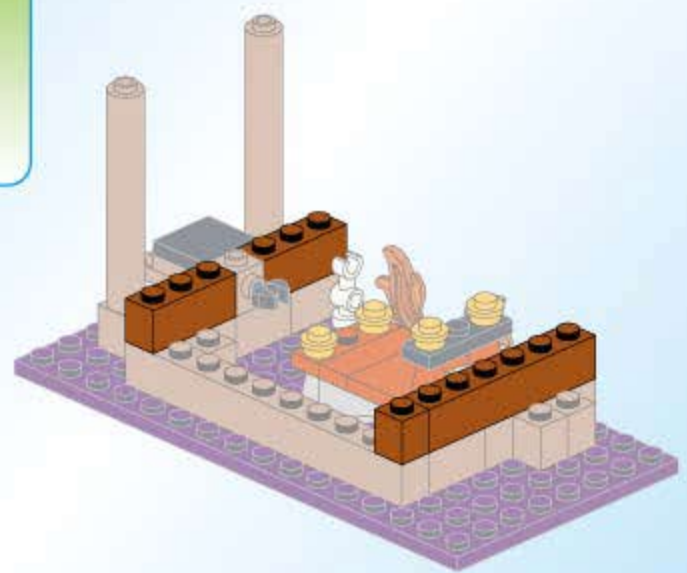

65

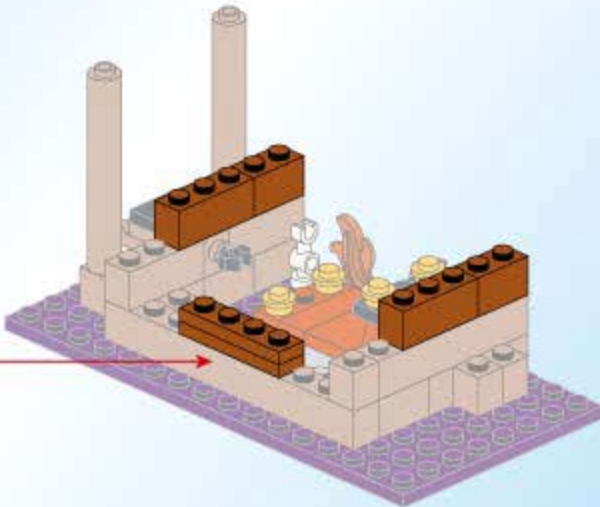
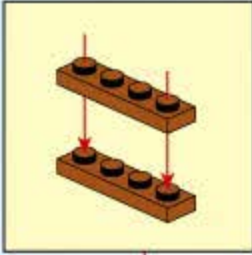
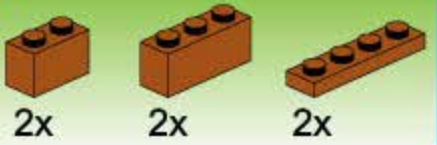

66

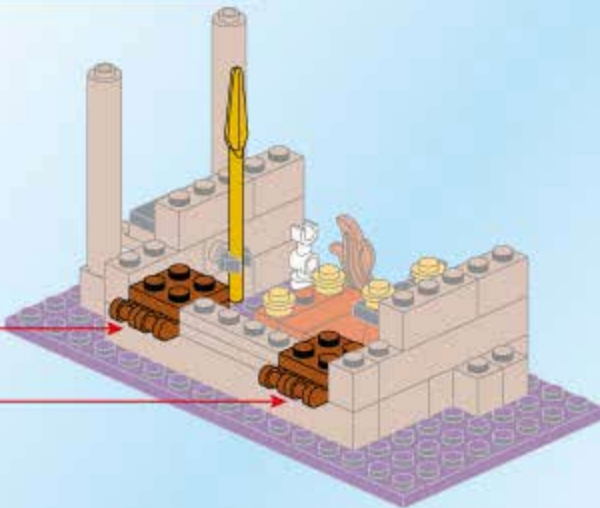
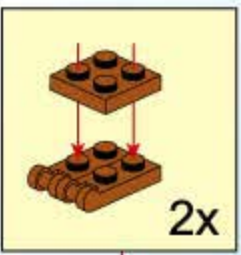
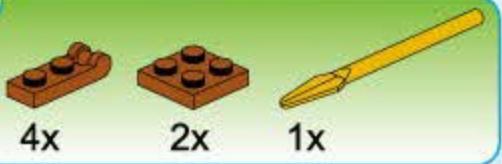

67

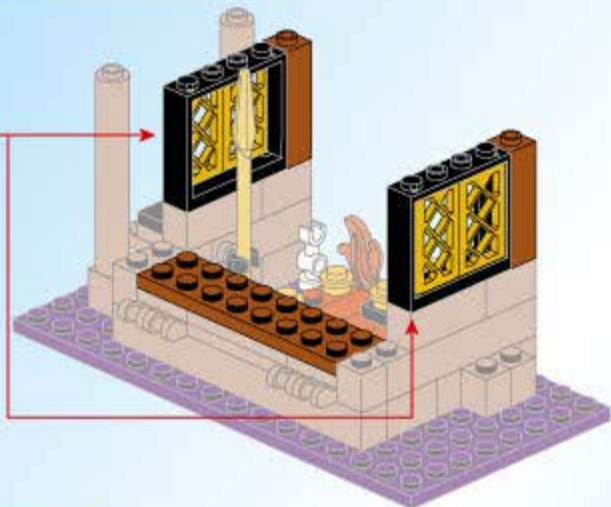
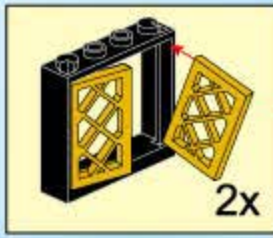
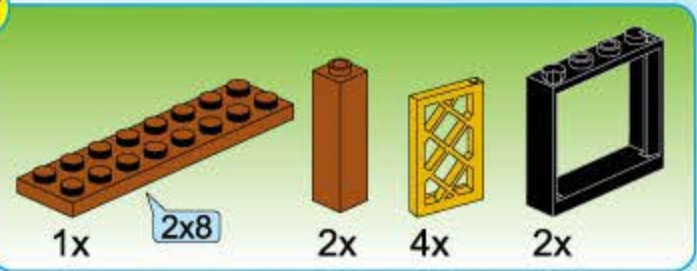

68

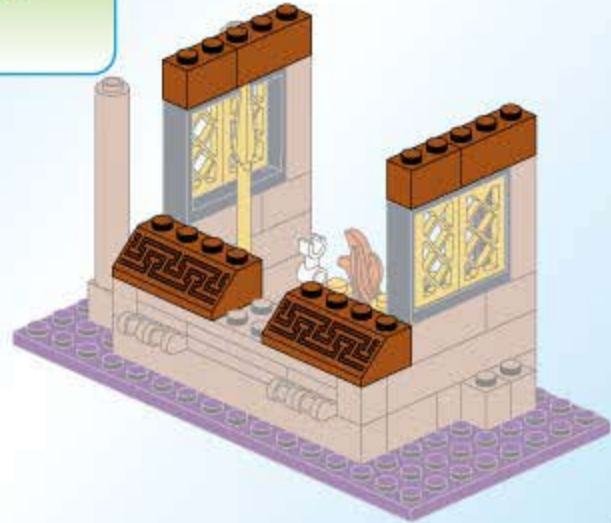
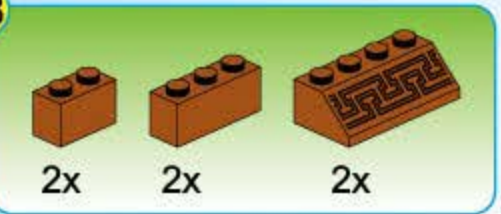

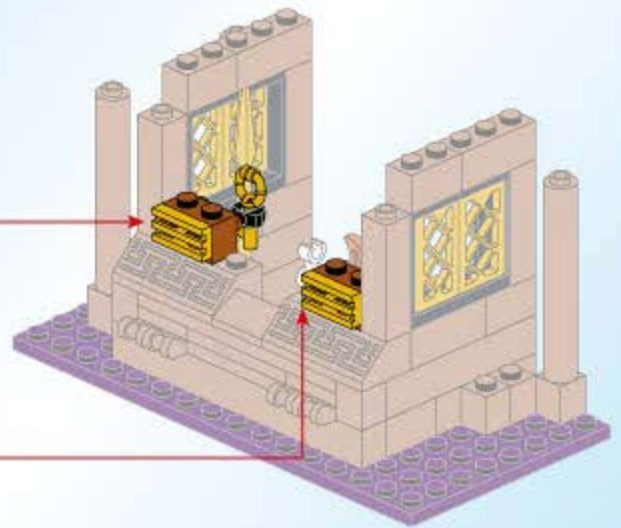
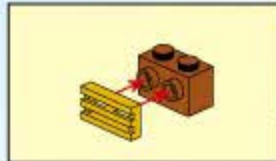
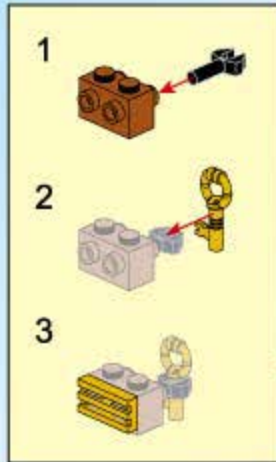
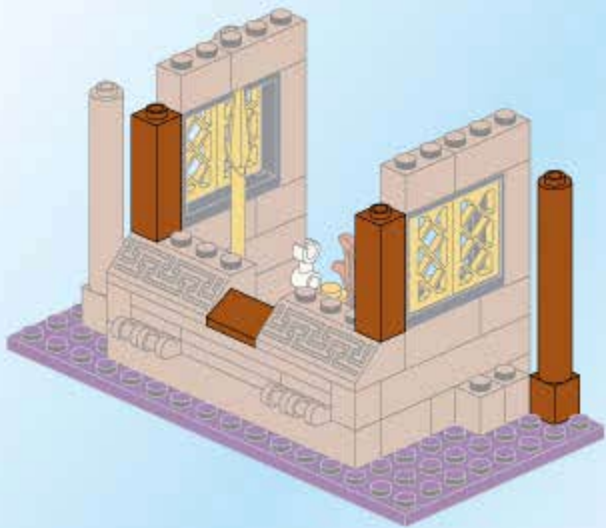
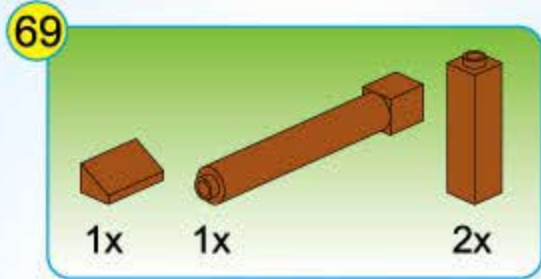
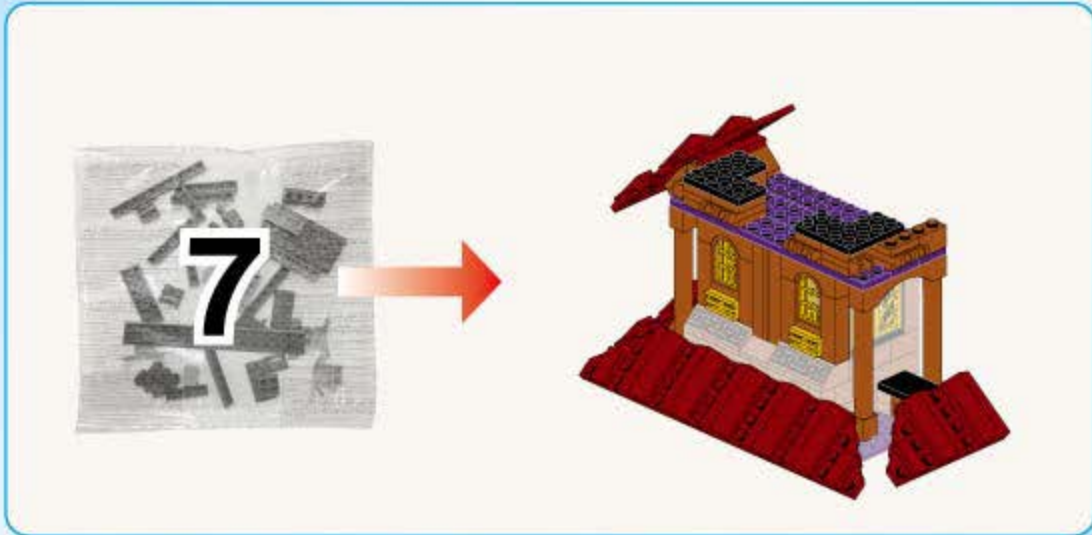

71

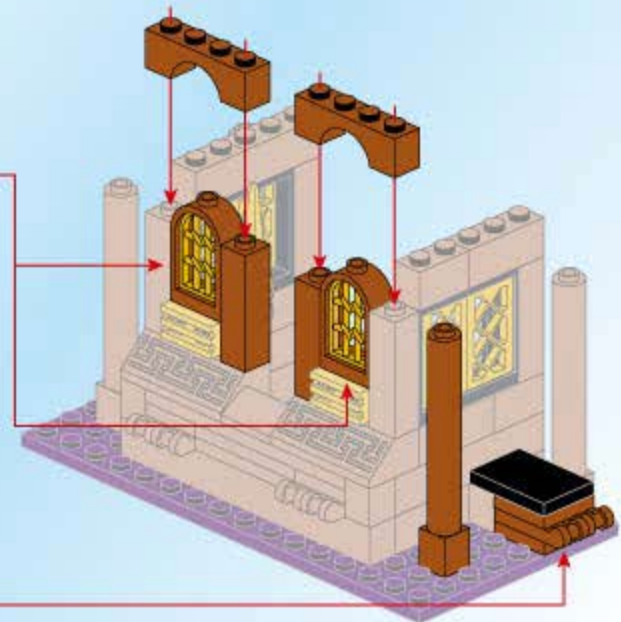
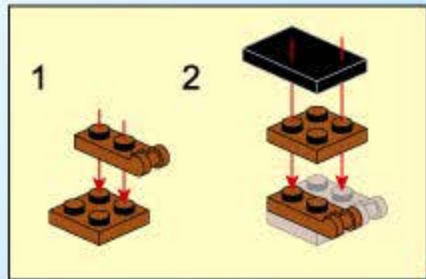
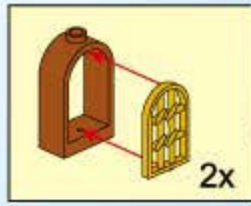
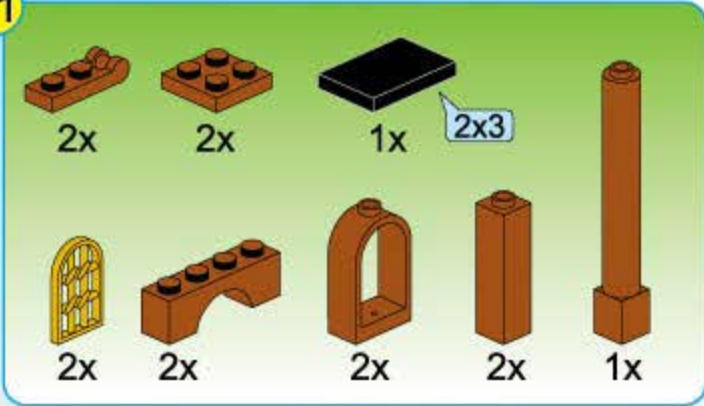

72

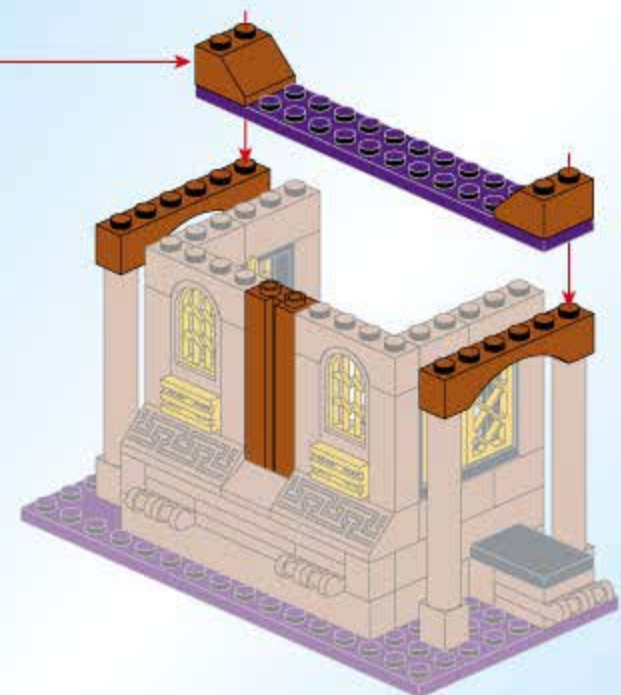
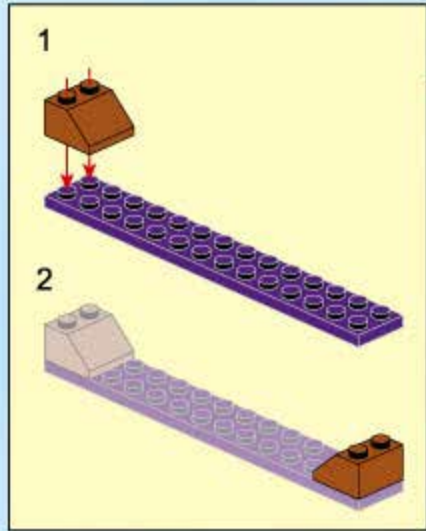
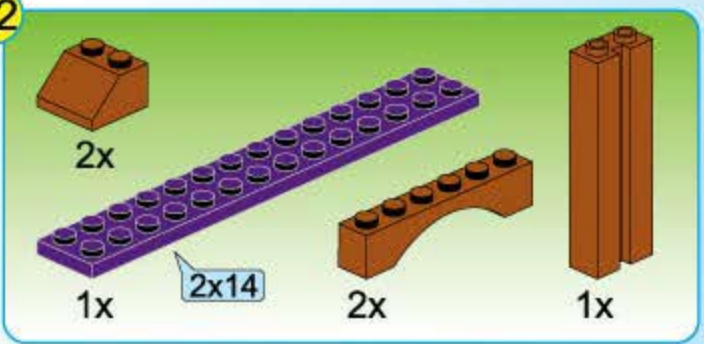

73

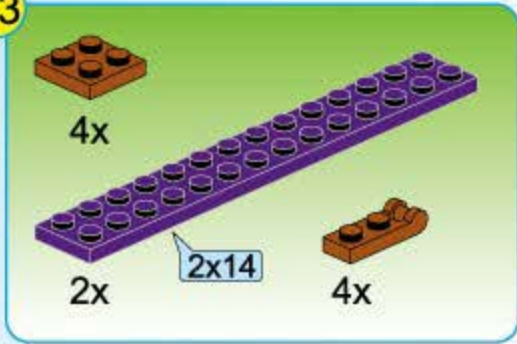

74

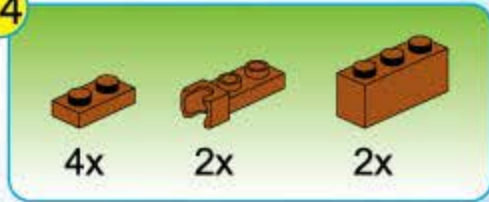

75

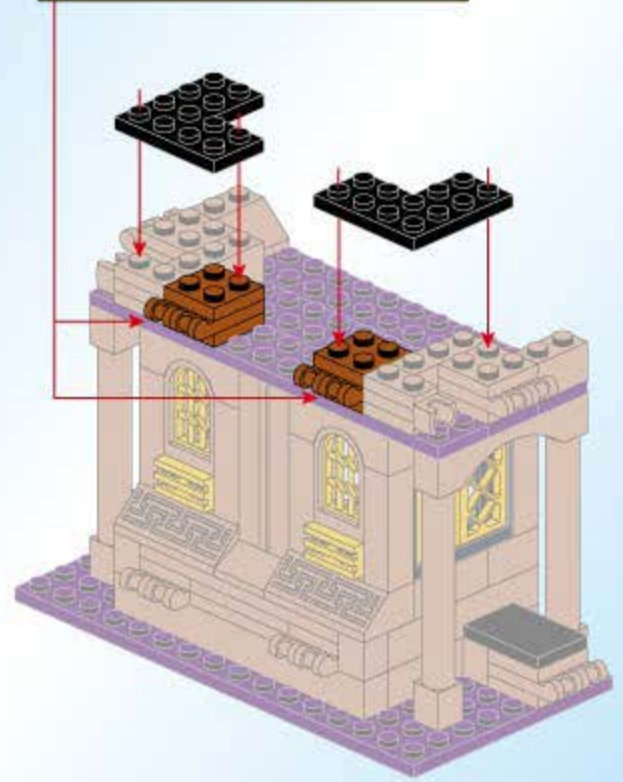
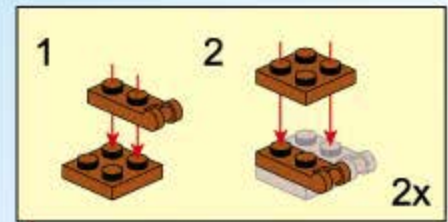
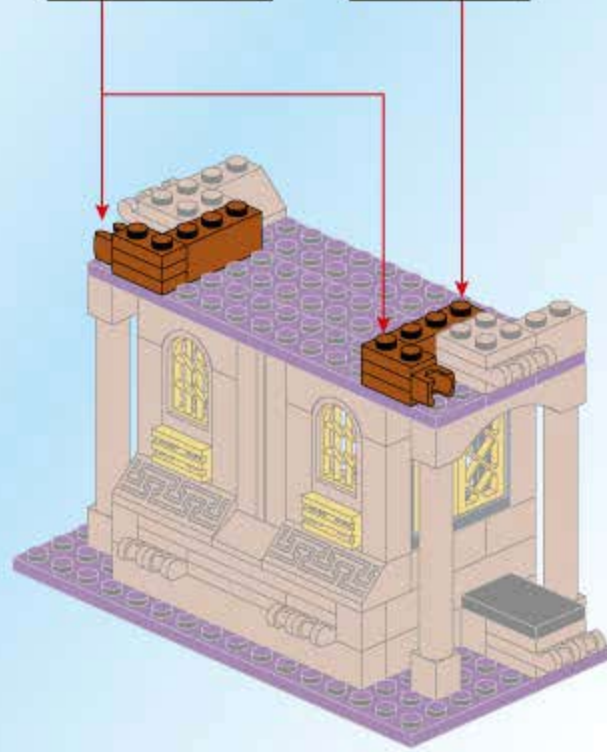
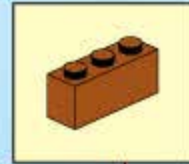
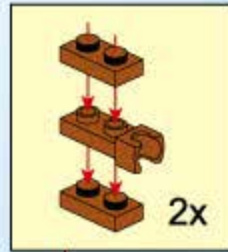
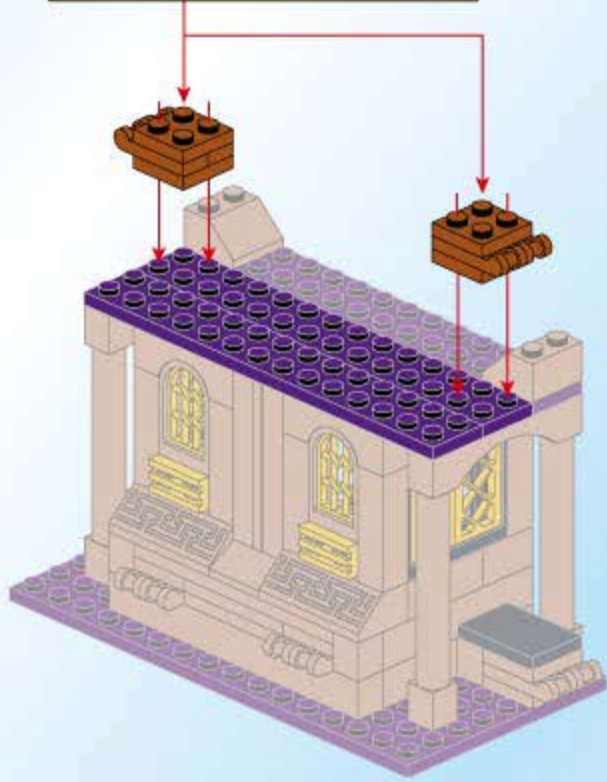
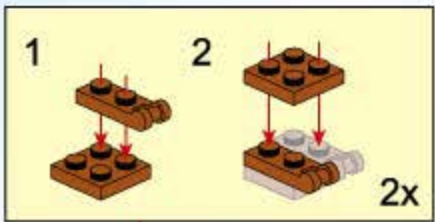
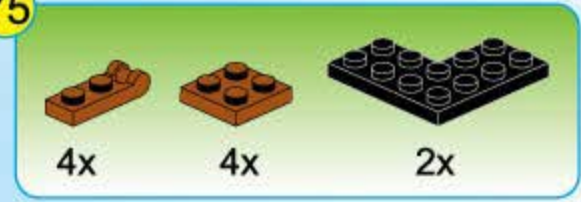

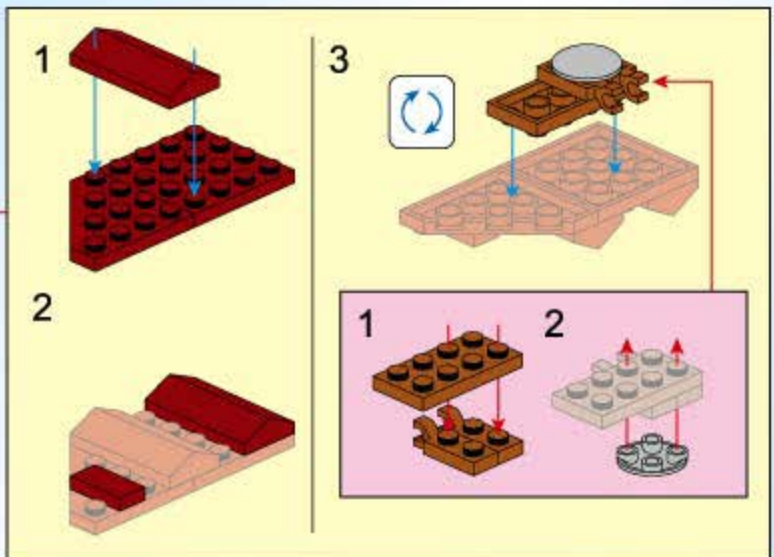
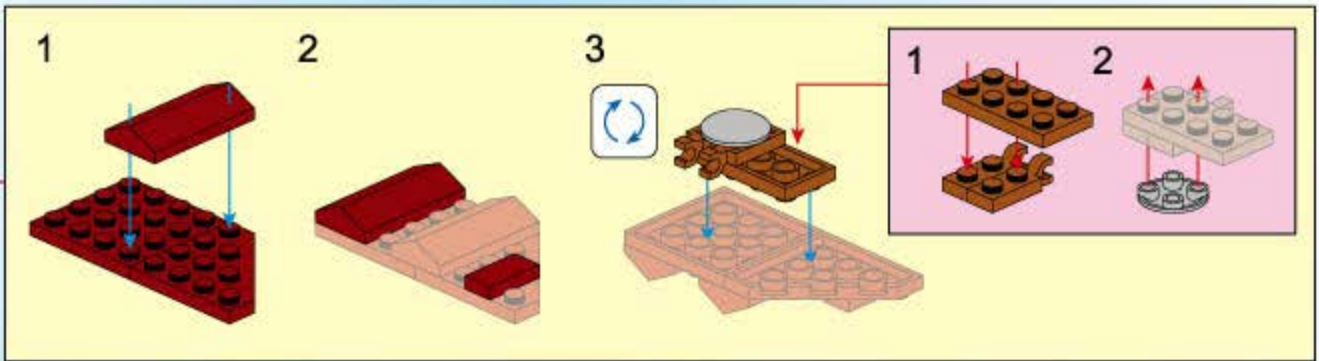
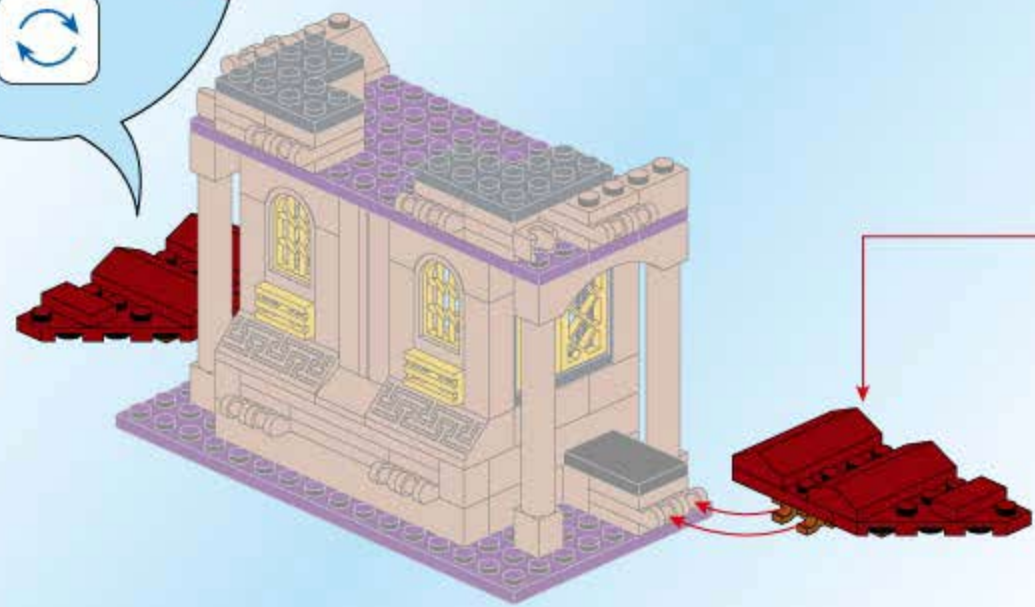
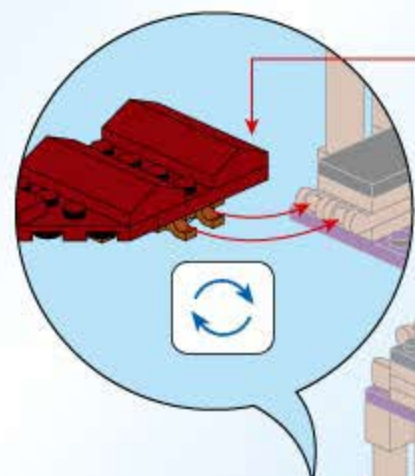
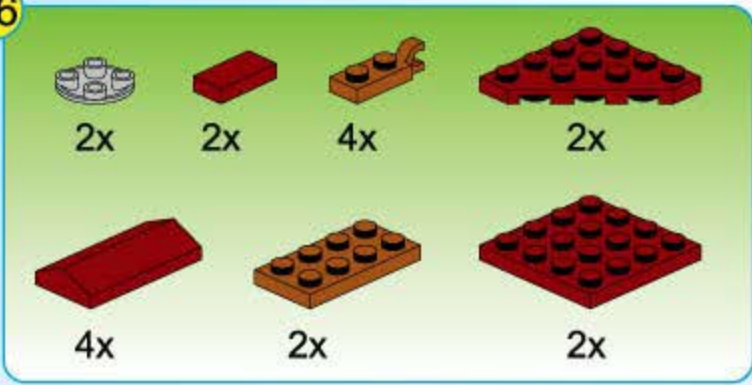

3x 3x 6x 1x
1x 7x 3x
1x 4x12
1x 2x16

1

2

3

1

2

1

2

3

1

2

2x

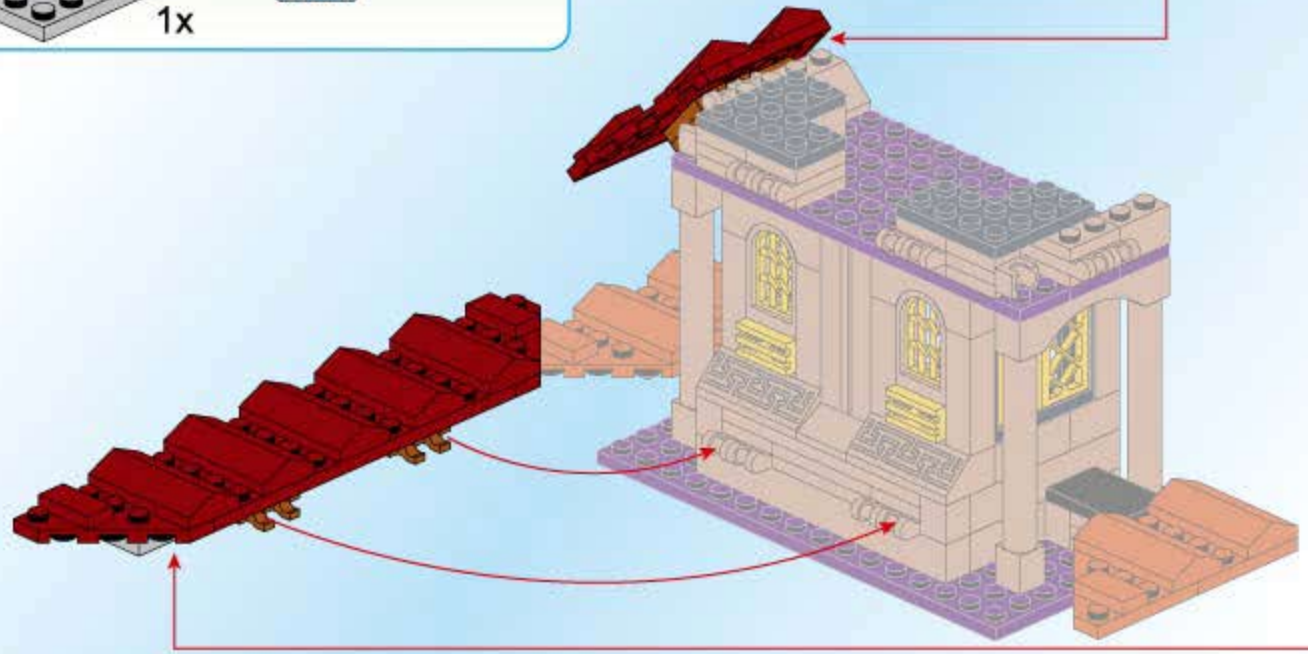

78

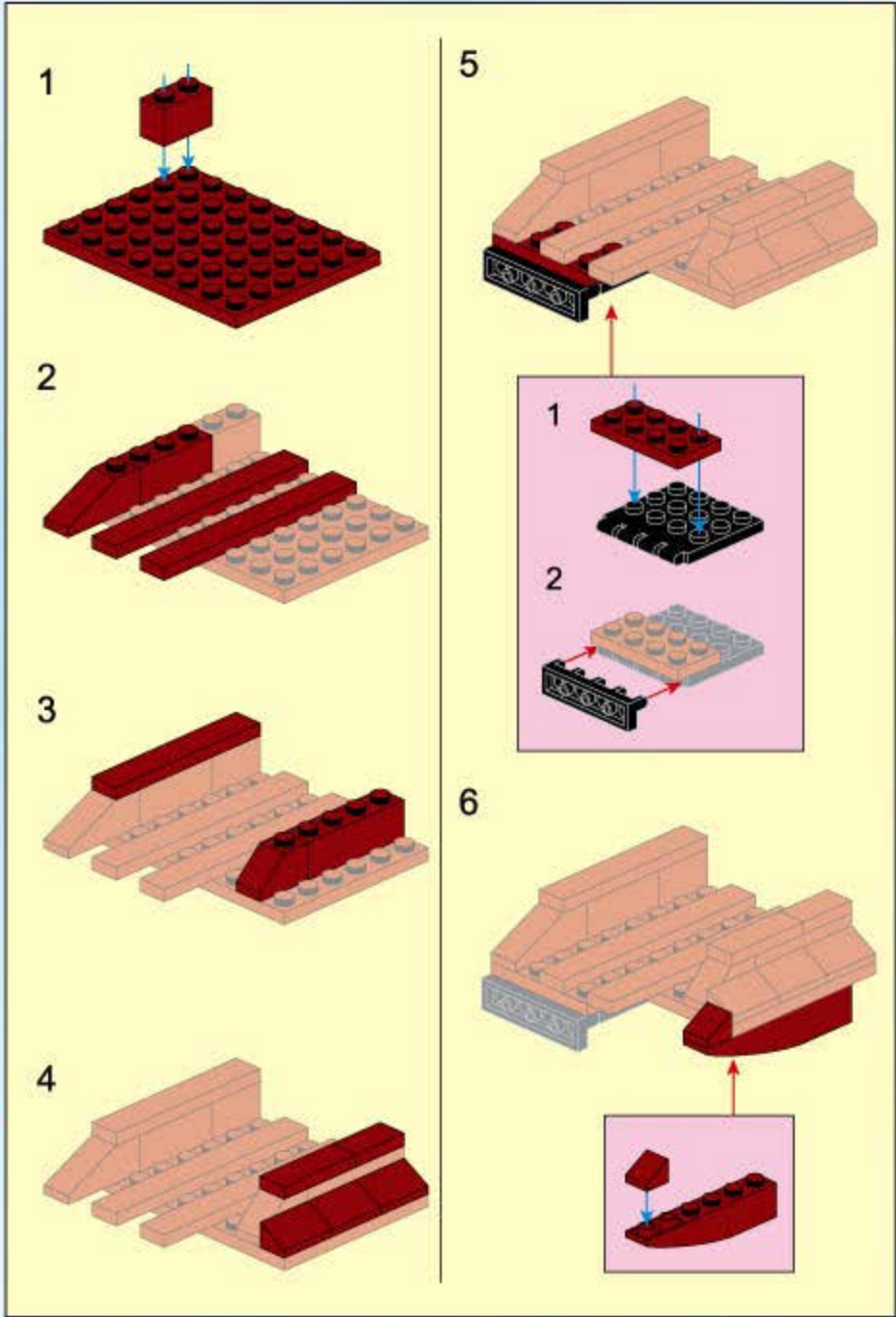
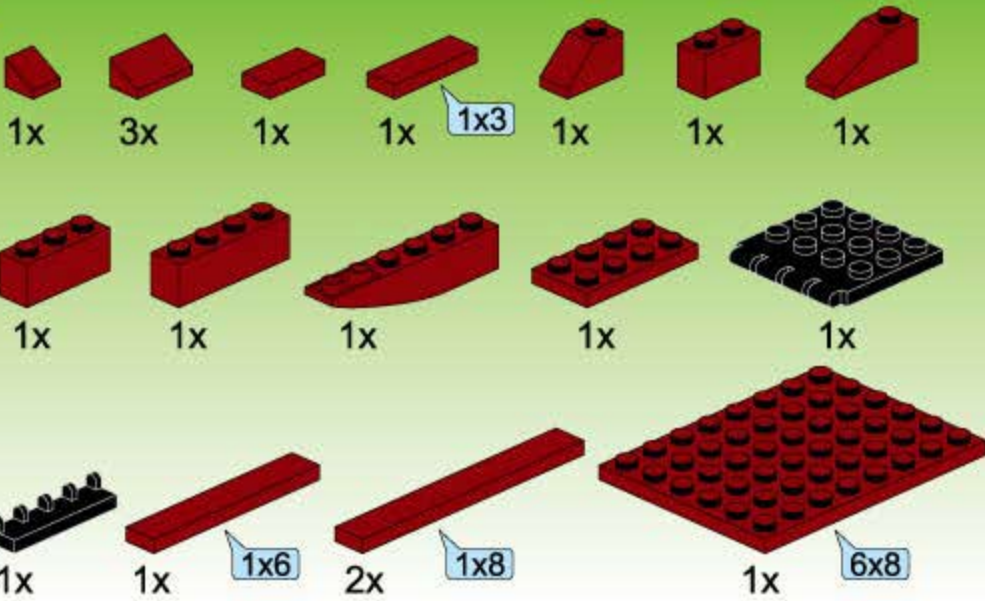
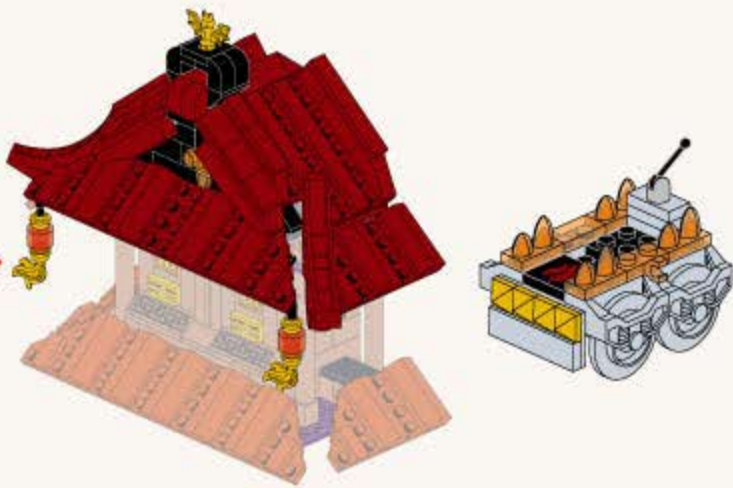

79

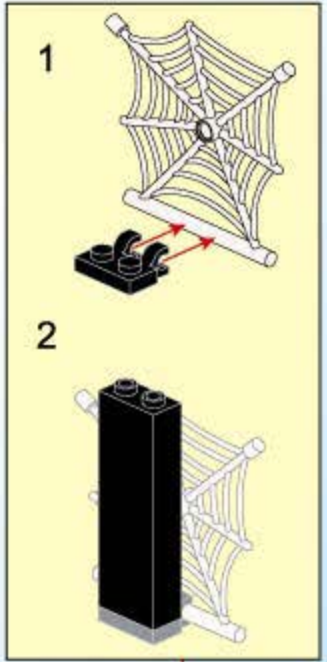
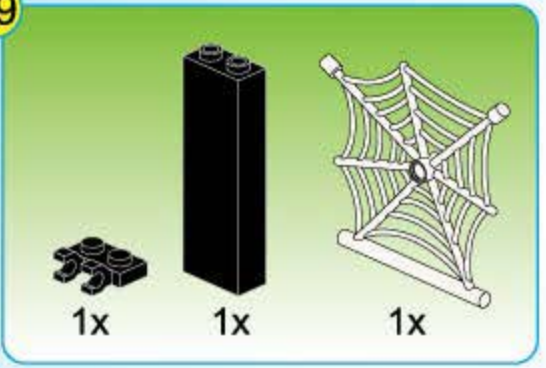

80

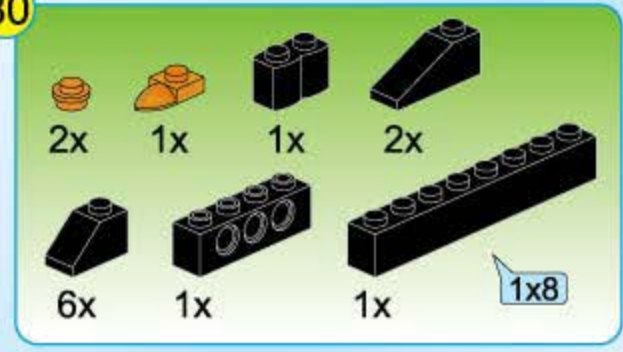

78

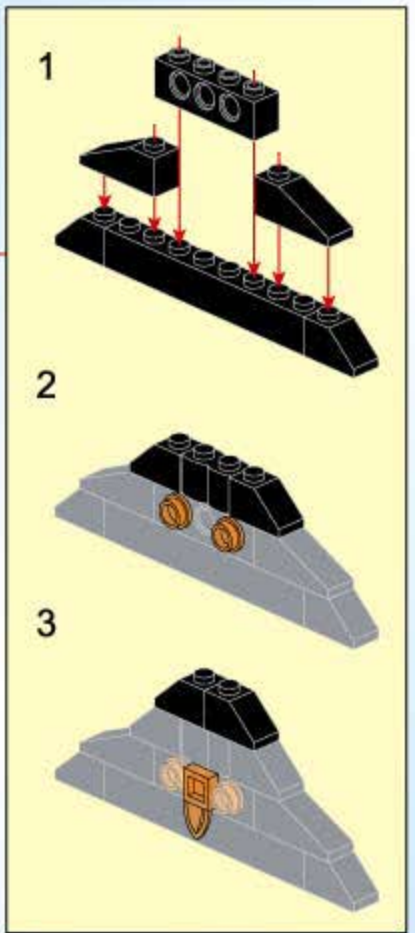
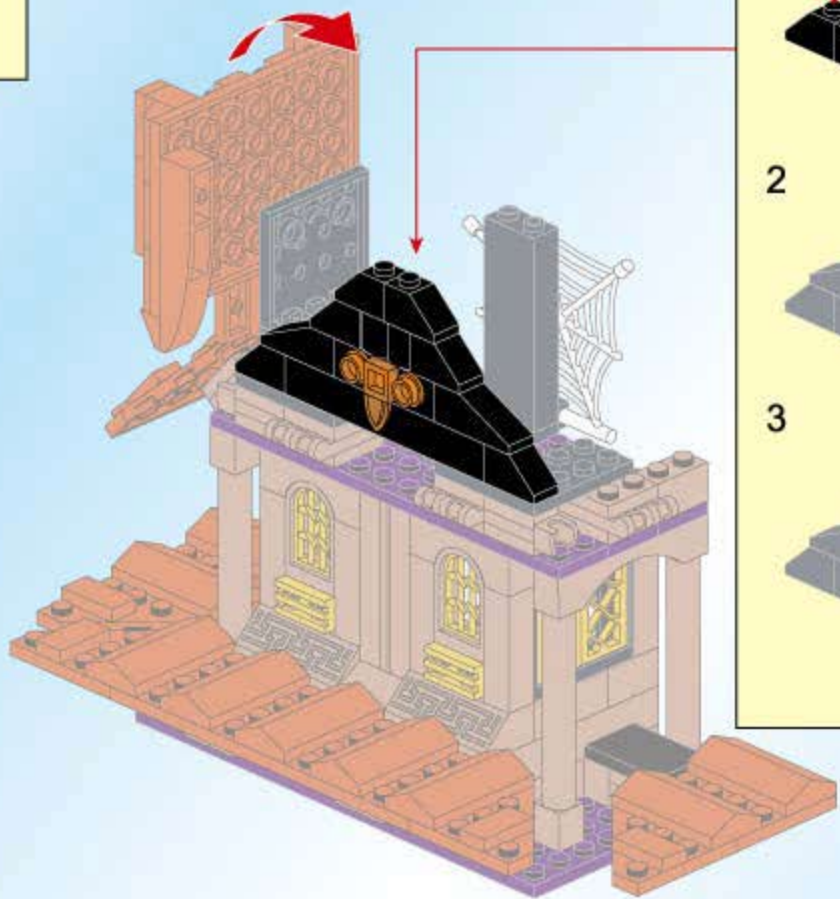
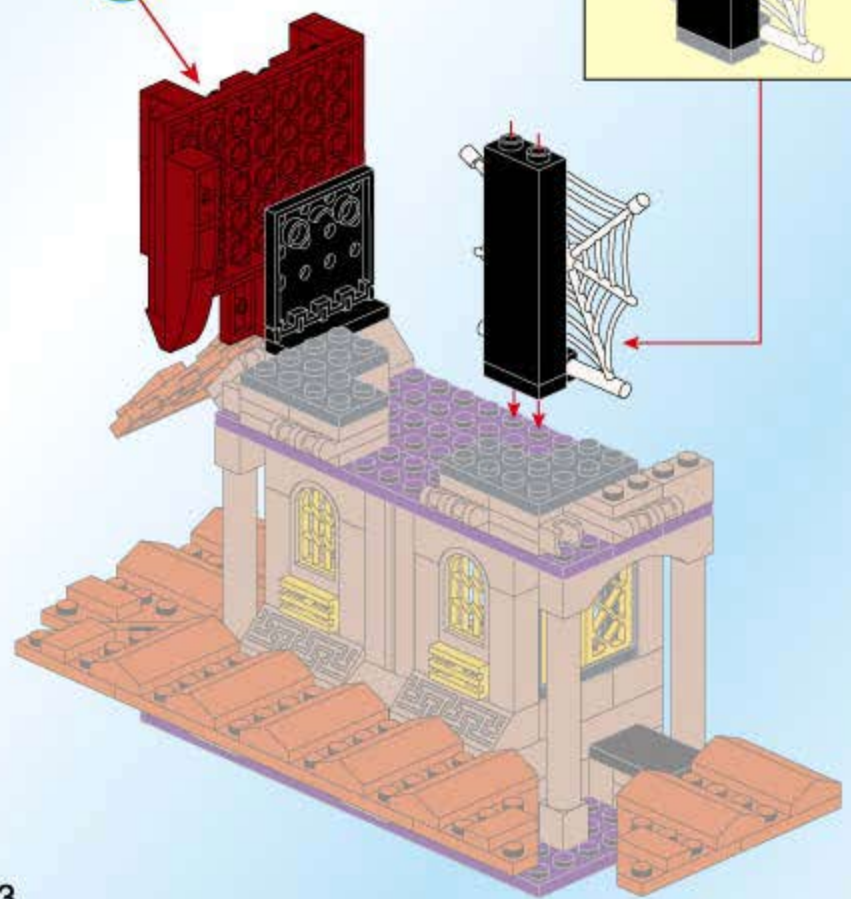

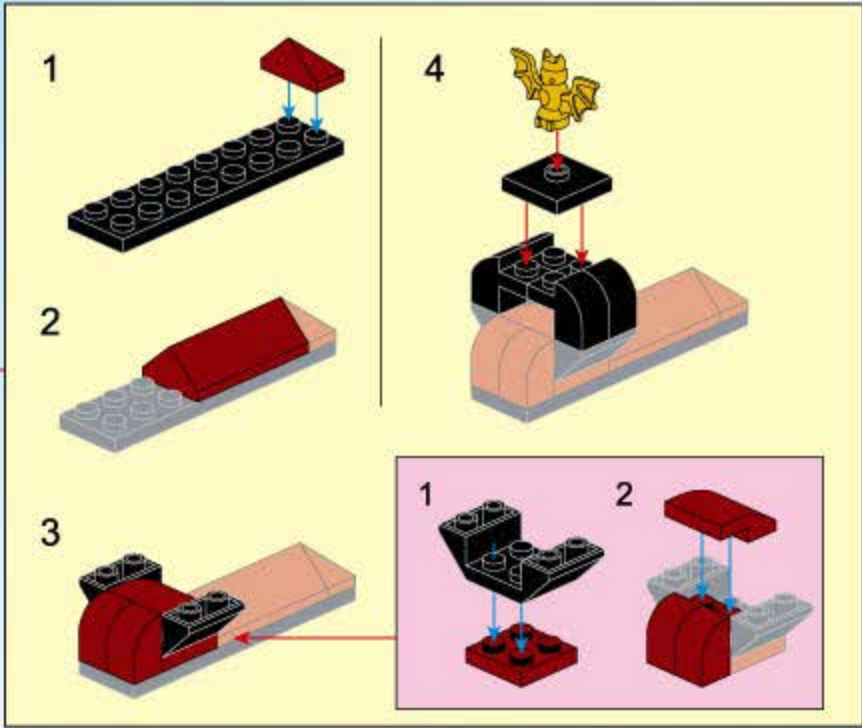
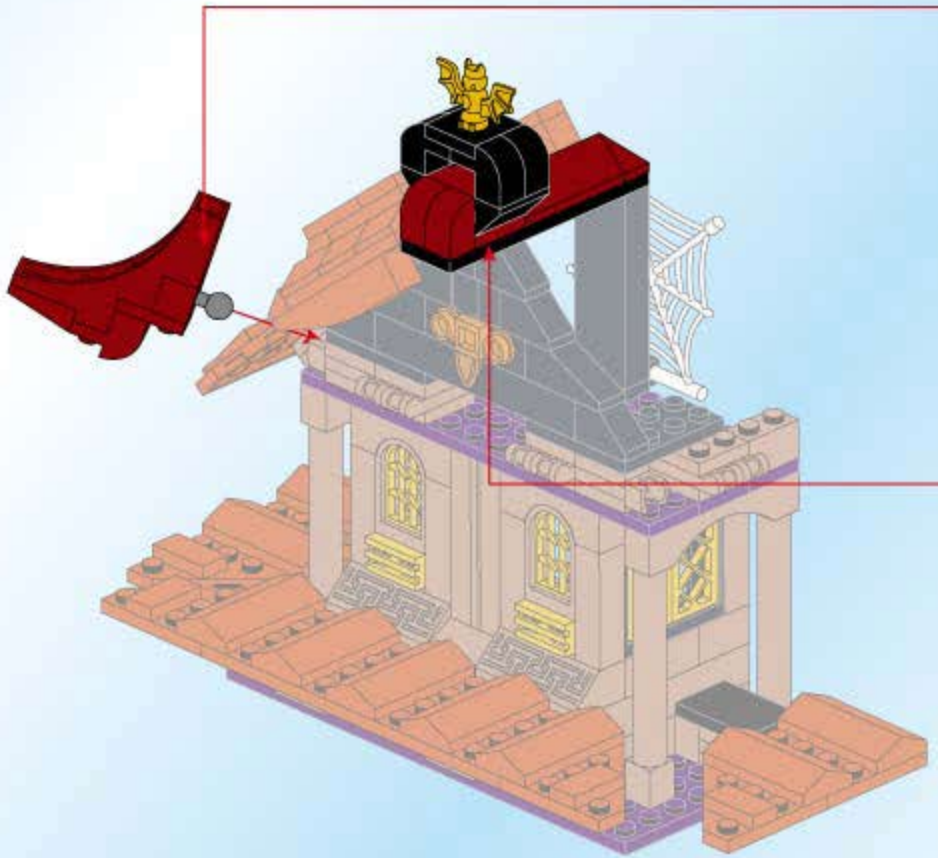
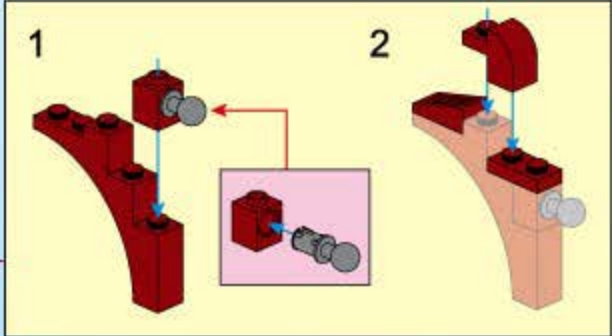
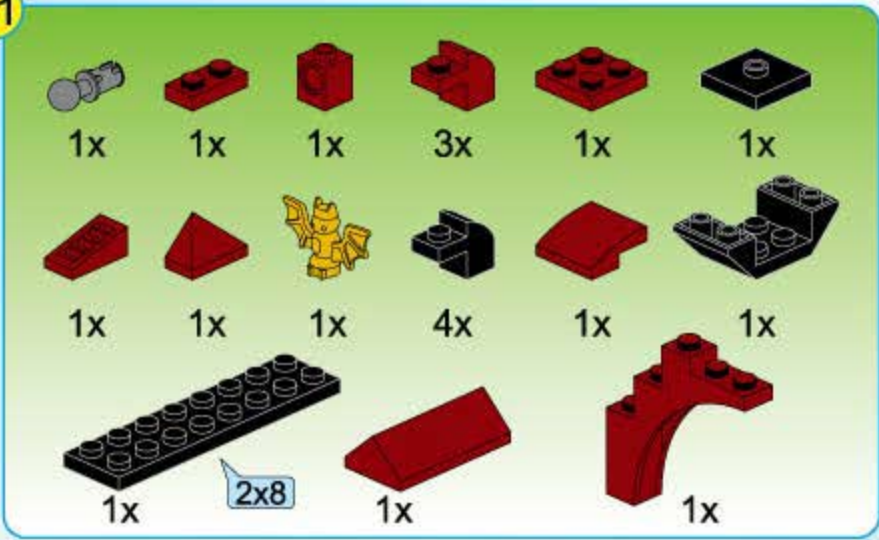

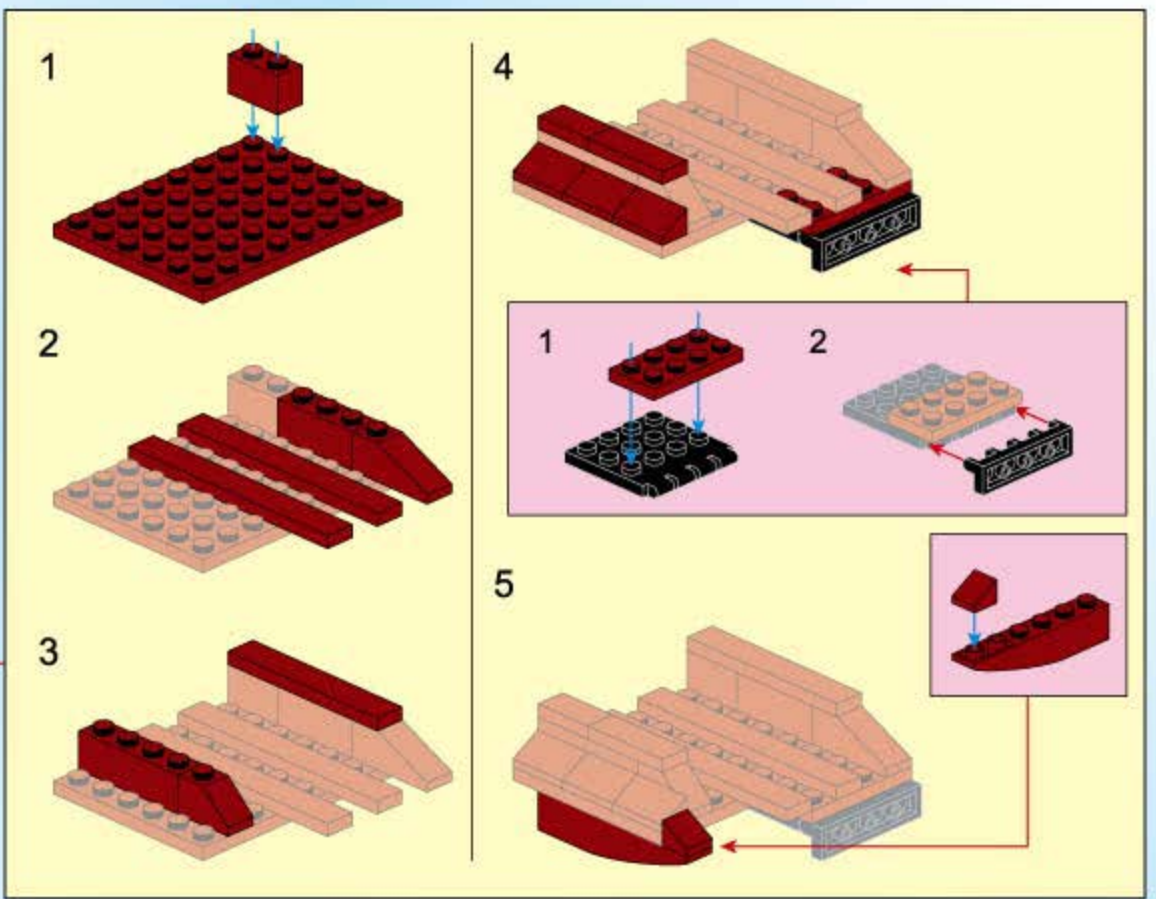
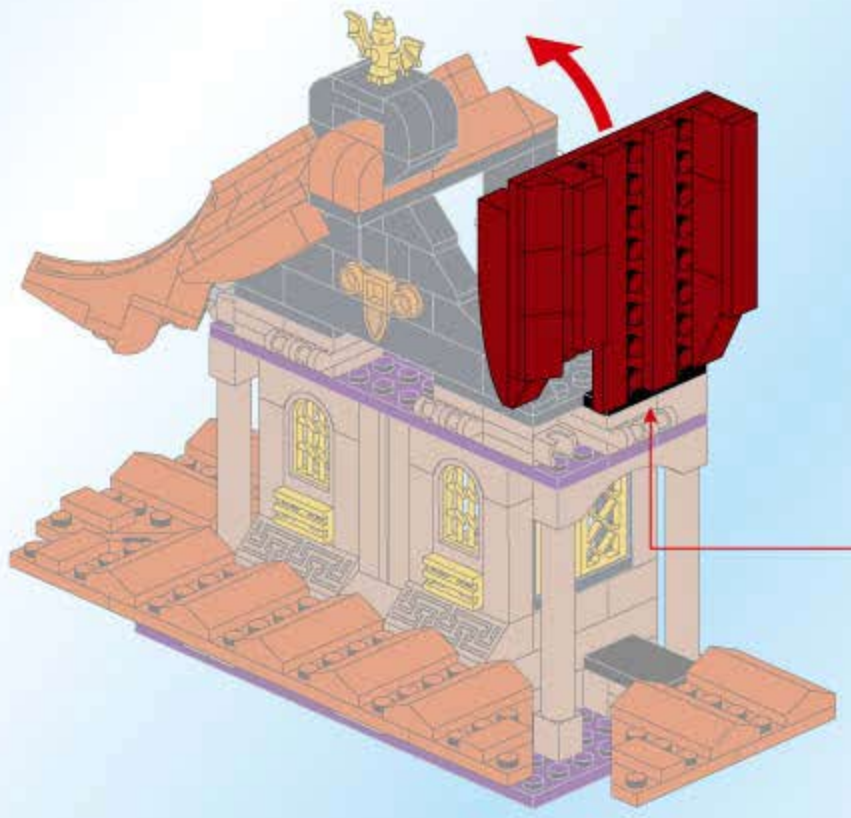
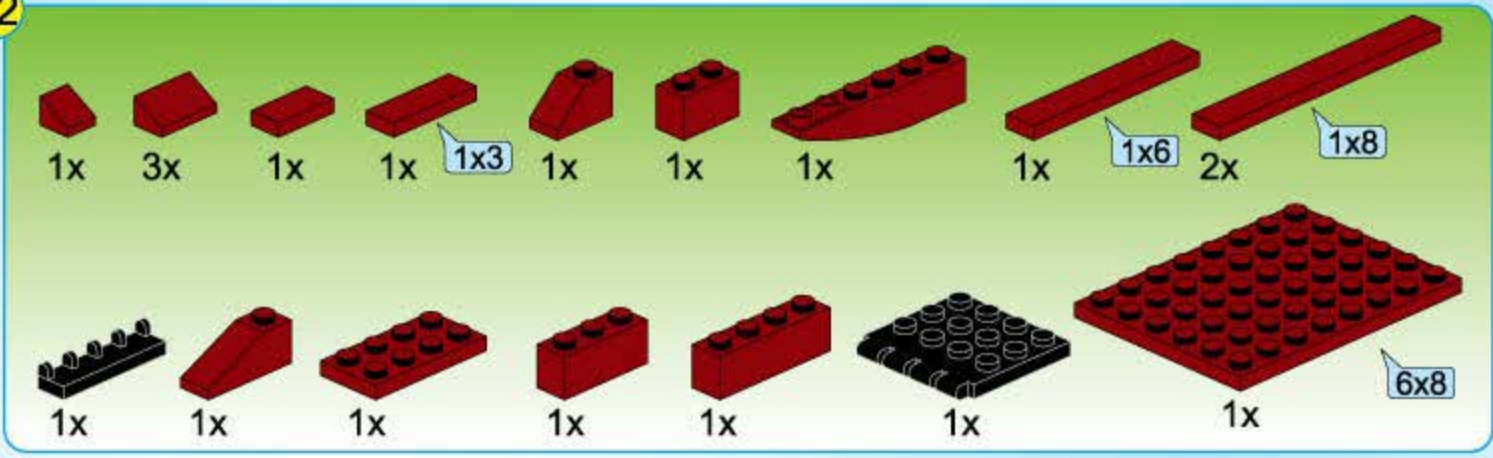

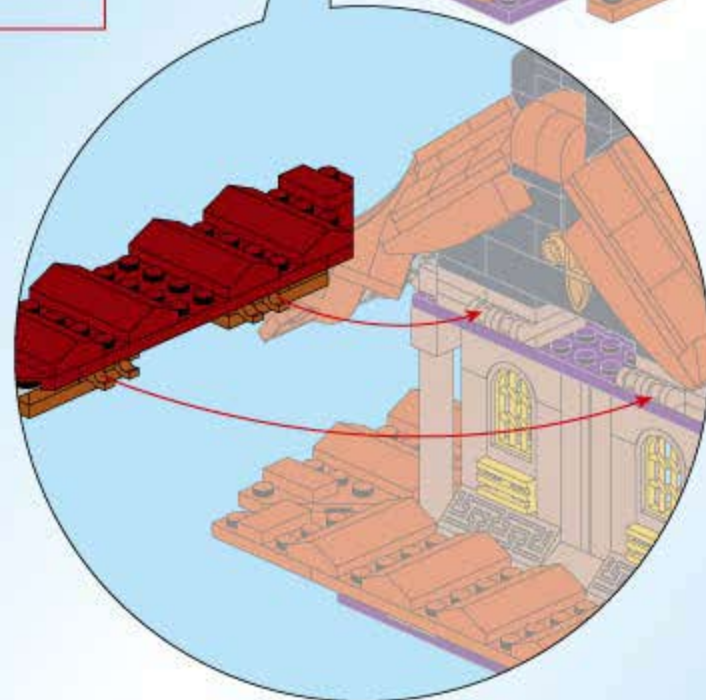
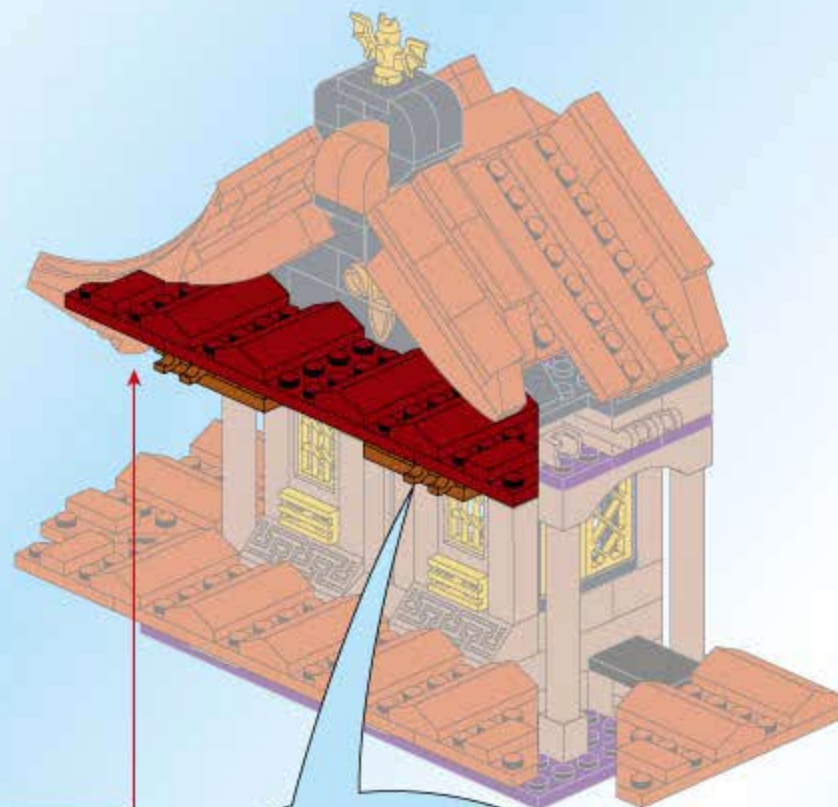
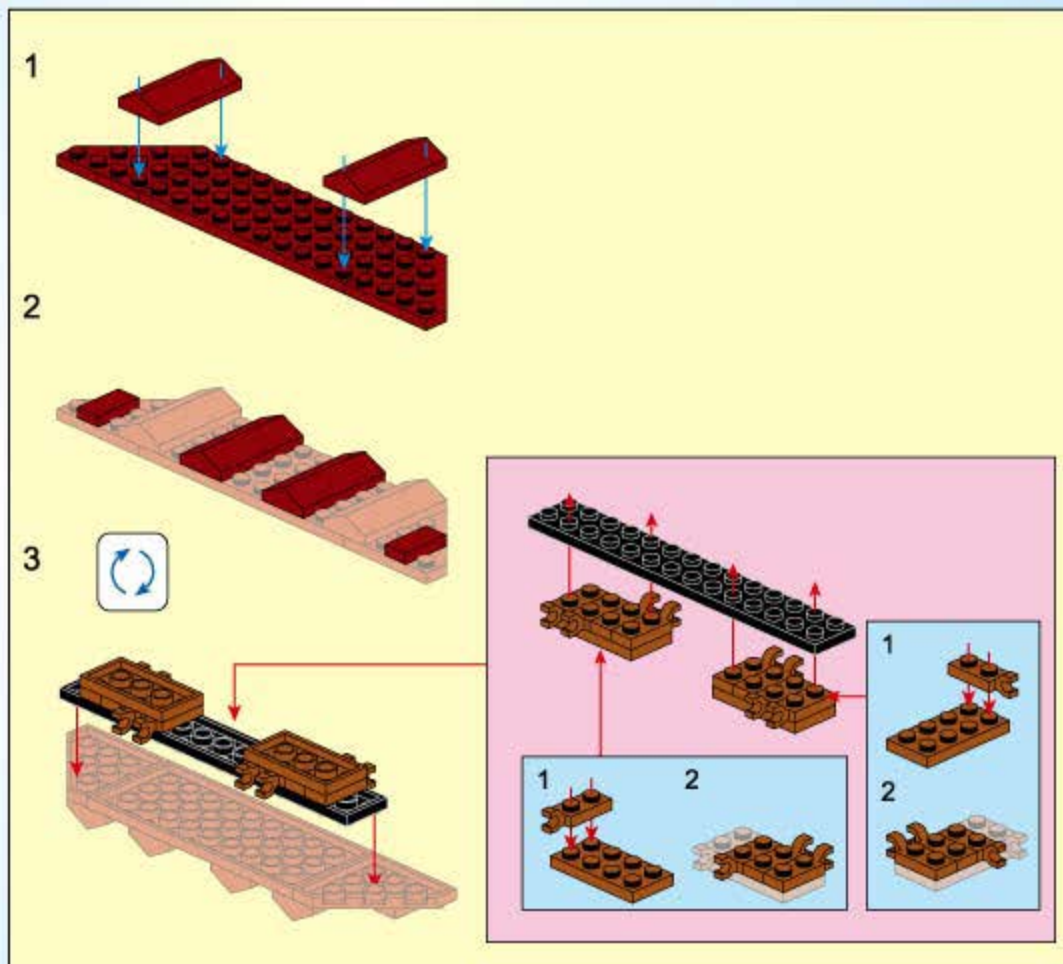
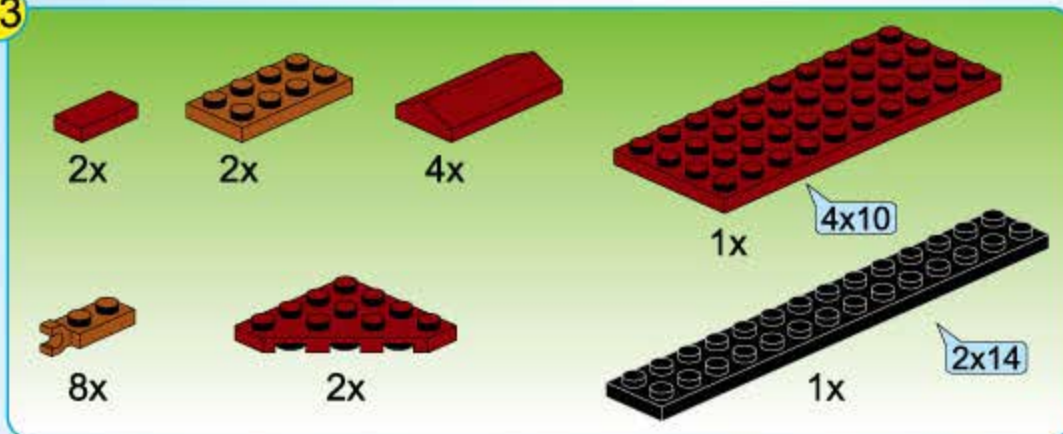

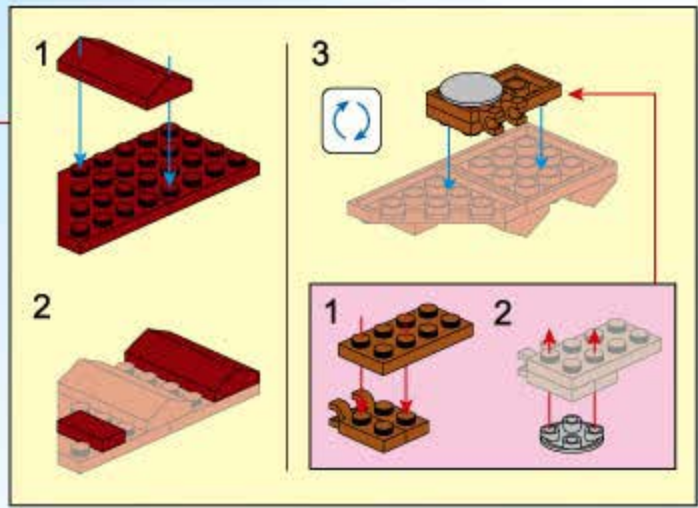
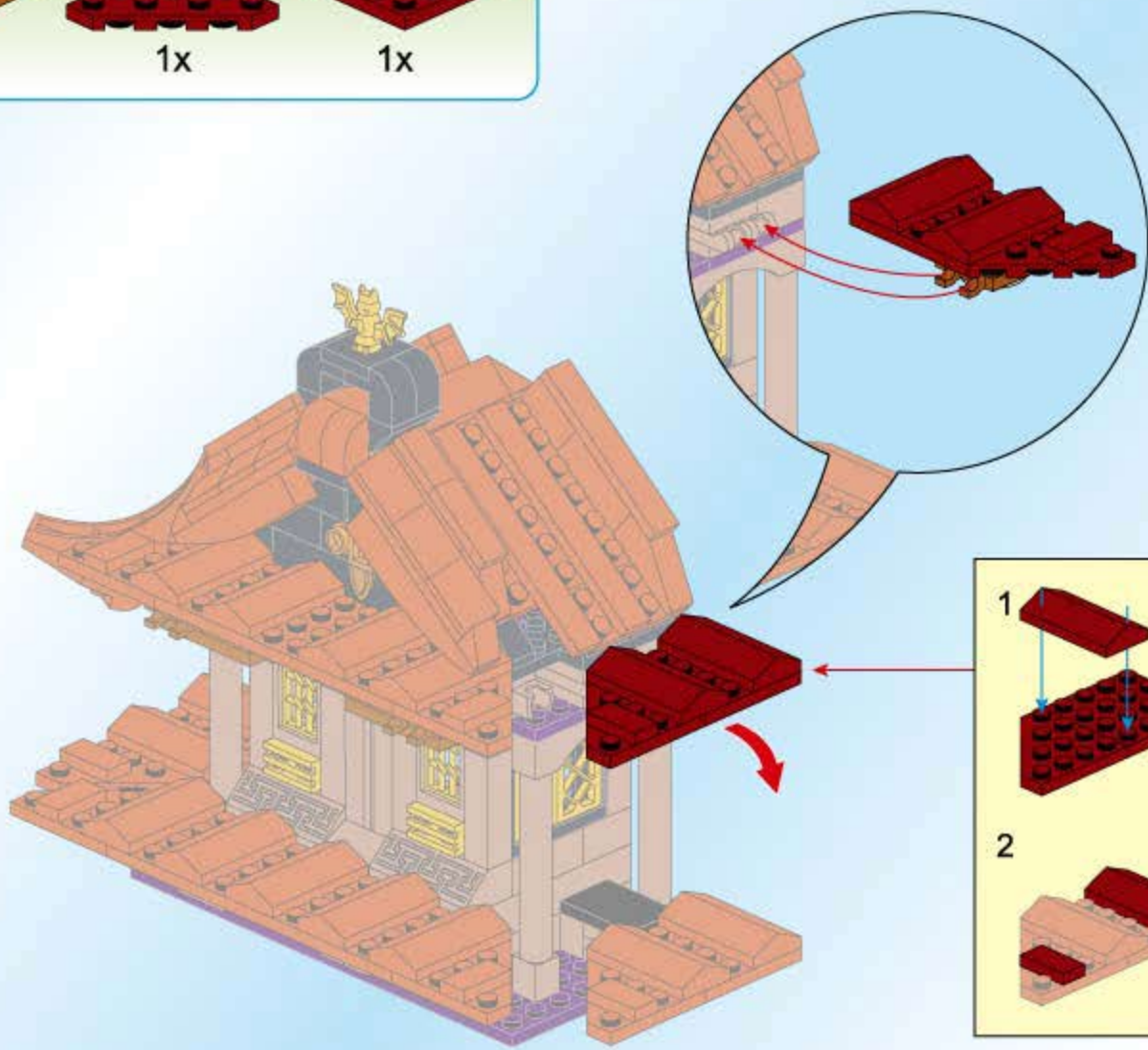
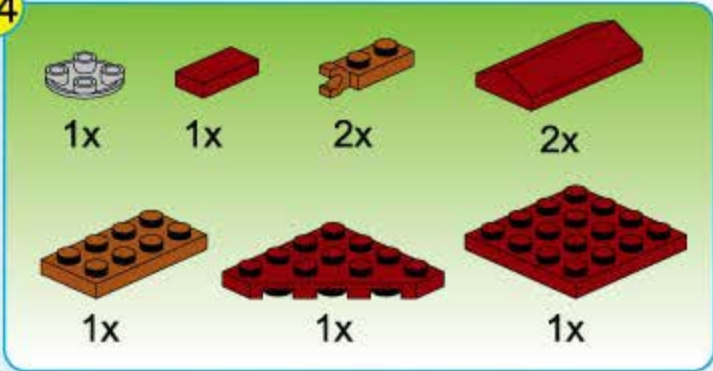

85

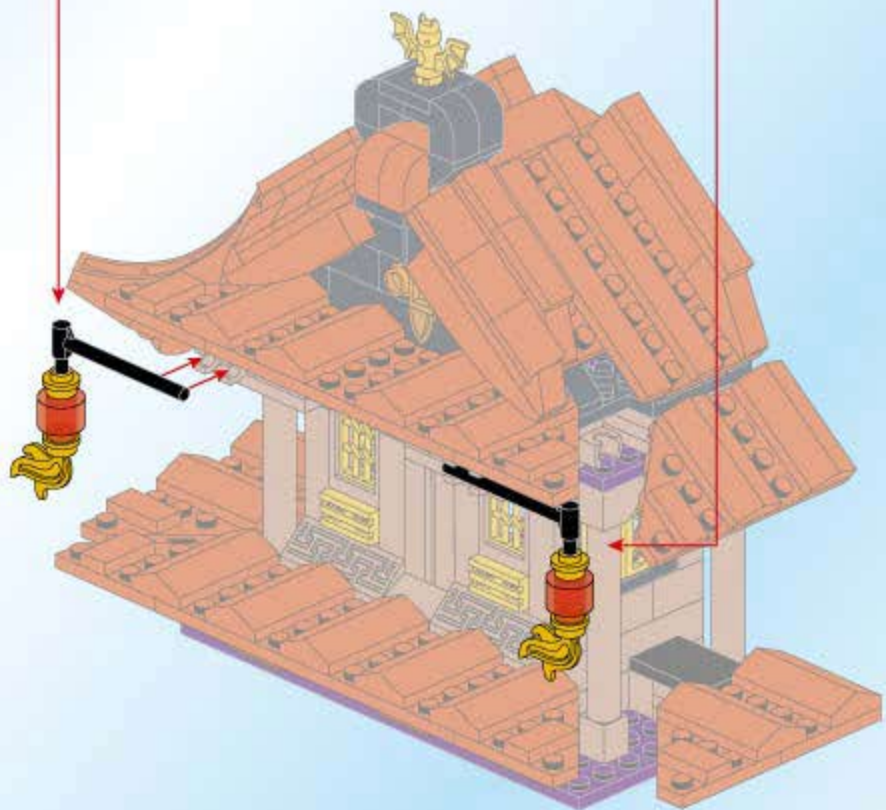
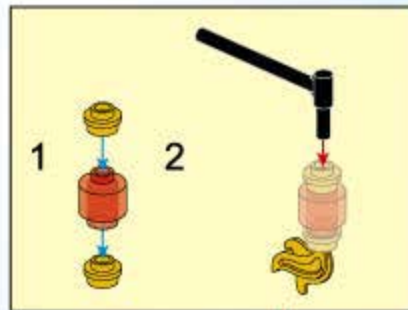
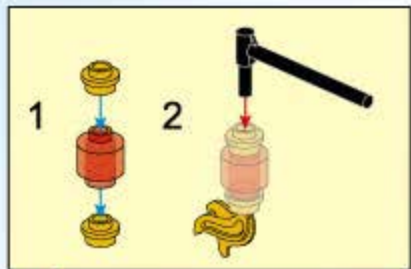

86

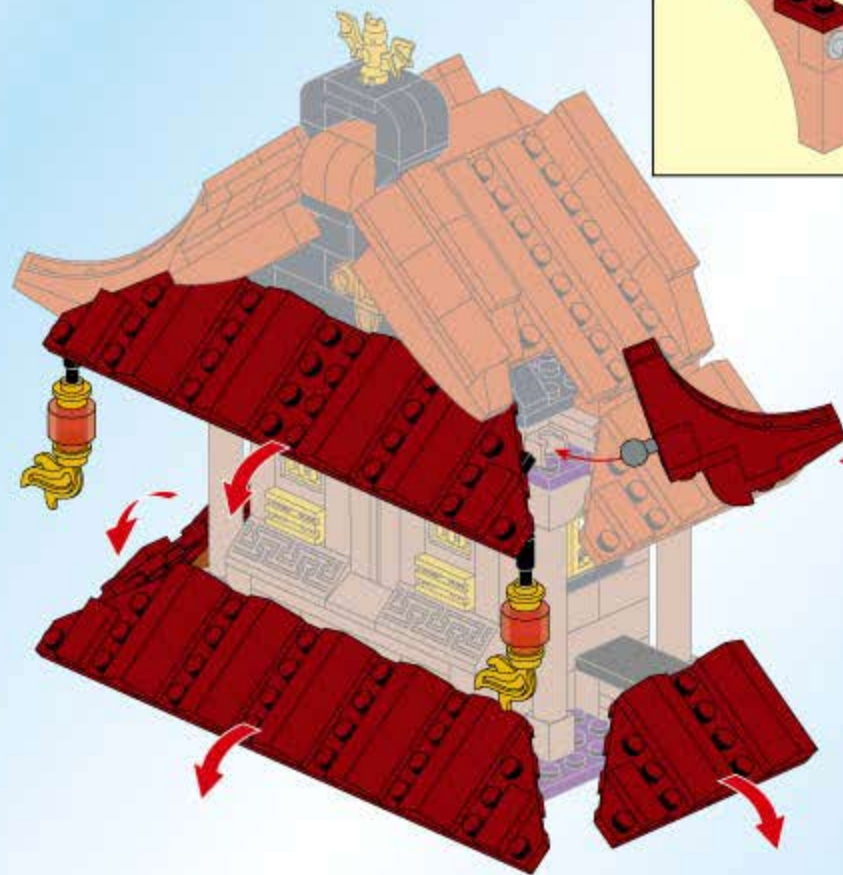
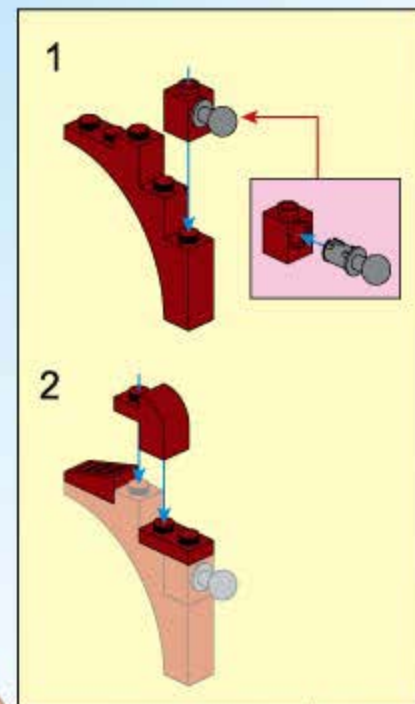
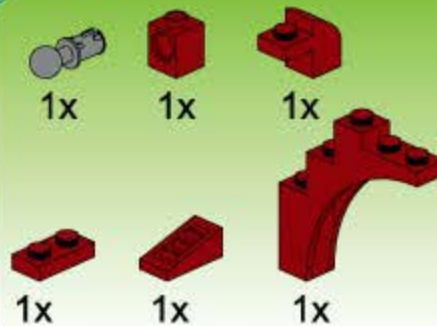

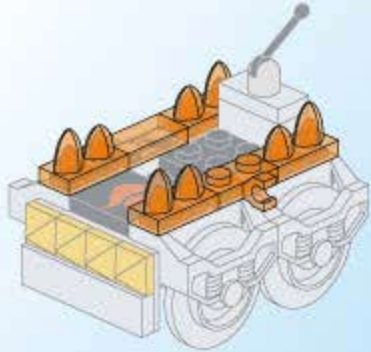
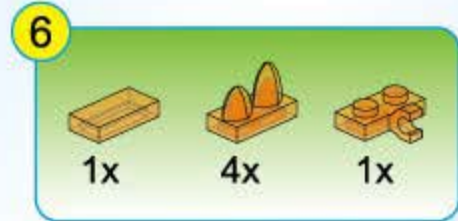
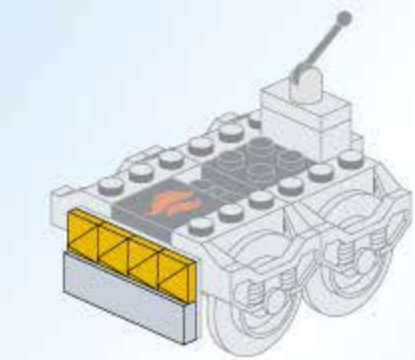
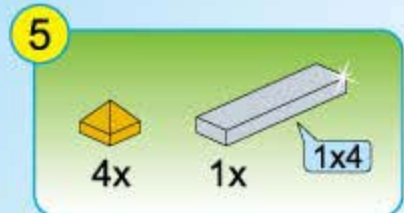
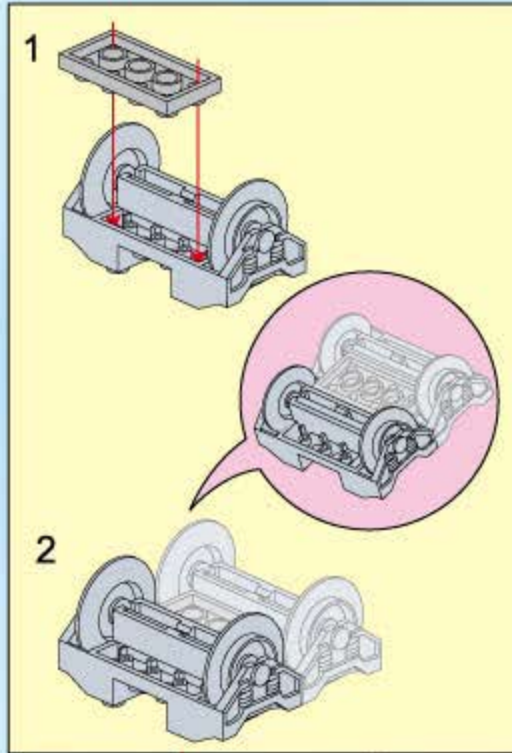
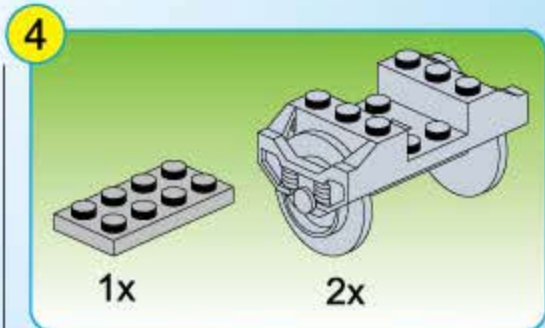
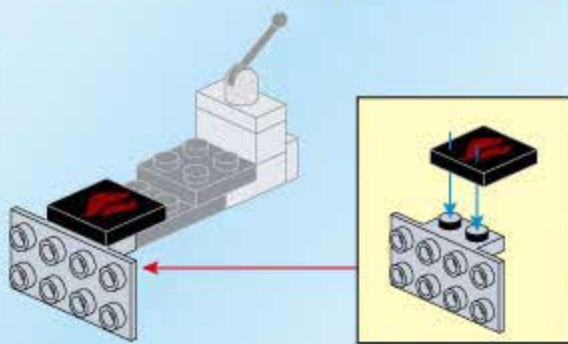
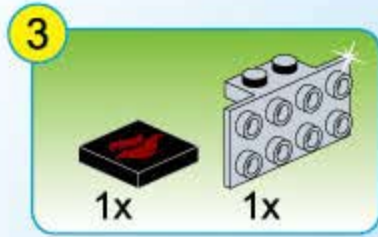
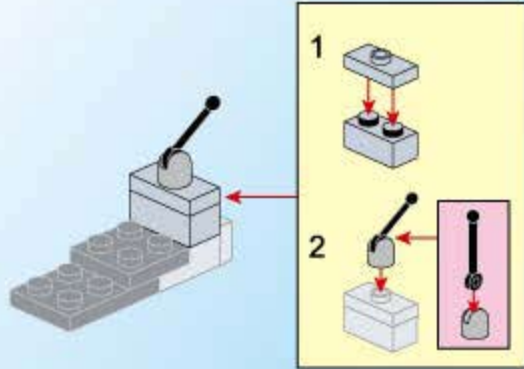
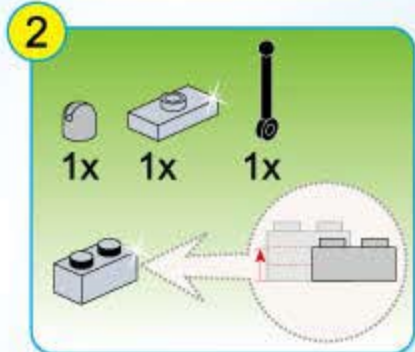
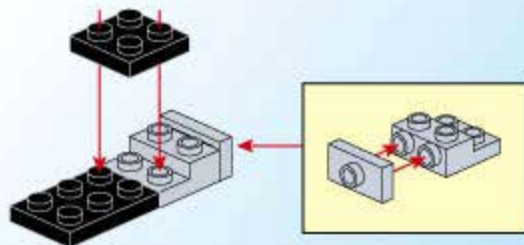
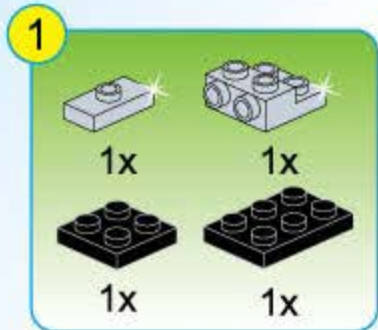
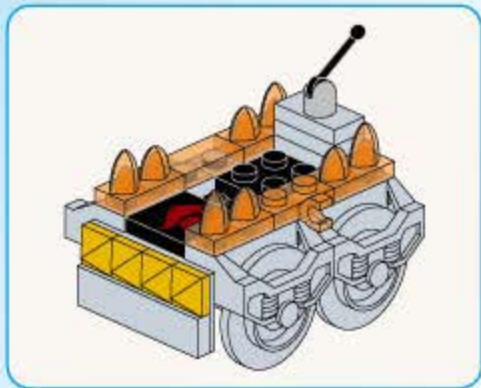





MONKEYKING

STORY OF WUKONG



3801 Monster Encounter



3802 Robbery of Mount Huaguo



3803 Execute Lady Skeleton



3804 Obstruction at Ridge Shituo



3805 Outwit Demon Brothers



3806 Battle with Bull Demon



3807 Fight the Red Boy

