

Qman

3804

Ages: 6+

Minifigs: X2

PCS: 420

MONKEY KING

STORY OF WUKONG



Obstruction at Ridge Shituo

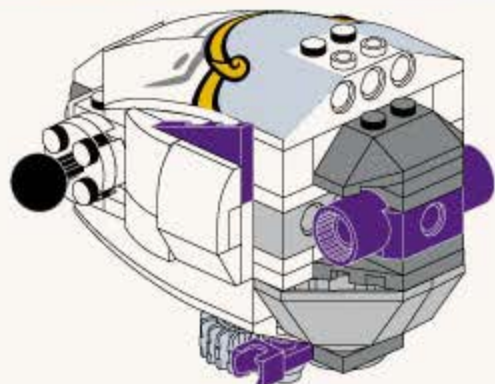
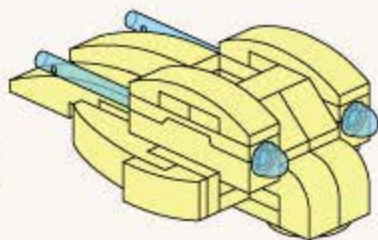

拆件器使用方法, 仅为示例

Usage of Brick Separator, Just for the sample

1

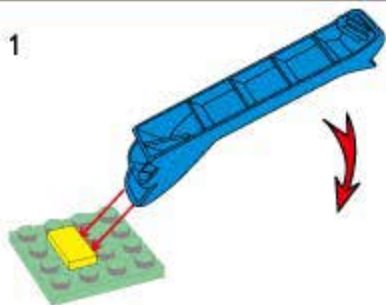

2

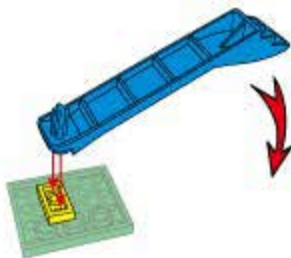

3

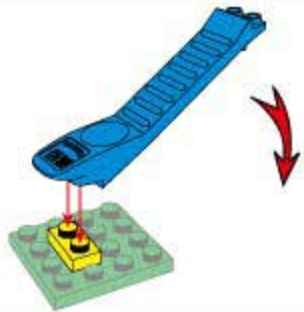

4

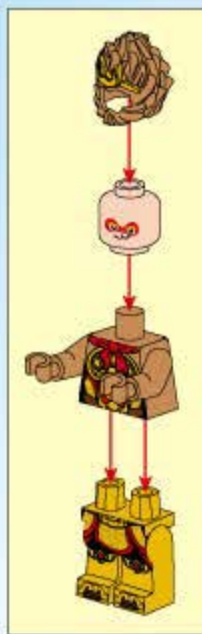
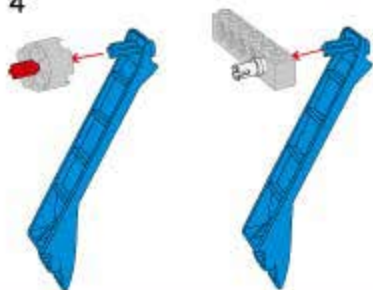

sketch map of fitting hand
装手示意图



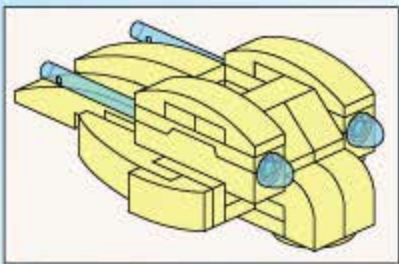

A1

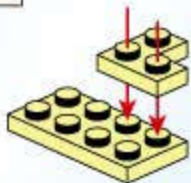
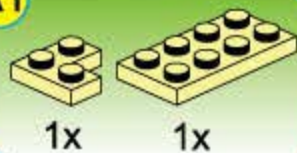

A2

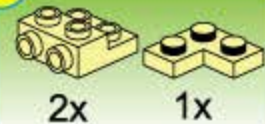

A3

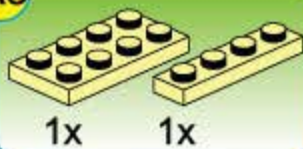

A4

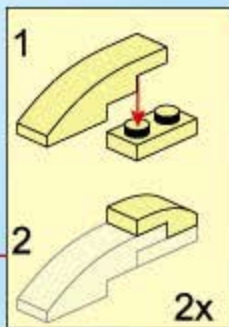
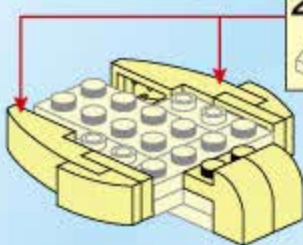
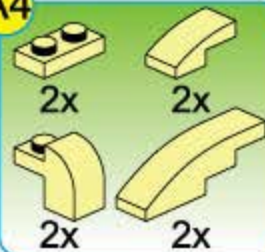

A5

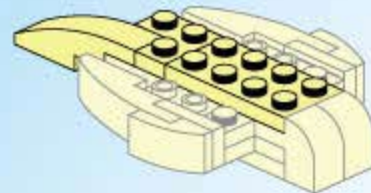
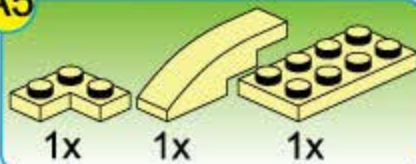

A6

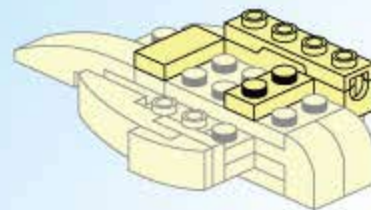
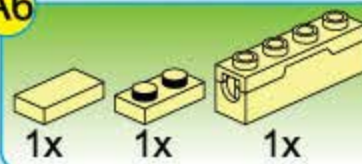

A7

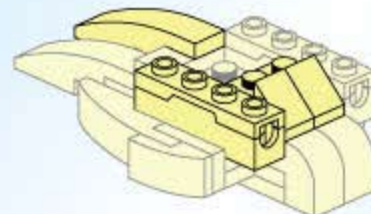
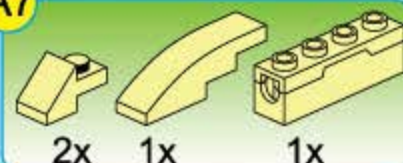

A8

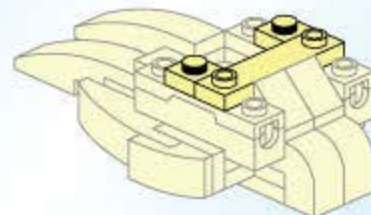
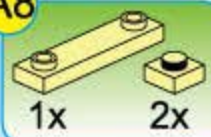

A9

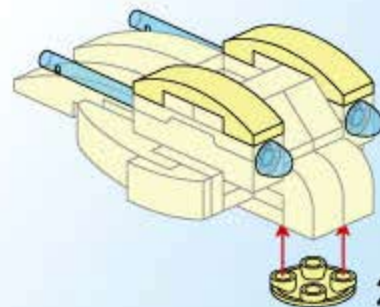
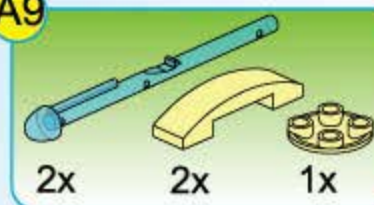

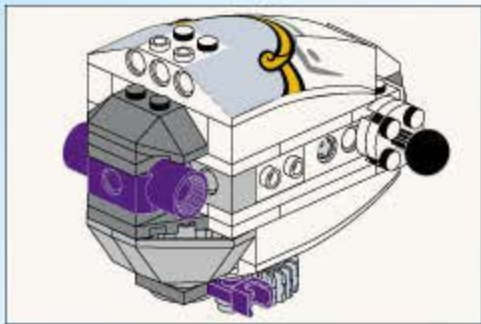

B1

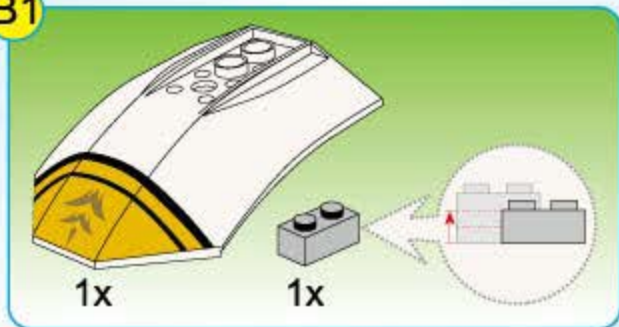

B2

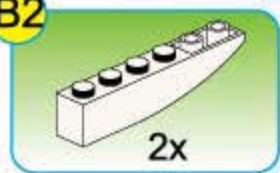

B3

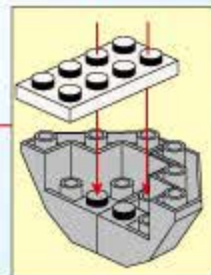
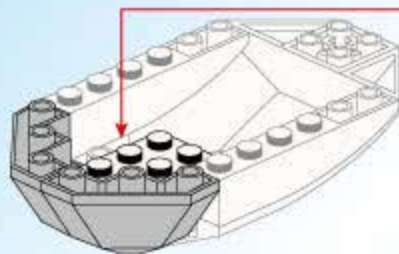
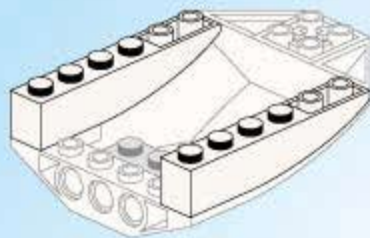
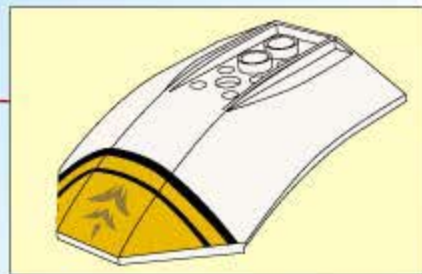
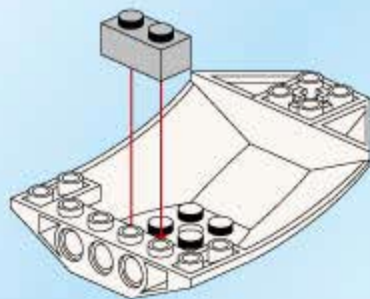
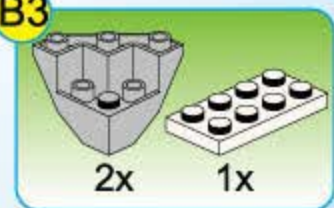

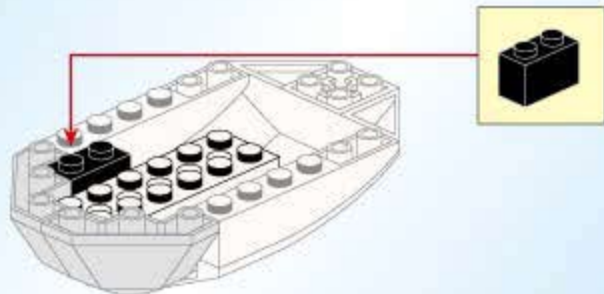
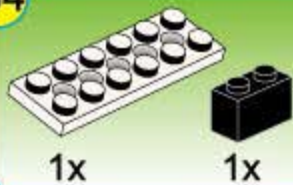
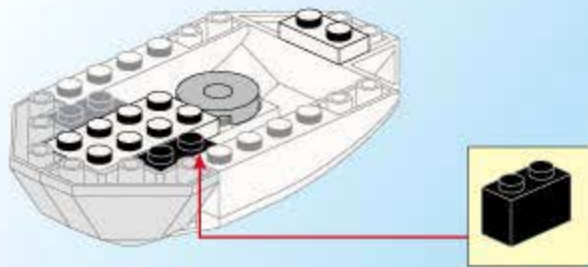
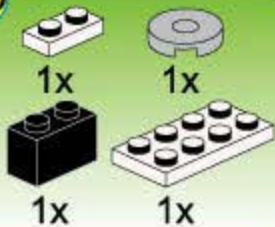
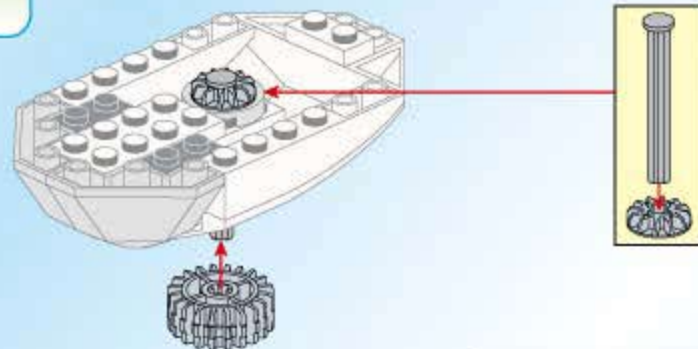
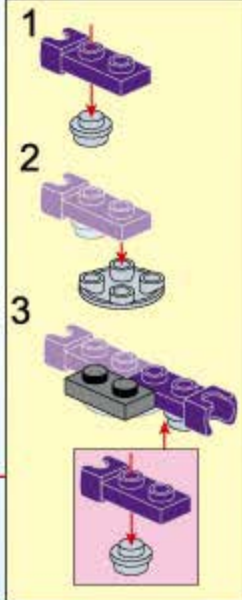
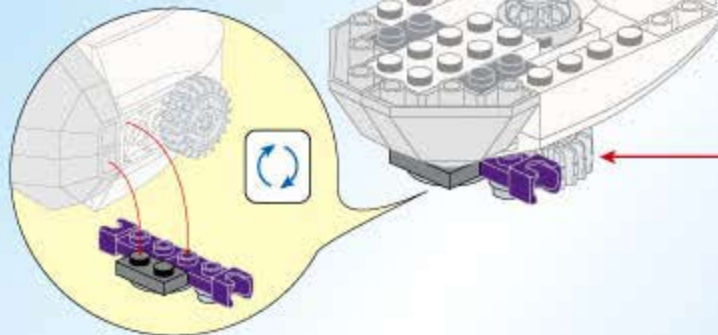
B4**B5****B6****B7**

B8

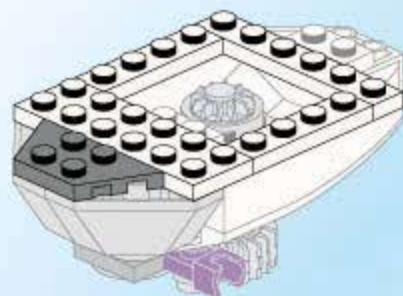
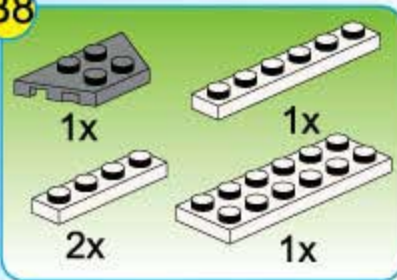

B9

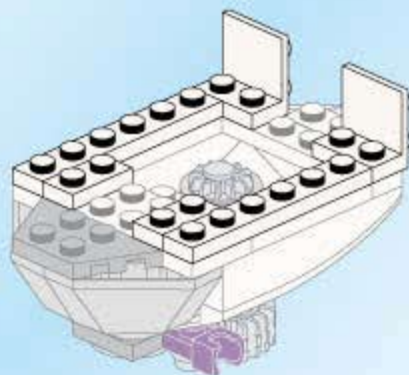
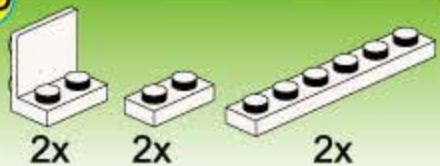

B10

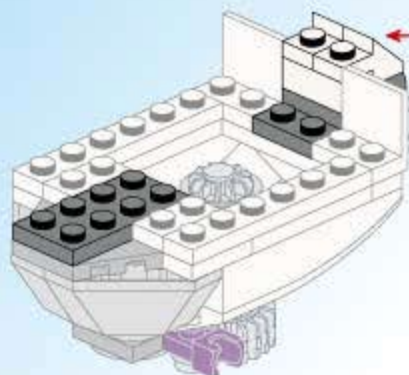
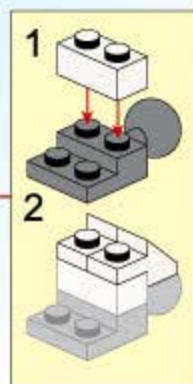
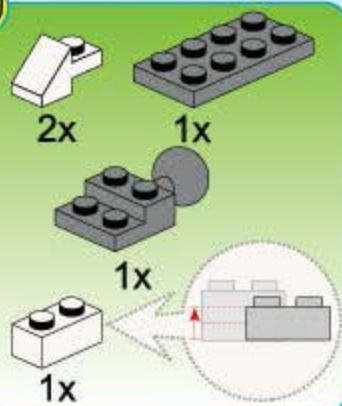

B11

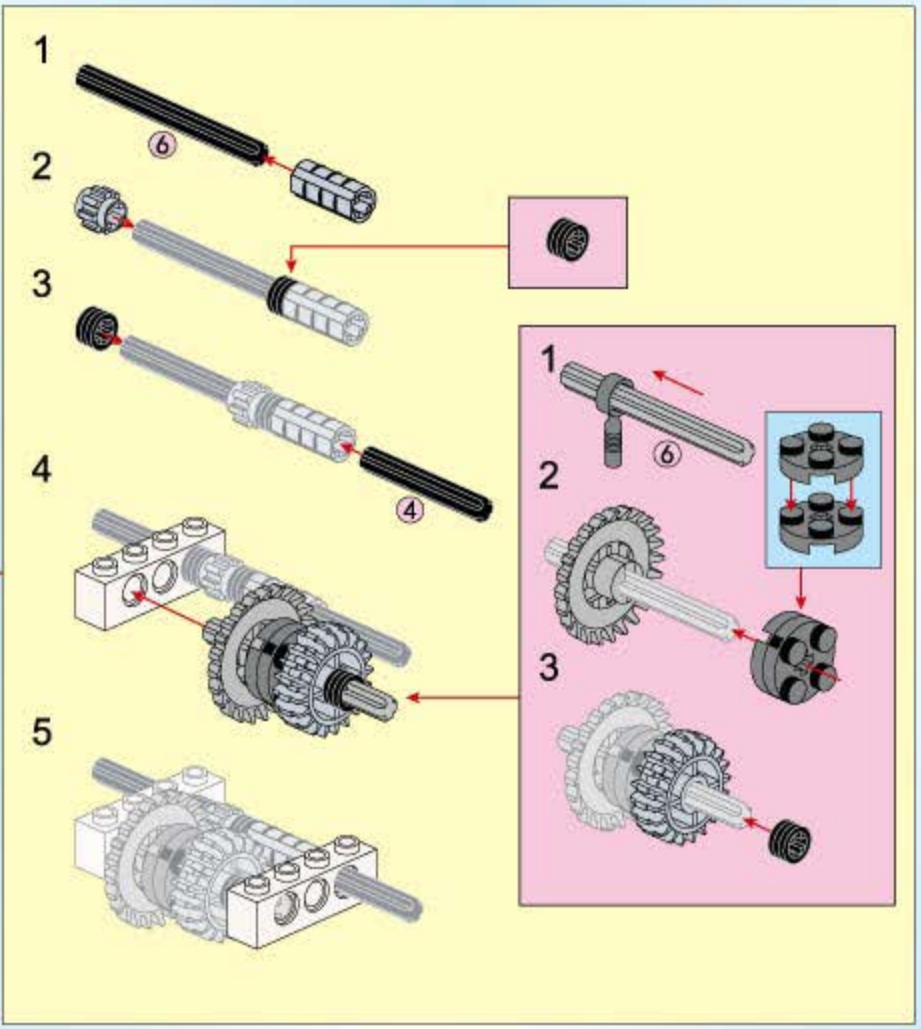
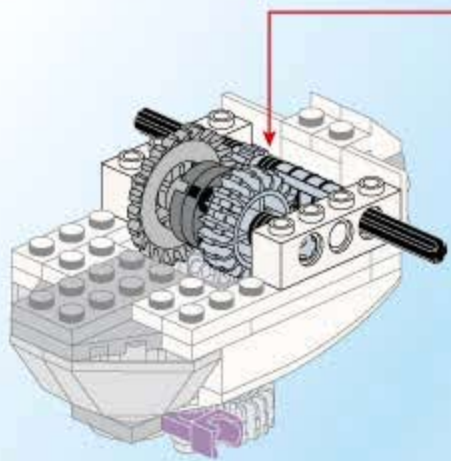

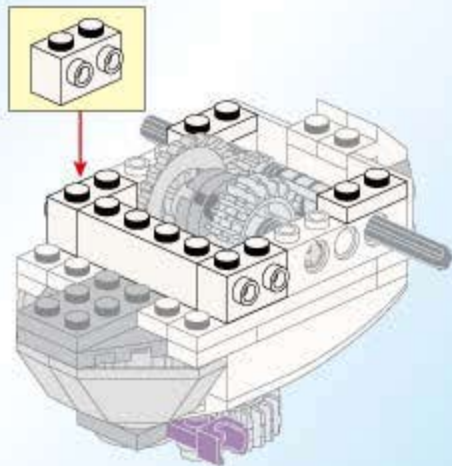
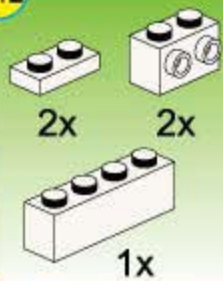
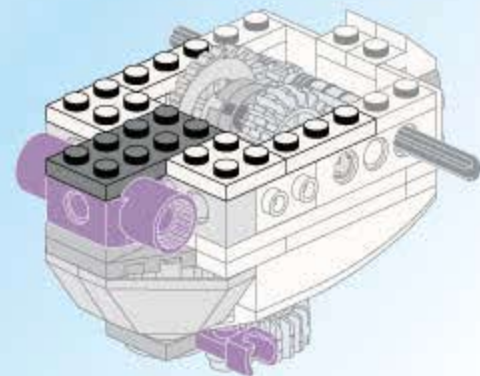
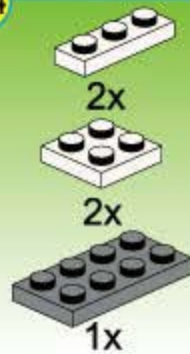
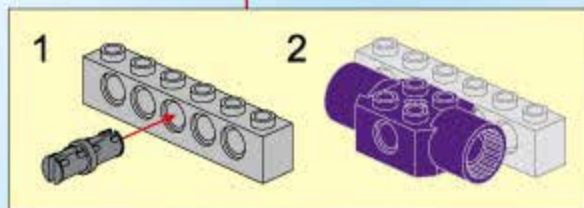
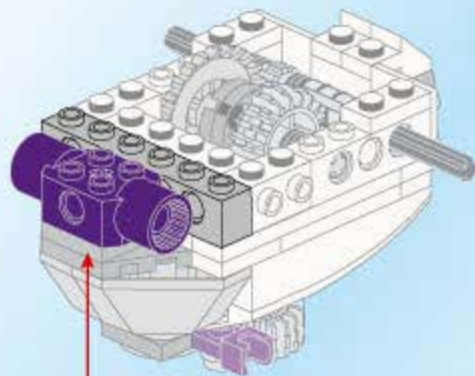
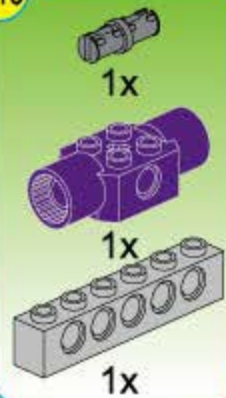
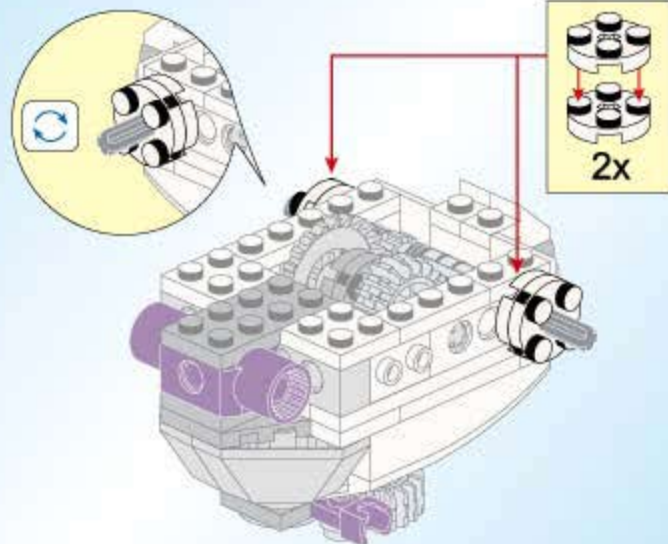
B12**B14****B13****B15**

B16



2x



1x



2x

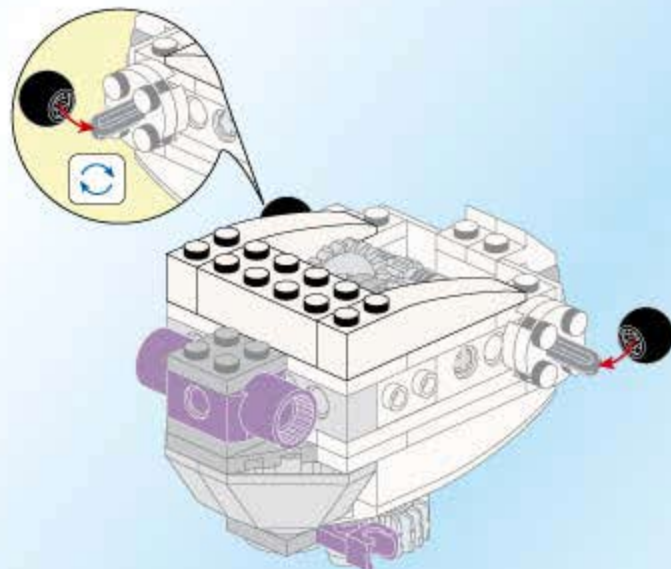

B17



1x



1x

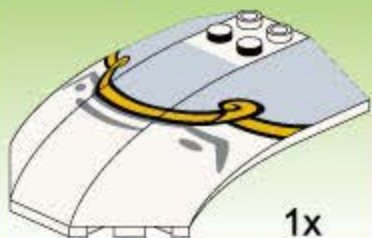

1x

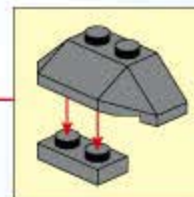
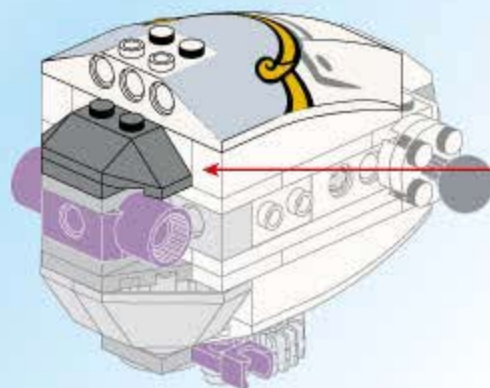

B18

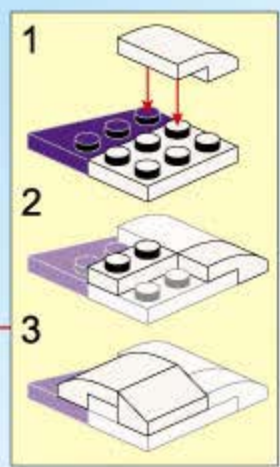
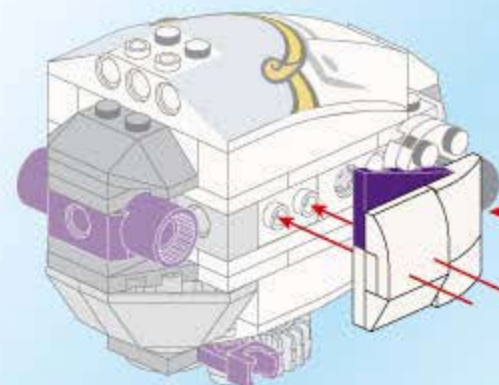
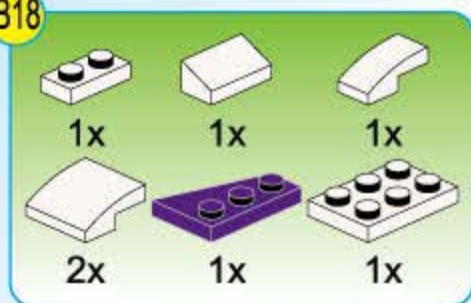

B19

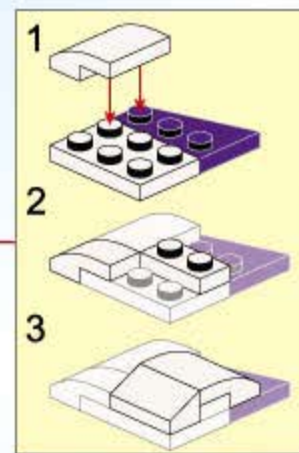
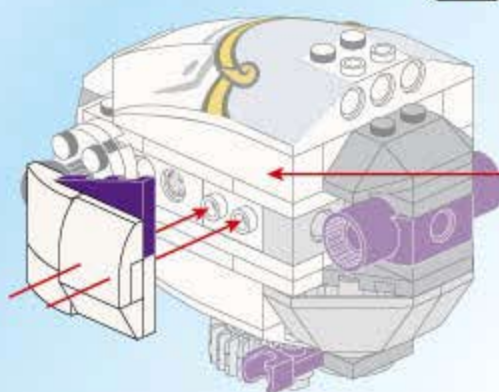
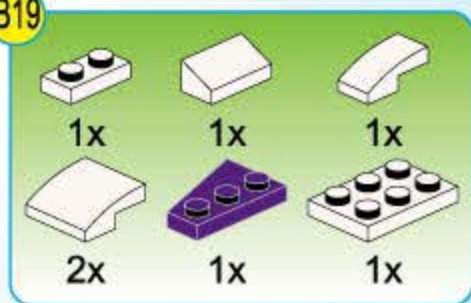

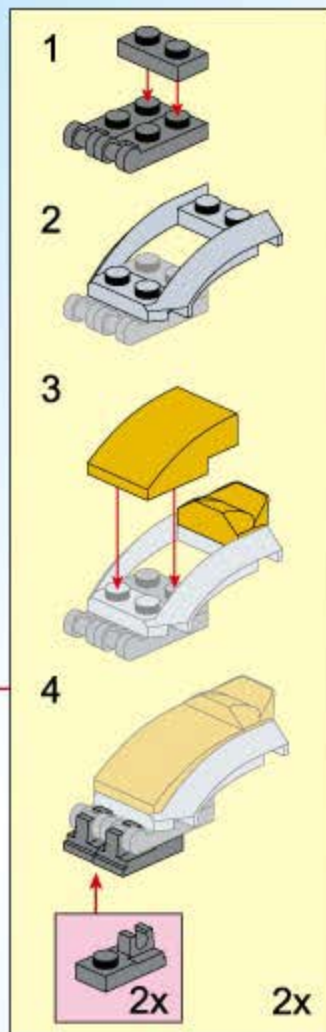
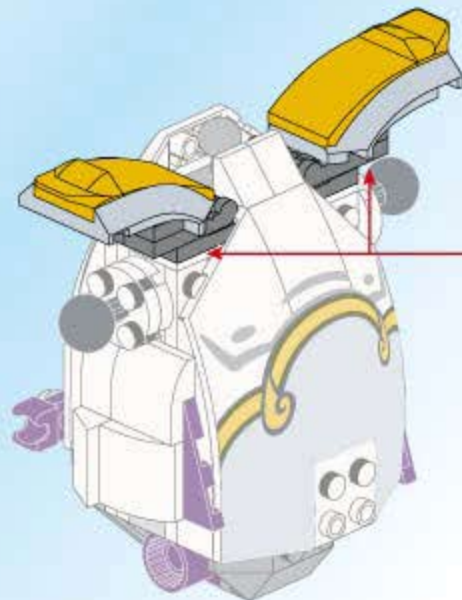
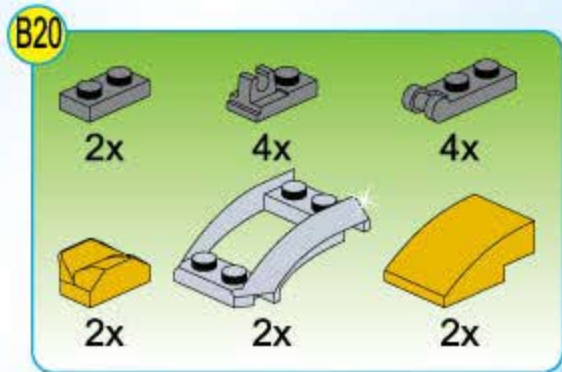
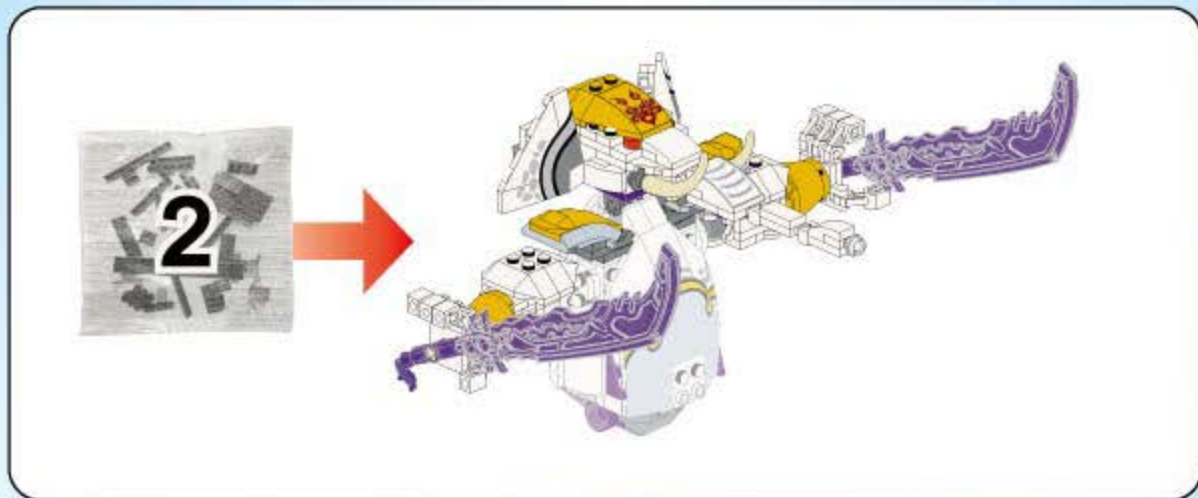

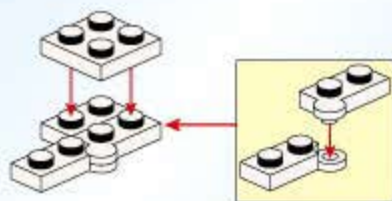
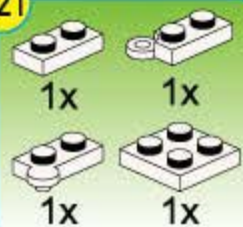
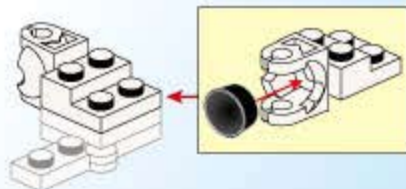
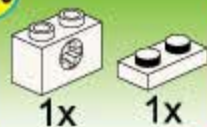
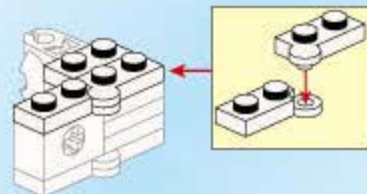
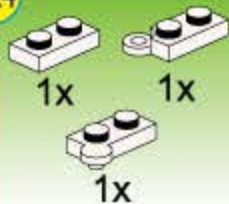
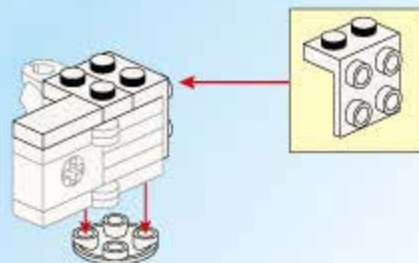
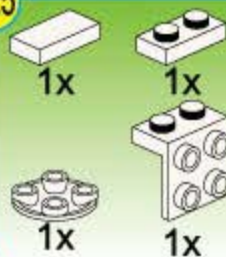
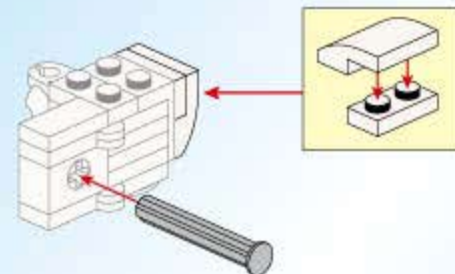
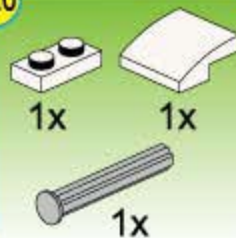
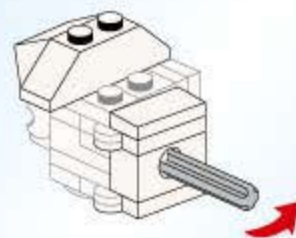
B21**B22****B23****B24****B25****B26****B27****B28**

B29



1x



B30



1x

1x

1x



1x



4x

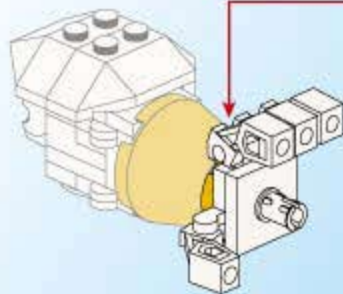

1



2



3



4

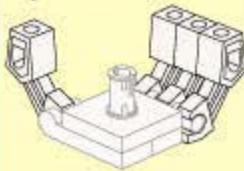

B31

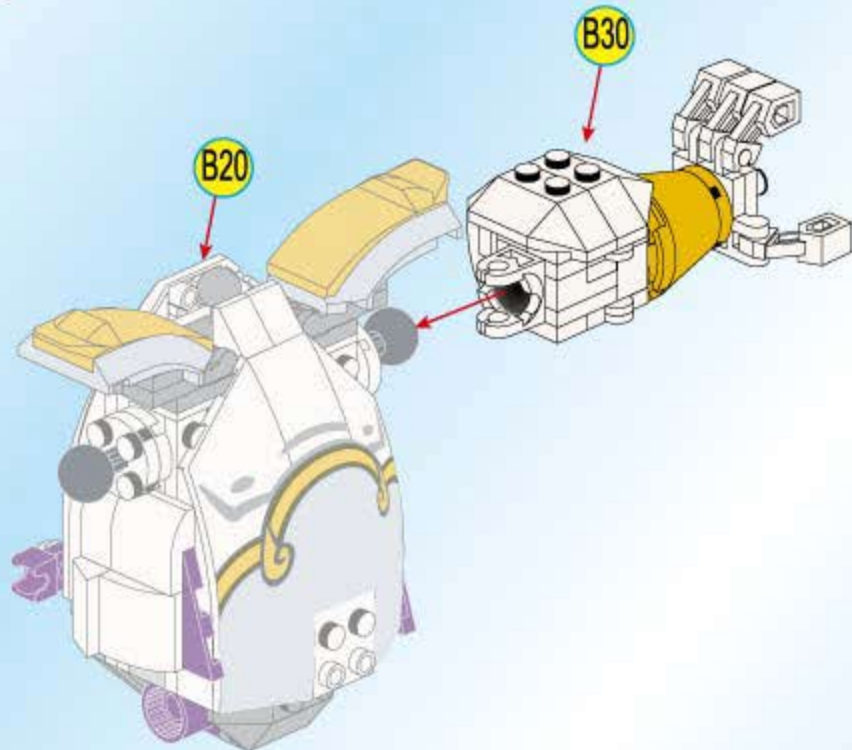

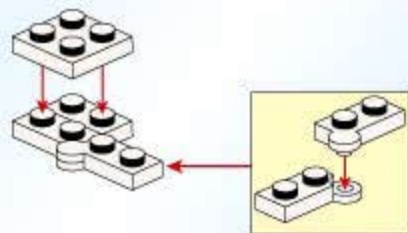
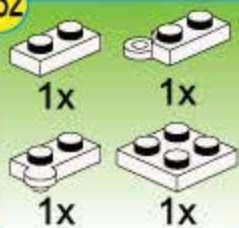
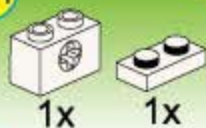
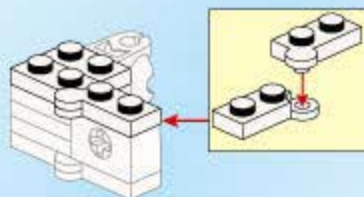
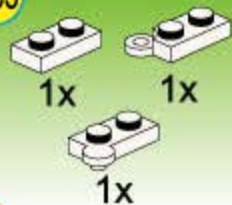
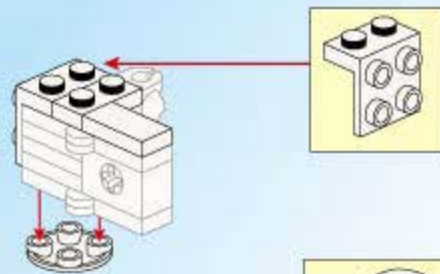
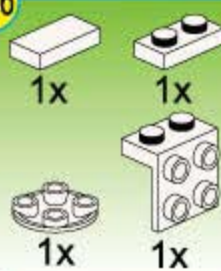
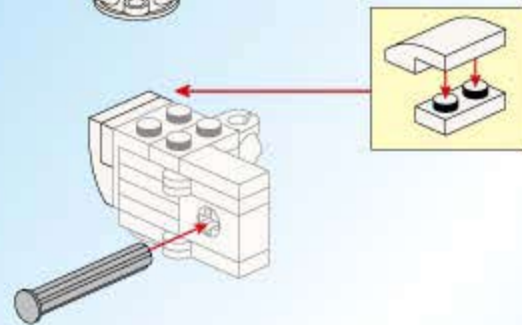
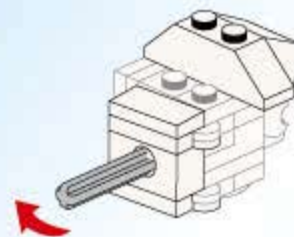
B32**B33****B34****B35****B36****B37****B38****B39**

B40

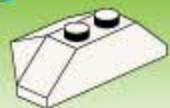

1x



B41



1x

1x

1x



1x



4x

1



2



3



4

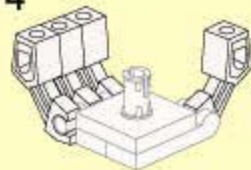

B42

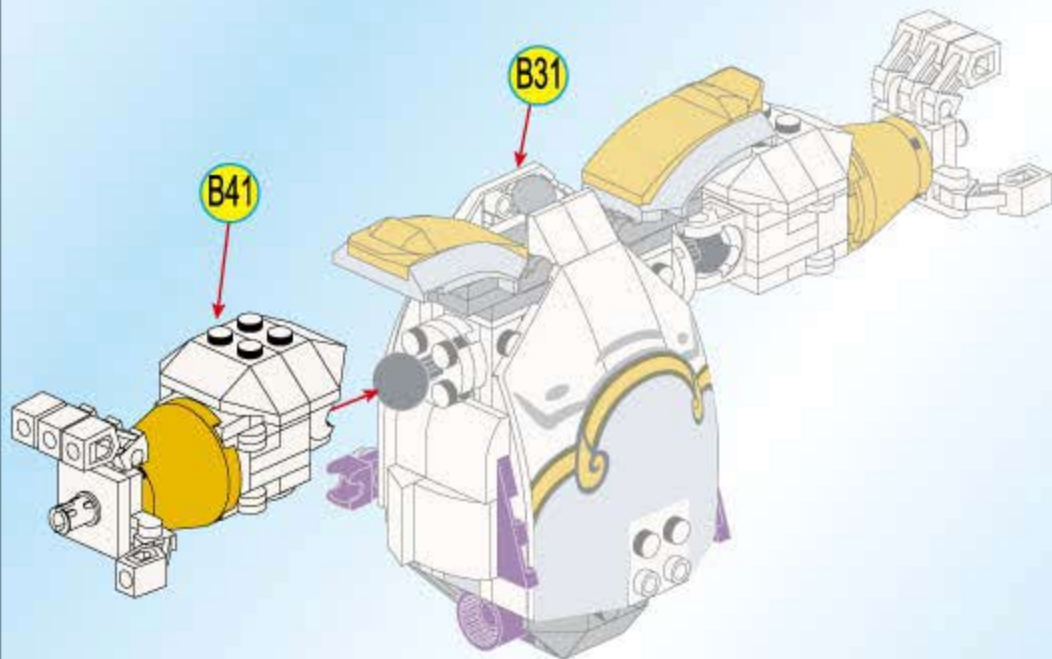

B43



2x



2x



2x



2x

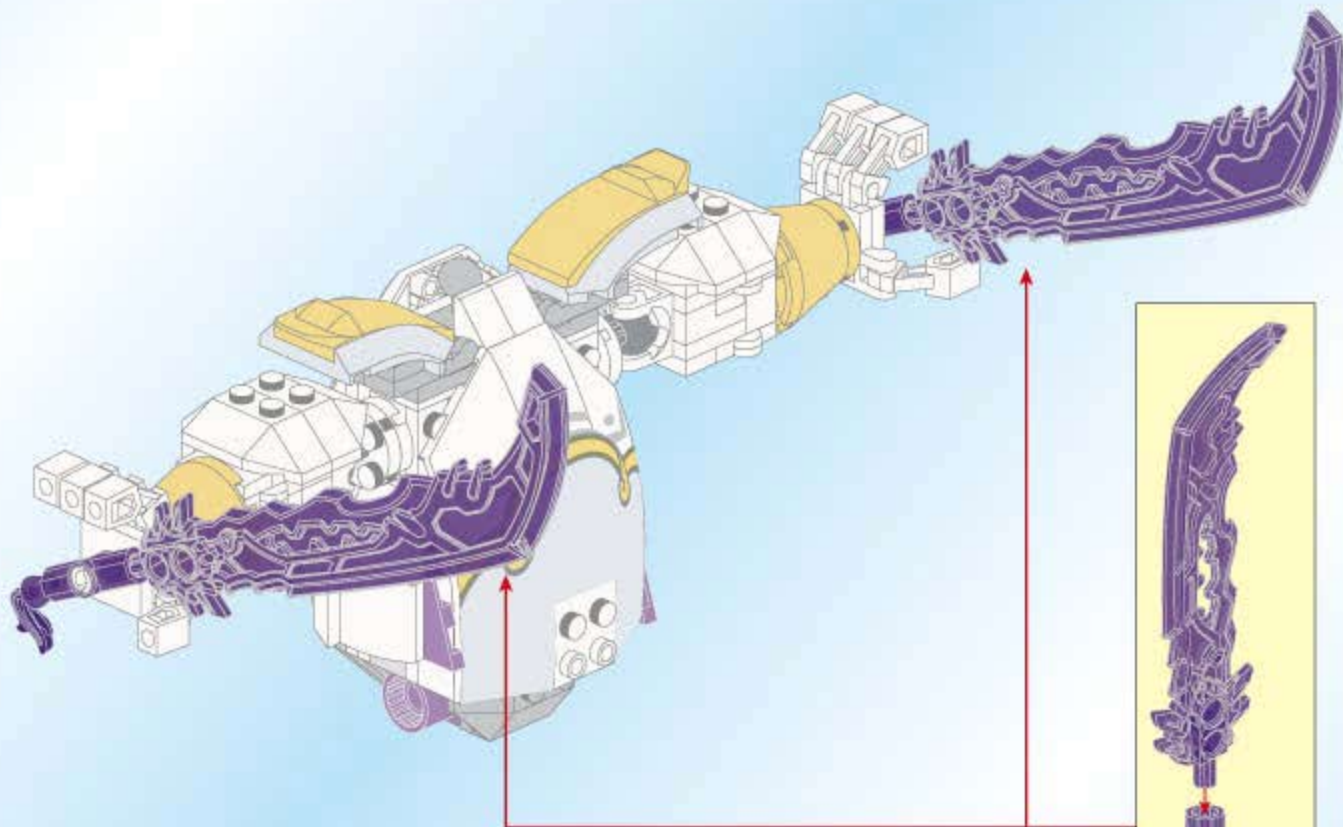

2x

B44

1x 1x

B45

2x 4x 2x

B46

2x 2x

B47

1x 1x

B48

2x 2x

1x

B49

1x 1x



B50

1x 1x

1x 1x

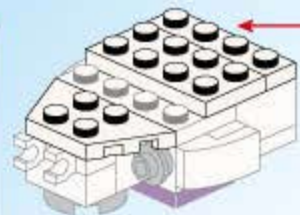

1

2

B51

2x 2x

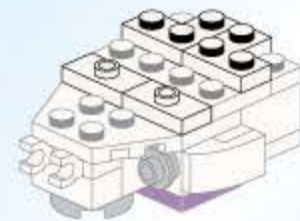

B52

2x 2x

1x 1x

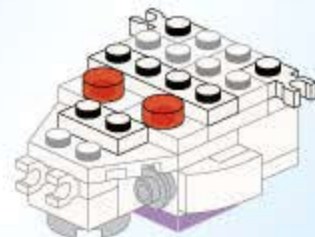

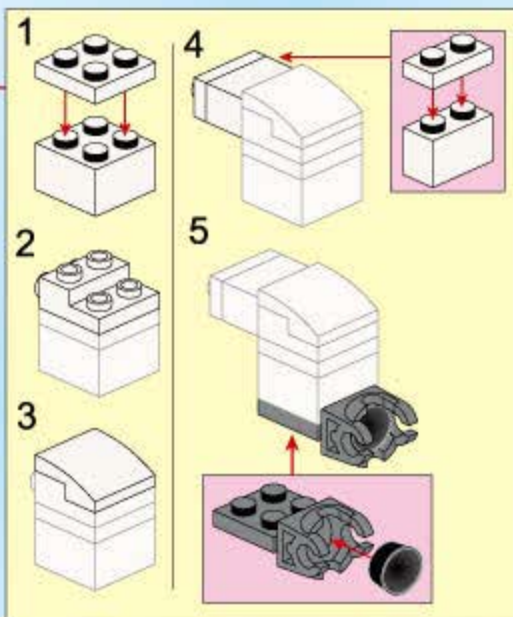
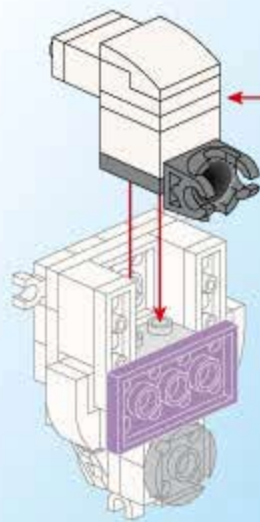
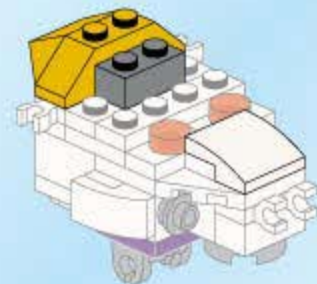
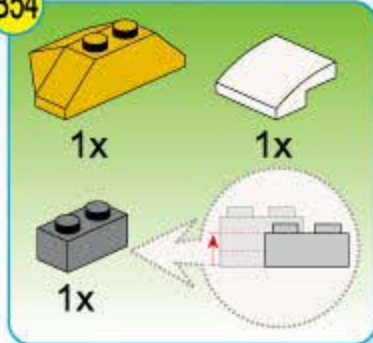
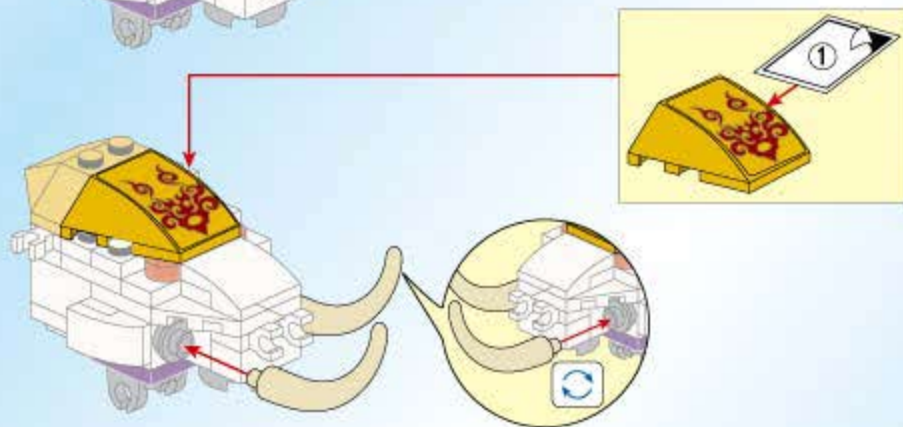
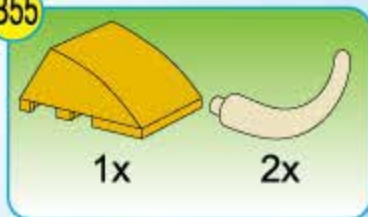
B53**B54****B55**

B56

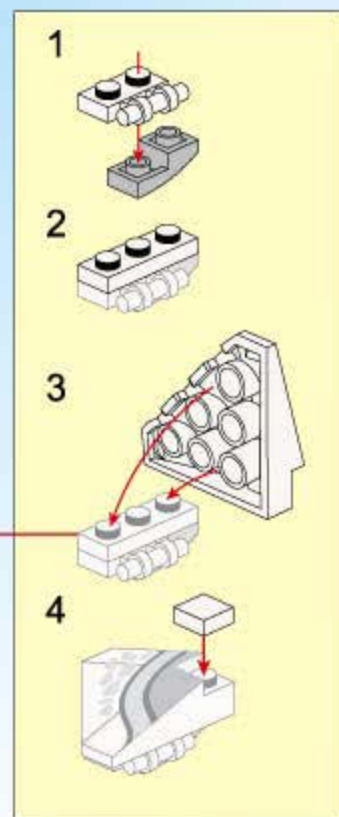
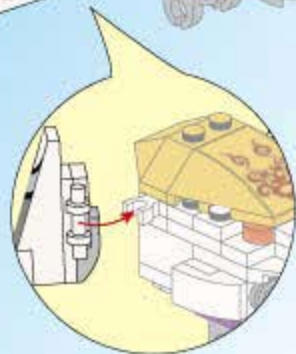
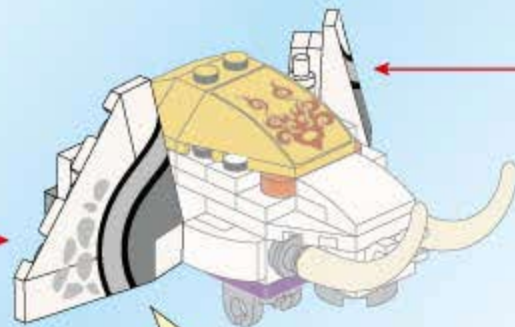
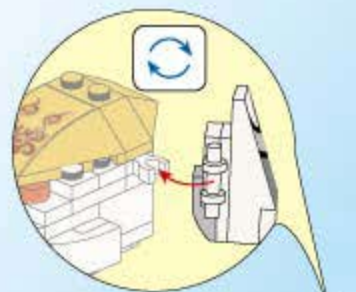
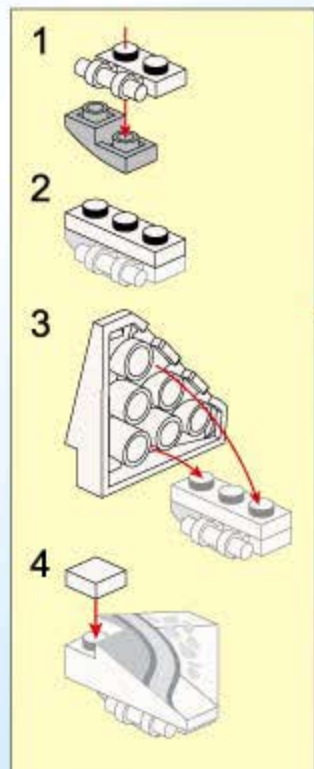
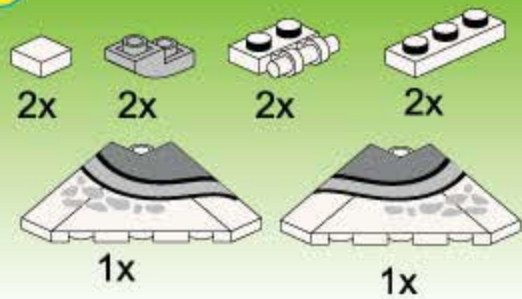

B57

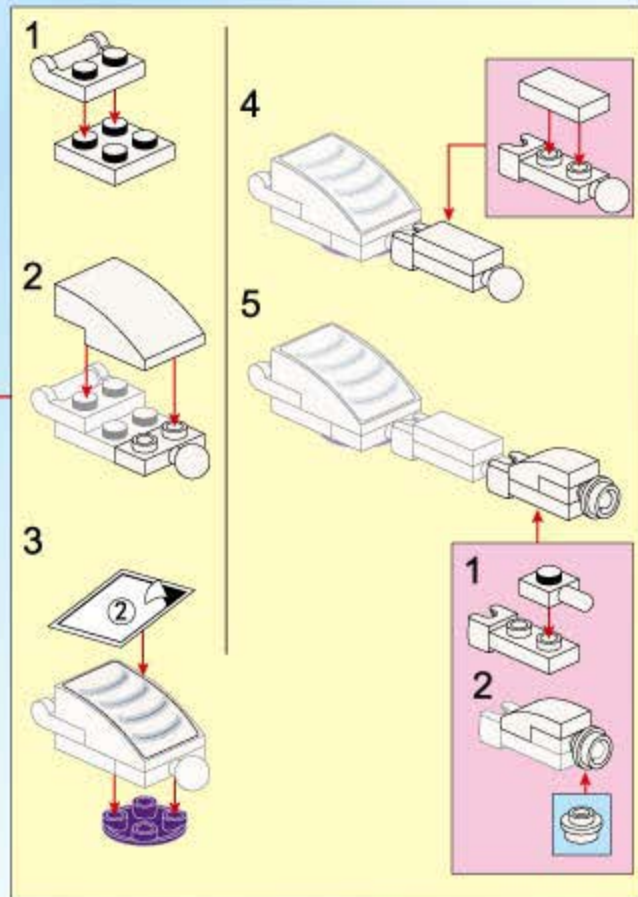
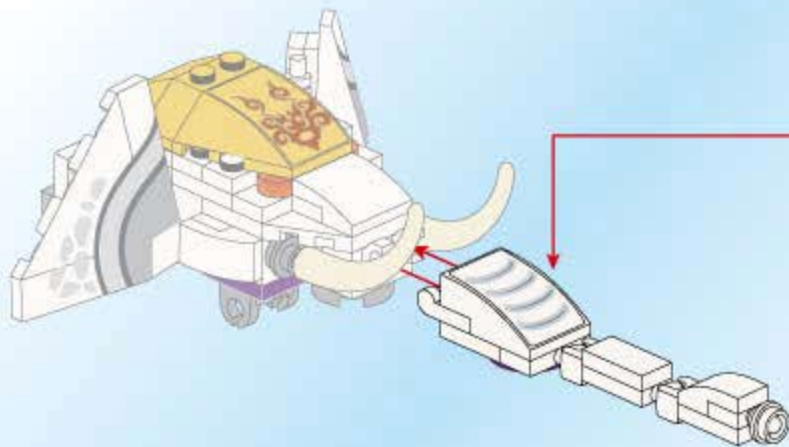
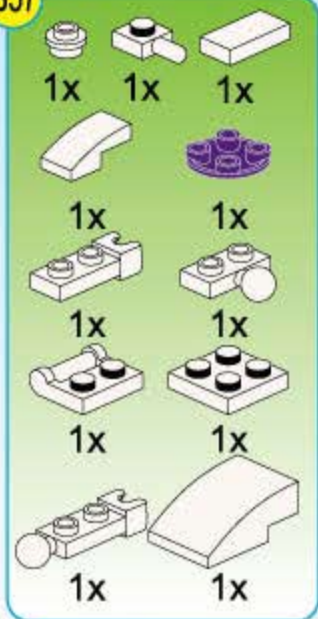

B58

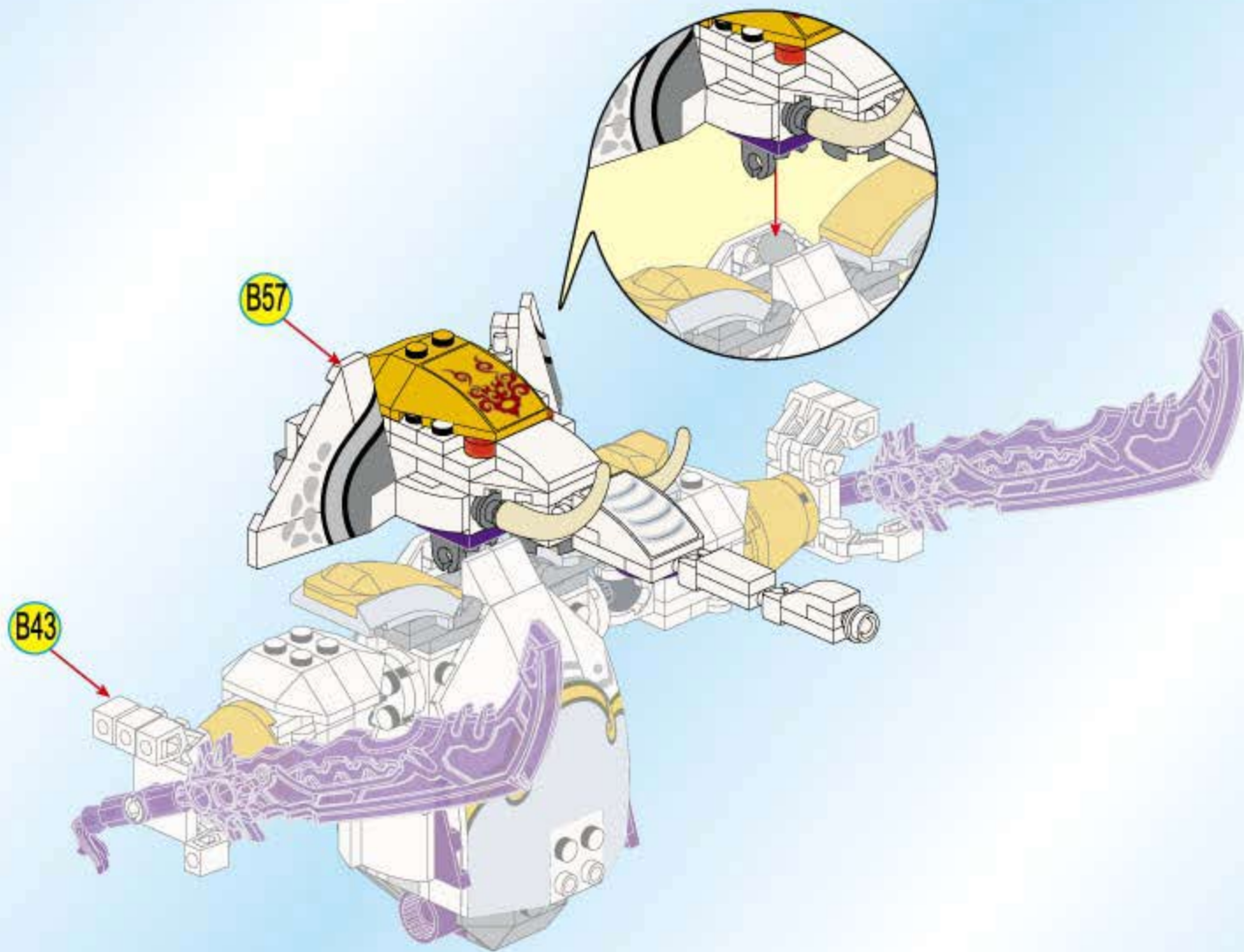

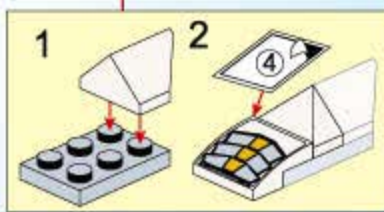
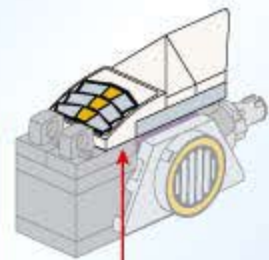
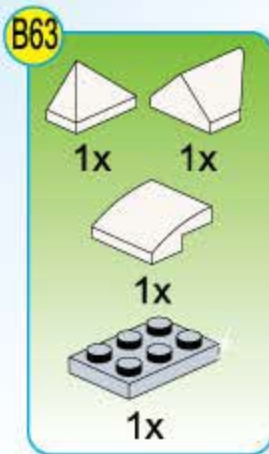
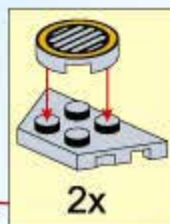
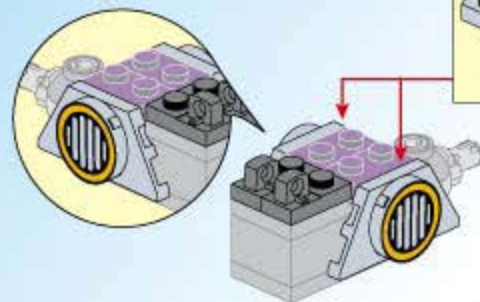
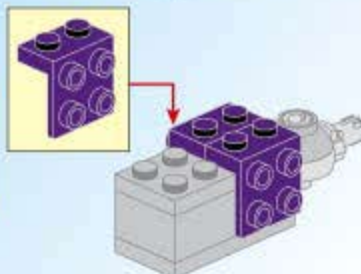
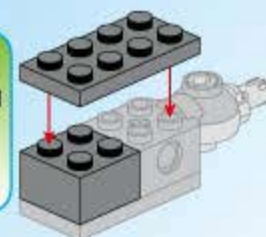
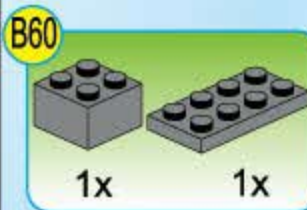
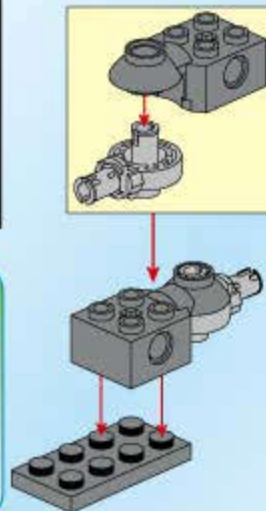
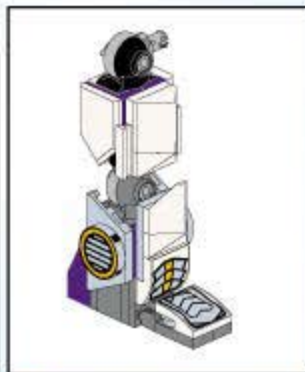
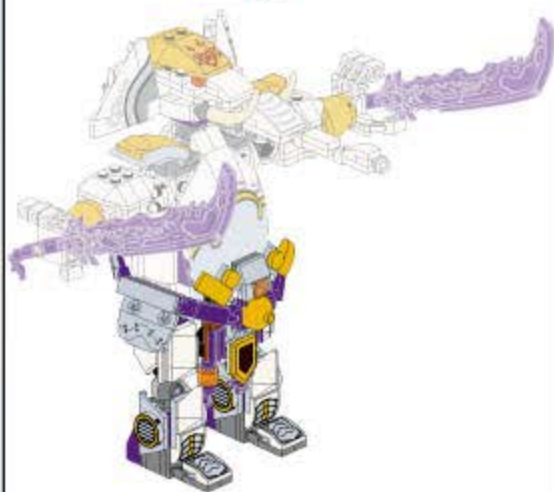

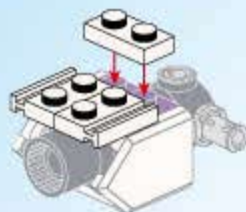
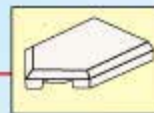
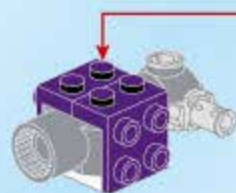
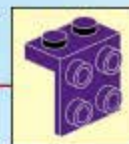
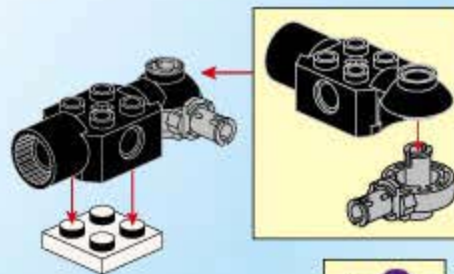
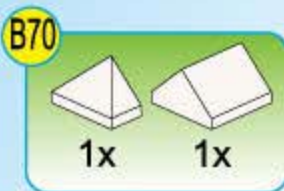
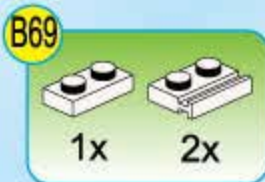
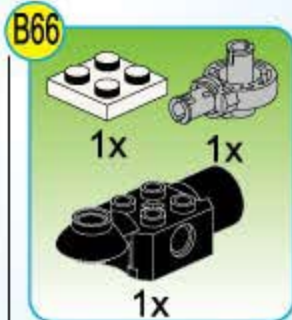
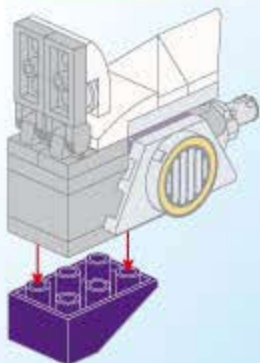
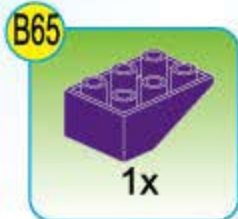
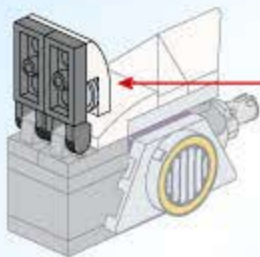
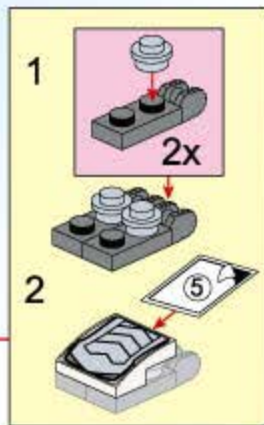

B71

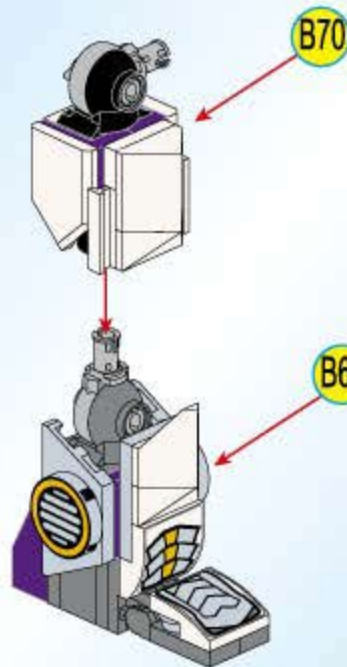

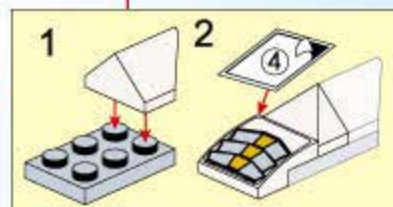
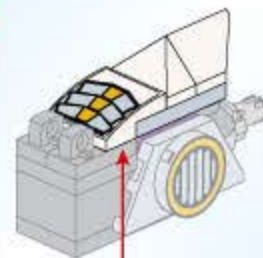
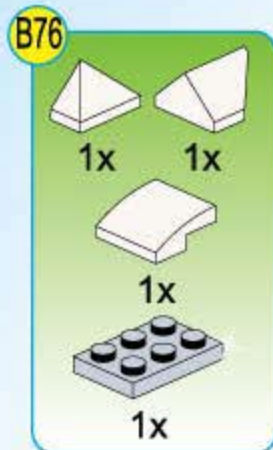
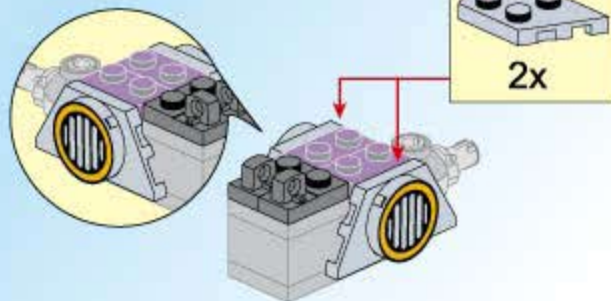
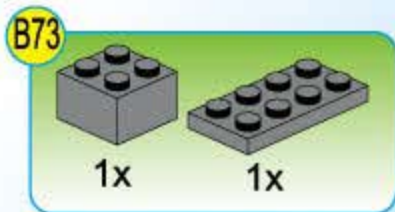
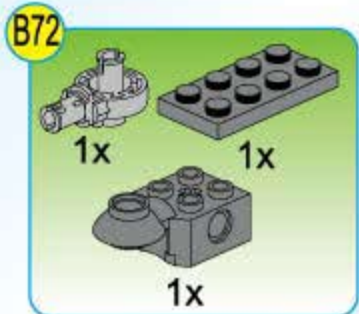
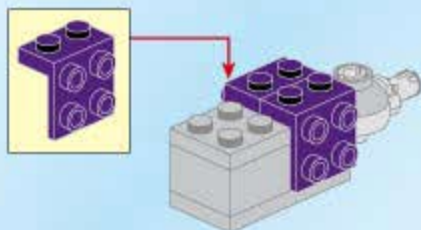
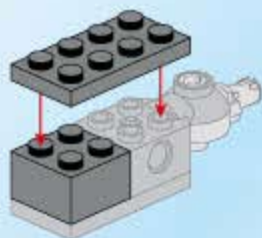
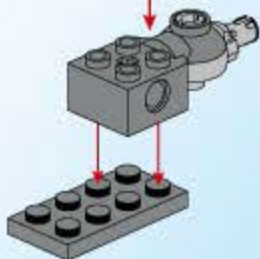
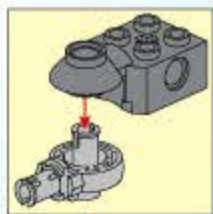

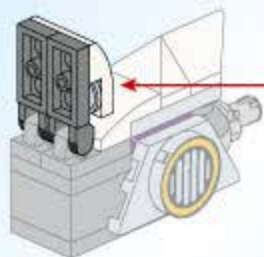
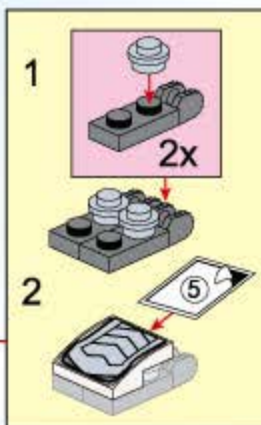
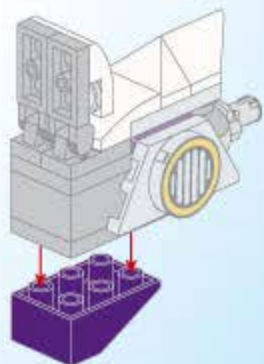
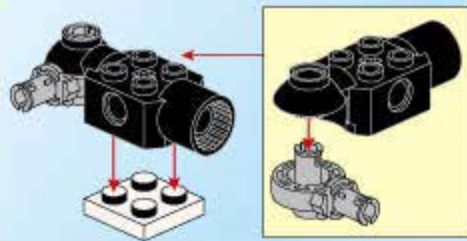
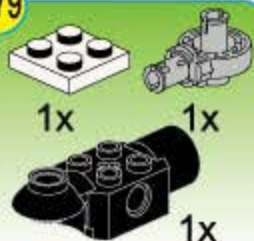
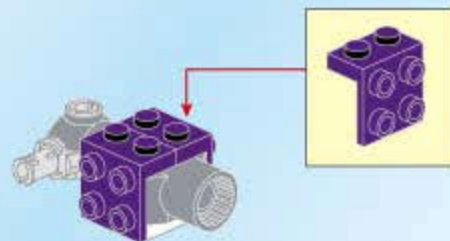
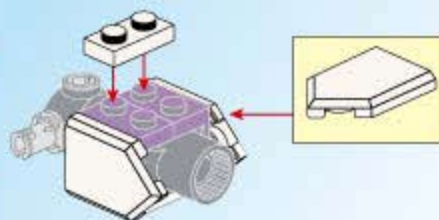
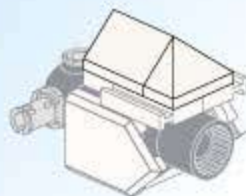
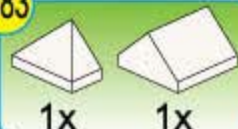
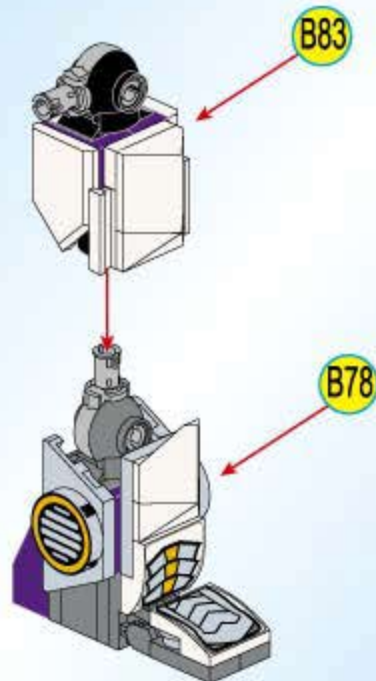
B77**B78****B79****B80****B81****B82****B83****B84**

B85







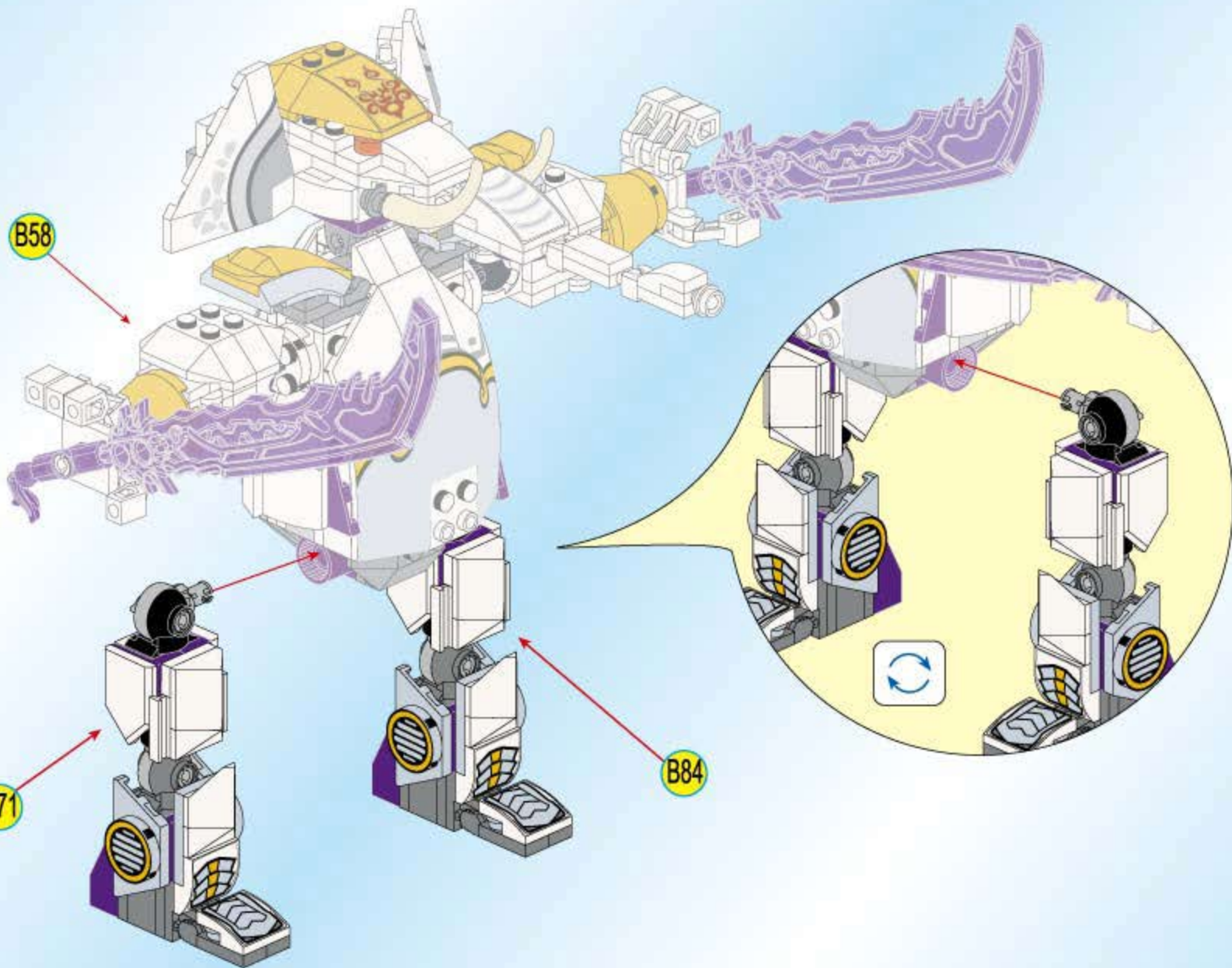



B58



B71



B84



B86



- | | | | | |
|---|---|---|---|---|
|  |  |  |  |  |
| 4x | 2x | 2x | 2x | 2x |
|  |  |  |  |  |
| 2x | 1x | 2x | 2x | 2x |

1  

2  

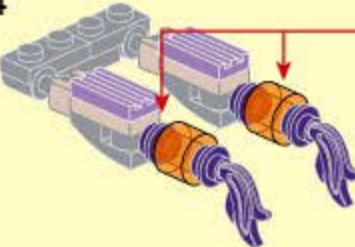
3 



4 

1  

2 

3 

2x

1  

2x

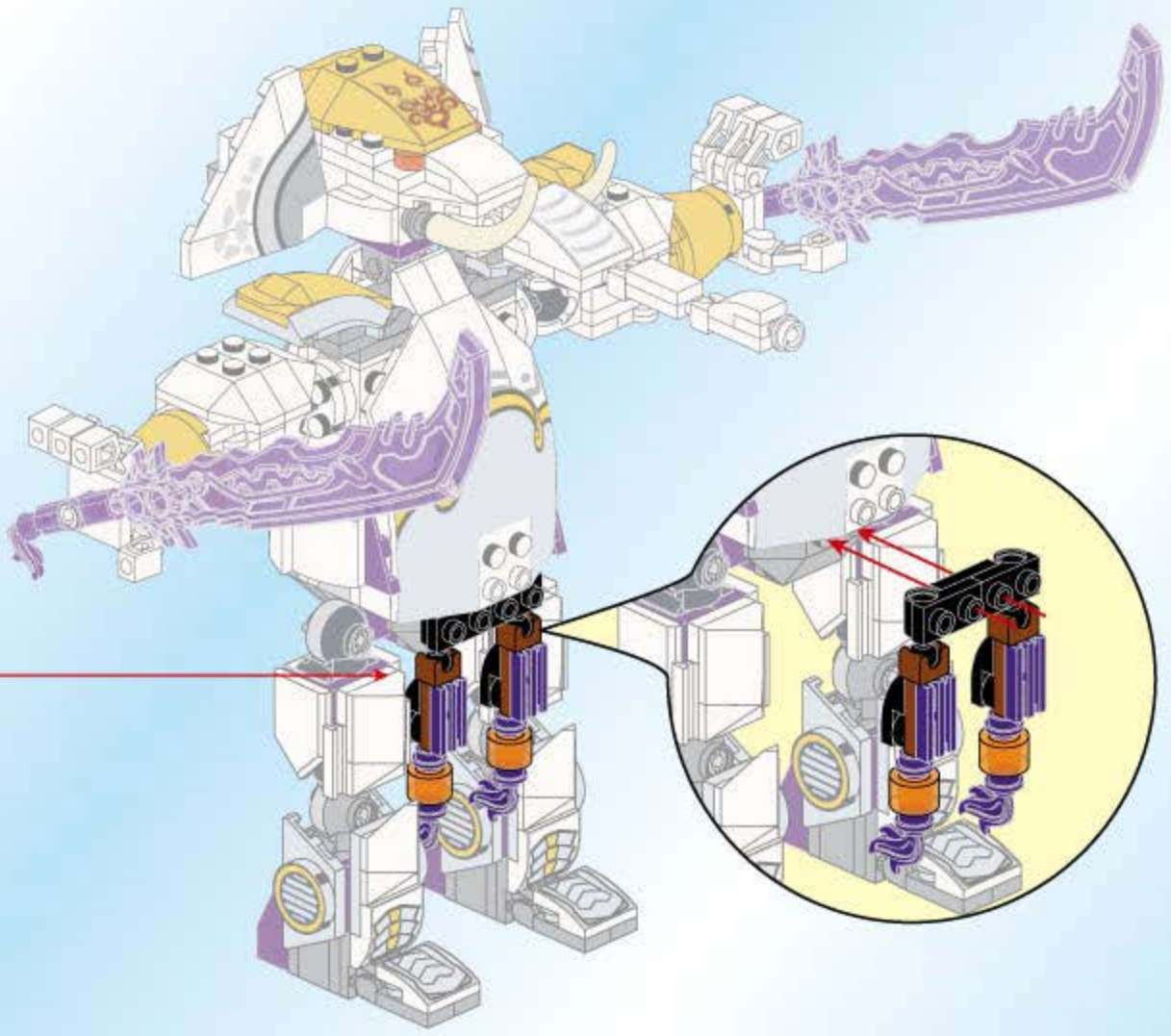

B87

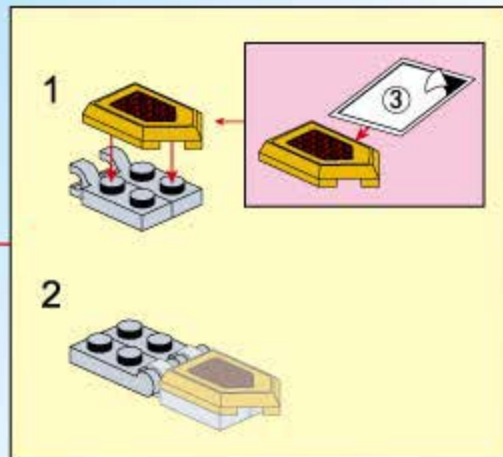
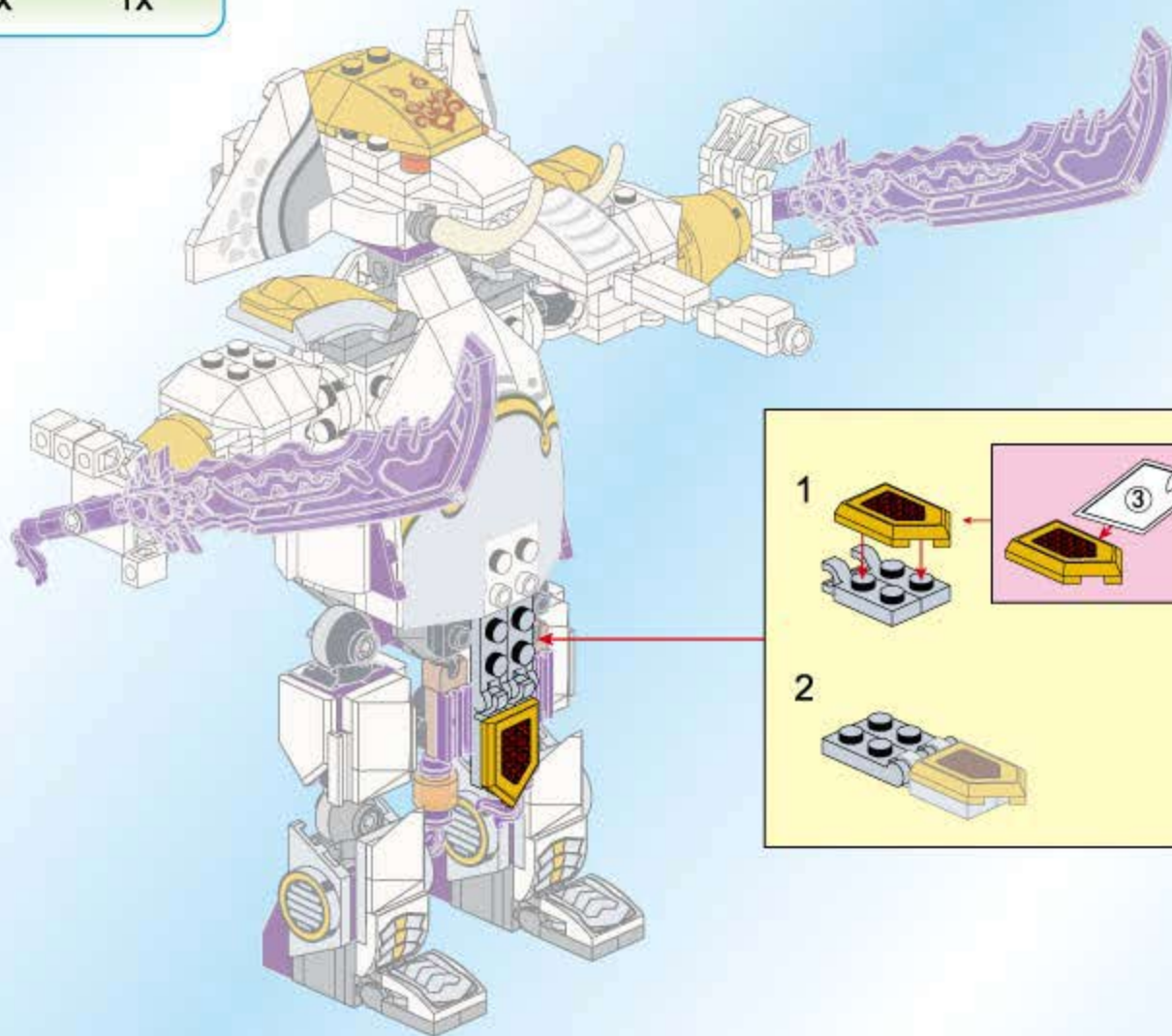

B88

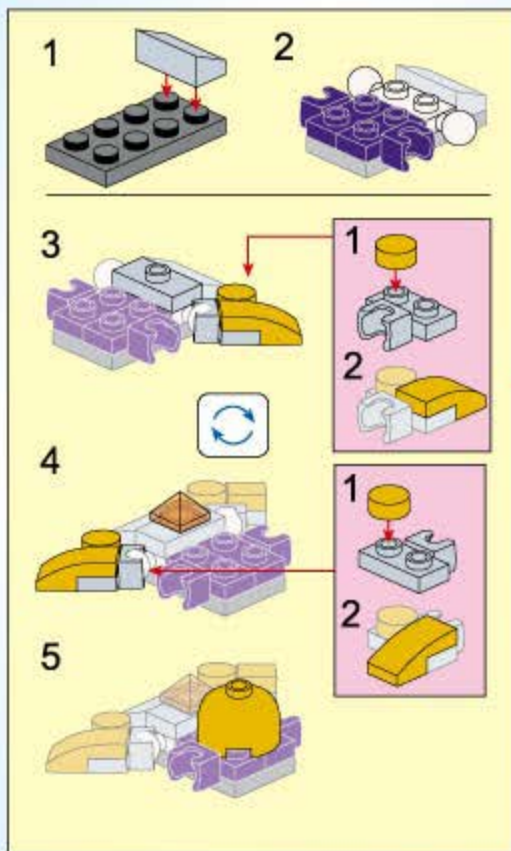
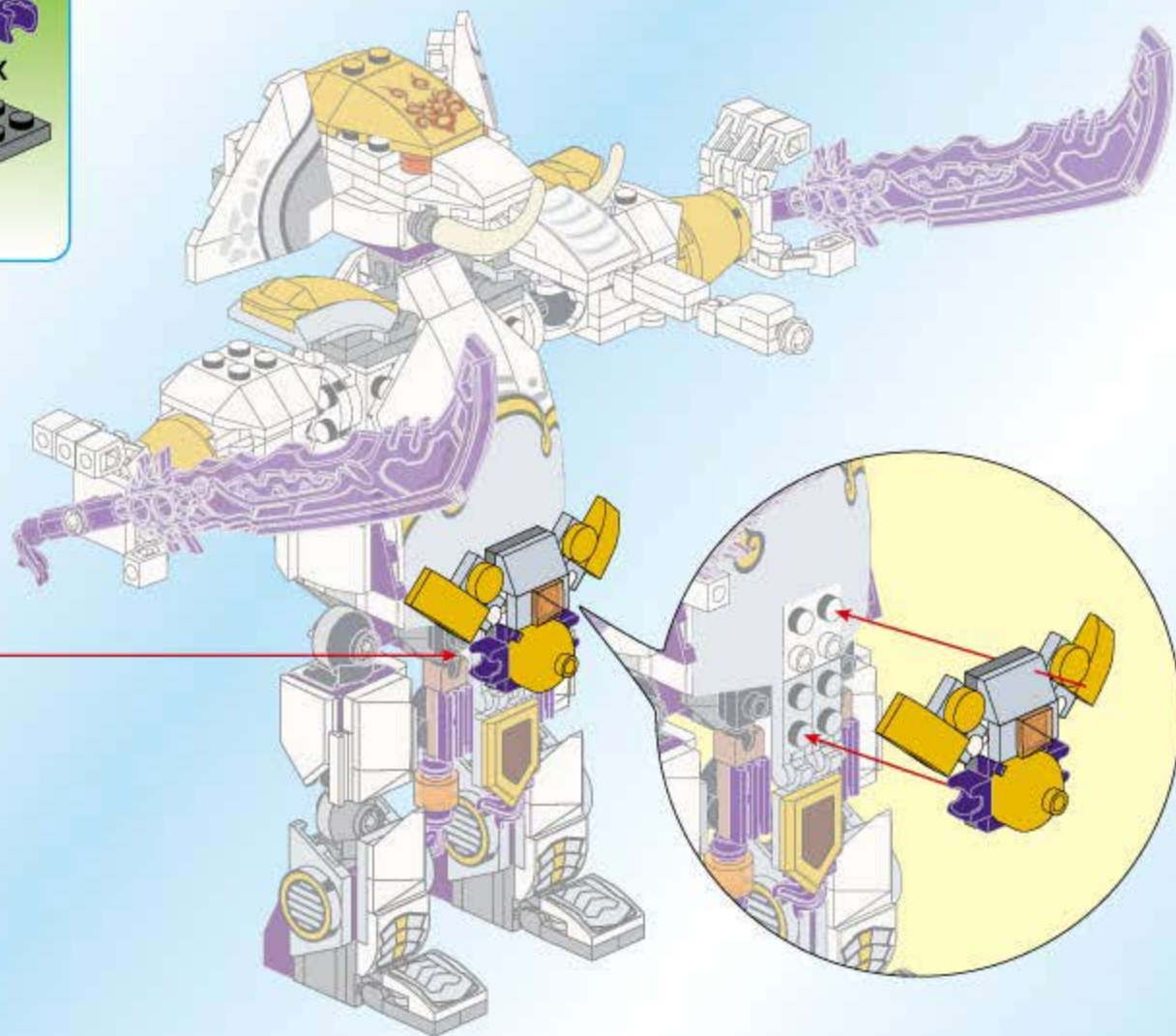
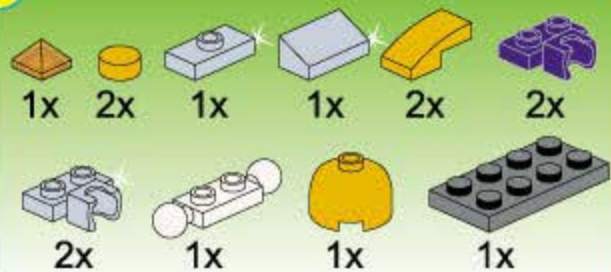

B89

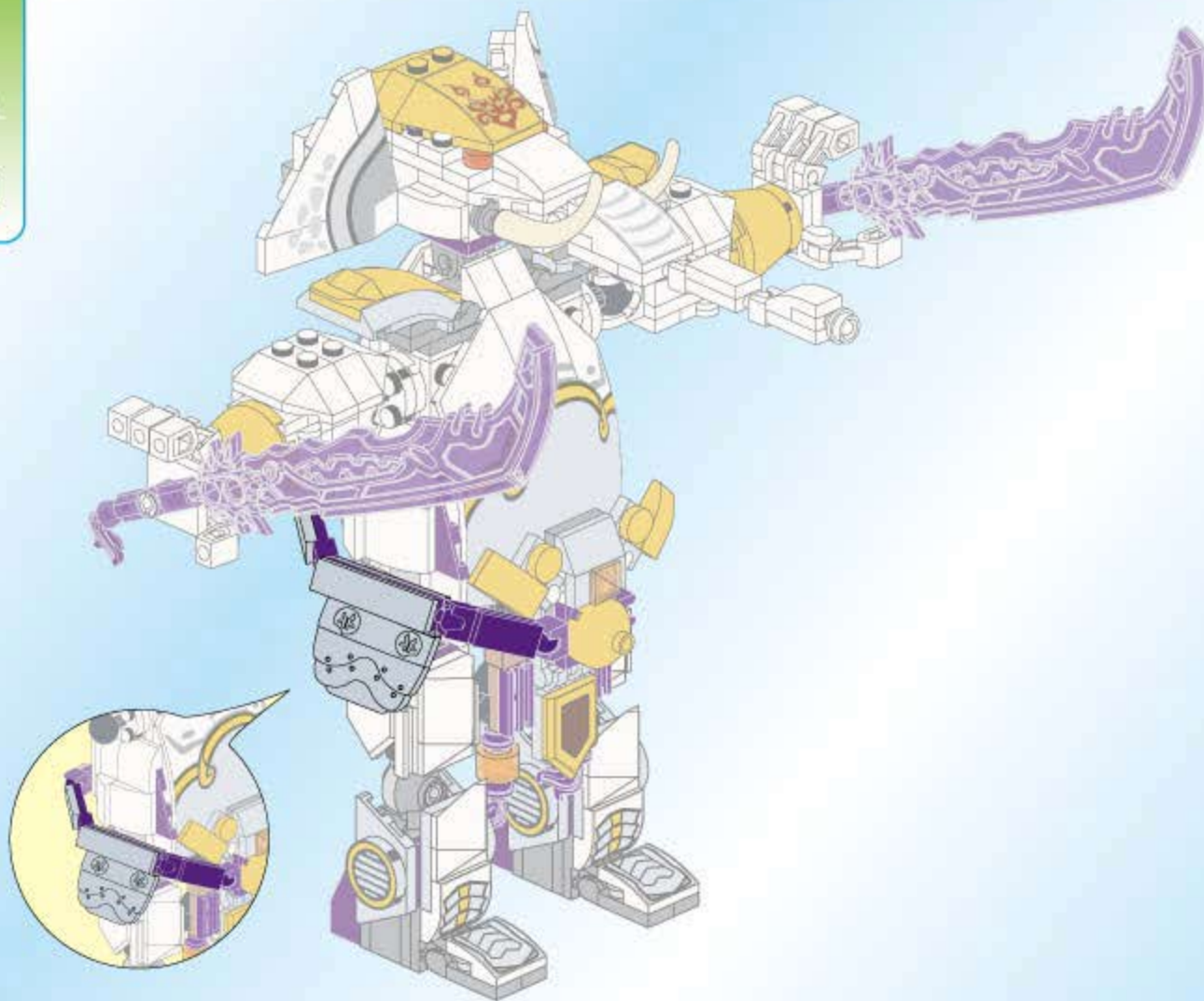
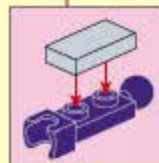
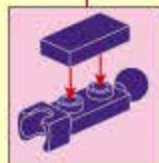
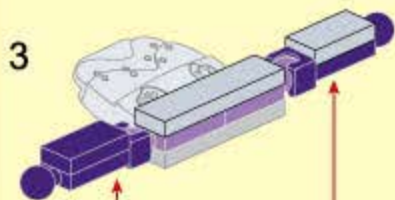
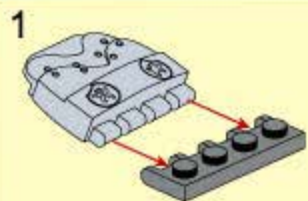
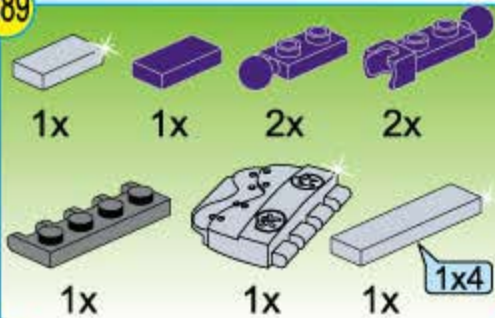

B90

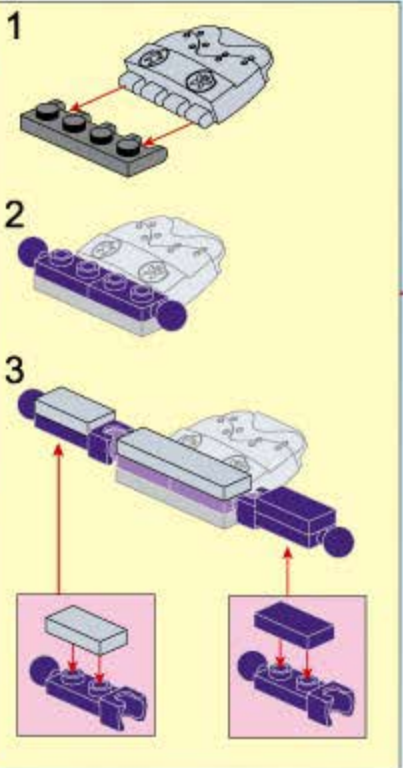
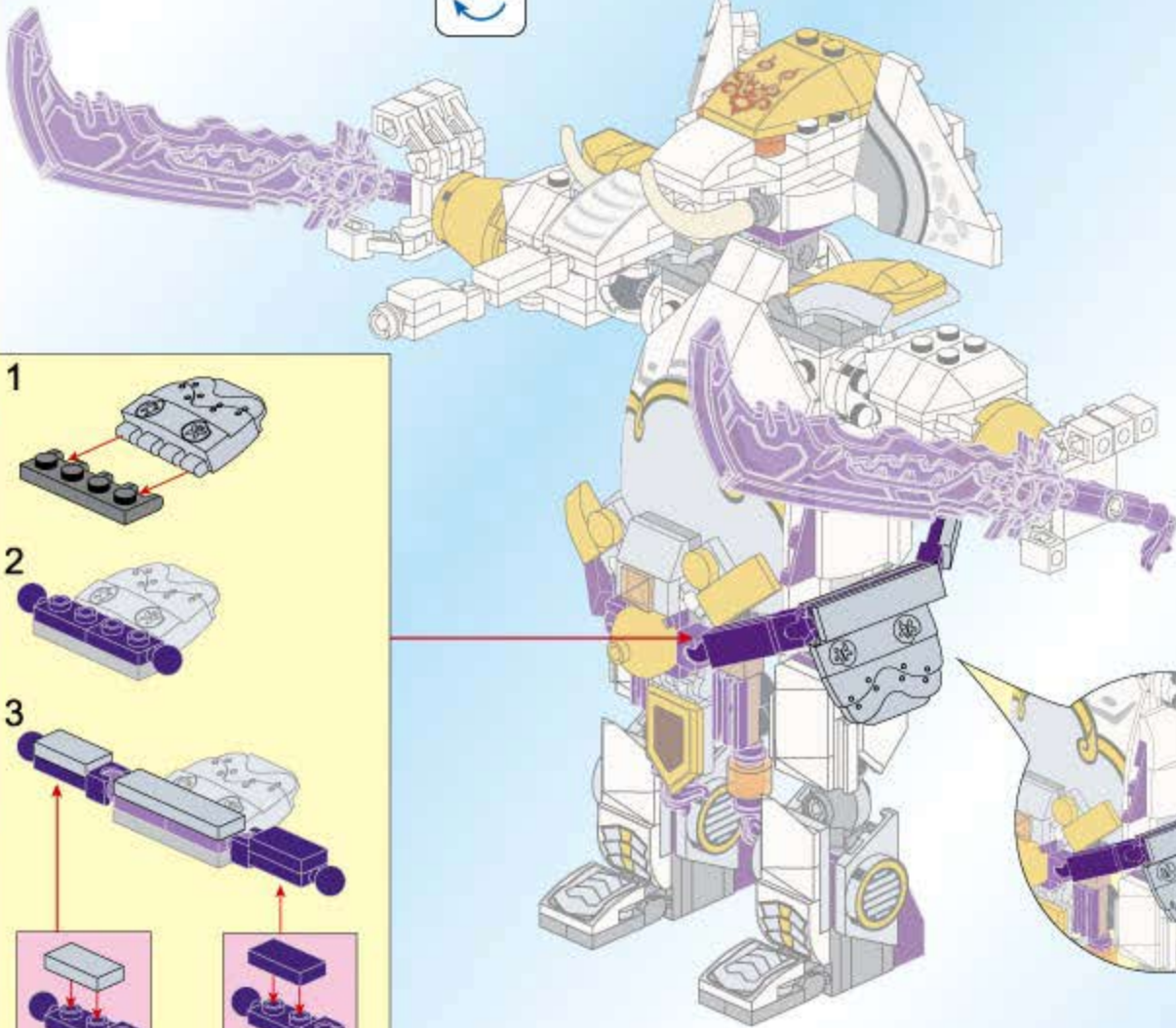
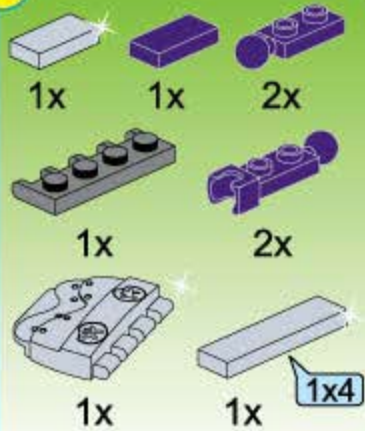



MONKEY KING

STORY OF WUKONG



3801 Monster Encounter



3802 Robbery of Mount Huaguo



3803 Execute Lady Skeleton



3804 Obstruction at Ridge Shituo



3805 Outwit Demon Brothers



3806 Battle with Bull Demon



3807 Fight the Red Boy

