



**3208**

**Ages: 6+**

**Minifigs: X5**

**PCS: 648**

# THUNDER MISSION



**GUNSHIP AIRCRAFT**



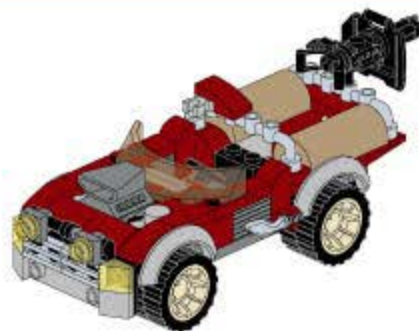

拆件器使用方法, 仅为示例

Usage of Brick Separator Just for the sample

1

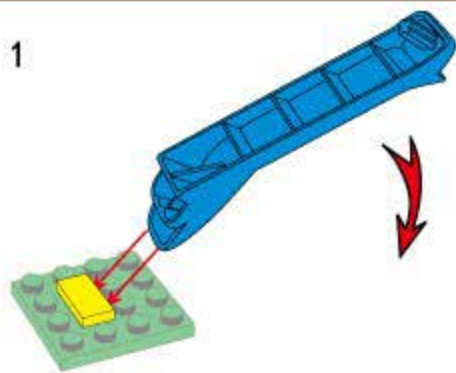

2

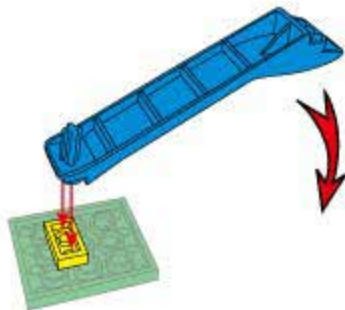

3

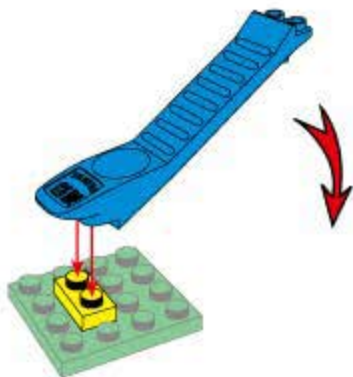

4

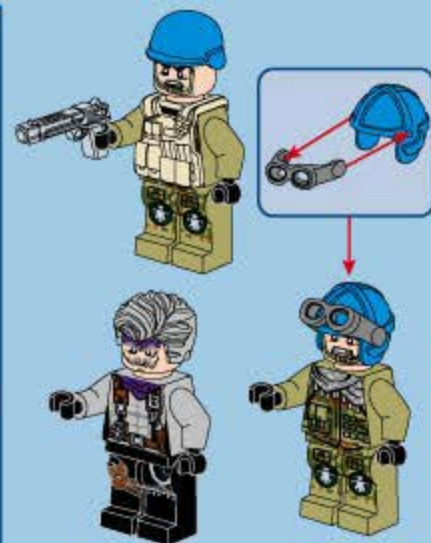
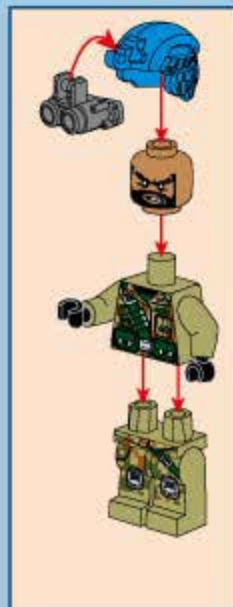
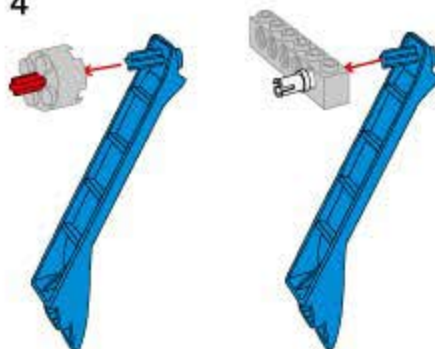

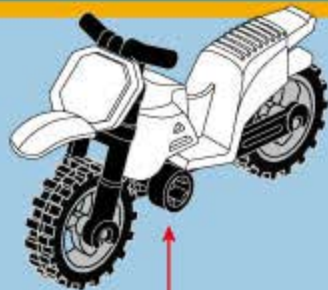

1



2

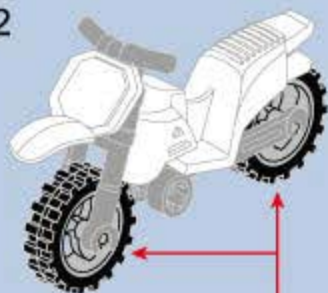

A1

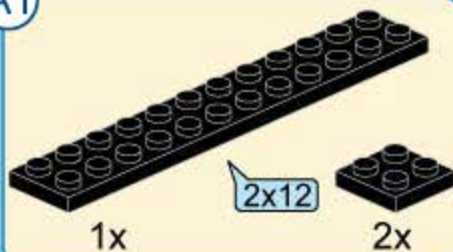

A2



A3

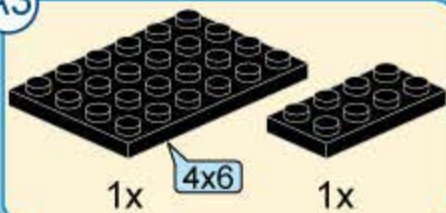

A4

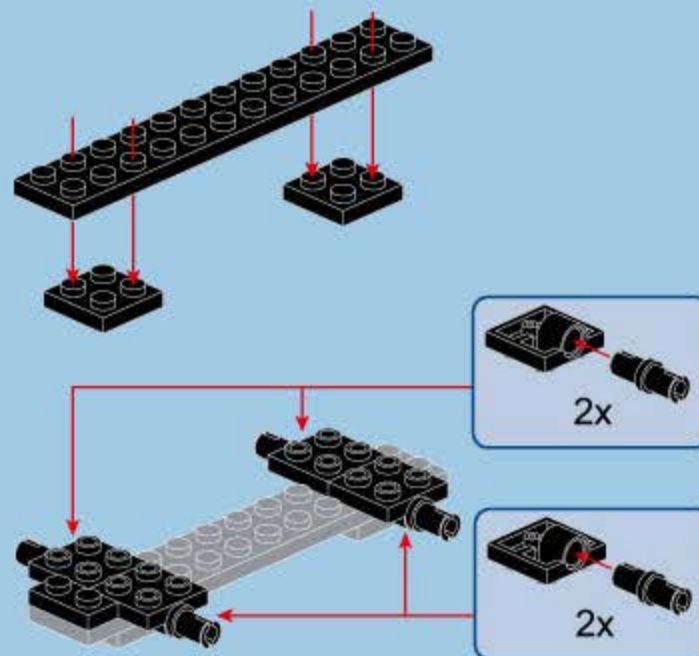
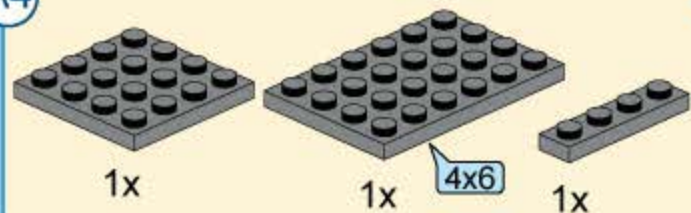



A5

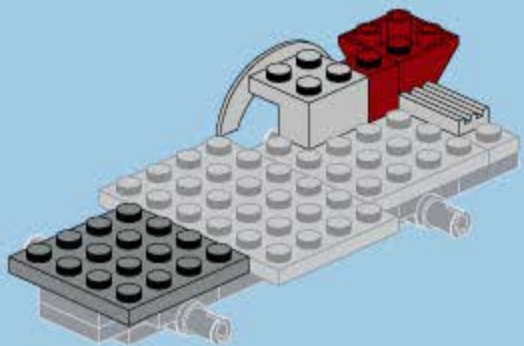
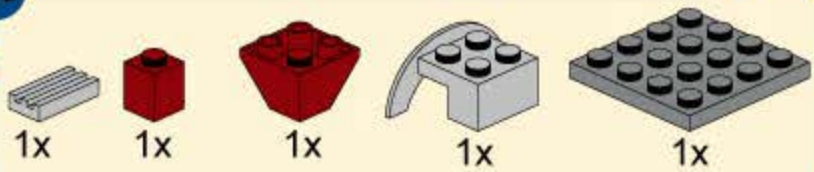

A6

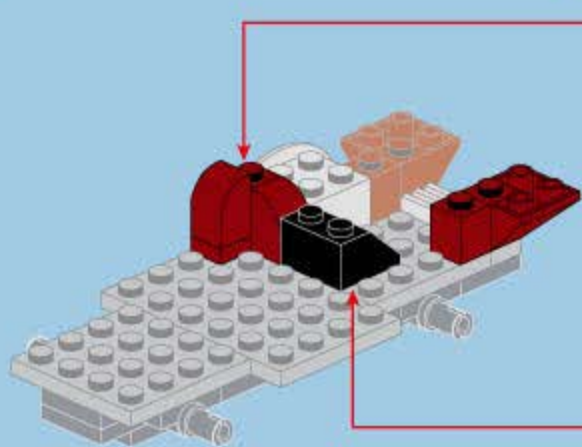
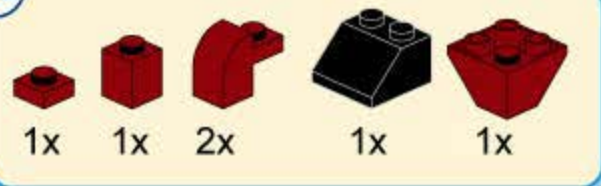

A7

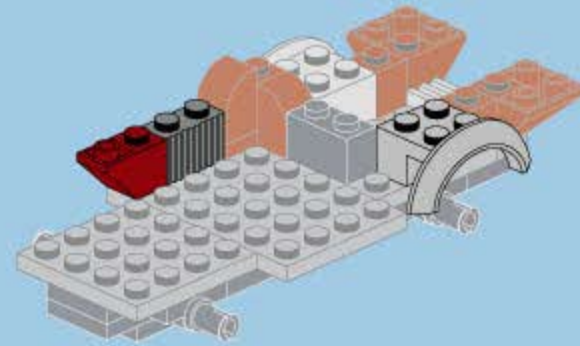
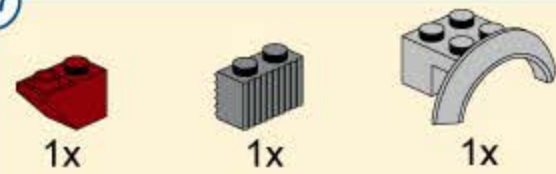

A8

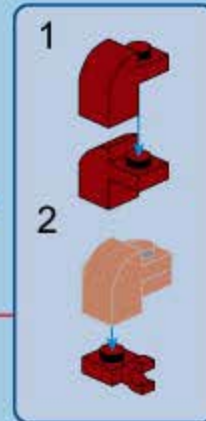
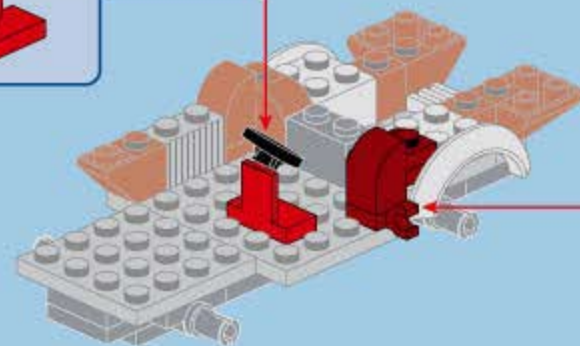

A9

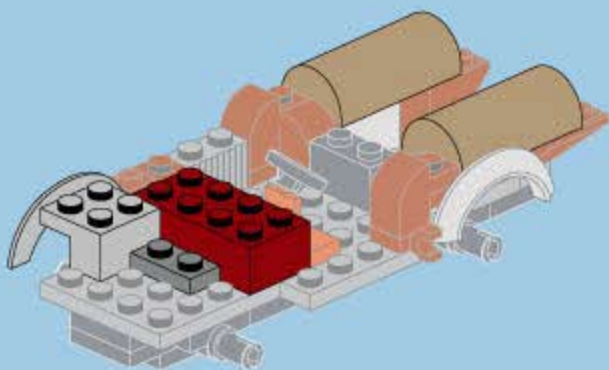
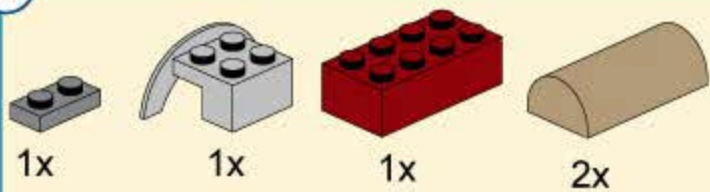

A10

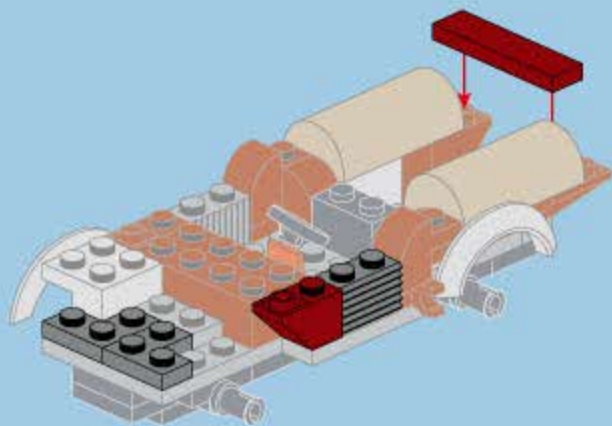
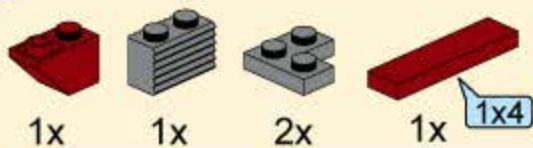

A11

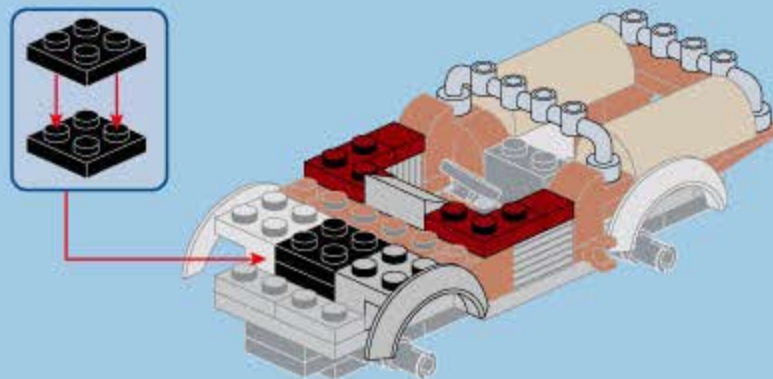
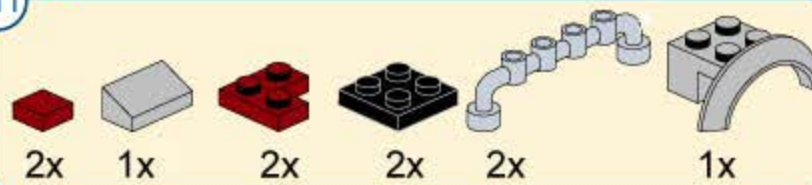

A12

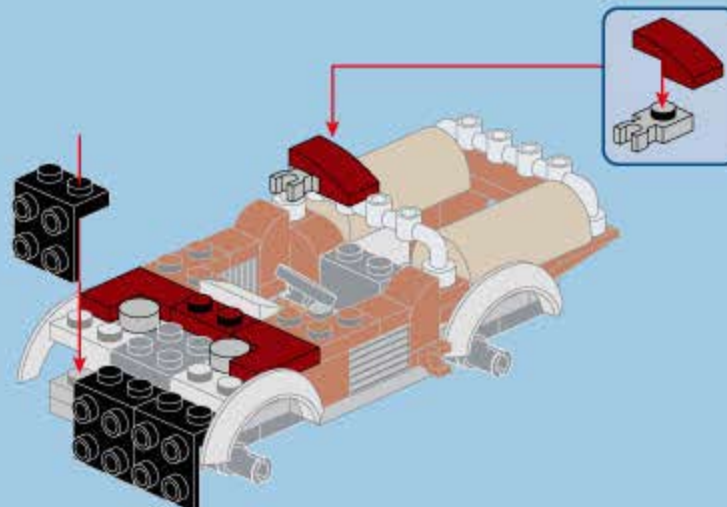
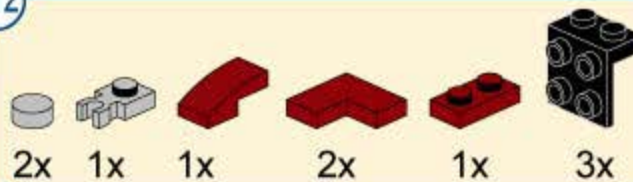



A13

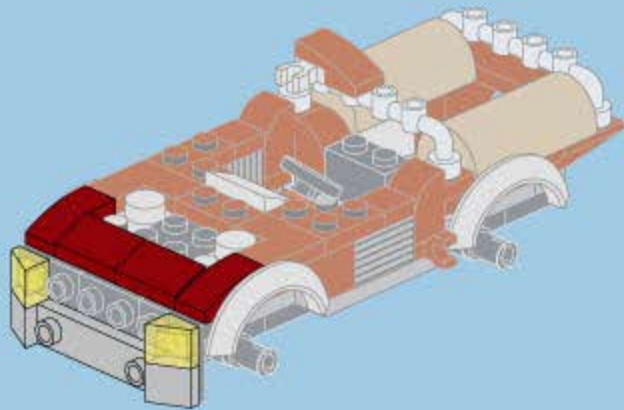
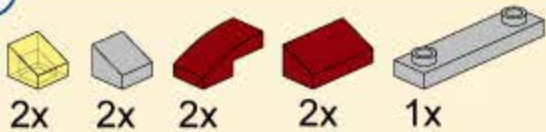

A14

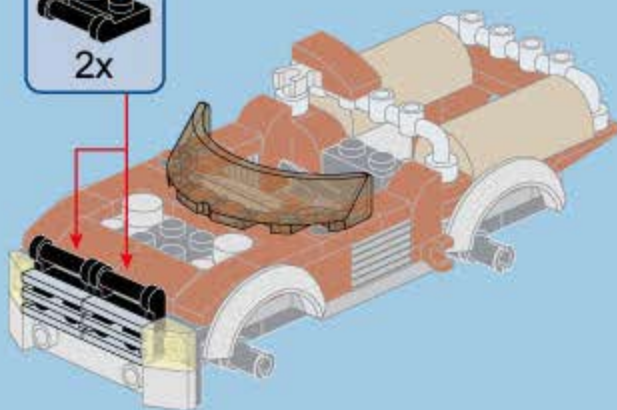
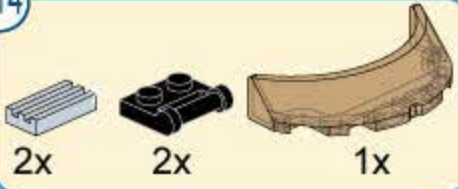

A15

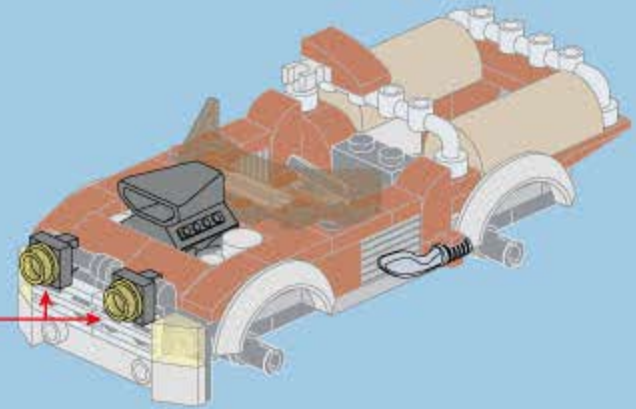
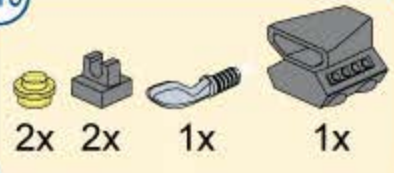

A16

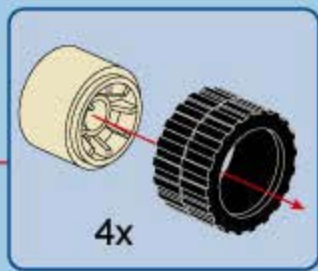
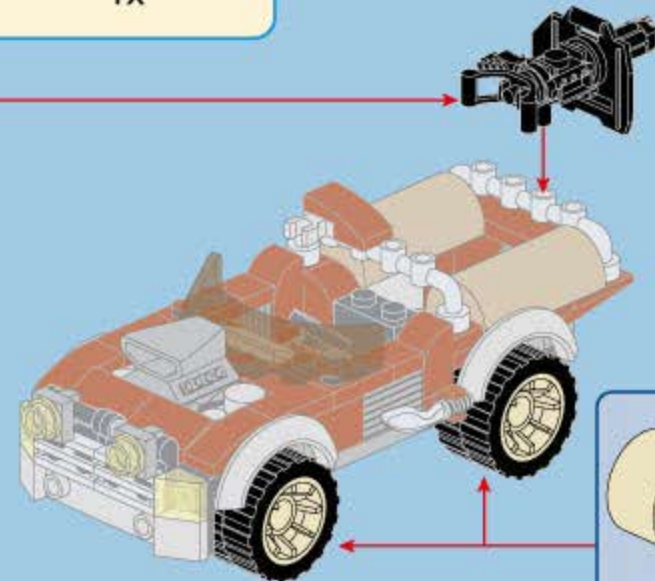
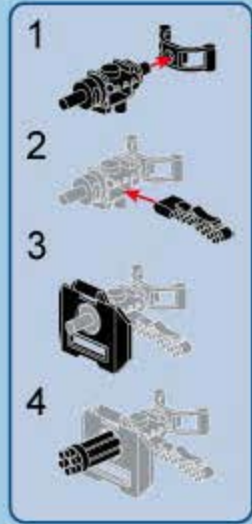
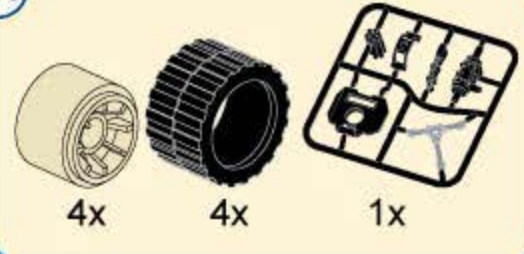



+



8x24

=

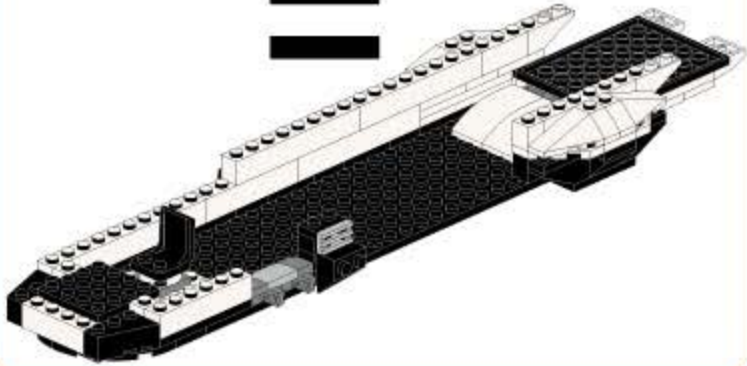

B1

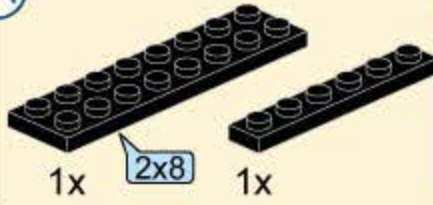

1x

2x8

1x

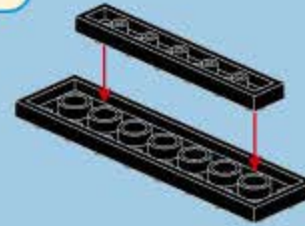

B2

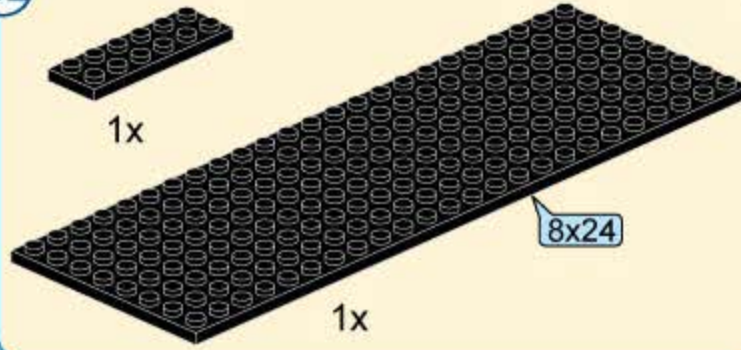

1x

8x24

1x

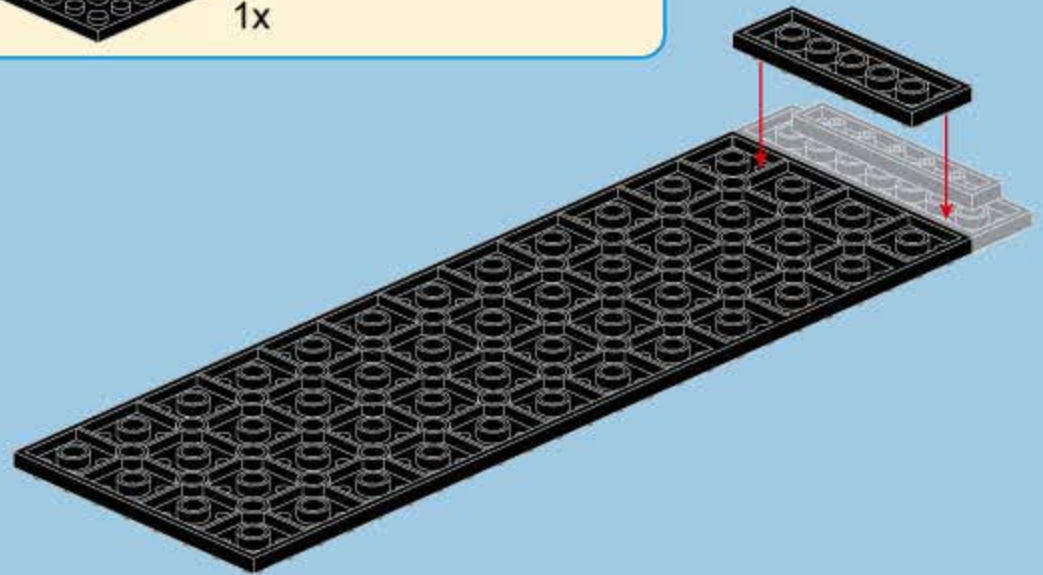



B3

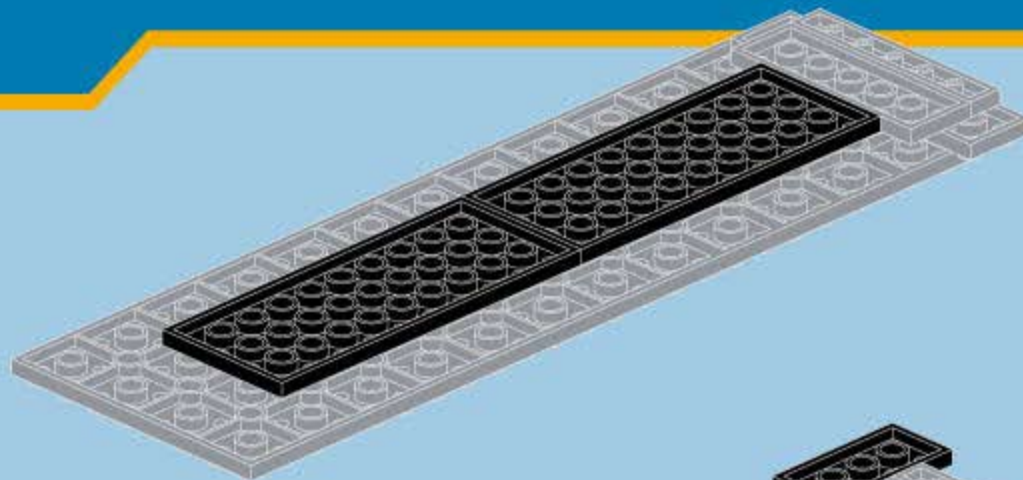
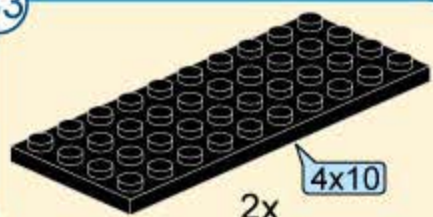

B4

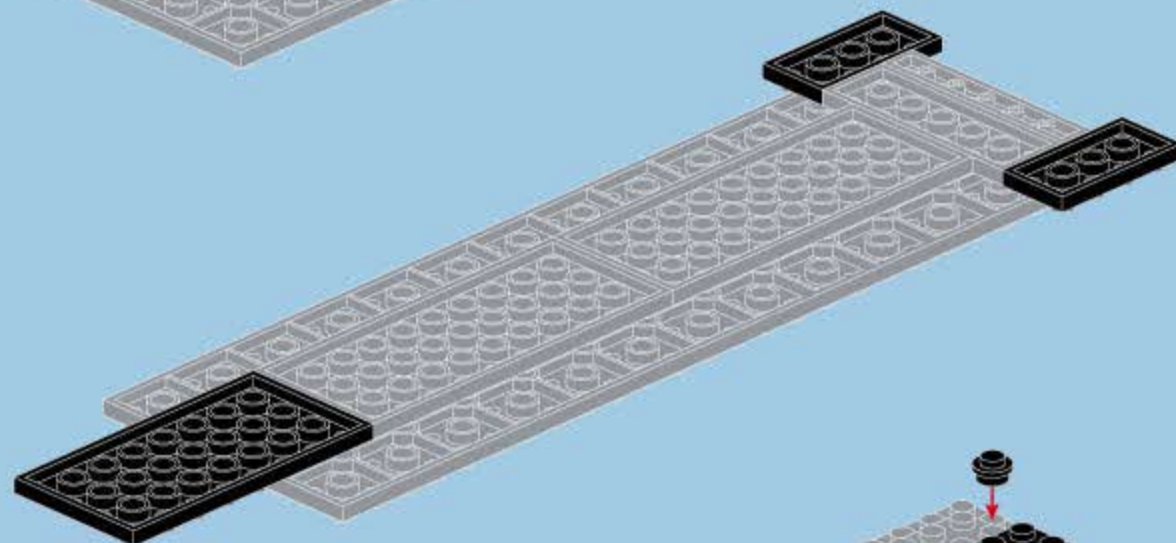
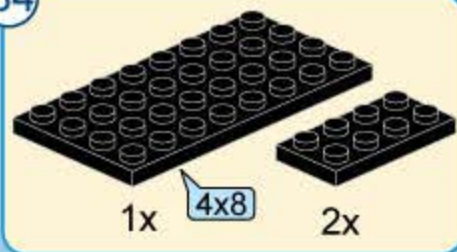

B5

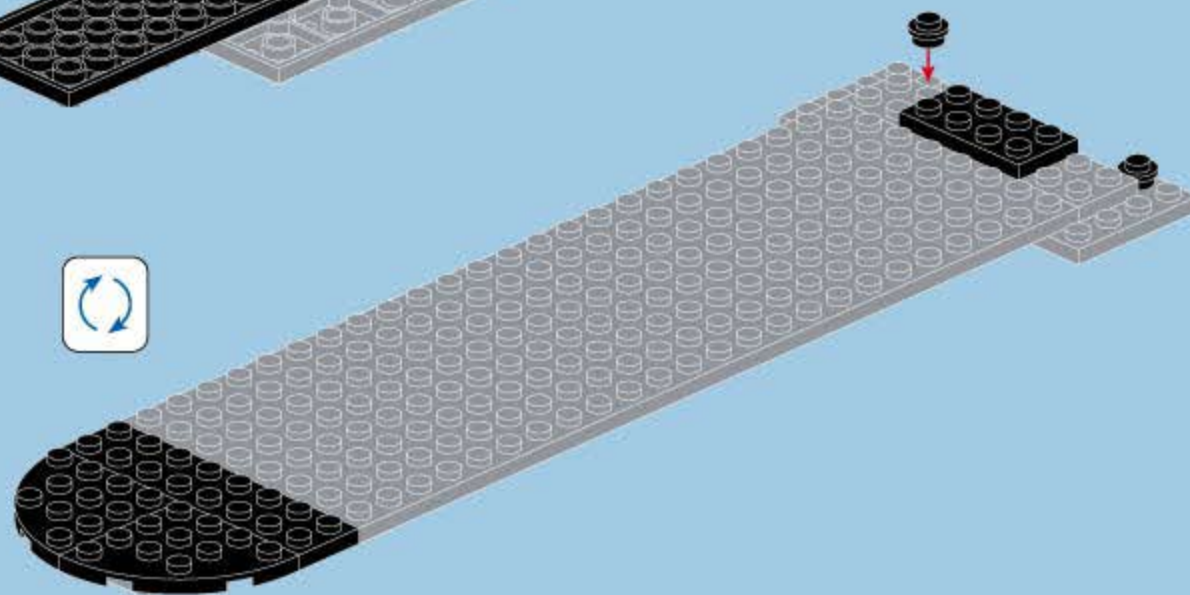
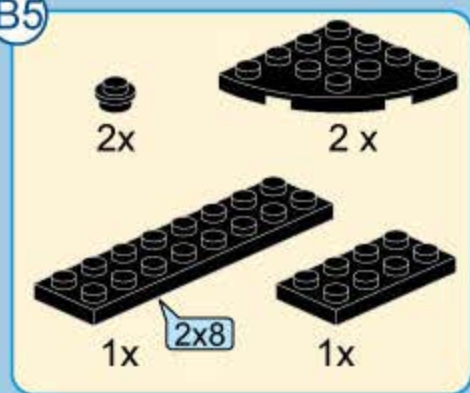



B6

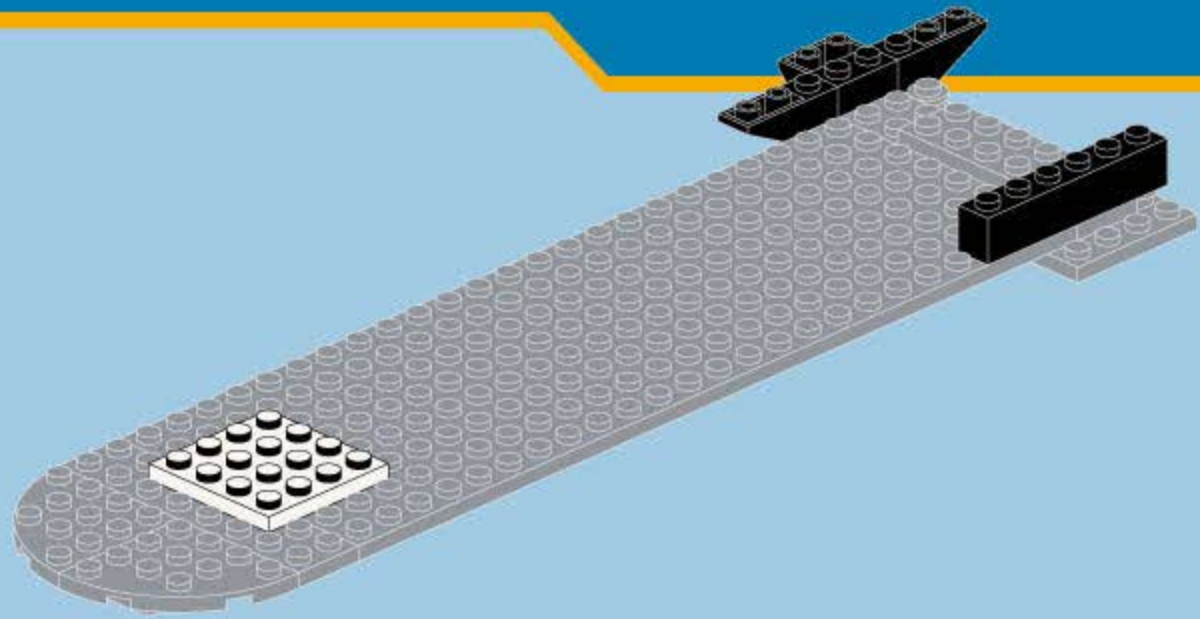
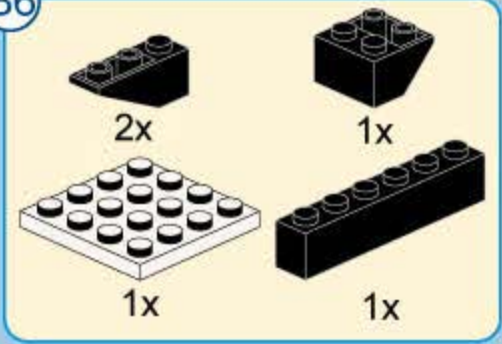

B7

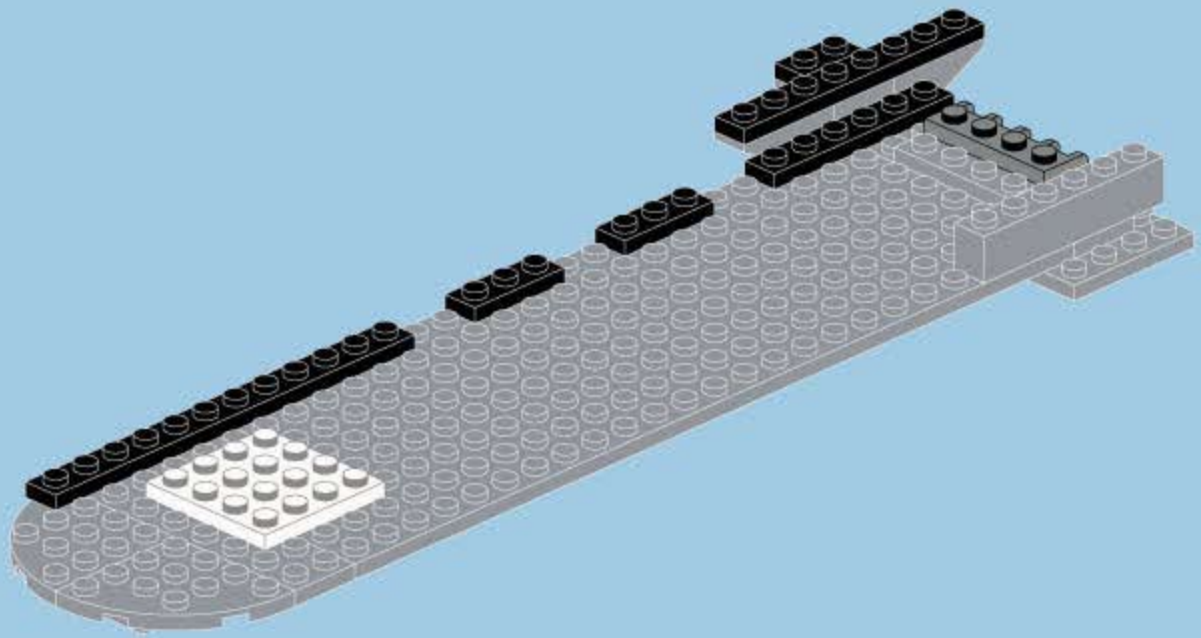
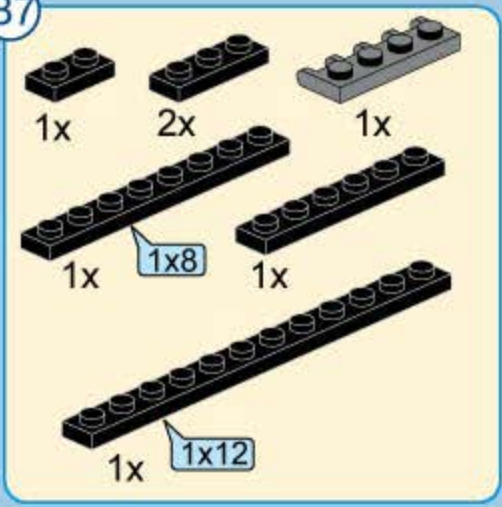

B8

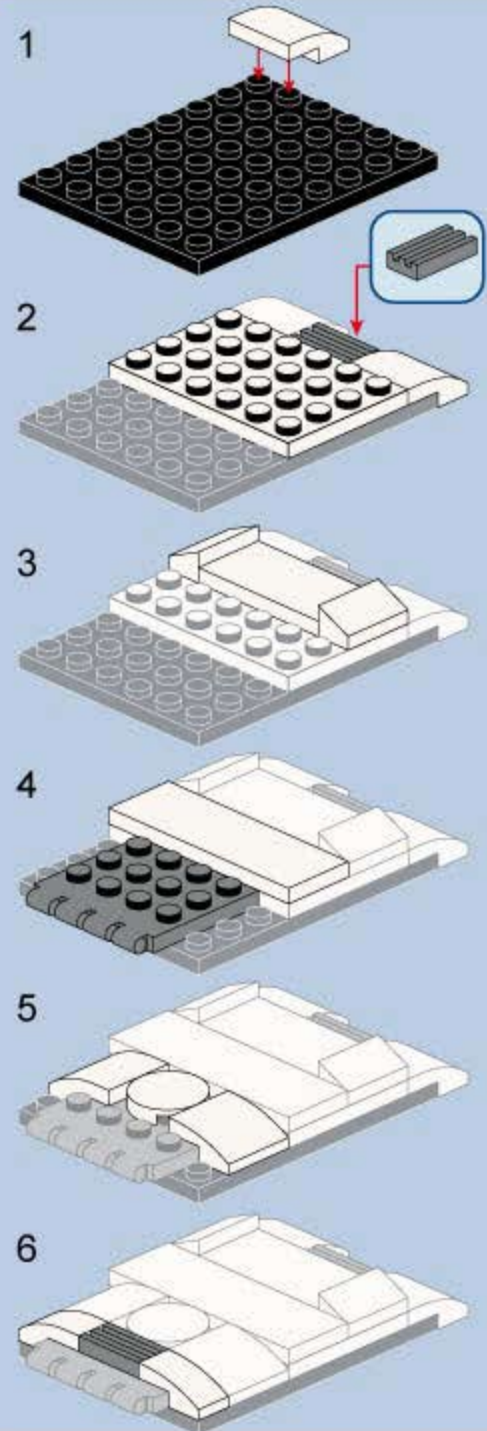
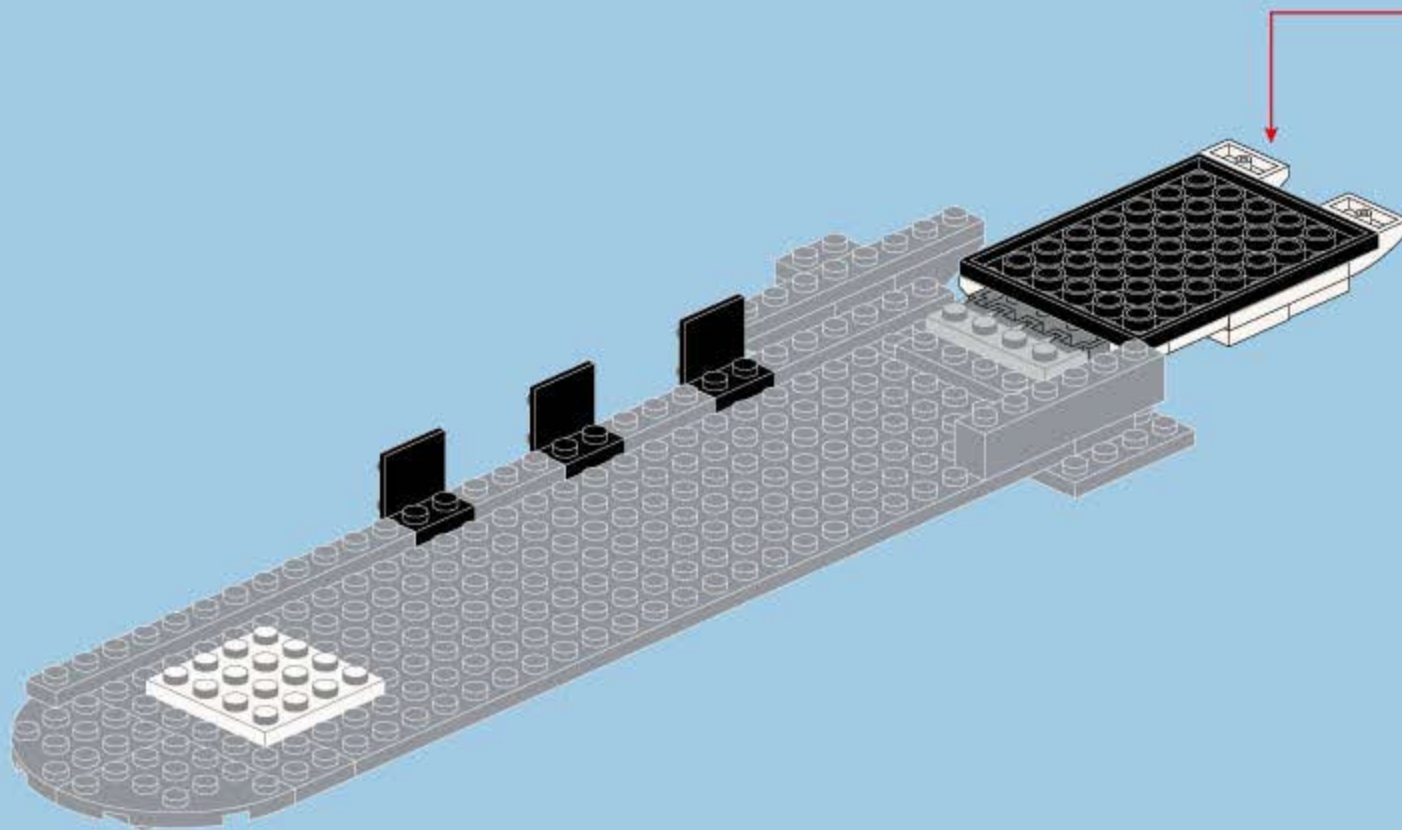
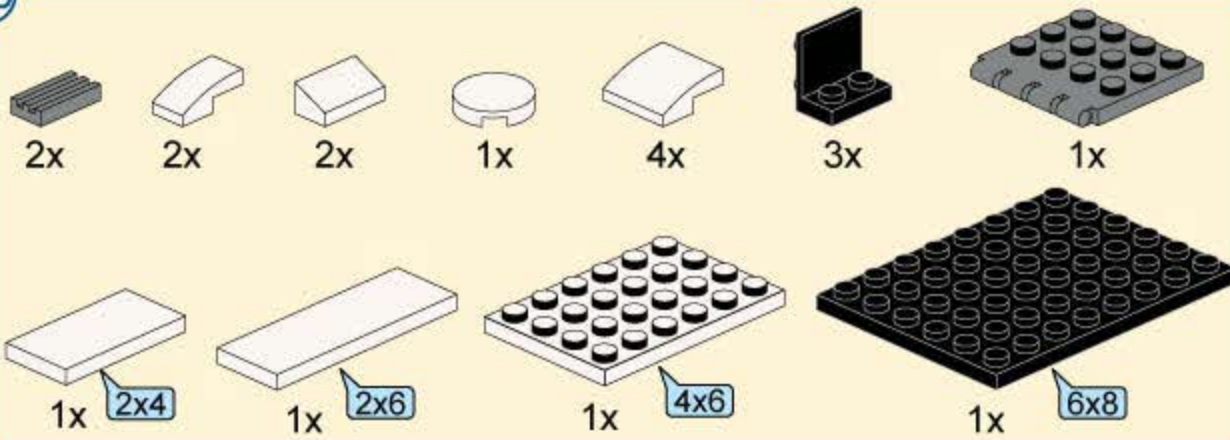



B9

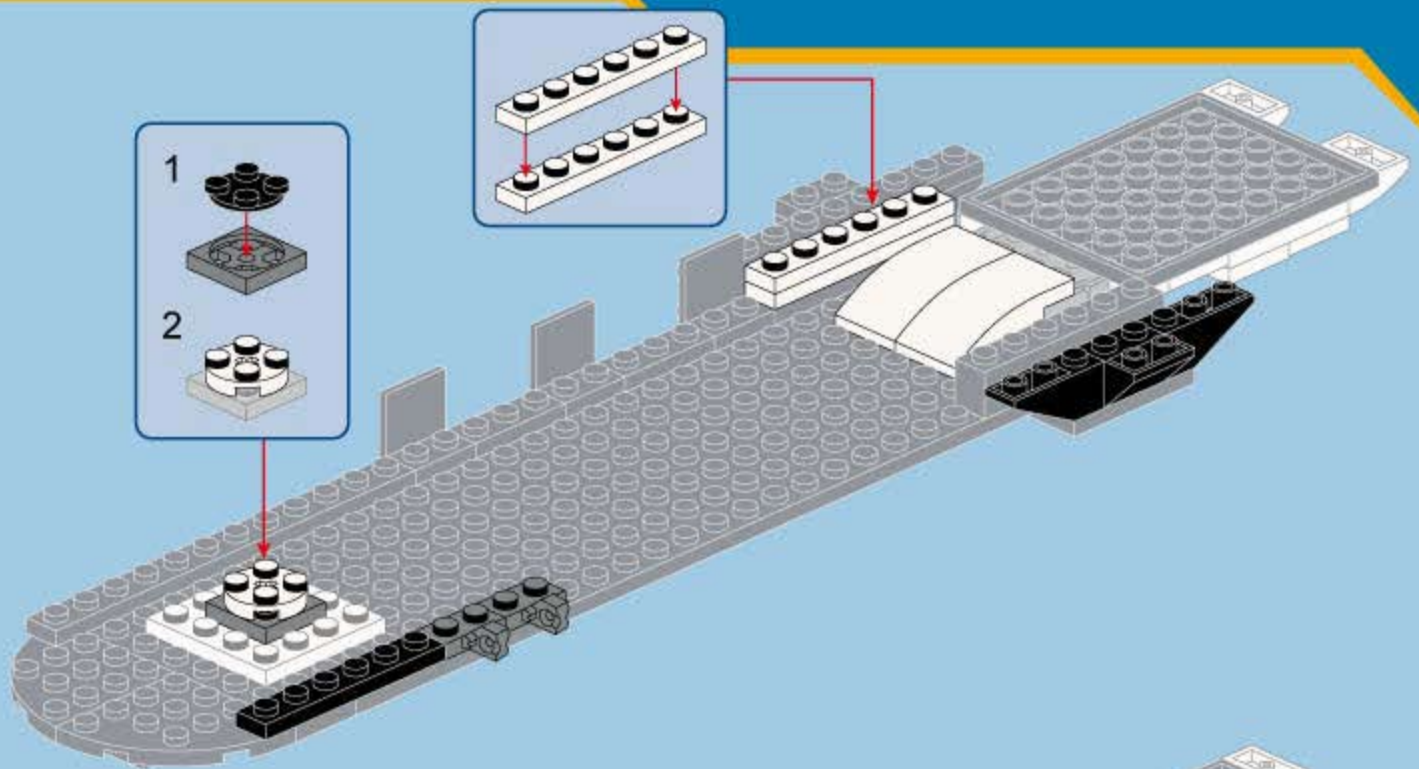
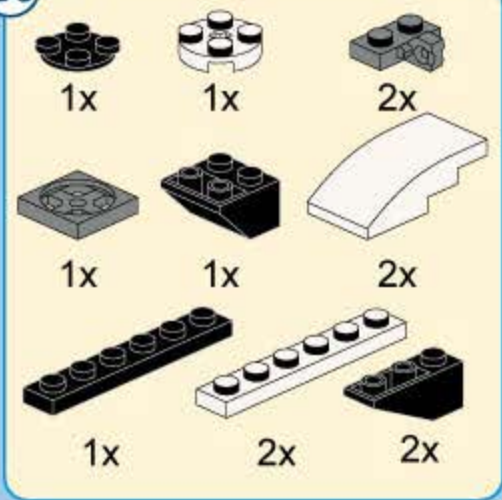

B10

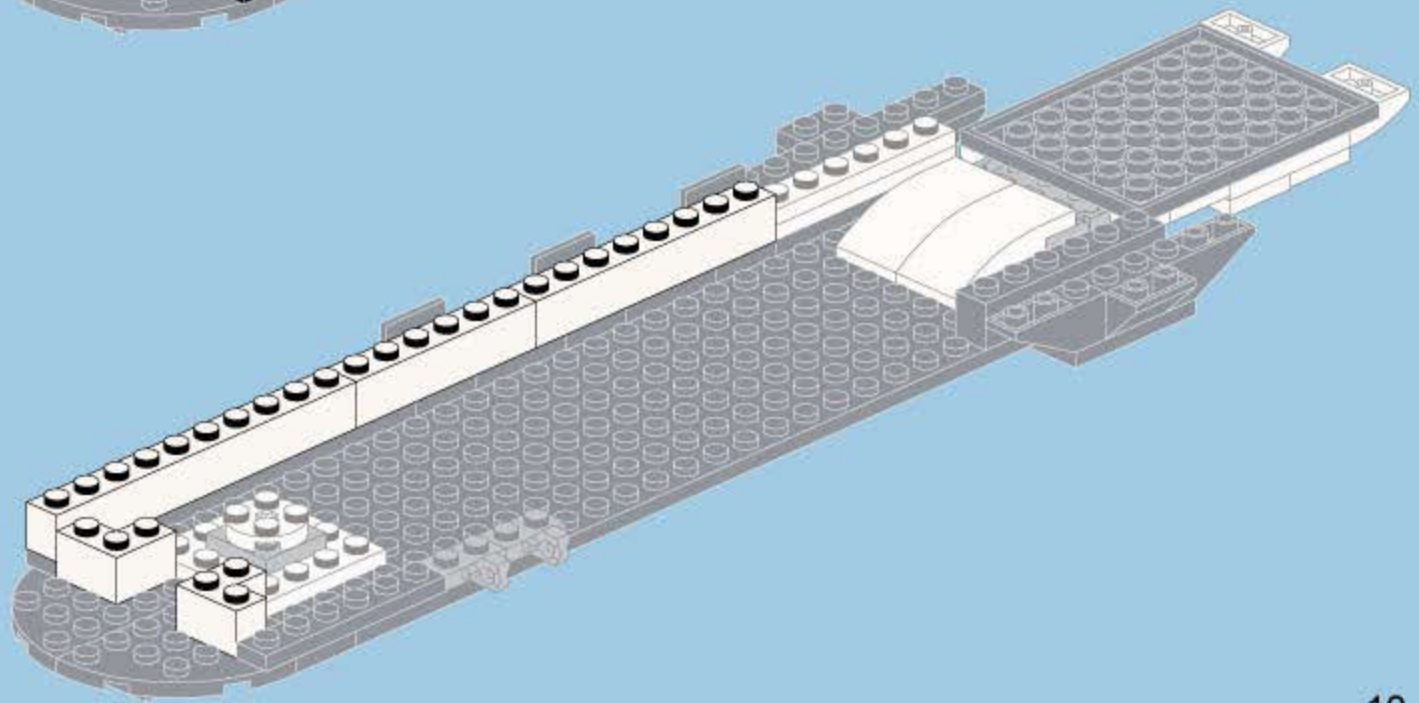
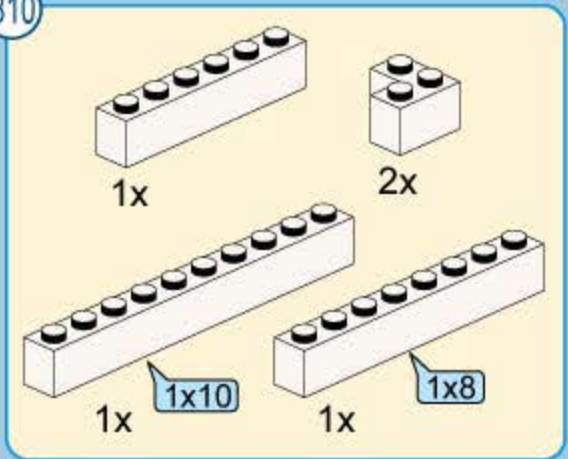

B11

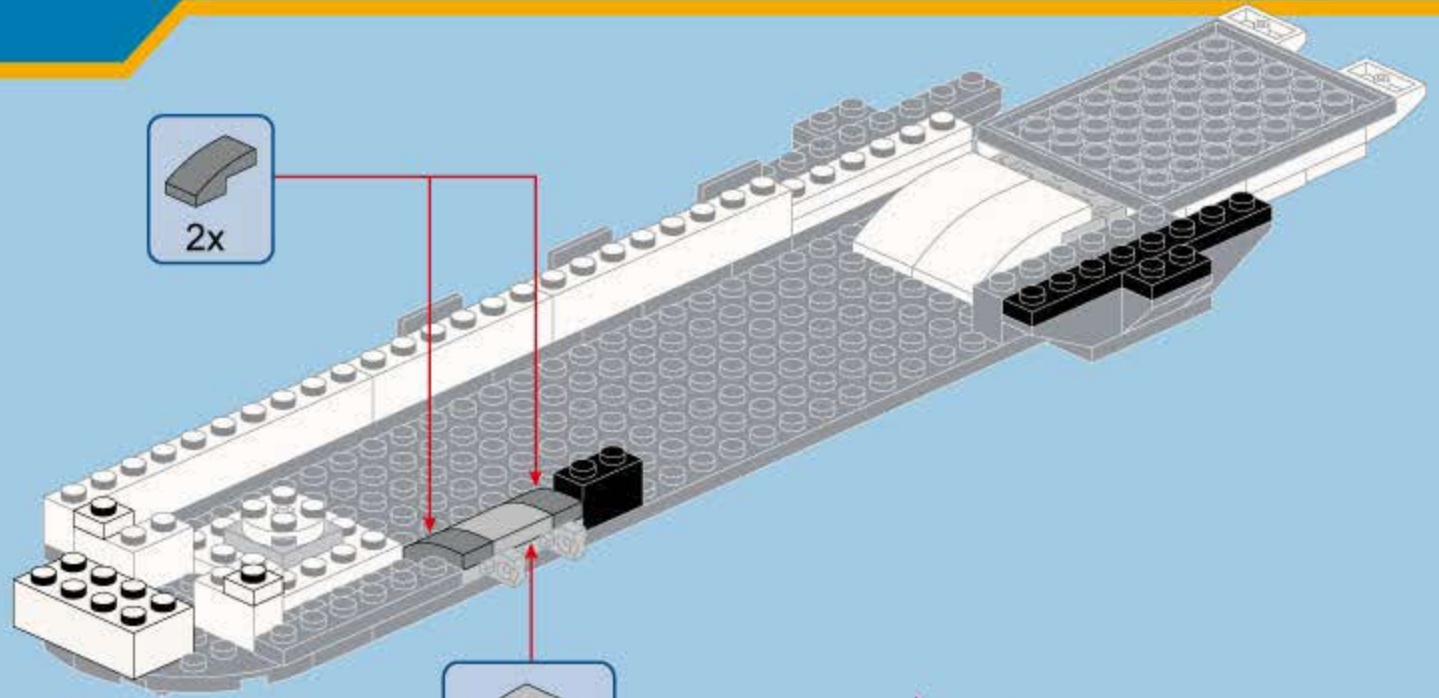
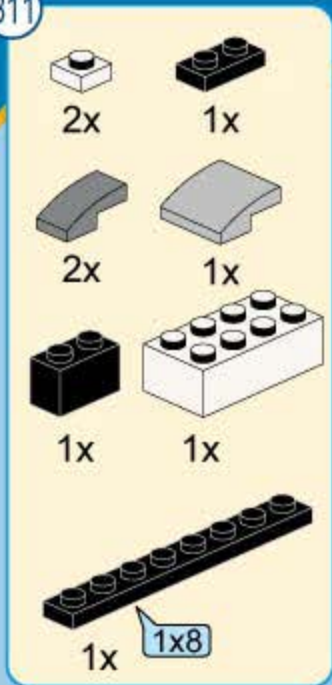

B12

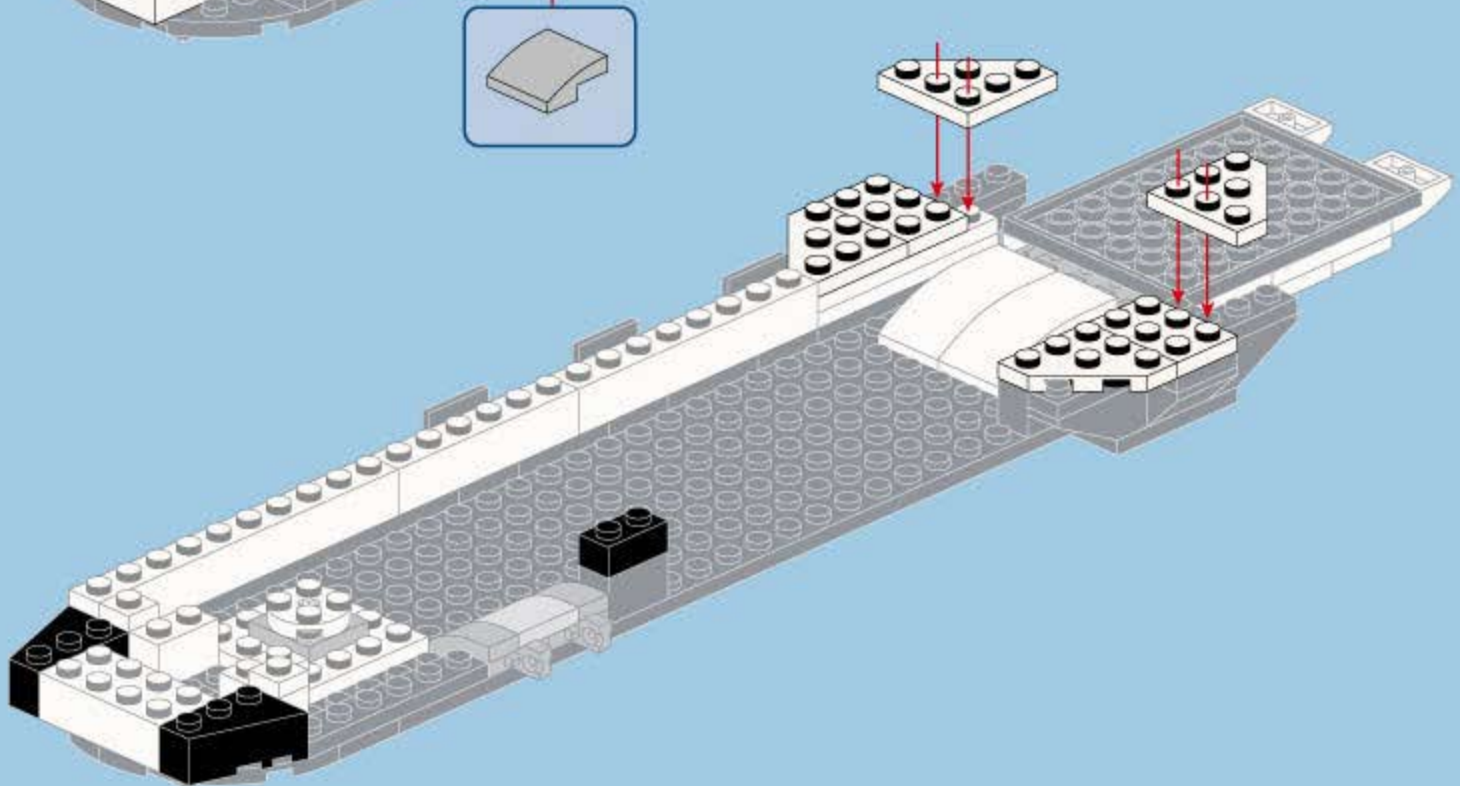
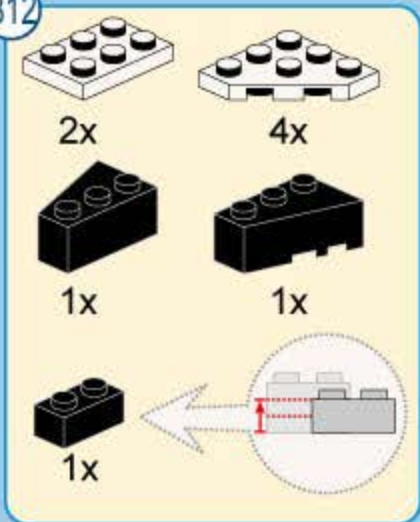



B13

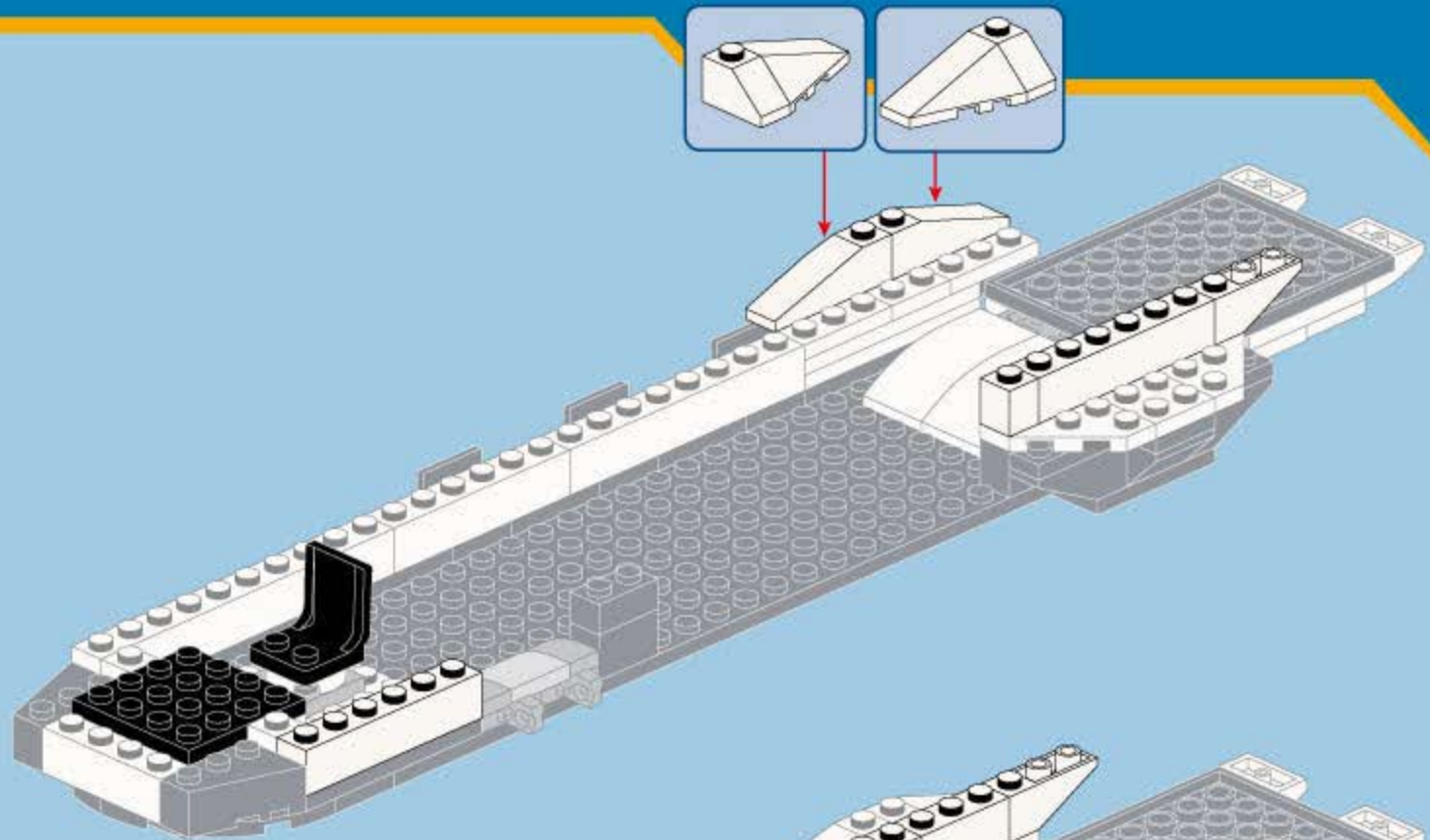
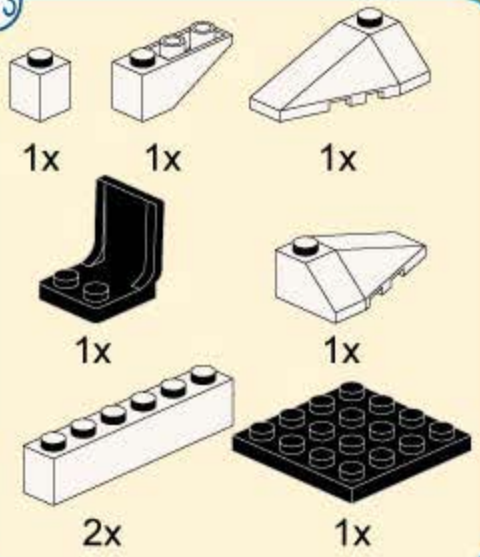

B14

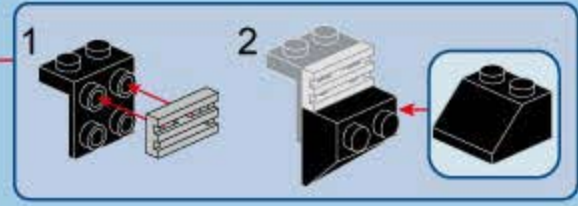
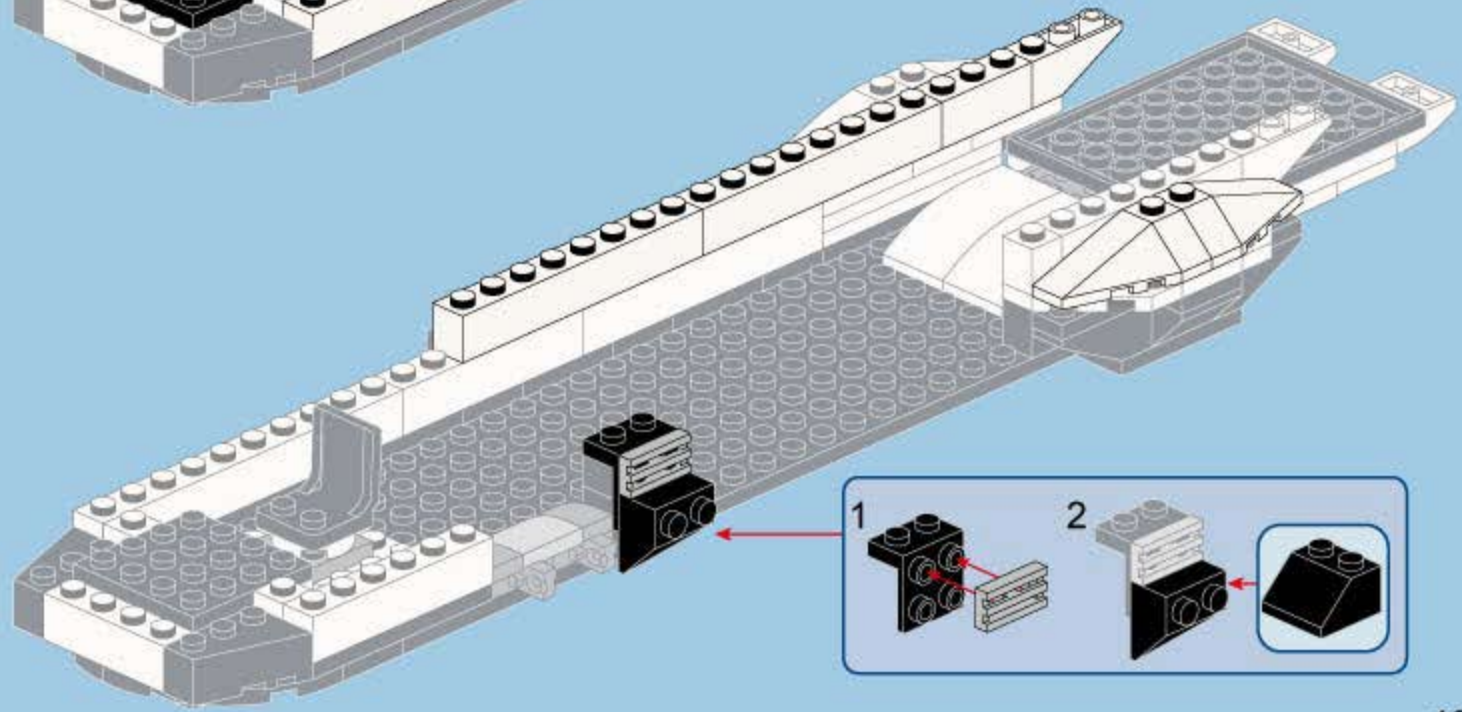
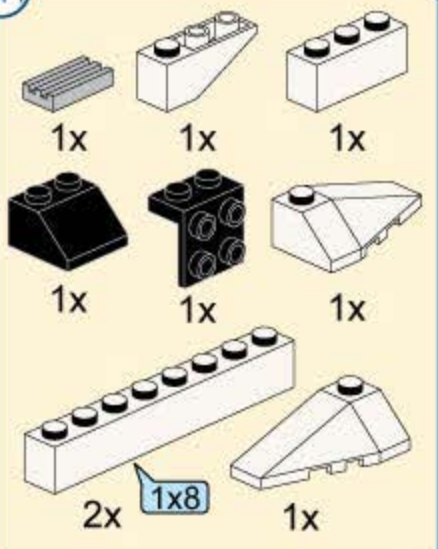

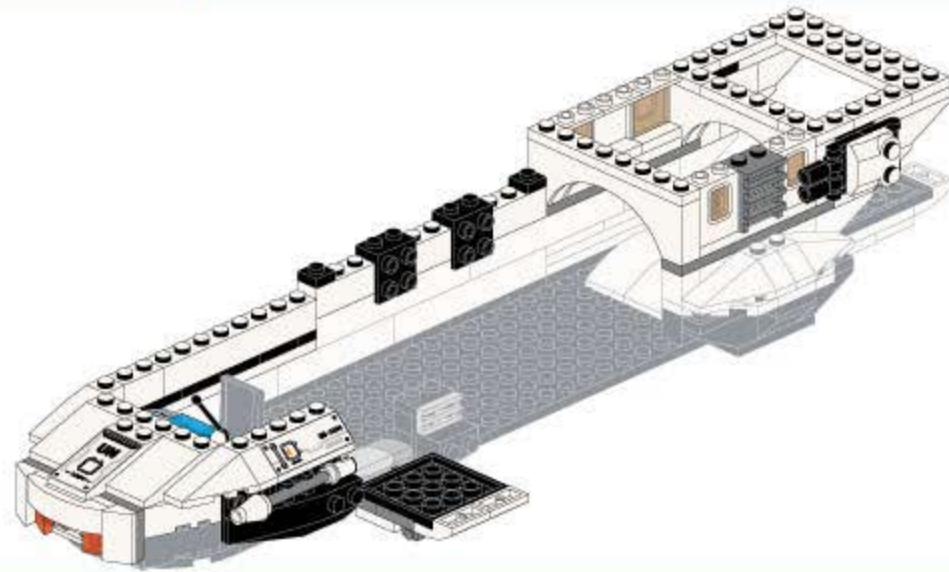

B15

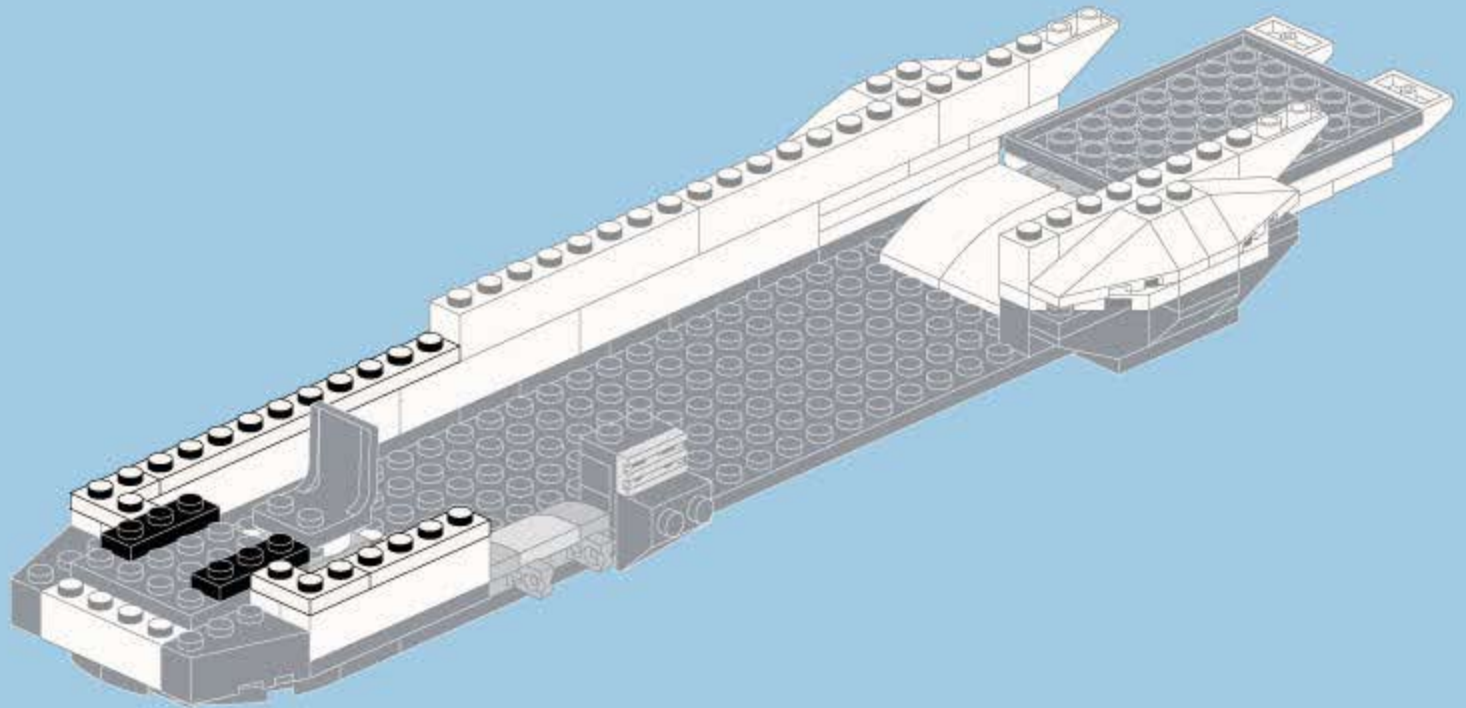
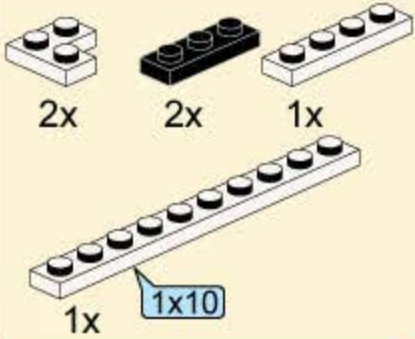



B16

- 2x
- 1x
- 2x
- 2x
- 1x
- 1x

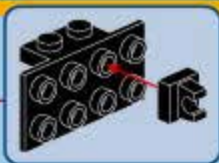
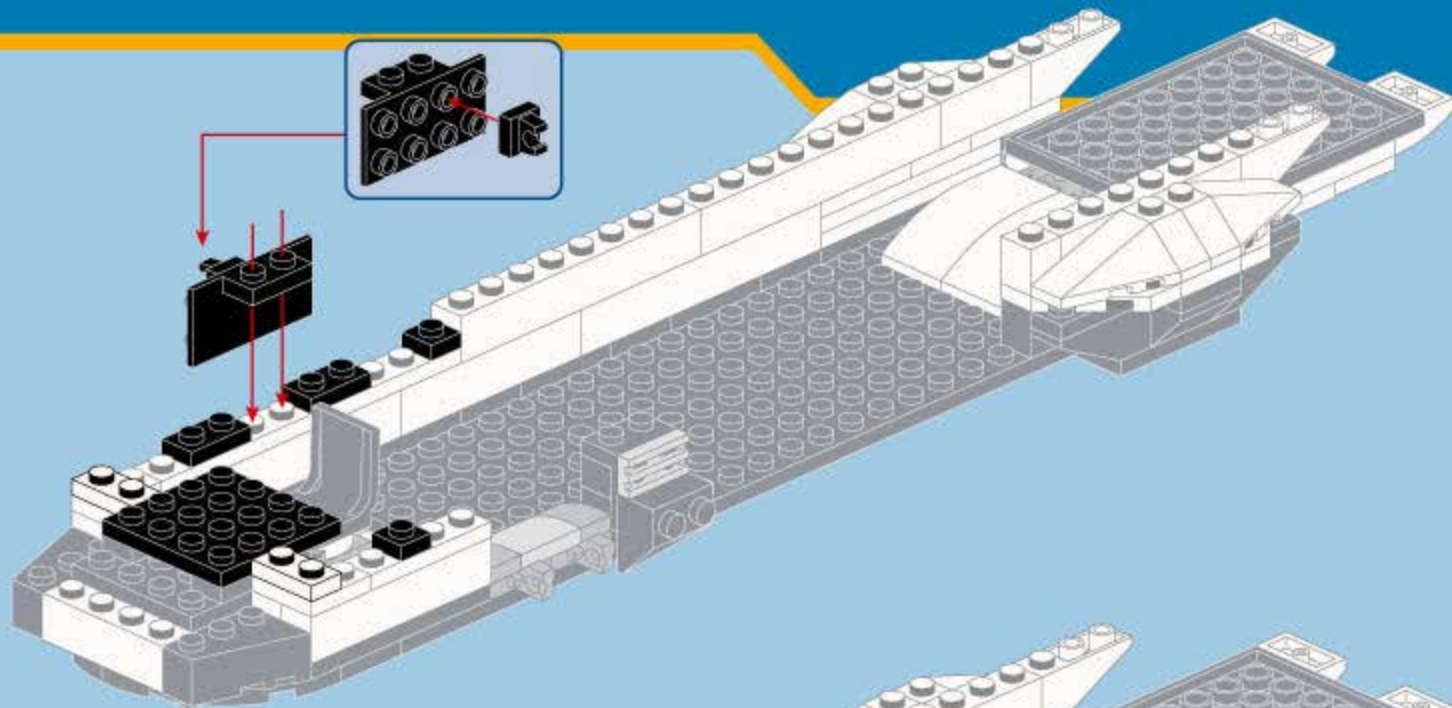





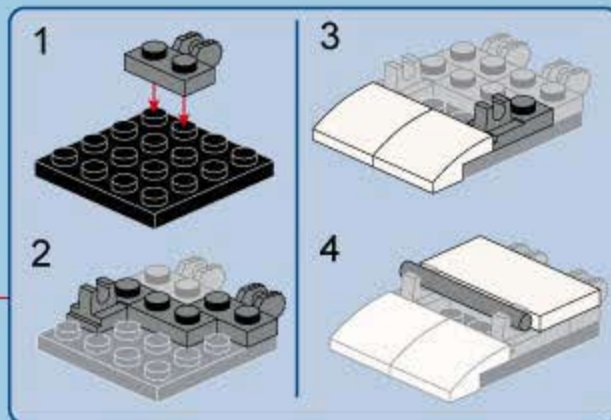
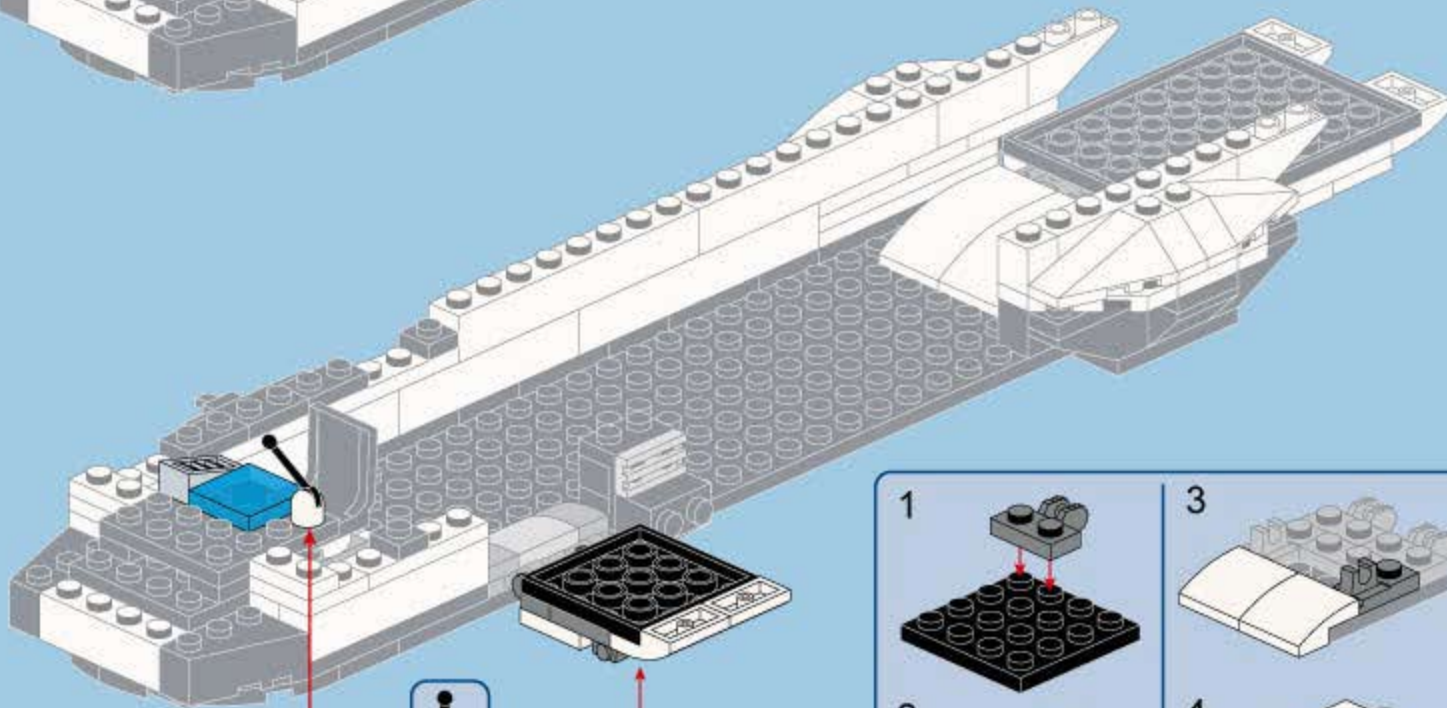

B17

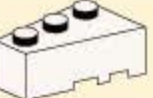
- 1x
- 1x
- 1x
- 1x
- 2x
- 2x
- 1x
- 2x
- 1x
- 1x
- 1x

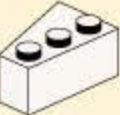

B18

 3x	 1x
 1x	 1x
 1x	 3x
 2x <span style="border: 1px solid blue; padding: 2px;">1x8</span>	

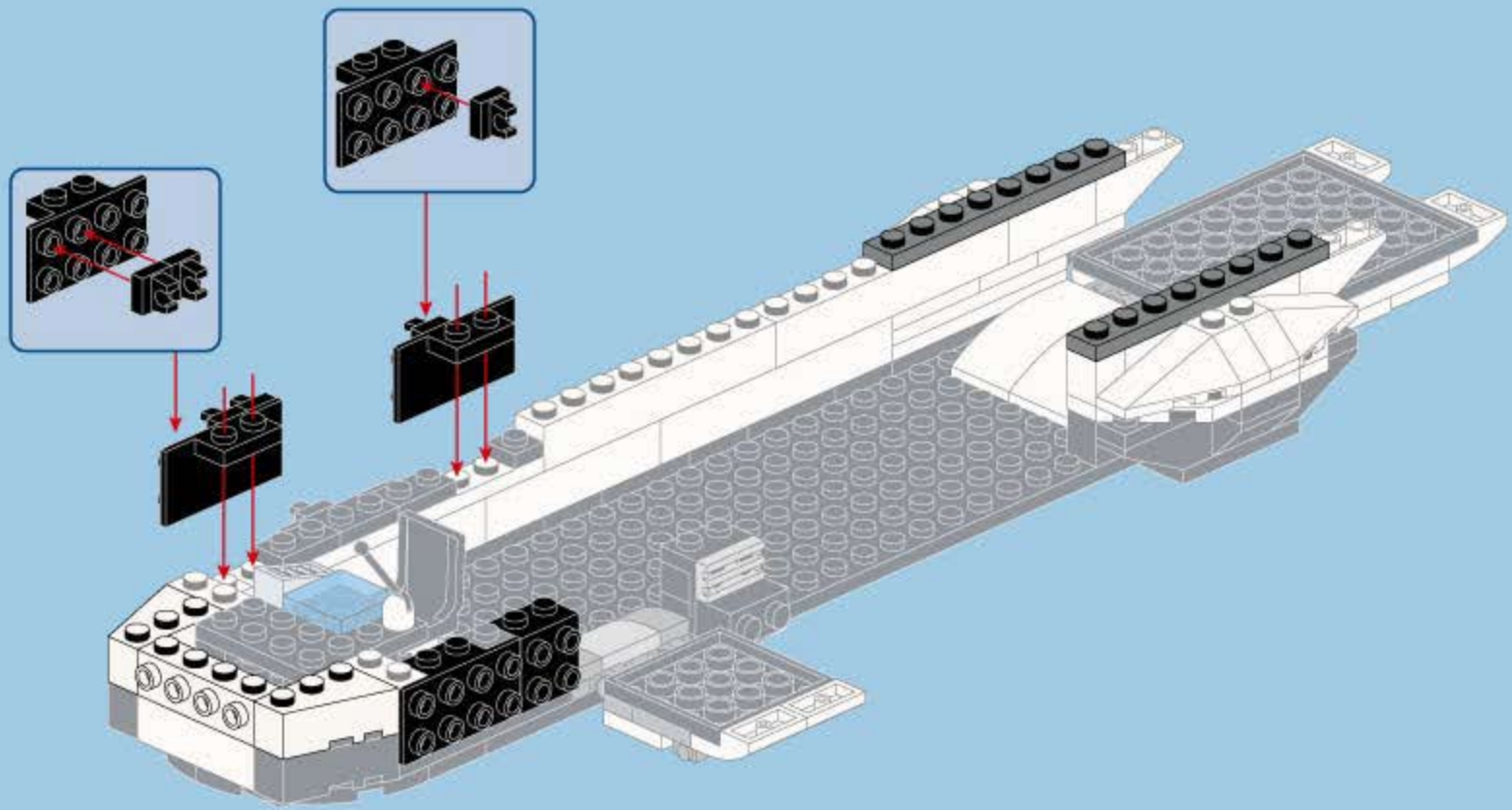



B19

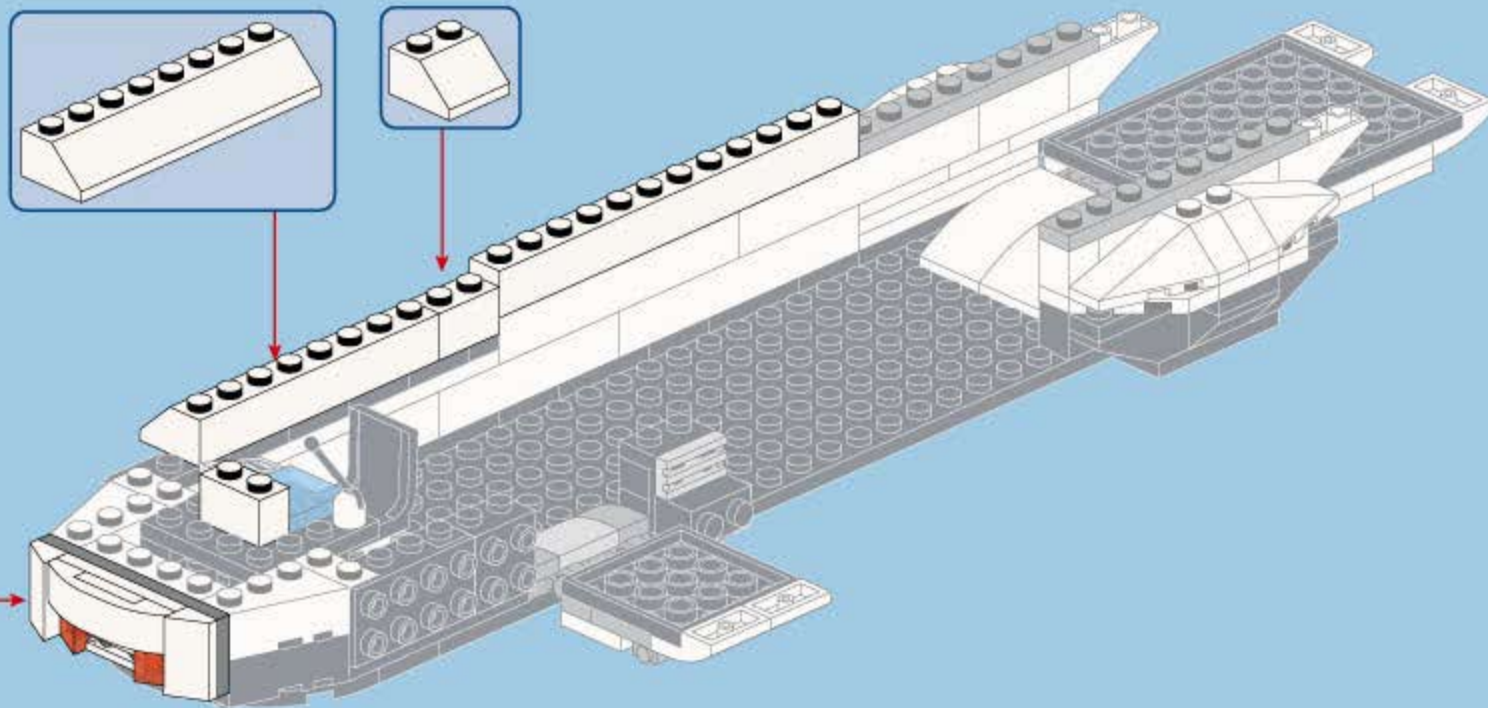
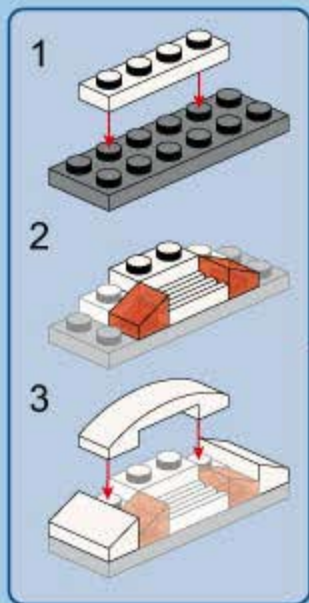
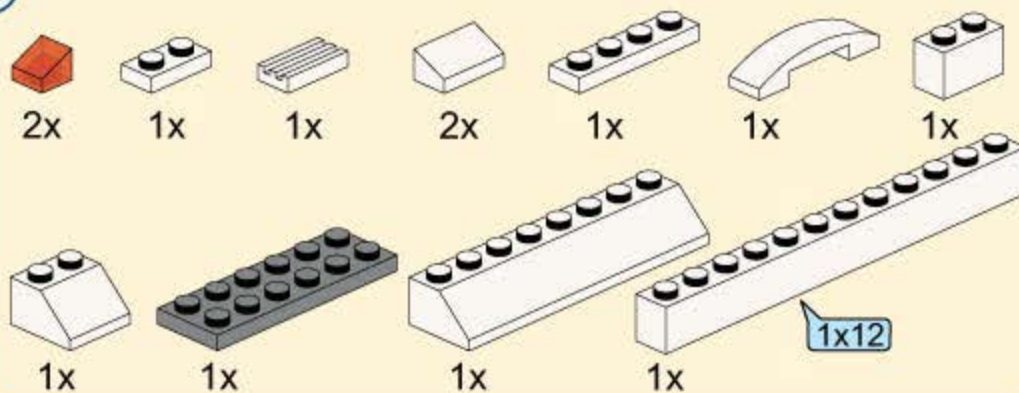

B20

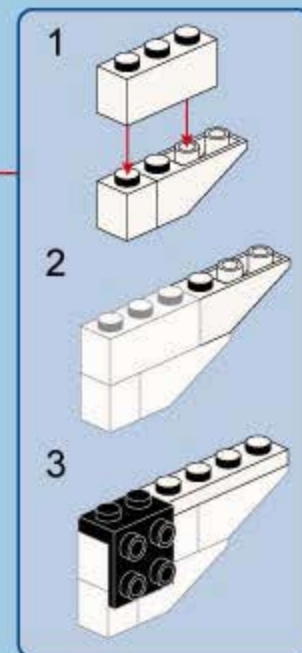
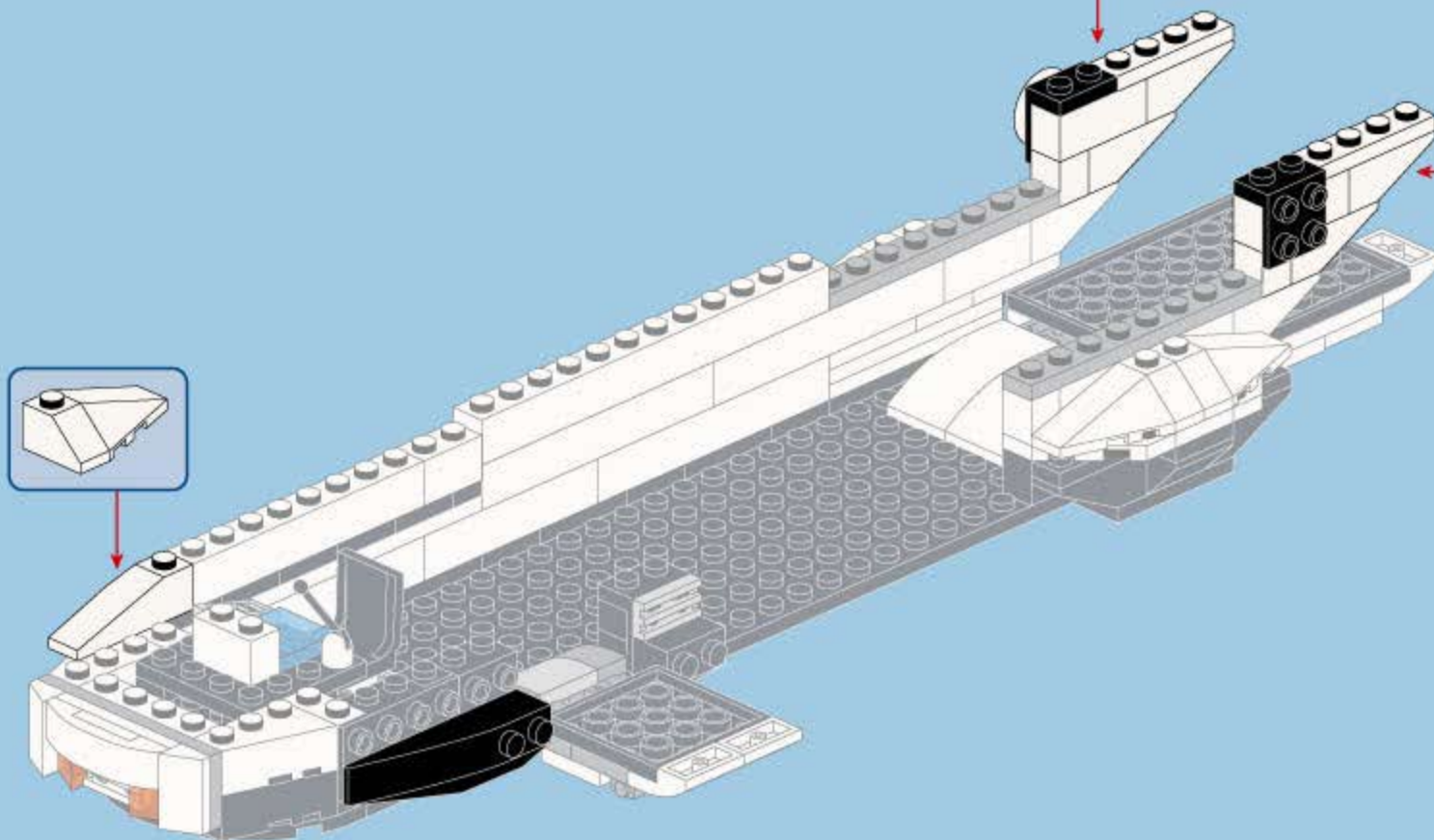
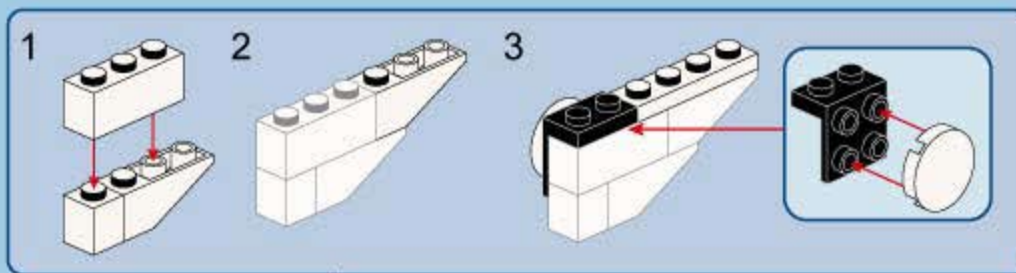
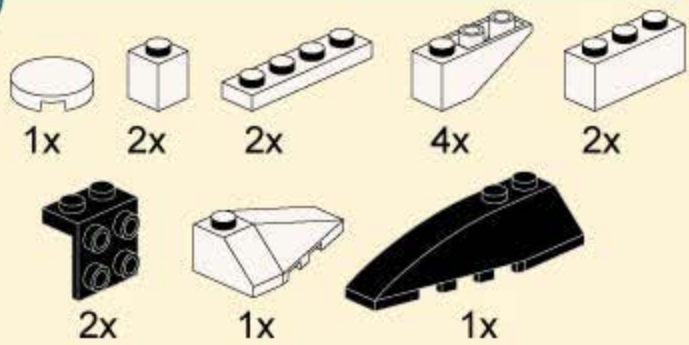



B21

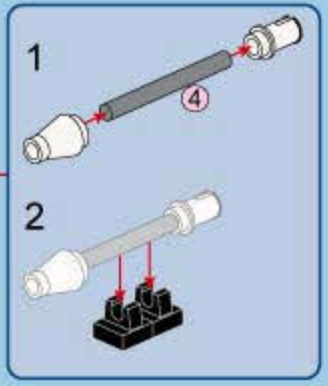
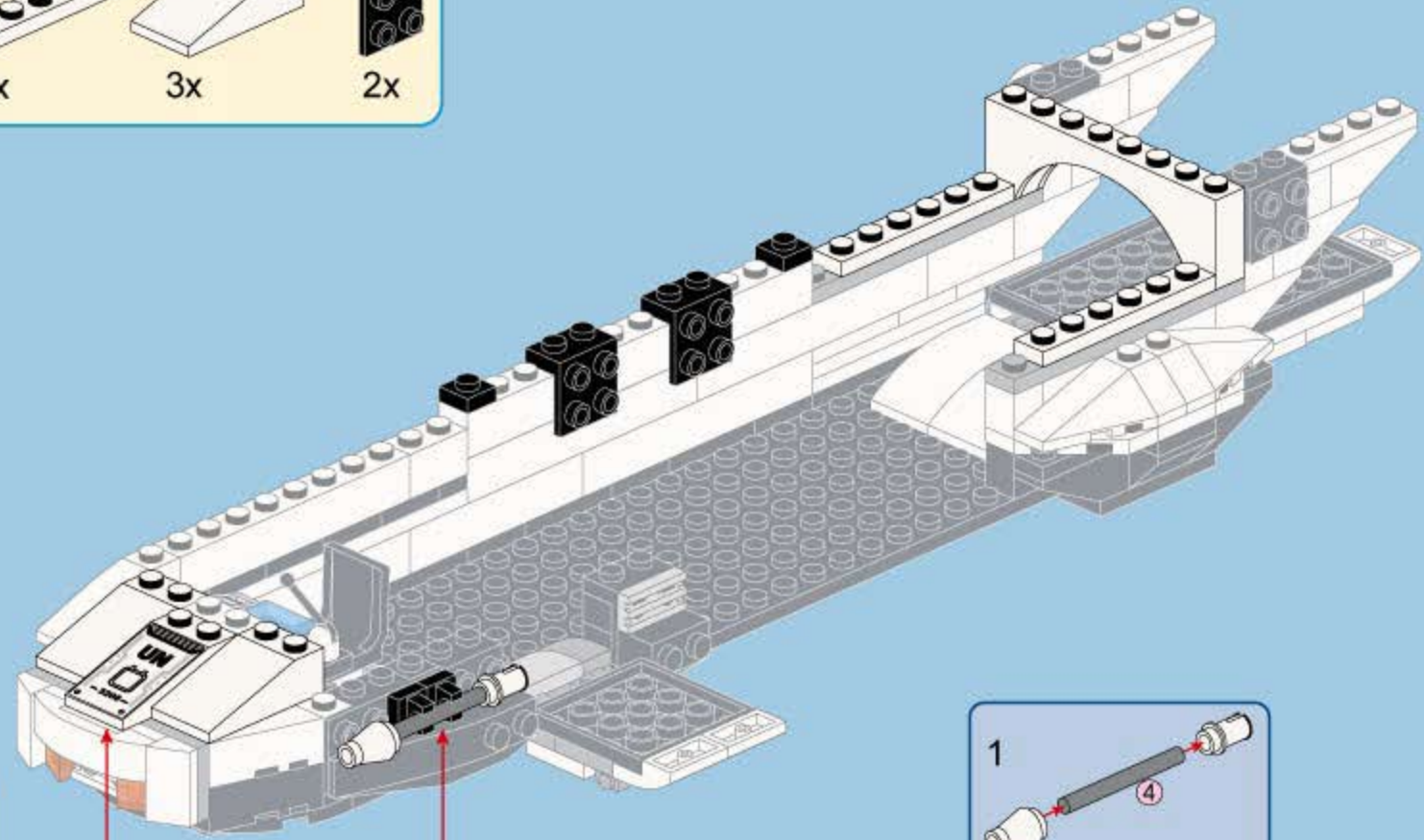
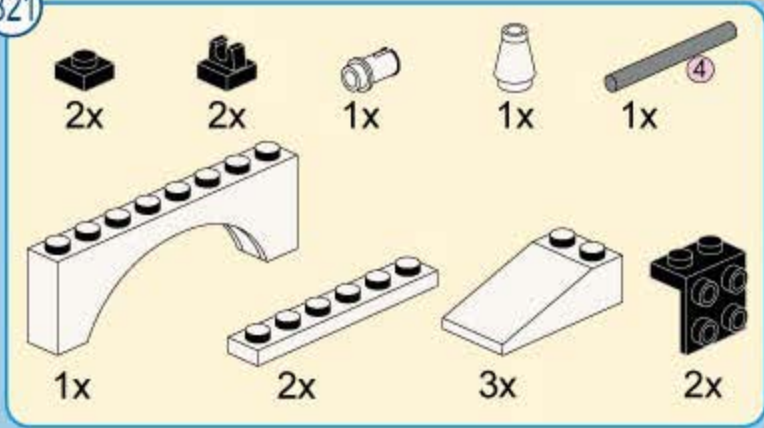

B22

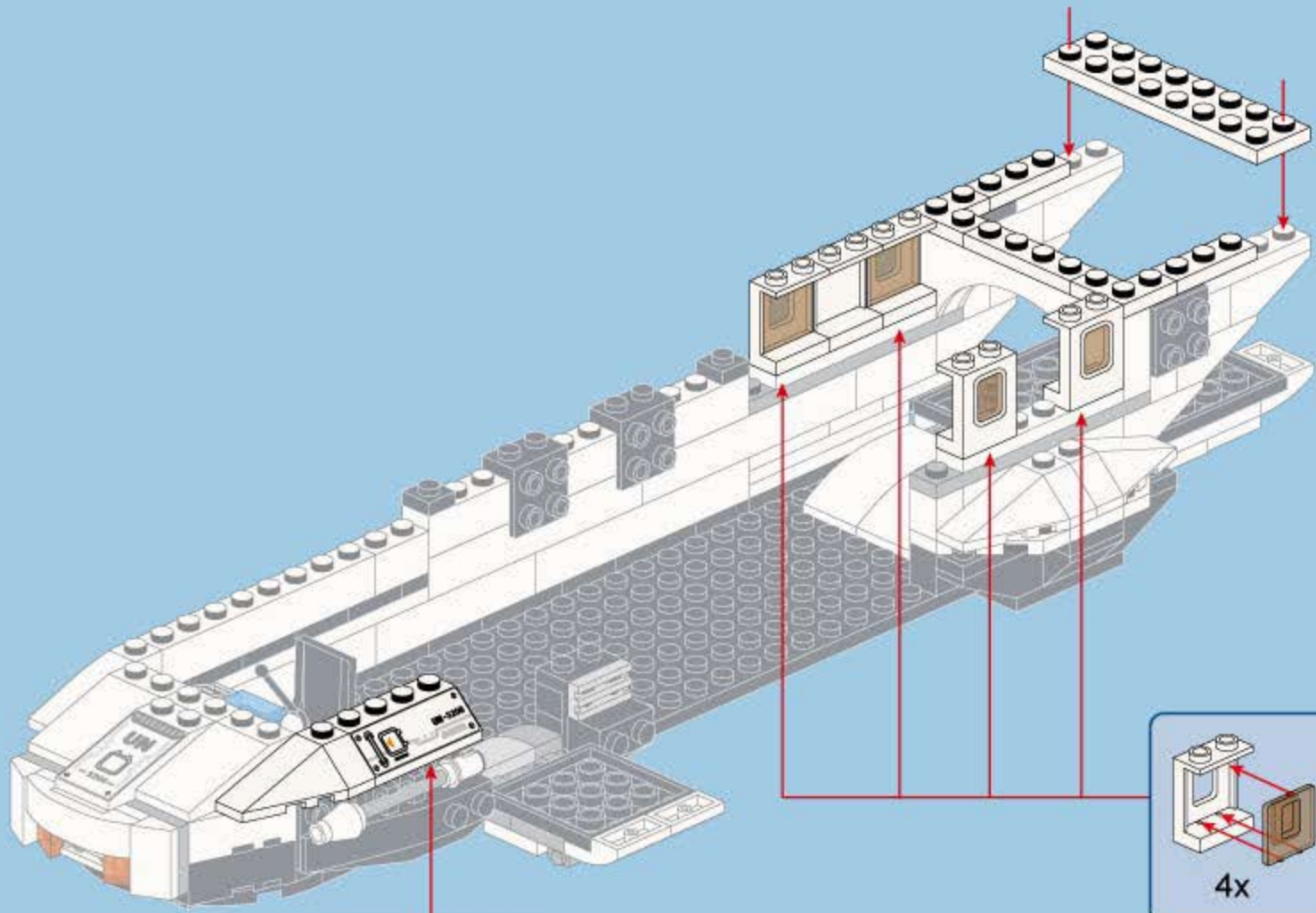
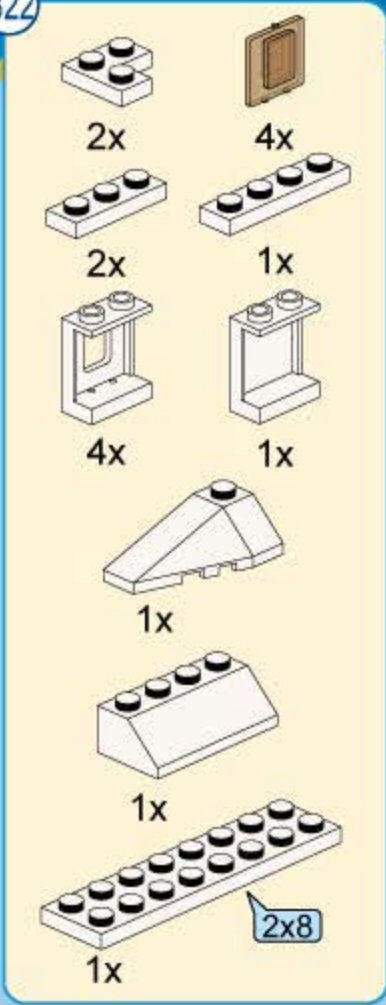







+

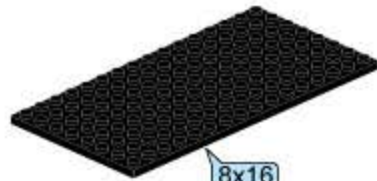

8x16

=

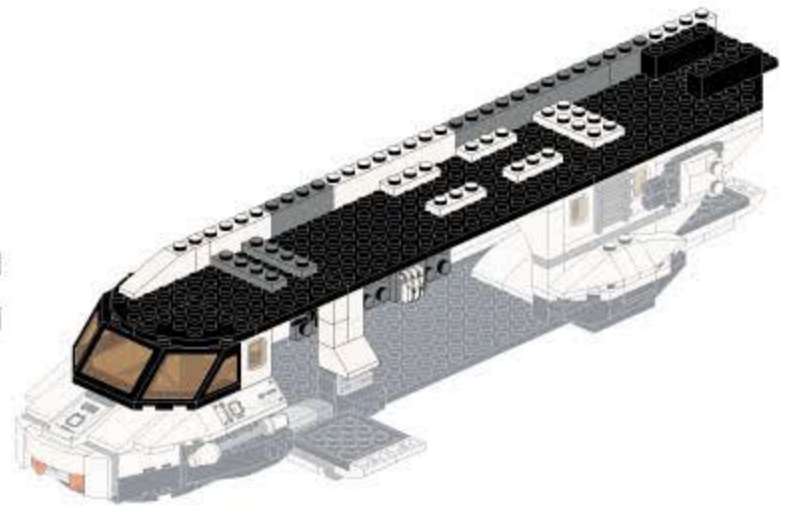

B24



3x



3x

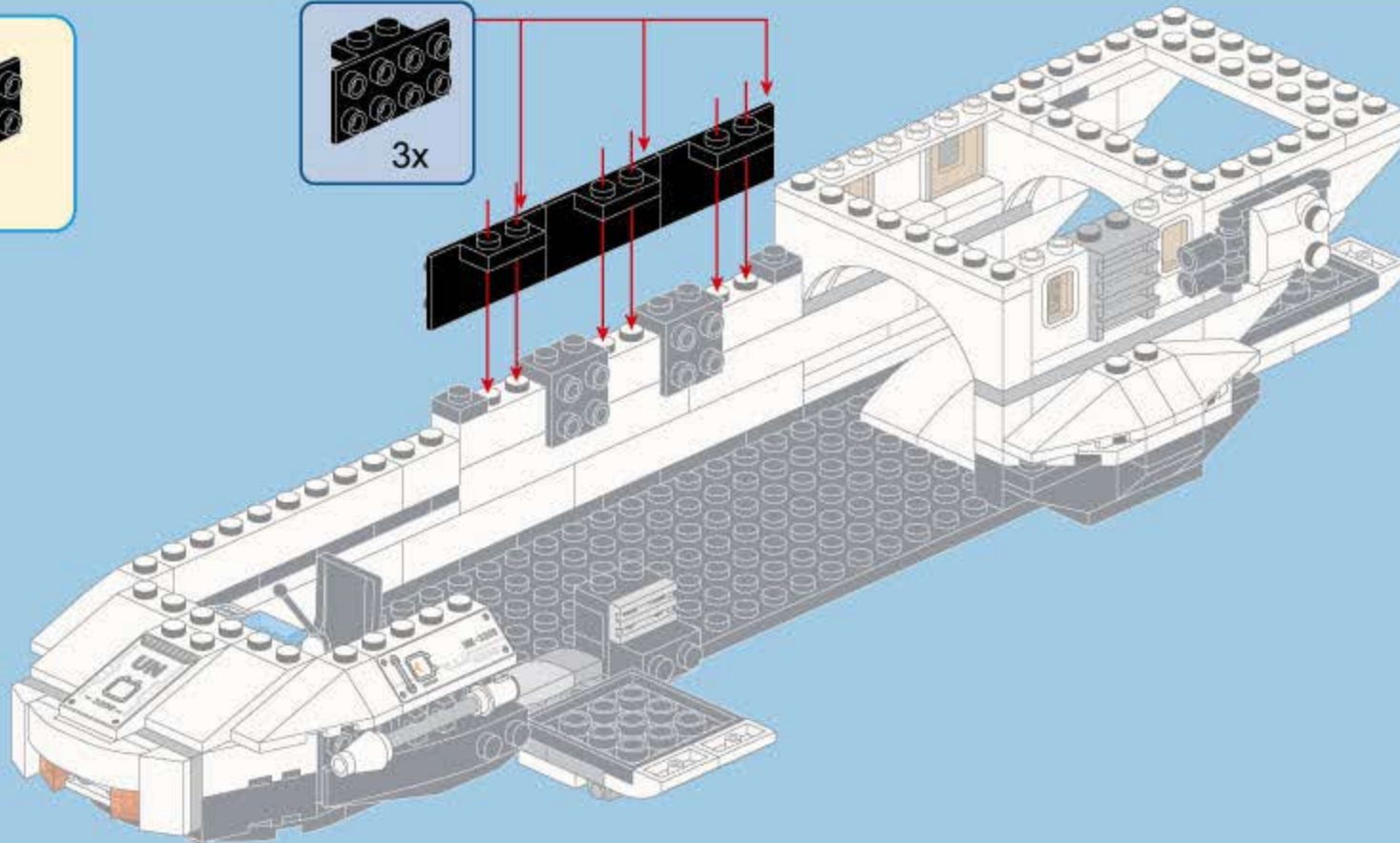



B25

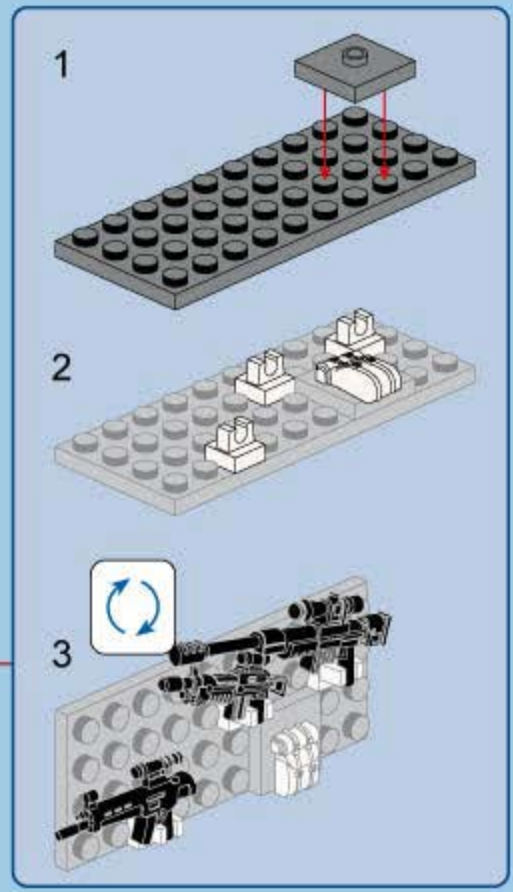
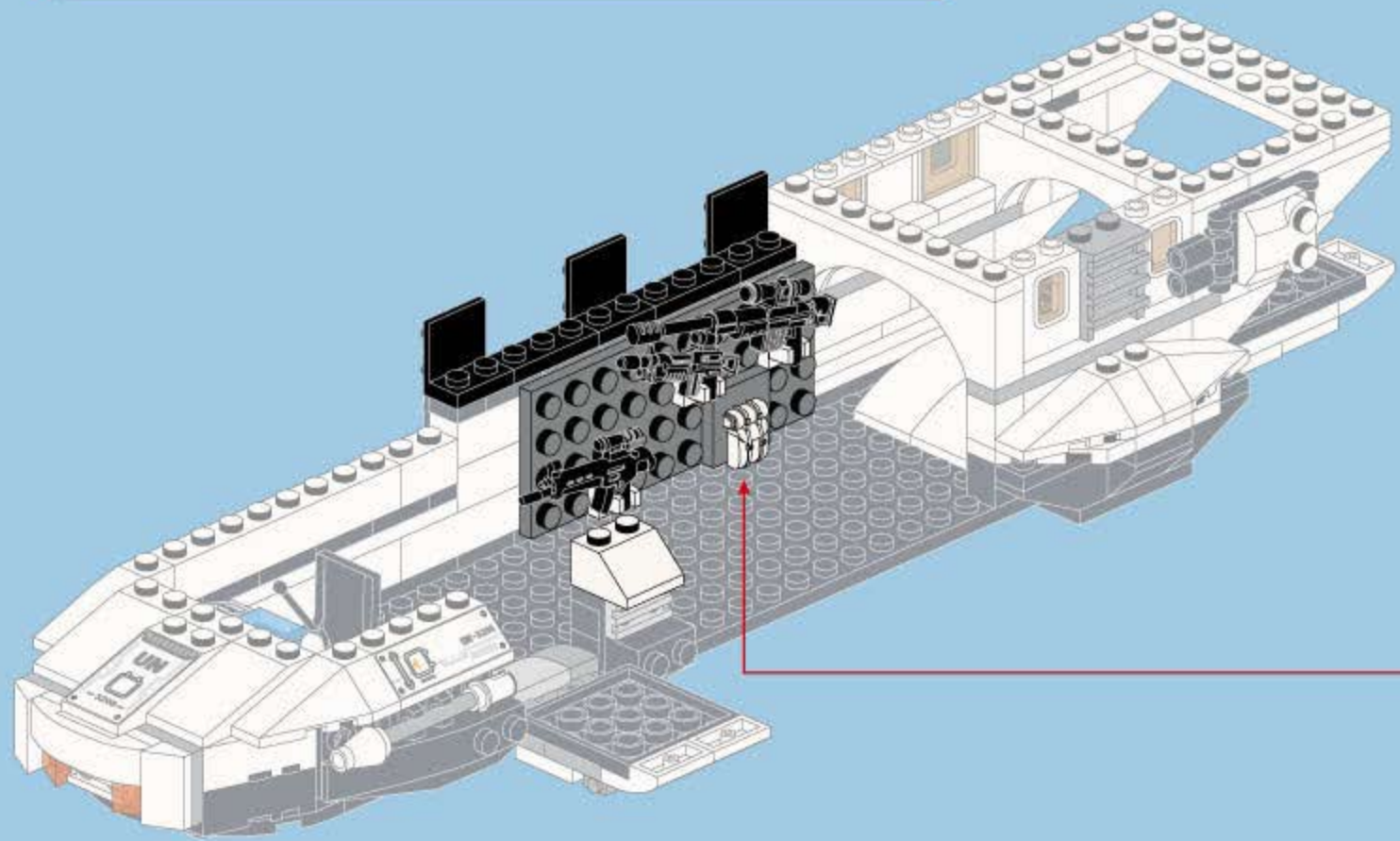
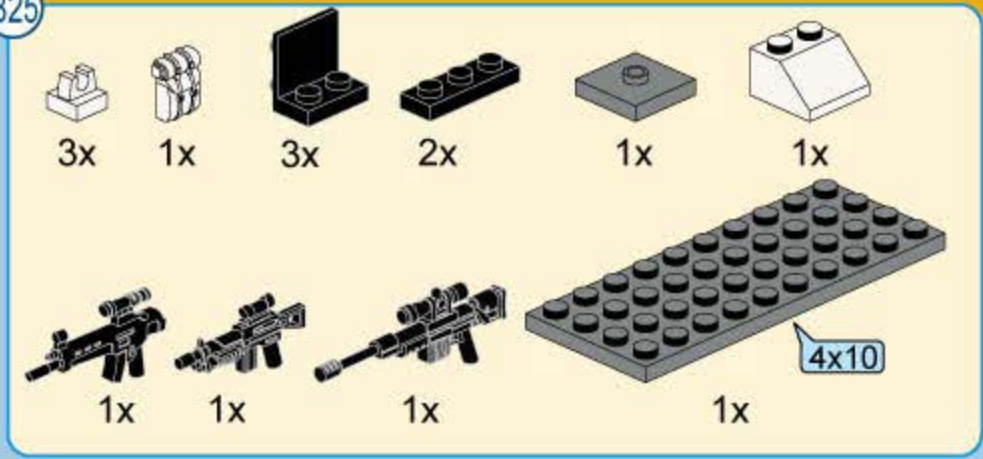

B26

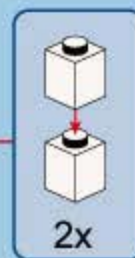
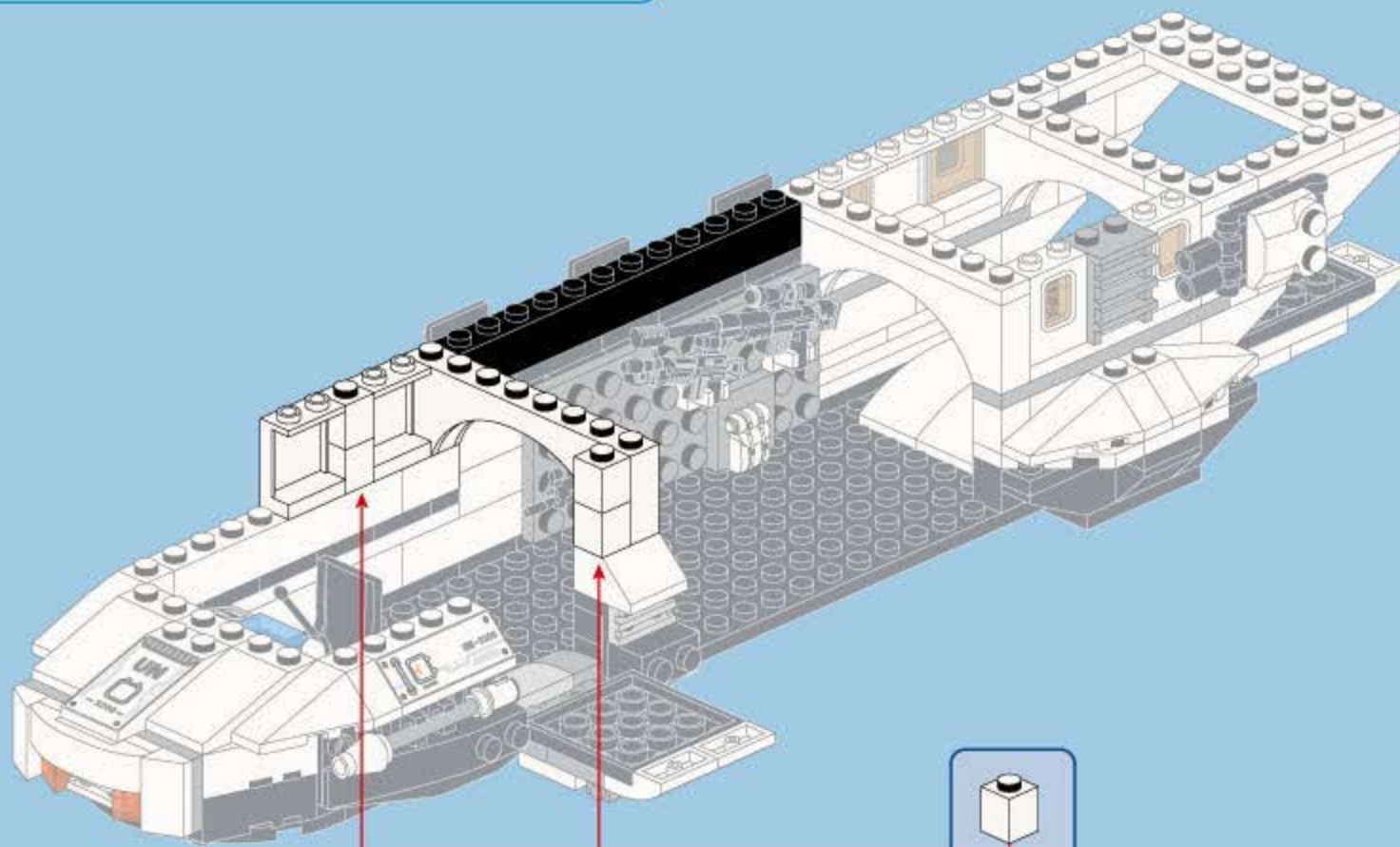
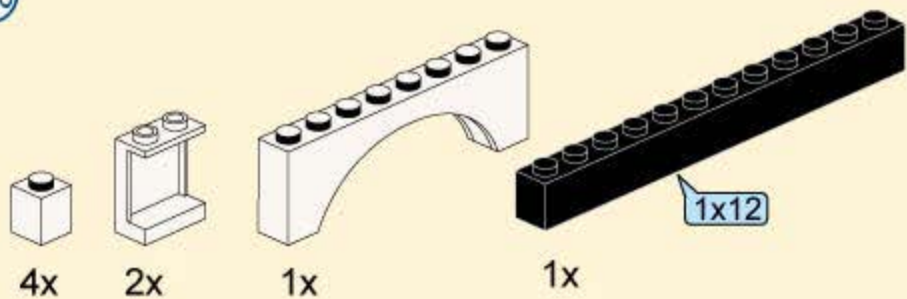



B27



2x



2x



2x



1x

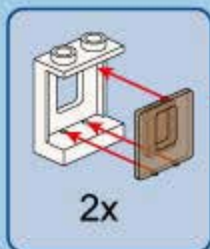

2x

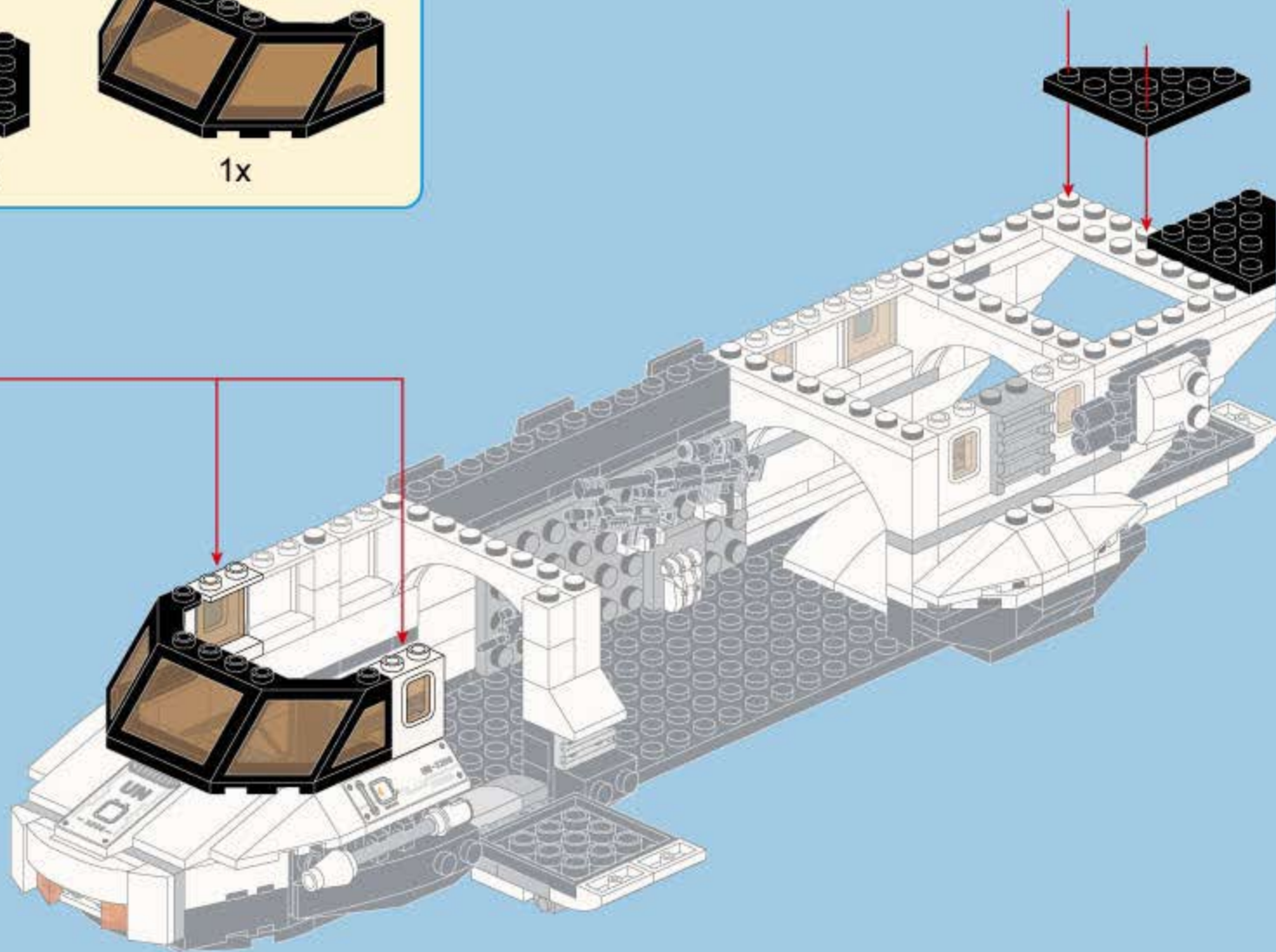

B28

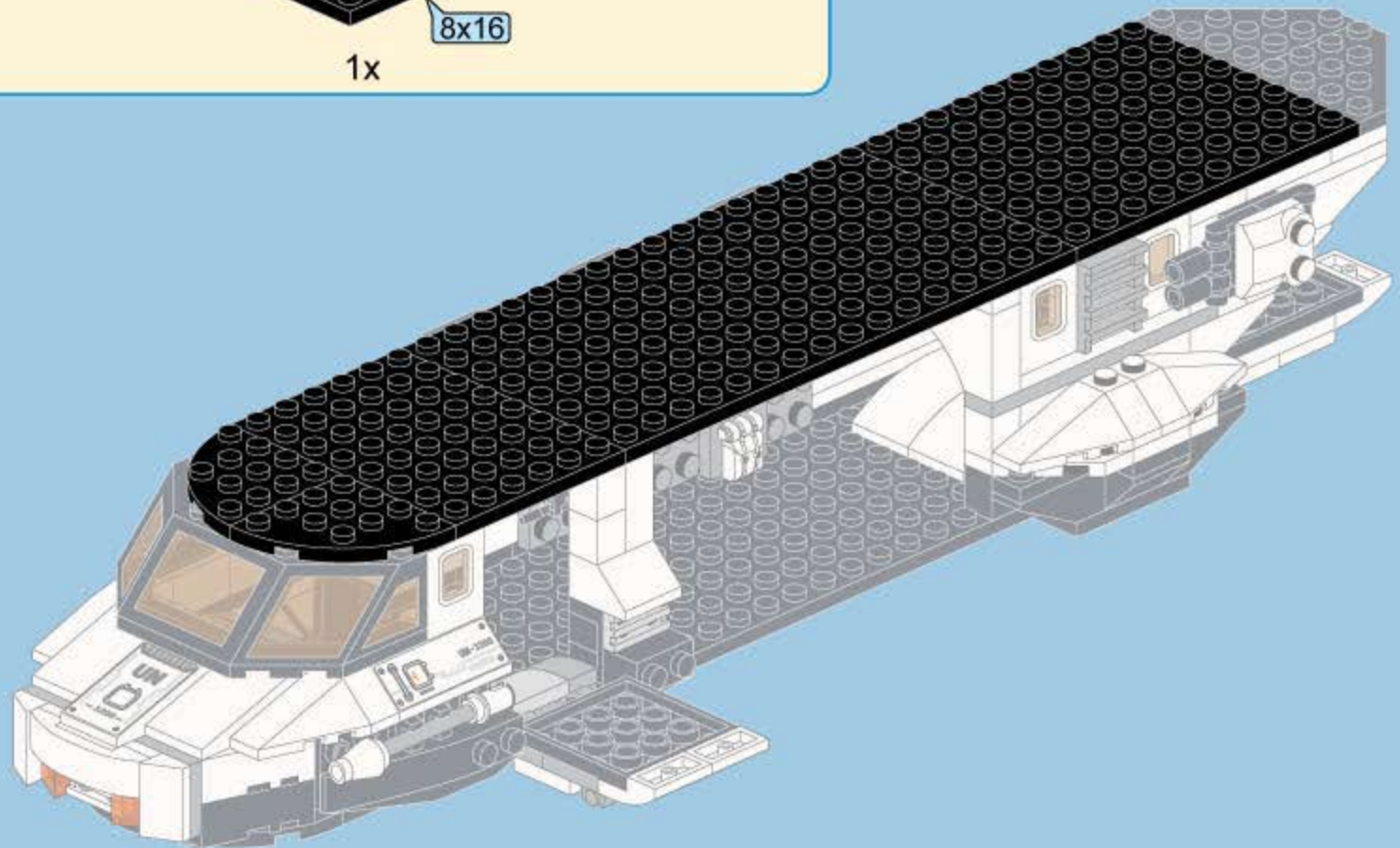
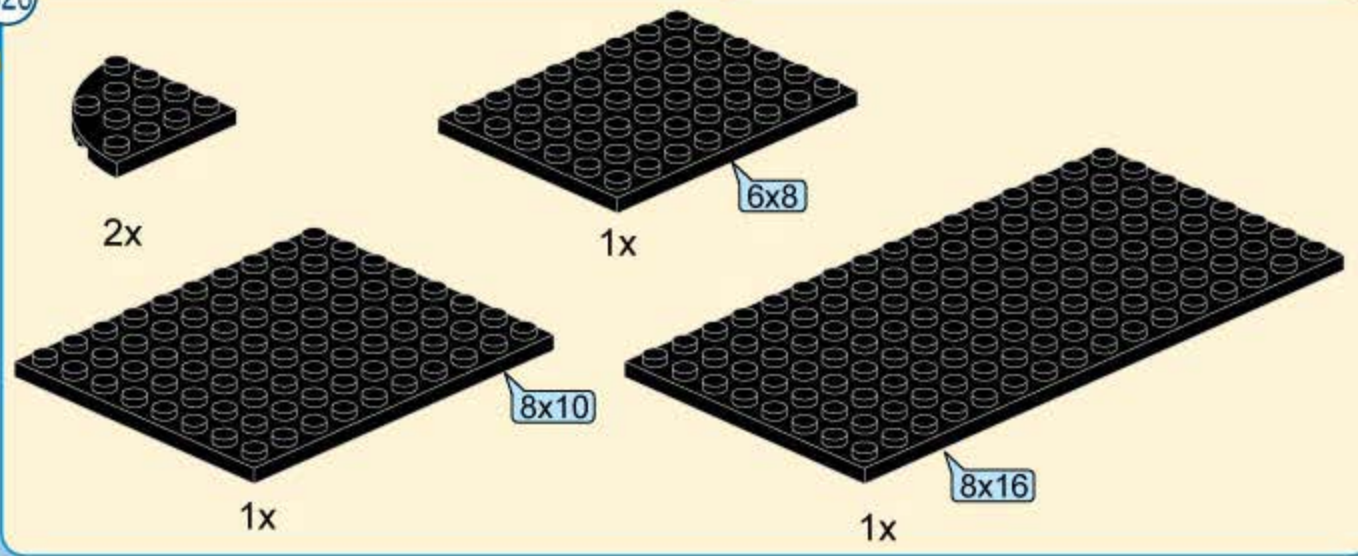



B29



1x



6x



1x

1x4



2x

1x6



1x

2x6



1x

2x6



2x



1x

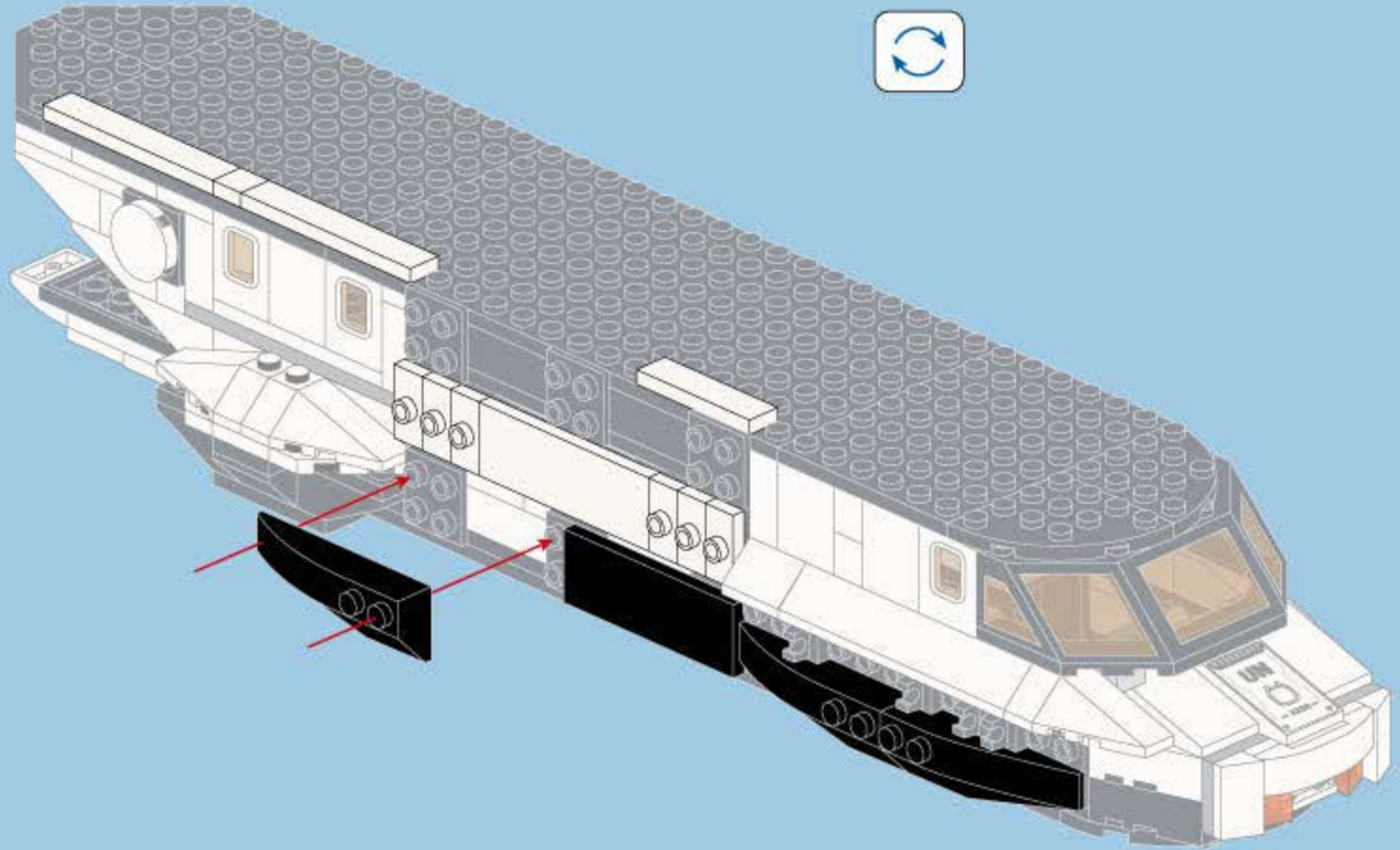

B30

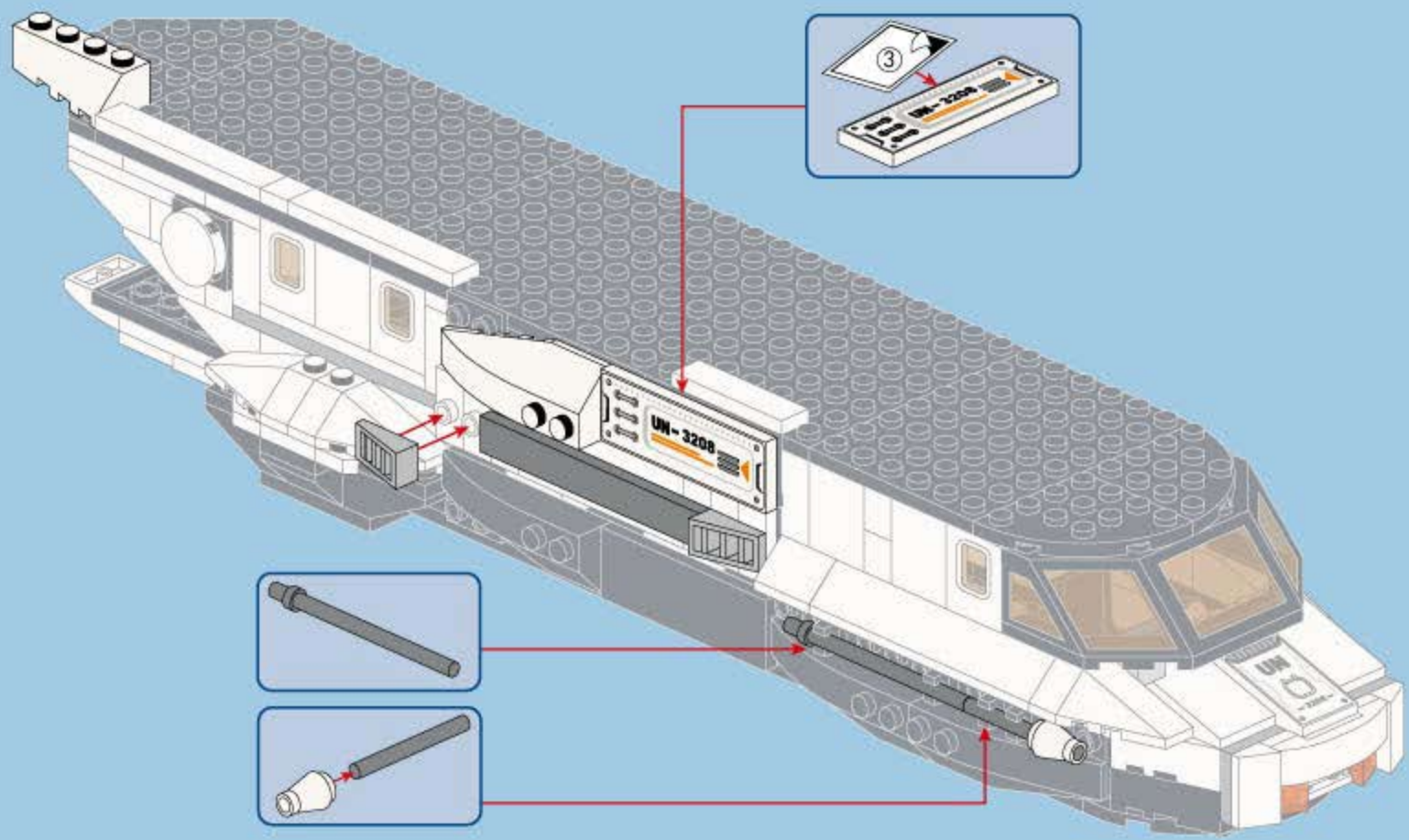
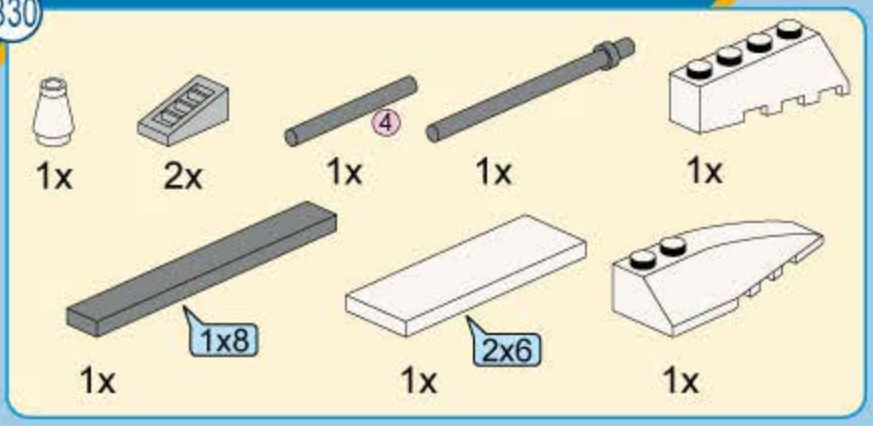



B31

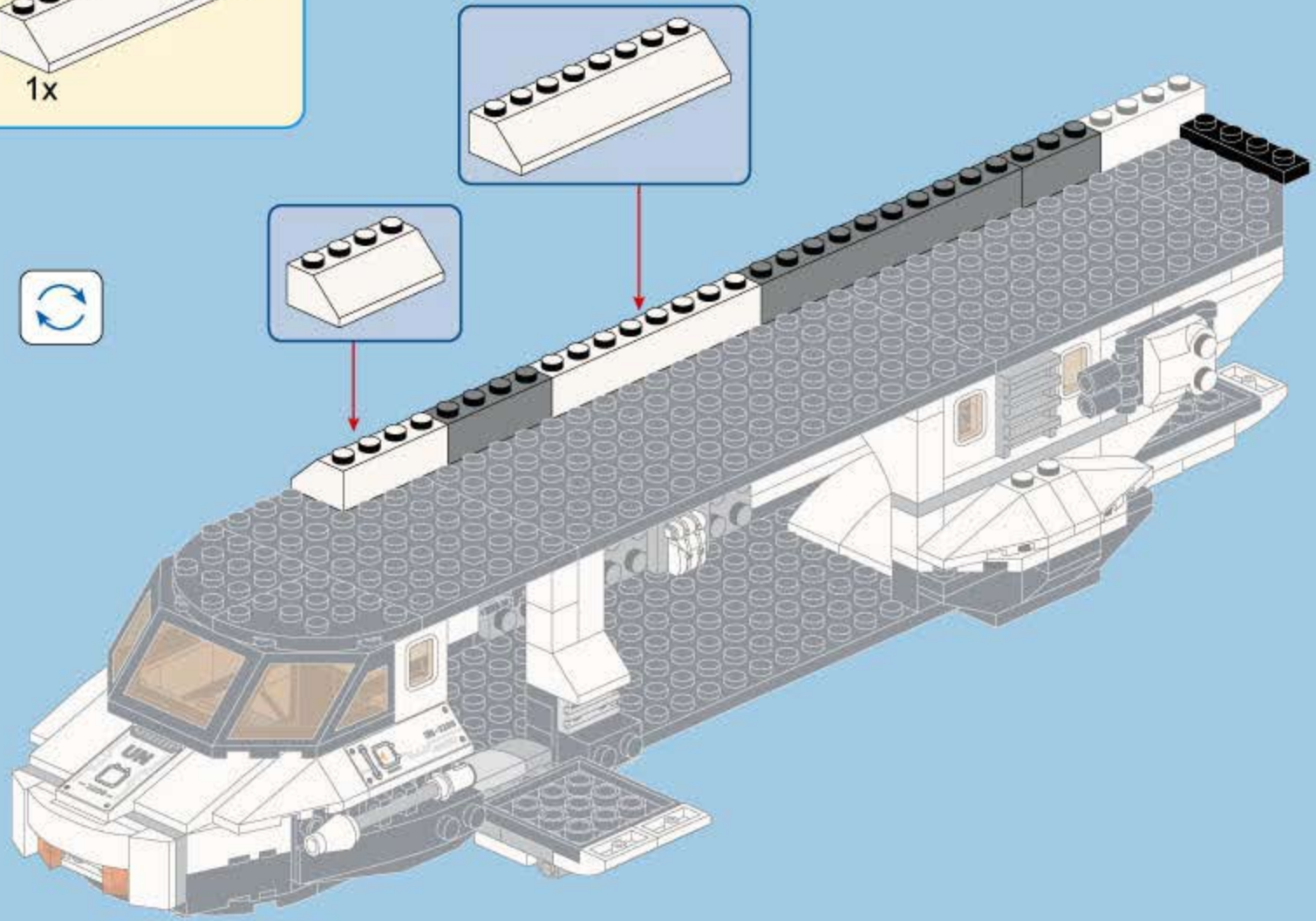
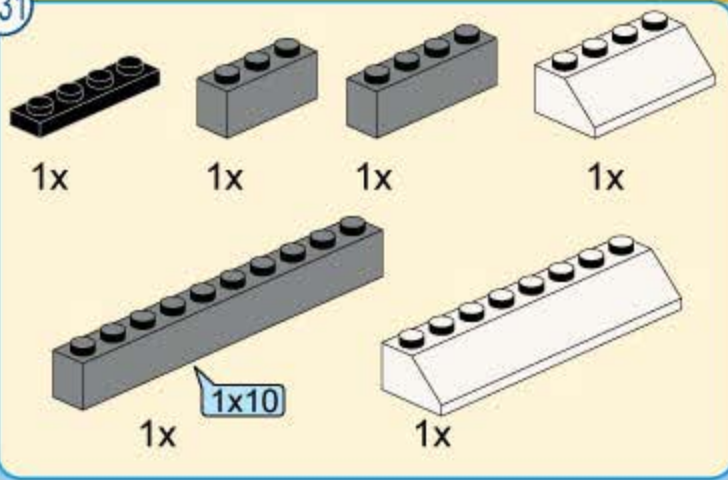

B32



4x



2x



1x



1x



2x



1x

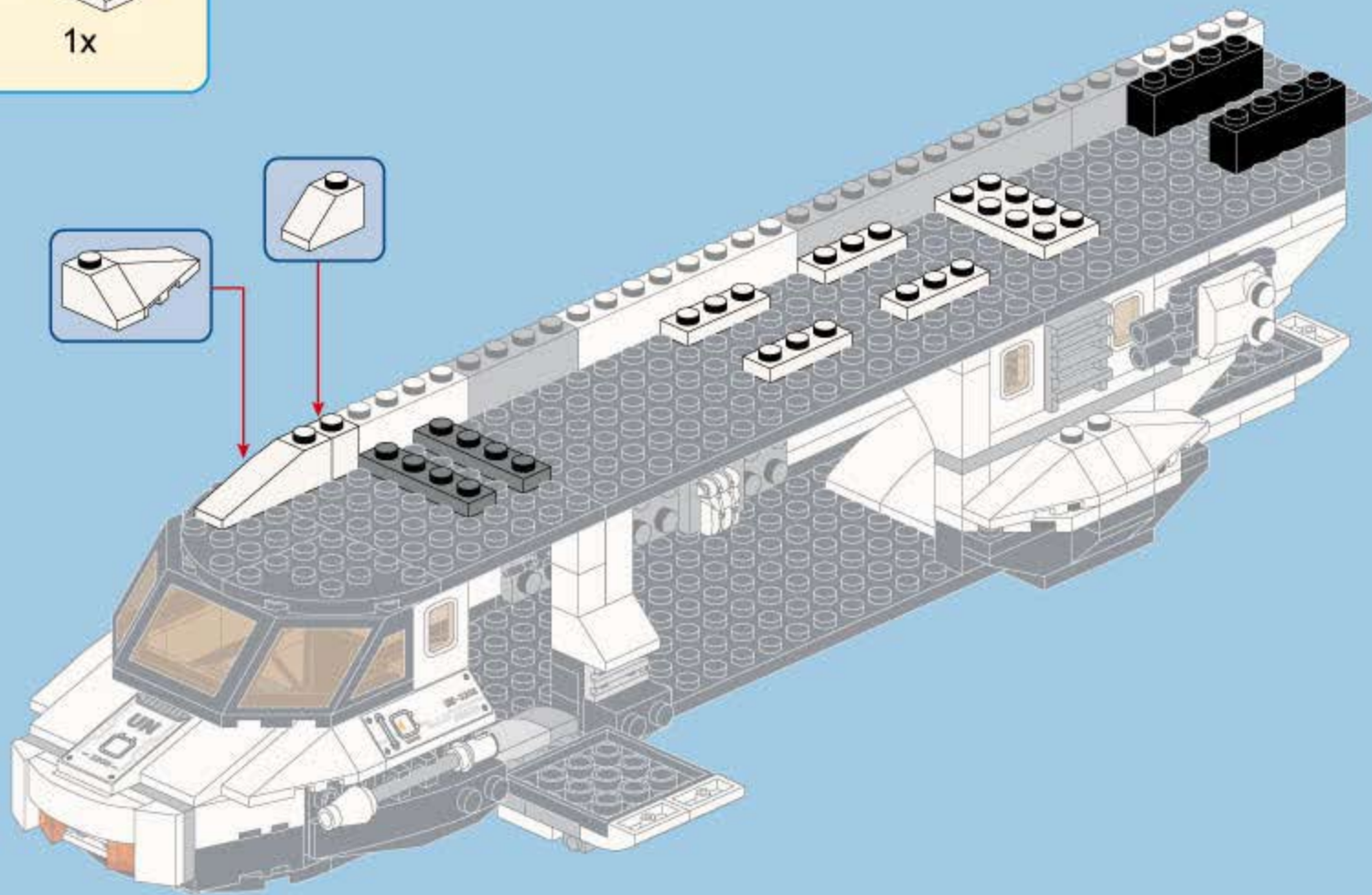



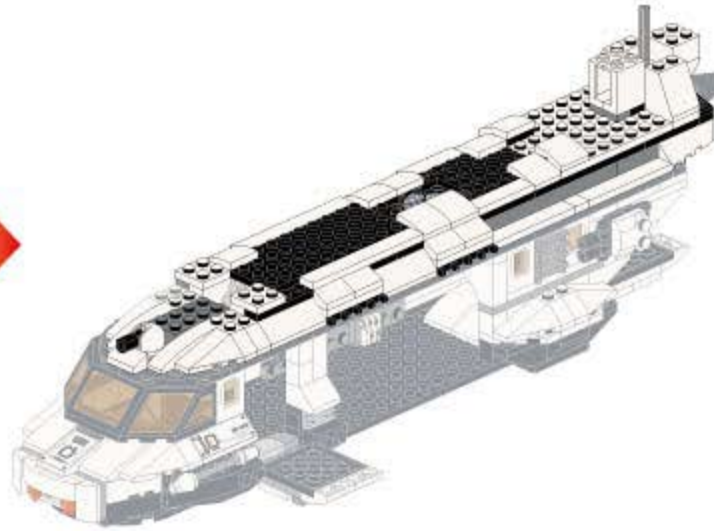

B33



1x



6x

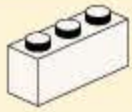

2x

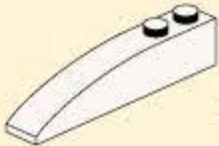

1x



1x



2x

1x10



1x

1x8

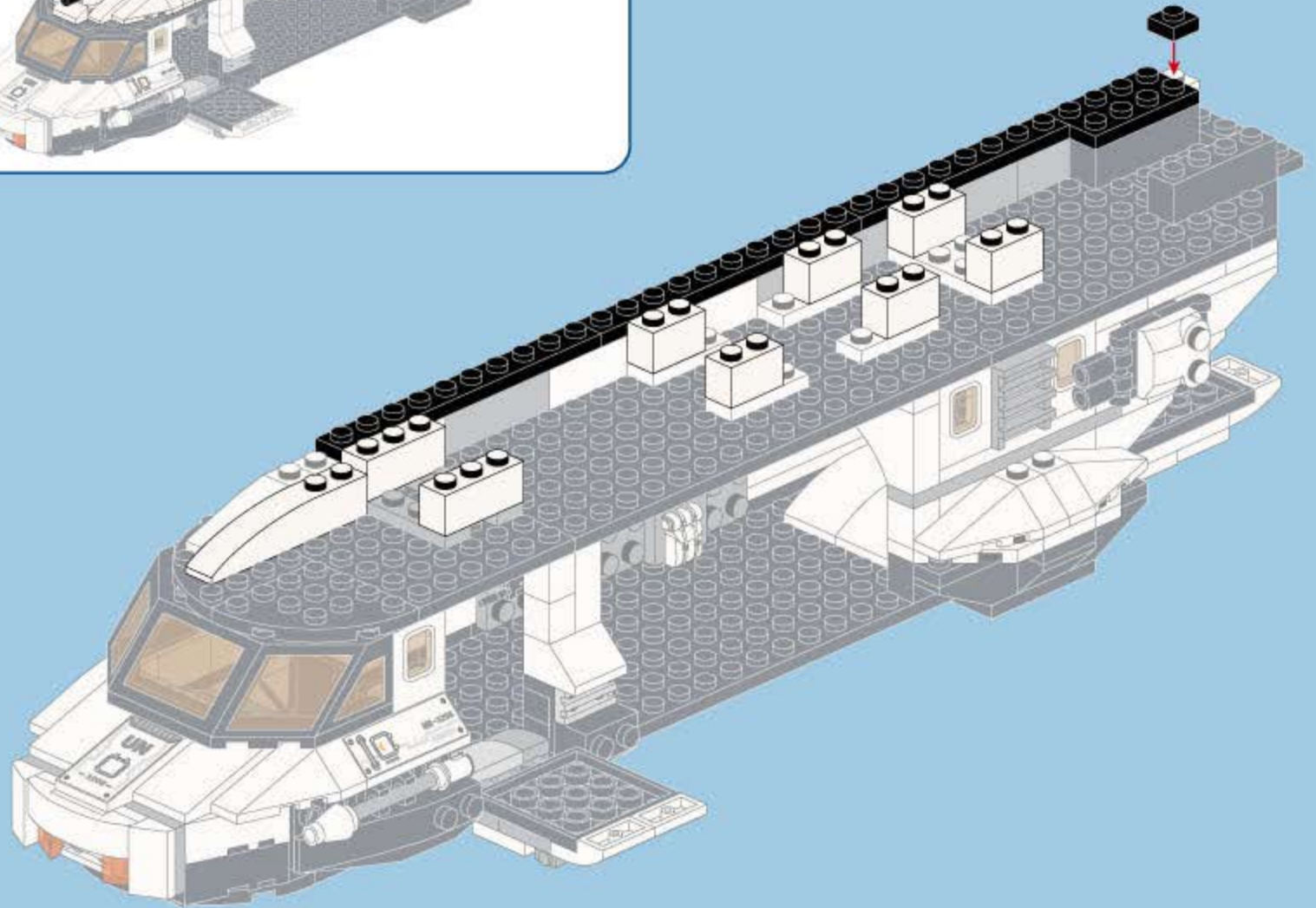

B34

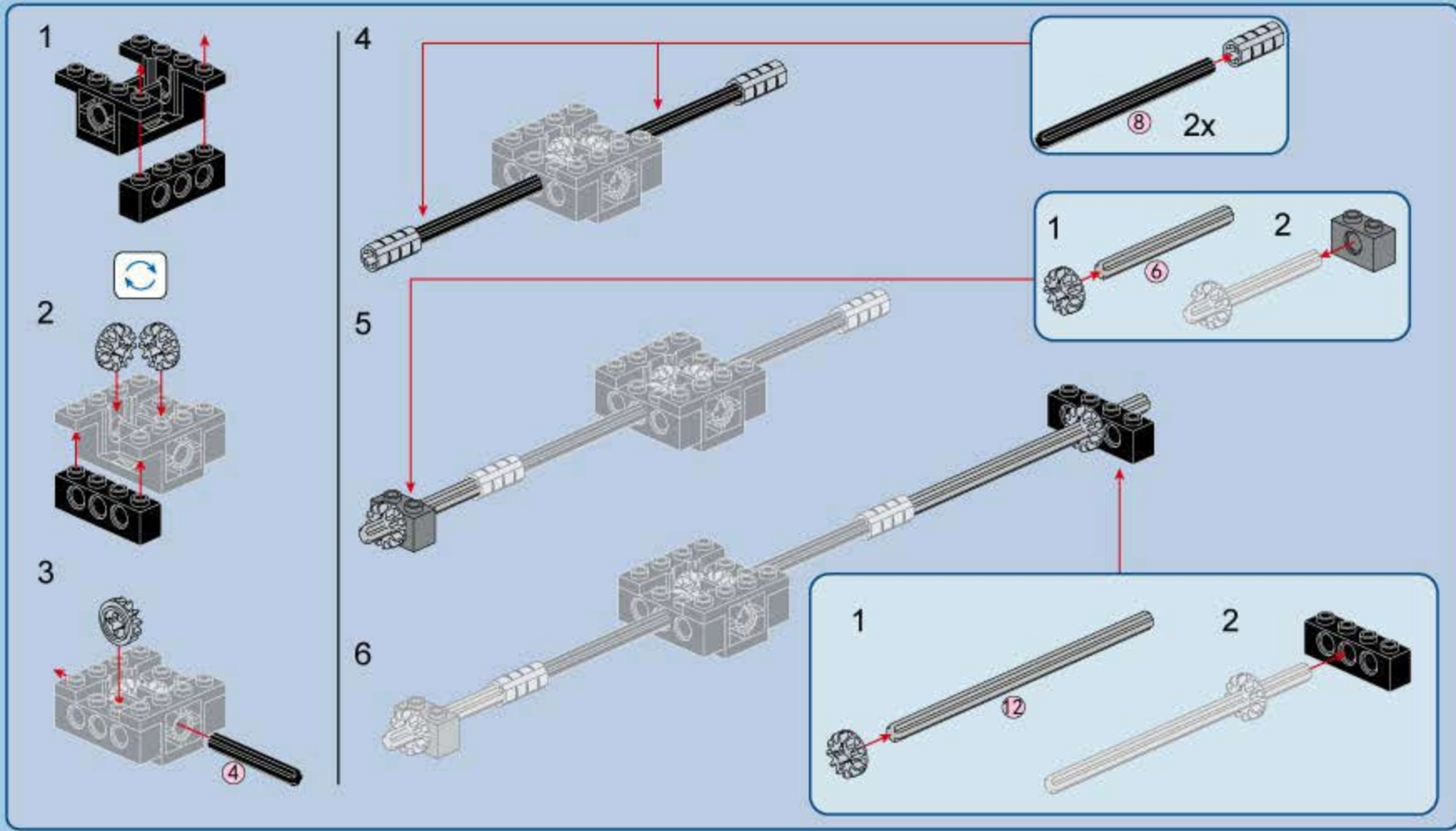
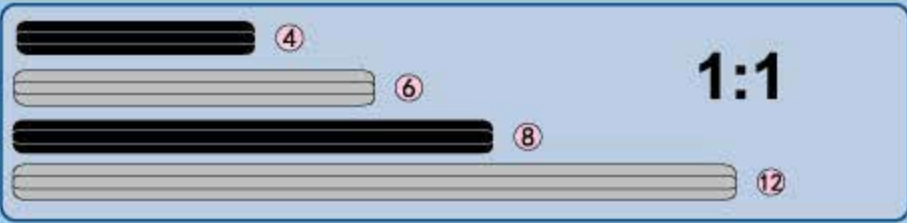
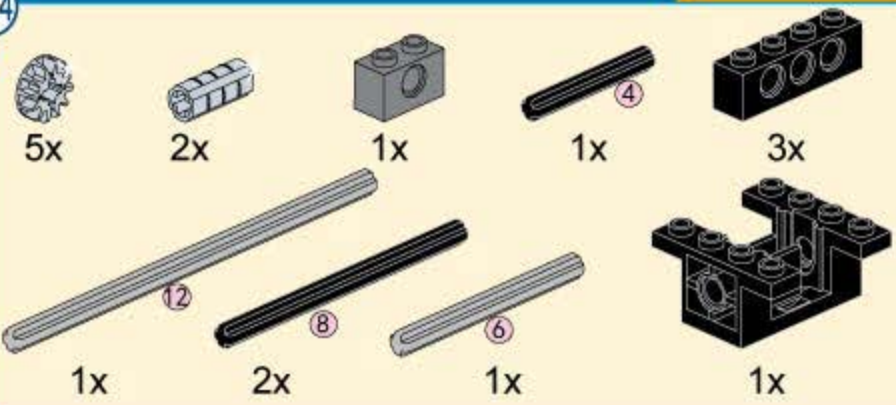



B35



2x



1x



B33

B34

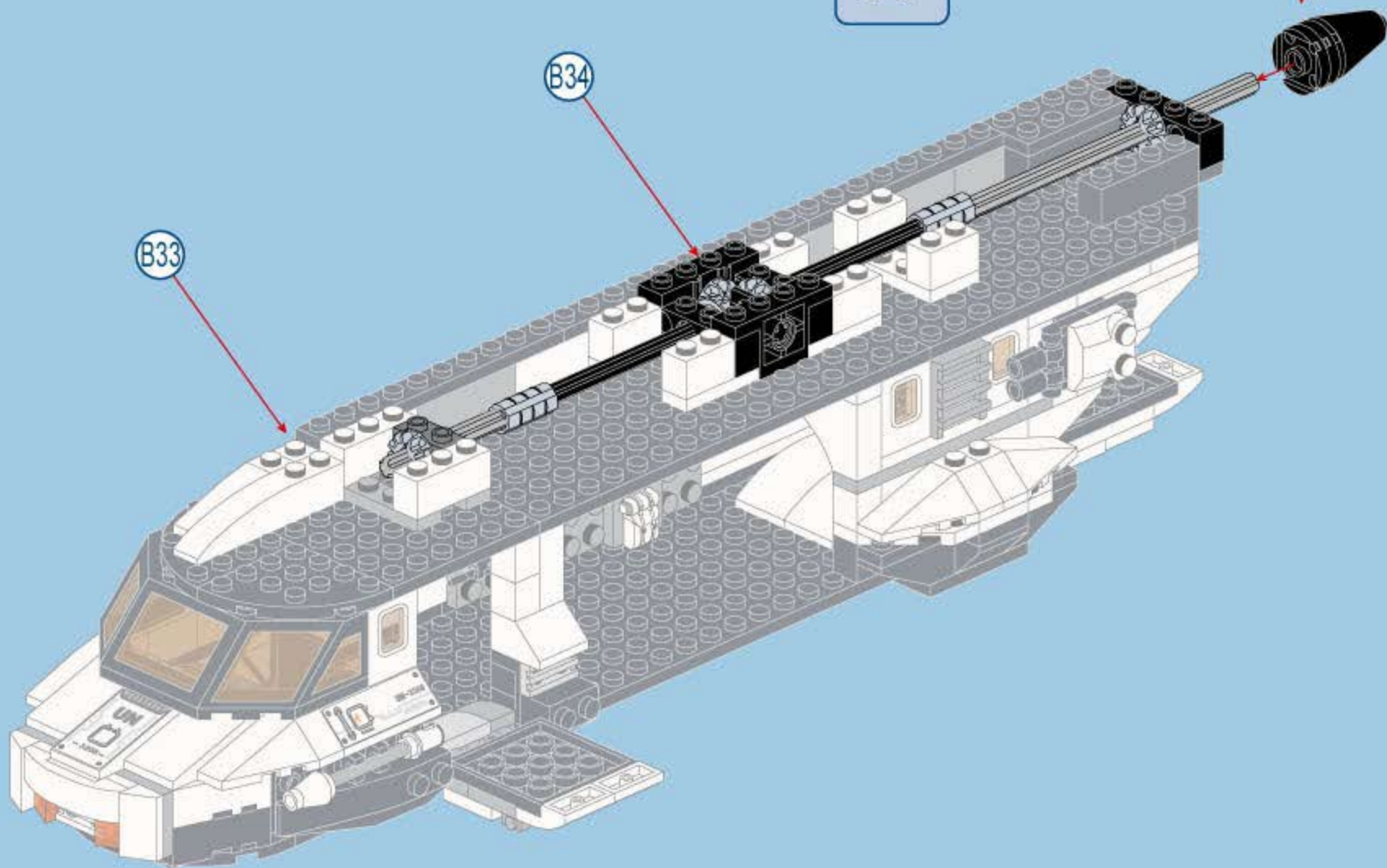

B36



1x

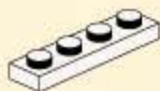

2x



1x



1x

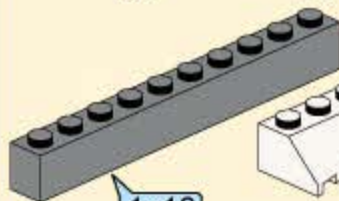

1x

1x10

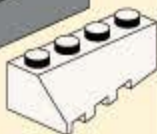

1x

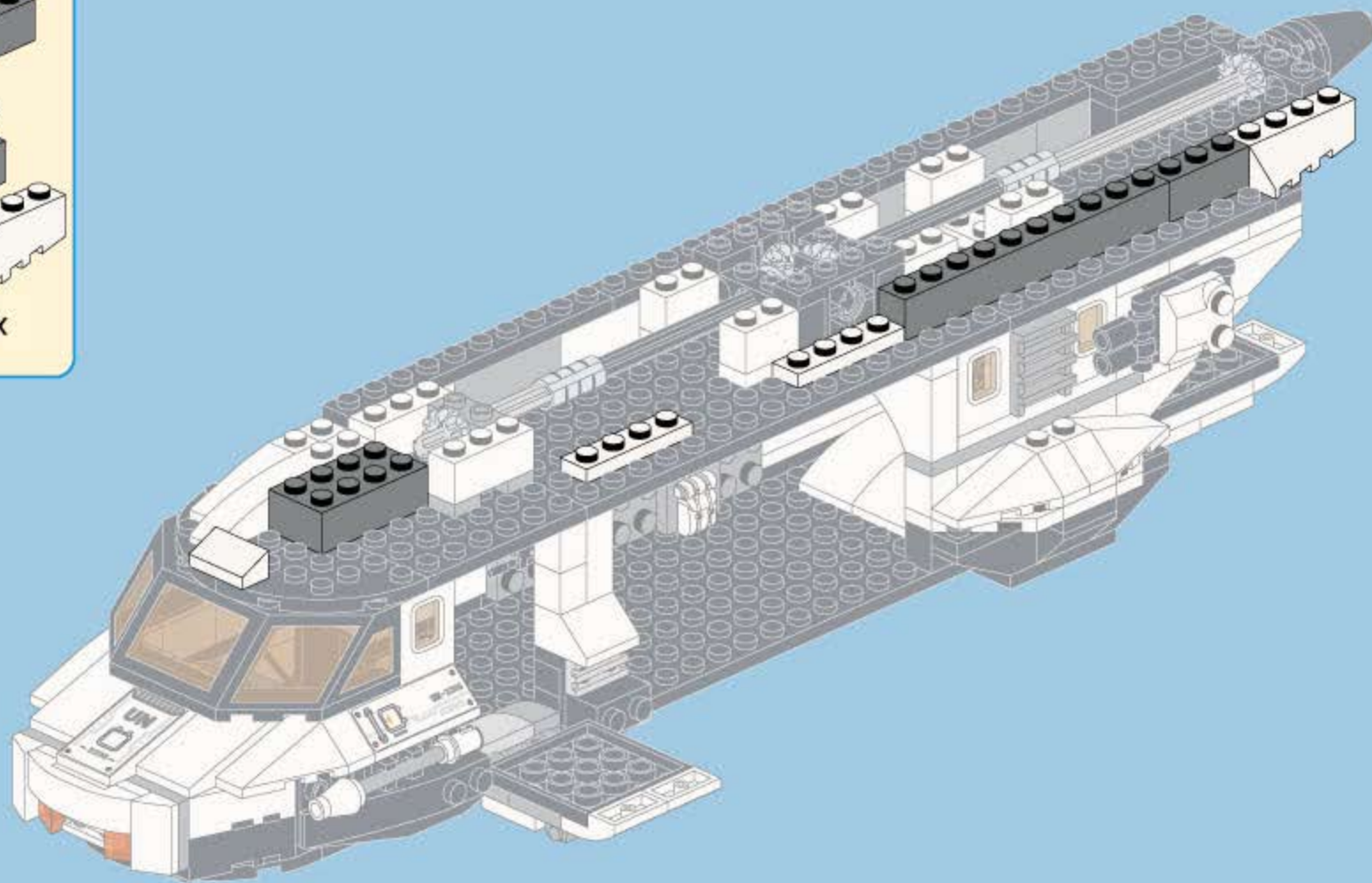



B37

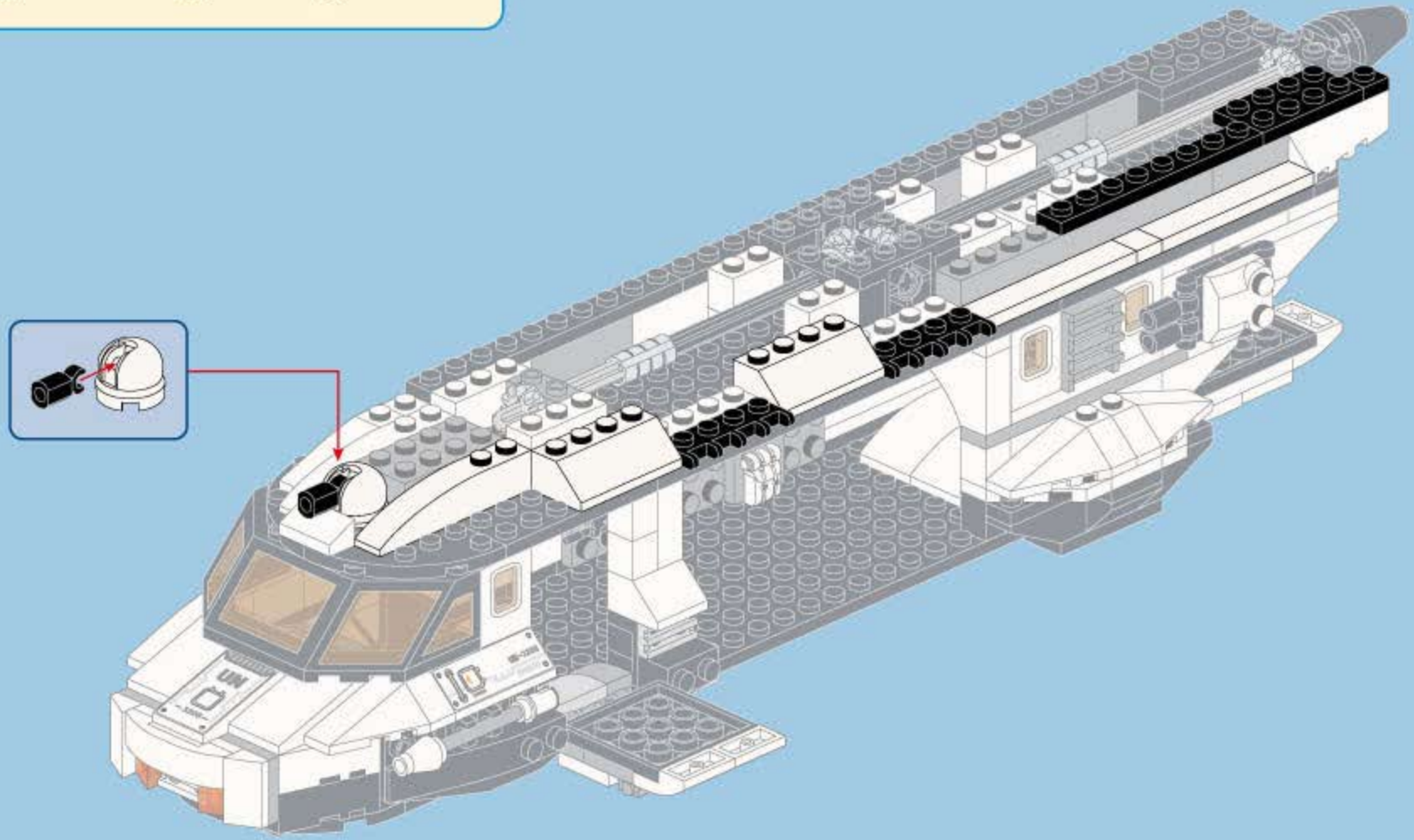
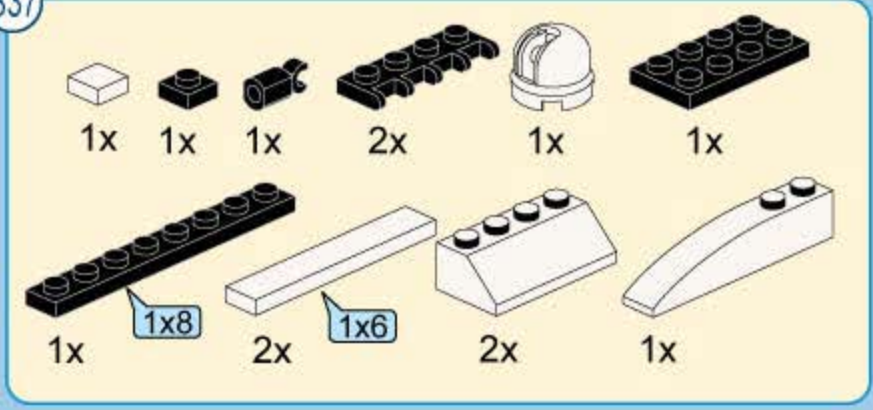

B38

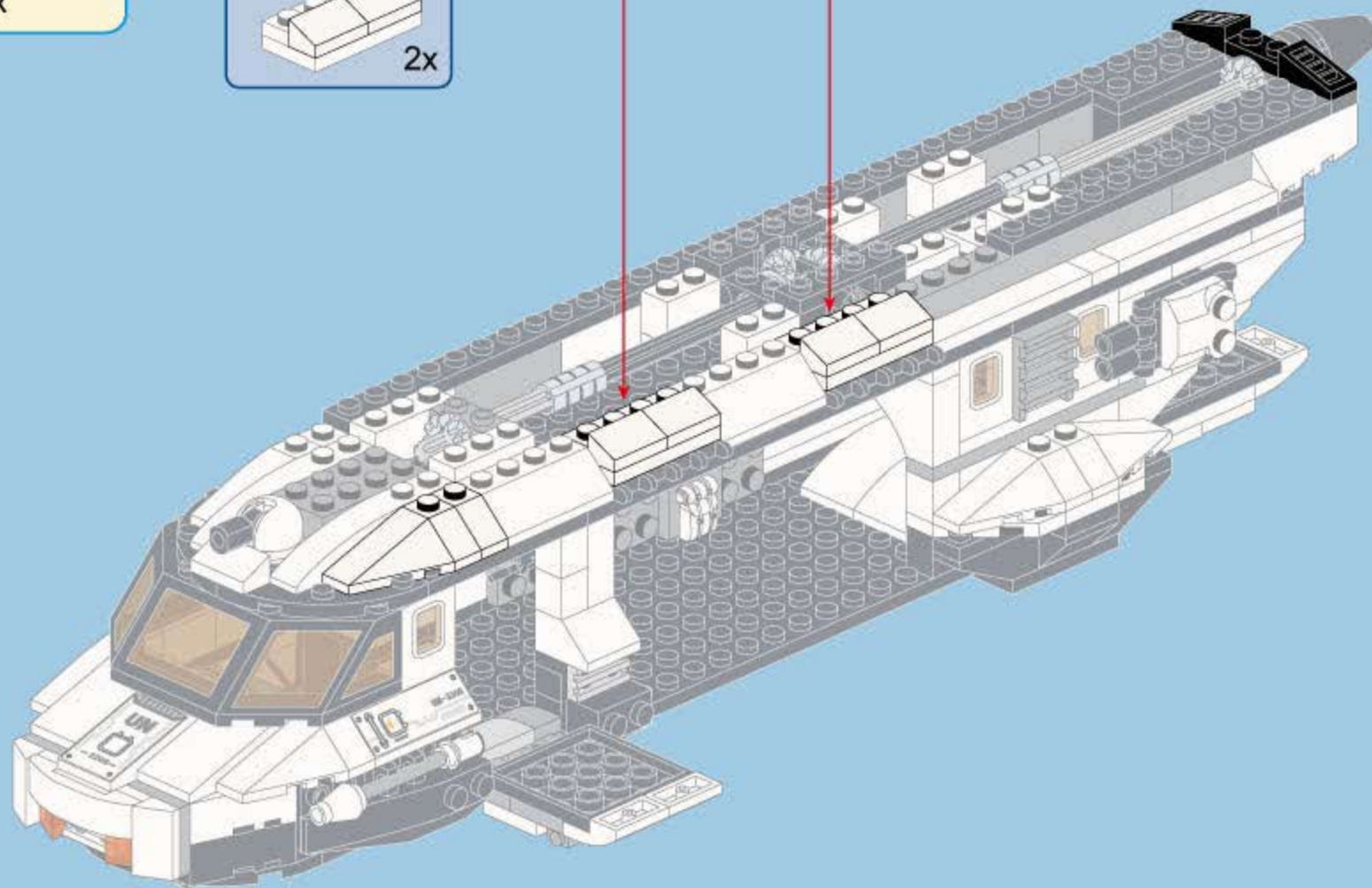
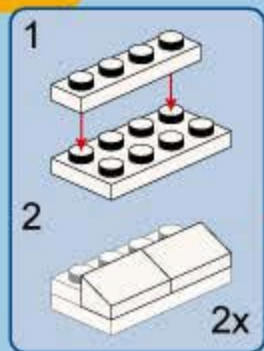
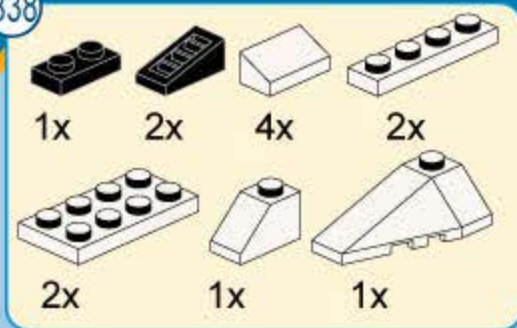



B39

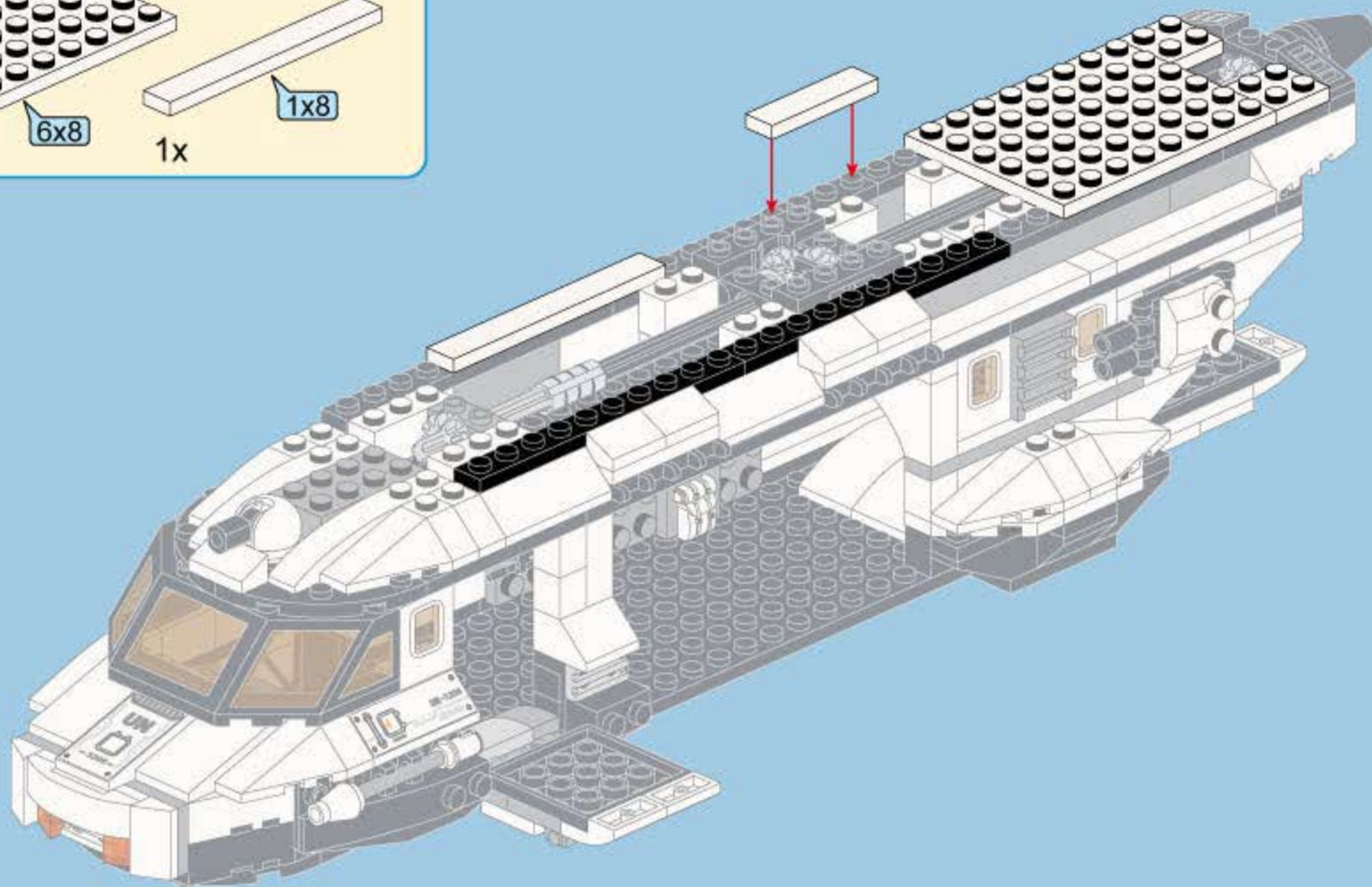
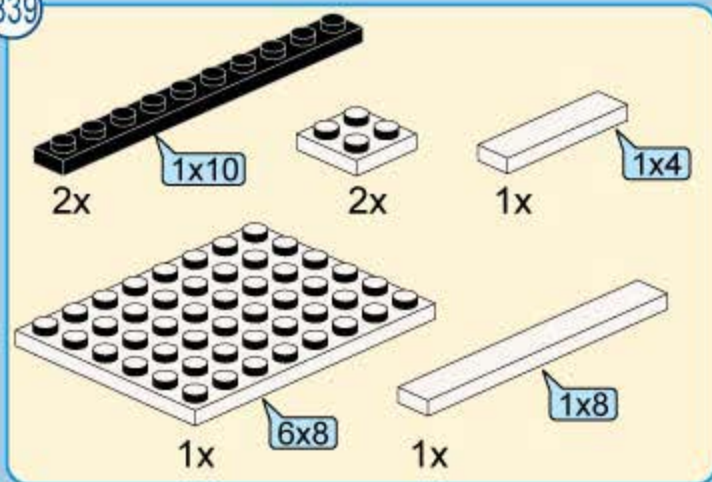

B40

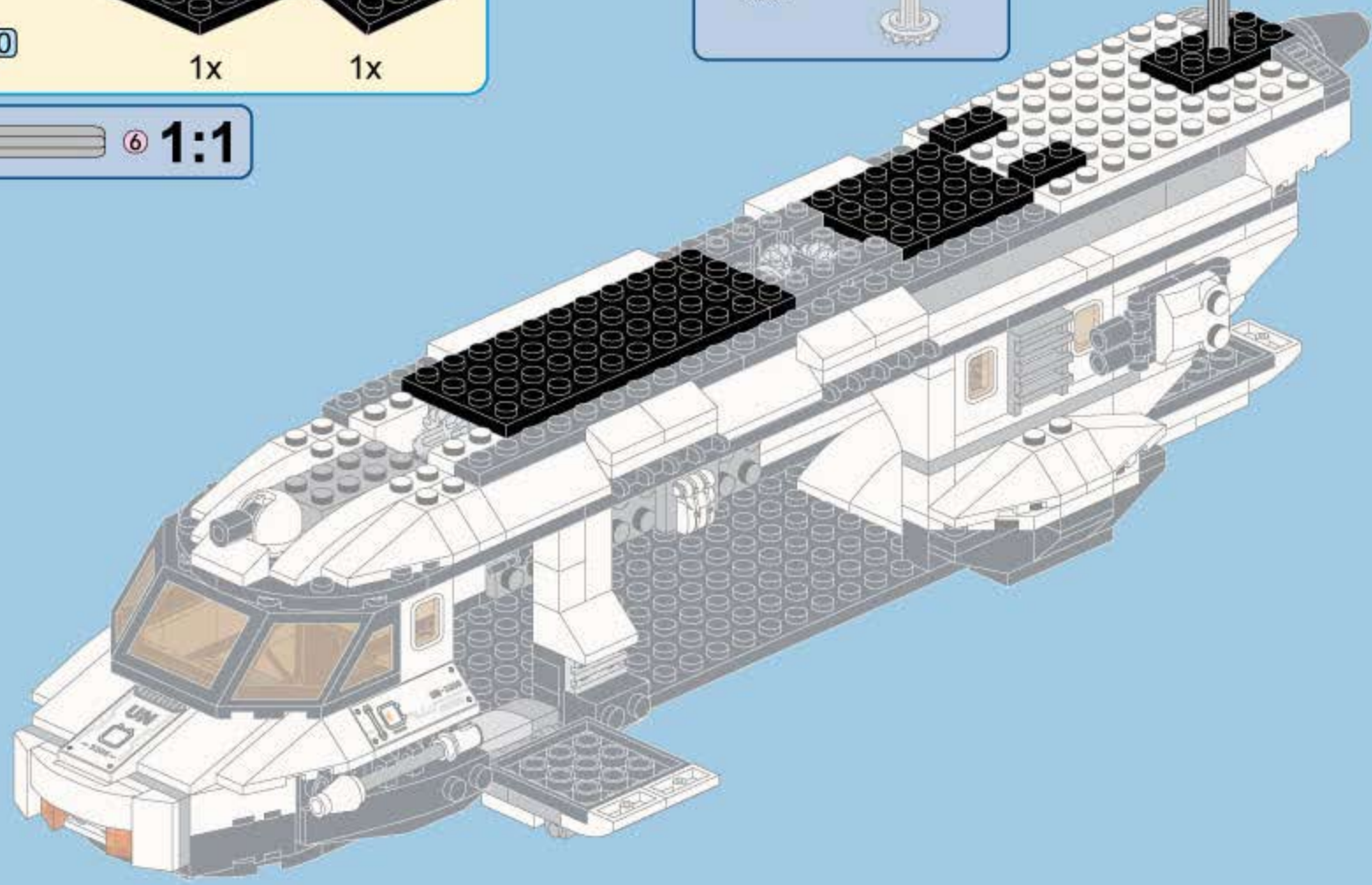
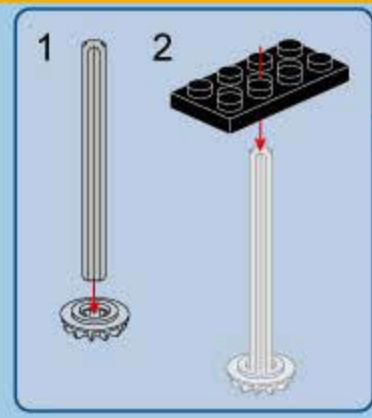
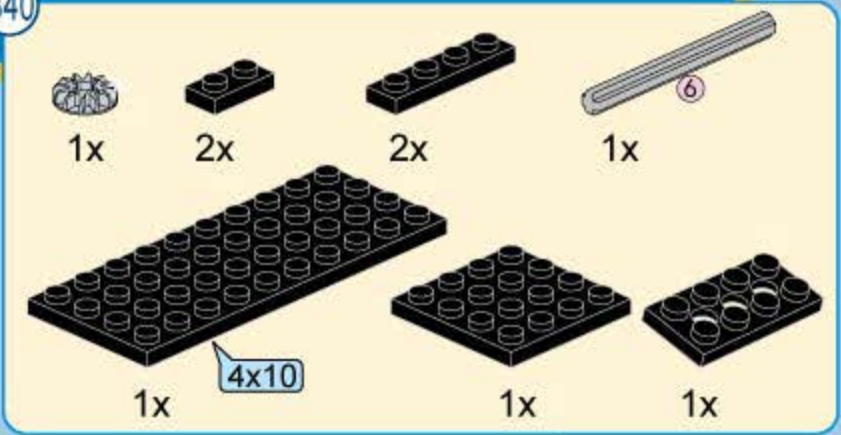



B41



1x



5x



1x



1x

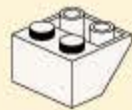

1x

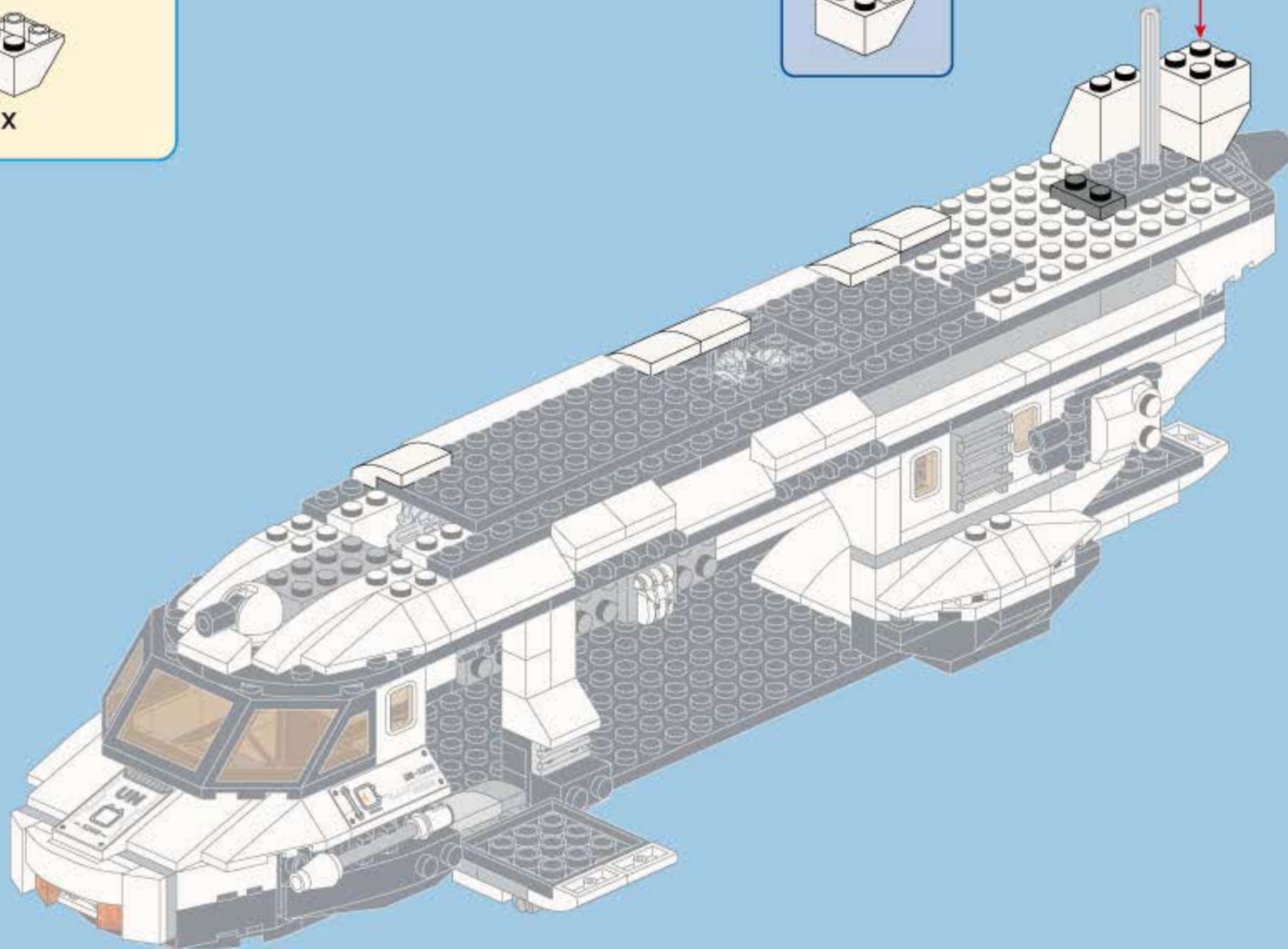
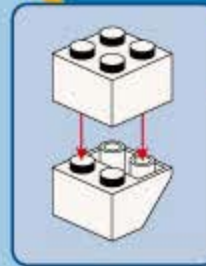

B42



2x



5x



1x

1x4



2x



1x

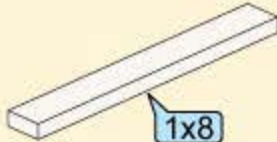

1x

1x8

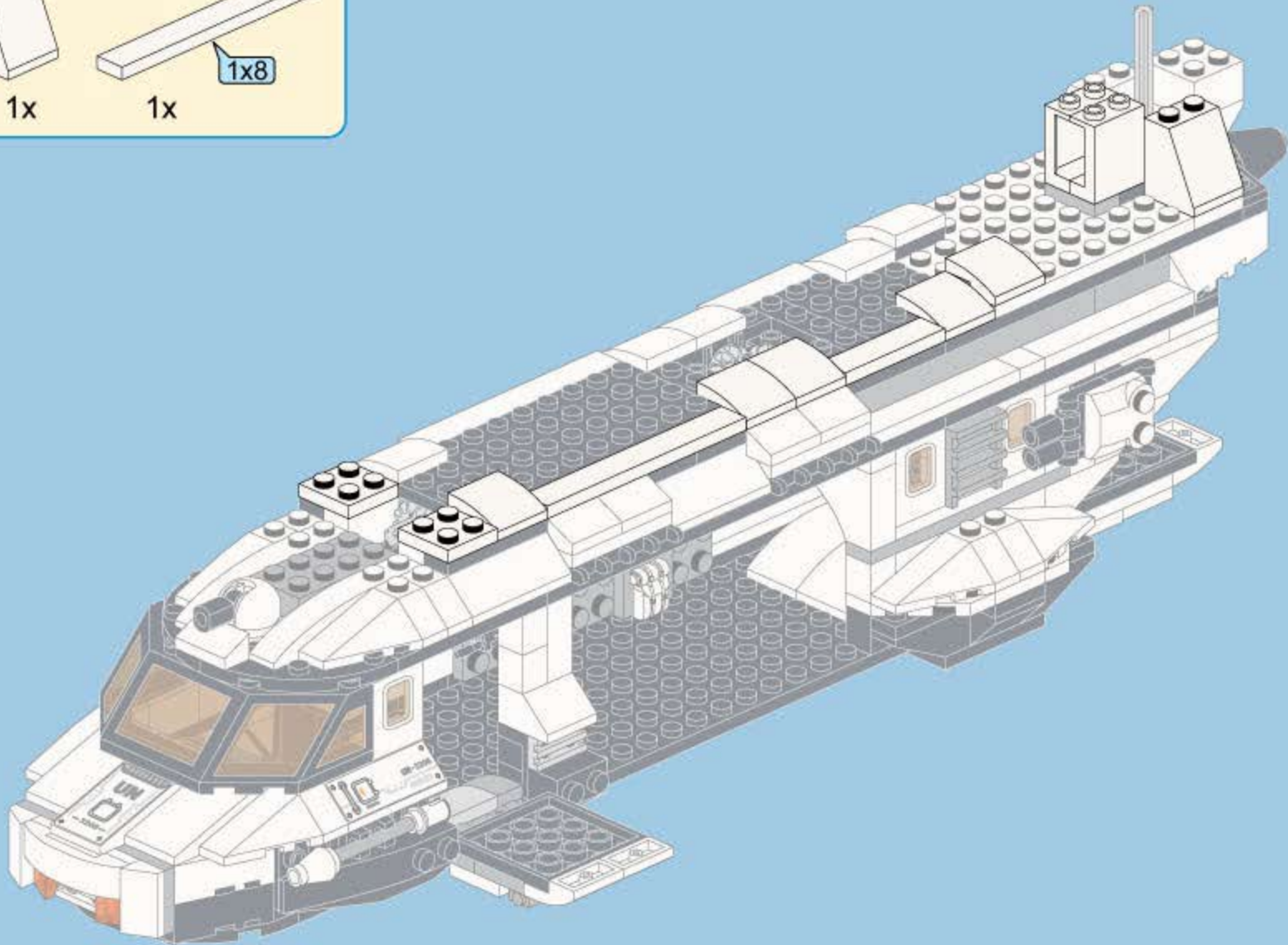





6



B43

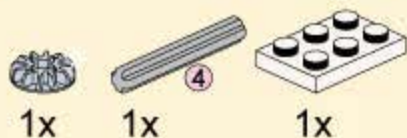

1x

1x

1x



1x

2x8

1x



2x

2x6

2x

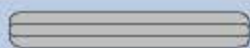

4

1:1

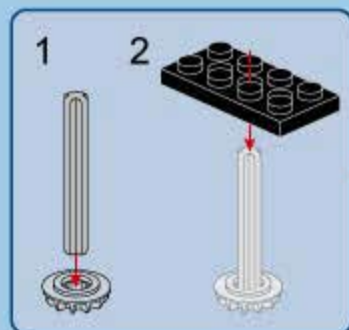





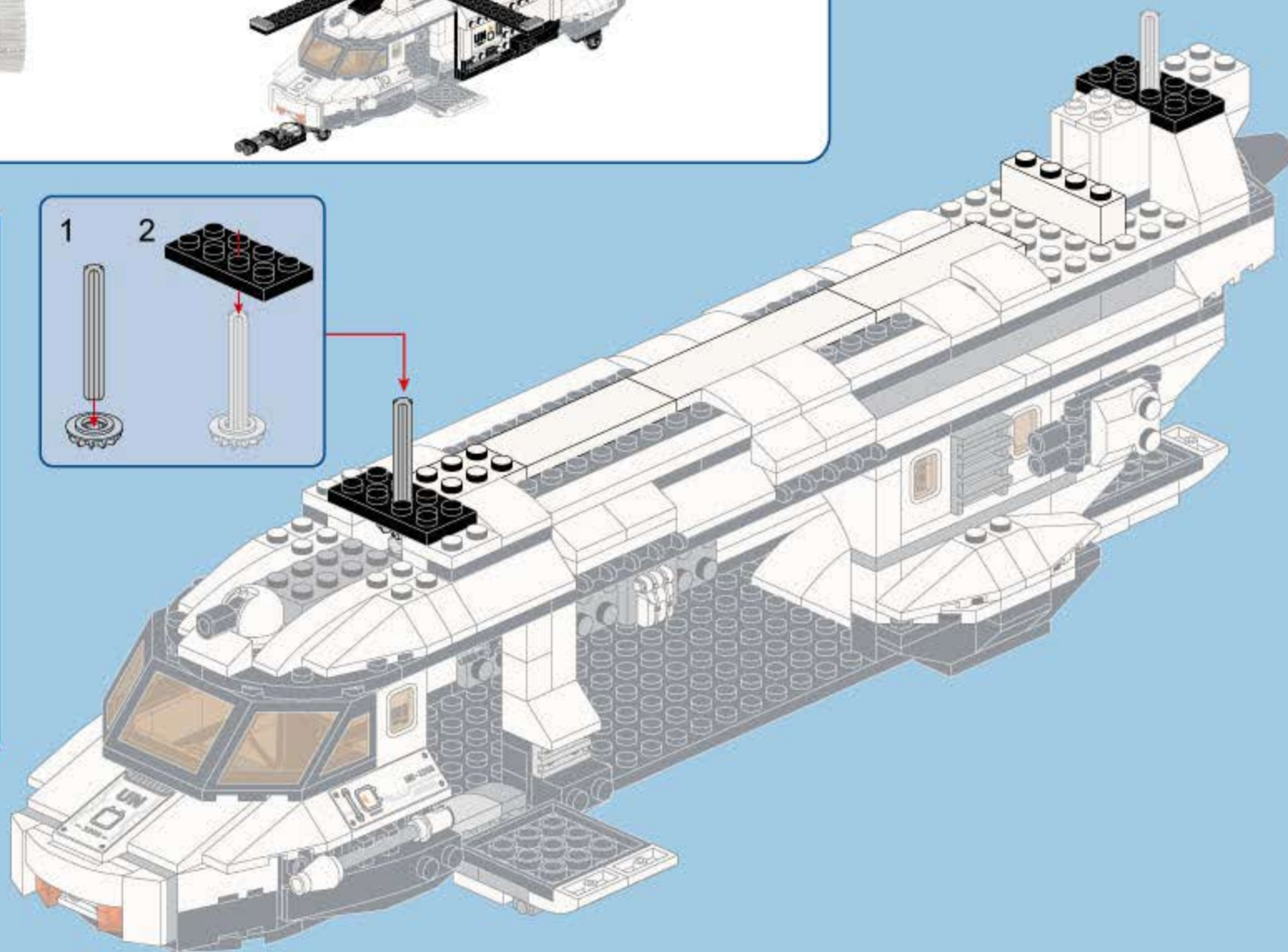

1

2



B44

- |   |   |
|---|---|
|  |  |
| 2x  | 2x  |
|  |  |
| 1x  | 1x  |
|  |  |
| 1x  | 2x  |

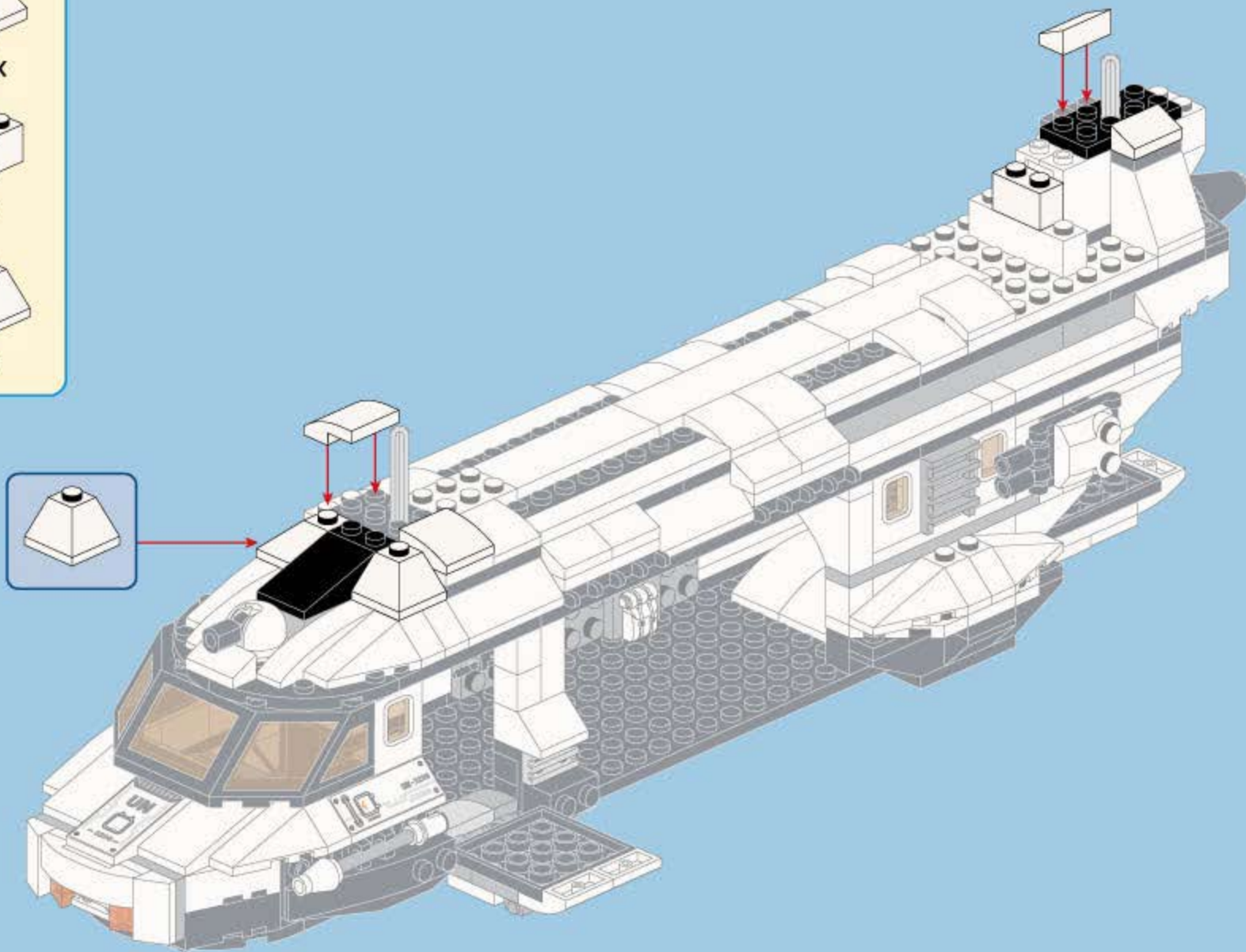



B45



1x



1x

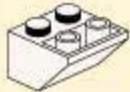

1x



1x



1x

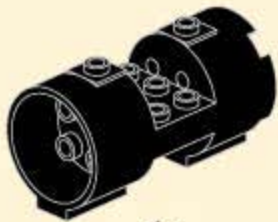

1x

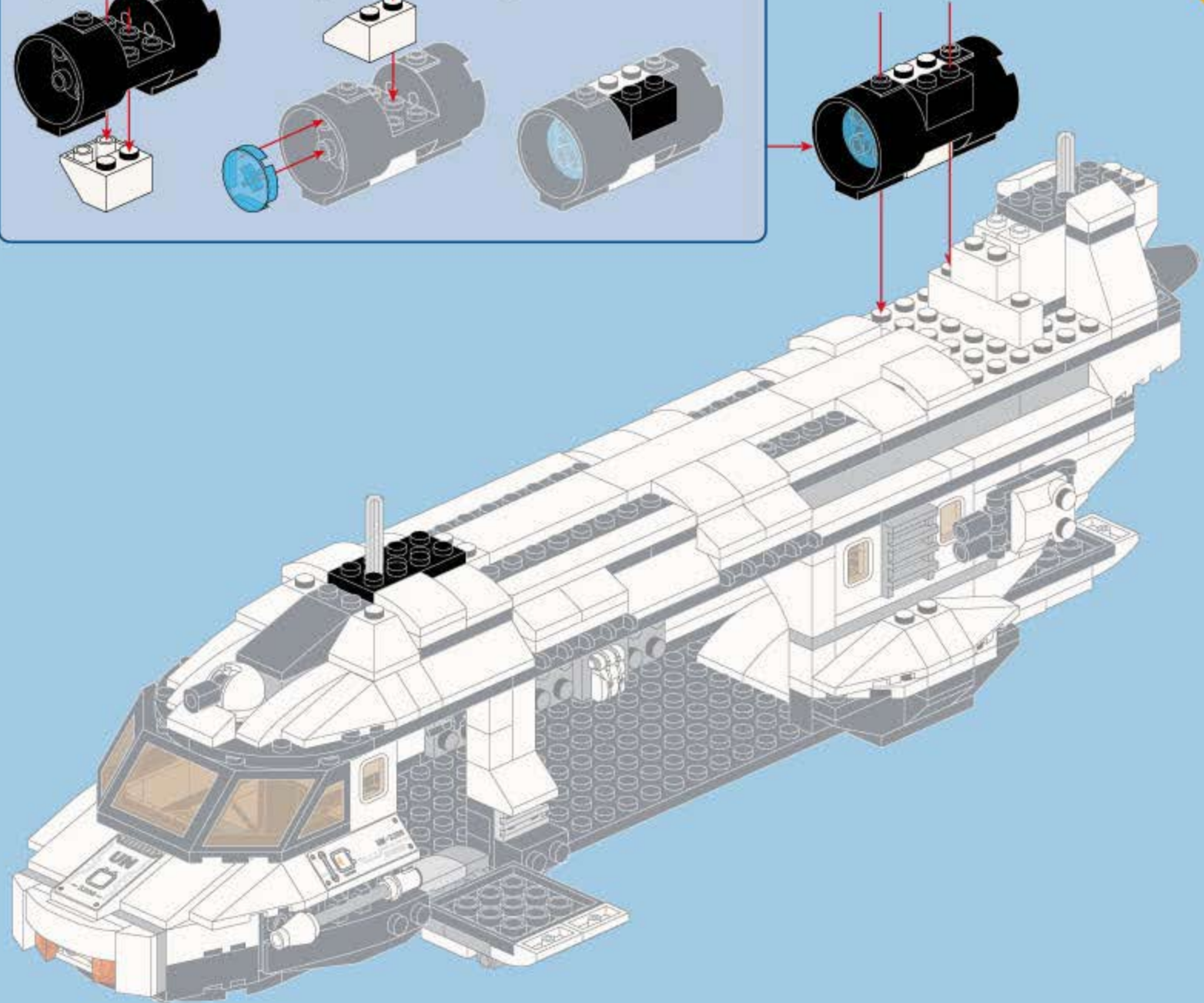
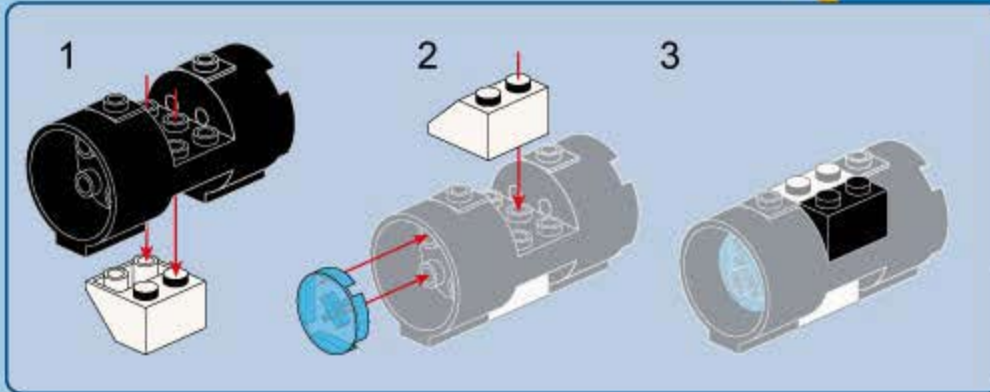

B46

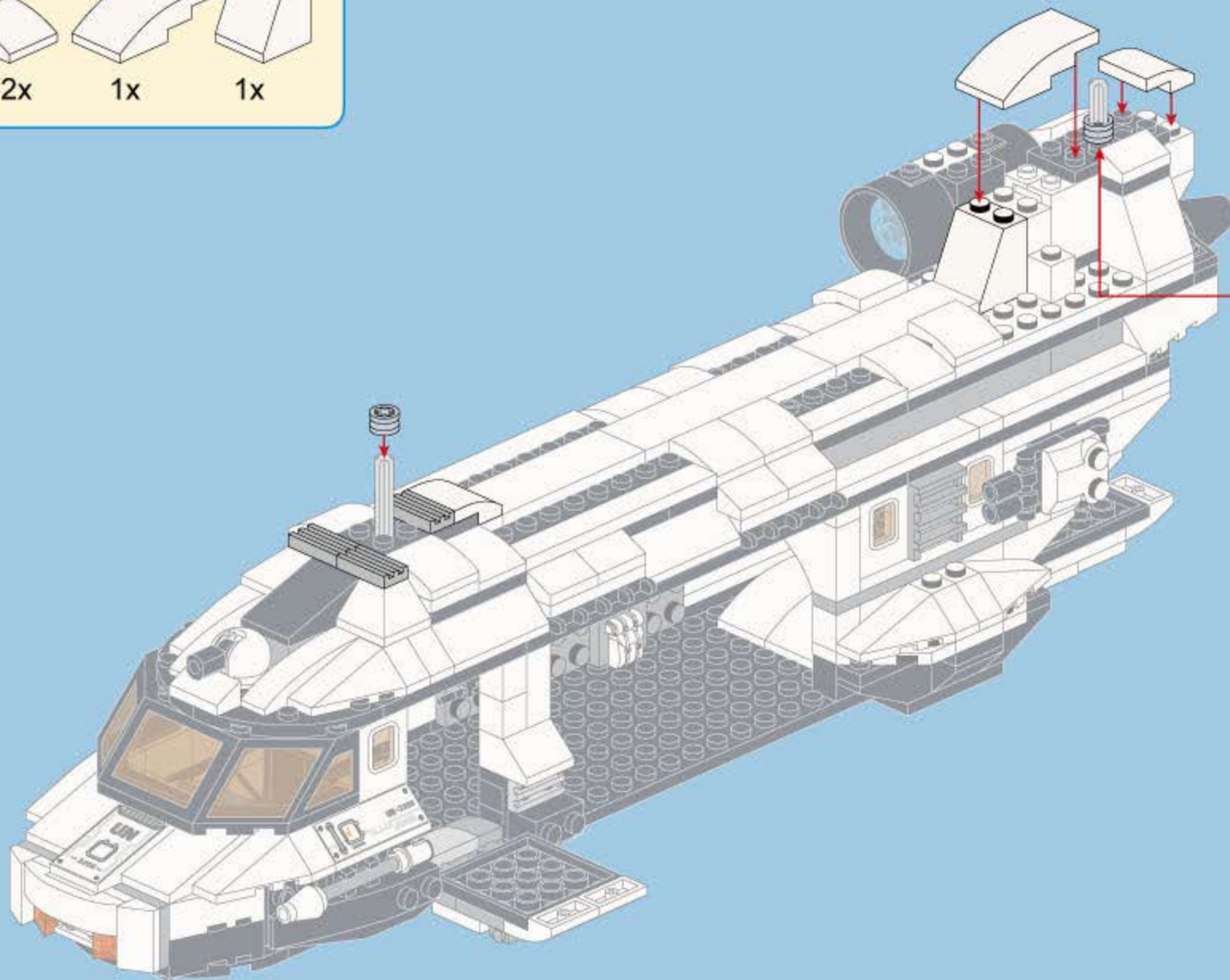
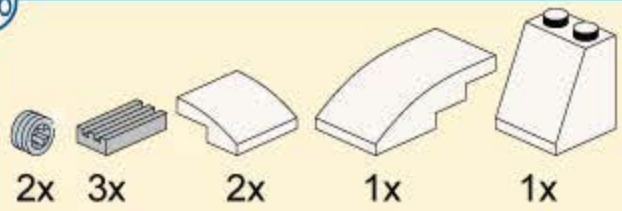



B47



1x



1x



1x



1x



1x

1

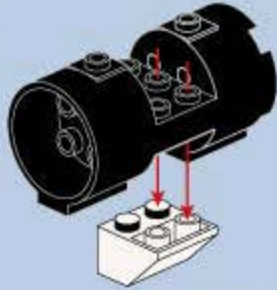

2

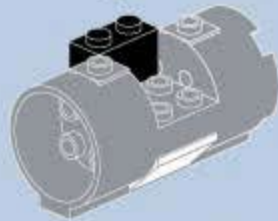

3

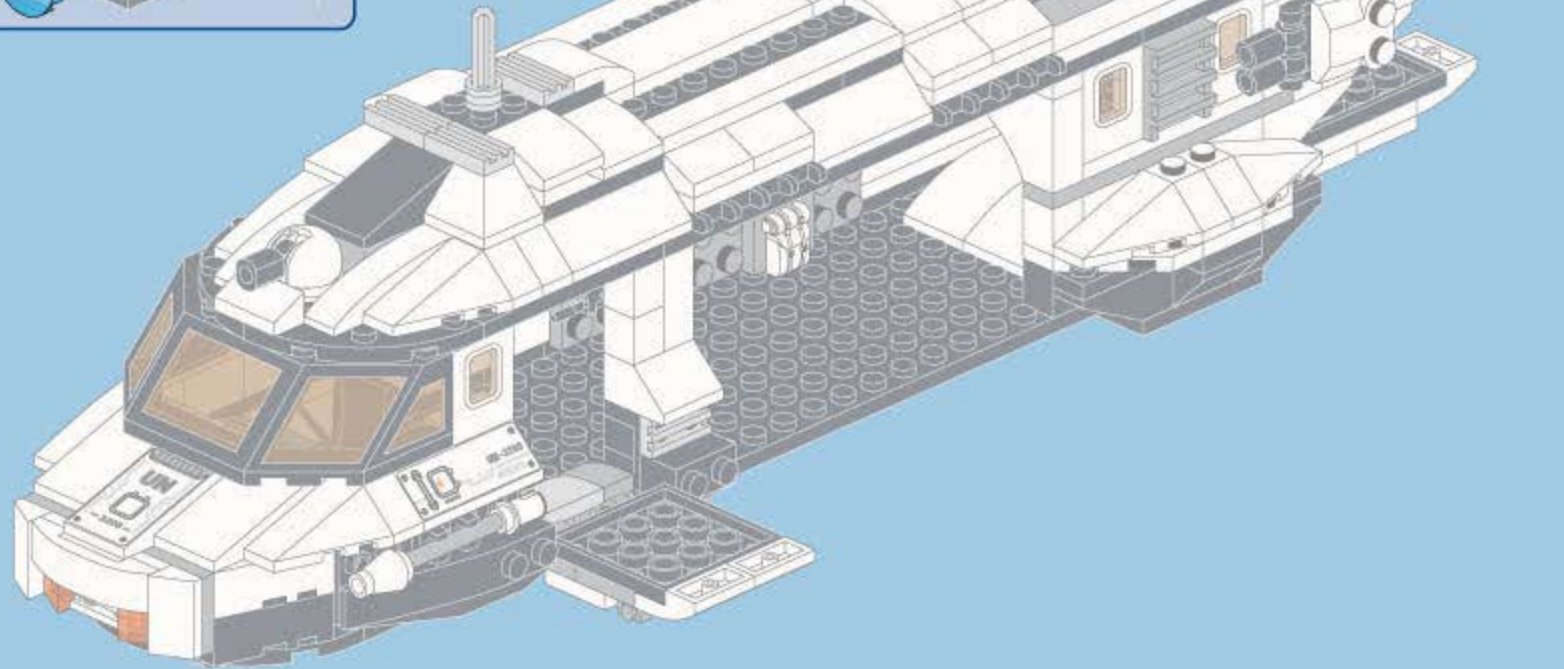
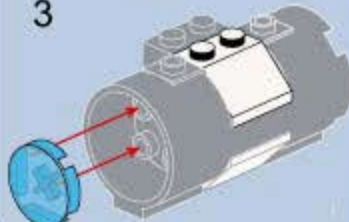

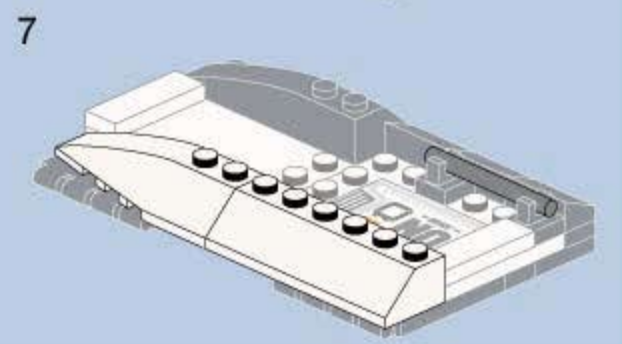
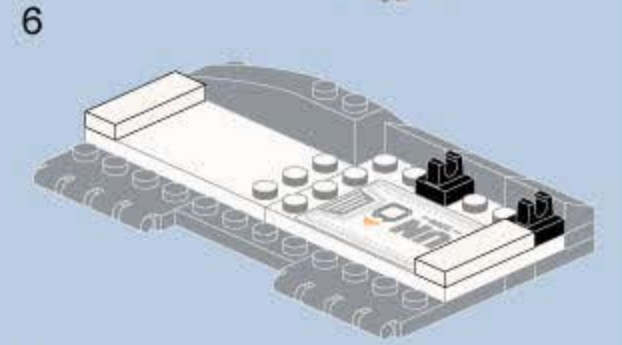
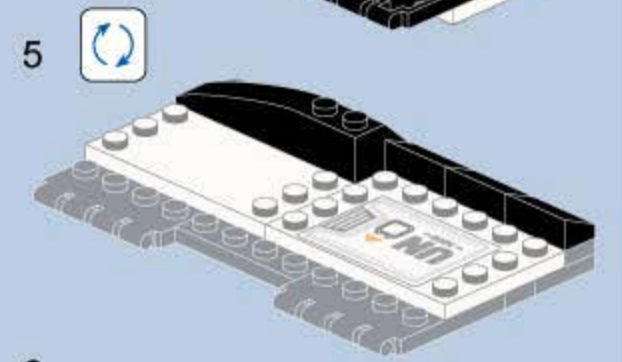
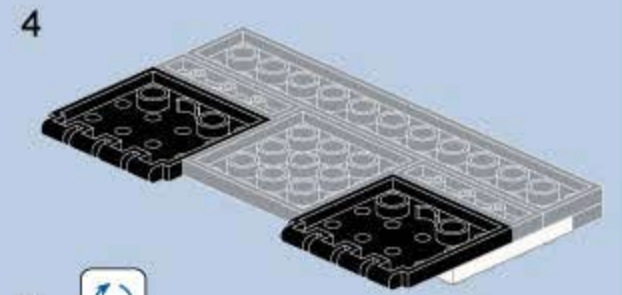
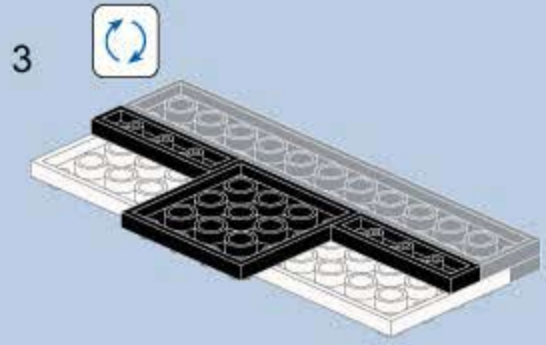
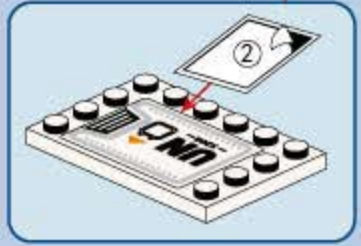
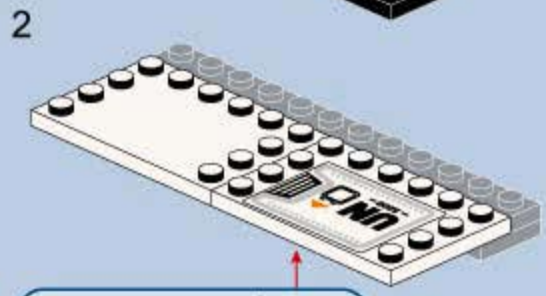
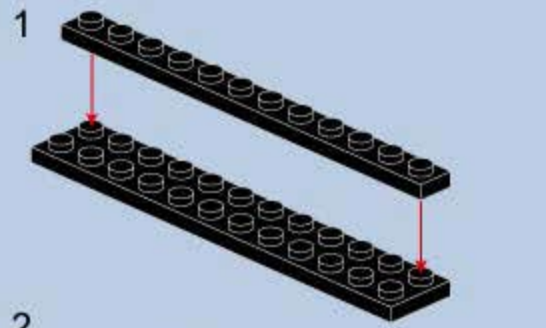
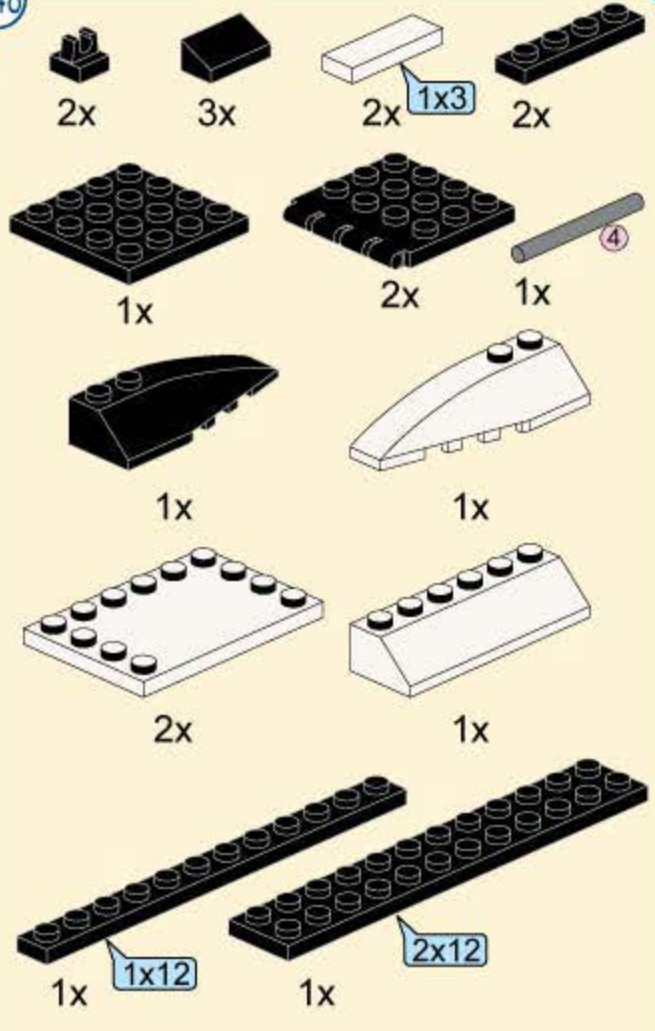





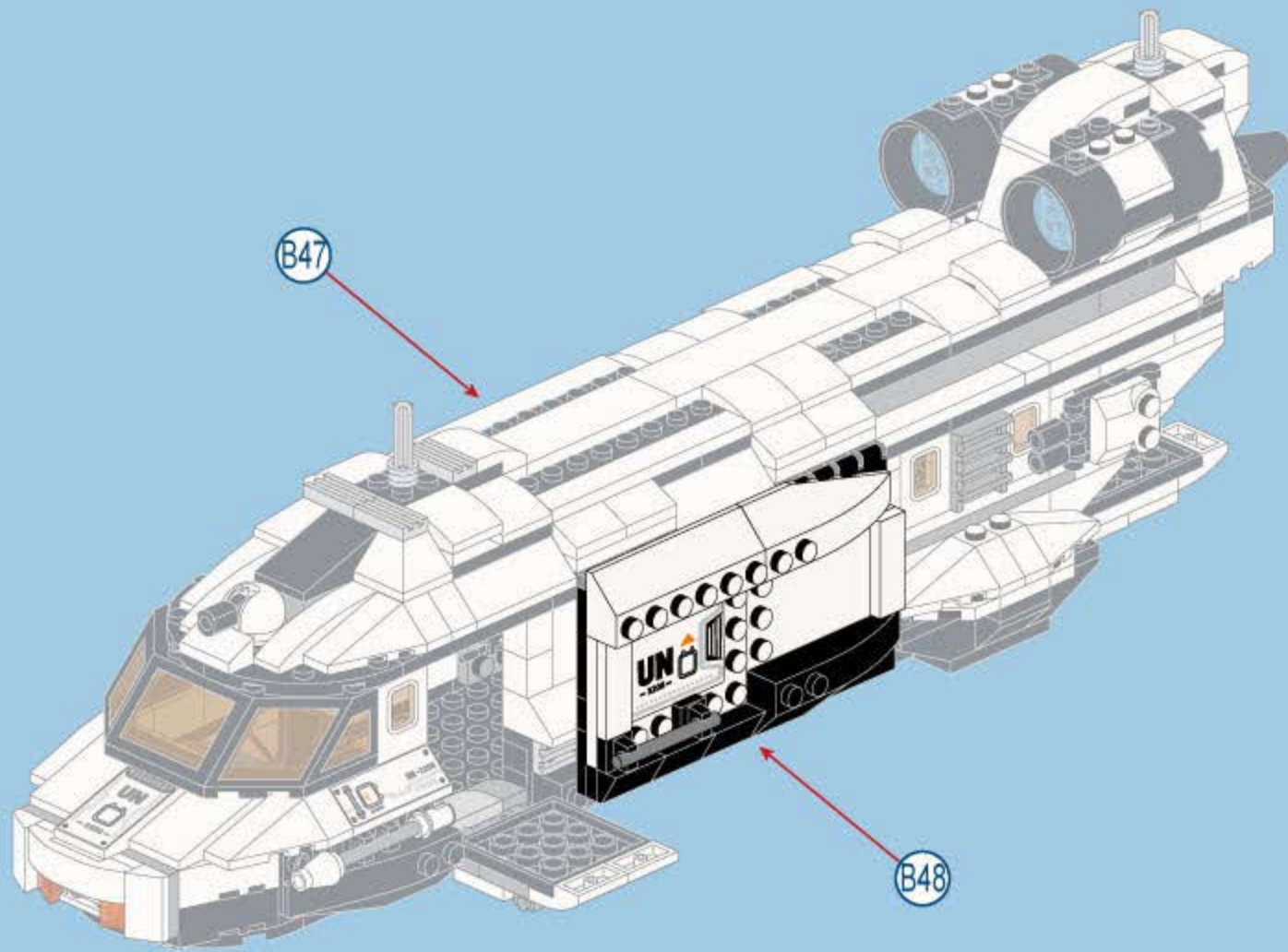







B49



B50

- |   |   |
|---|---|
| <br>1x | <br>2x |
| <br>1x | <br>1x |
| <br>2x | <br>1x |
| <br>1x | <br>1x |
| <br>1x | <br>2x |
| <br>1x | <br>1x |

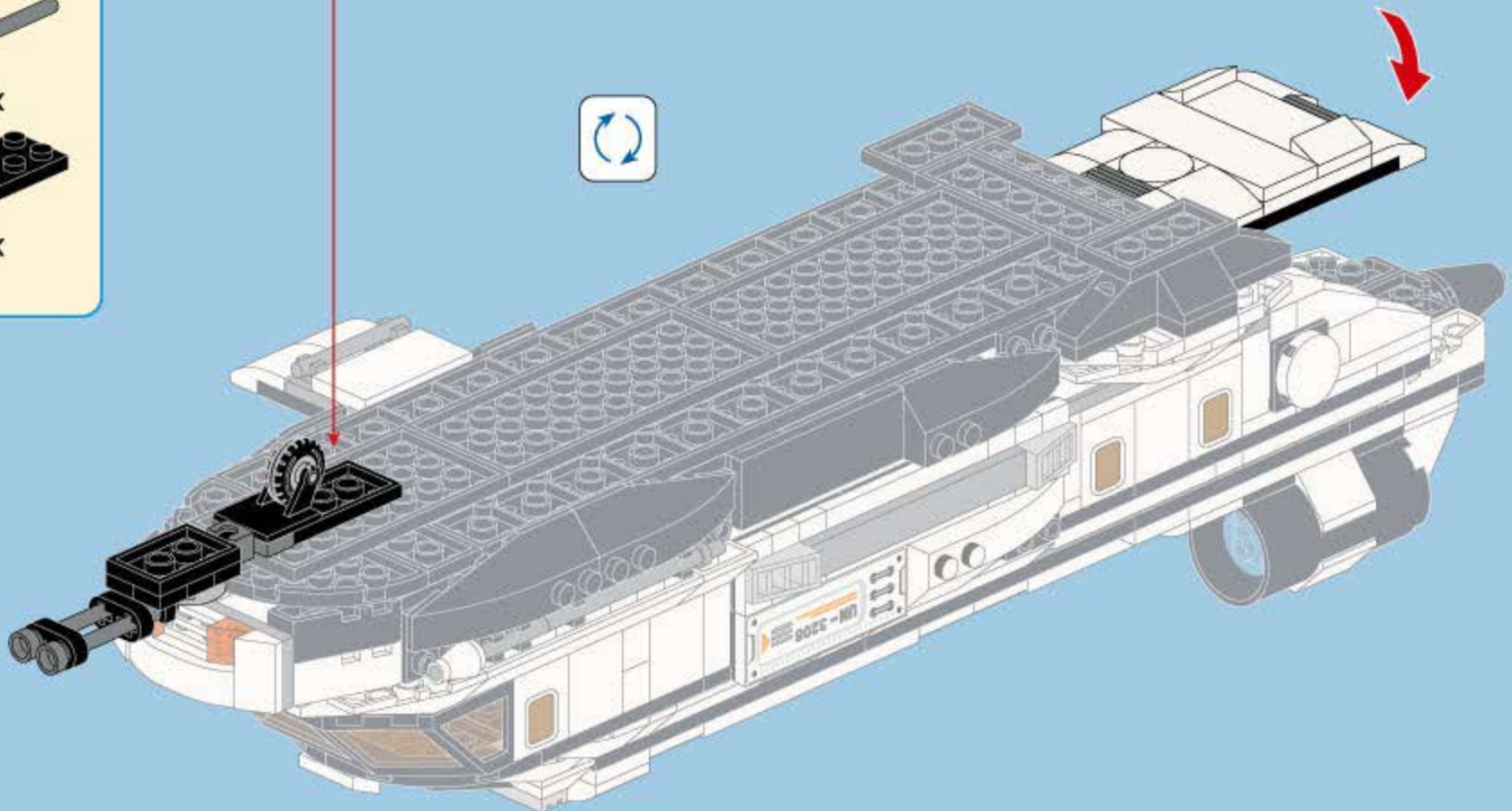
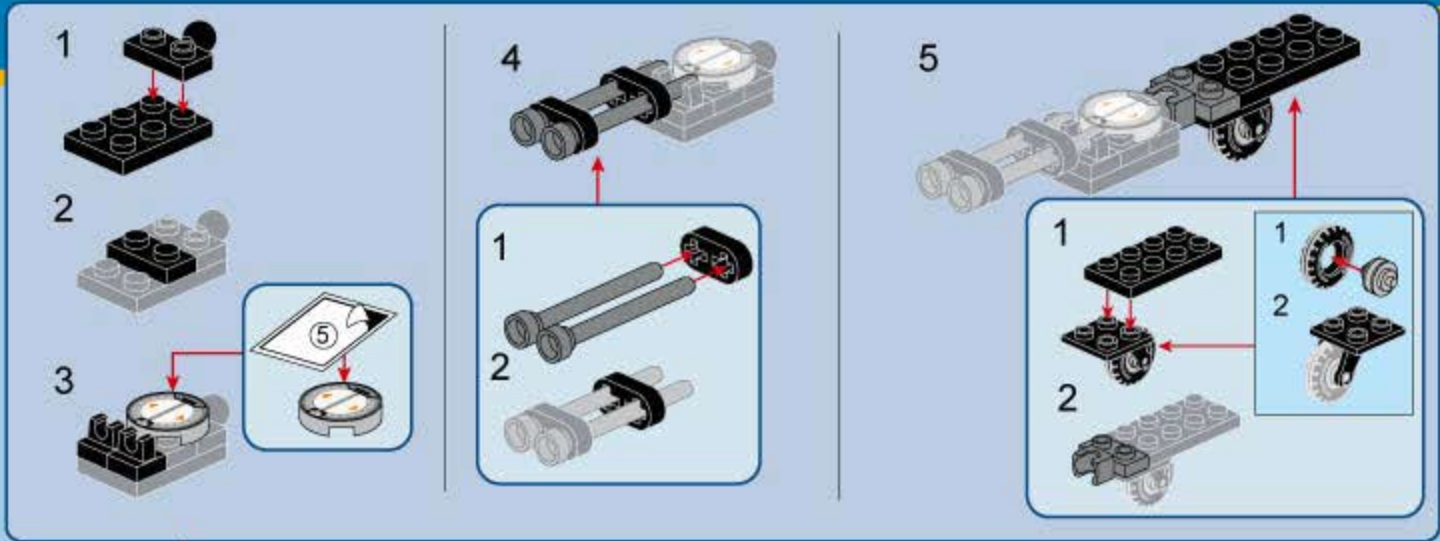



B51



4x



4x

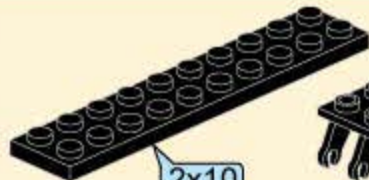

1x

2x10



4x

1



2

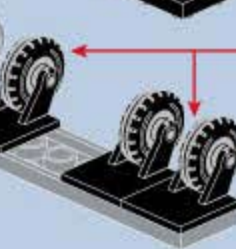

1



2



1



2



3x

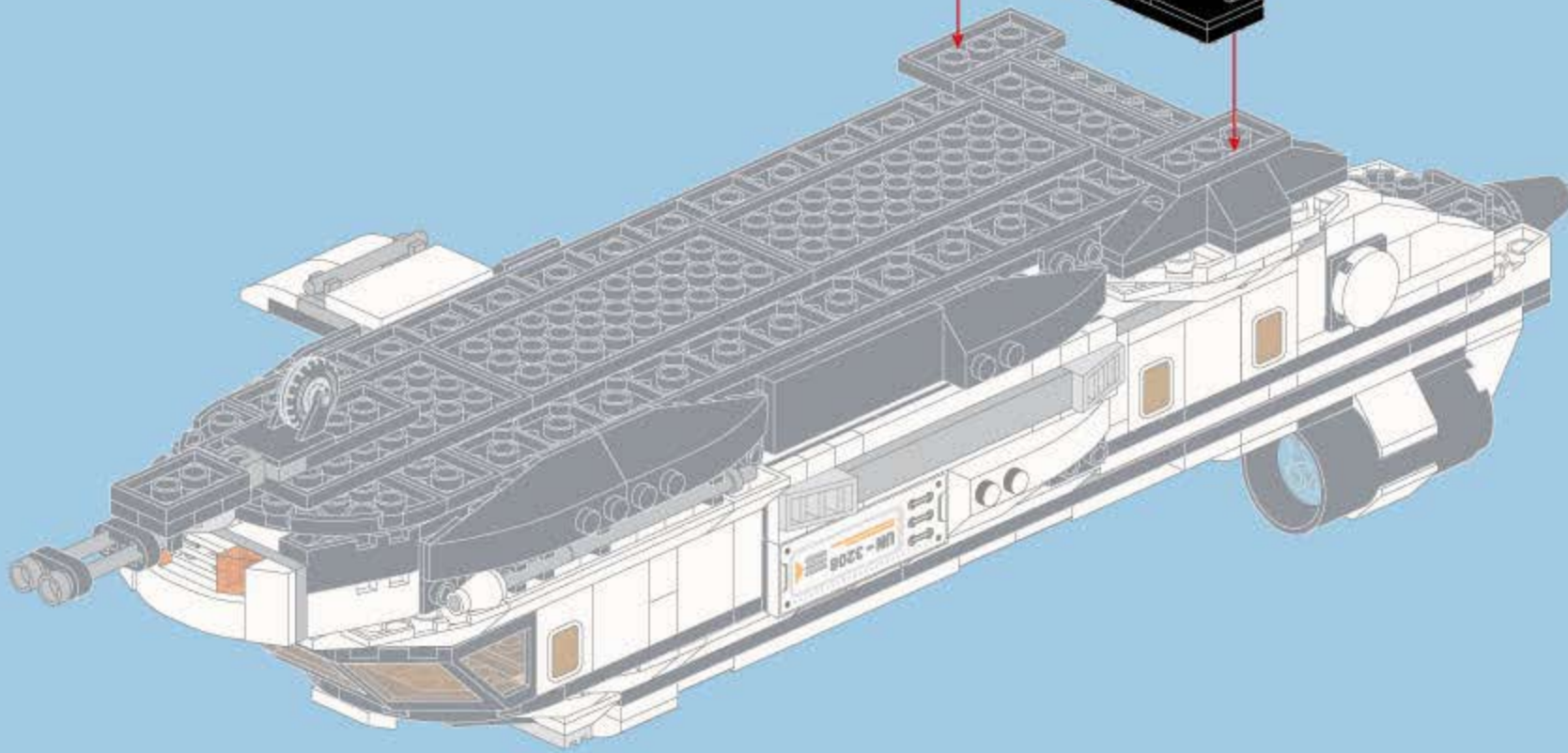

B52

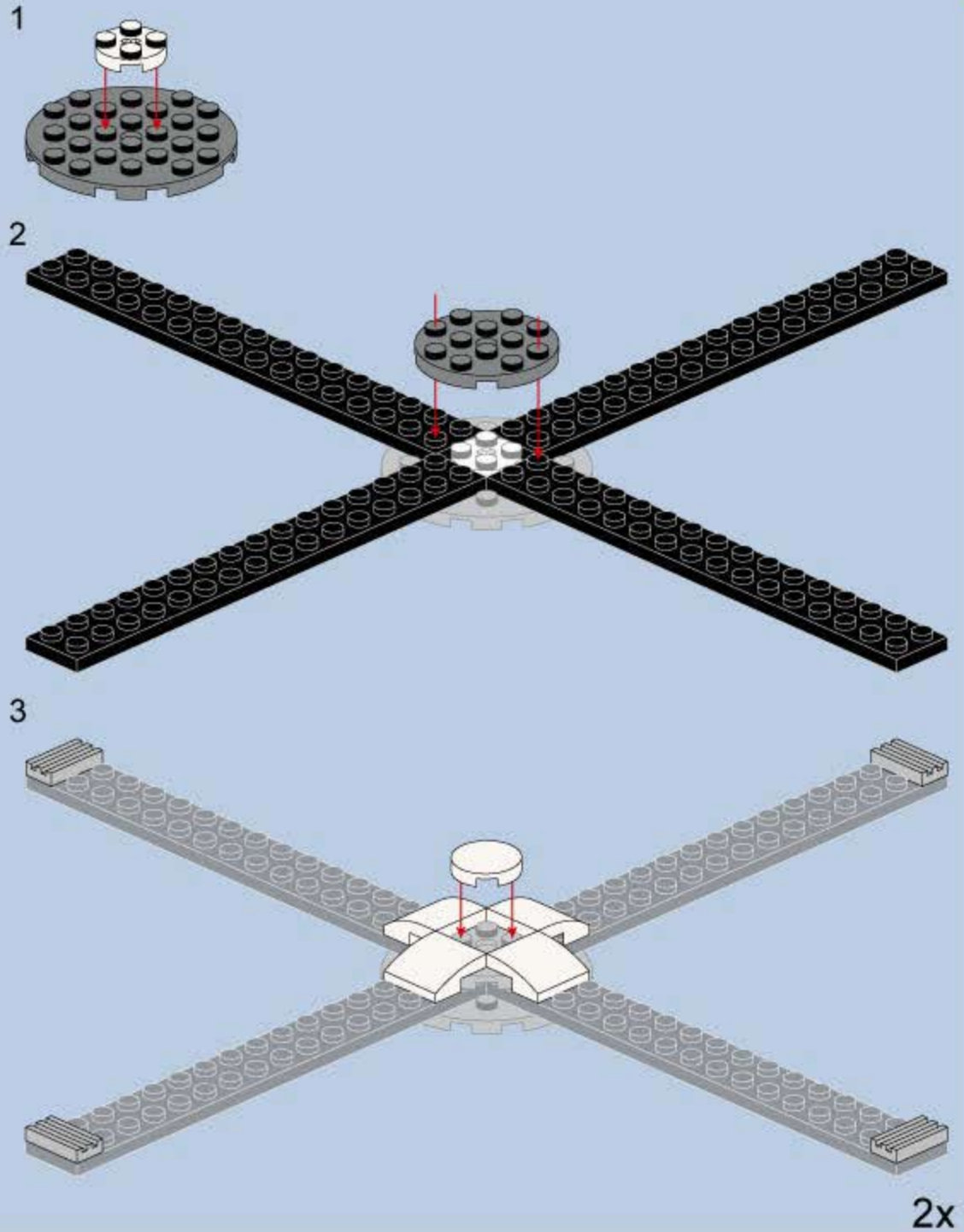
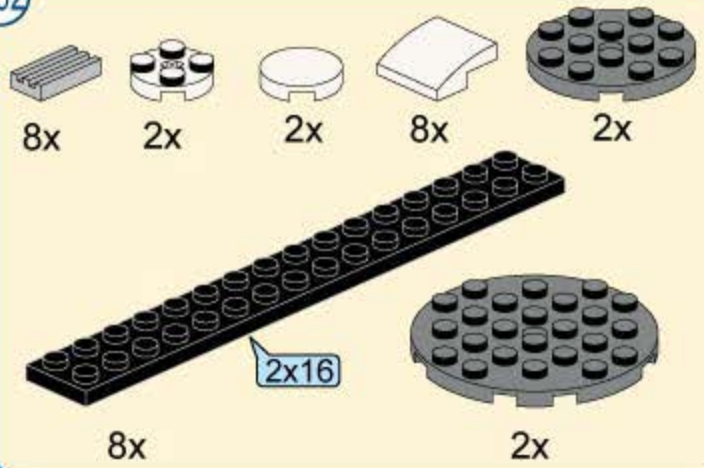



B53



B52

B52

B51

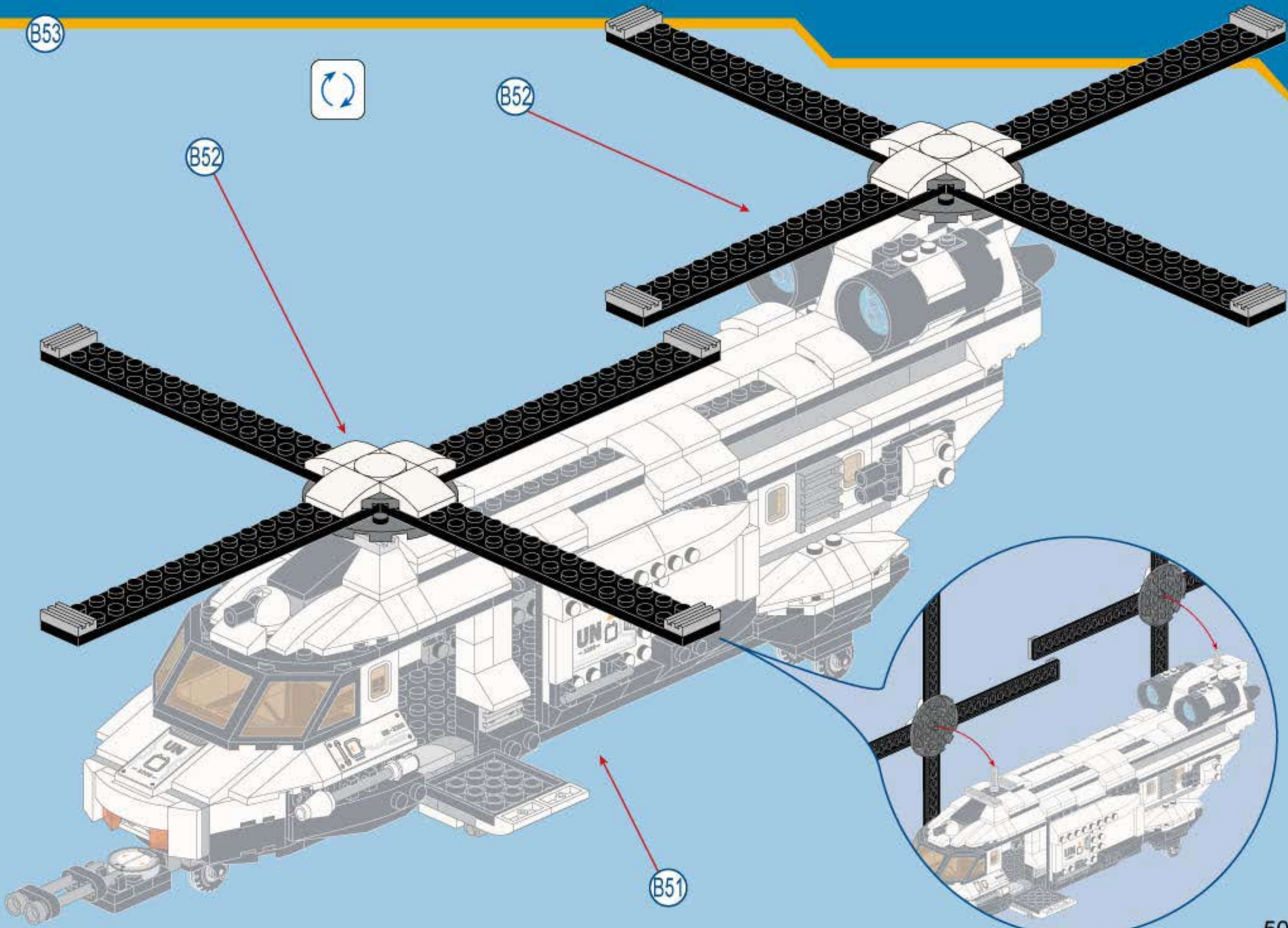





**3208**

# THUNDER MISSION



**3201 STING'S ASSAULTED**



**3202 MOUNTAIN AMBUSH**



**3203 BLOCK ARMED JEEP**



**3204 ARMORED VEHICLE'S CRISIS**



**3205 HUMMER COUNTERATTACK**



**3206 TANK ATTACK**



**3207 SUPER WEAPON APPEARANCE**



**3208 GUNSHIP AIRCRAFT**



**3209 HEAVY ARMORED VEHICLE ATTACK**