



Qman

2609

Ages: 6+

Minifigs: X3

PCS: 456

Princess Leah



Angel Princess Ship





+



=

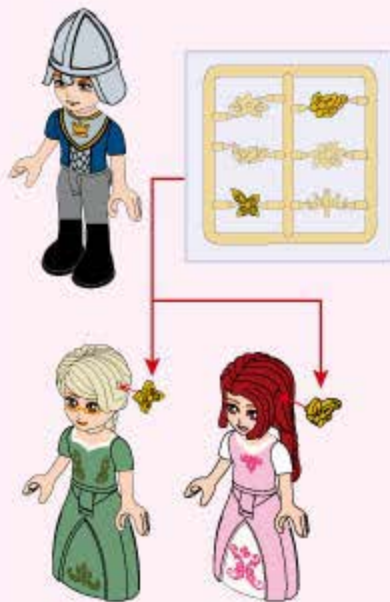
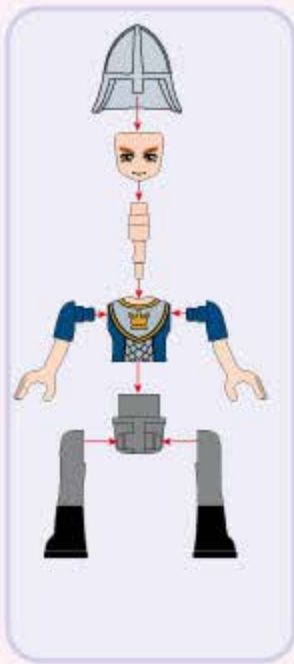
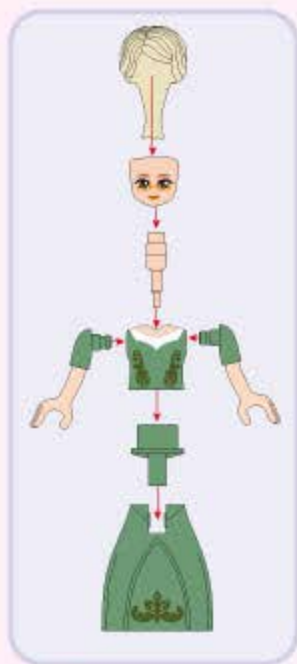

拆件器使用方法, 仅为示例

Usage of Brick Separator, Just for the sample

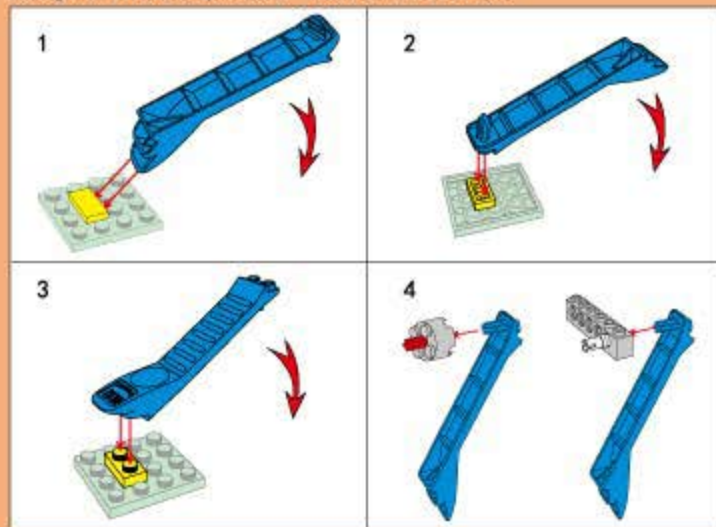

1

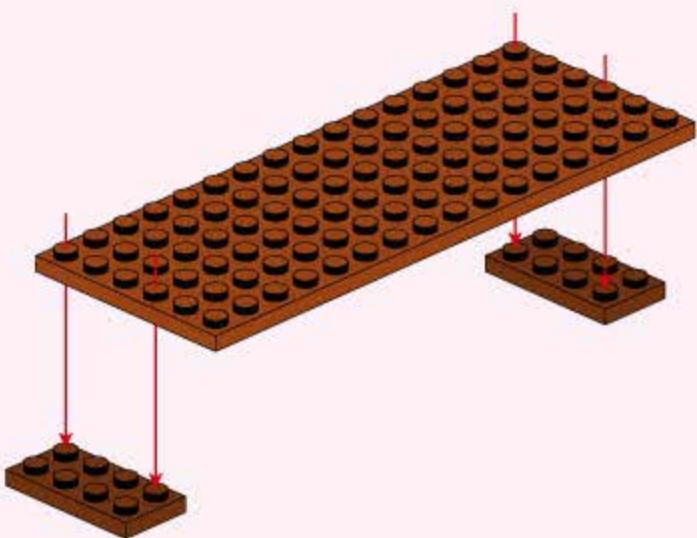
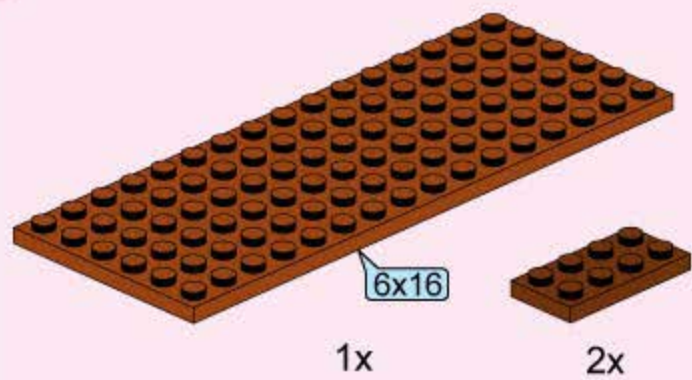

2

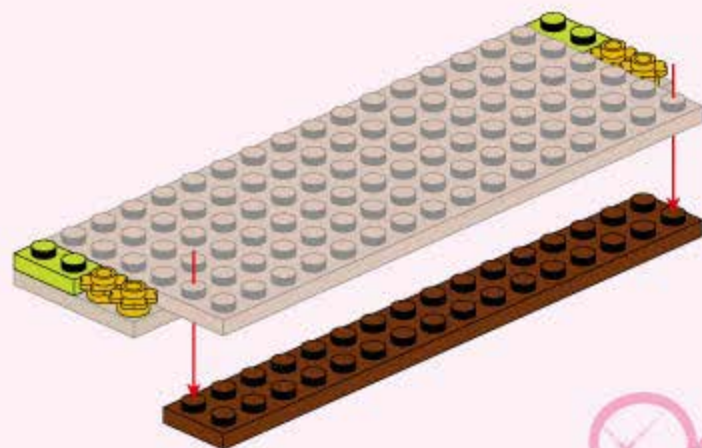
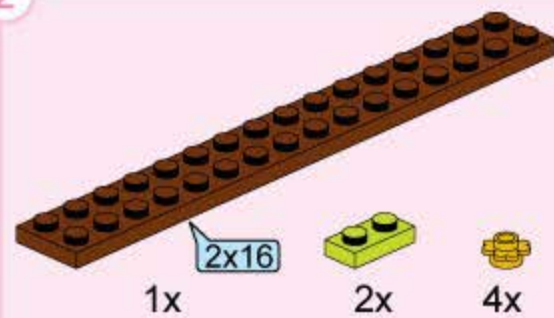

3

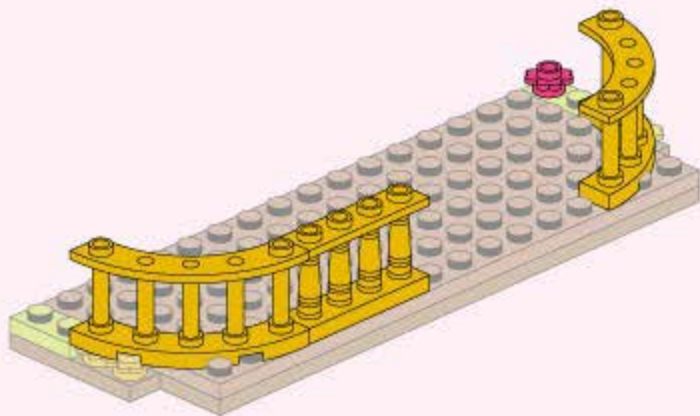
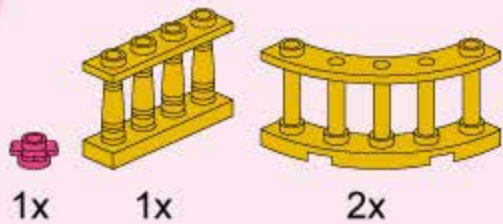

4

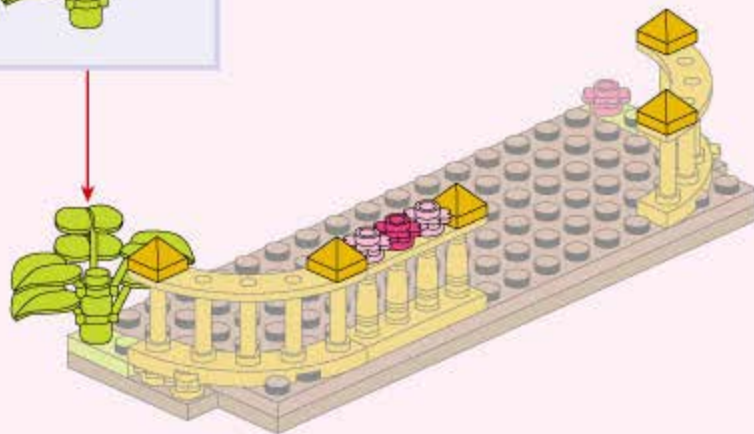
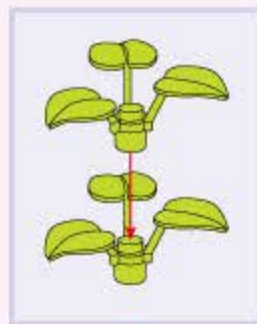
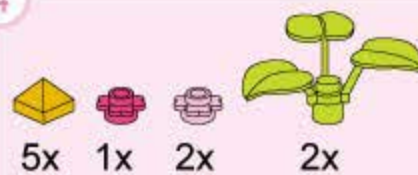

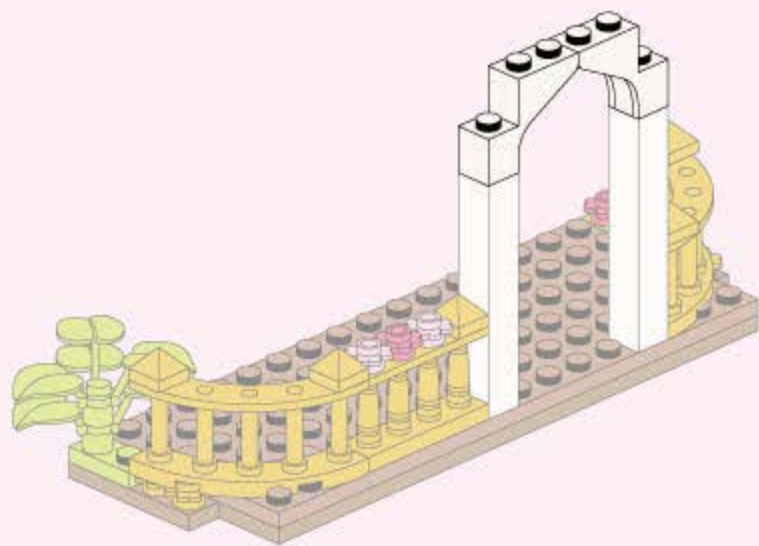
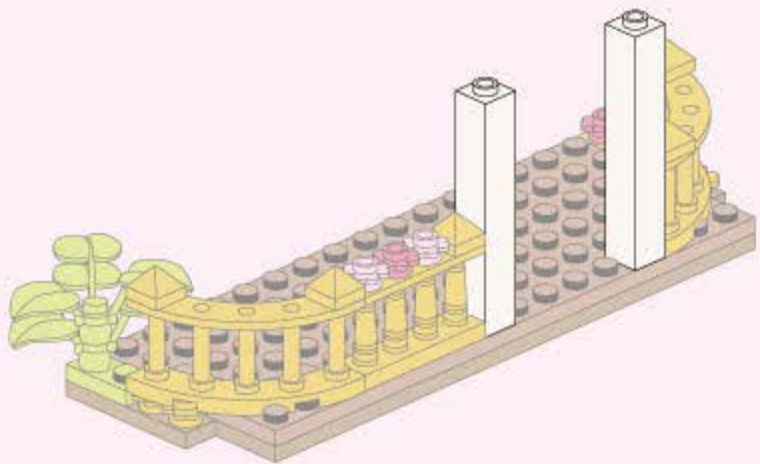
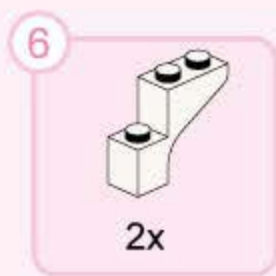
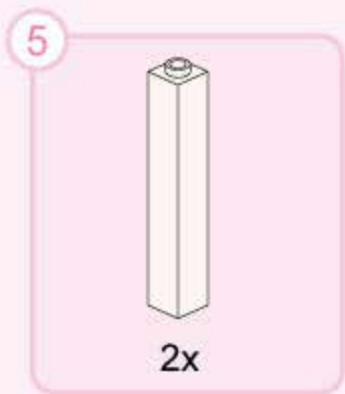



7



2x

2x

1x



1x



2x

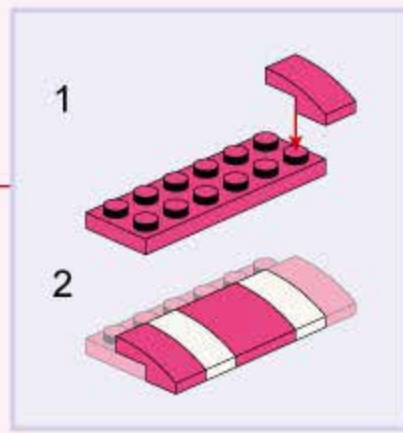

1

2

8



2x

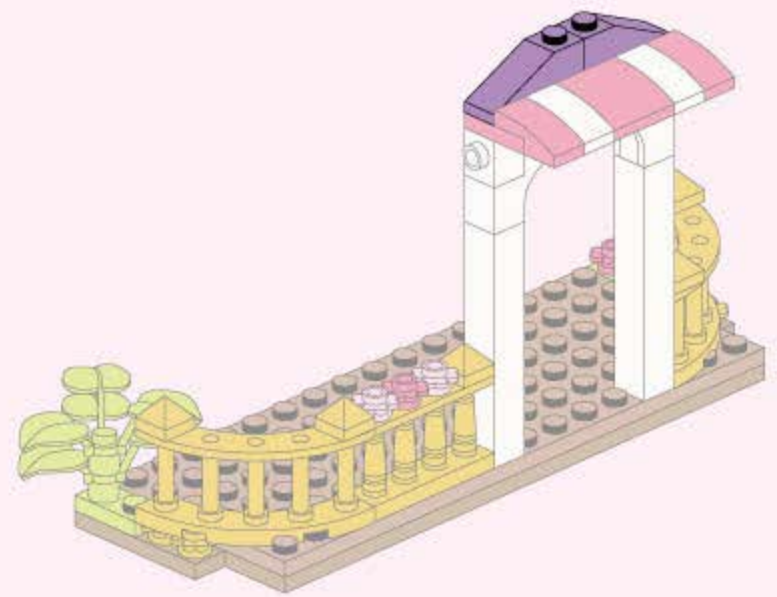
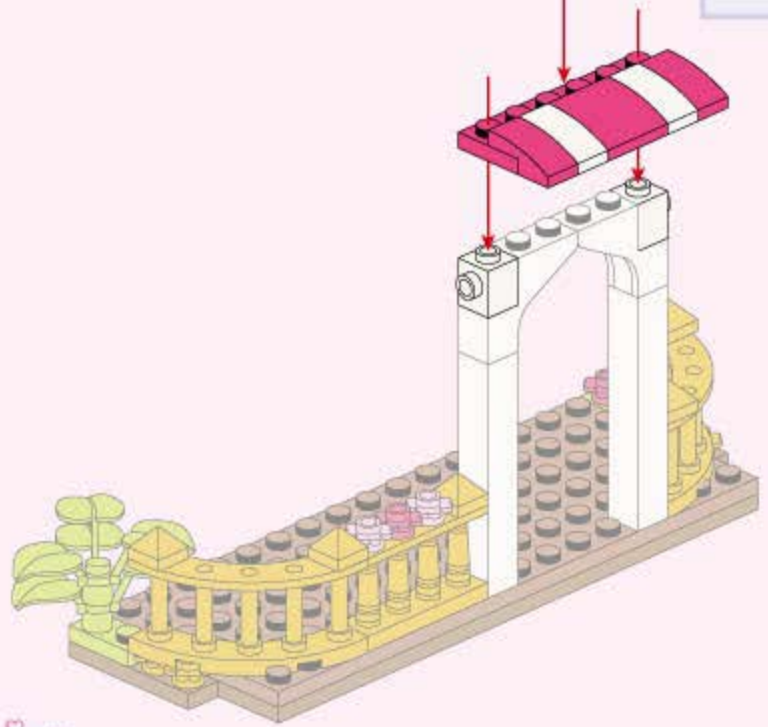

9

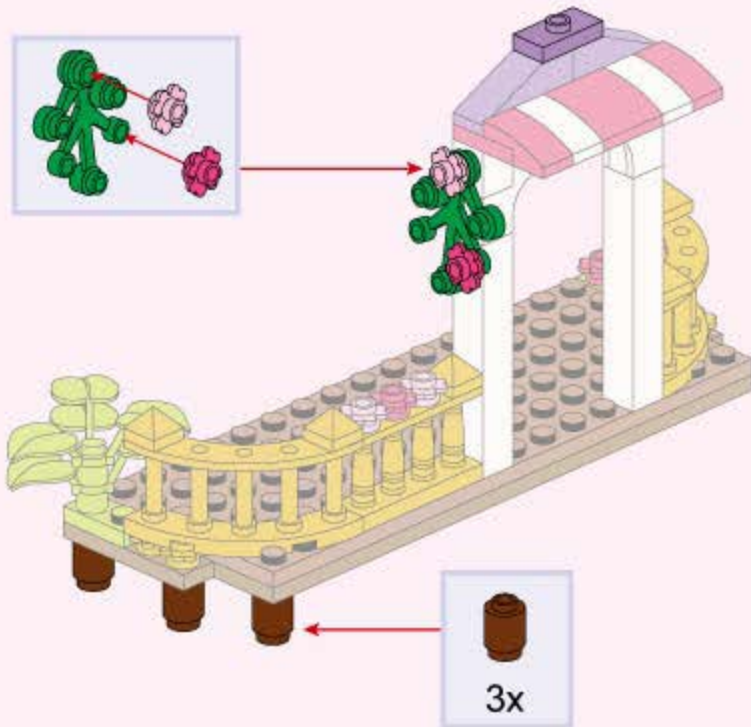
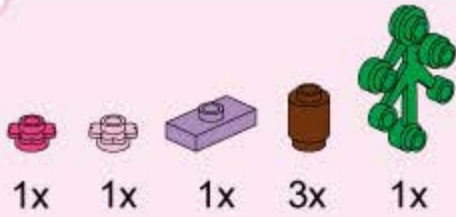

10

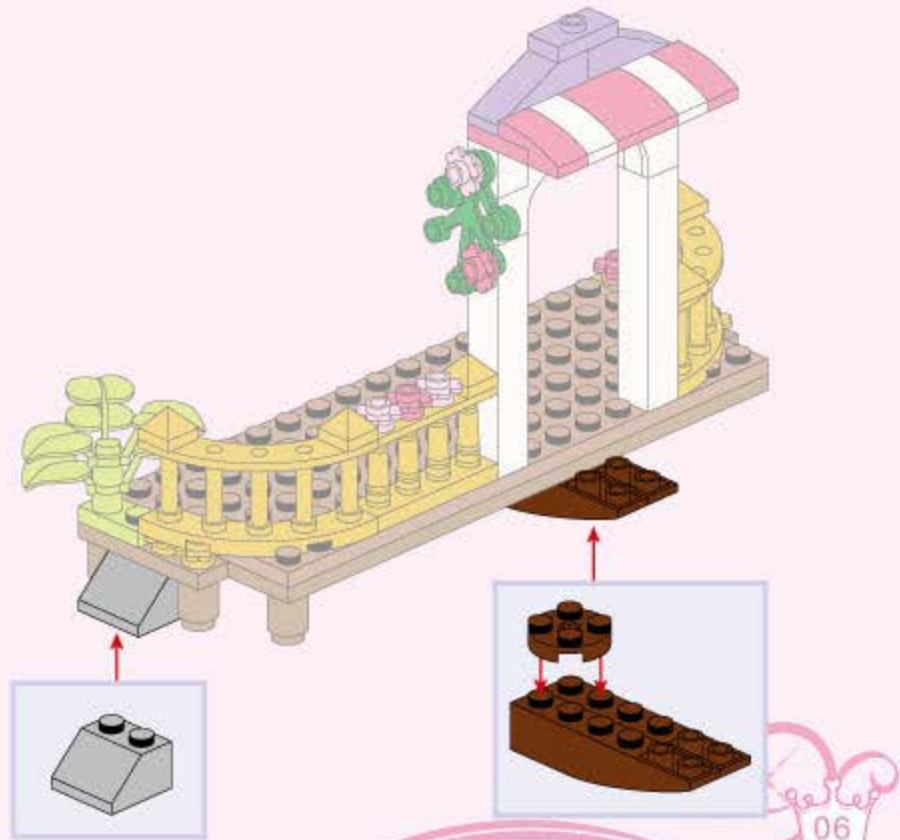
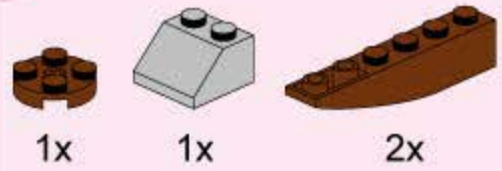

11



1x



1x



3x



1x

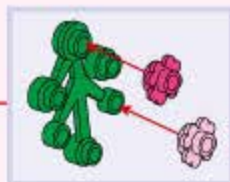



12



2x

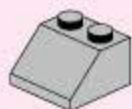

1x



1x

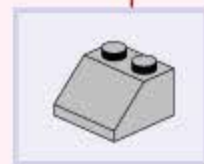
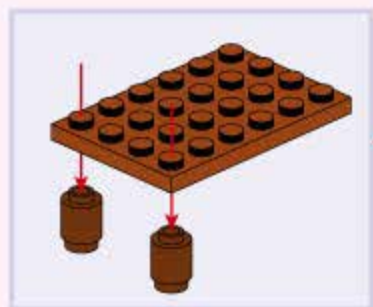

13



4x



4x



1x



1x

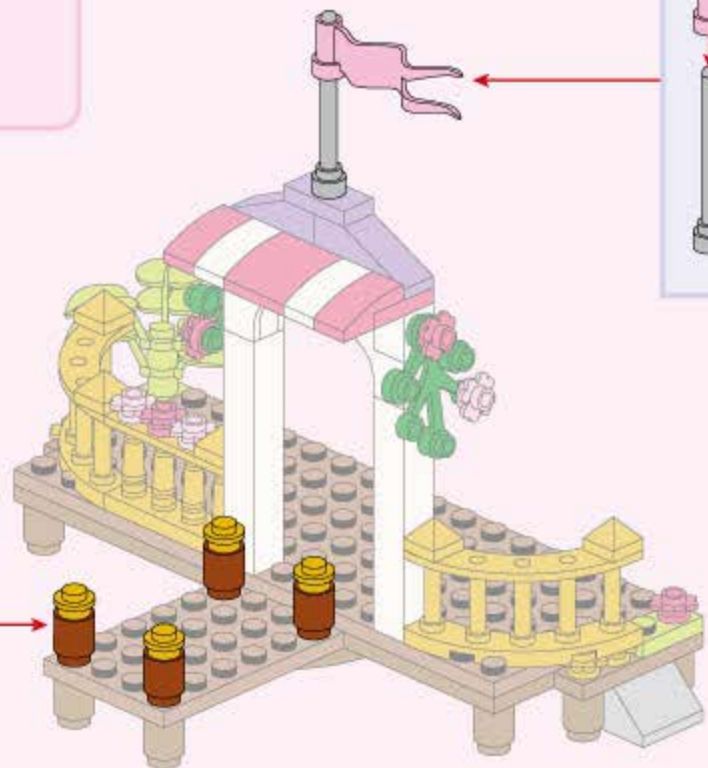

4x

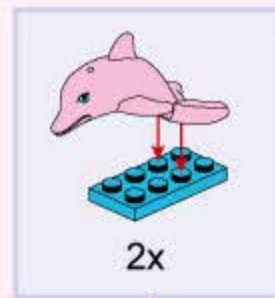
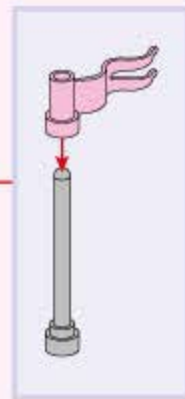

2x



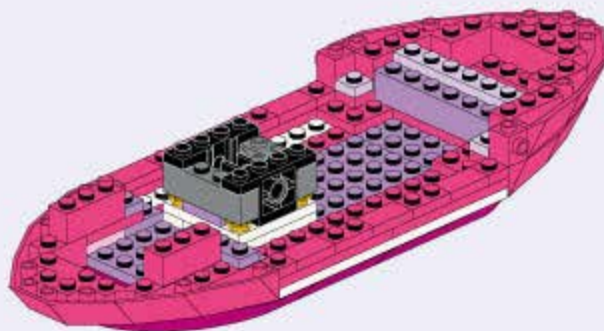

1



1x



2x

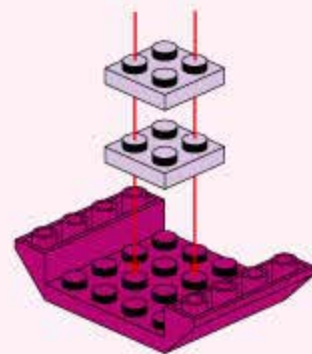



2

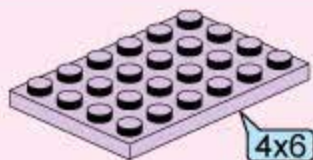

1x



2x

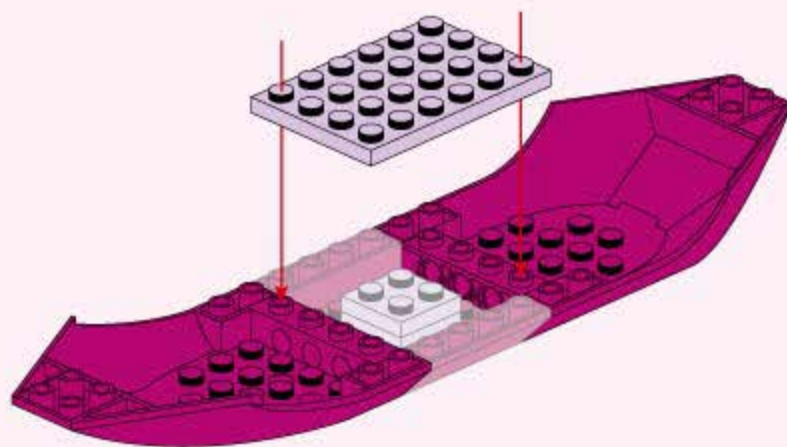

3



4x



1x

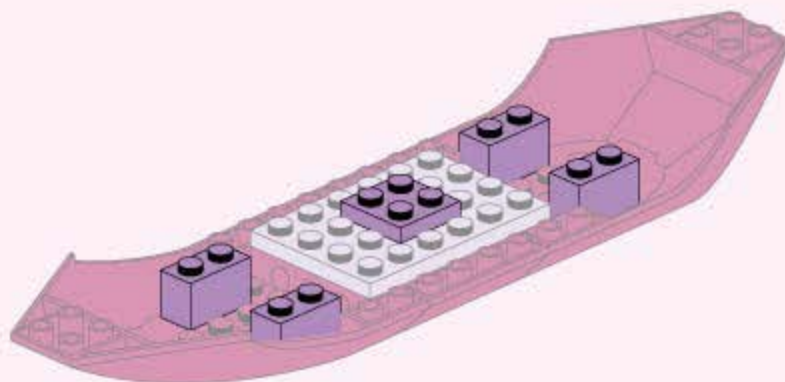

4



1x

2x

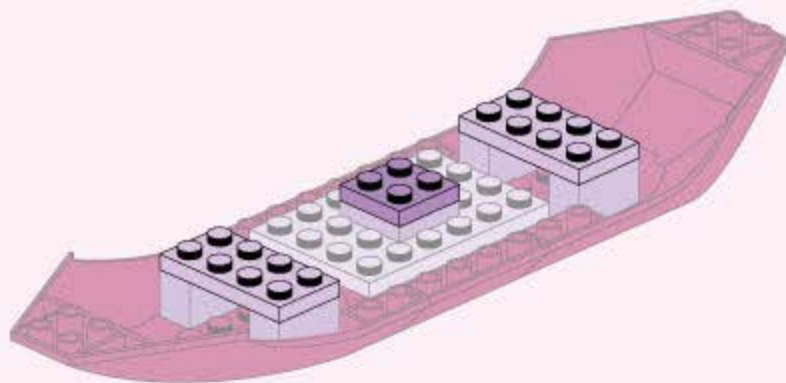

5



4x

4x

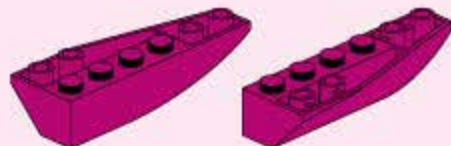

2x

2x

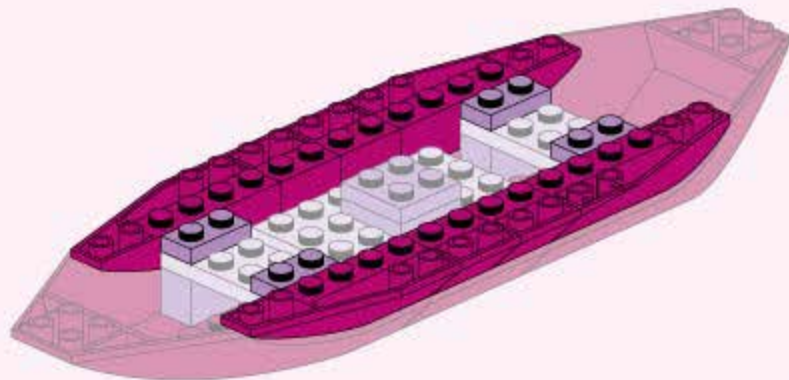

6

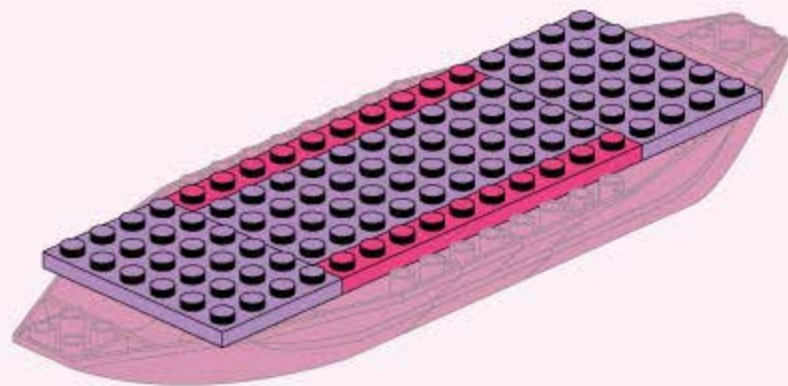
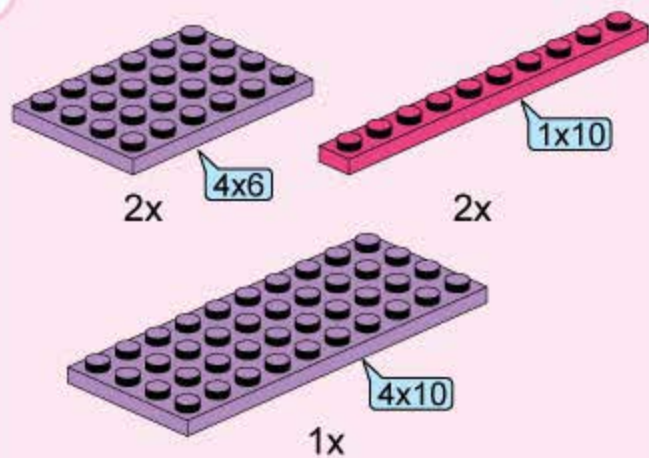

7

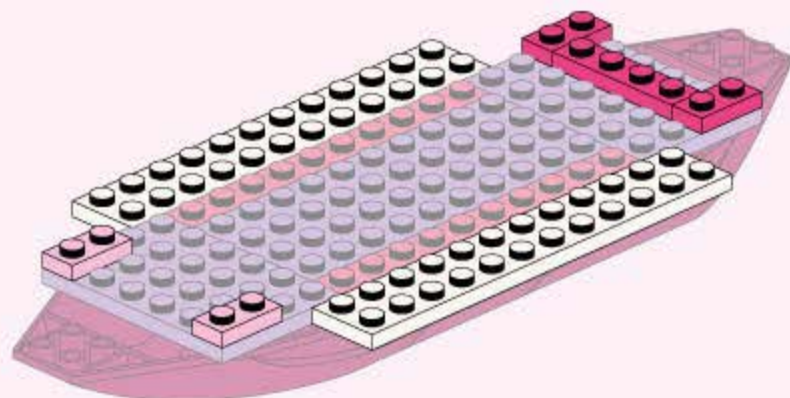
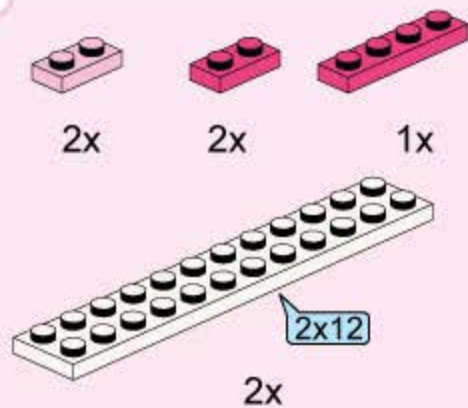



8

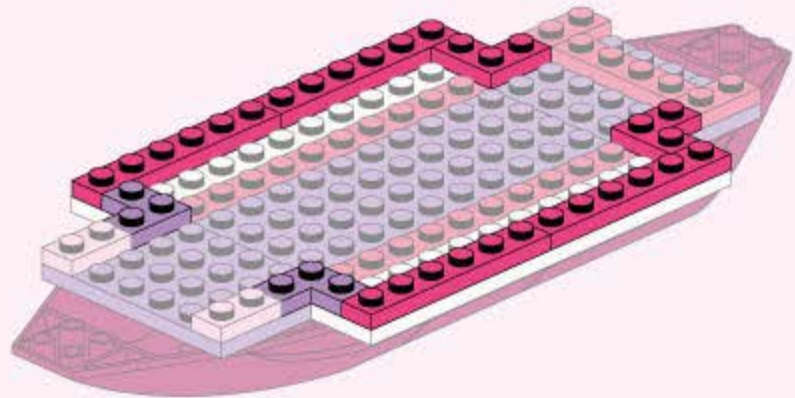
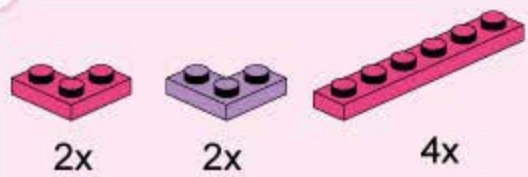

9

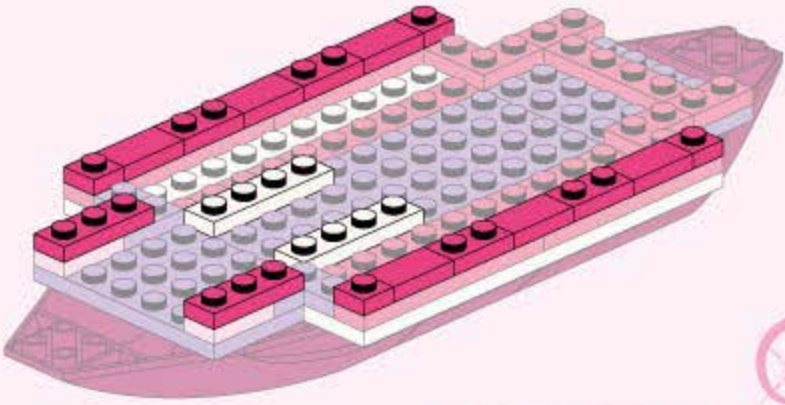
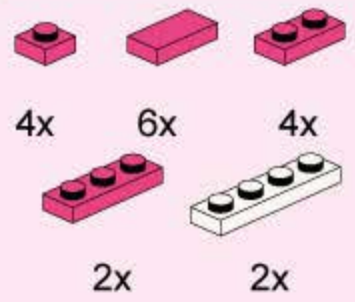

10



1x

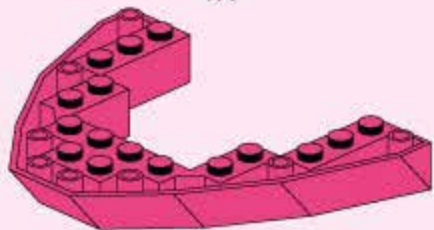

2x

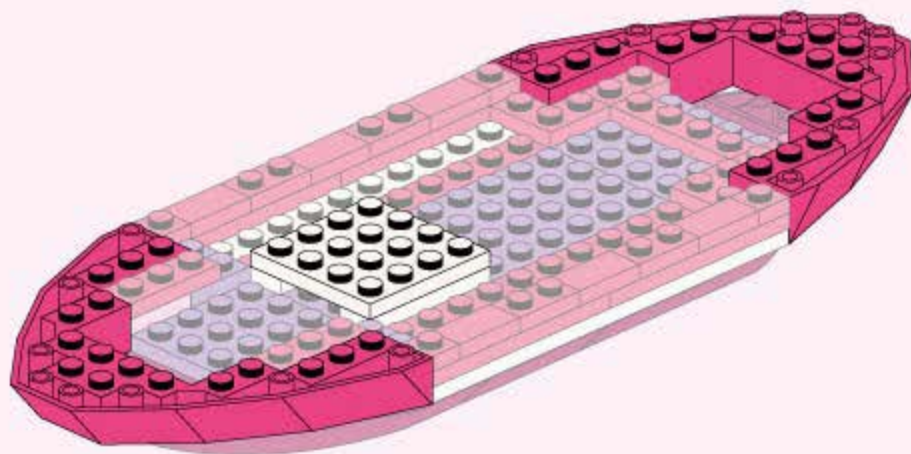

11



4x



2x



4x

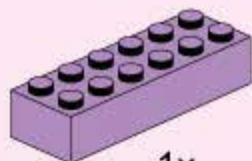

1x

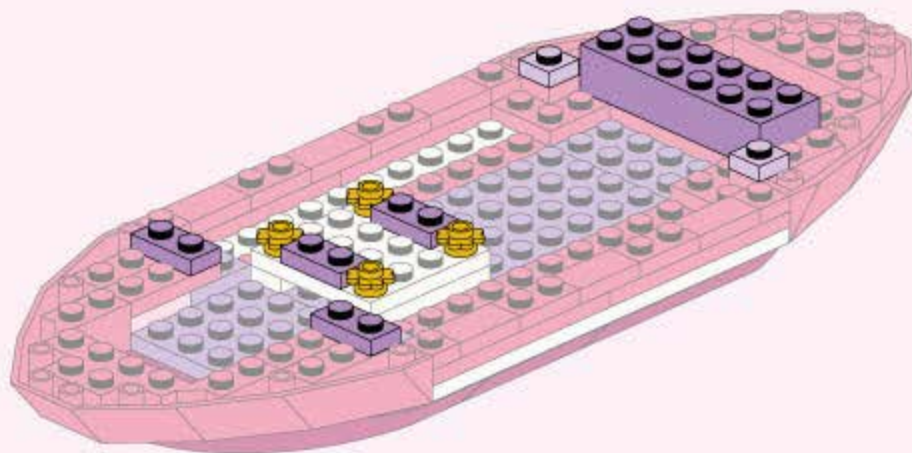

12



1x

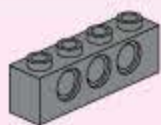

1x



2x

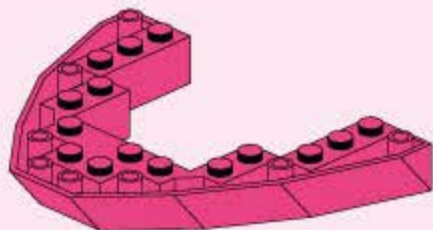

1x

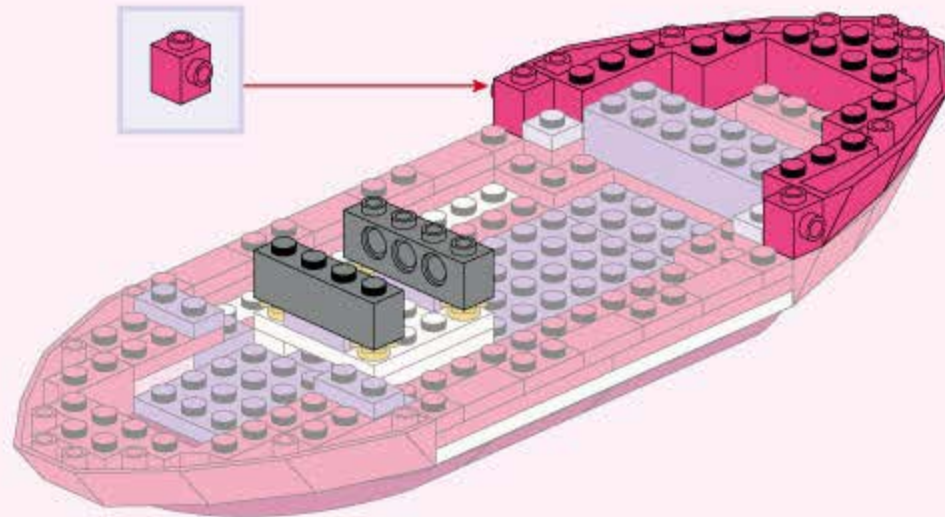

13



2x



1x



1x

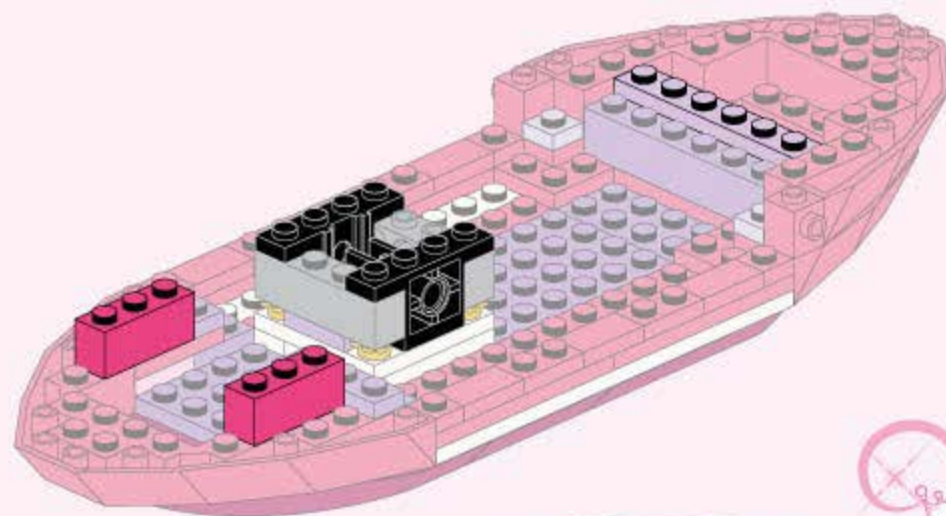





14



1x



2x

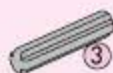

1x



1x

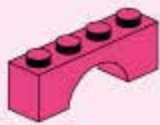

6x



3

1:1

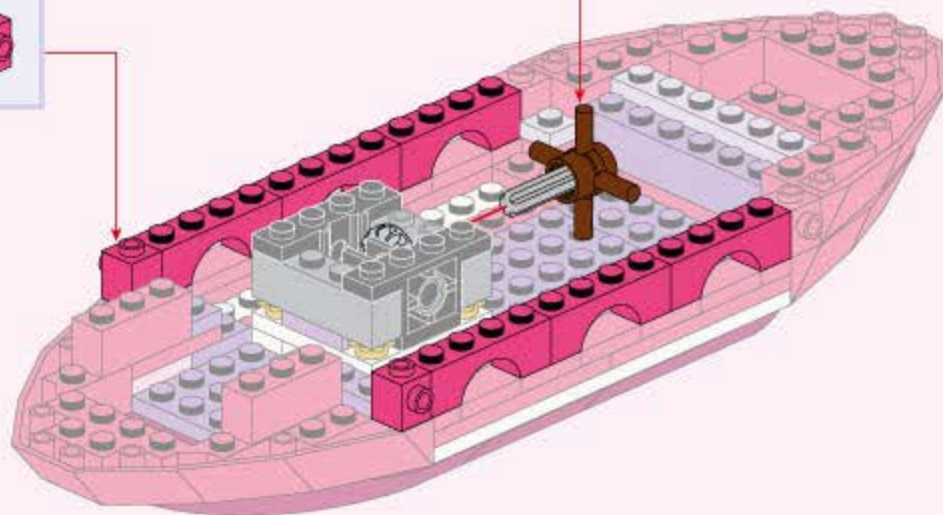
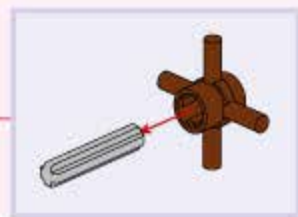

15



1x



1x



1x

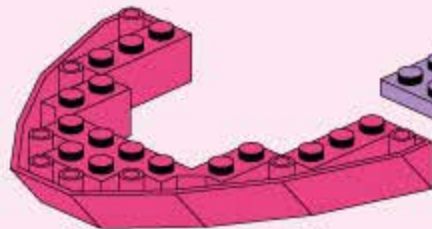

1x

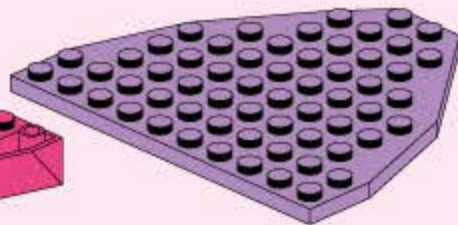

1x

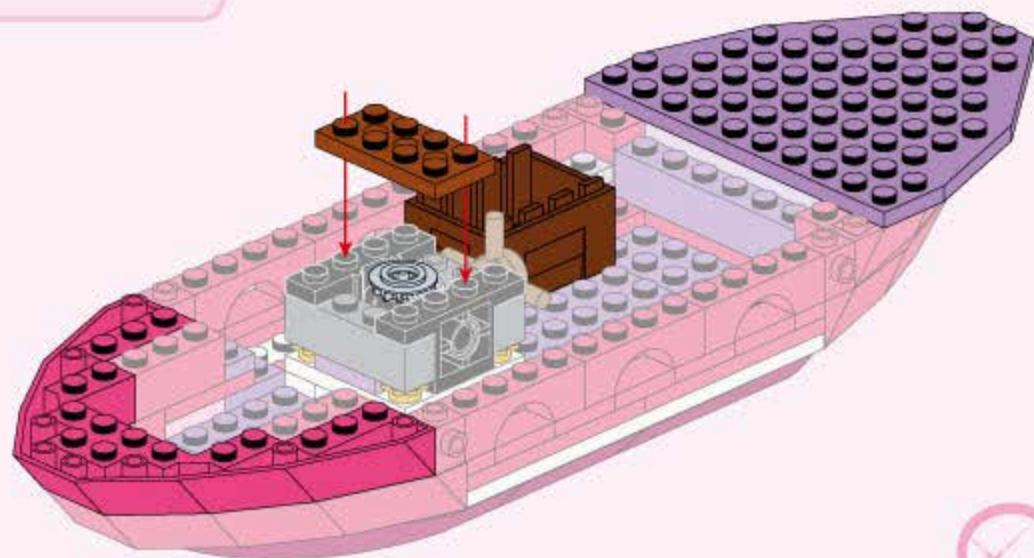

16



2x



1x



1x



2x



1x

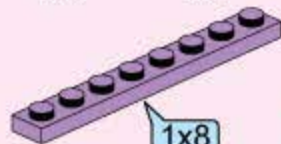

4x

1x8



1x



2x

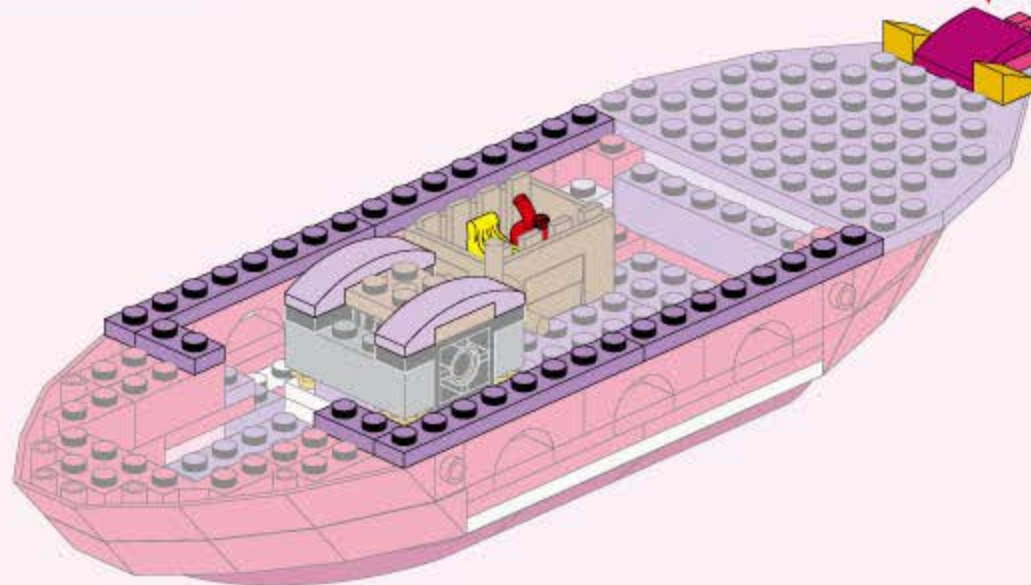



17

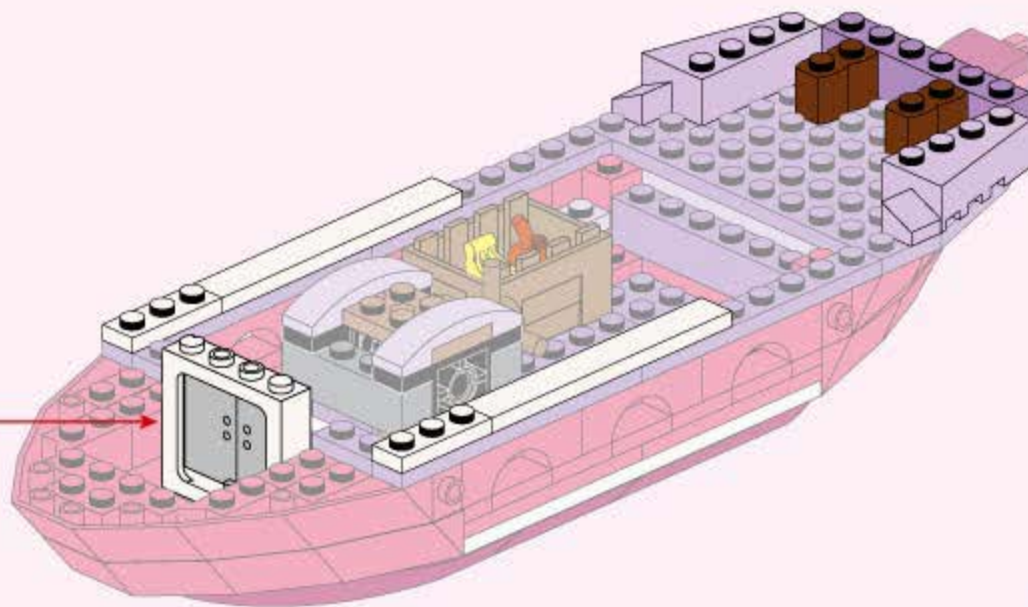
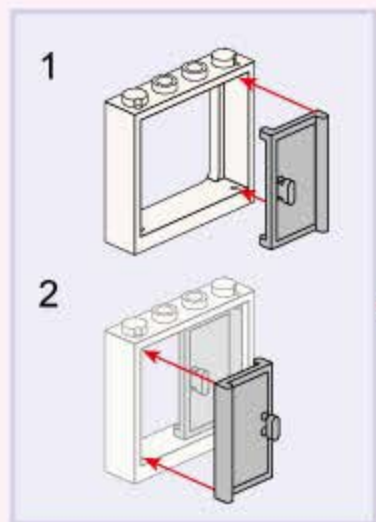
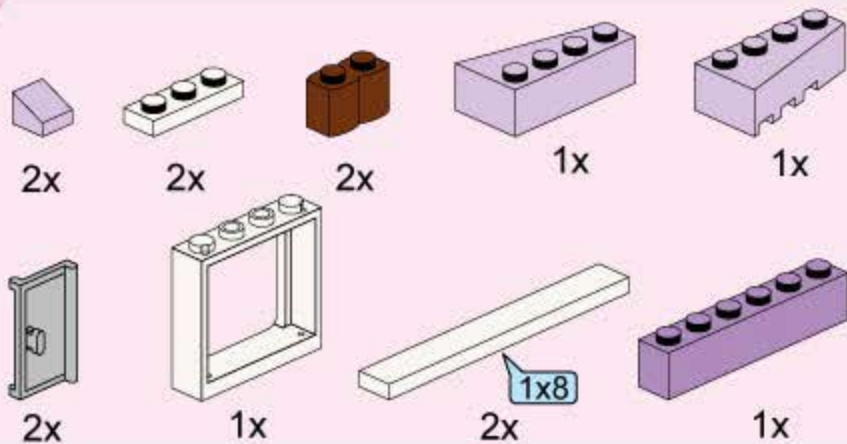

18



2x



1x



2x



1x



4

1x

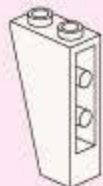

1x



2x

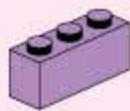

2x



1x



1x

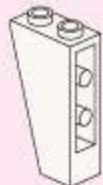

1x

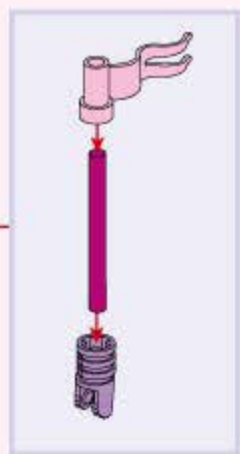
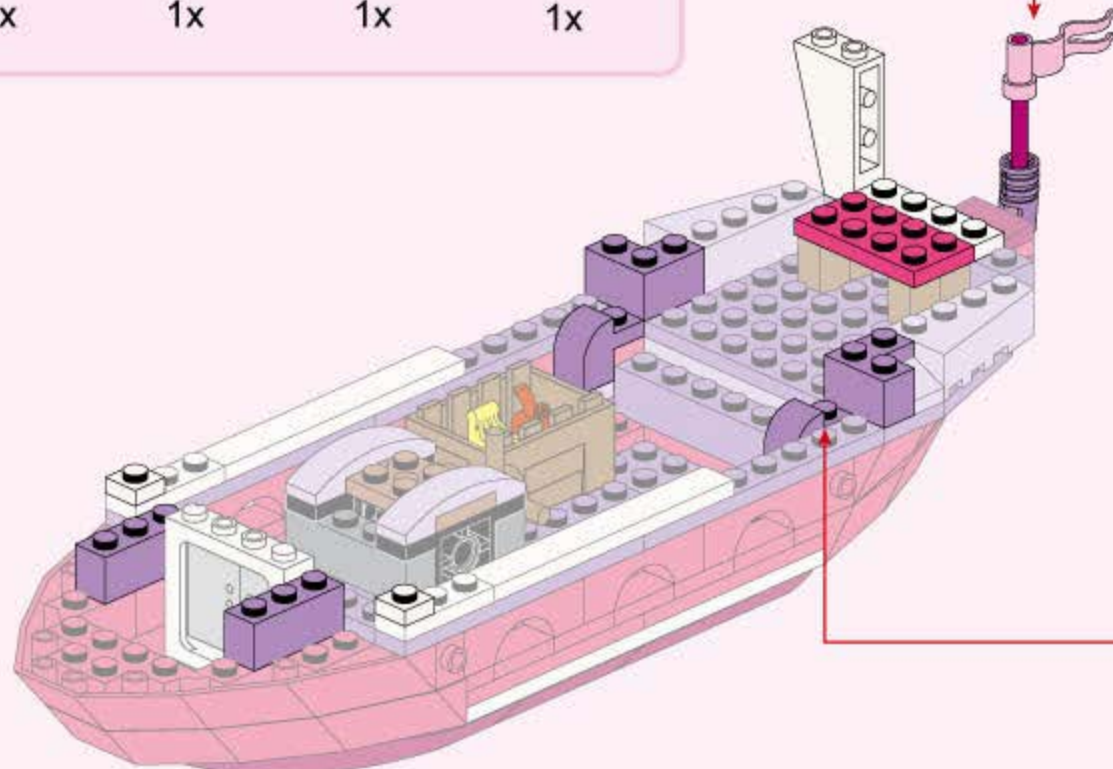

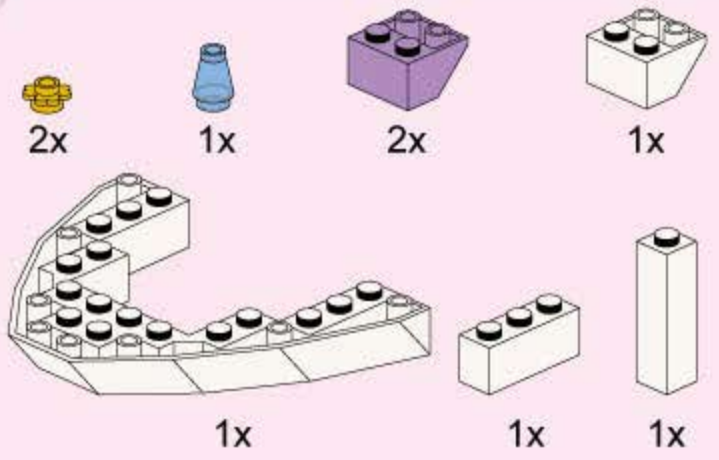

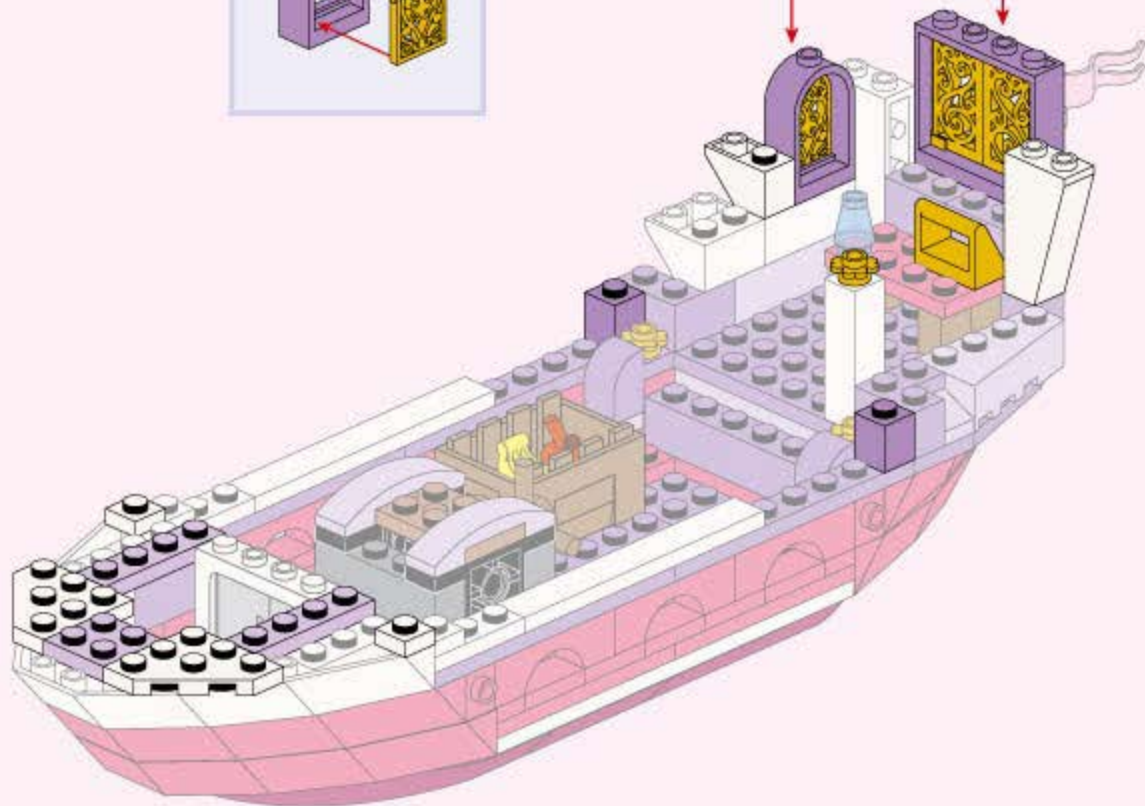
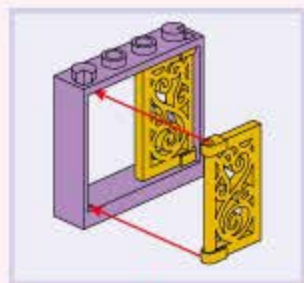
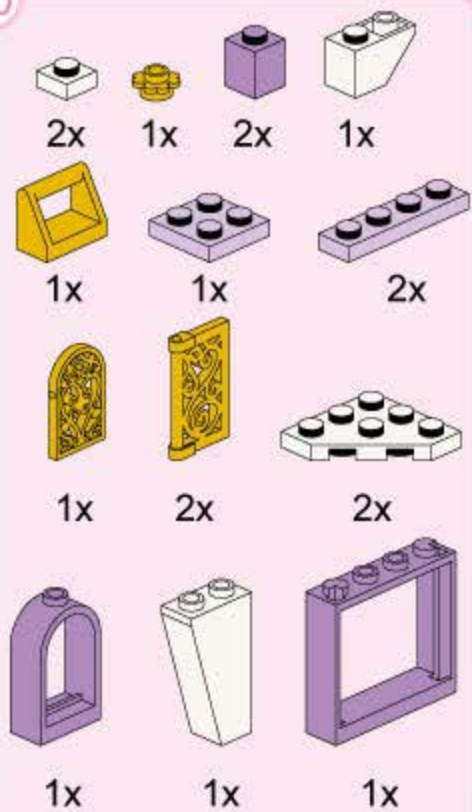



21

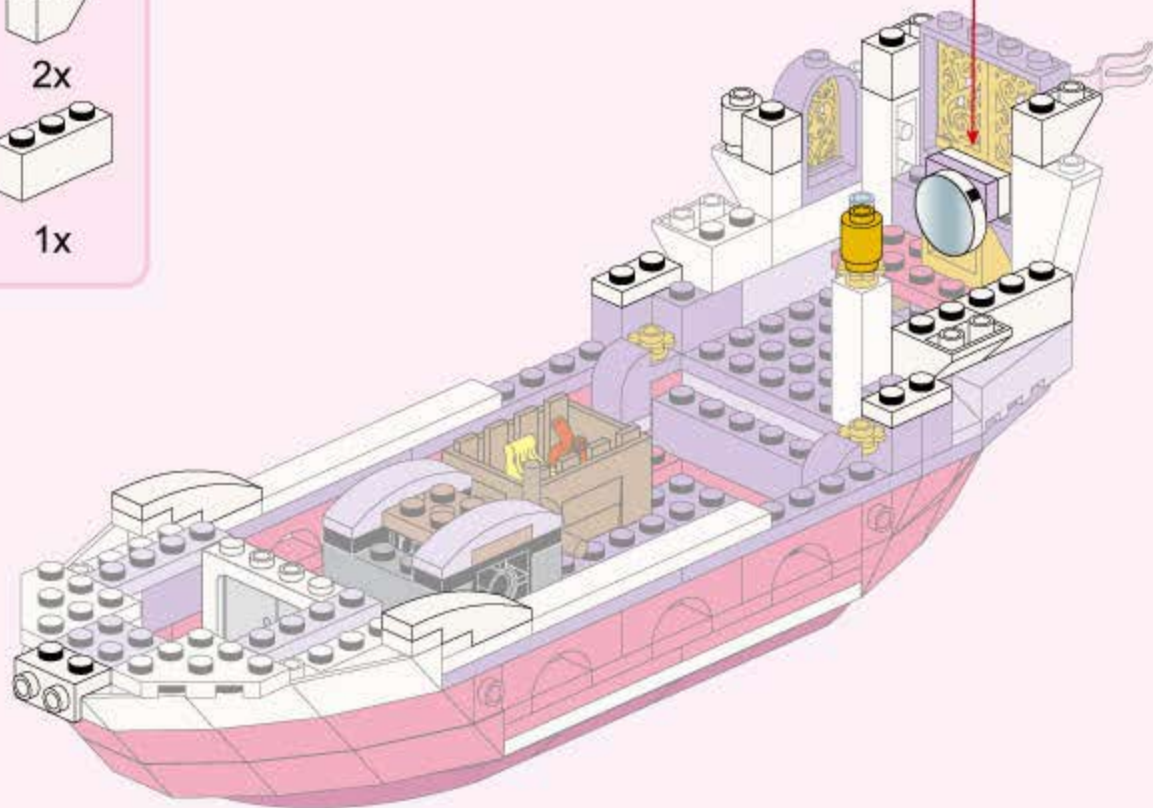
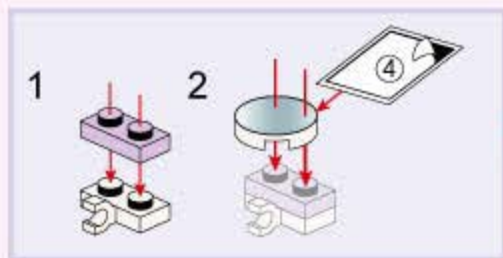
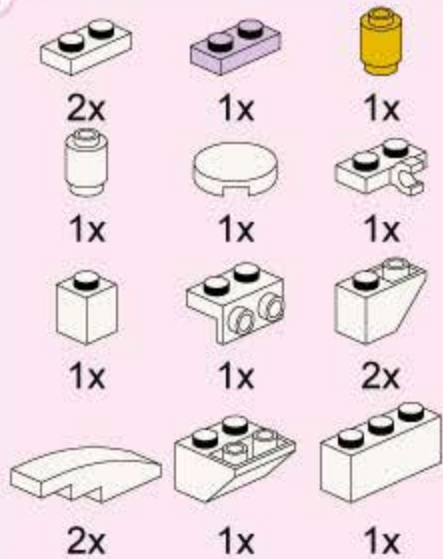



+



=



22

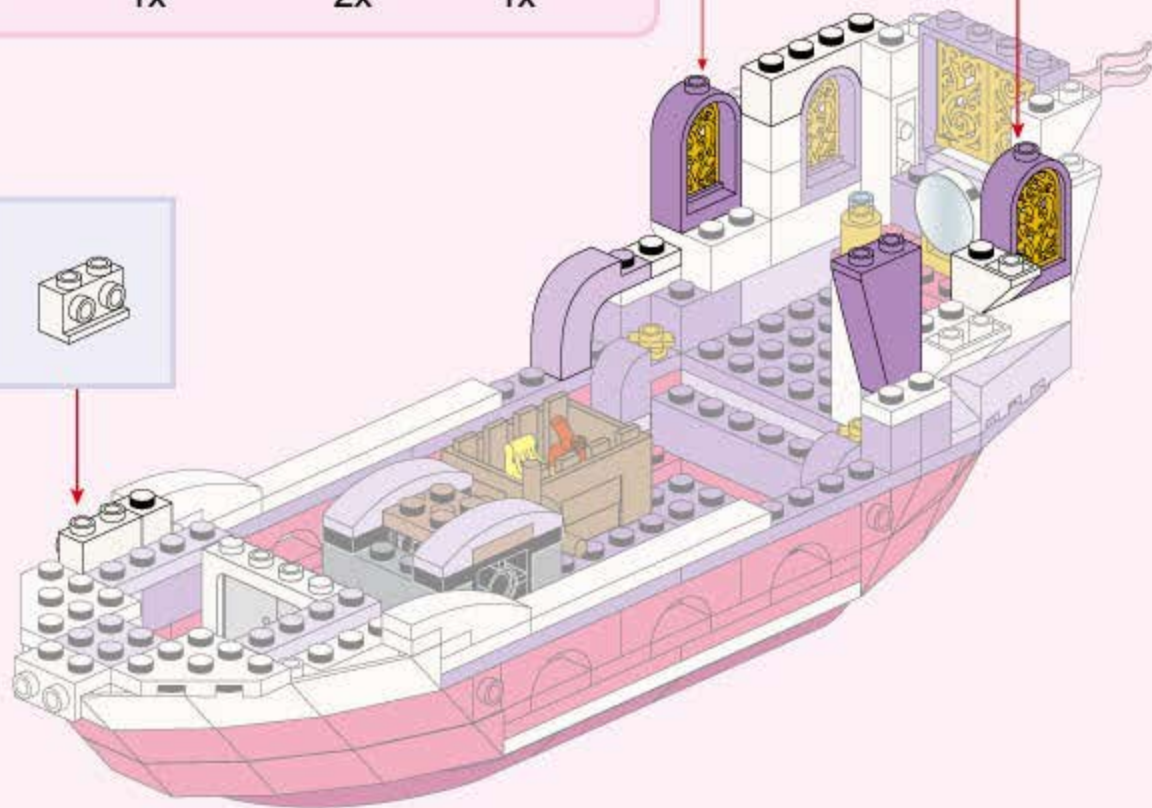
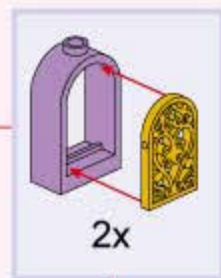
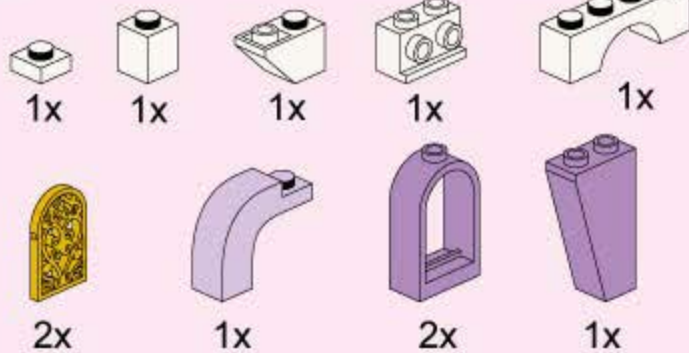

23

- 1x [1x1 white brick with hole]
- 2x [1x2 white brick with hole]
- 1x [white cylinder]
- 1x [white square]
- 1x [green cross-shaped piece]
- 2x [1x3 white plate] 1x3
- 1x [white curved piece]
- 1x [purple curved piece]
- 1x [orange circular piece with red and grey dots]
- 1x [4x6 purple plate] 4x6

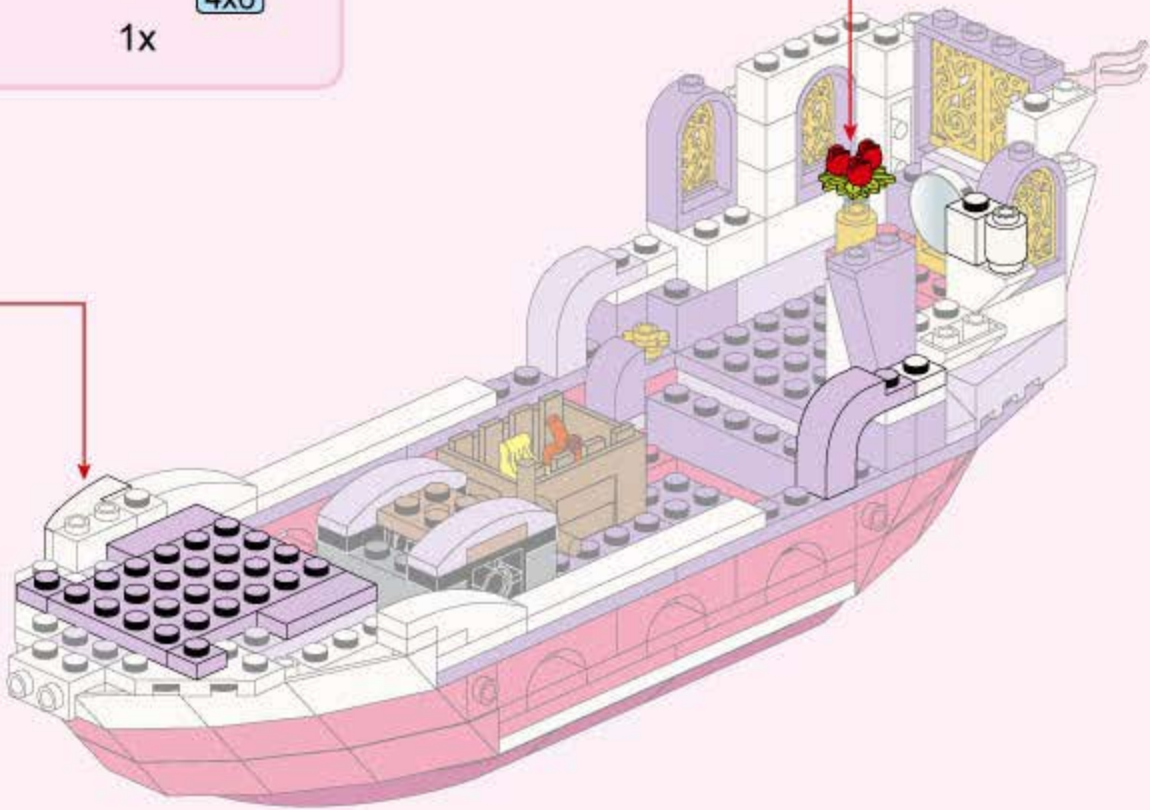
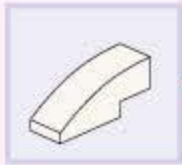



24



1x



1x



2x

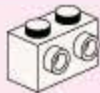

2x



1x



1x



1x

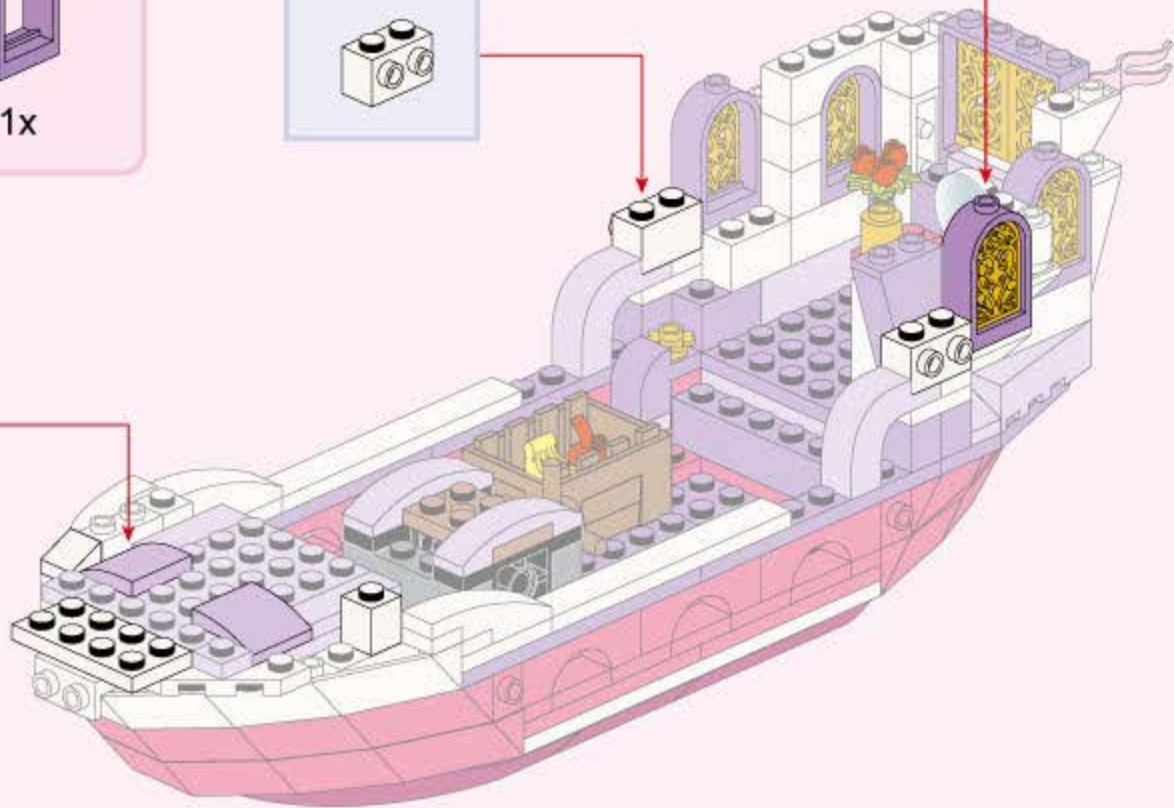
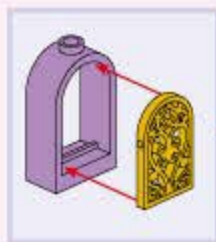



25

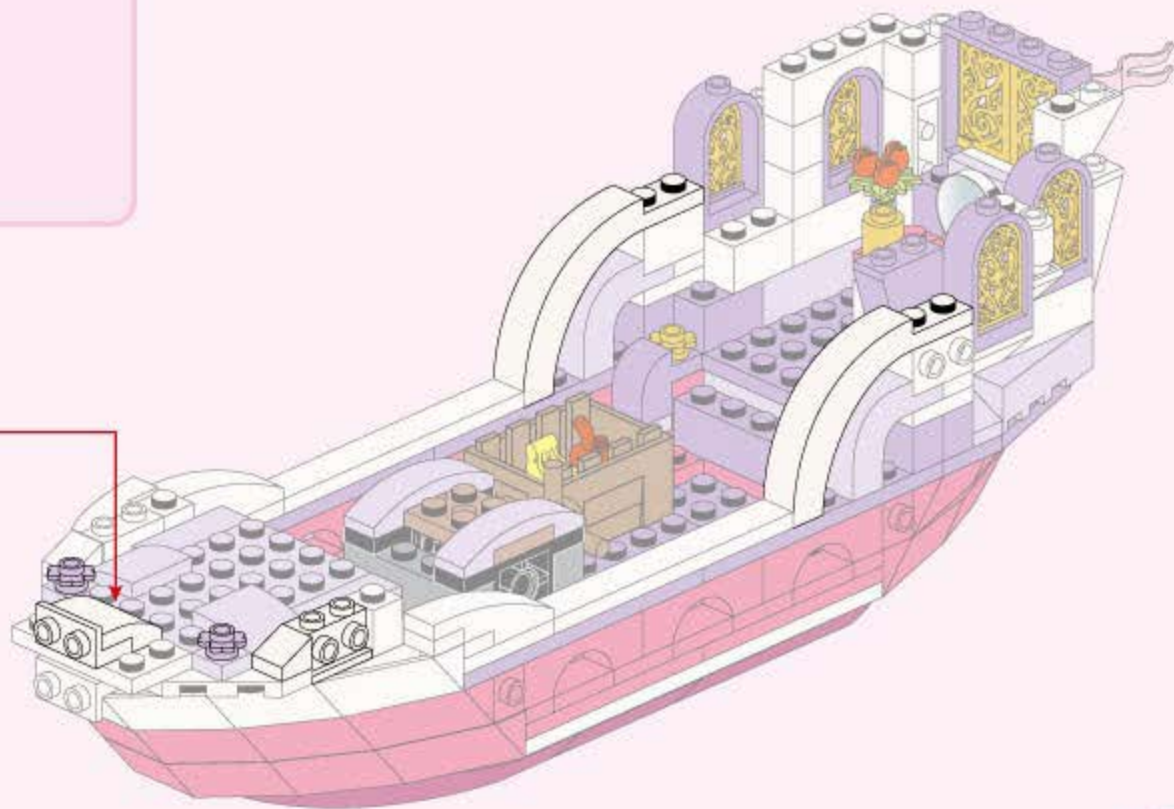
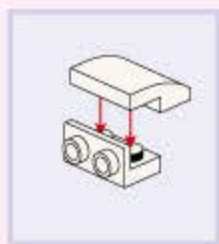
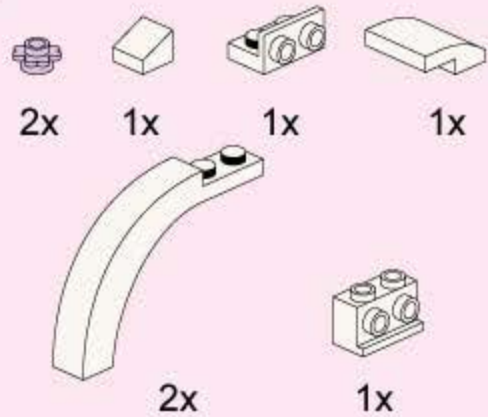

26

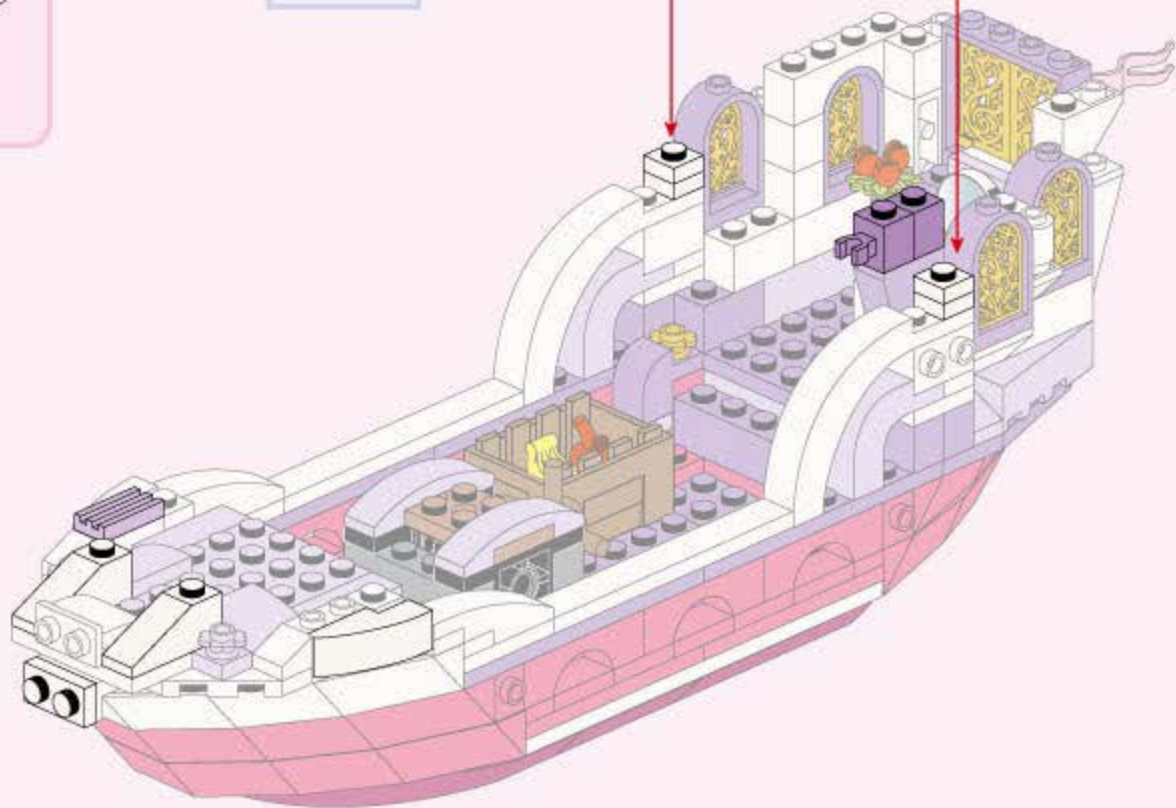
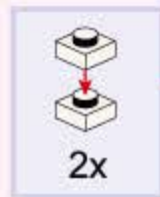
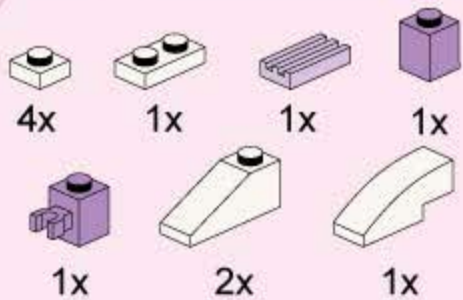

27

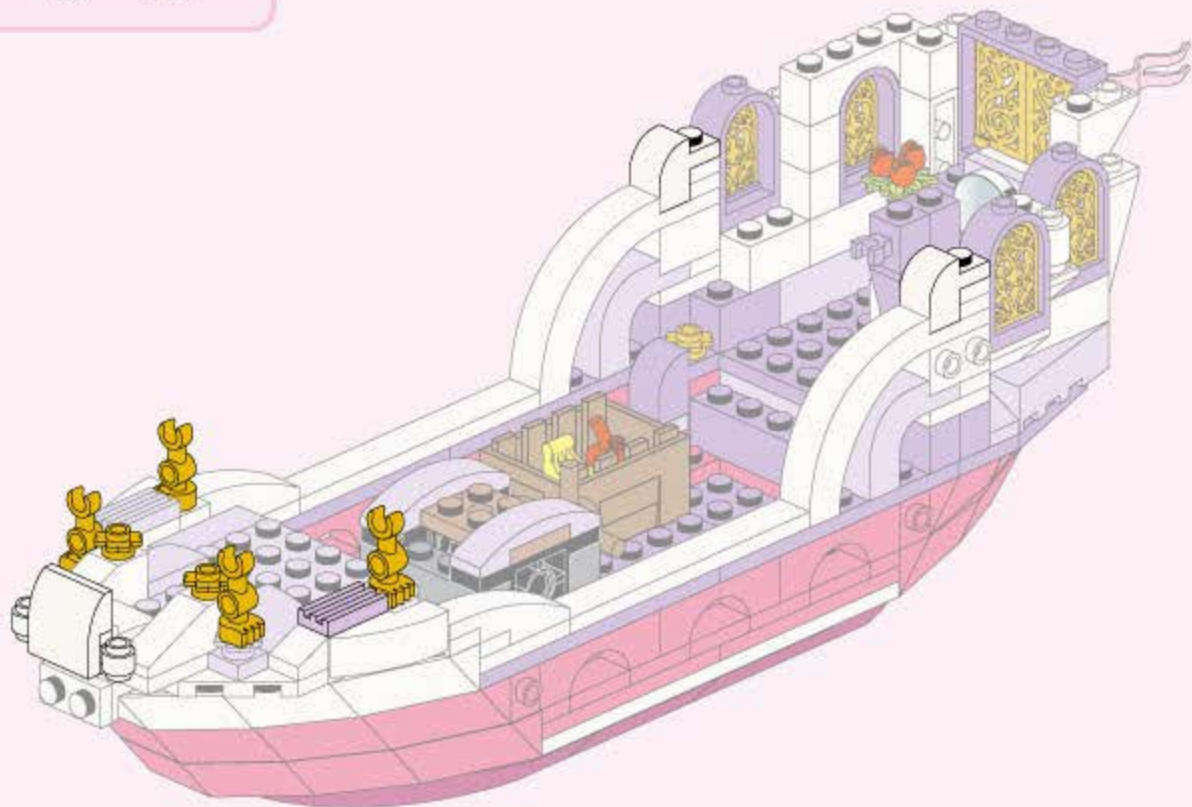
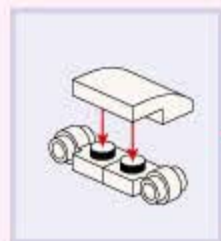
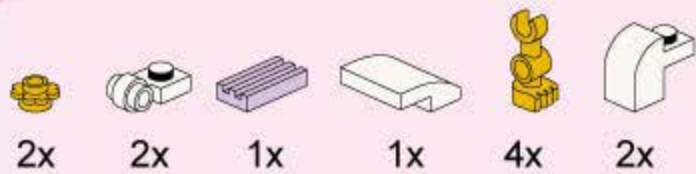

28



2x



2x



3x



1x



1x

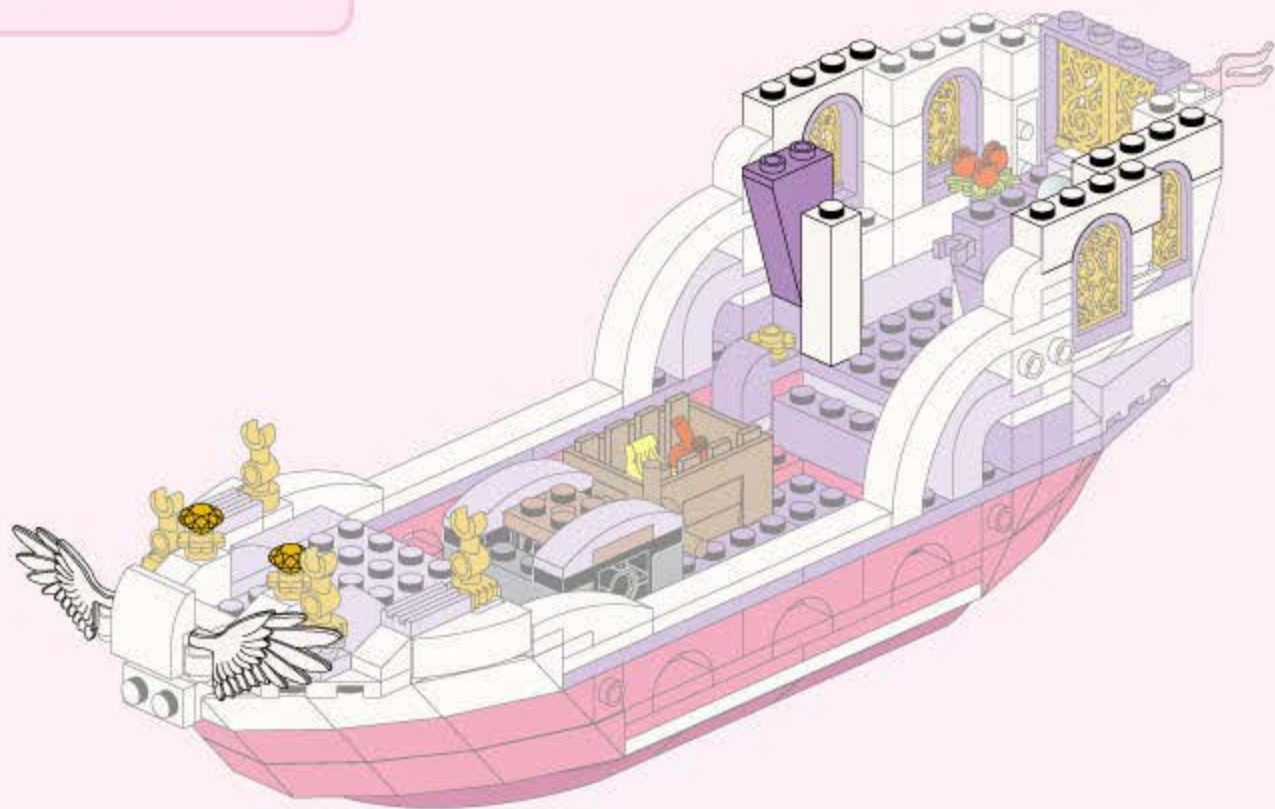



29



1x



1x



1x



1x



1x

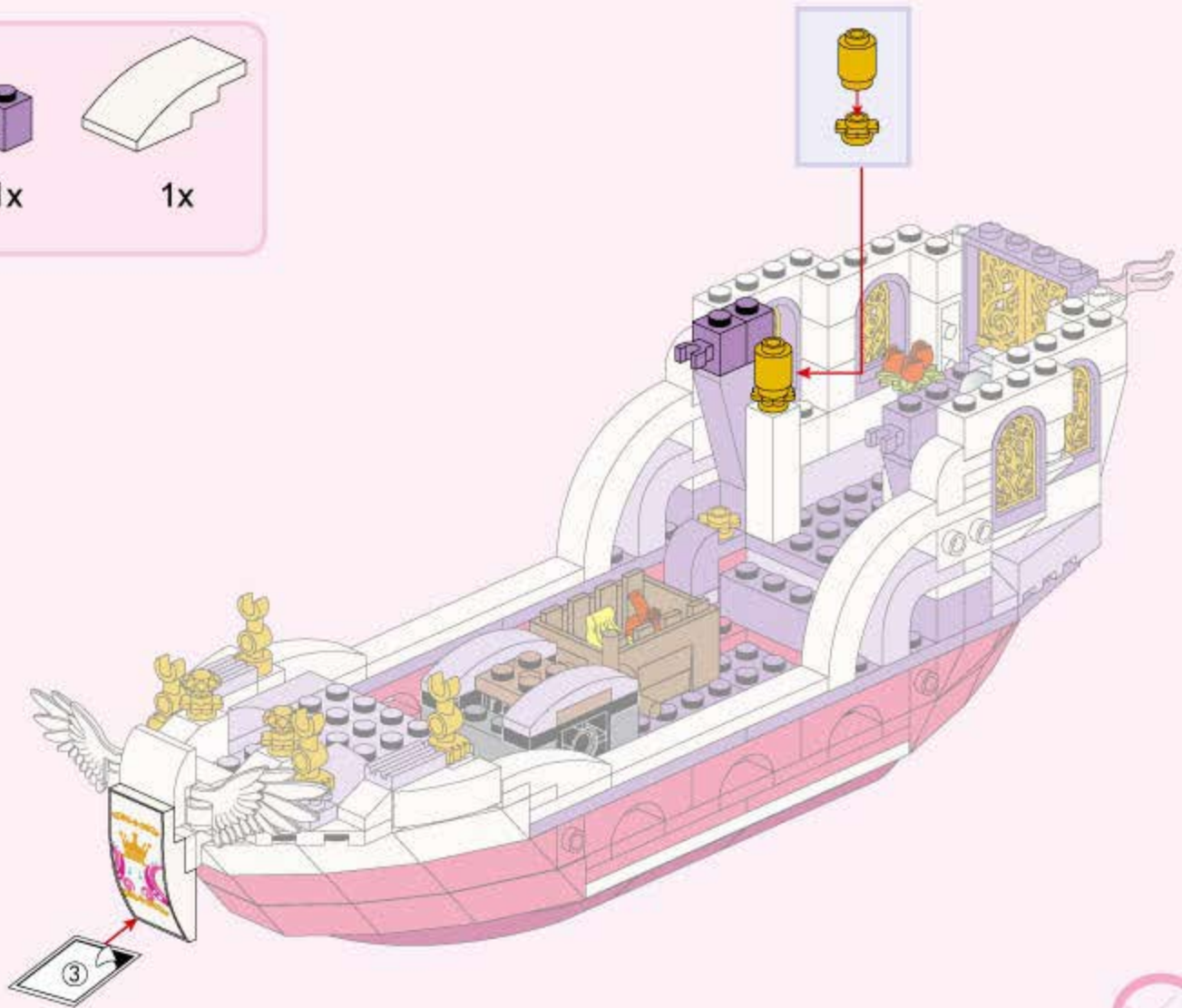

30



2x

2x

2x



1x



2x

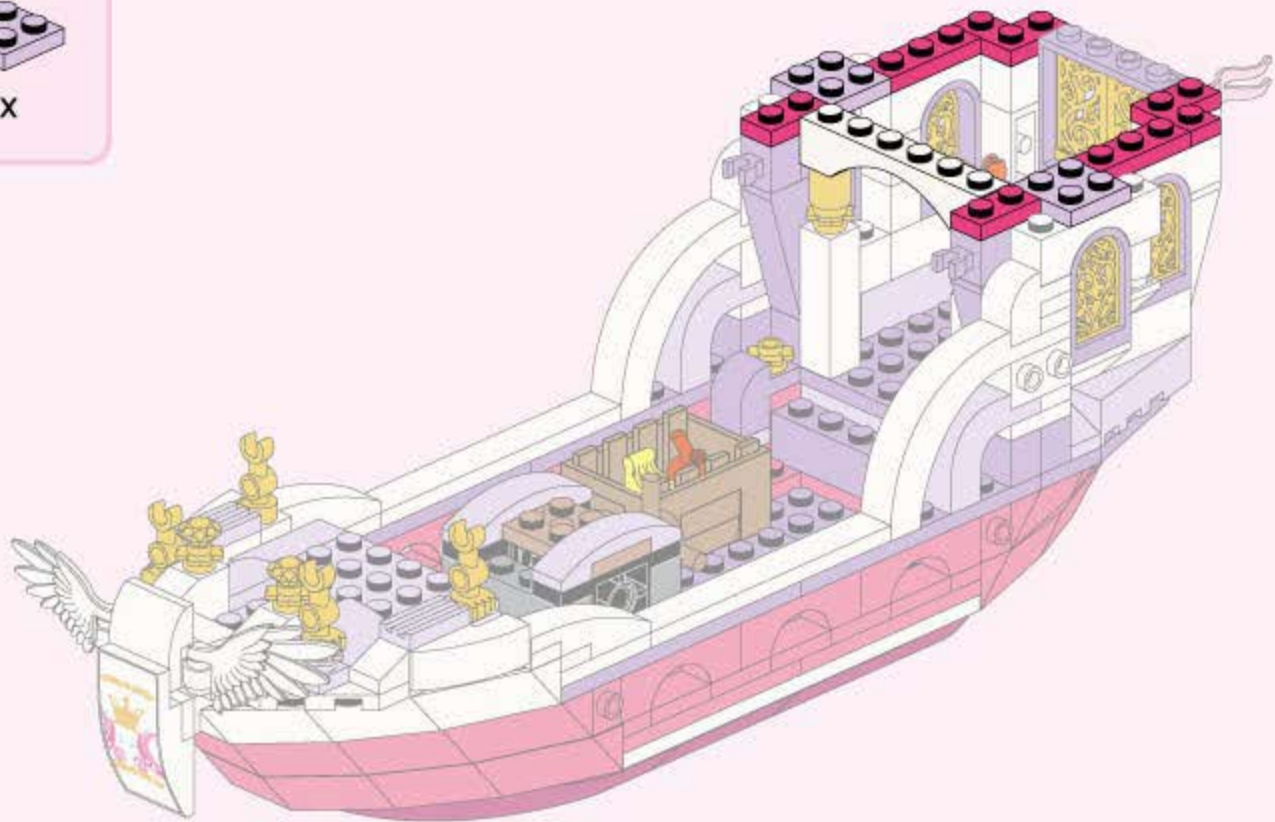

31

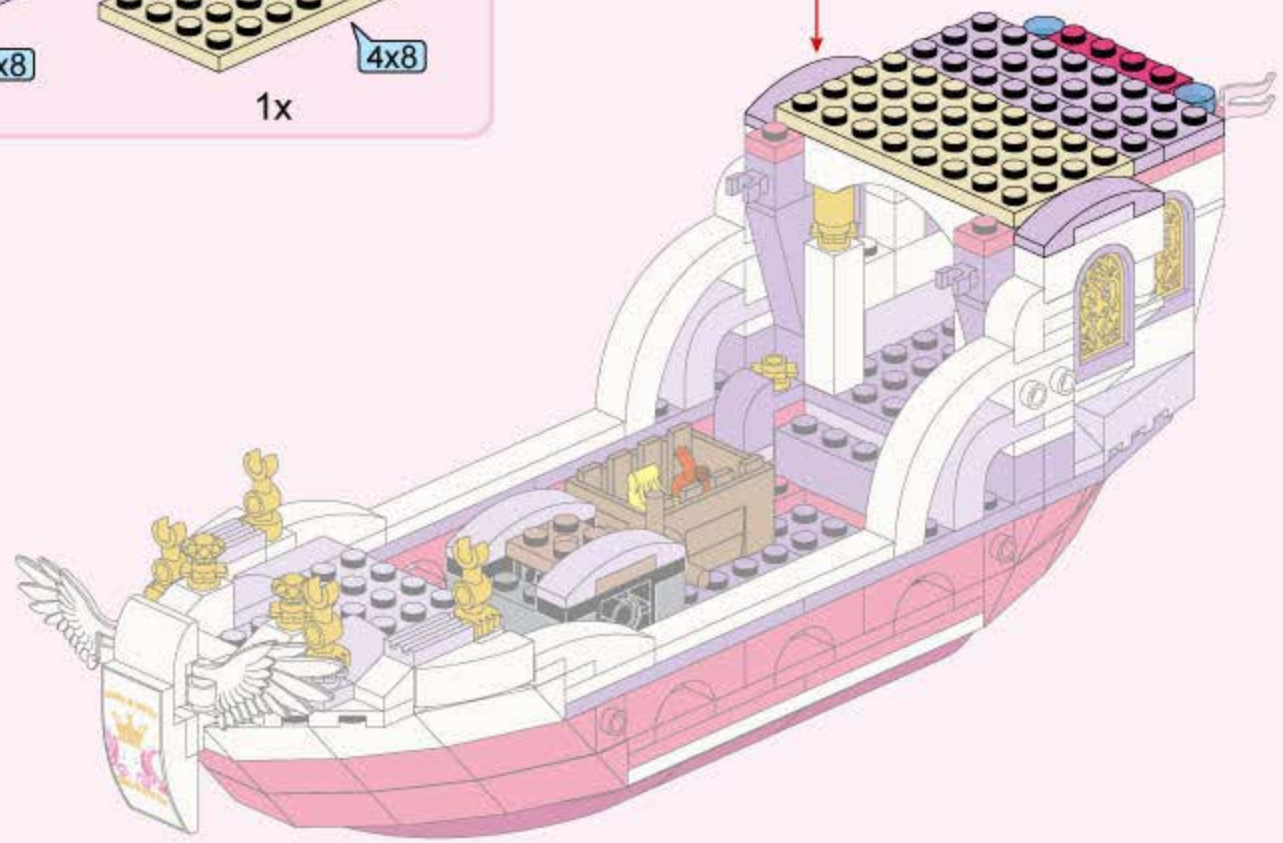
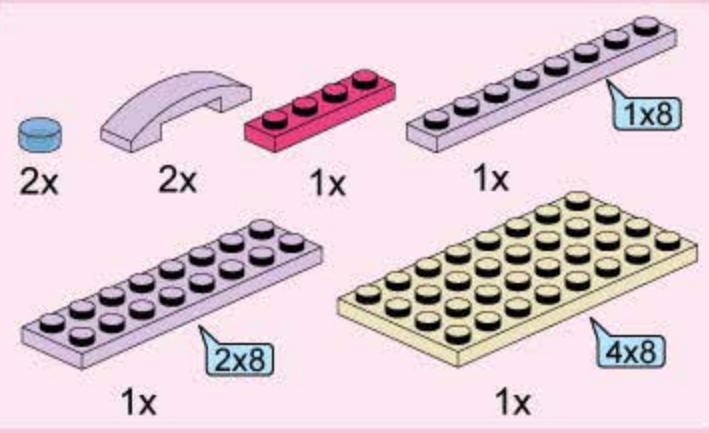

32



2x



2x



2x



2x

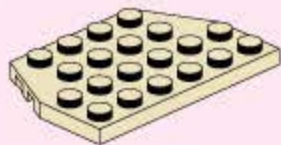

1x

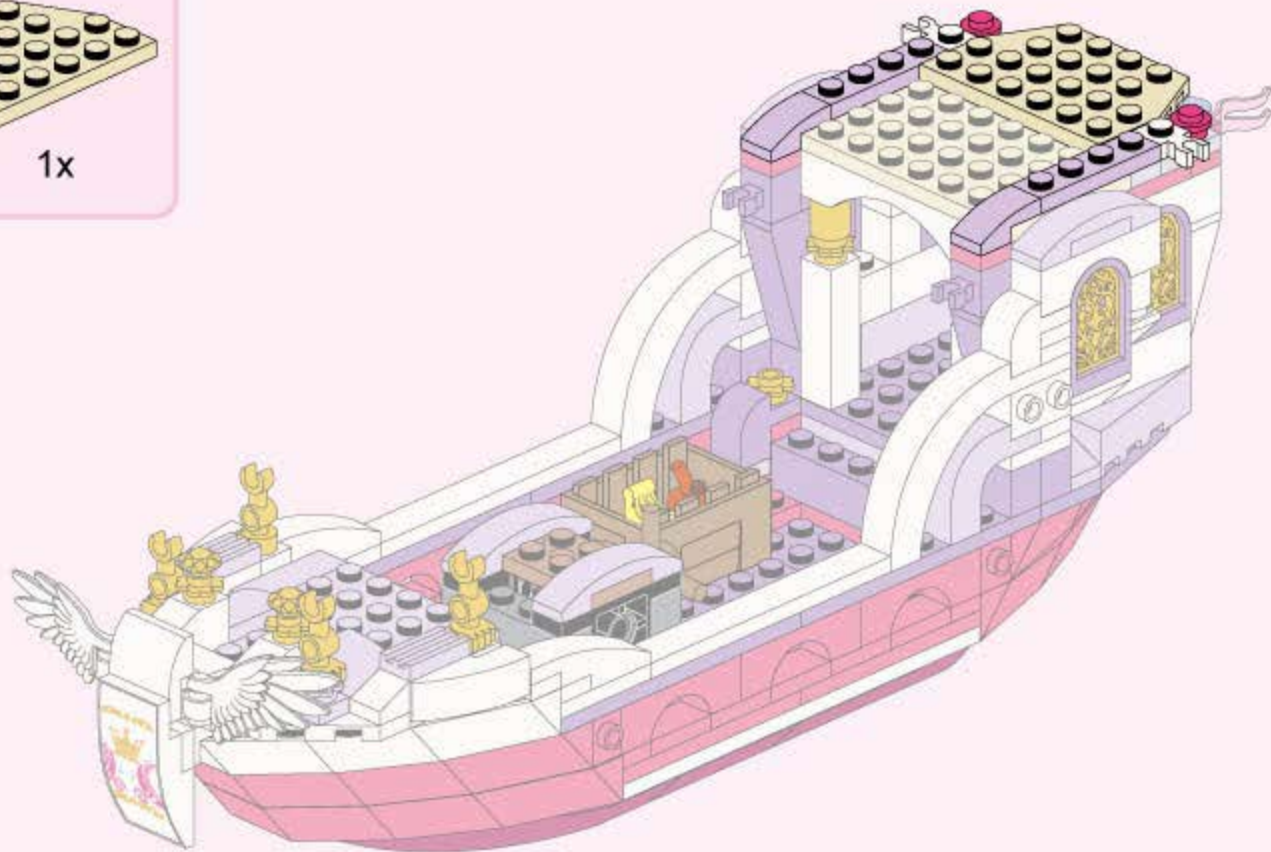



33



2x



2x



2x



2x

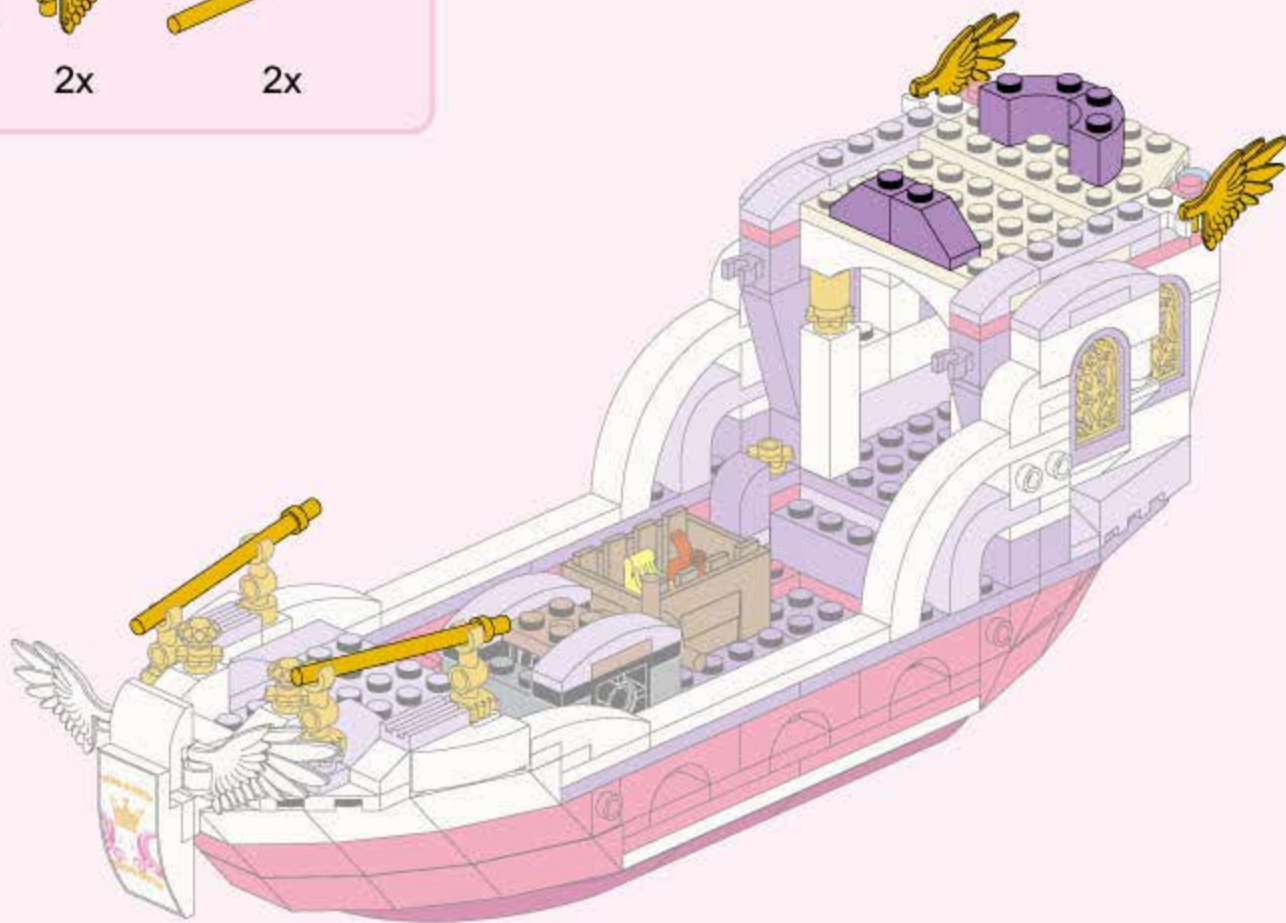

34



1x



2x



2x



1x



1x



2x



35



2x



2x

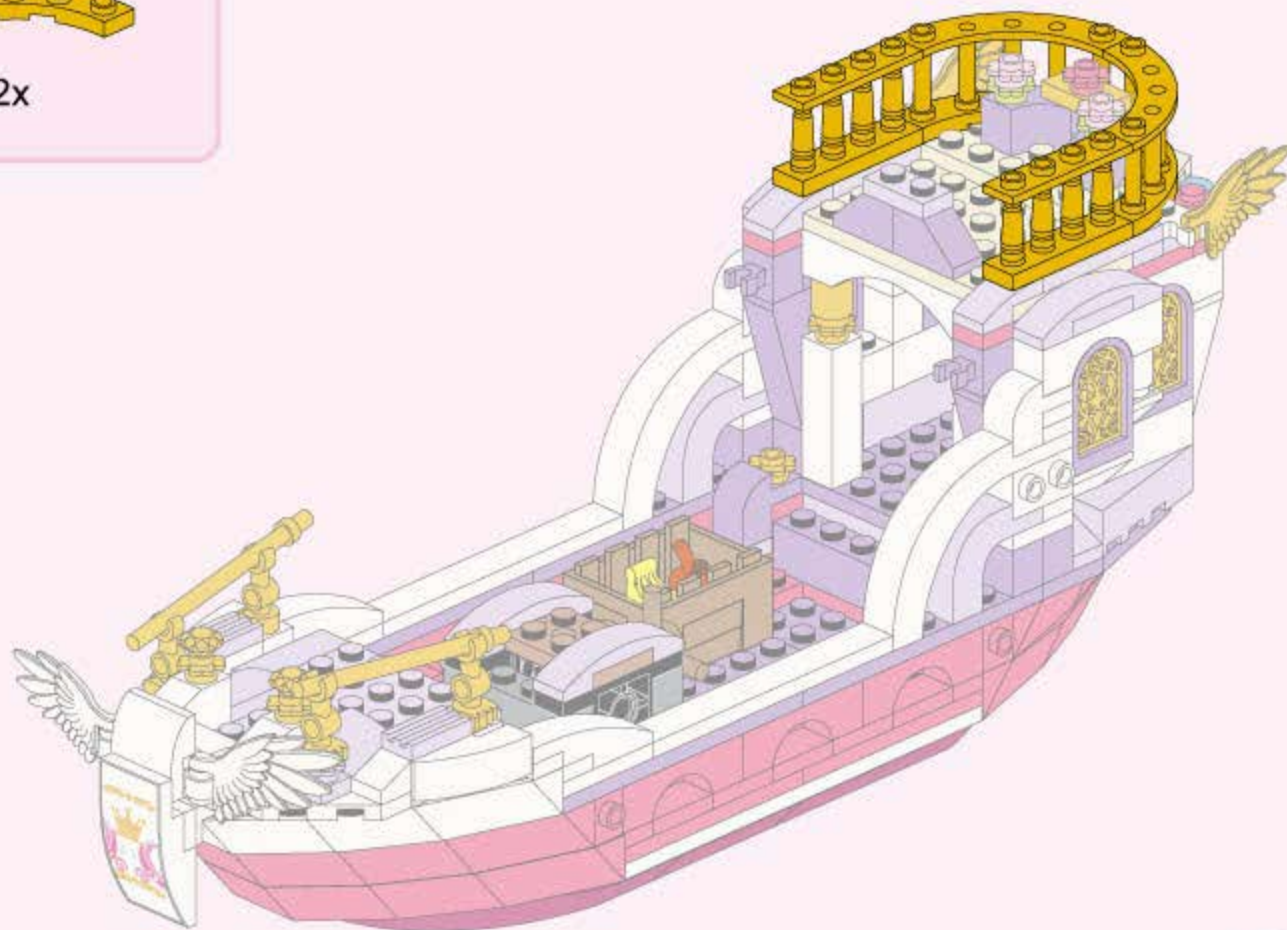



36

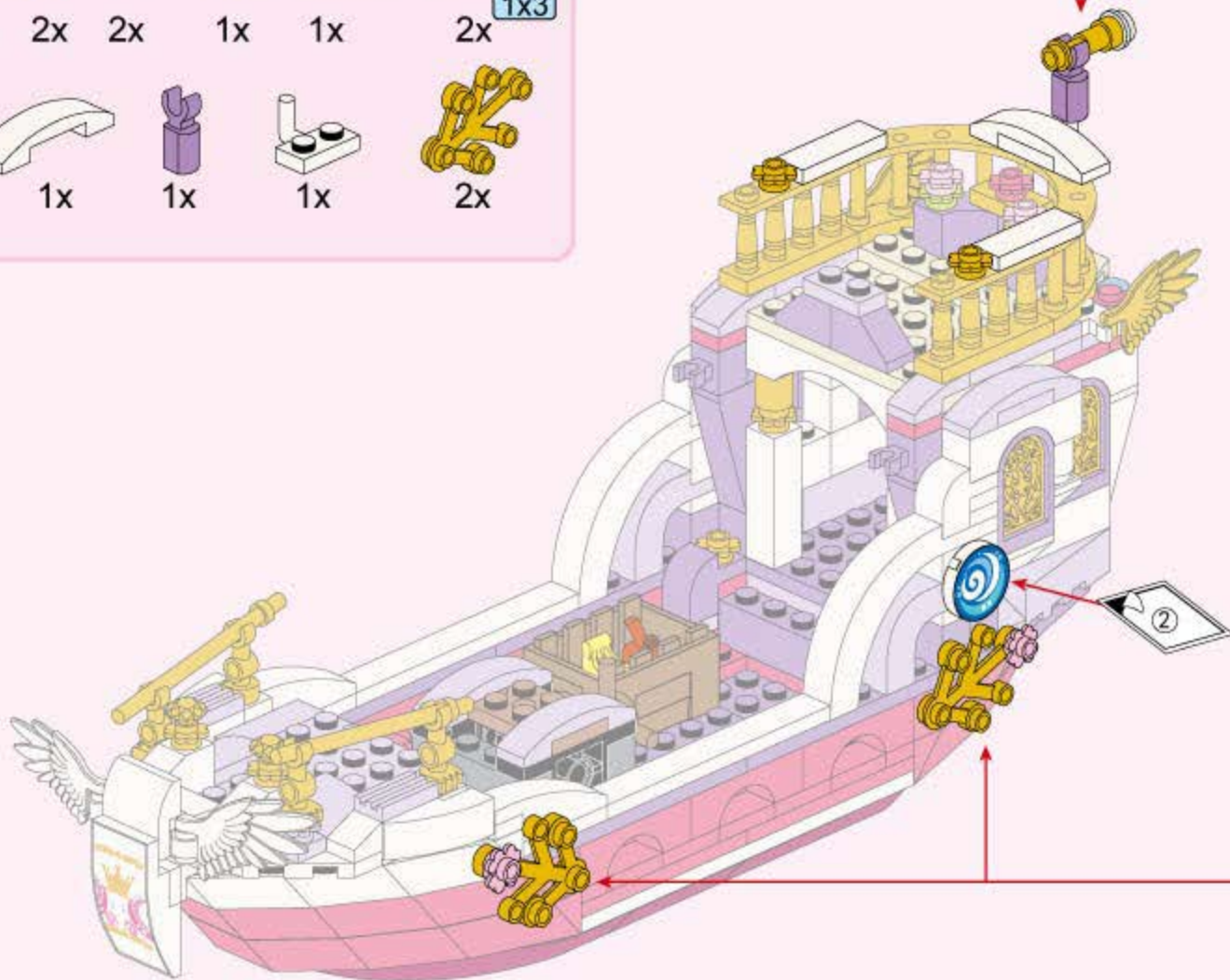
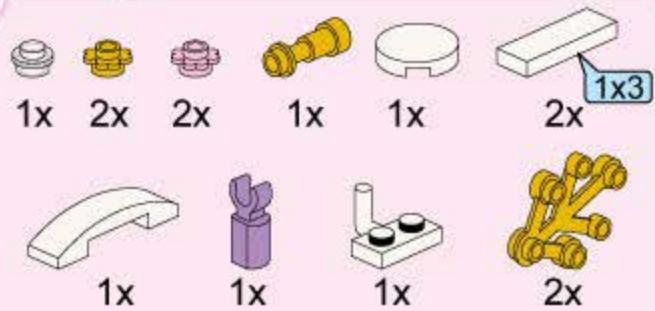

1



2



3

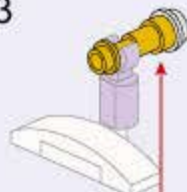

2x

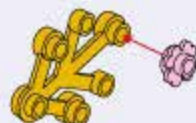



37



2x



2x



2x



2x



1x



1x



2x



2x



1x

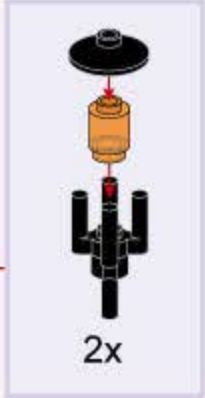
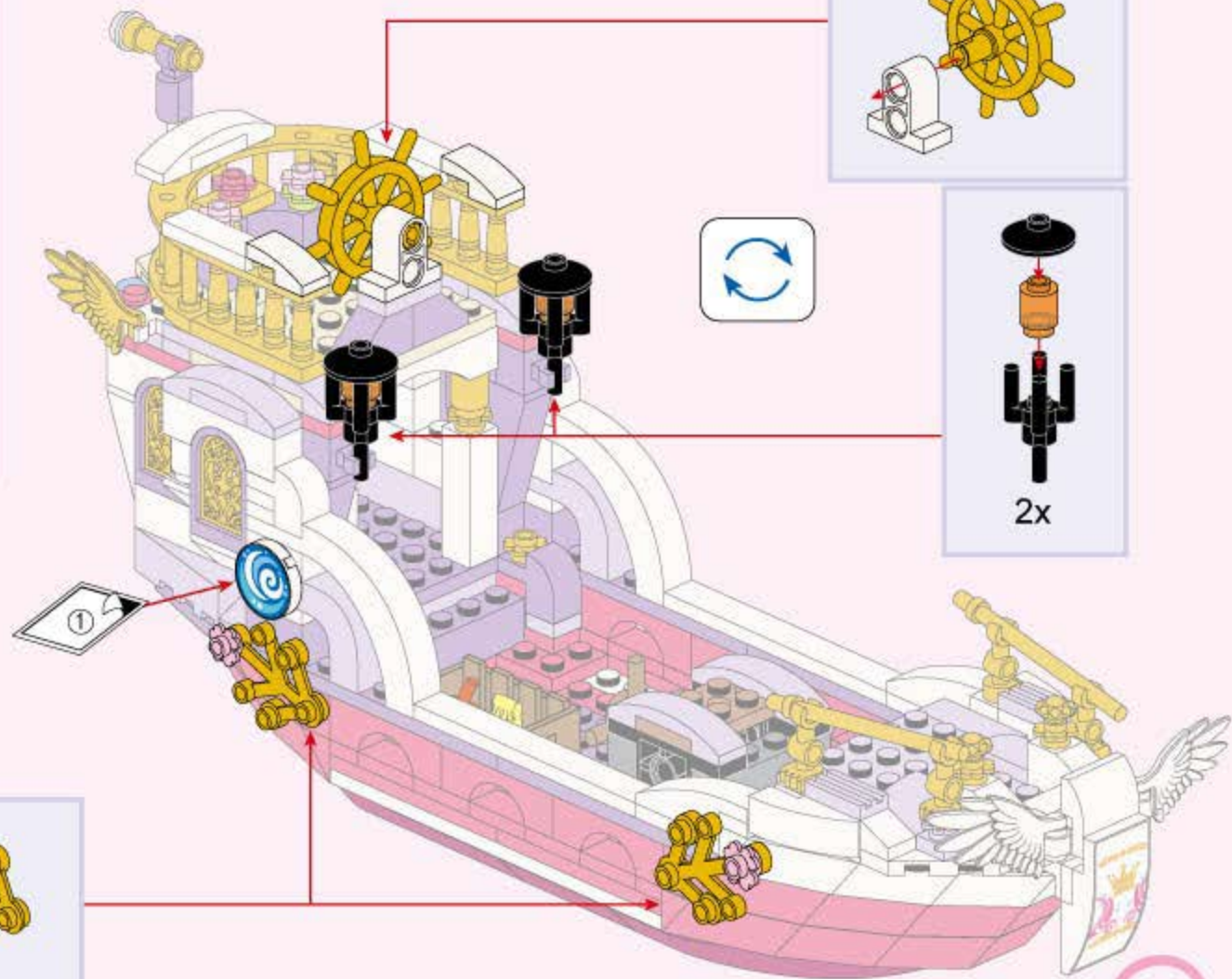

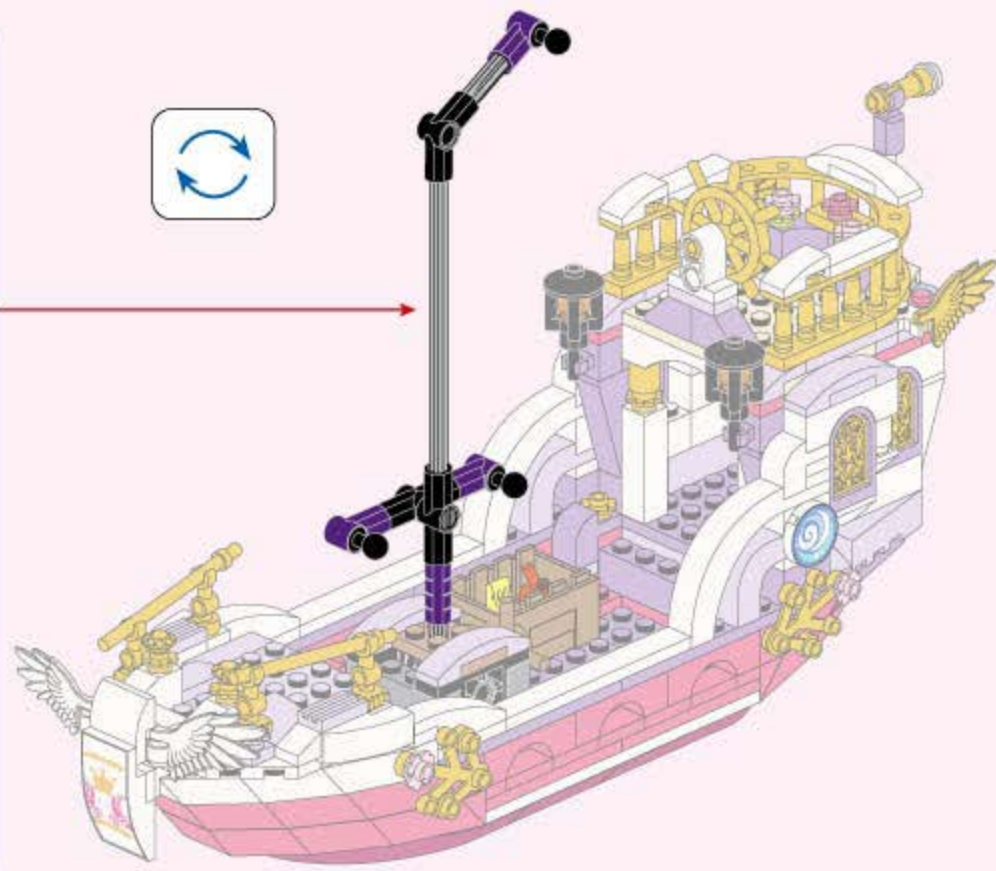

39



1x







2609

# Princess Leah



2601 Leah's Bedchamber



2602 Rose Corridor



2603 Chansons Bakery



2604 Rainbow Windmill



2605 Violet Carriage



2606 Genius Tailor's



2607 Lakeside Party



2608 Royal Library



2609 Angel Princess Ship



2610 Leah's Birthday Party



2611 Royal Wisdom School



2612 Angel Castle Celebration